Encyclopedia of
PSYCHOTHERAPY



Editors-in-Chief

Michel Hersen

Pacific University, Forest Grove, Oregon

Michel Hersen, Ph.D., ABPP, is Professor and Dean, School of Professional Psychology, Pacific University, Forest Grove, Oregon. Dr. Hersen is a graduate of State University of New York at Buffalo, and completed his post-doctoral training at the West Haven VA (Yale University School of Medicine Program).

Dr. Hersen is past president of the Association for Advancement of Behavior Therapy. He has co-authored and co-edited 133 books, and has published 223 scientific journal articles. Dr. Hersen is also co-editor of several psychological journals, including *Behavior Modification*, *Aggression and Violent Behavior: A Review Journal*, *Clinical Psychology Review*, *Journal of Anxiety Disorders*, *Journal of Family Violence*, *Journal of Clinical Geropsychology*, and *Journal of Developmental and Physical Disabilities*. He is editor-in-chief of a new journal entitled *Clinical Case Studies*, which is devoted to description of clients and patients treated with psychotherapy. He is co-editor of the recently published 11-volume work entitled: *Comprehensive Clinical Psychology*.

Dr. Hersen has been the recipient of numerous grants from the National Institute of Mental Health, the Department of Education, the National Institute of Disabilities and Rehabilitation Research, and the March of Dimes Birth Defects Foundation. He is a diplomate of the American Board of Professional Psychology, Fellow of the American Psychological Association, Distinguished Practitioner and Member of the National Academy of Practice in Psychology, and recipient of the Distinguished Career Achievement Award in 1996 from the American Board of Medical Psychotherapists and Psychodiagnosticians. He has had full-time and part-time private practices.

William Sledge

Yale University, New Haven, Connecticut

William H. Sledge, M.D., is Professor of Psychiatry at Yale University School of Medicine, and is the Medical Director of the Psychiatric Services at Yale-New Haven Hospital. Dr. Sledge is a graduate of Baylor College of Medicine and the Western New England Institute for Psychoanalysis. He completed his residency training in psychiatry at Yale University, Department of Psychiatry.

Dr. Sledge has been a faculty member at Yale University School of Medicine for 25 years. He has written about psychotherapy and psychoanalysis and is a mental health services and health services investigator. In addition, he provides psychiatric consultation to the aviation industry and investigates the neurobiological basis of the thought disorder of schizophrenia.

Dr. Sledge has had a long, distinguished career as an educator, and has functioned as an administrator of a variety of medical educational programs at Yale. In addition to his medical duties, he has been Master of one of the Yale undergraduate residential colleges, Calhoun College, for seven years, and is the chair of the Council of Masters.

Dr. Sledge has been active in the American Psychoanalytic Association and the American Psychiatric Association, primarily in the areas addressing education and psychotherapy. He is former chair of the American Psychiatric Association Committee on the Practice of Psychotherapy and a member of the Commission on the Practice of Psychotherapy by Psychiatrists. He is a member of the Group for Advancement of Psychiatry Committee on Therapy.

Associate Editors

Alan M. Gross

University of Mississippi, Oxford, Mississippi

Alan M. Gross, Ph.D., is Professor of Psychology and Director of Clinical Training at the University of Mississippi. He is the former editor of the *Behavior Therapist* journal, and recently served as associate editor for the *Journal of Clinical Child Psychology*. He currently serves on the editorial boards of several scientific journals, including *Behavior Therapy*, *Journal of Clinical Child and Adolescent Psychology*, *Behavior Modification*, *Journal of Family Violence*, and *Aggression and Violent Behavior*.

Professor Gross has published numerous articles and book chapters in the area of self-management, behavior problems in children, and sexual aggression.

Jerald Kay

Wright State University School of Medicine, Dayton, Ohio

Jerald Kay, M.D., is Professor and Chair in the Department of Psychiatry at Wright State University School of Medicine, Dayton, Ohio. He is a Fellow of the American College of Psychiatrists and of the American Psychiatric Association (APA). Currently he is the chair of the APA Commission on the Practice of Psychotherapy by Psychiatrists. He is the founding editor of the *Journal of Psychotherapy Practice and Research* and associate editor of the *American Journal of Psychotherapy*.

Dr. Kay is the editor of 8 books and has published extensively on the topics of medical and psychiatric education, medical ethics, child psychiatry, psychoanalysis, psychotherapy, and psychosocial aspects of AIDS and of cardiac transplantation. He was designated as a 1994 Exemplary Psychiatrist by the National Alliance for the Mentally Ill and is the recipient of the 2001 APA-NIMH Seymore Vestermark Award for contributions to psychiatric education.

Bruce Rounsaville

Yale University School of Medicine, New Haven, Connecticut
and

U.S. Veterans Administration, West Haven, Connecticut

Bruce Rounsaville, M.D., is Professor of Psychiatry at the Yale University School of Medicine and director of the U.S. Veterans Administration New England Mental Illness Research Education and Clinical Center. Since he joined the Yale faculty in 1977, Dr. Rounsaville has focused his clinical research career on the diagnosis and treatment of patients with alcohol and drug dependence. Using modern methods for psychiatric diagnosis, Dr. Rounsaville was among the first to call attention to the high rates of dual diagnosis in drug abusers. As a member of the Work Group to Revise DSM-III, Dr. Rounsaville was a leader in adopting the drug dependence syndrome concept into the DSM-III-R and DSM-IV Substance Use Disorders criteria.

Dr. Rounsaville has been a strong advocate for adopting psychotherapies shown to be effective in rigorous clinical trials. Dr. Rounsaville has also played a key role in clinical trials on the efficacy of a number of important treatments, including outpatient clonidine/naltrexone for opioid detoxification, naltrexone for treatment of alcohol dependence, cognitive-behavioral treatment for cocaine dependence, and disulfiram treatment for alcoholic cocaine abusers. He has contributed extensively to the psychiatric treatment research literature in over 200 journal articles and 4 books.

Warren W. Tryon

Fordham University, Bronx, New York

Warren W. Tryon, Ph.D., ABPP, is Professor of Psychology and Director of Clinical Training at Fordham University, Bronx, New York. He is a fellow of Division 12 (Clinical Psychology) of the American Psychological Association, a fellow of the American Association of Applied and Preventive Psychology,

and a founder of the Assembly of Behavior Analysis and Therapy. He is a diplomate in Clinical Psychology—American Board of Professional Psychology (ABPP). He is listed in the National Register of Health Service Providers in Psychology and is a licensed psychologist in New York State.

Dr. Tryon has published over 130 articles, has authored 1 book, and edited 2 others. He has presented over 115 papers at professional meetings. Dr. Tryon is on the editorial board of *Behavior Modification* and has served as reviewer for over 30 journals and publishers. Seventy doctoral students have completed their dissertations under his direction.

EDITORIAL ADVISORY BOARD

DAVID H. BARLOW
Boston University,
Boston, Massachusetts

BERNARD BEITMAN
Columbia, Missouri

LARRY BEUTLER
University of California,
Santa Barbara,
Santa Barbara, California

NICHOLAS CUMMINGS
Scottsdale, Arizona

PAUL M. G. EMMELKAMP
University of Amsterdam,
Amsterdam, The Netherlands

EDNA B. FOA
Allegheny University
Philadelphia, Pennsylvania

W. KIM HALFORD
Griffith University,
Nathan, Australia

SANDRA LEE HARRIS
Rutgers University,
Piscataway, New Jersey

MARDI HOROWITZ
Langley Porter Psychiatric
Institute,
San Francisco, California

HORST KAECEHELE
Ulm, Germany

OTTO KERNBERG
Cornell Medical Center,
White Plains, New York

SUSAN LAZAR
Bethesda, Maryland

LESTER LUBORSKY
University of Pennsylvania,
Philadelphia, Pennsylvania

WILLIAM L. MARSHALL
Queens University,
Kingston, Canada

MALKAH NOTMAN
Cambridge Hospital,
Cambridge, Massachusetts

JOHN SCHOWALTER
Yale University,
New Haven, Connecticut

BONNIE R. STRICKLAND
University of Massachusetts,
Amherst,
Amherst, Massachusetts

MYRNA WEISSMAN
Columbia University,
New York, New York

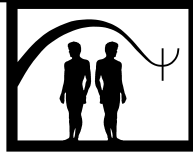

Preface

When we began this project, it would have been beyond our most radical beliefs to think that we would be seeing a nation fraught with intense worry, anxiety, acute stress disorder, post-traumatic stress disorder, grief, and depression less than three years later. So now, as we put our finishing touches on this work, and following the terrorist incursions, we regrettably have been forced to see the graphic proof of the inherent value of psychotherapy. The critical contributions and the value of the psychotherapeutic arts have never been clearer to us than in the aftermath of the terrorist strikes. We say this with much humility, in that we would have preferred to continue to talk about the sometimes small theoretical differences in various psychotherapeutic applications, in what now seem to be needless polemics between such psychotherapeutic camps. Nonetheless, the original intent (which continues today in spite of world events) was to present a compilation of both the science and art of psychotherapy.

Psychotherapy has been a vital treatment in health care since development of the great innovative and technical approaches embodied by psychoanalysis and behaviorism at the beginning of the 20th century. In the course of its development, many questions have been raised about this treatment: What is psychotherapy? How does it work? Which forms are cost effective? Who can do it? How does it fit into a comprehensive approach to health care? What is its scientific basis? How does theory drive treatment? What is the role of complementary treatments such as pharmacotherapy in combination with psychotherapy?

The *Encyclopedia of Psychotherapy* strives to answer the aforementioned questions. It is a comprehensive reference to extant knowledge in the field and written in clear expository language so that it will be of value to professional and lay persons alike. Within its pages, this encyclopedia addresses over 200 topics by experts

in psychotherapy. Topics were selected in order to give broad coverage of the field (albeit not exhaustive) so as to encompass the most contemporary schools and approaches that have clearly defined techniques, some form of systematic study, and measurement of outcomes. Eclectic and integrative approaches have also been considered. Additional topics that transcend all schools, such as the impact of culture and the importance of the therapeutic relationship, have also been included as well as discussion of the treatment for some specific disorders.

Psychotherapy is an extremely complicated process that is difficult to fully capture even in a work of large scope, such as this encyclopedia. The interplay between scientific confirmation of particular strategies and the actual implementation of a given therapeutic technique is not always isomorphic. Also, how theory drives practice and ultimately the empirical confirmation of such practice, is not always clear cut. Moreover, how cultural, financial, legislative, and forensic issues act in confluence further complicate the intricacies of what we refer to as psychotherapy. However, it is these very intricacies and complexities which make psychotherapy such an interesting field to examine. In many ways, this work may raise more questions than it does provide answers, and that, perhaps, is the way it should be.

The *Encyclopedia of Psychotherapy* is designed to serve the needs of a multi-faceted audience. As a reference work, we see it being used by students and professionals from counseling and clinical psychology, psychiatry, psychiatric nursing, and social work. Certainly, other disciplines will make reference to it as well. But the encyclopedia will also be of use to interested lay individuals seeking information about this burgeoning field. Topics are arranged alphabetically. As appropriate, a good many of the entries have case

descriptions to illustrate the specifics of theory and technique. The topics addressed span clinical, theoretical, cultural, historical, and administrative and policy issues, as well as the matters of schools and specific patient conditions. Most importantly, a comprehensive user friendly Index is provided.

Early on it was apparent that a project of this magnitude would require associate editors and an advisory board to ensure broad coverage of issues and topics. The inclusion of these colleagues has added immeasurably to the fruition of this work. The associate editors (Alan M. Gross, Ph.D., Jerald Kay, M.D., Bruce J. Rounsaville, M.D., Warren W. Tryon, Ph.D.) were chosen in order to represent the cross-fertilization between the medical and the psychological, adult and child, theoretical and pragmatic, research and practice, and behavioral and non-behavioral. Similarly, the 18 advisory board members (both M.D.s and Ph.D.s) were selected because of their broad range of interests and expertise in all aspects of the psychotherapeutic endeavor.

The iterative process began with a large list of topics selected by the two editors-in-chief, which was then refined by the associate editors and the advisory board members. Excellent suggestions for authors were made and the solicitation process began. When received by Academic Press, each entry was evaluated by an appropriate associate editor, revised to the editor's specifications, and then sent on to one of the two editors-in-chief

for approval and/or further modification. All entries were reviewed on the basis of accuracy, completeness, clarity, brevity, and the absence of polemics. The resulting *Encyclopedia of Psychotherapy* is a product of complete collaboration between the two editors-in-chief, and hence the order of editorship is alphabetical.

We are grateful to the many individuals who helped make the *Encyclopedia of Psychotherapy* possible. Thank you to the four associate editors who performed in an exemplary fashion. Thank you also to our 18 members of the advisory board for their wise counsel and excellent suggestions. Thanks also to our contributors who took time out from their busy schedules to become part of our project, sharing their expertise as well as articulating their views on where this field stands. We thank Alex Duncan, Angelina Marchand, and Angelina Basile for their research efforts. We appreciate Carole Londeree's technical assistance. We thank all at Academic Press who were involved in the production effort, especially the acquisitions editor, George Zimmar, and the coordinator of the *Encyclopedia*, Anya Kozorez, for helping us to conceptualize this work and overcome obstacles to see it through to publication.

We dedicate this work to our colleagues who work on a daily basis to relieve the suffering of their clients.

Michel Hersen
William Sledge

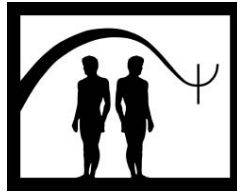

Contents of Volume 1

Acceptance and Commitment Therapy; <i>Kirk Strosahl</i> ;	1-8
Addictions in Special Populations: Treatment; <i>Paul R. Stasiewicz and Kellie E. Smith</i> ;	9-14
Adjunctive/Conjoint Therapies; <i>Robert Ostroff</i> ;	15-22
Adlerian Psychotherapy; <i>Henry T. Stein and Martha E. Edwards</i> ;	23-31
Alternatives to Psychotherapy; <i>Janet L. Cummings</i> ;	33-40
Anger Control Therapy; <i>Raymond W. Novaco</i> ;	41-48
Animal-Assisted Therapy; <i>Aubrey H. Fine</i> ;	49-55
Anxiety Disorders: Brief Intensive Group Cognitive Behavior Therapy; <i>Tian P. S. Oei and Genevieve Dingle</i> ;	57-60
Anxiety Management Training; <i>Richard M. Suinn and Jerry L. Deffenbacher</i> ;	61-69
Applied Behavior Analysis; <i>Alan E. Kazdin</i> ;	71-94
Applied Relaxation; <i>Lars-Goran Ost</i> ;	95-102
Applied Tension; <i>Lars-Goran Ost</i> ;	103-108
Arousal Training; <i>Marita P. McCabe</i> ;	109-112
Art Therapy; <i>Marcia Sue Cohen-Liebman</i> ;	113-116
Assertion Training; <i>Eileen Gambrill</i> ;	117-124
Assisted Covert Sensitization; <i>Joseph J. Plaud</i> ;	125-130
Attention Training Procedures; <i>Alice Medalia</i> ;	131-137
Aversion Relief; <i>Paul M. G. Emmelkamp and j. H. Kamphuis</i> ;	139-143
Avoidance Training; <i>James K. Luiselli</i> ;	145-148
Backward Chaining; <i>Douglas W. Woods and Ellen J. Teng</i> ;	149-153
Beck Therapy Approach; <i>Judith S. Beck</i> ;	155-163
Behavioral Assessment; <i>David C. S. Richard and Stephen N. Haynes</i> ;	165-183
Behavioral Case Formulation; <i>Jennifer R. Antick and Johan Rosqvist</i> ;	185-190
Behavioral Consultation Therapy; <i>Mark E. Ehrlich and Thomas R. Kratochwill</i> ;	191-205
Behavioral Contracting; <i>Brad Donohue and Lisa Solomon Weissman</i> ;	207-211
Behavioral Group Therapy; <i>Brian J. Cox and Steven Taylor</i> ;	213-221
Behavioral Marital Therapy; <i>Gary R. Birchler</i> ;	223-231
Behavioral Therapy Instructions; <i>Amy M. Combs-Lane, Joanne L. Davis,</i> <i>Adrienne E. Fricker and Ron Aciermo</i> ;	233-236
Behavioral Treatment of Insomnia; <i>Jack D. Edinger</i> ;	237-242
Behavioral Weight Control Therapies; <i>Donald A. Williamson,</i> <i>Joy R. Kohlmaier and Marney A. White</i> ;	243-251
Behavior Rehearsal; <i>Arnold A. Lazarus</i> ;	253-257

Behavior Therapy: Historical Perspective and Overview; <i>John P. Forsyth and Jill Sabsevitz</i> ;	259-275
Behavior Therapy: Theoretical Bases; <i>Dean McKay and Warren W. Tryon</i> ;	277-291
Bell-and-Pad Conditioning; <i>Daniel M. Doleys and Brad B. Doleys</i> ;	293-300
Biblical Behavior Modification; <i>Linda Wasserman</i> ;	301-307
Bibliotherapy; <i>Eileen Gambrill</i> ;	309-315
Bioethics; <i>Everett K. Spees</i> ;	317-330
Biofeedback; <i>Doil D. Montgomery</i> ;	331-344
Breathing Retraining; <i>Ronald Ley</i> ;	345-348
Brief Therapy; <i>Brett N. Steenbarger</i> ;	349-358
Cancer Patients: Psychotherapy; <i>David Spiegel</i> ;	359-364
Chaining; <i>Ruth Anne Rehfeldt</i> ;	365-369
Character Pathology; <i>Donna S. Bender and Andrew E. Skodol</i> ;	371-379
Child and Adolescent Psychotherapy: Psychoanalytic Principles; <i>Steven Marans, Kirsten Dahl and John Schowalter</i> ;	381-400
Cinema and Psychotherapy; <i>Irving Schneider</i> ;	401-406
Clarification; <i>W. W. Meissner</i> ;	407-413
Classical Conditioning; <i>Steven Taylor</i> ;	415-429
Cognitive Appraisal Therapy; <i>Richard L. Wessler</i> ;	431-434
Cognitive Behavior Group Therapy; <i>Sheldon D. Rose</i> ;	435-450
Cognitive Behavior Therapy; <i>Deborah A. Roth Winnie Eng and Richard G. Heimberg</i> ;	451-458
Collaborative Care; <i>Nicholas A. Cummings</i> ;	459-467
Communication Skills Training; <i>David Reitman and Nichole Jurbergs</i> ;	469-473
Comorbidity; <i>William M. Klykylo</i> ;	475-479
Competing Response Training; <i>Raymond G. Miltenberger</i> ;	481-485
Complaints Management Training; <i>Gudrun Sartory and Karin Elsesser</i> ;	487-493
Conditioned Reinforcement; <i>Ben A. Williams</i> ;	495-502
Confidentiality; <i>Norman Andrew Clemens</i> ;	503-510
Configurational Analysis; <i>Mardi J. Horowitz</i> ;	511-515
Confrontation; <i>W. W. Meissner</i> ;	517-524
Contingency Management; <i>Christopher A. Kearney and Jennifer Vecchio</i> ;	525-532
Controlled Drinking; <i>Harold Rosenberg</i> ;	533-544
Control-Mastery Theory; <i>Joseph Weiss</i> ;	545-549
Corrective Emotional Experience; <i>Deborah Fried</i> ;	551-555
Correspondence Training; <i>Karen T. Carey</i> ;	557-560
Cost Effectiveness; <i>William H. Sledge and Susan G. Lazar</i> ;	561-568
Countertransference; <i>William H. Sledge</i> ;	569-572
Couples Therapy: <i>Insight-Oriented</i> ; <i>Douglas K. Snyder</i> ;	573-577
Covenant Control; <i>E. Thomas Dowd</i> ;	579-585
Covert Positive Reinforcement; <i>Gerald Groden and June Groden</i> ;	587-592
Covert Rehearsal; <i>Zehra F. Peynirciolu</i> ;	593-597
Covert Reinforcer Sampling; <i>Patricia A. Wisocki</i> ;	599-602
Cultural Issues; <i>Edward F. Foulks</i> ;	603-613
Danger Ideation Reduction Therapy; <i>Mairwen K. Jones and Ross G. Menzies</i> ;	615-619
Dialectical Behavior Therapy; <i>Sarah K. Reynolds and Marsha M. Linehan</i> ;	621-628

Differential Attention; <i>Nirbhay N. Singh, Bethany A. Marcus and Ashvind N. Singh;</i>	629-632
Differential Reinforcement of Other Behavior; <i>Marc J. Tasse, Susan M. Haverkamp and Luc Lecavalier;</i>	633-639
Discrimination Training; <i>Lisa W. Coyne and Alan M. Gross;</i>	641-646
Documentation; <i>Norman Andrew Clemens;</i>	647-653
Dosage Model; <i>S. Mark Kopta and Jenny L. Lowry;</i>	655-660
Dreams, Use in Psychotherapy; <i>Robert C. Lane and Max Harris;</i>	661-669
Eating Disorders; <i>Joel Yager;</i>	671-680
Economic and Policy Issues; <i>Nicholas A. Cummings;</i>	681-701
Education: Curriculum for Psychotherapy; <i>James W. Lomax;</i>	703-708
Effectiveness of Psychotherapy; <i>Michael J. Lambert and David A. Vermeersch;</i>	709-714
Efficacy; <i>Michael J. Lambert and Melissa K. Goates;</i>	715-718
Electrical Aversion; <i>Nathaniel McConaghy;</i>	719-730
Emotive Imagery; <i>Arnold A. Lazarus;</i>	731-734
Engagement; <i>Georgiana Shick Tryon;</i>	735-739
Existential Psychotherapy; <i>Paul B. Lieberman and Leston L. Havens;</i>	741-754
Exposure; <i>Steven Taylor;</i>	755-759
Exposure in Vivo Therapy; <i>Wiljo J. P. J. van Hout and Paul M. G. Emmelkamp;</i>	761-768
Extinction; <i>Alan Poling, Kristal E. Ehrhardt and R. Lanai Jennings;</i>	769-775
Eye Movement Desensitization and Reprocessing; <i>Francine Shapiro and Louise Maxfield;</i>	777-785
Fading; <i>Cynthia M. Anderson;</i>	787-791
Family Therapy; <i>William A. Griffin;</i>	793-800
Feminist Psychotherapy; <i>Carolyn Zerbe Enns;</i>	801-808
Flooding; <i>Catherine Miller;</i>	809-813
Formulation; <i>Tracy D. Eells;</i>	815-822
Forward Chaining; <i>Raymond G. Miltenberger;</i>	823-827
Free Association; <i>Anton O. Kris;</i>	829-831
Functional Analysis of Behavior; <i>Kelly G. Wilson and Amy R. Murrell;</i>	833-839
Functional Analytic Psychotherapy; <i>Robert J. Kohlenberg and Mavis Tsai;</i>	841-845
Functional Communication Training; <i>Cynthia R. Johnson;</i>	847-852
Gambling: Behavior and Cognitive Approaches; <i>Robert Ladouceur, Claude Boutin, Caroline Sylvain and Stella Lachance;</i>	853-862
Gestalt Therapy; <i>Stephen G. Zahm and Eva K. Gold;</i>	863-872
Gifted Youth; <i>Douglas Schave;</i>	873-878
Good Behavior Game; <i>Daniel H. Tingstrom;</i>	879-884
Grief Therapy; <i>Rostyslaw W. Robak;</i>	885-889
Group Psychotherapy; <i>K. Roy MacKenzie;</i>	891-906
Guided Mastery Therapy; <i>Asle Hoffart;</i>	907-910
Habit Reversal; <i>Raymond G. Miltenberger;</i>	911-917
Heterosocial Skills Training; <i>Eric Strachan and Debra A. Hope;</i>	919-924
History of Psychotherapy; <i>David Bienenfeld;</i>	925-935
Home-Based Reinforcement; <i>Douglas W. Woods and Michael P. Twohig;</i>	937-941
Homework; <i>Lisa W. Coyne and Thomas W. Lombardo;</i>	943-947
Humanistic Psychotherapy; <i>Kirk J. Schneider and Larry M. Leitner;</i>	949-957

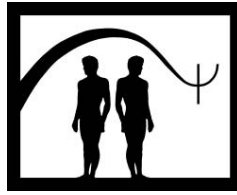

Contents of Volume 2

Note: Pages of Volume 2 have prefix ‘b’ (b1, b2, ...)

Implosive Therapy; <i>Donald J. Levis;</i>	1-6
Individual Psychotherapy; <i>Larry E. Beutler and T. Mark Harwood;</i>	7-15
Informed Consent; <i>Catherine Miller;</i>	17-24
Integrative Approaches to Psychotherapy; <i>Jerry Gold;</i>	25-35
Interpersonal Psychotherapy; <i>Scott Stuart and Michael Robertson;</i>	37-47
Interpretation; <i>T. Wayne Downey;</i>	49-56
Intrapsychic Conflict; <i>Alan Sugarman;</i>	57-62
Job Club Method; <i>Nathan H. Azrin;</i>	63-67
Jungian Psychotherapy; <i>Jeffrey Satinover;</i>	69-81
Language in Psychotherapy; <i>W. Rand Walker;</i>	83-90
Legal Dimensions of Psychotherapy; <i>Howard Zonana;</i>	91-105
Logotherapy; <i>Paul T. P. Wong;</i>	107-113
Manualized Behavior Therapy; <i>Michael J. Zvolensky and Georg H. Eifert;</i>	115-121
Matching Patients to Alcoholism Treatment; <i>Margaret E. Mattson;</i>	123-129
Medically Ill Patient: Psychotherapy; <i>Randy A. Sansone and Lori A. Sansone;</i>	131-139
Minimal Therapist Contact Treatments; <i>Anderson B. Rowan and Julie M. Storey;</i>	141-145
Modeling; <i>Kurt A. Freeman;</i>	147-154
Mood Disorders; <i>Michael Robertson and Scott Stuart;</i>	155-164
Multicultural Therapy; <i>David Sue;</i>	165-173
Multimodal Behavior Therapy; <i>Arnold A. Lazarus;</i>	175-182
Negative Practice; <i>Theodosia R. Paclawskyj and Johnny L. Matson;</i>	183-188
Negative Punishment; <i>Alan Poling, John Austin, Susan Snyckerski and Sean Laraway;</i>	189-197
Negative Reinforcement; <i>Alan Poling, Linda A. LeBlanc and Lynne E. Turner;</i>	199-205
Neurobiology; <i>Douglas S. Lehrer and Jerald Kay;</i>	207-221
Neuropsychological Assessment; <i>Linda Laatsch;</i>	223-228
Nocturnal Enuresis: Treatment; <i>Henry S. Roane, Cathleen C. Piazza and Mary A. Mich;</i>	229-233
Objective Assessment; <i>James N. Butcher;</i>	245-248
Object-Relations Psychotherapy; <i>Frank Summers;</i>	235-244
Oedipus Complex; <i>Jodi H. Brown and Alan Sugarman;</i>	249-256

Omission Training; <i>Ruth Anne Rehfeldt</i> ;	257-260
Online or E-Therapy; <i>Zebulon Taintor</i> ;	261-270
Operant Conditioning; <i>Alan Poling, James E. Carr and Linda A. LeBlanc</i> ;	271-287
Organic Brain Syndrome: Psychotherapeutic and Rehabilitative Approaches; <i>Avraham Schweiger and Jason W. Brown</i> ;	289-297
Orgasmic Reconditioning; <i>Nathaniel McConaghy</i> ;	299-305
Outcome Measures; <i>Michael J. Lambert and Dean E. Barley</i> ;	307-311
Overcorrection; <i>Steven A. Hobbs, Benjamin A. Jones and Julie Stollger Jones</i> ;	313-317
Pain Disorders; <i>Douglas A. Songer</i> ;	319-324
Panic Disorder and Agoraphobia; <i>Stefan G. Hofmann</i> ;	325-330
Paradoxical Intention; <i>L. Michael Ascher</i> ;	331-338
Parent-Child Interaction Therapy; <i>Brendan A. Rich, Jane G. Querido and Sheila M. Eyberg</i> ;	339-347
Patient Variables: Anaclitic and Introjective Dimensions; <i>Sidney J. Blatt</i> ;	349-357
Positive Punishment; <i>Alan Poling, Kristal E. Ehrhardt and Ruth A. Ervin</i> ;	359-366
Positive Reinforcement; <i>Alan Poling and Edward J. Daly III</i> ;	367-372
Posttraumatic Stress Disorder; <i>Ann E. Norwood and Robert J. Ursano</i> ;	373-378
Primary Care Behavioral Pediatrics; <i>Patrick C. Friman and Nathan Blum</i> ;	379-399
Progressive Relaxation; <i>Rachel L. Grover and Douglas W. Nangle</i> ;	401-407
Projective Testing in Psychotherapeutics; <i>J. Christopher Fowler</i> ;	409-414
Psychoanalysis and Psychoanalytic Psychotherapy: Technique; <i>Stephen M. Sonnenberg and Robert J. Ursano</i> ;	415-422
Psychoanalytic Psychotherapy and Psychoanalysis, Overview; <i>Eric R. Marcus</i> ;	423-430
Psychodynamic Couples Therapy; <i>Francine Cournos</i> ;	431-437
Psychodynamic Group Psychotherapy; <i>Walter N. Stone</i> ;	439-449
Psychodynamic Voice Disorders: Treatment; <i>E. Charles Healey and Marsha Sullivan</i> ;	451-455
Psychopharmacology: Combined Treatment; <i>Jerald Kay</i> ;	457-465
Race and Human Diversity; <i>Sandra Jenkins</i> ;	467-481
Rational Emotive Behavior Therapy; <i>Albert Ellis</i> ;	483-487
Reality Therapy; <i>Robert E. Wubbolding</i> ;	489-494
Reinforcer Sampling; <i>Adrienne E. Fricker, Amy M. Combs-Lane, Joanne L. Davis and Ron Acierno</i> ;	495-497
Relapse Prevention; <i>Kirk A. Brunswig, Tamara M. Penix and William O'Donohue</i> ;	499-505
Relational Psychoanalysis; <i>Spyros D. Orfanos</i> ;	507-513
Relaxation training; <i>Daniel W. McNeil and Suzanne M. Lawrence</i> ;	515-523
Research in Psychotherapy; <i>Karla Moras</i> ;	
Resistance; <i>Kay McDermott Long and William H. Sledge</i> ;	547-552
Response-Contingent Water Misting; <i>J. Grayson Osborne</i> ;	553-560
Response Cost; <i>Saul Axelrod</i> ;	561-564
Restricted Environmental Stimulation Therapy; <i>Jeanne M. Bulgin, Arreed F. Barabasz and W. Rand Walker</i> ;	565-569
Retention Control Training; <i>Kurt A. Freeman and Elizabeth T. Dexter</i> ;	571-575
Role-Playing; <i>Joanne L. Davis, Adrienne E. Fricker, Amy M. Combs-Lane and Ron Acierno</i> ;	577-580
Schizophrenia and Other Psychotic Disorders; <i>Richard L. Munich</i> ;	581-590

Self-Control Desensitization; <i>E. Thomas Dowd</i> ;	591-593
Self-Control Therapy; <i>Lynn P. Rehm and Elisia V. Yanasak</i> ;	595-600
Self-Help Groups; <i>Gary M. Burlingame and D. Rob Davies</i> ;	601-605
Self-Help Treatment for Insomnia; <i>Annie Vallieres, Marie-Christine Ouellet and Charles M. Morin</i> ;	607-613
Self Psychology; <i>Arnold Wilson and Nadezhda M. T. Robinson</i> ;	615-620
Self-Punishment; <i>Rosiana L. Azman</i> ;	621-624
Self-Statement Modification; <i>E. Thomas Dowd</i> ;	625-628
Setting Events; <i>Mark R. Dixon</i> ;	629-633
Sex Therapy; <i>Heather J. Meggers and Joseph LoPiccolo</i> ;	635-650
Short-Term Anxiety-Provoking Psychotherapy; <i>John Tsamasiros</i> ;	651-657
Single-Case Methods and Evaluation; <i>Graham Turpin</i> ;	659-668
Single-Session Therapy; <i>Brett N. Steenbarger</i> ;	669-672
Solution-Focused Brief Therapy; <i>Anne Bodmer Lutz and Insoo Kim Berg</i> ;	673-678
Somatoform Disorders; <i>Ann Kerr Morrison</i> ;	679-685
Sports Psychotherapy; <i>Todd C. O'Hearn</i> ;	687-692
Spouse-Aided Therapy; <i>Paul M. G. Emmelkamp and Ellen Vedel</i> ;	693-697
Stretch-Based Relaxation Training; <i>Charles R. Carlson</i> ;	699-705
Structural Analysis of Social Behavior; <i>Lorna Smith Benjamin</i> ;	707-713
Structural Theory; <i>Alan Sugarman</i> ;	715-719
Substance Dependence: Psychotherapy; <i>Kathlene Tracy, Bruce Rounsaville and Kathleen Carroll</i> ;	721-730
Successive Approximations; <i>Patricia A. Wisocki</i> ;	731-732
Sullivan's Interpersonal Psychotherapy; <i>Maurice R. Green</i> ;	733-740
Supervision in Psychotherapy; <i>Stephen B. Shanfield</i> ;	741-744
Supportive-Expressive Dynamic Psychotherapy; <i>Lester Luborsky</i> ;	745-750
Symbolic Modeling; <i>Michael A. Milan</i> ;	751-753
Systematic Desensitization; <i>F. Dudley McGlynn</i> ;	755-764
Tele-Psychotherapy; <i>Ann Oberkirch</i> ;	765-775
Termination; <i>Georgiana Shick Tryon</i> ;	777-779
Therapeutic Factors; <i>T. Byram Karasu</i> ;	781-791
Therapeutic Storytelling with Children and Adolescents; <i>Everett K. Spees</i> ;	793-801
Thought Stopping; <i>Melanie L. O'Neill and Maureen L. Whittal</i> ;	803-806
Time-Limited Dynamic Psychotherapy; <i>Hanna Levenson, Thomas E. Schacht, Hans H. Strupp</i> ;	807-814
Timeout; <i>Rebecca S. Griffin and Alan M. Gross</i> ;	815-819
Token Economy; <i>Paul Stuve and Julian A. Salinas</i> ;	821-827
Token Economy: Guidelines for Operation; <i>Teodoro Ayllon and Michael A. Milan</i> ;	829-833
Topographic Theory; <i>Alan Sugarman and Keith Kanner</i> ;	835-839
Transcultural Psychotherapy; <i>Thomas E. Heise</i> ;	841-850
Transference; <i>Eric R. Marcus</i> ;	851-854
Transference Neurosis; <i>Alan Sugarman and Claudia Law-Greenberg</i> ;	855-859
Transitional Objects and Transitional Phenomena; <i>Arnold Wilson and Nadezhda M. T. Robinson</i> ;	861-866
Trauma Management Therapy; <i>B. Christopher Frueh Samuel M. Turner and Deborah C. Beidel</i> ;	867-873

Unconscious, The; <i>Alan Sugarman and Caroline DePottel;</i>	875-879
Vicarious Conditioning; <i>E. Thomas Dowd;</i>	881-883
Vicarious Extinction; <i>E. Thomas Dowd;</i>	885-887
Virtual Reality Therapy; <i>Max M. North and Sarah M. North;</i>	889-893
Vocational Rehabilitation; <i>Ruth Crowther;</i>	895-900
Women's Issues; <i>Malkah T. Notman and Carol C. Nadelson;</i>	901-908
Working Alliance; <i>Georgiana Shick Tryon;</i>	909-912
Working Through; <i>Mark J. Sedler;</i>	913-916



Acceptance and Commitment Therapy

Kirk Strosahl

Mountainview Consulting Group, Inc.

- I. Theoretical Bases of ACT
 - II. Description of ACT Treatment
 - III. Empirical Studies of ACT
 - IV. Summary
- Further Reading

GLOSSARY

cognitive fusion The act of perceiving private experiences such as thoughts and feelings from the perspective structured by the private event itself rather than the perspective of an observer of that event as a process. Reducing fusion is a key target of meditation, mindfulness, and deliteralization interventions in ACT.

cultural change agenda The culturally sanctioned model most clients bring into therapy holds that the goal is to gain control of and eliminate negative personal content. This agenda for changing from an unhealthy person with “issues” to a healthy person without “issues” has the paradoxical effect of increasing suffering.

literality The capacity of representational thought and language to take on literal meaning and for the derived stimulus functions of referents to dominate over other sources of behavior. An example is “anticipatory panic attacks,” which result from simply imagining being in a panic associated situation, such as a mall or elevator, and then taking those thoughts literally.

relational frame theory (RFT) A post-Skinnerian account of the structural and functional properties of human language and thought that is based in contextual behaviorism. RFT views language and thought as relational behavior that is controlled by learning factors.

Acceptance and commitment therapy (ACT) is a contextually based cognitive behavioral treatment. The ACT model holds that culturally supported attempts to control and eliminate unpleasant private experiences (i.e., negative emotions, thoughts, memories) result in personal suffering, behavior disorders, and a lack of vital and purposeful living. ACT attempts to teach clients to accept, rather than control or eliminate, private experiences that are not amenable to first order change. Acceptance is accomplished through teaching the client to see these private experiences as conditioned verbal responses, rather than literal truth. ACT emphasizes that the client approach, rather than avoid, valued life goals, even though pursuing such goals may stimulate “uncomfortable” private experiences.

I. THEORETICAL BASES OF ACT

Acceptance and commitment therapy is unique among the cognitive behavioral therapies in that it is theoretically derived from relational frame theory (RFT). RFT is a post-Skinnerian behavior analytic account of the functional properties of human language and thought, developed by Steven Hayes and other behavior analytic researchers around the world. Hayes and colleagues conducted two decades of basic research to validate the core principles of RFT before introducing the ACT therapy model. As we shall see, many ACT interventions are based in RFT principles and are designed to influence the contextual and functional characteristics

of language and thought. There are several principles of RFT that are directly relevant to both the development of human suffering and psychopathology, as well as clinical interventions.

First, it is not functionally useful to separate the functions of human language and thought from the contextual field in which the human organism operates. These processes are learned, reinforced, and reciprocally governed in the same fashion as any other learned human behavior. In RFT, language and thought are a special form of relational behaviors that enable the human organism to relate events bidirectionally and in combination, whereas direct experience is only unidirectional. For example, learning that a ball is called "ball" enables the human to look for and orient toward the ball when later hearing "ball." This simple process is apparently absent in nonhumans, but occurs in human infants by about 14 months.

A second critical RFT principle is that the context or "field" of language and thought involves both externally and internally generated verbal relations. The external context is the verbal community, consisting of verbally transmitted cultural practices (i.e., the language called "English" is what you will speak), social influence and consequence (i.e., you need to justify with the correct set of words why you hit someone, otherwise you get punished), and interpersonal influence (i.e., if you don't give a good reason why you hit Johnny, you will get a spanking). The development of a culturally compliant human organism is dependent on this process. The main vehicle of cultural transmission is the process of language acquisition and refinement. Eventually, language is experienced covertly in the form of thinking. The internal context is the relationship between the thought and the thinker. Humans have the ability to "receive" thoughts, weigh their merits (using other thoughts) and produce an action justified in terms of the second set of thoughts. The complexity of this constantly evolving set of relationships, combined with a constant reciprocal interaction with the verbal community, requires that humans engage in hundreds of thousands of language and thought transactions daily, much of them beneath the level of conscious awareness. The result is that humans become so dependent on these symbolic processes that they cease to recognize them for what they are: arbitrarily derived relations between verbal stimuli. When this occurs, the dominance of language and thought can become so excessive that the organism ceases to adapt to the demands of the environment and, instead, is controlled by symbolic representations of the envi-

ronment. In ACT, this is referred to as the hegemony of language.

A third key principle of RFT is that there are distinct functional properties of language and thought that explain not only the tremendous evolutionary advantage of human thought, but also its "dark side." The bidirectionality of human language enables humans to produce pain simply by remembering past pain or anticipating it in the future. For that reason, humans cannot regulate their psychological discomfort by escaping aversive situations, and instead begin to attempt to avoid or modify emotions. Thus, emotional avoidance is built into human language. Many unique forms of human behavior (e.g., humans are the only species known to commit suicide), seem to be a side effect of this process.

Relational behavior in turn enables rule-governed behavior: the generation of verbal formula to use in guiding human action. Unlike contingency governed actions, which are shaped systematically through direct trial and error (e.g., learning to ride a bicycle), rule-governed behaviors are developed through the verbal specification of contingencies, rather than through direct contact with them. This form of learning greatly expands the potential for learning important rules without having to make direct contact with the contingencies specified by those rules.

There are many different types of rule-governed classes that have clinical significance. Augmentation involves a rule that changes motivation, typically by relating some immediate situation with a verbally constructed set of future contingencies. For example, a young college student might be highly motivated to study by having images of getting a high-paying job several years hence (i.e., a motivative augmental). Getting an "A" on an important exam is reinforcing because of the augmenting effect of the future contingencies. The consequence is the persistence of studying behavior. Pliance is a more basic form of rule-governed behavior. "Plys" are rules that influence the person to behave in culturally sanctioned ways. Telling a crying child, "Be a good boy now and stop crying," is in effect saying to please the parents by stopping the act of crying. The child may stop crying, even though significant physical discomfort is present. Tracking is another common form of rule following that involves establishing a relationship between a rule and a set of nonarbitrary contingencies. A track might involve responding to a weather report that calls for record cold temperatures by securing a heavier coat, because past history has established a relationship between the

temperature outside and the type of clothing that produces warmth.

Because of the general utility of rules, a pervasive consequence for rule-governed behavior is sense making. It appears that humans are highly motivated to organize derived relations within an overarching framework that helps them “make sense” of these relationships. Independent of whether the relationships are factually correct, humans will create this type of conceptual order. In ACT, this is referred to as the “context of reason giving.”

The ACT account of human pathology applies RFT principles to the larger rule-governed context of human behavior. First, RFT research has established that, for all their evolutionary utility, rule-governed behaviors are extremely resistant to the mitigating effects of direct experience. At the same time, these change-resistant features are hidden in the very structure of language and thought. A brief clinical example will highlight how basic RFT principles directly convert into clinical dysfunction:

A woman who was sexually abused as a child reports persistent problems with extreme fearfulness when engaging in any kind of intimate behavior with a new boyfriend. She reports having the same kinds of experiences she remembers having when she was being sexually victimized (based on a “frame of coordination” between the two events). She reports being unable to trust her male friend even though there is evidence that he is different than her abusive father (a “transformation of functions” through that frame of coordination). She has been taught that the key to a fulfilling life is to form a positive intimate relationship, and has continued dating so as not to disappoint her mother (pliance). She is frustrated and angry with herself because she believes she is “defective” due to her childhood abuse history. The proof of this is healthy people are able to trust others in intimate relationships and she cannot (sense making). She has decided to stop dating because she believes her fear, mistrust, and disappointment will just get worse (augmentation). She wonders what she ever did to deserve being abused.

When a person encounters negative personal content such as in the sexual abuse vignette, culturally transmitted, verbally based responses are activated that determine both the outcome to be achieved and the processes needed to achieve it. Basic social programming suggests that “health” is measured by the absence of negative psychological content. In western culture, psychopathology and suffering are viewed as

deviations from a natural state of psychological health. When confronted with negative personal experience, the socially sanctioned response is directly analogous to the process used to handle challenges in the external world. Specifically, first one identifies the cause of the problem, then employs strategies designed to eliminate the cause and, through the causal chain, the problem itself.

In contrast, the ACT approach holds that suffering and dysfunction arise from following these culturally sanctioned, but ineffective, rules for coping with distressing experiences. Paradoxically, the use of control and elimination strategies leads to greater suffering and an apparent loss of control of the symptoms to be eliminated. In ACT, this is termed the “rule of mental events.” Specifically, the less one is willing to have a problematic private experience, the more one gets of it. There is significant research to support this core feature of human experience. For example, the thought suppression literature demonstrates that suppression and control strategies produce an upsurge in unwanted thoughts, and increased distress. Ironically, the strategies that have produced so much success for the human species in the external world are the cause of suffering and psychopathology when applied to events “between the ears.” The reasonable, normal, sensible things people do to address suffering in fact generates suffering. In ACT, this is referred to as the problem of unhealthy normality. Clients do not present for treatment because they are “broken,” but because they are trapped in an unworkable culturally supported change agenda.

The cultural change agenda is supported by basic rule-governed behaviors that normally are not within the awareness of the client. In ACT, these core dysfunctional responses are described in the FEAR model of suffering:

Fusion: This is the tendency of humans to merge with the content of their private experiences, leading to the problem of literality. Literality means that the distinction has been lost between symbolic activity and the event that acts as its referent. In the example above, the woman is fusing historically learned physical and emotional symptoms (from the original trauma) with a conceptually similar current event (intimate relations with her boyfriend) and attributing her reactions to the current event. She has fused the emotional and physical properties of a distant event with a minimally similar current event. Hence, her verbal formulation suggests she has trust issues, whereas the core issue is her fusion with historically conditioned responses.

Evaluation: This is the tendency of humans to categorize and attribute qualities to referents, as though they are primary properties of the referents. An example of major evaluative themes in psychopathology and human suffering are “good-bad,” “right-wrong,” or “fair-unfair.” Through the process of fusion, evaluations become inseparable from the events they are intended to qualify. In the example above, the woman states she is defective, as if defective was a primary property at the level of being. In truth, she is a woman who is having the self-evaluative thought called, “I am defective.” She indicates that healthy people do not have these issues, a form of good-bad attribution. She wonders what she did to deserve the abuse, essentially imbuing life with some independent property of fairness.

Avoidance: Due to the impact of bidirectionality and rule-governed behavior, humans are inclined to avoid the situational or representational “triggers” for unpleasant consequences. Paradoxically, this type of experiential avoidance may stimulate feared or unwanted private experiences such as thoughts, feelings, memories, or bodily sensations. There is a significant empirical literature demonstrating the unhealthy effects of experiential avoidance, even in nonpsychiatric samples. It is implicated as a primary mechanism in numerous mental and chemical dependency disorders. Experiential avoidance is almost always predicated on the mistaken belief that, by avoiding participation in challenging life events, one will not have to experience the uncomfortable private experiences associated with participation. In the example above, the woman indicates she has decided to stop dating, rather than experience continued fear, mistrust, and relationship failure. Paradoxically, it is precisely by withdrawing from the “field of play” that her childhood trauma exerts its maximum negative influence over her life. Each day spent not participating lends credence to her notion that she is “defective,” elevates her anticipatory fear response about accidentally meeting a soul mate, and deprives her of the opportunity to practice being intimate while being afraid.

Reason Giving: This is the tendency to present reasons that explain the cause of particular forms of private experience and/or behavior. In essence, the cultural context of language and thought teaches humans to give socially sanctioned reasons for behavior, especially behavior that is out of the perceived cultural norm. The most common reason-giving strategy is a two-step process: First, describe a set of historical influences that hypothetically explain a predisposing pri-

vate experience such as a negative thought, feeling, memory, or physical sensation: Second, describe the predisposing private experience as a cause of the resulting behavior. In the example above, the woman presents her problem as being linked historically to her sexual abuse. The sexual abuse is used to explain her fear experiences during intimacy. She then justifies her lack of intimacy behavior by setting her private experiences in opposition to the desired outcome (i.e., one cannot be intimate while being afraid; fear causes the loss of intimacy). In the end, she has “justified” why intimacy is impossible and why she is entitled to cease efforts in that area.

Reason giving is a pervasive issue in human dysfunction for many reasons, but two are worth noting. First, not only do humans have extremely limited access to the vast multitude of influences that shape their learning history, but also there is no convincing evidence that private events “cause” behavior. The client’s story is an arbitrary set of internally consistent, culturally shaped and sanctioned reasons that probably bears little resemblance to a complete historical analysis. Second, most forms of therapy are rooted in the verbal community and consequently a premium is placed on giving “good” reasons for being distressed and dysfunctional. Not only is the abused woman giving an inaccurate account of her learning history (focusing on the sexual abuse and ignoring a multitude of other learning factors), proposing an unlikely cause–effect relationship (her fear “causes” her to stop being intimate), but very likely will have this “story” tacitly endorsed by the therapist.

II. DESCRIPTION OF ACT TREATMENT

ACT seeks to accomplish several major results. The first is to help the client use direct experience, instead of rule following, to discover more effective responses to the challenges of being alive. The second is to discover that control and elimination strategies are the cause of suffering, not the cure for suffering. The third is to realize that acceptance and willingness are viable alternatives to struggle, control, and elimination. The fourth is to understand that acceptance is made possible by learning to detach from the rule-governing effects of language and thought. The fifth is to realize that the basic, unchanging self as consciousness is a place from which acceptance and committed action can occur. The final result is the understanding that

the road to vitality, purpose, and meaning is a journey consisting of choosing valued actions that are performed in the service of valued life ends. In ACT, the response to the life-limiting effects of FEAR is:

*Accept
Choose
Take action*

To many clients, the notion of turning around and embracing feared memories, hidden insecurities, perceived shortcomings, and negative personal history is frightening. The grip of self-limiting, rule-governed responses is so complete that clients cannot even see the system they are trapped in. Most clients know they are suffering, but are completely immersed in the private logic of their verbal conditioning. To attack this basic problem, ACT tries to engender a healthy skepticism about the role of language and thought in managing negative personal content. Ironically, therapy is an enterprise that occurs within the context of the verbal community. To attempt to undermine dysfunctional rule-governed behaviors through the use of verbal concepts such as “belief,” “understanding,” and “insight” is analogous to fighting a small fire with a can of gasoline. The ACT therapist must use words, images, metaphors, and experiential exercises in ways that undermine the client’s confidence in the utility of language and thought. This must occur without ACT concepts being coopted into the client’s system of “understanding.” It is not unusual for an ACT therapist to say such things as, “If this makes sense, then that’s not it” or “Don’t believe a word I’m saying.” By attacking the hegemony of language and thought through the nonliteral use of verbal concepts, the therapist is fighting fire with fire. The trick is to avoid being burned.

ACT can be separated into basic thematic components that often occur in a somewhat predictable sequence. However, it is important to understand that the relative prominence of different themes drives both the focus and strategies of therapy. It is frequently unnecessary to expose a client to all the stages of ACT. Some clients already have applied experience with acceptance and mindfulness strategies and may readily employ them when supplied with the proper framework. However, the same client might struggle mightily with committed, valued actions. With this type of client, more focus would be placed on values clarification, distinguishing life processes from life outcomes and so forth. For present purposes, we shall describe the core themes as “stages,” because there is a sort of logic to how

human suffering unfolds and, consequently, to how ACT might unfold.

A. First Thematic Stage: Creative Hopelessness

The goal of creative hopelessness is to help the client determine that the cultural change agenda is unworkable. The change agenda the client typically brings into therapy is to determine the cause of suffering and then to eliminate the cause, so the problem will dissipate. This typically converts into a cause and effect statement: “If I had more confidence in myself, I wouldn’t be so anxious in new social situations.” The goal of therapy is to provide me with more confidence, so my anxiety will go away. The notion of “workability” is central to ACT. Generally, clients have tried these commonsense change strategies repeatedly, even in the face of repeated disconfirming experience (the more you try to get confidence, the less confident you are). The client’s rule following has all but eliminated the corrective effects of direct experience. The client tries the same strategies over and over again, even though direct experience suggests these strategies are doomed to fail. In ACT, the therapist is likely to ask, “Which are you going to believe here? Your mind or your experience?” Often, the clinical goal of this stage is simply to get the client to stop using strategies that are not workable. At the same time, the therapist is attempting to create a readiness to see the problem in a larger context.

B. Second Thematic Stage: Control Is the Problem, Not the Solution

In this thematic module, the client is exposed to the unworkable, paradoxical nature of control and elimination strategies and their natural offshoot, experiential avoidance. The client is exposed via metaphor, story, and experiential exercise to an essential feature of control and elimination strategies: The more one attempts to control undesirable content, the more undesirable content occurs. The rule of mental events, described earlier, is a cornerstone of this stage. In this stage, the negative effects of experiential avoidance are drawn out for the client. Generally, this involves determining what situations and/or experiences the client is avoiding in the service of controlling negative experiences. Next, the client will evaluate whether the avoidance is “paying off” in terms of promoting positive psychological events or reducing

negative ones. For example, the sexually abused woman might be asked to gauge whether avoiding dating has increased or decreased her sense of mistrust of men, increased or decreased her sense of relationship failure, and so on. Generally, the concept of “willingness” will be introduced, as an alternative to control, elimination, and avoidance. Willingness is the choice to have unpleasant private content at the level of awareness, but without evaluation or struggle. Often, clients will be asked to maintain a “willingness-suffering-workability” diary that lets them collect data on the relationship between levels of willingness, intensity of suffering, and perceived workability of their lives.

C. Third Thematic Stage: Defusing Cognitive Fusion

The Latin root of fusion means to “pour together.” As discussed earlier, clients suffer when they pour together direct experience, representations of direct experience, thoughts, feelings, and so forth. They become lost in the maze of private events, such that it becomes difficult to separate what is real from what is being represented. The goal of this stage is to help the client detach from the literal meaning of private experiences and instead to see private experiences as separate from the basic self. This goal is critical because it is very difficult for clients to accept the most provocative, negative forms of private experience without the ability to see private experiences from the perspective of an observer. ACT employs a wide variety of “deliteralization” strategies in this stage. Deliteralization strategies generally seek to reveal the functional and/or representational properties of language, stripped of their concealment in the system of language. This allows the client to see thoughts as thoughts, feelings as feelings, reasons as reasons, evaluations as evaluations, and so forth. The result is that the client is able to defuse fusion. This might involve showing how easily behavior can be programmed through simple, obvious augmentation strategies. Alternatively, the client might be asked to produce multiple, different autobiographies or to say the word “milk” over and over again until the word “goes away” and a guttural, chopping sound is all that is experienced. Throughout this stage, clients are exposed to the FEAR algorithm, as it is expressed through cognitive fusion. A host of metaphors, stories, and experiential exercises are typically employed to attack the literal attachment to cognition, emotion, memory, and other private representations of experience.

D. Fourth Thematic Stage: Self as Content, Self as Context

Acceptance is most likely to occur when there is an unassailable point from which to observe and make room for distressing private content. Similar to various forms of meditation, ACT seeks to help the client locate a sense of self that is larger than the experience of the products of brain behavior. This is done in the service of making willingness and various forms of acceptance less emotionally hazardous for the client. In ACT, there are three types of self: (1) Self as conceptualized content is analogous to a “self concept.” It is the verbally evaluated summary statement of characteristics and attributes (i.e., I have always hated fighting). This form of self is quite rigid and is frequently a problem in therapy. Many clients will vigorously defend their “self concept,” as if their life depended on it, even when the content of the self-concept is negative; (2) Self as ongoing process reflects the ability to report current mood states, thoughts, verbal analyses, and other products of direct experience. This form of self is necessary for psychological health. It is the vehicle for experiencing what is to be experienced in the “here and now.” Avoidance of this form of self tends to produce the most basic and severe forms of psychopathology; (3) Self as context is the most basic sense of self that is possible. It is awareness and consciousness itself. There are no limits or boundaries to basic consciousness. It contains everything within it. It is immutable and, unlike other forms of self, never changes in character. It is the context in which all private events take on reference. Whatever their form or content, the client’s struggles are acted out on the stage of consciousness itself. Yet, the integrity of consciousness is not at issue. If accessed, this space puts the client in a position where private experiences can be observed, without struggle. In ACT, this is referred to as the “you that you call you.” Learning to make contact with this form of self is a skill that can be learned with practice. Consequently, ACT employs a wide diversity of mindfulness, awareness, and meditation exercises to develop this connection.

E. Fifth Thematic Stage: Willingness as a Chosen Action

Given the conditioned, rule-governed nature of private experience, little direct control can be exerted over the instantaneous reactions triggered by various stimulus events. In a previously described stage of ACT, willingness is used to describe a nonjudgmental

awareness of disturbing private content. However, there is a more basic form of willingness that is central to ACT. Willingness the action is the choice to enter into valued life activities, with certain knowledge that feared, private responses will be stimulated. These “monsters” generally are associated with the control, elimination, and avoidance behaviors that have previously trapped the client. This form of willingness is a qualitative act, driven by choice, rather than by persuasion or reason.

Choice is a core concept in ACT. It is an action taken with reasons, but not for reasons. It is a form of volunteerism, or voting with one’s feet. This is the resting potential of any client; the ability to transcend learning, history, and logic and simply take an action that can produce vitality, meaning, and purpose. A variety of ACT exercises teach the client that willingness is both a chosen action and almost invariably involves making room for feared experiences. Choosing willingness is made more difficult when cognitive fusion is extreme and the sense of self as context is weak. Thus, willingness and choice generally become therapeutic foci when cognitive defusion and self-identification strategies have had some degree of success. In the sexual abuse example, the willingness question might be, “Would you be willing to continue dating in the service of your dreams of developing intimacy, knowing that you will have to make room for mistrust, conditioned fear responses, and self critical thoughts?”

F. Sixth Thematic Stage: Values, Goals, and Committed Action

Although ACT is heavily focused on dismantling ineffective rule-governed behaviors, this process is important only to the extent that it results in the client living a more vital, purposeful life. This can only be achieved through committed actions that are in pursuit of valued life outcomes. Often clients have lost sight of their dreams, because of the pernicious effects of control and avoidance behaviors. They have slipped into a haze where it is difficult to imagine a life much different from the one they are living. ACT attempts to “jump start” the process of committed action by helping the client define core life values, associated goals and develop specific committed actions. A basic ACT intervention is called, “What do you want your life to stand for?” This involves having the client imagine that he or she has died and is listening to eulogies from different significant others at the funeral. The question to be answered

is, “What do you want to be remembered for, by those you leave behind?”

There are many nuances involved in developing committed action. One is helping the client differentiate between values as process rather than values as outcomes. To this end, ACT employs a variety of exercises that emphasize committed action as a journey, rather than a destination. A basic ACT principle is, “Goals are the process by which the process becomes the goal.” Vitality is produced by seeking, rather than by reaching valued outcomes. Further, some values cannot be “achieved,” only enacted on a continuing chosen basis. An example is the value of being a loving spouse. One never “reaches” love; there is always more love to experience. Similarly, a loving act often occurs when the feeling of love is missing. A second issue is that, in the name of seeking vitality, the client may have to jettison a well-practiced story that rationalizes why vitality and meaning are impossible to attain. Frequently, this story involves traumatic personal history and the need to remain dysfunctional to prove that a transgression occurred. The client may have to let go of the sense of trauma, shame, and blame in order to pursue vitality. In ACT, this form of forgiveness is construed to mean, “Giving oneself the grace that came before the transgression.” A common ACT question is, “Who would be made right, or who would have to be let off the hook of blame, if you committed yourself to living a valued life?”

III. EMPIRICAL STUDIES OF ACT

ACT is a relative newcomer to the family of cognitive-behavioral treatments and therefore does not have a highly developed empirical literature at this point. However, the initial empirical results have been positive. There have been two controlled studies looking at the relative efficacy of ACT and cognitive therapy with depressed patients. In one controlled study, ACT produced significantly greater reductions in depression than cognitive therapy. A second controlled study with depressed patients showed the two treatments to have equal efficacy. However, analysis of depressive thinking process measures suggested that ACT had a significantly greater impact in reducing the believability of depressive thoughts. A recent study examined the effect of providing a psychoeducational intervention or ACT with a randomly assigned group of hospitalized patients with schizophrenia. The interventions were designed to target the disturbing effects of visual and auditory hallucinations. Results were intriguing: ACT

patients reported a greater self-reported frequency of hallucinations, but rated the hallucinations as less distressing than the psychoeducational intervention patients. In contrast, the patients undergoing psychoeducational treatment reported significantly fewer hallucinations, but significantly more distress associated with the hallucinations. ACT interventions have also been shown to have a significant effect with such diverse problems as chronic pain, occupational stress, and high medical utilization.

ACT is one of the few cognitive-behavioral treatments to undergo a field-based clinical effectiveness study. Strosahl and colleagues developed an ACT training package for a group of masters' level therapists in an outpatient HMO mental health system. Compared with a control group of therapists who did not receive the training, ACT therapists produced greater clinical benefits as reported by patients, had less referrals for psychiatric medicines, and were more likely to complete cases earlier with the mutual consent of the client. In an uncontrolled clinical effectiveness study, Strosahl found that chronically depressed personality-disordered patients treated in the ACT model reported significant reductions in depression and an increased rate of achieving important personal goals. There are several large clinical trials underway examining the effectiveness of ACT with severe drug addiction, tobacco cessation, and social phobia. Hopefully, results of these and future studies will help delineate the clinical effectiveness of ACT, as well as describe the process mechanisms that underpin the treatment.

IV. SUMMARY

Acceptance and commitment therapy is one of the new generation of cognitive and behavioral therapies that utilizes acceptance and mindfulness strategies, in addition to first-order change strategies. The emphasis on acceptance strategies may be attributed to the growing recognition that first-order change is not always possible, or even desirable. There are many aspects of human experience that cannot be directly altered through psychotherapy or any other type of change effort. As we have discussed, the human nervous system works by addition, not by sub-

traction. Rule-governed responses never really disappear, they are simply placed in a different relational frame under the dominance of new rule-governed behaviors. When ACT is successful, clients understand that there is no need to shun undesirable personal history, temperament, spontaneous emotions, thoughts, and so forth. These are unique and healthy human qualities. Indeed, the human organism is perfectly made to experience each of these qualities, and therein lies the potential for vitality, purpose, and meaning.

See Also the Following Articles

Avoidance Training ■ Language in Psychotherapy ■ Relational Psychoanalysis

Further Reading

- Hayes, S. (1987). A contextual approach to therapeutic change. In N. Jacobson (Ed.), *Psychotherapists in clinical practice: Cognitive and behavioral perspectives* (pp. 327–387). New York: Guilford Press.
- Hayes, S. C., Barnes-Holmes, D., & Roche, B. (2001). *Relational frame theory: A post-Skinnerian account of language and cognition*. New York: Plenum.
- Hayes, S., & Hayes, L. (1992). *Understanding verbal relations*. Reno, NV: Context Press.
- Hayes, S., Jacobson, N., Follette, V., & Dougher, M. (1994). *Acceptance and change: Content and context in psychotherapy*. Reno, NV: Context Press.
- Hayes, S., Strosahl, K., & Wilson, K. (1999). *Acceptance and commitment therapy: An experiential approach to behavior change*. New York: Guilford Press.
- Hayes, S., Wilson, K., Gifford, E., Follette, V., & Strosahl, K. (1996). Emotional avoidance and behavior disorders: A functional dimensional approach to diagnosis and treatment. *Journal of Consulting and Clinical Psychology, 64*, 1152–1168.
- Strosahl, K. (1991). Cognitive and behavioral treatment of the personality disordered patient. In C. Austad & B. Berman (Eds.), *Psychotherapy in managed health care: The optimal use of time and resources*. Washington DC: American Psychological Association.
- Strosahl, K., Hayes, S., Bergan, J., & Romano, P. (1998). Assessing the field effectiveness of acceptance and commitment therapy: An example of the manipulated training research method. *Behavior Therapy, 29*, 35–64.

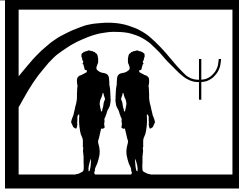

Addictions in Special Populations: Treatment

Paul R. Stasiewicz and Kellie E. Smith

Research Institute on Addictions

- I. Introduction
 - II. Racial/Ethnic Minorities
 - III. Women
 - IV. Summary
- Further Reading

GLOSSARY

cultural competence The belief that treatment providers should recognize and respect other cultural groups and be able to effectively work with them in a clinical setting.

special populations People with special treatment needs related to age, gender, ethnic background, or health status that are underserved by alcohol and drug treatment resources.

I. INTRODUCTION

The origin of the term “special population” can be attributed to several U.S. government agencies involved in health and human services in the mid-1970s. The term is reserved for groups whose need for substance abuse treatment programs has been underserved. The purpose was to identify subgroups in order to help with planning and evaluating the national treatment system for alcohol and drug problems. The goal was to provide funding for specialty programs, or to ensure that mainstream programs were structured to provide appropriate treatment services. Special population groups are most often defined in terms of age, race/eth-

nicity, gender, and health status. This article focuses on the treatment of addictive behavior in racial/ethnic minorities and women. These groups present unique treatment issues such as pregnancy and culture-specific beliefs and attitudes regarding substance use. In addition members of minority groups report higher rates of substance abuse problems than do whites, and the number of women entering treatment for substance abuse problems has increased in the past two decades.

II. RACIAL/ETHNIC MINORITIES

A. Description of Treatment

Ethnic and racial diversity is increasing in the United States, and according to the 1991–1993 National Household Survey on Drug Abuse members of various ethnic minorities report higher rates of substance use and related problems than do Whites. Although a need for treatment services exists, special populations often encounter barriers to obtaining treatment for alcohol and drug problems. The Office for Substance Abuse Prevention includes the following common barriers to treatment:

- **Cultural barriers:** Many programs lack staff who share the cultural background of those being treated. In addition, staff may lack sensitivity and/or training regarding the cultural beliefs and practices of their clientele. Language barriers also may exist.

- *Funding*: Many members of minority groups lack insurance or personal funds to pay for treatment.
- *Availability*: Waiting lists are common at affordable programs.
- *Child care*: Often not available at treatment sites. Some people may fear losing custody of their children if they seek treatment for an alcohol or drug problem.

These factors make it less likely that minorities will enter mainstream treatment programs. Of those who do enter treatment, the outcome data are mixed with some studies showing minority patients to have treatment outcomes equal to those for Whites, and other studies showing that minority patients have poorer outcomes and are less likely to complete treatment.

The high rates of substance use problems among many ethnic and racial minorities, combined with the barriers encountered by these individuals in mainstream treatment programs, raise the issue of whether or not to develop culturally sensitive treatment programs. Typically, these programs employ staff from varied cultural backgrounds and/or provide training to staff members in cultural issues. Culturally sensitive treatment programs may improve access to treatment for some individuals, but there are few scientific studies that examine or support their ability to produce improved outcomes. Therefore, the benefits of such programs are not yet thoroughly understood. Moreover, there is often considerable heterogeneity within specific ethnic or racial groups. Major sources of such heterogeneity include

- *Subgroups within a major ethnic group*: For example, there are approximately 300 different American Indian tribes. Many of these have their own unique culture and have developed specific norms regarding substance use, help-seeking behavior, and healing. Similarly, Hispanics who are Cuban American, Central American, Puerto Rican, and Mexican American have different attitudes toward substance use and treatment for substance-related problems.
- *Personal characteristics*: Members of the same minority group vary on several dimensions that have implications for treatment outcome. Included here are socioeconomic status, education level, and employment status.
- *Acculturation*: Members of the same minority group may differ in terms of their acculturation or assimilation to the majority culture.

It is unlikely that a single treatment approach could be developed that would suffice in addressing such

variability. Alternatively, it would not be realistic nor cost effective to develop separate programs for each distinct subgroup. This is not to say that the development and cross-cultural validation of such programs be discontinued. However, while these programs are being developed and evaluated, it seems reasonable to utilize existing approaches that have been demonstrated to have relative efficacy with other populations of substance abusers. Such treatment approaches include, but are not limited to, brief motivational interventions, cognitive-behavioral approaches, behavioral couples therapy, and the community reinforcement plus vouchers approach.

1. Brief Motivational Interventions

Brief interventions (e.g., motivational enhancement therapy, guided self-change) have been shown to be as effective as long-term inpatient treatment for alcohol problems. Core elements of these interventions include objective feedback regarding the nature and severity of the problem, acceptance of personal responsibility for change, providing a menu of change strategies, and an empathic therapist style.

2. Cognitive-Behavioral Approaches

A set of strategies including social skills training, behavioral self-control training, relapse prevention, and cognitive therapy. Core elements often include assertiveness training, coping with high-risk alcohol and drug use situations, managing urges and cravings, managing thoughts about drinking and drug use, problem-solving training, drink and drug refusal skills, and managing negative thinking and negative moods.

3. Behavioral Couples Therapy

This approach aims to improve communication and conflict resolution skills to help achieve and maintain abstinence. It assumes that family members can reward abstinence and that alcohol and drug abusers with healthier relationships have a lower risk of relapse. According to Timothy O'Farrell and William Fals-Stewart a core element of this approach is the daily sobriety contract in which the patient expresses his or her intention not to drink or use drugs on a given day, and the spouse provides support for efforts to remain abstinent.

4. Community Reinforcement Plus Vouchers Approach

This approach includes a number of skills-training components similar to those mentioned earlier. It also includes prompt reinforcement for drug abstinence by

using vouchers. The points accumulated can be spent for anything that contributes to furthering the patient's treatment goals. All purchases are made by the treatment staff.

Given the absence of research on the application of these and other treatment approaches for ethnic minorities, how should one proceed in tailoring existing treatment approaches to culturally diverse groups? The following steps have been proposed by clinicians and researchers alike. First, mainstream substance abuse treatment programs can ensure a degree of cultural sensitivity by hiring minority staff and/or providing training to increase the cultural responsiveness of staff members. Although there is limited evidence to support the overall treatment effectiveness of culturally sensitive therapists (CSTs), there is somewhat more evidence to support the role of CSTs in engaging and retaining minorities in treatment. Second, it would be important to identify the unique cultural aspects of a particular group, including those that may be affecting the person's recovery. For example, a client whose culture teaches her to be passive may feel it is wrong to express her feelings, even though such feelings may be a reason for continued substance use. Third, existing treatment approaches can be modified to include culturally relevant material. Comas-Diaz and Duncan included a cultural component in an assertiveness training program for low-income Puerto Rican women. In addition to standard assertiveness training, the women identified cultural factors prohibiting the development and expression of assertive behavior. They also identified potential conflicts that might arise as a result of their assertiveness and were taught strategies for managing these conflicts.

Although most writers call for culturally relevant treatment, there are few models that operationally define how clinicians and researchers should proceed. Clearly, there is a need for the systematic development and evaluation of such treatment programs. However, while waiting for such programs to be developed, ongoing efforts should be made to adapt existing, empirically supported treatments to specific cultural groups and to enhance the cultural competence of therapists in mainstream treatment programs.

B. Theoretical Bases

Theoretical models of substance abuse among ethnic minorities are lacking. Reasons for substance abuse are more common and are typically based on one or more key characteristics of a given cultural group. Despite

the lack of theoretical development in this area, many accounts of substance abuse within a specific cultural group may be explained by existing models of addictive behavior. For example, a popular cognitive-behavioral model of addictive behavior is the stress-coping model. This model views substance use as a coping response to life stress that can function to reduce negative affect or increase positive affect. *Stress* refers to the problems or tensions that people encounter throughout life, and *coping* refers to the behavioral or cognitive responses that people use to manage stress. Although the nature of the stress may vary across cultures (e.g., PTSD among Southeast Asians), the underlying mechanism—that alcohol and drugs reduce stress—may generalize from culture to culture.

High rates of substance abuse in some ethnic minorities have been attributed to relatively greater experiences of stress. Major sources of stress include

- *Environmental stressors*: Several major stressors include substandard housing, overcrowding, and unsafe living conditions.
- *Social stressors*: Factors included here are poverty, greater exposure and access to drugs, discrimination, and unemployment.
- *Personal stressors*: A few examples include depression, helplessness, and low self-esteem.

In addition to increased stress, ethnic minorities may lack the personal and social resources necessary to support effective coping responses. In the absence of good coping skills individuals may use alcohol and other drugs to cope with stress. The view that substance abuse is a dysfunctional coping response to stress led to the development of psychosocial interventions focused on strengthening an individual's coping skills. With regard to substance abuse treatment for minorities, the objective for coping skills interventions is to incorporate culturally relevant content when addressing the stressors unique to specific cultural groups.

Acculturation theory has also been linked to substance abuse in ethnic minority groups. Briefly, this theory refers to the three phases of contact, conflict, and adaptation through which members of both minority and majority cultures move, before assimilation is achieved. The ability to align equally with values, attitudes, and behaviors of both the minority and majority culture is called "bicultural competence." With regard to substance use, a person with a monocultural orientation is likely to experience more stress than a person with a bicultural orientation, and therefore is more

likely to use alcohol and other drugs to cope with the stress. In this way, acculturation theory is similar to the stress and coping model described earlier.

C. Treatment Outcome

The focus in research has been on demographic and descriptive characteristics of substance abuse problems among various cultural groups. Well-conducted treatment outcome studies are lacking, so it is unknown whether outcomes would be improved if treatment programs were more sensitive to cultural issues. Controlled trials are needed in which the effectiveness of existing treatments for substance abuse problems are compared with treatments specifically designed, or modified, for a given cultural group. The main question to be addressed is whether culturally relevant treatment approaches increase accessibility, retention, and outcome in ethnic minority populations.

III. WOMEN

A. Description of Treatment

In 1991, The National Institute of Mental Health Epidemiologic Catchment Area Study (ECA) reported that substance abuse was the second most common psychiatric disorder among all female respondents. In addition, the number of women entering treatment for substance abuse problems has increased by approximately 10% since the late 1980s. Despite this increase, Yaffee and colleagues assert that the special needs of women remain unmet by the majority of mainstream treatment programs. In fact, it has been argued that mainstream treatment programs may be seen as a barrier to women seeking treatment for substance abuse problems. For example, the lack of on-site child care services may limit access to treatment for many women.

In the past two decades, funding has increased to aid the development of treatment programs specifically designed for substance-abusing women. These women-oriented treatment programs are characterized by an emphasis on understanding the importance of gender roles in society and how these roles may contribute to the development and maintenance of substance abuse problems in women. Important components of women-oriented treatment programs include the following: treatment for other problems (e.g., domestic violence, depression); child care services; parenting and family-oriented services; comprehensive medical services in-

cluding nutrition, hygiene, prenatal and postpartum care; vocational rehabilitation; legal assistance; transportation assistance; and access to female treatment providers. A consistent difference between women-oriented programs and mixed-gender programs is the provision of services associated with pregnancy and parenting.

Common treatment approaches for women include cognitive-behavioral coping skills interventions, brief motivational interventions, family therapy, pharmacotherapy, and self-help groups. Within each of these approaches, women's issues are addressed by the inclusion of one or more of the women-oriented treatment components mentioned earlier.

1. Cognitive-Behavioral Approaches

Women with alcohol problems exhibit poorer skills for coping with stressors than do women without alcohol problems. Alcohol may be used as a primary coping behavior for these women. This treatment approach teaches skills for coping with high-risk alcohol and drug use situations and also provides other life management skills (e.g., problem-solving, communication, assertiveness, and other skills).

2. Brief Interventions

These interventions provide information, feedback, advice, and support and are known to be effective in addressing substance abuse problems. When the goal is drinking reduction, brief interventions for problem drinking have been shown to be more effective among women than among men.

3. Family Therapy

Strategic-structural family therapy and behavioral family therapy are the two most frequently used models of family therapy for the treatment of substance-dependent women. Family therapy is seen as beneficial because family members often play a significant role in the etiology and maintenance of problematic patterns of substance use among women. For example, a woman's drinking pattern is often influenced by her male partner's pattern of drinking. Therefore, it may be helpful to include both individuals in treatment.

4. Pharmacotherapy

Compared to men, women report more psychiatric problems and are more likely to drink to relieve negative affect. In this regard, medications may be used as adjuncts to psychosocial treatment for substance use and psychiatric disorders. Disulfiram (Antabuse) has a

long history of use as deterrent medication. When taken with alcohol it produces nausea, vomiting, dizziness, difficulty breathing, headache, flushing, and rapid heartbeat. Disulfiram is administered orally on a daily basis, and the client cannot drink for 4 to 7 days following discontinuation of the medication. This delay often provides the individual with time to reconsider the decision to begin drinking. Naltrexone (Revia) is an orally administered opioid antagonist that more recently has been found to be effective for the treatment of alcohol problems. It has been found to decrease craving for alcohol and to produce lower relapse rates when added to psychosocial treatment for alcoholism. Antidepressants and other psychotropic medications may be used to help treat a range of psychiatric symptoms that serve to maintain the substance use disorder.

5. Self-Help Groups

In addition to Alcoholics Anonymous, Women for Sobriety is a mutual-help organization designed to meet the specific needs of women. The program consists of 13 statements, primarily focused on improving self-worth and reducing shame and guilt often reported by its members. Self-help groups can be very useful treatment approaches because they provide an excellent opportunity for women to develop new social roles and relationships and to construct a non-substance-abusing support network.

The treatment approaches just summarized are only a few examples of the wide range of treatment options available. Because a large number of substance-abusing women have multiple problems, there is a need to provide broad and comprehensive services for women. For example, a cognitive-behavioral treatment program for women with alcohol problems may be combined with pharmacotherapy to address strong cravings for alcohol or symptoms of depression. In addition, existing treatment approaches may be further modified to address the individual needs of each female patient (e.g., prenatal care).

B. Theoretical Bases

Most of the work regarding substance abuse in women is largely atheoretical. However, social relationships have been reported to play a greater role in the psychological development of women as compared with men. In this regard, interventions that focus on the development of new relationships or that strengthen the woman's social support network are viewed as beneficial. However, most women-oriented

treatment programs generally include a range of services and develop treatment plans in which specific services are matched to the needs of the individual patient.

C. Treatment Outcome

When examining outcome data from mixed-gender programs, studies to date have found few differences in treatment outcome for men and women. In contrast, research investigating the effectiveness of women-oriented treatment programs has produced mixed findings. Some studies demonstrate better outcomes for women in women-oriented programs compared with women treated in mainstream programs, and others report no differences. A study by Dahlgren and Willander compared women in a women-oriented program ($n = 100$) with female patients in a mainstream program ($n = 100$). At the 2-year follow-up, patients in the women-oriented treatment program had better outcomes both in terms of alcohol consumption and social adjustment as measured by employment status and family relationships.

With regard to the effectiveness of specific interventions for women, research has demonstrated that drinking reduction interventions appear to be beneficial for women who are less physically dependent on alcohol. Several studies have demonstrated that women problem drinkers were more successful than men in attaining moderate drinking. Cognitive-behavioral interventions, in which patients are matched on the basis of personality characteristics and level of motivation, have shown benefit with female substance abusers. Brief interventions that incorporate motivational interviewing strategies have also been effective in reducing alcohol consumption for problem-drinking women. Finally, some studies have indicated that women benefit from self-help groups, such as Alcoholics Anonymous and Women for Sobriety. It is thought that women do well in these groups because they become more involved in the social support network offered by this type of treatment.

Although it appears that women do benefit from treatment, well-conducted treatment outcome studies are lacking, so it is unknown whether outcomes would be improved if treatment programs were more sensitive to gender issues. Nevertheless, one advantage of women-only treatment programs may be their ability to attract women who would not otherwise have sought treatment from a mainstream program. For example, a study by Copeland and Hall found that clients enrolled in a women's treatment program were more likely to be lesbian, or have suffered childhood sexual abuse than women enrolled in other programs. Therefore, the

availability of women-oriented programs and services may contribute to reducing barriers to treatment for some women.

IV. SUMMARY

In 1990, an Institute of Medicine report suggested that caution must be exercised when defining a given person only in terms of his or her gender or racial/ethnic group membership; individuals within both of these special populations vary on other important dimensions that have implications for treatment entry and outcome (e.g., socioeconomic level, education). Moreover, the heterogeneity among persons with substance abuse problems suggests that it may be difficult to identify the key characteristic to use in determining a treatment referral. For example, an individual can be a member of more than one special population group (e.g., a married, black female with depression). In this case, how does the clinician decide which special program best meets the need of this client? At present, the answer is not clear. However, Copeland and Hall and others have reported that special programs may be more likely to attract individuals who would not otherwise seek treatment.

See Also the Following Articles

Controlled Drinking ■ Cultural Issues ■ Matching Patients to Alcoholism Treatment ■ Multicultural Therapy ■ Race and Human Diversity ■ Substance Dependence: Psychotherapy ■ Transcultural Psychotherapy

Further Reading

- Caetano, R., Clark, C. L., & Tam, T. (1998). Alcohol consumption among racial/ethnic minorities. *Alcohol Health and Research World*, 22, 233–241.
- Center for Substance Abuse Treatment. (1994). *Practical approaches in the treatment of women who abuse alcohol and other drugs*. Rockville, MD: U.S. Department of Health and Human Services, Public Health Services.
- Comas-Diaz, L., & Duncan, J. W. (1985). The cultural context: A factor in assertiveness training with mainland Puerto Rican women. *Psychology of Women Quarterly*, 9, 463–47.
- Copeland, J., & Hall, W. (1992). A comparison of women seeking drug and alcohol treatment in a specialist women's and two traditional mixed-sex treatment services. *British Journal of Addiction*, 87, 1293–1302.
- Helzer, J. E., & Pryzbeck, T. R. (1988). The co-occurrence of alcoholism with other psychiatric disorders in the general population and its impact on treatment. *Journal of Studies on Alcohol*, 49, 219–224.
- Institute of Medicine. (1990). *Broadening the base of treatment for alcohol problems*. Washington, DC: National Academy Press.
- Lisansky Gomberg, E. S., & Nirenberg, T. D. (1993). *Women and Substance Abuse*. Norwood, NJ: Ablex.
- Miller, J. B. (1984). *Toward a New Psychology of Women* (2nd ed.). Boston: Beacon.
- National Institute on Alcohol Abuse and Alcoholism. (1994). Special focus: Women and alcohol. *Alcohol Health and Research World*, 18, (3).
- O'Farrell, T. J., & Fals-Stewart, W. (2000). Behavioral couples therapy for alcoholism and drug abuse. *Journal of Substance Abuse Treatment*, 18, 51–54.
- Office for Substance Abuse Prevention. (1990). Alcohol and other drug use is a special concern for African American families and communities (OSAP Fact Sheet, Appendix C). In U. J. Oyemade & D. Brandon-Monye (Eds.), *Ecology of alcohol and other drug use: Helping black high-risk youth* (OSAP Prevention Monograph-7). Rockville, MD: U.S. Department of Health and Human Services, Alcohol, Drug Abuse, and Mental Health Administration.
- Pagliaro, A. M., & Pagliaro, L. A. (Eds.). (2000). *Substance use among women: A reference and resource guide*. Philadelphia, Pennsylvania: Taylor & Francis Group.
- Rebach, H. (1992). Alcohol and drug use among American minorities. In J. E. Trimble, C. S. Bolek, & S. J. Niemcryn (Eds.), *Ethnic and multicultural drug abuse: Perspective on current research* (pp. 23–57). New York: Haworth.
- Substance Abuse and Mental Health Services Administration. (1998). *Prevalence of substance use among racial and ethnic subgroups in the United States: 1991–1993*. Available from <http://www.samhsa.gov/oas/oas.html>
- Terrell, M. D. (1993). Ethnocultural factors and substance abuse: Toward culturally sensitive treatment models. *Psychology of Addictive Behaviors*, 7, 162–167.
- Wetherington, C. L., & Roman, A. B. (Eds.). (1998). *Drug addiction research and the health of women*. Rockville, MD: NIDA.
- Yaffe, J., Jenson, J. M., & Howard, M. O. (1995). Women and substance abuse: Implications for treatment. *Alcohol Treatment Quarterly*, 13, 1.

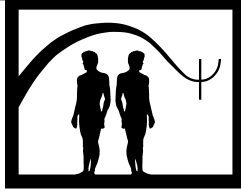

Adjunctive/Conjoint Therapies

Robert Ostroff

Yale University School of Medicine

- I. Adjunctive/Conjoint Therapy
 - II. Theoretical Basis
 - III. Historical Overview
 - IV. Summary
- Further Reading

split treatment The practices of separating treatment functions into different domains. Most often this treatment is used in long-term hospital settings to address the split between administrative and therapeutic functions.

GLOSSARY

adjunctive therapy Two or more therapies used in an integrative fashion to treat an individual with mental illness.

conjoint therapy Therapy consisting of two distinct treatment models: (1) The treatment of two or more related individuals in the same setting, for example, couples treated in a group therapy or family therapy groups and (2) treatment used interchangeably with *adjunctive therapy*. In this chapter, the second meaning always applies.

integrative treatment Treatment that attempts to theoretically reconcile different therapeutic approaches into a single therapeutic approach, for example, psychodynamic and behavioral. May also be used interchangeably with *adjunctive therapy*.

psychopharmacotherapy The use of medication to treat mental illness. This therapy is performed primarily by a psychiatrist but may also be practiced by primary care physicians, physician assistants, and advanced nurse practitioners.

sociotherapy The consideration of the patient's entire social milieu as an agent of therapeutic treatment. This treatment is most often practiced in a hospital setting but may also be used in residential settings of all types, including group homes and specialized treatment facilities (e.g., substance abuse programs or other psychiatric rehabilitative settings).

I. ADJUNCTIVE/CONJOINT THERAPY

In today's psychological treatment setting, it is common to find two or more treatments being used together by different health care providers to treat the same patient. In fact, with today's emphasis on outcome and results rather than on the process orientation that dominated the treatment environment until the last several decades, it is more common than not to find adjunctive therapy as the dominant treatment intervention. Although the varieties of adjunctive therapeutic interventions are too numerous to catalog, they may be broken down into several common combinations. By far the most common form of this treatment today is the use of psychopharmacotherapy and individual psychotherapy. In addition, individual therapies are often used adjunctively with group therapy and/or family therapy.

As treatment has become more focused and refined, specialized programs are increasingly being used to treat individuals with similar disorders. Consequently, 12-step substance abuse groups are used with individual substance abuse counseling, and dialectical behavioral therapy (DBT) training groups are used adjunctively

with individual DBT treatment and diagnostically focused groups. For example, anxiety disorder groups or obsessive-compulsive groups are used adjunctively with cognitive-behavioral therapy. Each type of adjunctive therapy may involve slightly or even radically different theoretical biases on the part of individual therapists. A substance abuse counselor running a 12-step group will be informed by a different theoretical orientation than a psychodynamic psychotherapist. The DBT therapist may operate from a different orientation than a psychopharmacotherapist. Yet, with adjunctive therapy, the often varying viewpoints of the treaters are not only made to work together but also often produce results that are superior to either treatment alone. Regardless of the type of adjunctive therapy, a common set of issues arise whenever conjoint treatment occurs.

Whenever more than one therapist is involved in the treatment of the same patient, the issues that always give structure to the treatment are the following: (1) *Treatment hierarchy*: Most typically this involves the identification of a primary therapist. (2) *Role definition*: The function of each therapist needs to be clearly defined, his or her primary domain delineated, and there must be a clear understanding of when each therapist would intervene and when a referral would be made to another therapist. (3) *Theoretical clarity*: Each therapist must understand the theoretical perspective of not only his or her own treatment modality but also that of all others involved in the treatment of the patient. It is also imperative for each therapist to understand areas of potential conflict between theoretical orientations and areas where the treatments should be complementary. (4) *Boundaries*: The boundaries or parameters for each therapy need to be defined clearly for the patient, but each therapist should also understand the boundary definitions of all the therapists involved in an adjunctive therapy. (5) *Goals*: Goals, or expected treatment outcome, should be explicitly defined, for each therapist may have a different contribution to make to the outcome. (6) *Communication*: Clear guidelines are needed for communication between therapists that define when to communicate and how much to communicate. These six areas provide the structure for any type of adjunctive therapy regardless of what combination is being used. Because psychopharmacotherapy individual psychotherapy is currently the most common type of adjunctive therapy, I will use it as a model to explicate each of these areas.

A. Treatment Hierarchy

The treatment hierarchy in adjunctive therapy is perhaps the most straightforward, and because it involves power, it is also the most difficult area for therapists to address. There is a twofold need to identify a primary or principal therapist in any adjunctive therapy: the need of the patient to know who is in charge of the treatment and coordinating it and the need of the therapists involved to know who is responsible for the coordination and integration of care.

Typically, the patient identifies the principal therapist as the one he or she first contacts when initiating treatment. If a patient sees an individual therapist for several sessions and the decision is made to seek a psychopharmacotherapy consultation, the patient will invariably regard the individual therapist as the principal therapist. The patient is likely to orient toward the individual therapist in seeking to identify who the psychopharmacotherapist is and later in processing recommendations made by the psychopharmacotherapist. The converse is just as often true when the psychopharmacotherapist is seen initially in consultation. When the need arises for adjunctive therapy with a referral to an individual therapist, the patient is likely to regard the psychopharmacotherapist as the principal therapist. This hierarchical structure implicitly involves power because the patient will regard the principal therapist as being the arbitrator for decisions regarding treatment and, in fact, as the person who is "in charge" of the treatment. For example, if the need arises for hospitalization, the patient will look to the principal therapist for a recommendation. In this case, if the individual therapist is a nonphysician and the psychopharmacotherapist is a physician, the patient may look to the individual therapist for guidance, even though the physician is the therapist with the power to hospitalize.

It is crucial that the treaters understand this hierarchy because these power issues relate directly to the therapist's professional identity. Each discipline that defines the therapist's professional identity comes with explicit and implicit skill sets that define expertise and power. The physician therapist may feel that he or she alone should have the power to make decisions regarding hospitalization or medication changes. The psychologist therapist treating an individual, who is in couple's treatment together with a social worker, may have difficulty with the social worker colleague recommending psychological testing. These discipline-specific sets of expertise and power need to be understood and should

be somewhat fluid to allow for successful adjunctive therapy. Although it is true that the physician alone has the power to prescribe a medication, the patient may not take the medication or comply with the physician's recommendation without the support and validation of the primary therapist, who might be a social worker. If the treatment hierarchy is understood, it reduces the potential for confusion on the patient's part and lessens threats to the professional identity of the therapists involved in the treatment.

The principal therapist can change during the course of a treatment but must make this change explicit and coordinate it. One of the therapists involved in the treatment may leave the area, necessitating a replacement, a therapist may have irreconcilable differences with a patient, or one of several therapeutic components of an adjunctive therapy may reach a termination point. The principal therapist would coordinate addressing and resolving all of these issues.

B. Role Definition

Adjunctive therapy involves two or more therapists intervening in different ways and often in different domains with the same patient. The roles of the therapists may vary widely, and their areas of intervention may overlap to varying degrees. The role of each therapist needs to be clearly defined. Well-delineated roles aid all the therapists involved and diminish the potential for patient noncompliance, acting out, or resistance to treatment. Using individual therapy/psychopharmacotherapy as a model adjunctive treatment illustrates both the difficulties and the need for role definition.

The individual therapist's role is focused on the psychological domain of the individual and is confined to effecting change in psychological processes. The psychopharmacotherapist's role is focused on the biological domain of the individual and is confined to using medications to effect physiological changes and lead to symptom relief, maintenance of a given state (e.g., euthymic mood), or relapse prevention. This oversimplification diminishes the role of both the treaters and the effectiveness of the adjunctive therapy. At the far border of role definition, it is clear that the individual therapist will not be making recommendations about specific medications and the psychopharmacotherapist will not be making recommendations about interventions that need to be made in individual therapy. At the near border of role definition, there may be great overlap. The patient will complain to the individual thera-

pist about increasing dysphoria and may want to deal with it as an individual therapy issue. On another occasion, the patient will seek the psychopharmacotherapist's help with a medication that aids in improving his or her relationship with female co-workers. In these instances, the therapist must be able to recognize the limits of his or her role and be comfortable directing the patient to the other therapist. Between the two borders of the roles there is the need for each therapist to move in and out of the other's domain. Although psychopharmacotherapy may seem to be easily confined to the biological realm, in practice this is rarely the case. Taking a medication can have powerful psychological meaning for the patient and will need to be discussed and dealt with by the individual therapist as well as by the psychopharmacotherapist. On the other hand, socially phobic patients whose symptoms are relieved by medication may have to redefine themselves and examine how the change in a set of behaviors necessitated by the symptom that is now gone will affect their personal identity. Clearly, this is the role of the individual therapist.

Some issues clearly involve both roles and need to be addressed by both therapists. Insomnia is an example. In a patient with a mood disorder, insomnia might be an early warning that medications need to be changed or adjusted or that a relapse is beginning. Insomnia may also mean that the patient is having difficulty managing external stressors and needs psychological help in improving coping skills. It should be apparent that these are not mutually exclusive phenomena and could occur simultaneously, requiring interventions by both therapists. In fact, either therapist could perform an intervention such as instructing the patient about sleep hygiene. This also highlights the need for communication among therapists, which will be addressed in a later section.

Role definition also must address practical administrative issues, or else confusion and conflict may arise. Each therapist needs to know what the expectation of the other therapist is during the course of treatment. Coverage issues also need to be clarified. Who fills in for therapists' absences needs to be understood. In an adjunctive therapy it is often tempting for each therapist to cover for the other during vacations. This approach can blur roles, causing confusion and leading to conflict. If the psychopharmacotherapist covers for the individual therapist and an emotional crisis occurs, for example, he or she may need to temporarily take over the role of the therapist. Later, it may be difficult for

the psychopharmacotherapist to revert to his role, and it may prove confusing to the patient. Similarly, it must be clear whether the individual therapist is expected to monitor side effects and/or report them. This will directly affect the frequency of visits to both therapists. It is obvious that gross side effects will be reported, but obviously it is not the role of the individual therapist to perform screening tests examining for side effects. Depending on the nature of the individual therapy it may have more or less of an impact on the therapist's role.

C. Theoretical Clarity

Adjunctive therapy often involves the collaboration of therapists with different theoretical orientations. For the most part, these theoretical orientations are not inherently conflictual, although they may vary in emphasis. A behavioral therapy that focuses on changing observable patterns of behavior or reported cognitive patterns does not conflict with a dynamically oriented couples therapy that views behavior as arising out of early family patterns and roles. If, simultaneously, a psychopharmacotherapist approaches the behavior as a manifestation of an underlying biological diathesis and prescribes medication, the approaches are not contradictory but do have enormous potential for confusion and conflict. It is imperative that each therapist involved in adjunctive therapy understand not only his or her own theoretical orientation but also the orientation of all other therapists involved in the treatment. No therapist can be hidebound by his or her approach and must be respectful and open to other points of view.

The potential to regard one's own approach as superior and the other therapies as merely supportive must be guarded against, for it inevitably sabotages the treatment. For example, if an individual therapist believes that medication may relieve symptoms and reduce the patient's need and motivation for individual therapy, he or she might discourage the patient from taking medication or convey to the patient that using medication is a crutch and interferes with the "real" treatment.

At times, differences in theoretical perspectives may lead to different treatment interventions for the identical clinical situation. While understanding each therapist's treatment boundaries may reduce the potential for misunderstanding, appreciating each theoretical perspective can prevent therapist conflicts. For example, an individual therapist with a dialectical behavioral therapy (DBT) orientation and a physician prescribing

medication following a medical model may approach a patient threatening suicide very differently. The DBT therapist may already have had an agreement with the patient that the patient go to an emergency room and only contact the therapist when all danger had passed. The psychopharmacotherapist may feel the need to take an active role in the patient's hospitalization and continue to treat the patient in a hospital setting. Only with an appreciation of the DBT therapist's orientation and of what he or she is attempting to achieve with the patient can the psychopharmacotherapist intervene, support the DBT therapist's position, and encourage the patient to return to the therapist when the danger of suicide has passed.

Before entering into an adjunctive therapy, each therapist should learn the theoretical orientation of the other therapist, understand areas of potential conflict, and be certain that they can all work compatibly together without feeling devalued or devaluing. If this is not possible, it is best to avoid adjunctive therapy collaboration.

D. Boundaries

Each therapist in an adjunctive therapy has his or her own boundaries that define the treatment parameters within which the therapist operates. This includes a definition of the therapist-patient relationship and an understanding of what the patient should expect from the therapist and what the therapist should expect from the patient. These expectations include fees, payment schedules, cancellation policies, frequency of sessions, availability out of session, length of treatment, treatment of emergencies, issues of confidentiality, and many therapy-specific requirements. How each therapist delineates the boundaries of therapy affects all the therapists involved in an adjunctive therapy. For example, the individual therapist and the psychopharmacotherapist must know that their patients will be thrown out of the substance abuse group they are attending if they test positive twice for drugs or if they fail to produce urine for testing twice. Without this knowledge of the group therapist's boundaries, they could not plan their treatment effectively. With knowledge of each other's boundaries, they can plan in advance for this situation and agree that such an event would lead to transfer to a rehabilitation facility. An individual therapist may tell the patient that he or she is unavailable for calls on weekends. The psychopharmacotherapist needs to know this limit and be prepared to respond if the patient chooses to call him instead.

One important aspect of therapist boundaries that overlaps with a following item, communication, is content boundaries. It must be clear to all the therapists involved in an adjunctive therapy and to the patient what information will and will not be shared among all therapists. Without this clarity, the patient will be anxious about confidentiality, and the therapists will be uncertain about what information they can share. Therapists need to be clear with each other about what information they need in order to practice comfortably. Without this knowledge, a treater may agree with a patient's request not to share information that other treaters feel they need to know in order to effectively treat the patient. Clearly, effective treatment planning cannot occur without each therapist involved in an adjunctive therapy understanding the boundaries of all the therapists and without a consideration of potential conflicts related to these boundaries.

E. Goals

The goals or expected outcome for adjunctive treatment need to be explicitly defined for both the patient and the therapists. Inherent in adjunctive therapy is a variation in goals and expected outcome for the different treatments involved. Not only will there be variation in goals for each therapy but the duration of treatment may vary widely in both length and in predictability of length. Group therapies may be rigid in length, particularly when the focus is psychoeducational, or more open-ended, with goals set differently for each individual patient. Psychopharmacotherapy may have a clear goal of symptom relief but can also involve more open-end goals—for example, prophylactic treatment or maintenance treatment with a need for indefinite followup. In addition, the goals of therapies are often fluid and change over the course of a treatment. Illness can evolve over time, requiring a change in goals. For example, a patient in treatment for alcoholism may after a period of abstinence—clearly a successful goal of treatment for substance abuse—manifest symptoms of an underlying mood disorder, requiring a different therapy and a change in treatment goals. Consequently, the goals of therapy need to be clearly understood, and communication among therapists is necessary to help them avoid conflict in goals, agree when goals are met, and change goals depending on the condition of the patient.

Outcomes can affect the other parameters of adjunctive therapy as well. A common occurrence is the successful termination of one therapy because the goals

have been met. Any of the individual therapies that comprise an adjunctive treatment may meet its goals first. This results in a termination of the therapy and a change in other parameters of the treatment. Termination of one component of the therapy, whether it is due to a successful outcome or a poor outcome, always necessitates a review of the other parameters. This is best carried out if the final parameter, communication, is working well.

F. Communication

The sine qua non for effective adjunctive therapy is communication. The therapists must agree on what to communicate, when to communicate, and how to communicate. In an adjunctive therapy, the patient has a therapist–patient relationship with each of the treaters and must give permission for communication. The therapists must agree on what can and cannot be communicated and convey this agreement to the patient. Without this clarity, one or more therapists may be working with a handicap. For example, a patient conveys to an individual therapist that she had several hospitalizations for psychosis as a young adult. The patient may express concern that the psychopharmacotherapist not be told because she is afraid the psychopharmacotherapist will hospitalize her. This historical information is crucial to making a correct diagnosis and in choosing the right medication. Without this information the psychopharmacotherapist is handicapped in his or her decision-making process. Consequently, in most adjunctive therapies the patient is told that no therapist will keep confidential information that is deemed crucial for the decision making of the other therapists. Without such a stipulation, the lack of communication can provide an avenue for acting out and resistance.

The therapists must also agree on how often to communicate and how to communicate. How often is usually driven by the frequency of the therapies, the time of expected change, and the clinical status of the patient. How to communicate depends on the situation and means available to the therapists. If the adjunctive therapy has all the therapists working in the same setting sharing a common chart, written communication may suffice. More commonly, therapists are working in disparate settings and unaffiliated programs, so communication occurs by a regularly scheduled integrated treatment meeting initiated by the principal therapist. Because such meetings can be resource intensive, they are often scheduled infrequently. Communication occurs

between meetings by phone conferences, faxing office notes, or more recently by e-mail.

The areas defining adjunctive therapy, treatment hierarchy, role definition, theoretical clarity, and boundaries are often fluid, with large areas of overlap. They are commonly in flux throughout the course of a treatment and require active communication as a glue to hold the treatment together and focused on common goals.

II. THEORETICAL BASIS

The reasons that individuals seek psychological help involve many domains—social, psychological, and biological, reflecting the complexity of human experience. With the growth of empirical evidence over the last half century, a consensus has built that confining a theory of mental illness to a single domain (often the biologic) is reductionistic and ultimately limiting to understanding the illness and likewise its treatment. When mental illness occurs, it affects all three domains of human activity to varying degrees. Consequently, treatment interventions are often made across these domains using a variety of therapies.

Starting with DSM-III, American psychiatry made a paradigmatic shift defining illness as occurring across biopsychosocial domains defined by multiaxial diagnoses. It is noteworthy that the model for this diagnostic structure was adapted from the New York Heart Association criteria for classifying heart disease. Explicit in this diagnostic approach is an acknowledgment that illnesses span these domains and that treatment interventions need to be planned across all three domains.

Although research has shown a variety of treatments, including individual treatments (e.g., cognitive behavioral therapy, interpersonal therapy, and dialectical behavior therapy); group therapies, and psychopharmacotherapy, to be effective treatment for psychiatric illness, no single treatment addresses dysfunction in all three domains of human experience. This fact is not confined to psychiatric illness but rather mimics what has been known about other disorders as well—that illness, regardless of its nature, involves biopsychosocial functioning to varying degrees. This has been well-illustrated in oncology by David Spiegel who in 1989 showed that women receiving chemotherapy for breast cancer had better survival rates if they received a time-limited structured group psychotherapy than women treated with chemotherapy alone.

The outcome of this research for psychological treatment has been to reinforce the need of the therapist to at least assess all three domains of function and, when indicated, to plan treatment interventions across all domains. Because of the training, orientation, and experience of a variety of treaters, it has become increasingly common to need the involvement of more than one therapist in treating an individual. This leads directly to the demand for adjunctive therapy.

III. HISTORICAL OVERVIEW

The use of adjunctive therapy had its earliest formal use in the United States during the late nineteenth century with the development of moral therapy. Prior to that time, ill individuals were treated with primarily physical interventions ranging from herbal treatments, bloodletting, isolation, wet packs, rest cures, and, for severely ill, agitated patients, imprisonment and even physical torture. Moral therapy was primarily a social intervention in which individuals were treated on large farm-like hospitals and required to participate in the work of the farm. The basic tenet of moral therapy was that if individuals who are profoundly ill are treated with respect and dignity and are required to participate in normal social activities rather than be imprisoned and punished, they will once again acquire the social attributes of normal members of society. The large mental institutions in the United States constructed in the late nineteenth century were largely working farms. While this earliest example of sociotherapy was often effective and Charles Dickens described it in glowing terms during his visit to America, it was often not enough. Physical therapies such as isolation, restraints, and wet packs were also used frequently to control disruptive behavior. Consequently, combinations of both physiologic and social therapies were in wide use beginning in the last quarter of the nineteenth century.

The beginning of the twentieth century saw the growth of psychological treatment led by Freud and his followers. Psychoanalysis focused on the psychological domain of the individual and on how it attributed to both illness and health. The overriding emphasis was on psychoanalysis as a general theory that both explained and could treat all mental illnesses. Psychoanalysis as a monotherapy largely dominated treatment for the first half of the century. Although gravely ill individuals at times received adjunctive therapy, usually, physical treatments such as wet packs, electroconvulsive therapy, and limited pharmacotherapy, confined largely to sedatives,

these treatments were viewed as more enabling the patient to take part in psychoanalysis as an individual treatment rather than adjunctive therapy *per se*.

The growth of adjunctive therapies began after World War II in terms of widespread use, theoretical interest, and empirical studies. With psychoanalysis as the preeminent treatment, the emphasis was on intrapsychic phenomena and intensive individual treatment. The effect of the war was to burden the health care system, producing more traumatized individuals than could possibly be seen in intensive and lengthy psychotherapy. Group psychotherapy and, in particular, the empirical and theoretical work of Wilfred Bion grew directly out of the need to help many psychologically traumatized individuals with limited resources. Frequently, less intensive individual psychotherapy was used in conjunction with group psychotherapy, forcing early theorists to conceptualize how these treatments worked together in complementary ways and, equally importantly, how the therapists collaborated.

Even as psychoanalysis grew as the preeminent theory and, consequently, the treatment modality, it became obvious that psychoanalytic treatment alone was often insufficient to treat ill individuals, particularly those requiring hospitalization. As the emphasis of hospitals shifted from social treatment and biological therapy to psychoanalytic treatment of the individual, the use of adjunctive therapies and the theoretical understanding of the relationship of these many different treatments grew. Talcott Parsons, Marshall Edelson, Otto Kernberg, and others addressed the issues of sociotherapy—that is, the use of the milieu to effect change and complement individual treatment, the roles of various therapists in treatment, the effective domains of varying treatments and how they complement and compete with each other, the need for a mechanism of communication between treaters, and a hierarchy of treaters.

The last quarter of the twentieth century produced an emphasis on expanding the empirical database, elucidating what therapies work and for what conditions. Led by the work of Aaron Beck, Mardi Horowitz, Myrna Weisman, Marsha Linehan, and others, we have vastly increased our knowledge of what kind of psychotherapy works and under what conditions. Similarly, pharmacotherapy research has provided data about what medication is effective for what condition.

This increase in empirical information has highlighted the fact that no single treatment addresses the ill individual's entire treatment needs. A leading example has been the treatment of Major Depressive Disorder. Both Beck

and Weisman have demonstrated that certain types of individual psychotherapy—in this case cognitive-behavioral therapy and interpersonal therapy—are effective treatments for this disorder. Pharmacotherapy research has shown that a variety of medications are effective in the treatment of severe and recurrent depression. Strikingly, both psychotherapy and pharmacotherapy when used together to treat depression have better outcomes than either used as monotherapy. These types of empirical studies have led to the increasing use of adjunctive therapy in the current treatment of the mentally ill.

IV. SUMMARY

Adjunctive therapy is the use of two or more therapies to treat the same individual with mental illness. This combination may be an individual therapy and group therapy, or couples therapy and individual therapy. Currently, the most common form of adjunctive therapy is the use of individual therapy with psychopharmacotherapy. The growth of empirical data on a variety of adjunctive therapies over the last quarter of a century and the acceptance of a biopsychosocial model of mental illness as the leading theoretical paradigm have made adjunctive therapy increasingly the common form of modern treatment of mental illness. Depending on the illness, a variety of adjunctive therapies are currently in use. These adjunctive therapies may be individual treatment and group treatment, family treatment and individual treatment, and psychopharmacotherapy and a variety of other therapies. While the combinations of treatment involved in adjunctive therapy are too numerous to exhaustively catalog identical elements give it structure. These elements are treatment hierarchy, role definition, theoretical clarity, boundary definition goals, and communication.

See Also the Following Articles

Anxiety Disorders ■ Cognitive Behavior Group Therapy ■ Individual Psychotherapy ■ Integrative Approaches to Psychotherapy ■ Matching Patients to Alcoholism Treatment ■ Psychopharmacology: Combined Treatment ■ Substance Dependence: Psychotherapy

Further Reading

Applebaum, P. S. (1991). General guidelines for psychiatrists who prescribe medications for patients treated by

- non-medical psychotherapists. *Hospital and Community Psychiatry*, 42, 281–282.
- Ormont, L. R., & Strean, H. S. (1978). *The practice of conjoint therapy: Combining individual and group treatment*. New York: Human Sciences Press.
- Riba, M. B., & Balon, R. (Eds.). (1999). *Psychopharmacology and psychotherapy: A collaborative approach*. Washington, DC: American Psychiatric Press.
- Stricker, G., & Gold, J. R. (Eds.). (1992). *Comprehensive handbook of psychotherapy integration*. New York: Plenum Press.

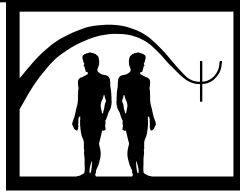

Adlerian Psychotherapy

Henry T. Stein and Martha E. Edwards

Alfred Adler Institute of San Francisco and Ackerman Institute for the Family

- I. Description of Treatment
 - II. Theoretical Bases
 - III. Applications and Exclusions
 - IV. Empirical Studies
 - V. Case Illustration
 - VI. Summary
- Further Reading

GLOSSARY

antithetical scheme of apperception The sharply divided way of interpreting people and situations with an “either/or,” “black and white” restriction of qualities; no “grey area” is acknowledged.

compensation A tendency to make up for underdevelopment of physical or mental functioning through interest and training, usually within a relatively normal range of development. Overcompensation reflects a more powerful impulse to gain an extra margin of development, frequently beyond the normal range. This may take a useful direction toward exceptional achievement or a useless direction toward excessive perfectionism. Genius may result from extraordinary overcompensation. Undercompensation reflects a less active, even passive attitude toward development that usually places excessive expectations and demands on other people.

eidetic imagery Vivid, detailed visualizations of significant figures in a person’s life used to yield projective impressions and stimulate emotional responses during the diagnostic phase of therapy. Later in therapy, these visualizations can be modified to promote therapeutic changes.

feeling of community (social interest) Translated from the German, *Gemeinschaftsgefühl*, as community feeling, so-

cial interest, social feeling, and social sense. The concept denotes a recognition and acceptance of the interconnectiveness of all people, experienced on affective, cognitive, and behavioral levels. At the affective level, it is experienced as a deep feeling of belonging to the human race and empathy with fellow men and women. At the cognitive level, it is experienced as a recognition of interdependence with others, that is, that the welfare of any one individual ultimately depends on the welfare of everyone. At the behavioral level, these thoughts and feelings can then be translated into actions aimed at self-development as well as cooperative and helpful movements directed toward others. Thus, at its heart, the concept of feeling of community encompasses individuals’ full development of their capacities, a process that is both personally fulfilling and results in people who have something worthwhile to contribute to one another.

feeling or sense of inferiority (primary and secondary) The primary feeling of inferiority is the original and normal feeling in the infant and child of smallness, weakness, and dependency. This usually acts as an incentive for development. However, a child may develop an exaggerated feeling of inferiority as a result of physiological difficulties (e.g., difficult temperament) or handicaps, inappropriate parenting (including abuse, neglect, pampering), or cultural or economic obstacles. The secondary inferiority feeling is the adult’s feeling of insufficiency that results from having adopted an unrealistically high or impossible compensatory goal, often one of perfection. The degree of distress is proportional to the subjective, felt distance from that goal. In addition to this distress, the residue of the original, primary feeling of inferiority may still haunt an adult. An inferiority complex is an extremely deep feeling

of inferiority that can lead to pessimistic resignation and an assumed inability to overcome difficulties.

fictional final goal An imagined, compensatory, self-ideal created to inspire permanent and total relief, in the future, from the primary inferiority feeling. Often referred to as simply the person's goal, it is usually unconscious until uncovered in psychotherapy.

missing developmental experience A belated therapeutic substitute for toxic, deficient, or mistaken early family, peer, or school experiences.

organ jargon An organ's eloquent expression of an individual's feelings, emotions, or attitude. Usually an ultrasensitive organ sends a symbolic message of the individual's distress about a subjectively unfavorable psychological situation.

private logic versus common sense Private logic is the reasoning invented by an individual to stimulate and justify a self-serving style of life. By contrast, common sense represents society's cumulative, consensual reasoning that recognizes the wisdom of mutual benefit.

psychological movement The thinking, feeling, and behavioral motions a person makes in response to a situation or task.

safeguarding tendencies Strategies used to avoid or excuse oneself from imagined failure. They can take the form of symptoms—such as anxiety, phobias, or depression—which can all be used as excuses for avoiding the tasks of life and transferring responsibility to others. They can also take the form of aggression or withdrawal. Aggressive safeguarding strategies include depreciation, accusations, or self-accusations and guilt, which are used as a means of elevating a fragile self-esteem and safeguarding an overblown, idealized image of oneself. Withdrawal takes various forms of physical, mental, and emotional distancing from seemingly threatening people and problems.

Socratic-therapeutic method An adaptation of the Socratic style of questioning specifically tailored to eliciting and clarifying information, unfolding insight, and promoting change in Classical Adlerian psychotherapy.

striving for significance The basic, common movement of every human being—from birth until death—of overcoming, expansion, growth, completion, and security. This may take a negative turn into a striving for superiority or power over other people. Unfortunately, many reference works mistakenly refer only to the negative “striving for power” as Adler's basic premise.

style of life A concept reflecting the organization of the personality, including the meaning individuals give to the world and to themselves, their fictional final goal, and the affective, cognitive, and behavioral strategies they employ to reach the goal. This style is also viewed in the context of the individual's approach to or avoidance of the three tasks of life: other people, work, love, and sex.

tendentious apprehension The subjective bending of experience in the direction of the fictional final goal.

unity of the personality The position that all of the cognitive, affective, and behavioral facets of the individual are viewed as components of an integrated whole, moving in one psy-

chological direction, without internal contradictions or conflicts.

I. DESCRIPTION OF TREATMENT

The primary indication of mental health in Adlerian psychotherapy is the person's feeling of community and connectedness with all of life. This sense of embeddedness provides the real key to the individual's genuine feeling of security and happiness. When adequately developed, it leads to a feeling of equality, an attitude of cooperative interdependency, and a desire to contribute. Thus, the central goal of psychotherapy is to strengthen this feeling of community.

The major hindrance to a feeling of equality and the development of the feeling of community is an exaggerated inferiority feeling for which the individual attempts to compensate by a fictional final goal of superiority over others. Thus, the therapeutic process is simultaneously focused on three aspects of change. One is the reduction of the painful, exaggerated inferiority feelings to a normal size that can be used to spur growth and development and a healthy striving for significance. A second is the dissolution of the patient's corrosive striving for superiority over others, embodied in a compensatory style of life. A third is the fostering of equality and feeling of community. Underlying this work is a firm belief in the creative power of the individual, to freely make choices and correct them, thus providing an encouraging perspective on responsibility and change.

Adlerian psychotherapy is a creative process in which the therapist invents a new therapy for each client. Six phases of the therapeutic process are as follows: (1) establishing the therapeutic relationship, (2) assessment, (3) encouragement and clarification, (4) interpretation, (5) redirection of the lifestyle, and (6) meta-therapy. These are briefly offered with the caveat that for any particular client, the actual therapeutic process may look quite different.

A. Phase I: Establishing the Therapeutic Relationship

Developing a cooperative working relationship is fundamental for any meaningful therapeutic progress. A warm, caring, empathic bond, established from the very beginning, opens the door for gradual, positive influence. Initially, the client may need to express a great deal of distress with little interruption. In response,

therapist offers genuine warmth, empathy, understanding, and empathy. An atmosphere of hope, reassurance, and encouragement enables the client to develop a feeling that things can be different.

The therapist also helps the client learn to participate in a cooperative relationship. The success of the therapy depends on how well the patient and therapist work together, each doing his or her part, which includes the client's thinking and action between visits.

The relationship with the therapist is a major avenue for significant change. The therapist provides belated parental influence to provide what was missing in the patient's early childhood or to ameliorate toxic early experiences. The therapist helps the patient experience a relationship based on respect, equality, and honesty—for some patients the first such relationship they have ever experienced. The therapist also provides a good model of cooperation and caring.

B. Phase II: Assessment

A thorough assessment is a critical step in Adlerian psychotherapy, for it will guide much of the therapeutic process. Although it is generally conducted during the first part of the treatment, information obtained throughout treatment may be used to refine and even correct initial impressions and interpretations. The objective of the assessment process is to conduct a comprehensive analysis of the patient's personality dynamics and the relationship among them—what Adler called the style of life. At a minimum, this analysis includes an identification of the patient's inferiority feelings, fictional goal, psychological movement, feeling of community, level and radius of activity, scheme of apperception, and attitude toward the three life tasks of occupation, love and sex, and other people.

A central assessment technique that Adler pioneered is the projective use of early memories. These memories—whether they are “true” or fictional—embody a person's core beliefs and feelings about self and the world and reflect the core personality dynamics. In addition to these early memories, the therapist uses the following: (1) a description of symptoms and difficulties, the circumstances under which they began, and the client's description of what he would do if not plagued with these symptoms; (2) current and past functioning in the domains of love relationships, family, friendships, school, and work; (3) family of origin constellation and dynamics, and extended family patterns, (4) health problems, medication, alcohol, and drug use, (5) previous therapy and attitude toward the therapist; (6) night

and day dreams, and (7) information about the larger contexts in which the patient is embedded (e.g., ethnic, religious, class, gender, or racial contexts). Although much of this information can be collected in the early therapy sessions, it can also be obtained in writing both to save time and to draw on information from a different mode. When appropriate, intelligence, career, and psychological testing are included.

The therapist uses both cognitive and intuitive processes to integrate this diagnostic information into a unique, vivid, and consistent portrait. This is key to treatment planning and will eventually and gradually be shared with the client. The therapist must always keep in mind, however, that these conclusions are somewhat tentative and are subject to refinement and revision. As the therapist gains more information, it must all fit in with this portrait in a consistent way; if not, the portrait may need revisions to accommodate this new information.

C. Phase III: Encouragement and Clarification

An ongoing central thread throughout the entire therapeutic process is encouragement. The therapist cannot give clients courage; this feeling must develop through the gradual conquest of felt difficulties. The therapist can begin this process by acknowledging the courage the client has already shown, for example, in coming to therapy. Then the therapist and client together can explore small steps that, with a little more courage, the client might take. For many clients, this is equivalent to doing the “felt impossible.” During and after these steps, new feelings about efforts and results are acknowledged and discussed.

In attempting to avoid failure, discouraged people often decrease their level and radius of activity. They can become quite passive, wait for others to act, and limit their radius of activity to what is safe or emotionally profitable. If this is true for a patient, the therapist and patient need to find ways to increase the patient's activity level—to increase initiative and persistence, completion of tasks, improvement of capacities, and enjoyment of progressively vigorous effort. If the activity radius is too narrow, a broadening of interests may provide stimulation, challenge, and more pleasure. In increasing activity level, however, a client may initially move in a problematic direction; for example, a timid person aggressively tells off his friend. But this is often a necessary first step that can be corrected after commencing the attempt.

During this still-early phase of therapy, Socratic questioning is used to clarify the client's core beliefs and feelings about self, others, and life. Here is a brief example of Socratic questioning in a therapy session with a depressed man who is stuck in his symptoms.

T: You may have a suggestion, you're kind of bright, you know.

C: What makes you think I'm bright?

T: By the way you talk, and the way you answer questions, and the way you do things in general. You're bright. You know how to avoid giving an answer, and how to aggravate people, and you know a lot of things. That's kind of bright. Dumb people don't do that.

C: You think that's a sign of brightness, to aggravate people?

T: Oh, sure! That's a way that you use it. I don't particularly think that people approve of the way you use it, but it is a sign of brightness. You could use the same brightness in a different way, you know?

C: That's true. A lot of people are very annoyed at me.

T: Uh huh. You like that?

C: Sometimes I don't mind. It bothers me when my parents get annoyed at me because then I can't go visit them. And they won't let me visit every week.

T: They won't let you visit every week. Now if I would be very annoying, would you like me to visit you every week?

C: (weakly) I don't think so.

C: No. Sounds as if your parents have a point.

The therapist builds on a strength of the client—his intelligence. Then she brings out the client's private logic, which could be expressed as, "I can annoy others with impunity." She then tests this private logic by extending it to others, asking whether this logic could also be applied to the therapist annoying the client. Using Socratic questioning to challenge the client's private logic helps him to move closer to common sense.

As the client and therapist talk during these early sessions, the therapist focuses on the psychological movement within the client's expressions and imagines the goal toward which the movements lead. For example, while the client may talk about a conflict with his wife, two possible movements he could actually be describing are away from his wife (withdrawal) or against his wife (aggression). By doing this, the therapist begins to identify the client's immediate and long-range hidden goals. He may be trying to protect himself from psychological harm, or he may wish to punish her for real or imagined hurts. Frequently, the immediate so-

cial result is the best clue to discovering a goal. Translating actions, thoughts, and feelings into movement and interpreting them in clear, simple, nontechnical language provides a useful mirror for the client. Buzzwords, jargon, and typologies do not help as much, frequently obscuring the uniqueness of the client's experience. The therapist uses everyday terminology and even tries to form insight in terms of images that are familiar to the client.

In the therapeutic dialogue, the therapist will also dialectically question the client's *antithetical scheme of apperception*. The client is likely to resist this process because the scheme of apperception provides certainty and supports the pursuit of the childlike, egocentric, final goal. The client's scheme of apperception depends on cognitive rigidity to generate very strong feelings. It locks the client into a dichotomized, superior/inferior way of seeing the world, evaluating experiences, and relating to others. Thus, to loosen and dissolve the antithetical scheme of apperception, the therapist must help the client see the real and subtly distinguishing qualities of people and experiences rather than dividing impressions into "either or," rigidly absolute categories.

All behavior is purposive and is aimed at moving toward the final goal. Client's emotions and symptoms will all serve the goal. The purpose may be hidden, and the client may not want to acknowledge responsibility for his intention. Both emotions and symptoms can be used to avoid responsibility for actions or as excuses for not doing what the client really does not want to do. For example, fear, confusion, and anger can all be used as excuses for not developing better relationships with others. The client needs to understand how he uses or abuses emotion. Does he create feelings that help him do the right thing? Does he use strong emotion as an excuse for indulgent and irresponsible action? What emotions does he avoid? Does one client, for example, aggressively ward off tender emotions, while another avoids anger with his "nice guy" approach? What is the impact of the client's emotions on other people? Does he want this result? Emotions are not the cause of behavior: rather, they serve one's intentions.

One of Adler's favorite diagnostic questions was, "If you did not have these symptoms, what would you do?" The answer frequently revealed what responsibility or challenge the person was trying to avoid. Symptoms, like crutches, will be discarded when they are no longer needed. Trying to treat the symptom is like blowing away smoke without extinguishing the fire that causes it.

D. Phase IV: Interpretation

After the client has made some movements toward change and she and the therapist have examined the meaning of her movements and immediate goals, they eventually engage in an interpretation of the client's style of life. Discussing and recognizing these core personality dynamics, such as the inferiority feeling or the goal, can be both painful and even embarrassing. The interpretation process requires diplomacy, exquisite timing, and sensitivity. Doing this interpretation too soon is discouraging. The style of life is interpreted gradually, as the client gains success and strength in a new direction, discovers capacities that she has neglected, and begins to correct what she has omitted in her development. Once she has moved sufficiently in a new direction, the results of her new and old attitudes are then compared.

This insight enables the client to take greater initiative in interpreting situations more on her own, sharing her own ideas with the therapist. Many clients are tempted to terminate at this point, feeling that they know enough, even though they have not actually applied their insight and changed their main direction in life. However, profound change occurs after the client and therapist have together identified and discussed the client's style of life. Insight and newly found courage are mobilized to approach old difficulties and neglected responsibilities. On the basis of this insight, then, the client can work toward lifestyle redirection, that is, changing the main direction of movement and approaching the three central tasks of life (community, work, and love).

E. Phase V: Style of Life Redirection

This phase represents the depth work that is done for the client to redirect the lifestyle. This requires reducing and using inferiority feelings, redirecting the superiority striving, changing the fictional final goal, and increasing the feeling of community.

Clients may have exaggerated inferiority feelings that they want to eliminate totally, believing that if they realize their goal, these painful feelings will disappear. A client may use his feeling of inferiority to build a wall in front of him, thereby excusing himself from difficult effort and from risk to his fictional ideal. His depreciation of others, fictional superiority posturings, alcohol, or drugs may temporarily give him some relief from his semi-hidden and dreaded feeling of deficiency. The therapeutic aim is to help the client put an

inferiority feeling behind him so that it pushes him ahead. That's the purpose of the normally sized inferiority feelings—to motivate development. If, however, the client's feeling of inferiority is quite exaggerated and seems to immobilize him or thrust him into wildly ambitious plans that are destined for failure, the therapist helps him change his thinking about his assumed great deficiency.

When the client's inferiority feelings are exaggerated, the superiority striving gets corrupted into striving for superiority over others rather than for development and growth. Thus, another therapeutic process involves redirecting this striving into a more positive direction—the conquest of real personal and social difficulties that benefit others rather than the superiority and power over other people.

A thread that runs through the therapy and that underlies efforts to reduce inferiority feelings is the way the therapist promotes the feeling of equality. The therapist's offer of equality may be a new experience that the client can gradually transfer to other people.

As the client begins to feel more able and less inferior, she may be able to begin changing her fictional final goal. The compensatory, fictional final goal, originally formed to relieve the primary feeling of inferiority, can gradually be modified to a more cooperative form, or dissolved and replaced by a different form of motivation. Abraham Maslow described this higher level of functioning as "growth motivation," in contrast to the lower level of "deficiency motivation." A client makes the choice to abandon his former direction and pursue the new one because it yields a more positive feeling of self and greater appreciation from others. As the goal changes, the rest of the style of life also changes as old feelings, beliefs, and behaviors are no longer required in the new system.

Parallel to the process of reducing inferiority feelings and changing the goal is the process of increasing the feeling of community. Initially, through his contact with the therapist and later through his application of social interest with other people, the client learns the meaning and value of contact, connectedness, belonging, and empathy. *Gemeinschaftsgefühl*, the original German term for community feeling, expresses a very profound philosophical perspective on life—a very deep feeling for the whole of humankind, an attitude of vigorous cooperation and social improvement, and a sense of the interconnectedness of all of life and nature.

Perhaps skeptical of the therapist's good-will at first, the client has felt and appreciated the genuine caring and encouragement. The conquering of obstacles has

generated courage, pride, and a better feeling of self that now lead to a greater cooperation and feeling of community with the therapist. This feeling can, and should, now be extended to connect more with other people, cooperate with them, and contribute significantly to their welfare. As the client's new feeling of community develops, she will become motivated to give her very best to her relationships and to her work.

Throughout the therapeutic process—both before and after the formal interpretation process—the therapist and client have been working on correcting the client's private logic and dissolving the antithetical scheme of apperception. In addition to these processes, it may be helpful to engage in therapeutic strategies that change the negative imprints from the past.

If the client's early childhood experience was very negative or deficient, it may be helpful to help the client counteract the haunting memories of abuse or neglect with creative, nurturing images. Some people respond to a vivid description and discussion of how they could have been parented. It gives them a picture of what might have happened, how it could have felt, and the outcomes that could have resulted. It may also serve as a model for what the client could do in his or her own parenting.

Other clients prefer the use of guided imagery to change the negative imprints of significant others that weigh heavily on them and often ignite chronic feelings of guilt, fear, and resentment. Still others prefer role-playing both to add missing experiences to their repertoire and to explore and practice new behavior in the safety of the therapist's office.

To provide missing experiences—for example, support and encouragement of a parent—a group setting is recommended. Group members, rather than the therapist, can play the roles of substitute parents or siblings. In this way, a client can engage in healing experiences, and those who participate with him can increase their own feeling of community by contributing to the growth of their peers.

The client and therapist can engage in role-playing for learning and practicing new behaviors. The therapist can model possible behaviors as well as coaching, encouraging, and giving realistic feedback about probable social consequences of what the client plans to do. This is somewhat equivalent to the function of children's play as they experiment with roles and situations in preparation for growing up.

A final issue of therapeutic change in the Classical Adlerian model is the person of the therapist. Clients constantly observe their therapists and may use them as

positive or negative models. How the therapist behaves is critical, for it may interfere with the therapy process if a client sees that his therapist does not embody what she is trying to teach him. Thus, providing an honest example of cooperation and caring is fundamental. It is not enough for a therapist to understand and talk about Adler's ideas; they must also be lived. If a client sees any contradiction between the therapist's words, feelings, and actions, he has good reason to be skeptical.

F. Phase VI: Meta-Therapy

A few clients may reach the quest for full personal development. The challenge is to stimulate each client to become her best self in the service of others, to awaken her inner voice, and to fully use her creative powers. Müller described the last phase of therapy as a "philosophical discourse." For those clients who need and desire this experience, Classical Adlerian psychotherapy offers the psychological tools and philosophical depth to realize their quest.

Maslow labeled this latter aspect of therapy "meta-therapy." He suggested that the fullest development of human potential might require a more philosophical process, one that went beyond the relief of suffering and the correction of mistaken ideas and ways of living. As clients improve, the therapist can help them see that they can use new, more liberating and inspiring guides for their lives. These alternative guides are what Maslow called meta-motivation or higher values—for example, truth, beauty, justice. The values that individual clients choose will depend on their unique sensitivities and interests.

II. THEORETICAL BASES

Classical Adlerian psychotherapy is both similar to and distinctively unique to some contemporary schools of psychology and psychotherapy. In its focus on the importance of the relationship between the client and early childhood significant others, between the client and therapist, and between the client and significant others in his life, it is similar to self psychology and object relations psychotherapies. In its recognition of the embeddedness of the individual within a social context, it is similar to social psychology and family systems therapy. In its focus on the subjective meaning the client makes of the world and his relationship to it, it is similar to constructivist theories and cognitive-behavioral psychotherapy.

But several conceptual aspects of Classical Adlerian psychotherapy set it apart from all others. First and foremost is the conception of the creative power of the individual that is directed toward a goal, a fictional future reference point that pulls all movements in the same direction. An Adlerian psychotherapist never asks the question, “What makes the client do that?” The question is always, “What is the client trying to achieve by doing that?” Underlying this teleological approach is a belief in active, free will to creatively move toward a goal of one’s own choosing. But once having adopted a fictional final goal, the goal functions unconsciously, out of full awareness. (This concept of fictional final goal is similar to that of a strange attractor in chaos theory, a magnetic end point that pulls on and sets limits for a process.)

This goal also organizes the psychological movements of the person so that there is a unity of the personality. One part of the personality never wars with another; all cooperate together in the service of the goal. What may look like conflict—for example, a client is ambivalent about whether to remain monogamous in his marriage or to have an affair—is really in service of a final goal—to avoid giving himself completely to one woman. Emotions are also the servants of this goal—for example, fear used to avoid, anger used to dominate, punish, or create distance. Dreams reflect this goal, as do daydreams, early recollections, and everyday behaviors. (This concept of unity, in which one central theme is reflected in every psychological expression, is similar to the concept in physics of the hologram, wherein each part of a whole is an enfolded image of that whole.)

Another central aspect of Classical Adlerian psychotherapy is the values on which it is based. Adler used to say that if humans didn’t learn to cooperate, they would annihilate the world. Thus, therapy encompasses much more than simple relief from symptoms. The goal of therapy is to increase the client’s feeling of community so that she can better cooperate with others and make a contribution to the whole of life. Over the course of his theoretical development, Adler moved from viewing humans as simply attempting to compensate for inferiority feelings (what Maslow called “deficiency motivation”) to a focus on growth and development (what Maslow called “growth motivation”). Thus, in Classical Adlerian psychotherapy, the aim is to move towards optimal psychological, philosophical, and even spiritual health for the benefit of both self and others.

Unlike traditional psychoanalysis, Classical Adlerian psychotherapy does not utilize transference or countertransference as cornerstones of treatment. Transfer-

ence, from an Adlerian perspective, is the tendency of the client to transfer inappropriate positive or negative feelings, originally experienced toward a parent, sibling, or other significant figure from childhood, toward the therapist. Adler considered the client’s transference a device to justify and protect the pursuit of the hidden, fictional final goal. Consequently, the therapist diplomatically unveils the transfer of perception and feeling as a long-standing habit that needs to be corrected. In this perspective, transference is a resistance to the cooperation that is necessary between client and therapist. The client usually tries to draw the therapist into a familiar relationship where she can imagine an eventual secret victory.

Countertransference, the therapist’s reactions to the client, are used by the Adlerian therapist as clues to the effect that the client has on others in her life. If, however, the therapist finds that the client triggers his own unfinished personal issues, this should prompt the therapist to deal with these in his study analysis with a senior training analyst.

III. APPLICATIONS AND EXCLUSIONS

The strategies of Classical Adlerian psychotherapy are similar in individual, couple, family, and child psychotherapy. The central dynamic is the encouragement of each individual to develop his or her capacities so as to reduce the inferiority feeling, to feel more equal with others, to become more cooperative, and to contribute to the improvement of all relationships for mutual benefit. In order to accomplish this, the style of life of each person usually needs to be redirected. Abbreviated adaptations of Classical Adlerian psychology have also been developed for use in brief therapy, career assessment and guidance, organizational consulting, and child guidance for parents and teachers.

IV. EMPIRICAL STUDIES

As of yet, there have been no empirical studies of Classical Adlerian psychotherapy.

V. CASE ILLUSTRATION

Arthur, a lonely, angry man in his mid-40s, was referred to therapy after completing an outpatient alco-

hol treatment program. He was very frustrated with his career as a criminal investigator, experienced very little intimacy with his wife, and had no friends. Although he conducted extremely thorough investigations that resulted in convictions, sentences rarely included jail time. His cold and isolated childhood left him very bitter: his memories were of an unhappy mother; a remote father; and a hell-raising older brother whom he hated, but who was the center of the parents' attention and frequently got away with illegal behavior. By contrast, he was a compliant youngest child who didn't make any trouble and was ignored. His sister, the oldest sibling, acted as a substitute caretaker for the distracted and critical mother.

The felt neglect of his father and the lack of love from his mother were at the roots of his inferiority feelings—a painful sense of being unloved and ignored. Discouraged and pessimistic about gaining affection and attention, he directed his compensatory lifestyle toward catching as many “bad guys” as he could and seeing that they were locked up. Since most were not, in his estimation, adequately punished, he was perpetually frustrated. He also viewed his parents and brother as unpunished criminals. His unconscious goal was to secure compensation and revenge for his miserable childhood. Revenge was not working out to his satisfaction, but at least he could look forward to a comfortable retirement, a symbol of what he felt entitled to.

Initially, his attitude toward the therapist was guarded and minimally expressive. What made him competent in surveillance work, observing others without being seen, was a handicap in making a personal relationship. However, two strengths could be built on. First, he had conquered both alcohol and nicotine dependencies. Second, his intense curiosity about hidden information and details provided a stimulus for examining his own style of life thoroughly through a discussion of the vivid clues embedded in his earliest childhood recollections. His most revealing recollection featured his brother spoiling a family fishing trip by making trouble and then getting away with it. His antithetical scheme of apperception sharply divided the good guys who obeyed the laws and the bad guys who broke the laws.

His private logic dictated that those who followed the rules were entitled to generous rewards and that the criminals deserved harsh punishment and confinement. Through his work, he dreamed of the ultimate compensation denied him as a child: punishing lots of bad people. Gradually, he realized how much his crusade had driven his life and what he had been missing,

as a child and as an adult—warm, friendly contact with other people. He appreciated the therapist's understanding of his early family situation and empathy for his lonely childhood suffering. Socratically, he became aware of his narrow focus of interest on the people who made trouble and his exclusion of those who offered affection and caring.

Eventually, he softened enough to respond to healing, eidetic images of warmer, caring “substitute” parents. These images elicited his first experience of crying in therapy. After opening up emotionally and experiencing a gradual series of missing developmental experiences through guided and eidetic imagery, he overcame a socially corrosive depreciation tendency toward wrongdoers, and was willing to redirect his striving for significance into an interest in promoting understanding and fairness, instead of administering punitive justice. He concluded treatment with a more comfortable, closer relationship with his wife, and an optimistic perspective on making new friends.

VI. SUMMARY

In its most basic of descriptions, Adler conceived of the goal of therapy to help clients connect themselves with fellow men and women on an equal and cooperative footing. Therapist and client simultaneously focus on three therapeutic processes: (1) reducing painful, exaggerated inferiority feelings to a normal size that can be used to spur growth and development and a healthy striving for significance; (2) redirecting the lifestyle away from a useless and corrosive striving for superiority over others and fictional final goal and toward a more useful and cooperative direction; and (3) fostering equality and a feeling of community. Thus, not only does therapy benefit the individual, but it also contributes to the improvement of life for other people.

See Also the Following Articles

Countertransference ■ Dreams ■ History of Psychotherapy ■ Interpersonal Psychotherapy ■ Jungian Psychotherapy ■ Objective Assessment ■ Sullivan's Interpersonal Psychotherapy ■ Transference

Further Reading

Ansbacher, H. L., & Ansbacher, R. (Eds.). (1956). *The individual psychology of Alfred Adler*. New York: Basic Books.

- Davidson, A. K. (Ed.). (1991). *The collected works of Lydia Sicher: An Adlerian perspective*. Fort Bragg, CA: QED Press.
- Ellenberger, H. (1970). *The discovery of the unconscious: The history and evolution of dynamic psychiatry*. New York: Basic Books.
- Hoffman, E. (1994). *The drive for self*. New York: Addison-Wesley.
- Maslow, A. (1971). *The farther reaches of human nature*. New York: Penguin Books.
- Müller, A. (1992). *You shall be a blessing*. Alfred Adler Institute of San Francisco, San Francisco.
- Stein, H. (1988). Twelve stages of creative Adlerian psychotherapy. *Individual Psychology*, 44, 138–143.
- Stein, H. (1990). *Classical Adlerian psychotherapy: A Socratic approach*. Audiotape study program. Alfred Adler Institute of San Francisco, San Francisco.
- Stein, H. (1991). Adler and Socrates: Similarities and differences. *Individual Psychology*, 47, 241–246.
- Stein, H., & Edwards, M. (1998). Classical Adlerian theory and practice. In P. Marcus & A. Rosenberg (Eds.), *Psychoanalytic versions of the human condition: Philosophies of life and their impact on practice*. New York: New York University Press.

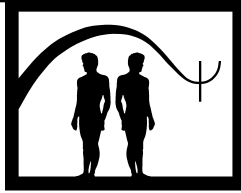

Alternatives to Psychotherapy

Janet L. Cummings

The Nicholas & Dorothy Cummings Foundation

- I. Technical Alternatives to Psychotherapy
- II. Pharmacologic (Herbal) Alternatives to Psychotherapy
- III. Summary
Further Reading

GLOSSARY

5-hydroxytryptophan (See five-hydroxytryptophan).

agonist A drug that works by stimulating its receptor (as opposed to an antagonist, which works by blocking receptors).

anesthetics Drugs used for general anesthesia.

Aristolochia fangchi Also called *guang fang ji*, an herb marketed over-the-counter for weight loss in products labeled “Chinese herbs.”

aristolochic acid A chemical found in the Chinese herb *Aristolochia fangchi*, which is sold over-the-counter in various weight-loss products.

autonomic nervous system The branch of the nervous system that regulates internal body processes requiring no conscious awareness.

barbiturates A class of drugs (including pentobarbital and phenobarbital) used to induce sleep, relieve anxiety, treat certain types of seizures, or for general anesthesia.

benzodiazepines A class of drugs (including Valium, Librium, and Xanax) that decrease anxiety and induce sleep by facilitating GABA neurotransmission.

carbidopa A prescription drug used to treat Parkinson’s disease, available in pill form.

carcinogenicity Cancer-promoting properties.

cyclosporine Prescription immunosuppressant medication used to prevent organ rejection in transplant recipients, available in pills, oral solution, or IV injection.

digoxin A prescription cardiac medication that strengthens and regulates the heartbeat, available as pills, IM injection, or IV injection.

dopamine A neurotransmitter involved in motor control, increased levels of which are associated with psychosis.

EMDR (See eye movement desensitization and reprocessing).

ephedra Also known as *ma huang*; an herbal compound with amphetamine-like qualities sold over-the-counter in a number of weight-loss and energy-boosting products.

eye movement desensitization and reprocessing (EMDR) An alternative to psychotherapy that utilizes eye movements or other left-right stimulation to treat psychological problems.

five-hydroxytryptophan (5-hydroxytryptophan) Also called 5-HTP, an herbal supplement marketed for the treatment of depression, which is metabolized into serotonin in the body and may enhance serotonin neurotransmission.

fluoxetine (Prozac) A selective serotonin reuptake inhibitor.

formulary A list of drugs that are included as covered benefits by a particular insurance company, as opposed to non-formulary drugs that must be purchased out-of-pocket or with a higher co-payment.

GABA (See gamma-aminobutyric acid).

gamma-aminobutyric acid The major inhibitory neurotransmitter of the central nervous system.

Griffonia simplicifolia An African plant, the seeds of which are used to derive 5-hydroxytryptophan.

guang fang ji (See *Aristolochia fangchi*).

heliotrophe (See *Valeriana radix*).

hematocrit A measure of the proportion of red blood cells to the total blood volume.

hemoglobin The oxygen-carrying component of red blood cells.

homocysteine A substance in the blood, high levels of which are associated with increased risk of heart disease.

Hypericum perforatum Also called St. John's wort; an herbal compound marketed over-the-counter for the treatment of depression, which likely affects the serotonin system.

immunosuppressant A drug used to prevent transplant rejection or to treat autoimmune disorders or severe allergies, which suppresses the functioning of the immune system.

inhibitory neurotransmitter A neurotransmitter, the presence of which decreases the probability of neuronal firing (as opposed to an excitatory neurotransmitter, the presence of which increases the probability of neuronal firing).

kava (See Piper methysticum).

kava kava (See Piper methysticum).

kavalactones Fatlike compounds with sedative qualities found in Piper methysticum (kava).

LeShan An alternative therapy used to heal medical and psychological problems when the treatment provider and patient are a distance apart.

ma huang (See ephedra).

MAO inhibitors (See monoamine oxidase inhibitors).

MAOIs (See monoamine oxidase inhibitors).

monoamine oxidase inhibitors (MAO inhibitors; MAOIs) A class of antidepressants (including Nardil, Marplan, Parnate, and Deprenyl) that work by blocking the enzyme that breaks down serotonin and norepinephrine.

noradrenaline (See norepinephrine).

norepinephrine Also called noradrenaline; a neurotransmitter that interacts with epinephrine to affect autonomic activity and mood.

perturbations Hypothesized structures throughout the body believed by proponents of thought field therapy to contain the energy that creates psychological disturbances.

Piper methysticum Also called kava or kava kava; an herbal compound marketed over-the-counter for the treatment of anxiety and insomnia.

platelets Cell-like particles in the blood, smaller than red or white blood cells, which clump together and promote clotting.

psychotropic medications Medications used to treat mental and emotional problems, including antidepressants, antipsychotics, and tranquilizers.

Reiki (Pronounced "ray-key") an ancient Buddhist practice of manual healing therapy, used to treat both medical conditions and psychological problems.

REM (rapid eye movement) sleep A stage of sleep characterized by rapid eye movements, behavioral activity, high electrical activity in the brain, increased rate and depth of breathing, and dreaming.

S-adenosylmethionine (SAMe) An herbal compound marketed over-the-counter for the treatment of depression and some medical conditions, including osteoarthritis and liver disease; may affect brain levels of serotonin, noradrenaline, and dopamine.

SAMe (See S-adenosylmethionine).

scleroderma A chronic disease characterized by blood vessel abnormalities, as well as degenerative changes and scarring of the skin, joints, and internal organs.

selective serotonin reuptake inhibitors (SSRIs) A class of antidepressants (including Prozac, Zoloft, and Paxil) that work by blocking the reuptake of the neurotransmitter serotonin.

serotonin A neurotransmitter, decreased levels of which are associated with depression.

serotonin syndrome A syndrome caused by high levels of serotonin and associated with agitation, restlessness, insomnia, tremor, nausea, vomiting, rapid heart rate, and seizures.

sertraline (Zoloft) A selective serotonin reuptake inhibitor.

SSRIs (See selective serotonin reuptake inhibitors).

St. John's wort (See Hypericum perforatum).

thought field therapy An alternative to psychotherapy in which the practitioner helps the client tap a series of points on the body in order to alter thoughts.

transductive points Specific places on the body that the client taps as part of thought field therapy.

tricyclic antidepressants A class of antidepressant drugs, including Elavil, Anafranil, Tofranil, and Pamelor, which work by blocking norepinephrine reuptake, with some blocking of serotonin reuptake.

tryptophan An amino acid from which serotonin and melatonin are manufactured in the body, which was sold as an over-the-counter sleep aide until an impurity in one bad batch caused severe medical problems and death in a number of users.

valerian (See Valeriana radix).

Valeriana officinalis (See Valeriana radix).

Valeriana radix Also called valerian, Valeriana officinalis, or heliotrophe; an herb with mild tranquilizing effects, sold over-the-counter to treat insomnia and mild anxiety.

warfarin (Coumadin) A prescription anticoagulant (blood thinner) medication, available in pills or IV injection.

Because of advances in modern medicine during the 20th century, homeopathic and naturopathic medicine had all but vanished in the United States. However, the past few decades have seen a revival of alternative medical treatments, with Americans making an estimated half-billion visits to alternative practitioners annually. Unfortunately, most alternative treatments, although promising, remain unvalidated by well-controlled scientific study at this time.

Many American consumers are now seeking alternative therapies for their psychological problems as well as for their medical problems. Alternative therapies for psychological problems include nutritional programs for the management of mental disorders, various techniques of bodywork and body alignment for clearer

thinking and peace of mind, aromatherapy, various types of touch therapy for emotional healing, magnet therapy, moving meditations such as tai chi and yoga, music therapy, and various forms of prayer. Such a vast array of alternatives to psychotherapy exists that it would be impossible to cover them all in detail in this article. Therefore, this article will focus on two types of alternative psychological treatments: technical and pharmacologic (herbal). Examples of each will be offered.

I. TECHNICAL ALTERNATIVES TO PSYCHOTHERAPY

A. Reiki

Reiki (pronounced “ray-key”) is an ancient Buddhist practice of manual healing therapy that was rediscovered in Japan by Mikao Usui in the mid 1800s. It has become increasingly popular in the United States during the past few decades and is used for treating heart attacks, emphysema, hemorrhoids, prostate problems, varicose veins, hiccups, nosebleeds, and various mental and emotional problems. It is based on the belief that life is dependent on a universal, nonphysical energy. Because health requires a sustained and balanced flow of this energy throughout the body, disturbances in that flow result in physical, emotional, and mental illnesses. The Reiki practitioner attempts to correct life energy imbalances and blockages by gently resting his or her hands in specific ways on 12 standard sites throughout the body. The practitioner generally begins with the head and spends a few minutes at each site, with a complete session taking an hour or more. In some cases, the practitioner will expand the therapy beyond the standard 12 sites. Advanced practitioners believe themselves to be as effective even when physically absent from their patients by simply visualizing their hand movements with patients. These practitioners believe that they can send spiritual energy to their patients through a process similar to prayer, and thus are able to perform effective Reiki from a distance.

Some researchers have proposed that Reiki changes the blood's oxygen-carrying capability as shown by hemoglobin and hematocrit levels. However, the few studies conducted to date have yielded mixed results and some of those studies showing changes in hemoglobin or hematocrit levels actually show changes for the worse rather than for the better. One study by Wirth and Barrett in 1994 actually showed slower wound healing time in patients receiving a combination of Reiki, therapeutic

touch, and LeShan (a distance healing technique) than in controls. Studies by Schlitz and Braud in 1985 and Thornton in 1966 examined the claim that Reiki induces relaxation and found that the autonomic activities of subjects receiving Reiki did not differ significantly from those of controls.

No adverse effects on patients have been reported with Reiki. However, no therapeutic benefits of Reiki have been demonstrated through well-controlled, scientific studies. The few studies on Reiki have generally been poorly designed, with such confounding variables as lighting, candles, and music. Although interest in Reiki is growing among alternative practitioners, there is no strong scientific evidence to date for its effectiveness, and Reiki remains unvalidated.

B. Thought Field Therapy (TFT)

Thought field therapy (TFT) is an alternative to psychotherapy used to treat depression, anxiety, phobias, addictions, anger, trauma, grief, and other emotional and mental conditions. It was developed by Roger Callahan, Ph.D., after his reported discovery of the existence of certain structures of active information (called perturbations) in the bioenergy thought field, which he believes cause psychological disorders. Through a long process of trial and error, Dr. Callahan developed TFT to diagnose and treat these perturbations in the energy field.

Proponents of TFT view psychological change as occurring via quantum leaps rather than by a step-by-step linear process. In order to treat psychological problems, the TFT practitioner is able to see and feel the reality of a perturbation. Once the diagnosis of a perturbation is made, the practitioner helps the client to tap a series of “transductive points” on the body in order to alter the structure of the thought field specific to the problem. Proponents of TFT believe the treatment to be so powerful that it need only be used once to result in significant change for a number of psychological problems.

Although the proponents of TFT claim that it has been proven to be more effective than psychotherapy, its effectiveness has not been demonstrated using well-controlled scientific studies. The evidence presented is generally anecdotal and lacks any comparison (control) groups. For example, Leonoff in 1996 reported a study in which he replicated a 1986 study by Dr. Callahan. Both studies used 68 subjects who called a radio program to receive on-the-air treatment by the researchers, and both studies claim a 97% success rate with a 75%

average improvement based on clients' reports of distress using a 10-point rating scale. However, neither study used a control group, and the comparison of the two studies by Leonoff in 1996 simply compares the use of TFT by practitioners in 1985 to the use of TFT by practitioners in 1996 without comparing TFT to any other treatment modality. Therefore, TFT remains unvalidated at this time.

C. Eye Movement Desensitization and Reprocessing (EMDR)

EMDR was first introduced in 1989 by Francine Shapiro, Ph.D., and has since been taught to thousands of clinicians and has received considerable media attention. It is used for the treatment of trauma and the various psychological symptoms that are believed to result from traumatic experiences. EMDR practitioners use an eight-phase protocol to help trauma victims reprocess distressing thoughts and memories, which includes using eye movements or other left-right stimulation:

- Phase I: Client history
- Phase II: Preparation (in which the theory is explained, expectations are set, and the client's fears are addressed)
- Phase III: Assessment (in which negative cognitions are identified, positive cognitions are developed, emotions are named, and body sensations are identified)
- Phase IV: Desensitization (in which eye movements are utilized to reduce the client's anxiety about a certain situation or event)
- Phase V: Installation (in which a positive cognition is enhanced and linked to the original target issue or event)
- Phase VI: Body scan (which focuses on any body tension produced by the original memory or the positive cognition that has been linked to it through the treatment)
- Phase VII: Closure (in which the client is returned to a positive frame of mind and is determined to be able to safely return home before being dismissed)
- Phase VIII: Reevaluation and use of the EMDR standard protocol (in which the clinician assesses how well the trauma has been resolved and determines whether or not the client needs any further processing)

Shapiro in 1995 theorized that EMDR utilizes the same brain processes as REM sleep, although she admits that current knowledge of neurology and neurobiology does not provide an explanation of exactly how EMDR works. Even though the precise impact of EMDR on the brain remains unknown, EMDR has received more rigorous, scientific study than the previously mentioned alternatives to psychotherapy. Shapiro and Forrest in 1997 cited a number of case reports and nonrandomized studies in order to demonstrate the efficacy of EMDR. In addition to these studies, the authors cite 12 randomized and controlled studies that serve to validate EMDR. Some of these studies have compared EMDR to other psychological treatment modalities, to no-treatment controls, or to delayed EMDR treatment, while other studies compare standard EMDR to variations of EMDR such as engendering eye movements by tracking a light bar rather than by tracking the clinician's finger or using forced eye fixation, hand taps, and hand waving instead of the standard eye movements.

These randomized and controlled studies indicate that EMDR is superior to other treatment modalities for the populations studied. However, some of the differences are small even though they are statistically significant. They also indicate that, in general, standard EMDR is as effective or more effective than the variations studied. Although this research seems promising, more study is needed before EMDR can be considered a validated treatment method. Shapiro and Forrest in 1997 reported studies that indicate that EMDR is at least as effective as other treatments, but do not state whether or not any studies conducted have indicated that EMDR is less effective than other treatment modalities for any conditions. Furthermore, some of the studies reported are flawed by confounding variables, such as the secondary gains of chronic inpatient veterans receiving compensation from the VA system. Some studies compare EMDR to treatment modalities unlikely to be effective for the condition being studied, such as biofeedback relaxation for veterans who have experienced chronic PTSD symptoms since the Vietnam War. The gains shown from EMDR as compared to no-treatment controls may be due to the EMDR itself or to the placebo effect, which is generally accepted as about 35% in magnitude. It is unknown whether the gains from EMDR are due to the eye movements themselves or to other aspects of the protocol that closely resemble traditional psychotherapy (such as replacing negative cognitions with positive ones). Therefore, EMDR has

some supporting evidence, but more research is needed.

II. PHARMACOLOGIC (HERBAL) ALTERNATIVES TO PSYCHOTHERAPY

Herbal remedies have become such a major factor in American health care in recent decades that the *Physician's Desk Reference* (PDR) has had a companion volume (*PDR for Herbal Medicines*) updated annually since 1998. In 1997, about 12% of Americans used herbal products, compared to about 3% in 1990. Most consumers who use herbal products do so for the management of chronic conditions, such as psychiatric disorders (particularly anxiety and depression).

Although the American public tends to equate "natural" and "herbal" with "safe," the efficacy and safety of these products have only recently been studied in controlled clinical trials. These recent studies indicate that not all herbal supplements are safe. For example, ephedra (also known as ma huang) is an herbal ingredient found in a number of weight-loss and energy-boosting products available without prescription. It has amphetamine-like qualities and can be dangerous, particularly for people with high blood pressure or heart conditions and is responsible for dozens of deaths. The amino acid tryptophan had been sold as an over-the-counter sleep aid until 1989 when the FDA banned its sale after at least 38 people died and numerous others were left with painful, crippling nerve damage, severe joint pain, and scarring of internal organs from an impurity in a bad batch of the supplement from one manufacturer. Recent evidence indicates that various combinations of herbs marketed as weight-loss products and labeled "Chinese herbs" can cause kidney failure and death. Most likely, aristolochic acid from the Chinese herb *Aristolochia fangchi* (also called *guang fang ji*) is a potent kidney toxin responsible for the reported kidney problems and deaths from kidney failure.

Since Congress passed the Dietary Supplement Health Education Act (DSHEA) in 1994, most herbal supplements have not been regulated by the FDA. Products labeled "dietary supplement" are exempt from FDA control, as long as they do not claim to cure any disease. Therefore, herbal products are not subjected to the same rigorous testing and standards as over-the-counter and prescription drugs. Because most

herbal supplements are exempt from FDA control, many products sold do not contain the amount of active ingredient indicated on the label. Occasionally the products contain more of the active ingredient than indicated, while often the products contain substantially less of the active ingredient than the label indicates. For this reason, research done using standardized dosages of herbal remedies may not be a valid indication of the efficacy of the unstandardized herbs available to the American public.

Most of the American public is unaware that most herbal products have side effects and interaction effects with medications. Some of the side effects and interaction effects will be discussed with each example of herbal alternatives to psychotherapy.

A. St. John's Wort (*Hypericum perforatum*)

St. John's wort was used by the ancient Greeks and has been used in Germany for many years as a prescription drug. It has recently become one of the most common herbal products sold in the United States, with retail sales surpassing \$140 million in 1998. Its effectiveness has been studied in Europe. Linde provided a meta-analysis of 23 randomized trials in Europe, 15 of which compared St. John's wort to placebo and 8 of which compared it to active treatments. These studies indicate no significant difference in efficacy between St. John's wort and tricyclic antidepressants for mild to moderate depression and that St. John's wort is more efficacious than placebo. However, these studies were generally short (about 6 weeks) in duration. Research comparing St. John's wort to selective serotonin reuptake inhibitors (SSRIs) is in its infancy. One recent trial compared St. John's wort to fluoxetine (Prozac) and showed similar improvements in both groups. A clinical trial sponsored by the National Institute of Mental Health (NIMH) is currently under way to compare St. John's wort to sertraline (Zoloft).

One study by Shelton and colleagues, which appeared in the April 18, 2001 issue of the *Journal of the American Medical Association* (JAMA), indicated that St. John's wort is no more effective than placebo for treating major depression. The study has gained significant media attention and has called into question previous studies indicating that St. John's wort is effective. However, the recent JAMA study looked at St. John's wort and major depression whereas the previous studies had looked at St. John's wort for the treatment of mild or

moderate depression. Taken as a whole, the body of research available to date indicates that St. John's wort may be useful for cases of mild to moderate depression, but that it is ineffective for the treatment of severe depression (major depression).

The mechanism of action of St. John's wort is uncertain. Early studies suggested it was similar to a monoamine oxidase (MAO) inhibitor in its action, but recent data indicate it is closer to an SSRI, except that it does not affect the serotonin system in the spinal cord and, therefore, does not produce the decrease in sexual drive experienced by at least one-third of SSRI users. Use of St. John's wort in conjunction with MAO inhibitors or SSRIs is contraindicated, as the combination increases SSRI-like side effects and could result in serotonin syndrome, a condition causing dizziness, confusion, anxiety, and headaches. The syndrome is potentially fatal.

Side effects of St. John's wort are similar to those of SSRIs and include gastrointestinal symptoms, dizziness, confusion, sedation, dry mouth, photosensitivity, and induction of hypomania according to Barrette, in 2000, and *PDR for Herbal Medicines* in 2000. A number of drug interactions may occur with St. John's wort. It can reduce blood levels of the HIV drugs (such as indinavir) by more than 50%, which may in turn lead to drug-resistant strains of the virus, noted the University of California, Berkeley, in 2000. It reduces the effects of blood thinners such as warfarin (Coumadin), the heart drug digoxin, some oral contraceptives, and the immunosuppressant drug cyclosporine (which helps prevent organ rejection in transplant recipients). It increases photosensitivity when used in conjunction with other photosensitizing drugs.

B. 5-HTP (5-Hydroxytryptophan)

5-HTP is an herbal supplement manufactured from the seeds of the African plant *Griffonia simplicifolia*. It is metabolized into serotonin and is thought to alleviate depression by enhancing serotonin neurotransmission. It is also used to treat fibromyalgia, insomnia, binge-eating, attention deficit disorder, and chronic headaches.

Studies conducted in the 1970s and early 1980s have shown 5-HTP to be more effective than placebo in treating depression. Several small studies have compared 5-HTP to standard antidepressant medications. However, these studies have some notable flaws (small sample sizes, short durations, no placebo group, poor definition of depression, and the inclusion of patients with bipolar depression).

The most common side effects of 5-HTP are nausea, vomiting, diarrhea, and anorexia. Euphoria, hypomania, restlessness, rapid speech, anxiety, insomnia, aggressiveness, and agitation have also been reported. It is possible that 5-HTP causes seizures in children with Down syndrome, and its safety for pregnant or nursing women and those with liver and kidney disease has not been established. People with kidney disease, peptic ulcers, or blood platelet disorders should not use 5-HTP.

There is some concern about contamination, even though the manufacture of 5-HTP is different from that of the standard tryptophan, which was banned in 1989. There have been a few reports of symptoms similar to those caused by contaminated tryptophan, and researchers have identified at least one contaminant in some batches of 5-HTP.

5-HTP interacts with MAO inhibitors, with an increase in risk of hypertension. 5-HTP should not be used in conjunction with tricyclic antidepressants or SSRIs due to the possibility of serotonin syndrome. 5-HTP also interacts with carbidopa (used to treat Parkinson's disease), and the combination can cause skin changes similar to those that occur with scleroderma.

C. SAME (S-adenosylmethionine)

SAMe (pronounced "Sammy") was first discovered in Italy in 1953. It became commercially available in Europe in 1977, and was not available in the United States until 1999. SAMe is used to treat osteoarthritis and liver disease, as well as depression, as noted by Gaster, and by Tufts University, in 1999. SAMe's mechanism for dealing with depression is not understood, but some researchers speculate that it affects brain levels of the neurotransmitters serotonin, noradrenaline, and possibly dopamine.

More than 40 trials have been conducted to evaluate SAMe for the treatment of depression. However, only five trials have tested oral forms of the herb, whereas the remaining studies have tested injectable formulations. Only three of the five trials of oral SAMe were randomized controlled trials. The trials that have tested injectable SAMe have generally shown it to be effective in the treatment of depression, although it is not valid to assume that oral SAMe is effective since it is very poorly absorbed from the gastrointestinal tract. It is too early to tell whether SAMe will prove to be a safe and effective treatment for depression.

Stomach upset is the most common side effect reported with SAMe use. Enteric-coated products are less likely to cause nausea, and are also less likely to break down in the stomach before they reach the small intestine

where SAME is absorbed. SAME is contraindicated for individuals with bipolar disorder, as it can trigger manic episodes. Those with obsessive-compulsive or addictive tendencies should not take SAME, as it may worsen their problems.

Safety concerns provide compelling reasons to avoid using SAME pending further research. Because the research has been very short term, it is not known whether taking the herb long term could cause problems with toxicity or carcinogenicity. Because SAME raises blood levels of homocysteine, it may also raise the risk of coronary disease. Until it is understood how SAME acts on the central nervous system, it is best to avoid taking SAME in conjunction with other antidepressants, according to Gaster in 1999.

Even though SAME's effectiveness and safety remain unvalidated, it is considerably more expensive than other treatments for depression (16 times as costly as St. John's wort, 5 times as costly as most tricyclic antidepressants, and 3 times as costly as SSRIs). SAME cannot be recommended at this time for the treatment of depression due to its high cost, uncertain absorption, uncertain safety, and potential for inducing mania.

D. Kava, also known as kava kava (*Piper methysticum*)

Kava is a shrublike plant from the pepper family that is native to the South Pacific. It has traditionally been made into beverages, but can also be purchased in pill form. Kava is marketed in the United States as an over-the-counter drug to treat anxiety and insomnia and to promote relaxation, with millions of dollars being spent annually on the herb. The effectiveness of kava has been researched in placebo-controlled studies conducted in the United States and Germany. Meta-analysis of these studies provides evidence that kava is more effective than placebo for mild to moderate anxiety, but it is not effective for panic disorder. To date, the effectiveness of kava as compared to other antianxiety medications is unknown. Mild gastrointestinal upset is the main side effect of kava, and therapeutic doses are generally well-tolerated. However, large doses or prolonged use can cause rashes (allergic skin reactions); yellow discoloration of skin, hair, and nails; weight loss; and abnormal reflexes.

Kava root contains kavalactones, fatlike compounds that act as sedatives, muscle relaxants, and pain relievers. It is recognized by the FDA as being intoxicating and having abuse potential. Kava most likely works on the neurotransmitter GABA (gamma-aminobutyric acid) as an agonist (much like benzodiazepines), but since it is

only a partial agonist it may be somewhat less effective than benzodiazepines. Because GABA is an inhibitory neurotransmitter, stimulation of GABA receptors results in CNS depression, noted Cummings, in 2000.

Use of kava with other central nervous system depressants (such as alcohol, benzodiazepines, or barbiturates) is contraindicated, as the interaction can potentiate the sedative effect and possibly lead to coma. Use of kava with anesthetics is also contraindicated, as it may prolong the sedation time and its use is contraindicated with antipsychotic medications due to the potentiation of the sedative effects. In Parkinson's patients, it can cause tremors, muscle spasms, or other abnormal movements and may decrease the effectiveness of anti-Parkinson's medications.

E. Valerian, also known as Heliotrope (*Valerianae radix* or *Valeriana officinalis*)

Valerian is an herb with mild tranquilizing effects, sold over-the-counter and used to treat insomnia and mild anxiety. It was the 10th most popular herb in the United States in 1998, whereas it was ranked 18th the previous year. It was originally used in ancient Greece, and was used during World War I as a primary treatment for shell shock.

Like kava, valerian likely acts as a GABA agonist to produce its sedative effects, noted Hardy in 1999. Several good placebo-controlled studies indicate that it reduces the time it takes to fall asleep, but the research indicating that it improves sleep quality is very limited. The few available studies indicate that valerian is somewhat more effective than placebo for treating mild anxiety, but is likely ineffective for moderate to severe anxiety or panic disorder.

Valerian's side effects include mild morning sedation and headache, although one case of serious liver toxicity from an over-the-counter sleep remedy containing valerian has been reported. Valerian use in conjunction with other sedative drugs (such as benzodiazepines, barbiturates, or anesthetics) is contraindicated, as the interaction may potentiate the sedation. The research available to date indicates that valerian may not potentiate the effects of alcohol, but until more research is available it is advisable not to combine the two.

III. SUMMARY

In general, good studies demonstrating the effectiveness of most alternatives to psychotherapy are lacking.

In some cases, the research is yet to be conducted. In other cases, the body of available research indicates that the treatments are ineffective or, at best, only slightly more effective than placebo. However, more and more health care dollars are being spent on these and other alternative therapies. This trend toward increased utilization of treatments that are unverified and of dubious scientific validity is likely due to several factors: (1) The American consumer expects modern medicine to be able to cure every ailment and alleviate every pain. When it does not, the consumer often turns to alternative techniques. (2) The public erroneously equates "alternative" with "safe" and "natural." At the same time, the public is concerned about the dangerous side effects that may accompany prescription medications. (3) Many patients believe that managed care is limiting their access to medical treatment and medications. In many cases, the newer psychotropic medications are not included on some insurance companies' formularies. Even though herbal alternatives may be costly, they are often less costly than paying out-of-pocket for non-formulary medications. (4) Many consumers complain that their doctors do not really listen to them and involve them in health care decisions. On the other hand, health food store personnel and alternative practitioners are often much more willing to listen, spend time with patients, and offer patients the opportunity to participate in decisions. (5) Perhaps most important, the public is deluged with health information. Few people have the ability to read health information critically and to distinguish between good science and hype.

Although research to date may not be sufficient to draw conclusions about the effectiveness of many alternative therapies, some alternative therapies have

been demonstrated to be effective adjunct treatments for various medical conditions. For example, biofeedback has been shown to be helpful in the treatment of a number of medical conditions, particularly muscle tension headaches and Raynaud's disease. As a result, insurance companies are becoming increasingly willing to pay for such treatments as adjuncts to standard medical treatments.

See Also the Following Articles

Animal-Assisted Therapy ■ Biofeedback ■ Cost Effectiveness ■ Cultural Issues ■ Effectiveness of Psychotherapy ■ Eye Movement Desensitization and Reprocessing ■ Online or E-Therapy

Further Reading

- Lam, Y. W. F. (2000). *Pharmacology update: Efficacy and safety of herbal products as psychotherapeutic agents*. Providence, RI: Manisses Communications Group.
- Mayo Clinic. (2000). *Special report: Alternative medicine*. Rochester, MN: Mayo Foundation for Medical Education and Research Publications.
- Petter, F. A. (1997). *Reiki fire: New information about the origins of the Reiki power*. Twin Lakes, WI: Lotus Light Publications.
- Sachs, J. (1997). *Nature's Prozac: Natural remedies and techniques to rid yourself of anxiety, depression, panic attacks and stress*. Englewood Cliffs, NJ: Prentice Hall.
- Shapiro, F., & Forrest, M. S. (1997). *Eye movement desensitization and reprocessing: The breakthrough "eye movement" therapy for overcoming anxiety, stress, and trauma*. New York: Basic Books.

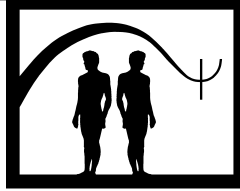

Anger Control Therapy

Raymond W. Novaco

University of California, Irvine

- I. Description of Treatment
 - II. Theoretical Bases
 - III. Applications and Exclusions
 - IV. Empirical Studies
 - V. Case Illustration
 - VI. Summary
- Further Reading

GLOSSARY

aggression Behavior intended to cause psychological or physical harm to someone or to a surrogate target. The behavior may be verbal or physical, direct or indirect.

anger A negatively toned emotion, subjectively experienced as an aroused state of antagonism toward someone or something perceived to be the source of an aversive event.

anger control The regulation of anger activation and its intensity, duration, and mode of expression. Regulation occurs through cognitive, somatic, and behavioral systems.

anger reactivity Responding to aversive, threatening, or other stressful stimuli with anger reactions characterized by automaticity of engagement, high intensity, and short latency.

anger schemas Mental representations about environment-behavior relationships, entailing rules governing threatening situations. They affect anger activation and behavioral responding.

cathartic effect The lowering of the probability of aggression as a function of the direct expression of aggression toward an anger-instigator. The lowering of arousal associated with such catharsis is more or less immediate and can be reversed by re-instigation.

escalation of provocation Incremental increases in the probability of anger and aggression, occurring as reciprocally heightened antagonism in an interpersonal exchange.

excitation transfer The carryover of undissipated arousal, originating from some prior source, to a new situation having a new source of arousal, which then heightens the probability of aggression toward that new and more proximate source.

frustration Either a situational blocking or impeding of behavior toward a goal or the subjective feeling of being thwarted in attempting to reach a goal.

hostility An attitudinal disposition of antagonism toward another person or social system. It represents a predisposition to respond with aggression under conditions of perceived threat.

inhibition A restraining influence on anger expression. The restraint may be associated with either external or internal factors.

provocation hierarchy A set of provocation scenarios progressively graduated in degree of anger-inducing features for the client. It is constructed by the therapist in collaboration with the client during the early stages of treatment and is used in the stress inoculation procedure.

stress inoculation A three-phased, cognitive-behavioral approach to therapy, involving cognitive preparation/conceptualization, skill acquisition/rehearsal, and application/follow-through. Cognitive restructuring, arousal reduction, and behavioral coping skills training are the core treatment components. Therapist-guided, graded exposure to stressors occurs in the application phase, where the client's enhanced anger control skills are engaged.

violence Seriously injurious aggressive behavior, typically having some larger societal significance. The injury may be immediate or delayed.

I. DESCRIPTION OF TREATMENT

A. Topic Introduction and Definition

Providing psychotherapy for persons having recurrent anger problems is a challenging clinical enterprise. This turbulent emotion, ubiquitous in everyday life, is a feature of a wide range of clinical disorders. It is commonly observed in various personality, psychosomatic, and conduct disorders, in schizophrenia, in bipolar mood disorders, in organic brain disorders, in impulse control dysfunctions, and in a variety of conditions resulting from trauma. The central problematic characteristic of anger in the context of such clinical conditions is that it is “dysregulated”—that is, its activation, expression, and effects occur without appropriate controls. Anger control treatment, a cognitive-behavioral intervention, augments the client’s self-regulatory capacity. It aims to minimize anger frequency, intensity, and duration and to moderate anger expression. It is an adjunctive treatment for a targeted clinical problem and thus is not meant to address other or more general psychotherapeutic needs. Clinical interventions for problems of anger seek to remedy the emotional turbulence that is associated with subjective distress, detrimental effects on personal relationships, health impairments, and the manifold harmful consequences of aggressive behavior. The main components of anger control treatment are cognitive restructuring, arousal reduction, and enhancement of behavioral skills. A key feature of its implementation is therapist-guided progressive exposure to provocation, in conjunction with which anger regulatory coping skills are acquired.

B. Core Characteristics of Clients

A common characteristic of people having serious anger problems is that they resist treatment, largely due to the functional value that they ascribe to anger in dealing with life’s adversities. Because anger can be commingled with many other clinical problems (such as personality disorder, psychoses, or substance abuse), getting leverage for therapeutic change can be an elusive goal, particularly when referrals for anger treatment entail some element of coercion. Efforts to achieve clinical change are challenged by the adaptive functions of anger as a normal emotion, such that it is not easily relinquished. Anger is often entrenched in personal identity and may be derivative of a traumatic life history. Because anger activation may be a precursor of aggressive behavior, while being viewed as a salient clinical need, it may at the same time present

safety concerns for the clinician and be unsettling for mental health professionals to engage as a treatment focus. Although many high-anger patients present with a hard exterior, they can be psychologically fragile, especially those having histories of recurrent abuse or trauma, or when abandonment and rejection have been significant life themes. Because anger may be embedded with other distressed emotions, accessing anger is often not straightforward.

C. Assessment Issues

Anger treatment best proceeds from proficient anger problem assessment. However, assessment itself presents many challenges, because of the multidimensionality of anger (cognitive, physiological, and behavioral features) and because the true level of anger may be masked by the person in reaction to the testing situation. In many assessment contexts, particularly forensic ones, people are not inclined to report that they have high anger dispositions. Even when clients are treatment-seeking, they may not be altogether forthcoming about their anger because an “angry person” labeling carries unflattering connotations. Effectively targeting anger treatment, as well as ascertaining therapeutic gains, hinges on assessment proficiency, which is best done by a multimethod approach utilizing interview, psychometric, clinical rating, and behavioral observation methods, as well as archival and physiological methods when possible.

D. Levels of Intervention

Psychotherapy for anger control can occur at several levels of intervention: (1) General clinical care for anger; (2) psychoeducational “anger management” provision, typically delivered in a group format; and (3) anger treatment, which is best provided on an individual basis and may require a preparatory phase to facilitate treatment engagement. The intervention levels reflect the degree of systematization, complexity, and depth of therapeutic approach. Increased depth is associated with greater individual tailoring to client needs. Correspondingly, greater specialization in techniques and in clinical supervision is required at higher levels.

E. Anger Control Treatment: A Stress Inoculation Approach

Cognitive-behavioral anger treatment targets enduring change in cognitive, arousal, and behavioral systems. It centrally involves cognitive restructuring and

the acquisition of arousal reduction and behavioral coping skills, achieved through changing valuations of anger and augmenting self-monitoring capacity. Because it addresses anger as grounded and embedded in aversive and often traumatic life experiences, it entails the evocation of distressed emotions (e.g., fear and sadness) as well as anger. Therapeutic work centrally involves the learning of new modes of responding to cues previously evocative of anger in the context of relating to the therapist (“transference”), and it periodically elicits negative sentiment on the part of the therapist to the frustrating, resistive, and unappreciative behavior of the client (“countertransference”). Anger treatment that has followed a “stress inoculation” approach utilizes provocation hierarchy exposure. The inoculation metaphor is associated with the therapist-guided, progressive exposure to provocation stimuli. This occurs *in vitro* through imaginal and role-play provocations in the clinic, and *in vivo* through planned testing of coping skills in anger-inducing situations identified by the client’s hierarchy.

Stress inoculation for anger control involves the following key components: (1) Client education about anger, stress, and aggression; (2) self-monitoring of anger frequency, intensity, and situational triggers; (3) construction of a personal anger provocation hierarchy, created from the self-monitoring data and used for the practice and testing of coping skills; (4) arousal reduction techniques of progressive muscle relaxation, breathing-focused relaxation, and guided imagery training; (5) cognitive restructuring of anger schemas by altering attentional focus, modifying appraisals, and using self-instruction; (6) training behavioral coping skills in communication, diplomacy, respectful assertiveness, and strategic withdrawal, as modeled and rehearsed with the therapist; and (7) practicing the cognitive, arousal regulatory, and behavioral coping skills while visualizing and role-playing progressively more intense anger-arousing scenes from the personal hierarchies.

Provocation is simulated in the therapeutic context by imagination and role-play of anger incidents from the hierarchy scenarios, produced by the collaborative work of client and therapist. The scenarios incorporate wording that captures the client’s perceptual sensitivities on provoking elements, such as the antagonist’s tone of voice or nuances of facial expression. Each scenario ends with provocative aspects of the situation (i.e., not providing the client’s reaction), so that it serves as a stimulus scene. The therapist directs this graduated exposure to provocation and knows the moderating variables that will exacerbate or buffer the magnitude of the anger reaction, should the scene need

to be intensified or attenuated in potency. Prior to the presentation of hierarchy items, whether in imaginal or role-play mode, anger control coping is rehearsed, and arousal reduction is induced through deep breathing and muscle relaxation. Successful completion of a hierarchy item occurs when the client indicates little or no anger to the scene and can envision or enact effective coping in dealing with the provocation.

Following the completion of the hierarchy, an effort is made to anticipate circumstances in the client’s life that could be anger-provoking and the obstacles to anger control that might arise. This is done as a relapse prevention effort, especially as people having anger difficulties are often without adequate supportive relationships to provide reinforcement for anger control. Follow-up or booster sessions are typically arranged to provide support, to ascertain what coping skills have proven to be most efficacious, and to boost treatment in areas in need of further work. Because of the reputations acquired by high-anger people, the reactions of others to them can be slow to change. This can lead to relapse and requires therapeutic attention at follow-up.

F. Treatment Preparatory Phase Needed

Some seriously angry clients may be quite ambivalent about earnestly engaging in assessment and treatment, and in some clinical service contexts, particularly forensic settings, angry patients may be very guarded about self-disclosure. Because of the instrumental value of anger and aggression, many clients do not readily recognize the personal costs that their anger routines incur; because of the embeddedness of anger in long-standing psychological distress, there is inertia to overcome in motivating change efforts. In such circumstances, a treatment “preparatory phase” is implemented, involving a block of five to seven sessions, varying with client competence and motivation. The aim is to foster engagement and motivation, while conducting further assessment and developing the core competencies necessary for treatment, such as emotion identification, self-monitoring, communication about anger experiences, and arousal reduction. It serves to build trust in the therapist and the treatment program, providing an atmosphere conducive to personal disclosure and collaboration. Since the preparatory phase can be pitched to the client as a “trial period,” its conclusion then leads to a more explicit and informed choice by the client about starting treatment proper.

II. THEORETICAL BASES

A. Anger and Threat

The conception of anger as a product of threat perceptions, as having confirmatory bias characteristics (i.e., the perception of events is biased toward fit with existing anger schemas), as being primed by aversive precursors, and as having social distancing effects (i.e., expressing anger keeps people away) can be found in the writings of Lucius Seneca, who was Nero's tutor in first-century Rome. Seneca was the first to write systematically about anger control. Like other Stoic philosophers who negate the value of emotions, his view of anger was almost exclusively negative. Although his idea of anger control was largely that of suppression, Seneca recognized the powerful role of cognition as a determinant of anger, advocated cognitive shift and reframing to minimize anger, and saw the merit of a calm response to outrageous insult. However, he discounted the functional value of anger, which thereby led him to miss the principle of regulation.

Since the writings of Charles Darwin, William James, and Walter B. Cannon, anger has been viewed in terms of the engagement of the organism's survival systems in response to threat and the interplay of cognitive, physiological, and behavioral components. It is an elementary Darwinian notion that the adaptive value of a characteristic is entailed by its fitness for the environment; if the environment changes, that characteristic may lose its adaptive value, and the organism must adjust. The activation of anger may usefully serve to engage aggression in combat and to overcome fear, but in most everyday contexts, anger is often maladaptive.

Many theories of emotion have enlarged upon the Darwinian view of emotions as reactions to basic survival problems created by the environment and upon Cannon's idea that internal changes prepare the body for fight or flight behavior. Thus, emotion has commonly been viewed as an action disposition. Some contemporary theorists postulate that emotion is controlled by appetitive and aversive motive systems in the brain, with the amygdala serving as a key site for the aversive motivational system, and neurobiological mechanisms associated with amygdala involvement in aversive emotion and trauma are being studied in various laboratories. Most generally, when people are exposed to stimuli signifying present danger or reminders of trauma, they are primed for anger reactions. Anger is intrinsically connected to threat perception.

B. Anger and Cognition

Central to therapeutic prescriptions for anger control is the idea that emotion is a function of cognitive appraisal. That is, anger is produced by the meaning that events have and the resources we have for dealing with them, rather than by the objective properties of the events. Important work in this regard was done by Lazarus on appraisal processes and on stress coping styles, yet there is dispute about how pivotal is appraisal in the activation of anger. Berkowitz alternatively asserts that aversive events trigger basic associations to aggression-related tendencies as a "primitive" or "lower order" processing, which is then paralleled by anger in association. "Higher order" processing, such as appraisal, is then subsequent to the rudimentary reactions, and anger can be elaborated by the appraisal. Similarly, Beck has conjectured that anger derives from "primitive" processing in defense against threat, in which mode information is rapidly compartmentalized. Negative biases and overgeneralization lead to information-processing errors and anger activation. Appraisal processing (activation of beliefs and interpretations) may then follow this primal thinking mode. What Beck adds is that automatic thoughts are activated in the primal mode and that these are the roots of emotional distress.

This differentiation between "lower order" and "higher order" processing may otherwise be viewed as a distinction between "automatic" versus "controlled" operations. Sometimes anger occurs as a fast-triggered, reflexive response, while other times it results from deliberate attention, extended search, and conscious review. There is nothing necessarily "primitive" about automaticity in anger responding, as anger schemas and aggressive scripts, which are acquired through social learning, can produce rapid reaction to provocation stimuli. Furthermore, central cognitive processes can override reflexive responding to aversive stimulation. Otherwise we would be very angry on most trips to the dentist, and professional boxers in the ring would be in a continuous state of rage.

Social information processing models of aggressive behavior, such as that of Huesmann, view the human mind as analogous to a computer. Anger schemas are thus understood as macro knowledge structures, encoded in memory, that filter our perceptions and are used to make inferences. Aggressive scripts are subroutines that serve as guides for behavior, laying out the sequence of moves or events thought to be likely to occur and the behavior thought to be possible or appropriate for a certain situation.

The main thrust of such conceptions is that anger and its associated behavior are cognitively mediated. Correspondingly, anger control interventions target the way in which people process information, remember their experiences, and cognitively orient to new situations of stress or challenge. Therapeutic change of schemas linked to anger prevents the occurrence of anger, and the self-regulation of anger once activated is effected by controlled use of cognitive self-control techniques, such as calming self-instructions and relaxation imagery, combined with other arousal reduction and behavioral coping strategies.

C. Cognition, Arousal, and Behavior Reciprocities

Intrapsychic, dispositional systems are the principal focus of psychotherapy, and, in that regard, anger has three main subsystems or domains: cognitive, physiological, and behavioral. Cognitive dispositions for anger include knowledge structures, such as expectations and beliefs, and appraisal processes, which are schematically organized as mental representations about environment-behavior relationships entailing rules governing threatening situations. Arousal or physiological dispositions for anger include high hormone levels (neurotransmitters) and low stimulus thresholds for the activation of arousal. Anger is marked by physiological activation in the cardiovascular, endocrine, and limbic systems, and by tension in the skeletal musculature. Behavioral dispositions include conditioned and observably learned repertoires of anger-expressive behavior, including aggression but also avoidance behavior. Implicit in the cognitive labeling of anger is an inclination to act antagonistically toward the source of the provocation. However, an avoidant style of responding, found in personality and psychosomatic disorders, can foment anger by leaving the provocation unchanged or exacerbated.

Thus, it can be seen that these dispositional subsystems are highly interactive or interdependent. Anger-linked appraisals influence arousal levels, high arousal activates aggression and overrides inhibition, and antagonistic behavior escalates aversive events and shapes anger schemas and scripts for anger episodes as behavioral routines are encoded. In turn, the personal dispositional system interfaces with the environmental, such as when anger and aggression drive away pacific people, leaving one with angry and aggressive companions, who not only incite anger but from whom one continues to learn anger responding and anger-engendering appraisals, which further heighten arousal.

D. Person-Environment Context and Systems

Anger and anger control difficulties should be understood contextually. This assumes that recurrent anger is grounded in long-term adaptations to internal and external environmental demands, involving a range of systems from the biological to the sociocultural. The adaptive functions of anger affect the social and physical environmental systems in which the person has membership. Anger experiences are embedded or nested within overlapping systems, such as the work setting, the work organization, the regional economy, and the sociocultural value structure. Anger determinants, anger experiences, and anger sequelae are interdependent.

The interrelatedness of system components provides for positive and negative feedback loops. When a system moves away from equilibrium, negative feedback loops serve to counteract the deviation, such as when the self-monitoring anger reactions prompt deep breathing or cognitive reappraisal to achieve anger control. In contrast, anger reactions can be augmented by positive feedback, which is a deviation amplification effect. Anger displays in a situation of conflict tend to evoke anger and aggression in response, which then justify the original anger and increase the probability of heightened antagonism. Such anger-aggression escalation effects are well-known in conflict scenarios, whether interpersonal or international.

Intervention proceeding from a contextual model examines environmental, interpersonal, and dispositional subsystems that shape anger reactions. Although recurrent anger is often a product of long-term exposure to adverse conditions or to acute trauma, it is nevertheless the case that anger is a product of agentic behavior. People who select high-conflict settings or recurrently inhabit high-stress environments set the stage for their anger experiences. Those who are habitually hostile create systemic conditions that fuel continued anger responding that is resistant to change. As anger schemas solidify, anger is evoked with considerable automaticity in reaction to minimal threat cues. Aggressive scripts that program antagonistic behavior, which exacerbates anger difficulties, are socially and contextually learned. Focus on intrapsychic variables is transparently inadequate when the person remains immersed in anger-engendering contexts. Coordinated efforts of a multidisciplinary treatment team may be required.

III. APPLICATIONS AND EXCLUSIONS

Anger control therapy is an adjunctive treatment. Across categories of clients, the key issues regarding appropriateness for this therapy are (1) The extent to which the person has an anger regulatory problem, implying that acquisition or augmentation of anger control capacity would reduce psychological distress, the probability of aggression or other offending behavior, or a physical health problem, such as high blood pressure; (2) whether the person does recognize, or can be induced to see, the costs of his or her anger and aggression routines and is thus motivated to engage in treatment; and (3) whether the person can sit and attend for approximately 45 minutes. The latter criterion applies especially to hospitalized patients. The stress inoculation approach to anger has been successfully applied to institutionalized mentally disordered (schizophrenia and affective disorders) and intellectual disabled persons (mild to borderline). Because resolution on the issue of treatment engagement is often elusive, an anger treatment "preparatory phase" has been developed and implemented in work with forensic patients. Such preparatory work would also be appropriate for persons who have anger dysregulation in conjunction with trauma.

People with violent behavior problems are often referred for anger treatment (e.g., incarcerated offenders and spousal abusers or enraged drivers in the community). However, anger treatment is not indicated for those whose violent behavior is not emotionally mediated, whose violent behavior fits their short-term or long-term goals, or whose violence is anger mediated but not acknowledged. Little is known about the efficacy of cognitive-behavior therapy anger treatment with psychopaths, but it is doubtful that it would be suitable. As well, persons who are acutely psychotic or whose delusions significantly interfere with daily functioning are not suitable candidates for this self-regulatory treatment. Persons with substance abuse disorders also require prior treatment to engage in anger therapy. Successful case applications are given later.

IV. EMPIRICAL STUDIES

Research on anger treatment lags substantially behind that for problems of depression and anxiety, yet there is convergent evidence that various cognitive-

behavioral interventions produce therapeutic gains in anger control. However, there have been few randomized control studies with seriously disordered patients. Such studies have more commonly been done with college student volunteers, selected as treatment recipients by upper quartile scores on self-reported trait anger, by having expressed interest in counseling for anger management, and by volunteering over the telephone. Such sample inclusion criteria do not reflect the clinical needs of the angry patients seen by mental health service providers in community and institutional settings. Existing meta-analytic reviews of treatment efficacy are overloaded with college student studies and fail to include case study reports and multiple baseline studies, which have typically involved real patients with serious problems. Nevertheless, statistical computations in reviews across dozens of controlled studies have found medium effect sizes for anger treatments, indicating that the large majority of treated participants were improved.

Cognitive-behavior therapy approaches that have not followed the stress inoculation framework have produced significant treatment gains, such as those by Deffenbacher and his colleagues using cognitive and relaxation methods with college student volunteers without demonstrable clinical pathology or violence history. However, such treatment study participants do not reflect the clinical needs of the angry patients seen by mental health service providers in community and institutional settings. In contrast to college student volunteer studies, a controlled anger treatment trial with seriously disordered Vietnam veterans by Chemtob, Novaco, Hamada, and Gross in 1997, which was missed in the Beck and Fernandez meta-analysis in 1998, obtained significant treatment effects on multiple measures of anger reactions and anger control for the stress inoculation anger treatment, compared to a multimodal, routine care control treatment condition. The anger control treatment gains with these severe post-traumatic stress disorder patients, who had had intense, recurrent postwar problems with anger and aggressive behavior, were maintained at 18-month follow-up. Other control group studies involving successful outcomes for the modified stress inoculation approach to anger treatment with clinical populations have included adolescents in residential care, adolescent offenders, forensic patients, and mentally retarded adults. Exemplary work on anger control with adolescents has been done by Feindler and her colleagues.

Multiple case studies involving a variety of serious clinical disorders have provided empirical support for

the efficacy of cognitive-behavioral anger treatment and the stress inoculation approach. These include a hospitalized depressed patient, child abusing parents, chronically aggressive patients, an emotionally disturbed boy, a brain damaged patient, mentally handicapped patients, adolescents in residential treatment, and institutionalized forensic patients.

Brief cognitive-behavioral therapy "anger management" has been successfully used in prisons, often delivered in group format, varying from 3 to 16 sessions across studies. However, outcome evaluation assessments in these prison-based studies have been thin, and results of efficacy have been uneven. In this regard, the treatment engagement issues highlighted earlier are most relevant, and the interventions used have not been firmly based in a designated treatment protocol. Because the through-put client service needs of institutions and community agencies are formidable, greater attention needs to be given to the development of group-based intervention for anger.

V. CASE ILLUSTRATION

A. Case Description

Mr. A is a man in his thirties, who received anger treatment in a forensic hospital. He had a highly dysfunctional home background. He was truant from school and reported abnormal psychological experiences, resulting in the involvement of the psychiatric services. In his teens, he developed a substance abuse problem and associated with a delinquent peer group that encouraged a violent presentation. Persistent petty theft associated with substance abuse and aggression led to placement in secure facilities. There, the experience of both using violence and being bullied had a profound effect on him.

He married and had a child, but his wife left him while he was serving a short prison sentence. Following a period of homelessness, he was imprisoned for assault. He was diagnosed with schizophrenia and while he resisted this, he would allude to having a special destiny after an encounter with extraterrestrials who had given him the power to benefit mankind. He was subsequently transferred to a psychiatric hospital, where he made a number of attacks on staff. He was ultimately transferred to community accommodation, but he was ejected for theft and noncompliance. He was readmitted to a local hospital, following arrest for reckless damage and police assault. He then again as-

saulted one of the staff, so badly that this led to his admission to a maximum security hospital.

There, his psychotic symptoms soon remitted, but he was reported to be demanding and antiauthoritarian, continually challenging the rules and reacting aggressively to any perceived threat to his self-image. A transfer to a local hospital was unsuccessful due to his aggressive, demanding manner and drug misuse. He struggled to cope with his readmission and maintained an antiestablishment attitude. He made frequent threats toward staff and was physically assaultive. Making little progress, he made a serious attempt at suicide, which was related to despair at his continued detention. When under stress, his positive psychotic symptoms could emerge. His close relationships having disintegrated, he was very worried about future intimate relationships.

B. Treatment Application

Mr. A received anger treatment by staff psychologists. He was happy to attend sessions but initially found it difficult to engage in tasks. He was anxious about being not listened to and was resistant to being given advice. He often refused to participate, argued his own point, talked on a tangent, or reduced everything to a joke. He was insistent that he should not be rushed and feared being overwhelmed. Establishing a supportive relationship and a sensitive pacing of therapy was vital to engagement. As he came to view his therapists as being nonjudgmental and working in his interests, he became less defensive and more willing to complete tasks such as anger diaries and hierarchical inoculation exercises. As treatment progressed, he became more resilient to provocation and less likely to conclude that others were personally attacking him. He found alternative ways of viewing situations that previously had initiated angry attempts to restore his self-esteem. He became more aware of his heightened level of physiological arousal in problematic situations and used tension reduction methods, including relaxation and taking time-outs to create social distance from provoking events. He learned to approach staff to discuss matters of dispute and received support from his peers for anger control.

Illustrative incidents: (1) Another patient accused Mr. A of not repaying a debt. As this was said in public, Mr. A thought this was a deliberate attempt to humiliate him and being angry, wanted to show that he was not someone "to be trifled with." However, he managed to stay calm and avoid violence; instead he responded in a

way that minimized loss of face and reminded himself of the negative consequences of physical violence. Later, he reassessed the situation, reasoning that the other patient was struggling with a life sentence for murder and had been picking on others, not just targeting him. Discussing the event with friends, they reinforced his view and reassured him that they did not believe the accusation. (2) Having been recommended for transfer to a lower security hospital, a visit to that local hospital was arranged. One hour before leaving for his visit, it was cancelled because of events at the local hospital. Initially he was convinced that there was a sinister motive, feeling that the staff were trying to renege on the agreement. He became angry. However, he used arousal reduction techniques, and had a discussion with staff, who rearranged the visit. Staff remarked that he listened to their explanation and trusted them to resolve the situation, rather than behave self-destructively.

C. Treatment Gains and Transfer

Level of care staff observed that Mr. A generally began to take others' perspectives into account, and his psychiatrist reported that he was less impatient, less instantly demanding, and better able to listen and to discuss issues in a constructive manner. His gains in anger control led to a recommendation for transfer to his local hospital, and staff there reported being impressed with what they felt was a positive change in his presentation. His self-reported improvement in anger control and progress through the provocation hierarchy in treatment sessions thus received validation from ward staff observations of his behavior and by the judgment of his attending psychiatrist who arranged the transfer to a lower security hospital.

VI. SUMMARY

Anger control therapy is a cognitive-behavioral treatment. It aims to augment the regulation of anger that has become problematic in frequency, intensity, duration, and mode of expression. In its fullest form of intervention, it utilizes a "stress inoculation" approach, the heart of which involves therapist-guided, progressive exposure to provocations in the clinic and *in vivo*, in conjunction with which coping skills are modeled and rehearsed.

Training in self-monitoring, cognitive reframing, arousal reduction, and behavioral coping skills are the essential components of the treatment. Some clients require a preparatory phase for treatment engagement.

See Also the Following Articles

Arousal Training ■ Beck Therapy Approach ■ Multimodal Behavior Therapy ■ Post-Traumatic Stress Disorder

Further Reading

- Beck, A. T. (1999). *Prisoners of hate: The cognitive basis of anger, hostility, and violence*. New York: Harper Collins.
- Beck, R., & Fernandez, E. (1998). Cognitive behavior therapy in the treatment of anger: A meta-analysis. *Cognitive Therapy and Research*, 22, 63–75.
- Berkowitz, L. (1993). *Aggression: Its causes, consequences, and control*. New York: McGraw-Hill.
- Chemtob, C. M., Novaco, R. W., Hamada, R., & Gross, D. (1997). Cognitive-behavioral treatment for severe anger in posttraumatic stress disorder. *Journal of Consulting and Clinical Psychology*, 65, 184–189.
- Feindler, E. L., & Ecton, R. B. (1986). *Adolescent anger control: Cognitive therapy techniques*. New York: Pergamon Press.
- Huesmann, L. R. (1998). The role of social information processing and cognitive schema in the acquisition and maintenance of habitual aggressive behavior. In R. Geen & E. Donnerstein (Eds.), *Human aggression: Theories, research, and implications for social policy* (pp. 73–109). San Diego, CA: Academic Press.
- Lang, P. J. (1995). The emotion probe: Studies of motivation and attention. *American Psychologist*, 50, 372–385.
- Lazarus, R. S. (1991). *Emotion and adaptation*. Oxford: Oxford University Press.
- Meichenbaum, D. (1985). *Stress inoculation training*. New York: Pergamon Press.
- Novaco, R. W. (1986). Anger as a clinical and social problem. In R. Blanchard & C. Blanchard (Eds.), *Advances in the study of aggression, Vol 2*. (pp. 1–67). New York: Academic Press.
- Novaco, R. W. (1997). Remediating anger and aggression with violent offenders. *Legal and Criminological Psychology*, 2, 77–88.
- Novaco, R. W., & Chemtob, C. M. (1998). Anger and trauma: Conceptualization, assessment, and treatment. In V. M. Follette, J. I. Ruzek, & F. R. Abueg (Eds.), *Cognitive behavioral therapies for trauma* (pp. 162–190). New York: Guilford.
- Siegan, A. W., & Smith, T. W. (1994). *Anger, hostility, and the heart*. Hillsdale, NJ: Erlbaum.

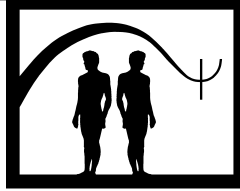

Animal-Assisted Therapy

Aubrey H. Fine

California State Polytechnic University

- I. Description of Treatment
 - II. Theoretical Bases
 - III. Empirical Studies
 - IV. Suggestions for Clinical Application
 - V. Summary
- Further Reading

GLOSSARY

animal-assisted activities Therapy that involves animals visiting people for motivational and recreational benefits to enhance quality of life. The same activity can be repeated by the facilitator with the same or different people, unlike the therapeutic intervention that is tailored to the specific person.

animal-assisted therapy A goal-oriented intervention in which an animal meeting specific criteria is an integral part of the treatment process. This service is delivered by a health or human service professional working within the scope of his or her professional role.

I. DESCRIPTION OF TREATMENT

Louis Sabin once stated that “No matter how little money and how few possessions you own, having a dog makes you rich.” Being rich should not only encompass physical resources, but also the joy and love from being wanted and appreciated. Animals appear to demonstrate great compassion for others and enhance the quality of life of their human counterparts.

Florence Nightingale in *Notes on Nursing* stated that a small pet animal was an excellent companion for the sick. Her impressions in the mid-nineteenth century seemed to accurately represent how animals could be supportive to the physical and mental health of individuals. Her position represents the impressions of various health care professionals over the past century and a half. Nevertheless, it has been the seminal work of Boris Levinson which many have considered to provide one of the earliest published papers highlighting the therapeutic value of animals. Levinson’s first article was entitled “The Dog as a Co-Therapist” and was published in *Mental Hygiene* in 1962. His initial article was met with cynicism and skepticism by many of his colleagues. However, Levinson genuinely believed that animals could make a major contribution to the therapeutic process.

Although some strides have been made in developing concepts in animal–human relationships, there continues to be limited empirical support and limited research validating the overall effectiveness of this approach. Many researchers point out that although the utilization of animals may be highly appealing, the evidence that a patient has enjoyed an interaction with an animal does not imply that the procedure is therapeutic. It appears that the biggest challenge facing advocates of animal-assisted therapy who claim that it improves outcomes is the need for documentation. The author in a previous writing suggested that a concentrated stronger effort is needed in promoting more sound empirical investigations demonstrating

the therapeutic utility of animals in various clinical settings. He suggested that the investigators may want to study what populations animal-assisted therapy (AAT) are effective with and under what conditions animal-assisted activities (AAA) or AAT are the most valuable. Furthermore, practitioners must pay attention to the need for program evaluation and documentation. These efforts will assist the scientific community with the needed research priorities.

In September 1987, the National Institutes of Health held a workshop entitled Health Benefits of Pets. Data from the proceedings highlighted some scientific evidence that pet ownership appeared to correlate with improvements in quality of life. Results from the meeting also pointed out that attachments to animals might also be an important dimension in studying those who have experienced or are experiencing reduced social contacts with people (e.g., the elderly and isolated children). These meetings appeared to act as a catalyst for the development of numerous animal visiting programs (sponsored by the various humane societies) for residents in long-term facilities. These early programs were considered pleasant diversionary activities. They were welcomed by administrators as long as the program didn't pose any risks to patient health and safety.

It appears that the greatest benefit an animal brings to a therapeutic setting is its ability to enhance the relationship between therapist and client. Its presence seems to make the client more comfortable and at ease. Phil Arkow suggested that the animal may act as a catalyst for the conversation between the therapist and the client. He called this process a rippling effect. Others, such as Samuel Corson and Elizabeth Corson, call this process a social lubricant. The presence of the animal allows the client a sense of comfort, which then promotes rapport in the therapeutic relationship. Studies reported in the literature point out that a therapist who conducts therapy with an animal being present may appear less threatening, and, consequently, the client may be more willing to reveal him/herself. Some clinicians report that in interviews in the presence of their dogs, children appeared more relaxed and seemed more cooperative during their visit. The findings appear to conclude that the dogs serve to reduce the initial tension and assisted in developing an atmosphere of warmth. The animals appear to help many clients overcome their anxiety about going into therapy. Many therapy animals, especially dogs, are more than willing to receive a client in a warm and affectionate manner.

The author in his application of AAT in his work with children has also found that his clients seemed to benefit from the observations seen between the animal and the therapist. The most common response pertains to the interaction with the animals and how some clients compare these interactions with their own child/parent relationships (since most of his clients are children and their parents). Other clients comment on how well the animals are treated, including the elements of compassion, consistency, firmness, and love. These vicarious observations can be utilized for the purposes of teaching skills and vicarious learning.

A. The Therapeutic Environment— Animals as an Aspect of Milieu Therapy

One of the most valued aspects of having animals as part of a therapeutic alliance appears to be related to their impact on altering the therapeutic environment. This assumption has been strongly advocated by this writer in numerous previous publications. The assumption has also been supported by Alan Beck who also believed that animals seemed to have the capacity to modify a person's environment. In most cases, presence of an animal appears to modify the perceived environment and make it more friendly and comfortable to incoming clients. Herbert Sklar suggests that development of an effective therapeutic alliance may actually begin with the creation of a proper therapeutic environment. It appears that the client's readiness for psychotherapy could be disturbed by the simplicity of a clinic's decor and perhaps by its disorder.

It seems obvious that living beings could also be utilized to complement the work environment by making it more appealing and relaxing. Of utmost value is that animals appear to bring a certain sense of security and warmth into the environment. Alan Beck and his associates conducted a study in Haverford, Pennsylvania, where they hypothesized that animals would alter the therapeutic environment and make it less threatening to patients with various mental illnesses. The patients (who met in a room containing birds) attended sessions more faithfully and became more active participants in comparison to a control group. In addition, the researchers found a reduction in hostility scores (from the Brief Psychiatric Rating Scale) in the clients within the experimental milieu.

A variety of researchers have looked at animals and their apparent impact on reducing stress in an

environment. For example, Aaron Katcher, Arline Segal, and Alan Beck reported, in their study on anxiety and discomfort before and during dental surgery, that subjects viewing the aquarium appeared more comfortable and less anxious than those subjects in a control group not viewing an aquarium. Watching a school of fish can be quite relaxing for some. With proper lighting and an attractively designed tank, clients can feel more at ease when they enter an office or while in therapy.

B. Incorporating Theory in Practice: Animal-Assisted Therapy from a Life Stage Perspective

A clinician's theoretical orientation will have a strong bearing on the incorporation of animals within his or her therapeutic approach. An explanation that seems to naturally align itself is Erikson's theoretical orientation. Erikson views development as a passage through a series of psychosocial stages, each with its particular goals, concerns, and needs. Although the themes may repeat during a life cycle, Erikson noted that certain life concerns were more relevant during specific eras. For example, as people age and experience new situations, they confront a series of psychosocial challenges. Aubrey Fine, in an article written on AAT in psychotherapy in the *Handbook on Animal Assisted Therapy*, recommended that clinicians should consider the various eight stages of psychosocial development and reflect on how the application of animals may be appropriate. Table 1 briefly highlights the major tenets presented.

Clinicians should consider extending the boundaries of where they perform their psychotherapy with their clients beyond the traditional office. Utilizing dogs as part of a therapeutic regime promotes taking walks. While walking, a therapist has an opportunity to deal with issues in a more comfortable and less threatening manner. Clinicians should become cognizant of their own communities and plan out routes that may have different purposes. For example, if privacy is strongly needed, the therapist should try to plan a walk that secures the most privacy and the fewest disruptions. Most routes should have a place where the clinician and client can stop and sit. This may be a point during a session where more attention to details is needed.

Clinicians applying AAT in their practices may also find the utilization of metaphors and stories incorporating animals as an appropriate extension. Clients in most cases should feel comfortable with these topics (since they are already being exposed to animals in the

TABLE 1
Animal-Assisted Therapy from a Life-Stage Perspective

Suggested developmental goals and treatment purposes for children

Suggestion 1. Within the first series of life stages, the primary goals to be achieved pertain to a child's need to feel loved, as well as developing a sense of industry and competence. In a practical sense, animals can assist the clinician in promoting unconditional acceptance. The animal's presence in therapy (as discussed previously) may assist a child in learning to trust. Furthermore, the animal may also help the clinician demonstrate to the child that he is worth loving.

Suggestion 2. The animal-assisted therapy can eventually go beyond the office visit. A clinician may suggest to a family the value of having a pet within the home. The animal may help a child develop a sense of responsibility as well as importance in life.

Suggested developmental goals and treatment purposes for adolescence

Suggestion 1. A clinician may find an animal's presence valuable in making the teen feel more at ease during his or her visit. The teen may be more willing to take down some of the barriers, if she or he feels more comfortable. Furthermore, although a teen may project the need to be adult-like, the teen may appreciate the free spirit of an animal. The comfort the youth may receive may allow him or her to feel more appreciated.

Suggested developmental goals and treatment purposes for adults

Suggestion 1. A therapist may use a therapy animal as a starting point to discuss decisions about having children or, for that matter, child-rearing practices.

Suggestion 2. Adults experiencing parenting challenges and couples who are experiencing marital dysfunction may find the metaphors and the stories related to bringing up children and learning to share one's life with another person as all appropriate topics. The presence of animals, and examples incorporating animals, may give some clarity to the subject of generativity versus self-absorption.

Suggested developmental goals and treatment purposes for the elderly

Suggestion 1. Clients who have had a history of animals within their lives may find the animal's presence extremely advantageous in reminiscing about past life events. A clinician may ascertain that the presence of the animal may act as a catalyst for reliving past events.

Suggestion 2. The clinician may also recommend to elderly patients that they consider purchasing a pet. A client's sense of value could be tremendously enhanced as a consequence of feeling needed once again.

therapeutic environment). Stories portraying the challenges, obstacles, and successes that animals experience and overcome may be applied therapeutically to help clients see the world or the struggles they face from a different perspective.

II. THEORETICAL BASES

Although not directly related to psychotherapy, the following research will provide further insight into the value of the animal–human bond. Mental health professionals may find this information useful in developing a clearer perception of the impact of animals in the lives of people. Over the past 30 years there have been several controlled studies documenting the correlation of pet ownership and cardiovascular health. Erika Friedman and her associates designed a study investigating pet ownership with survival rates among patients who were hospitalized for heart attacks, myocardial infarctions, or severe chest pains. The results illustrated a significant difference in life expectancy between the subjects who did have a pet versus those who did not. The results pointed out that 5.7% of the 53 pet owners compared with 28.2% of the 39 patients who did not own pets died within one year of discharge from a coronary care unit. The findings within this study have been replicated with similar findings in a few other studies. This assumption was also noted by James Serpell, a leading authority on animal–human relations, who detected that seniors who adopted pets appeared to experience a decreased frequency of minor health problems. These minor health problems included headaches, painful joints, hay fever, difficulty paying attention, colds and the flu, dizziness, kidney and bladder problems, as well as a mirage of other mild illnesses. He suggested that the associated physiological benefits could have been the result of increased physical activity.

On the other hand, there have been numerous studies investigating the psychosocial benefits of pet ownership. Conclusions from a vast majority of these studies point out that pet ownership or interaction with animals in therapeutic settings should be viewed with the interaction of many other social influences. Those individuals who live highly stressed lives (families in poverty or dislocation) may benefit more from social supports, including support from animals.

Companion animals provide numerous benefits to the emotional well-being of humans. Animals at times take on numerous roles where there may be a void in

an individual's life, including functioning as a friend and a confidant. Animals comfort their companions and apparently serve as a buffer of protection against adversity. Companion animals also appear to satisfy the numerous psychosocial needs of their human counterparts, including enhancing social stimulation, as well as providing an outlet for leisure opportunities. Reports in the psychological literature suggest that unobtrusive animals evoke social approaches and conversations from unfamiliar adults and children. Presence of an animal may become a social lubricant for spontaneous discussions with passing strangers. The dog usually helps break the ice and makes it easier to initiate casual discussion. In most cases, the topics initially begin around the animal's presence.

A. Companion Animals and Children

Brenda Bryant reports that animal companions have been found to provide important social support for children. She also reports that animals within a home may assist children in developing a greater sense of empathy for others, and may enhance a child's self-esteem and social skills.

Bryant surveyed 213 children and identified four potential psychological benefits of animals for children. In 1990 she utilized the "My Pet Inventory" to assess the subjects' interests. A factor analysis of Furman's inventory indicated that, from a child's perspective, there are four factors in which the child–pet relationship can be viewed as potentially beneficial. Bryant defined the factor of mutuality as having to do with the experience of both giving and receiving care and support for the animal. The enduring affection factor identifies the child's perception of the lasting quality of his or her relationship with the pet. This factor focuses on the permanence of the emotional bond between the child and the animal. Enhanced affection, the third factor, identifies the child's perception that the child–pet relationship makes him or her feel good as well as important. Finally, the factor of exclusivity focuses on the child's internal confidence in the pet as a confidant. This factor appears to be extremely crucial for therapists to underscore. It is within this factor that a child may rely on the pet companion to share private feelings and secrets. This may be an important outlet, especially when there are limited friends and supports within the community or the home. There is evidence reported that a child may also use an animal as a confidant. This appears to be an obvious alternative that some children may confide in their animals for social support. Many parents

and clinicians over the years have remarked that they have observed children utilizing a family pet as a sounding board or as a safe haven to discuss their problems and troubles.

B. Therapeutic Benefits of Companion Animals for the Chronically and Terminally Ill, Persons with Disabilities, and the Elderly

Over the years, some reported studies have found that pet ownership appears to decrease depression and improve a healthier morale state. There have been studies indicating that war veterans found pet ownership to be associated with improved morale. Furthermore, Lynette Hart and her associates have reported that service animals appear to stimulate conversations and interactions between the people who used the service animals and those who were just walking by. People with the assistance animals noted that their dogs created social opportunities with people. The dog appears to normalize the environment for the person with a disability and to act as a catalyst for a discussion.

A benchmark study conducted by Roger Mugford on the therapeutic value of pets for the elderly found that older people (who live independently) who were given a budgerigar had significantly improved social attitudes and appeared to be happier than those subjects who were in the control group (after five months). Furthermore, animals living within the home of people with terminal illnesses or animals visiting those with similar constraints appear to lessen the individual's fears, their sense of loneliness, and stress levels. Similar findings have been reported in studies evaluating the impact of an animal on the lives of people with terminal illnesses such as cancer and AIDS. A synthesis from these studies suggests that these individuals seemed to feel more in control of their lives when they were able to take care of an animal. Taking care of the animal and being able to hold and caress it seemed to cause them to focus less on their illness.

Companion animals tend to help people use their own strengths to help themselves and to be sensitive to other people's feelings and emotions, and therefore recognize those occasions when they are needed or wanted. Animals can act as human surrogates in a number of roles, including friends and confidants. In times when people are secluded in their homes, the companionship of animals is extremely meaningful. They act as true friends.

Keith Cherry and David Smith suggest that persons with AIDS are especially susceptible to loneliness. Statistics point out that a high portion of patients with AIDS have diminished social support from friends, family, and significant others. Therefore, it appears that the pets owned by these individuals can act as important social supports. Programs such as Pets are Wonderful Support (PAWS) have been developed to help persons with AIDS keep their pets as long as possible. The PAWS model recognizes the importance of the companion animal in the quality of life of his or her human counterpart. This model appears to be applicable to any other special population living independently.

III. EMPIRICAL STUDIES

Animal-assisted activities and AAT are most widely incorporated in institutional settings and large mental health organizations. Historically, these services have been facilitated by mental health professionals in addition to nursing and other allied health specialists. In most cases, these services have been applied in long-term care facilities for the elderly, patients in hospitals, children in a variety of therapeutic settings, and inmates in prisons.

Research reports the tremendous value in developing an animal visiting program (or even having an animal living in residence) in facilities serving the elderly. In most studies reviewed, the authors stressed that the residents in most nursing homes appeared eager for the weekly AAT program. In some cases, residents kept track of the calendar in anticipation of interaction with the animals. Several studies investigating the impact of AAA or AAT on the elderly have concluded that the therapy (1) appears to have a positive impact on enhancing attention span; (2) is instrumental in positively enhancing elements of quality of life and well-being; and (3) appears to be effective in decreasing levels of depression among many residents as well as enhancing socialization and communication opportunities between the residents.

Most research studies investigating AAA or AAT in hospital settings have acknowledged similar outcomes to those originally noted with the elderly. The conclusions suggest that the animal-based programs appear to be a good distraction for the patients from their everyday medical treatment in the hospital. The services also appeared to have a positive impact on health factors, including decreasing pain and hyperactivity, helping the patients feel calmer, as well as reducing high blood pressure.

In a very revealing study, David Lee documented the incredible positive outcomes identified for an AAT program initiated at the Lima State Hospital for the Criminally Insane. Lee reported that the wards with animals seemed to have a calming effect on the patients. There was also a noticeable reduction in the patients' violent acts and suicide attempts. Similar outcomes were found in the Washington State Correctional Center for Woman program, which found that inmates who were involved in the training of service dogs appeared to be less depressed and proud of their abilities in training the animal.

An ultimate concern in most medical settings is the health effects of the animals on the clients. This process is now known as "zoonoses." Philip Wishon reports that most cats and dogs carry human pathogens, which along with those carried by other animals have been associated with more than 150 zoonotic diseases. However, Linda Hines and Maureen Fredrickson of the Delta Society point out that the data regarding the transmission of zoonotic diseases in any AAT program have been minimal. Practitioners are advised to work closely with veterinarians and other public health specialists to ensure the safety of the animals as well as the clients involved.

IV. SUGGESTIONS FOR CLINICAL APPLICATION

A. Training and Liability

Therapists considering incorporating animals within their practice must seriously consider the factors of liability, training, as well as the safety and welfare of both the animal and the client. The Delta Society's Pet Partner Program strongly advocates that health care professionals have training in AAT and AAA techniques. Clinicians also need to be aware of best practice procedures ensuring quality and safety for all parties.

Gary Mallon and his associates, in a chapter in the *Handbook of Animal Assisted Therapy*, provided guidelines for developing and designing AAT programs. Within their chapter, the authors identified 20 principles that a practitioner should consider in developing an AAA or AAT program. The following briefly highlights some of the major points:

1. All animals must be screened for their temperament to make sure they are appropriate candidates.

Clinicians are encouraged to utilize the standards of practice guidelines suggested by the Delta Society. These standards highlight the need for reliability of the animal's behavior, as well as the predictability that the animal's behaviors will occur on a constant basis and that the animal can always be controlled or managed.

2. All animals incorporated in AAA or AAT must be permitted to rest and have breaks from their working schedule. Attention must also be given to the suitability of the animal to meet the specific goals prescribed by the practitioner for the specific session.

3. All clients should be interviewed to assess their comfort level with various animals, specific allergies, and, if relevant, past abusive behavior toward animals.

4. The AAA or AAT must be integrated into the client's comprehensive treatment plan.

5. The practitioner should utilize the animal to aid in mastering developmental tasks and to promote responsibility and feelings of self-worth as well as independence.

B. Animal Welfare

It is evident that the safety of one's patient should have the highest priority. Nevertheless, the therapist should and must consider the safety and welfare of all the animals used in therapeutic practice. To help identify principles for animal safety and welfare, the author has elected to incorporate some of the guidelines that were identified in the Appendix of a chapter written on ethical concerns by James Serpell, Raymond Copinger, and Aubrey Fine.

The following briefly identify the concerns noted:

1. All animals must be kept free from abuse, discomfort, and distress.

2. Proper health care for the animal must be provided at all times.

3. All animals should have a quiet place where they can have time away from their work activities.

4. Interactions with clients must be structured so as to maintain the animal's capacity to serve as a useful therapeutic agent.

5. Situations of abuse or stress for a therapy animal should never be allowed.

6. As an animal ages, his or her schedule for therapeutic involvement will have to be curtailed. Accommodations and plans must be considered. The transition into retirement may be emotionally difficult for the animal as well. Attention must also be given to this dimension.

V. SUMMARY

Animal-assisted therapy and AAA represent two dynamic approaches that may become valuable therapeutic strategies in the treatment of children and adults (in individual and group therapy, in both outpatient and institutional settings). Although there still exist limitations in investigating the efficacy of this treatment as well as understanding best practice strategies, practitioners should become more open-minded to the potential contributions animals may make to the physical and mental wellness of humans. Introduction of animals into a therapeutic environment may provide a calming effect that contributes to the therapeutic outcome. When animals are introduced with a well-thought-out plan, clinicians will not be disappointed with the outcome. Although not a panacea, the impact of the human animal bond should not be underestimated as a positive therapeutic alternative.

See Also the Following Articles

Alternatives to Psychotherapy ■ Bioethics ■ Parent–Child Interaction Therapy ■ Therapeutic Storytelling with Children and Adolescents

Further Reading

- Arkow, P. (1982). *Pet therapy: A study of the use of companion animals in selected therapies*. Humane Society of Pikes Peak Region, Colorado Springs, CO.
- Beck, A., Hunter, K., & Seraydarian, L. (1986). Use of animals in the rehabilitation of psychiatric inpatients. *Psychological Reports*, 58, 63–66.
- Beck, A., & Katcher, A. H. (1983). *Between pets and people: The importance of animal companionship*. New York: G.P. Putnam's Sons.
- Bryant, B. (1990). The richness of the child-pet relationship: A consideration of both benefits and costs of pets to children. *Anthrozoos*, 3, 253–261.
- Cherry, K., & Smith, D. (1993). Sometimes I cry: The experience of loneliness for men with AIDS. *Health Communications* 5, (3), 181–208.
- Corson, S. A. & Corson, E. O. (1980). Pet animals as nonverbal communication mediators in psychotherapy in institutional settings. In S. A. Corson & E. O. Corson (Eds.), *Ethology and nonverbal communication in mental health* (pp. 83–110). Oxford: Pergamon Press.
- Fine, A. H. (2000). Animals and therapists: Incorporating animals in outpatient psychotherapy. In A. Fine (Ed.), *Handbook on animal assisted therapy* (pp. 179–211). San Diego: Academic Press.
- Fredrickson, M., & Hines, L. (1998). Perspective on animal-assisted activities and therapy. In B. C. Turner & C. C. Wilson (Eds.), *Companion animals in human health* (pp. 23–39). Thousand Oaks: Sage Publications.
- Fredrickson, M., & Howie, A. (2000). Guidelines and standards for animal selection in animal-assisted activity and therapy programs. In A. Fine (Ed.), *Handbook on animal assisted therapy* (pp. 100–114). San Diego: Academic Press.
- Friedman, E., Katcher, A. H., Lynch, J. J., & Thomas, S. A. (1980). Animal companions and one-year survival of patients after discharge from a coronary care unit. *Public Health Reports*, 95, 301–312.
- Friedman, E., Katcher, A. H., Thomas, S., Lynch, J. J., & Mes-sant, P. (1983). Social Interaction and blood pressure: Influence of animal companions. *Journal of Nervous and Mental Disease*, 171, 461–465.
- Hart, L., Hart, B. & Begin, B. (1987). Socializing effects of service dogs for people with disabilities. *Anthrozoos*, 1, 41–44.
- Lee, D. (1984). Companion animals in institutions. In Arkow, P. (Ed). *Dynamic relationships in practice: Animals in the helping professions* (pp. 237–256). Alameda, CA: Latham Foundation.
- Levinson, B. M. (1962). The dog as a “co-therapist.” *Ment. Hyg.*, 46, 59–65.
- Mallon, G., Ross, S., & Ross, L. (2000). Designing and implementing animal assisted therapy programs in health and mental health organizations. In A. Fine (Ed.), *Handbook on animal assisted therapy* (pp. 115–127). San Diego: Academic Press.
- Mugford, R., & M'Cominsky, J. (1975). Some recent work on the psychotherapeutic value of cage birds with old people. In R. S. Anderson (Ed.), *Pet animals and society* (pp. 54–65). London: Bailliere-Tindall.
- Serpell, J., Coppinger, R., & Fine, A. (2000). The welfare of assistance and therapy animals: An ethical comment. In A. Fine (Ed.), *Handbook on animal assisted therapy* (pp. 415–430). San Diego: Academic Press.
- Sklar, H. (1988). The impact of the therapeutic environment. *Human Sciences Press*, 18(2), 107–123.
- Wishon, P. M. (1989). Disease and injury from companion animals. *Early Child Development and Care*, 46, 31–38.

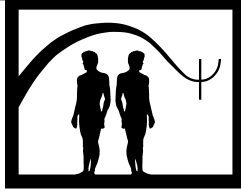

Anxiety Disorders: Brief Intensive Group Cognitive Behavior Therapy

Tian P. S. Oei and Genevieve Dingle

University of Queensland

- I. Development and Description of Treatment
- II. Theoretical Bases
- III. Empirical Studies
- IV. Summary
- Further Reading

I. DEVELOPMENT AND DESCRIPTION OF TREATMENT

Modern psychotherapy has its roots in Europe, and it was not until after the Second World War that the United States began to lead this field. During this period, psychotherapy flourished and grew at an enormous rate. Behavior therapy, and later cognitive behavior therapy (CBT), led the earlier growth and in 1974 when Michael Mahoney published his first book in cognitive behavior therapy, the term CBT became entrenched.

Accumulated empirical evidence shows that CBT is efficacious for the treatment of many psychological and psychiatric disorders, ranging from anxiety, to eating disorders and the psychoses. For many patients, it can be argued that CBT is the treatment of choice for these disorders. At the turn of the new millenium, CBT was generally accepted as an evidence-based psychotherapy that has benefited many people with mental health problems.

Although CBT can be delivered in individual or group settings, it is individual CBT that has received the most research and thus provides the most clear-cut support for its efficacy. The application of CBT to group work has a much later history than individual CBT, and accordingly the evidence-based research is not nearly

GLOSSARY

brief intensive group cognitive behavior therapy (BIGCBT)

A version of cognitive behavior therapy conducted in full-day sessions over a short time period (e.g., 3 consecutive days).

Brief intensive group cognitive behavior therapy (BIGCBT) is a version of cognitive behavior therapy conducted in full-day sessions over a short time period, for example, 3 consecutive days. This article presents the theoretical underpinnings and applications of BIGCBT, and a review of empirical studies showing the effectiveness of a BIGCBT program for outpatients with panic disorder with or without agoraphobia.

TABLE 1
**A Sample of the Brief Intensive Group CBT Program for Panic Disorder
 with and without Agoraphobia**

<i>Time</i>	<i>Day 1</i>	<i>Day 2</i>	<i>Day 3</i>
08:00	Registration		
09:00	Introduction to anxiety and phobias	Group cognitive behavior therapy	Drug therapy
10:30	Morning break	Morning break	Morning break
11:00	Anxiety and panic control	Breathing control control	Cognitive
12:30	Lunch	Lunch	Lunch
13:15	Planning	Planning	Planning
13:45	Relaxation	Relaxation	Relaxation
14:00	Exposure	Exposure	Exposure
16:00–17:00	Group work/consultation	Feedback	Positive thinking/ self-help. Closing.

Note: Adapted from Weir (2000). Health outcome of brief intensive group cognitive behavior therapy for anxiety disorders. Doctoral dissertation, University of Queensland, Brisbane, Australia.

as comprehensive. Since the success of individual and group CBT, researchers and clinicians have experimented with the delivery format of CBT. The format has ranged from brief to extended CBT. Brief CBT treatments comprise from one to four sessions, with a 1-hr session per week, while extended CBT treatments range from 30 to 52 weekly 1-hr sessions. The average length of time for individual CBT is about 10 weekly sessions, and the average length of group CBT is a weekly 2-hr session for 12 sessions. More recent, we introduced a BIGCBT intervention and demonstrated that it has efficacy in the treatment of anxiety and mood disorders.

The BIGCBT is delivered over 3 consecutive days, with an attendance of 8 hrs per day. Psychiatrist Larry Evans and psychologist Bevan Wiltshire initially started the BIGCBT in the early 1980s for the treatment of patients with anxiety disorders, in particular panic disorder with agoraphobia. In 1984, a group of psychologists, Tian Oei, Justin Kenardy, and Derek Weir, joined the group and further developed and evaluated the treatment package.

The BIGCBT was developed with the following principles in mind:

1. Self-help: We wanted patients to take an active role in the management of their disorders. We strongly encouraged them to do so by providing a rationale, actively teaching them self-help skills and encouraging them to experiment with solutions to their problems.

2. Problem versus sickness: We informed patients that to view their problems as a sickness did not promote their active role in the management of the problems, but could in fact hinder it.

3. Control versus cure: We emphasized that the main aim was for patients to take control of their anxiety and fear rather than to attempt to cure it forever. Being cured is a passive process that depends on someone doing something to you, whereas gaining control is an active process. We explained that control was a realistic and attainable goal. Gaining control of anxiety and fear would enable patients to take charge and learn how to help themselves. In addition to learning what techniques to use and how to use them, patients also need to understand why they are using these techniques.

BIGCBT was delivered in a group format with the aim of making the program more cost effective. Referrals were made by the patients' medical officers. Group sizes averaged 8 participants. The group format provided a structured setting in which to learn the skills delivered by the program. It also provided social support, and a more socially relevant context for behavioral and attitudinal change and reinforcement than would an individual CBT context.

A team of experienced clinicians delivered BIGCBT, including psychiatrists, psychologists, and nurses. It was ensured that all clinicians had a good grounding of CBT and had observed the whole BIGCBT program before taking responsibility for the delivery of group sessions.

No one clinician delivered the entire BIGCBT program. Clinicians were allocated to a session or sessions of the BIGCBT program based on interest, knowledge, and time availability.

An example of the 3-day program with the contents of each session is presented in Table 1. There were three blocks of exposure sessions, taken by at least two clinicians. When group membership was greater than eight, three or more clinicians were used. Fellow clinicians were encouraged to "sit in on" other sessions in order to provide feedback and peer support to the therapist. The participation of Dr. Evans in every program provided stability, consistency, and quality assurance for the program.

II. THEORETICAL BASES

The theoretical basis of the BIGCBT was derived from the cognitive behavioral framework and encompassed the elements of clinical assessment and diagnosis, psychoeducation of cognitive and behavioral skill components, exposure, relaxation training, and homework assignments. The Quality Assurance Project of the Royal Australian and New Zealand College of Psychiatrists treatment guidelines also contributed to the design of the BIGCBT.

III. EMPIRICAL STUDIES

BIGCBT was run at a community outpatient clinic. Therefore, evaluation of the intervention used an effectiveness approach rather than an efficacy approach. Oei and colleagues' previous publications address a diversity of topics, including the development of new instruments to measure catastrophic cognitions; the validation of outcome measures such as the fear questionnaire (FQ); psychopathology of panic attacks and panic disorders; and treatment effectiveness. In 1991, Evans, Craig Holt, and Oei reported the first long-term follow-up data using the BIGCBT. They found that at posttreatment, BIGCBT was significantly better than the no treatment waiting-list control on the outcome measures of the FQ and the fear survey schedule (FSS). However, there was no difference in the scores for the Maudsley personality inventory (MPI) and the hostility and direction of hostility questionnaire (HDHQ), suggesting that neither of these personality variables was affected by the BIGCBT treatment. One-year follow-up results showed that treatment gains were maintained. Clinical interview data confirmed the FQ and FSS self-report data by demon-

strating that at one year follow-up, 85% of the patients treated with BIGCBT were either symptom free or had significant symptom reduction. The finding that personality variables were not changed by the BIGCBT treatment was supported by a study by Clair, Oei, and Evans in 1992, using the same measures with the addition of the Fundamental Interpersonal Relations Orientation-Behavior Scale (FIRO-B). This 1992 study showed that personality variables derived from the previously mentioned three instruments were no different between patients who responded and did not respond to the BIGCBT treatment. Similar to previous findings, personality characteristics did not predict treatment outcome.

A study by Weir in 2000, supervised by Evans and Oei, compared 71 waiting-list control patients with 206 patients with anxiety disorders, on clinical and functional outcome measures. Clinical outcome measures used were self-report scales such as FQ, MPI, FSS, the State Trait Anxiety Inventory (STAI) and the HDHQ. Clinician-rated measures such as Hamilton Anxiety Rating Scale (HAM-A) and Hamilton Depression Rating Scale (HAM-D) were also used. The functional outcome measures were the Medical Outcome Study Short Form Health Survey (SF 36), the Quality of Life Inventory (QOLI) and the Health Schedule Utilization (HSU). Pre- to posttreatment comparison between the BIGCBT and control groups showed that the BIGCBT group made significant improvements when compared to the control group, on all the clinical outcome measures. The reported effect sizes for the BIGCBT group ranged from large (HAM-A = 1.24; HAM-D = .99) to small (STAI = .22). There was a small but significant effect size for the change in MPI and HDHQ scores. This personality change was not consistent with the earlier studies.

An important part of Weir's study is that it reported on 6-year follow-up results. The results showed that the treatment gains made by BIGCBT patients were maintained over the long term. The findings also showed that most of the gains were made at posttreatment, and that the length of time of follow-up (ranging from 1 to 6 years) did not improve the posttreatment gains.

The most interesting finding from the Weir study was in regard to the functional outcome measures. The results from the SF-36 showed that up to 6 years after the BIGCBT treatment, the SF-36 profiles of the treated group were almost the same as those of the general population, and much better than the SF-36 profiles of people with anxiety disorder problems in the national survey. This implies that long after treatment, the patients with anxiety disorder who were treated with the

BIGCBT can expect to have almost the same general health perception as the general population. This finding was complemented by the results of the QOLI that indicated that patients treated with BIGCBT were relatively free of psychological distress and had a more realistic expectation of their living conditions.

The long-term effectiveness of BIGCBT was also reported in a 1997 study conducted by Oei and Evans with Michael Llamas. This study investigated the possible impact of concurrent medication use on the long-term outcome of BIGCBT for panic disorder with or without agoraphobia. The researchers found that preexisting medication (antianxiety, antidepressant, or a combination of these) did not significantly enhance or detract from the long-term outcome of the BIGCBT program.

The BIGCBT has also been applied to the treatment of patients with comorbid alcohol use disorder and panic disorder with or without agoraphobia. The 2000 report by Bialkowska, supervised by Oei and Evans, documented that concurrent addition of the BIGCBT for panic disorder to the standard hospital treatment for alcohol abuse produced better clinical outcomes than the standard hospital treatment and a placebo treatment. It was found that BIGCBT had an impact on self-reported anxiety but not on alcohol outcome measures.

IV. SUMMARY

There is enough evidence to suggest that the BIGCBT is an effective treatment for anxiety disorders, in particular for panic disorder with and without agoraphobia. The exact mechanism for the effectiveness of this treatment is still unknown. Furthermore, the effectiveness of the BIGCBT is demonstrated by a single group of researchers in one place and needs to be replicated by different researchers and in different locations before anything more substantial can be said about the general clinical utility of the BIGCBT. What can be said with some degree of confidence, however, is that our findings add to the robustness of the delivery of CBT in the treatment of psychological disorders.

See Also the Following Articles

Cognitive Behavior Therapy ■ Cognitive Behavior Group Therapy ■ Panic Disorder and Agoraphobia

Further Reading

- Bialkowska, G. (2000). *The efficacy of a brief intensive group cognitive behavior therapy for panic disorder and comorbid alcohol dependent patients*, Master's thesis, University of Queensland, Brisbane, Australia.
- Clair, A., Oei, T. P. S., & Evans, L. (1992). Personality and treatment response in agoraphobia with panic attacks. *Comprehensive Psychiatry*, 33, 310–318.
- Evans, L., Holt, C., & Oei, T. P. S. (1991). Long term follow up of agoraphobics treated by brief intensive group cognitive behavior therapy. *Aust New Zealand Journal Psychiatry*, 25, 343–349.
- Kenardy, J., Evans, L., & Oei, T. P. S. (1992). The latent structure of anxiety symptoms in anxiety disorders. *American Journal of Psychiatry*, 149, 1058–1061.
- Khawaja, N., Oei, T. P. S., & Baglioni, A. (1994). Modification of the Catastrophic Cognitions Questionnaire (CCQ-M) for normals and patients: Exploratory and LISREL analyses. *Journal of Psychopathology and Behavioral Assessment*, 16, 325–342.
- Mahoney, M. J. (1974). *Cognition and behavior modification*. Cambridge, MA: Ballinger.
- Oei, T. P. S. (1999). *A group Cognitive Behavior Therapy program for anxiety, fear and phobias: A Therapists Manual*, CBT Unit, Brisbane.
- Oei, T. P. S., Llamas, M., & Develly, G., (1999). Cognitive changes and the efficacy of CBT with panic disorders with agoraphobia. *Behavioral and Cognitive Psychotherapy*, 27, 63–88.
- Oei, T. P. S., Llamas, M., & Evans, L. (1997). Does concurrent drug intake affect the long-term outcome of group cognitive behavior therapy in panic disorder with or without agoraphobia? *Behaviour Research and Therapy*, 35, 851–857.
- Oei, T. P. S., Moylan, A., & Evans, L. (1991). Clinical utility and validity of the Fear Questionnaire. *Psychological Assessment*, 3, 391–397.
- Weir, D. (2000). *Health outcome of brief intensive group cognitive behavior therapy for anxiety disorders*. Doctoral dissertation, University of Queensland, Brisbane, Australia.

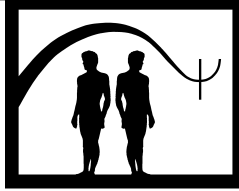

Anxiety Management Training

Richard M. Suinn and Jerry L. Deffenbacher

Colorado State University

- I. Description of Treatment
 - II. Case Illustration
 - III. Theoretical Basis
 - IV. Applications and Exclusions
 - V. Empirical Studies
 - VI. Summary
- Further Reading

GLOSSARY

AMT Acronym for anxiety management training.

anxiety management training A self-control intervention using relaxation as a coping skill to prevent or reduce anxiety arousal.

anxiety scene A concrete event from the client's actual experience associated with anxiety being aroused.

biofeedback Methods for relaxation training that employ equipment to monitor and provide feedback on physiological responses, such as changes in muscle tension or finger temperature.

early warning signs Internal cues such as tension in shoulders, upset stomach, or specific thoughts that indicate the onset or early stages of anxiety arousal. AMT trains clients to attend to these cues and initiate relaxation coping skills to abort anxiety or stress arousal.

progressive or deep muscle relaxation A method of relaxation training that has clients systematically tense and release the muscles of the body.

relaxation scene A concrete event from the client's actual experience that is associated with being relaxed.

relaxation training The process of developing a basic relaxation response, usually done through biofeedback or deep muscle relaxation.

I. DESCRIPTION OF TREATMENT

Anxiety management training (AMT) typically takes six to eight sessions after an assessment suggests that a self-managed relaxation approach is appropriate. It may take a few sessions longer if other emotions (e.g., anger) or psychophysiological disorders (e.g., tension or migraine headaches) are added to anxiety treatment goals. AMT can be conducted with individuals or in small groups.

The core characteristics of AMT include guided imagery, anxiety arousal, application of relaxation for self-managed anxiety reduction, and transfer of relaxation coping skills to the external environment. Guided imagery involves the introduction of relaxation imagery to strengthen the relaxation response, and it also includes anxiety imagery to precipitate anxiety arousal. Anxiety is precipitated during sessions in order to provide clients with the opportunity to become more aware of their anxiety arousal and to identify the early warning cues and employ relaxation that will reduce the actual experiences of anxiety. Thus, clients first practice controlling anxiety in the safe setting of therapy prior to real-life applications for anxiety reduction. As clients gain in self-control of anxiety over the course of AMT, the anxiety-arousing capacity of anxiety scenes is increased and the degree of therapist assistance in relaxation retrieval is decreased. Homework assignments to apply relaxation in specific situations and at any time anxiety is experienced are used to ensure the transfer of skills to in vivo application.

AMT is easily adapted to other distressing emotions and to physiological conditions associated with stress. For example, in applying AMT to anger, the training procedures remain the same, but the content of the scenes and homework focus on these emotions rather than on anxiety. In adapting AMT to tension headaches, stress-inducing scenes may be broader than anxiety, for other emotions may trigger tension headaches. Clients can also identify the early warning signs of headaches and apply relaxation skills when these cues are perceived.

A. Session 1

Session 1 is devoted primarily to deep muscle relaxation, whereby muscles are first tensed and then relaxed. An emphasis on awareness of tension is added by instructing clients to pay attention to feelings of muscle tension and to notice the contrast between the tensed and relaxed sensations. For most clients identifying a relaxation scene is useful for furthering control of relaxation. Such a scene should be a real-life event involving a specific relaxing moment from the client's life. The client and therapist develop this scene prior to initiating progressive relaxation. After deep muscle relaxation, the client is instructed to visualize the relaxation scene and to permit that experience to further increase the relaxation level. Progressive relaxation and relaxation scene visualization typically take about 30 minutes. Homework involves daily practice of progressive relaxation, self-monitoring and recording anxiety arousal, and the identification of one or two moderate anxiety scenes to be used in the next session.

B. Session 2

This session involves the development of an anxiety scene, inducing relaxation, and one or more trials of anxiety arousal followed by relaxation retrieval. The anxiety scene should be a real experience that elicits a moderately high level of anxiety (about 60 on a scale where 100 is extreme anxiety). Following determination of an anxiety scene, relaxation is introduced. Typically, clients will be able to become relaxed not by tensing muscles, by simply focusing on and relaxing each muscle group. When the client is relaxed, anxiety arousal is initiated through the therapist's instructions to switch on the anxiety scene, to use the scene to re-experience anxiety, and to signal the onset of this anxiety. The therapist includes both scene-setting and anxiety-arousal details from the scene and uses appropriate voice emphasis (e.g., volume and tone) to aid in anxiety arousal. After about 10 to 15 seconds of anxiety

exposure—that is, after the client signals anxiety—the anxiety scene is terminated, and the therapist reintroduces relaxation, first by visualization of the relaxation scene and then by a review of the muscles without tension. As time allows, this process is repeated, with the anxiety exposure interval lengthened to 20 to 30 seconds. Homework involves continued self-monitoring of anxiety, daily practice of relaxation without tension, and application of relaxation in nonstressful situations.

C. Session 3

This session follows the steps outlined in Session 2, with two major additions. Self-initiated relaxation and attention to the anxiety-arousal symptoms are prompted, so that clients can identify personal signs associated with anxiety. These might involve symptoms such as clenched fists, heightened respiration, feelings of panic, thoughts of self-doubt, images of great inadequacy, and the like. By training clients in becoming aware of the signs of anxiety and using their presence to initiate relaxation, AMT teaches clients not only how to reduce anxiety when it is experienced, but also to identify the early anxiety cues in order to prevent further anxiety buildup.

By this session the client should be able to achieve a relaxed state in a brief time, typically in one to three minutes. After the client has relaxed, the therapist initiates anxiety arousal by having the client visualize the 60-level scene. When the client signals anxiety, the therapist introduces the new instructions for attending to anxiety symptoms: "Pay attention to how you experience anxiety; perhaps it is in your body signs such as tension in your neck muscles, tightness across your stomach, or your heart rate or maybe in some of your thoughts." After about 30 seconds of anxiety arousal, relaxation is retrieved, with the therapist guiding the client through muscle reviews, relaxation imagery, or deep breathing-based relaxation. This process is repeated, usually three to five times, until the end of the session. Homework involves identifying a 90-level scene for the next session and using relaxation coping skills to control anxiety wherever it is experienced. Efforts are recorded in the self-monitoring log.

D. Session 4

In this session, a 90-level scene is developed. Use of the 90-level scene provides the client with the opportunity to cope with high levels of anxiety arousal. In addition, the client starts to assume more responsibility for controlling anxiety. Instead of the therapist terminating the anxiety scene and reinitiating relaxation, the

client initiates relaxation by using the relaxation scene, a muscle review, deep breathing-cued relaxation, or whatever method personally works best. The 60- and 90-level scenes are alternated to provide practice in anxiety management. Homework involves the self-monitoring of early warning signs of anxiety and the immediate application of relaxation to abort arousal any time anxiety is experienced. Clients are alerted to do this any time they encounter situations known to be anxiety arousing. Clients are also encouraged to routinely monitor anxiety signs four times a day (i.e., once in the morning, midday, afternoon, and evening). All efforts to monitor anxiety signs and apply relaxation are recorded in the client's self-monitoring log.

E. Session 5

In Session 5, the 60-level scene is often dropped and replaced with a higher level anxiety scene. This session also completes the fading out of therapist control and the completion of client self-control. Following client self-initiated relaxation, the therapist switches on the anxiety scene, but all activities from that point on are client-controlled. While in the anxiety scene the client initiates relaxation to deactivate arousal and decides when to terminate the scene. After signaling the therapist that this has occurred, the therapist readies the client for another scene and the process is repeated. Homework is the same as suggested in Session 4.

F. Sessions 6–8

With the exception of the introduction of new high level anxiety scenes, the same format used in Session 5 is used in Sessions 6–8. Moreover, application to other sources of distress is also encouraged. Length of time between sessions may be increased in order to provide more opportunities for application and to facilitate transfer and maintenance. Plans for maintenance and relapse prevention are discussed during these sessions as well. When self-control of anxiety is established, usually by Session 8 termination is initiated, or AMT is integrated with other interventions. Booster sessions may sometimes be employed prior to clients confronting future events to facilitate relapse prevention.

II. CASE ILLUSTRATION

Patient Characteristics. This case illustrates the basic AMT approach, with some modifications for the characteristics of the specific client. Jane, a 37-year-old married

mother of two teenagers, worked as a project manager for a computer company. She was diagnosed with generalized anxiety disorder (GAD). She also sought help regarding tension headaches and problems involving experiencing anger while driving. During intake, she reported being anxious and tense most of the time. Anxious feelings were marked by a general sense of unease and foreboding and by heightened general physiological arousal and agitation, a feeling of being jumpy and on edge, marked tension in the neck, shoulders, forehead, and hands, and a knot in her stomach, sometimes accompanied by nausea and stomach upset. She reported that the anxiety seemed to accumulate during the day, becoming worse in the afternoon and evening. She also reported moderately severe tension headaches on a nearly daily basis, headaches that were related to her chronic anxiety. In the past, her physician had prescribed benzodiazapines for this anxiety, and she currently took Valium approximately three times a week. She reported frequent periods of “stewing” (unrealistic worry) needlessly about several topics: (1) work performance (e.g., that she would fail and be fired, even though she had good to excellent performance reviews for several years; or that projects would not be completed or would be totally inadequate, even though this had not happened in the past); (2) the health and safety of her husband and children (e.g., continued preoccupation with a mole on her husband's neck, even though it had been checked by his family physician and a dermatologist; and frequent images that her husband or children had been killed or hurt in a car accident); and (3) finances (e.g., being worried that they would not be able to send their children to college, even though she and her husband had good, secure jobs). She indicated that the worry and anxiety led to such great weariness and fatigue that she often went to bed early or watched television to escape the anxiety, worry, and headaches. She also experienced frequent intense episodes of anger in her 40-minute commute to and from work. She indicated that this anger carried over into and influenced her work negatively and was another source of stress that contributed to her fatigue and headaches.

She was seen for two sessions for assessment involving interviewing, self-monitoring anxiety and tension headaches, and completion of psychometric instruments. AMT sessions are described next and are numbered to follow the outline presented earlier.

Initial portions of AMT Session 1 involved the therapist presenting the rationale for using AMT in the following way:

Rationale: Jane, it seems like the primary issues are the cycles of worrying and anxiety where you get tense

all over, especially in the neck, shoulders, and stomach. This only gets worse when you're angry and stressed when driving. All this seems to trigger the headaches and makes you worn out in the evening so that you just duck out by going to bed early or watching a lot of TV. You also indicated that you do much better when you relax, but most of that is by watching TV or sleeping off the stress, and you want to have better ways to relax and cope. Is that how it seems to you? (She responds affirmatively.) I think there are some ways we can do that and would like to describe them and see what you think. The first step is to help you learn how to really relax. If we agree, I will show you how to do this later in today's session. In the beginning, it will take you 20 to 30 minutes, but with practice you'll be able to do it much faster. Once you can relax yourself well, we'll develop several quick ways for you to relax whenever, wherever you start feeling anxious. The second step is to help you become more aware of when tension is coming on so that you can pay attention to those thoughts and feelings and initiate the relaxation skills. We've already started some of this when we had you keep track of your feelings in your diary (referring to self-monitoring log). The third step will really give you lots of practice in identifying the feelings of anxiety and relaxing away the tension so that you can have that "calm, clear-headed feeling" you like. We'll do this in the following ways. In the sessions, I will have you visualize situations that have made you anxious in the past, like a week ago when you were anxious about presenting your report at the project manager's meeting. Then, we will initiate relaxation and help you calm down and be relaxed again. We will do this over and over so that you get really good at recognizing anxiety and calming down by relaxing. Initially, we will start with moderate anxiety, but as you get better at relaxing away the tension, we'll increase the anxiety level, and have you take more and more control over the relaxation. You'll also practice the relaxation to cope with the worry and anxiety in real life. You'll write about those experiences in your diary, and we'll go over them each session. We'll also want to help you use the relaxation to abort those nasty headaches you get, and maybe on the anger you get when driving. Being able to relax should also help with that stewing or worrying you do. You indicated that when you are calm, you think things through pretty well, but not when you are uptight. The procedures I was describing should help you calm down and think things through calmly because you will be able to relax and calm yourself. This will take a lot of work on both our parts, but if we both

do our jobs, I think that we can develop these skills to relax whenever you are worried and tense in about 7 to 10 sessions. How does this sound to you?

The remainder of the session was spent developing a relaxation scene (see as follows), initiating progressive relaxation training, and presenting the relaxation scene twice. Homework included self-monitoring worry and anxiety and daily relaxation practice.

Relaxation Scene: It is last August when you were lying on that big rock out in the middle of the river near your favorite camping spot. It was about 3:30 in the afternoon, and you are there alone and can only hear the sound of the road off in the distant (general scene setting details). You are lying there on your back, looking up at the sky, the brilliant blue cloudless sky. The canyon is pretty steep on both sides, so the sky is framed in the gray of the rocks and green of the pine trees as you look up (more specific visual detail). You can hear the breeze rustling through the pines and hear the river gently gurgling as it flows over the rocks below you (auditory detail). The air is warm, but not hot and has that wonderful "early fall smell" you love so much (temperature and olfactory detail). You are warm, but not hot, feeling like the sun has soaked through you, that wonderful feeling like you have melted right into the rock (temperature, emotional, and kinesthetic detail). You are very peaceful, totally relaxed, and worry free, thinking that there is no place you would rather be. Feeling calm and clear headed. The colors and life seem clear and vibrant. Warm, relaxed, without worry, molded into that big rock in the river (cognitive and affective detail).

Session 2 involved a review of homework, the development of a moderate anxiety scene (i.e., approximately 60 on a 100-point scale), further relaxation training, anxiety arousal/relaxation coping, and assignment of homework. Relaxation training included practice with three new relaxation coping skills introduced for this client: (1) relaxation without tension (review of the muscles without tensing them); (2) breathing cued relaxation (taking three to five slow, deep breaths, relaxing more on each breath out); and (3) cue-controlled relaxation (pairing slow repetitions of the phrase "calm control" with relaxation). Focus was then directed to identifying an anxiety scene. The anxiety scene at the 70-level was as follows:

Anxiety Scene: It was Friday evening, three weeks ago. You were home alone as Jim (husband) and the kids had gone to the movies (scene-setting detail). It had been a tough day at work, and once again, you were frazzled and tired and avoided more stress by stay-

ing home (general emotional detail), sitting on the couch trying to zone out and watch TV, but couldn't stop thinking about work. You know it's stupid because you were well ahead of schedule, but kept thinking about how far behind you were and how much you had to do. You kept worrying that it was all going to fail and be your fault, how they were going to find out how incompetent you are. Also, you were worrying about Jim and the kids. He said they might get a bite to eat and catch the late movie, but you were worrying that they had been in an accident. You were a mess and couldn't stop thinking about all of this stuff (cognitive detail). You had that anxious-all-over feeling, like you couldn't sit still, all wound up, but no place to go. That sense of doom and bad things happening just sort of hung on you. Your shoulders were hard as rocks, stomach was churning away, and your head just kept turning over all the problems at work. You had another of those terrible headaches. That dull constant ache in the back was really wearing on you (emotional and physiological detail).

After the details of the anxiety scene were confirmed, relaxation was initiated through therapist-directed relaxation without tension. After the client signaled being relaxed, the anxiety scene was introduced, and relaxation was practiced (see sample instructions below).

Anxiety Scene Introduction: In a moment, we are going to have you practice reducing your anxiety. I will ask you to imagine the anxiety scene involving being home alone worrying about work and the kids. When I do, I want you to put yourself into that scene. Really be there and experience that worry and anxiety. As we discussed earlier, signal me when you are feeling anxious by raising your index finger. After a few seconds of being anxious, I will ask you to erase that scene and will help you retrieve that relaxed clear-headed feeling. When you are relaxed signal me again. So right now, put yourself into this scene ... (therapist describes the anxiety scene using voice inflection to increase attention to and the experience of anxiety) ... After 20 seconds, the client signals ... Ok, I see your signal. Now continue to pay attention to that anxiety. Let it build and pay attention to how you're feeling it ... maybe in the neck and shoulders ... maybe across the stomach area ... let it build and notice it ... really worry and be anxious about work ... (after 25 seconds) ... Ok, now erase that scene from your mind and once again switch back on your relaxation scene. You're there on the rock, relaxed and warm. Signal me when you are relaxed again ... (When the client signaled, this was followed by relaxation without tension.)

This process was repeated five times. Two relaxation coping skills were employed with each repetition. Homework involved self-monitoring, daily practice of progressive relaxation, and practice of relaxation coping skills at least once per day in nonstressful conditions (e.g., waiting for a friend for lunch).

Sessions 3 and 4 followed the format of Session 2, except that the client relaxed herself by "whatever method works best for you" prior to rehearsal of relaxation in response to anxiety scenes. An additional 60-level scene was added, and scenes were alternated during the session. During anxiety scene arousal, Jane was asked to pay attention to the signs associated with her experience of anxiety; these turned out to be tension in the neck and shoulders and clenching of the hands. Homework involved continued daily practice of relaxation without tension, application of relaxation coping skills whenever anxious, but with the caveat not to expect success every time, and continued self-monitoring of anxiety with the addition of recording applications of relaxation coping skills. The client was also instructed to identify two anxiety/worry scenes at approximately the 70-level.

By the beginning of Session 5, the client was showing some successful in vivo applications, having been able to partially reduce tension and anxiety on several occasions (i.e., she was able to lower her anxiety levels by 30 to 40 units, although she could not yet completely eliminate anxiety). Session 5 included two changes. First, two 70-level scenes were developed and alternated. Second, increased client self-control was fostered by having the therapist terminate the anxiety scene after a period of anxiety arousal, but having the client relax away the tension and signal the therapist when relaxation was achieved. For homework, in order to decrease the building stress and anxiety that appeared to trigger tension headaches, the client agreed to scan herself for cues of tension and to self-initiate a three-minute period of relaxation at the following times—in her car before she entered work, midmorning, after lunch, midafternoon, in her car before starting home, and at least once during the evening. She was also asked to apply relaxation coping skills any time she experienced any negative emotional arousal.

Sessions 6–9 followed a similar format. However, the anxiety level of the scenes increased to a 90-level as this was as anxious as the client felt when worried and anxious. Two driving anger scenes (see the following example) were also added to Sessions 7–9 to address her anger when driving. Instructions during rehearsal shifted to full client self-control. The therapist initiated

the visualization of the anxiety scene. The client signaled the experience of anxiety by raising her finger but kept her finger up. She then continued to visualize the scene and initiated relaxation coping skills, signaling by lowering her finger when she was relaxed. At that point, the therapist cleared the anxiety scene and instructed her to pay attention to her sense of control over the anxiety and her self-efficacy at anxiety management. Finally, to provide greater opportunities for in vivo practice and to initiate a transition to maintenance and relapse prevention, the time interval between Sessions 7, 8, and 9 was lengthened to two weeks.

Anger Scene: It was about two weeks ago. You were in the left lane on the two lane freeway ramp. You were following a woman driver in a blue Dodge with Nebraska plates. As the light change, the woman in front of you accelerated and swerved into the right lane in front of a large dump truck. The truck nearly hit her and blasted her with his horn. She then swerved back into your lane, nearly hitting you (setting detail). Instantly, you were angry, really pissed. Your hands were clenched around the wheel, shoulders knotted, stomach churning, and you had that hot flush come across your chest and into your neck and face (emotional and physiological detail). You were thinking, "Crazy bitch! She's going to get us all killed! Where the hell did she learn to drive, at some kind of destruction derby? I ought to run her off the road and save us all a lot of trouble (cognitive detail)."

Termination. The client had been demonstrating good anxiety management. She reduced significantly the frequency and intensity of worry/anxiety periods per day, reduced headache frequency from almost daily occurrences to approximately one per week with an intensity of a 3 on a 10-point scale, down from an intensity of 7 prior to therapy, and reported lessened anger while driving. A staggered termination was undertaken in order to facilitate maintenance and relapse prevention. Booster sessions were scheduled at one- and four-month post-therapy intervals, and continued self-monitoring and application of relaxation coping skills were underscored as the cornerstones of maintaining gains. The client contracted to continue self-monitoring and AMT application through at least the next four months. She developed a written contract and agreed to set aside \$1 per day toward the purchase of new clothes for every day she managed her anxiety and stress as well as an additional \$5 for a week in which she did so every day. The client mailed in her self-monitoring logs every two weeks. These were followed by therapist phone calls to

support gains and troubleshoot issues. Termination was achieved at four-month followup, although the client was seen for two additional booster sessions when her daughter became ill, and the client began worrying about potential health complications.

III. THEORETICAL BASIS

AMT was developed in 1971 as a solution to the inappropriateness of desensitization for dealing with what is now called generalized anxiety disorder (GAD). Desensitization is effective for phobias but requires the identification of the stimuli precipitating the anxiety response. In GAD, clients experience a more chronic, generalized state of anxiety, and the external cues eliciting anxiety cannot be identified so precisely. Desensitization was, therefore, not applicable, and alternative interventions were needed.

AMT is based on Richard Suinn's suggestion that clients can be taught to identify the internal signs, both cognitive and physical, that signal the presence of anxiety and to react to those signs by engaging in responses that remove them. This formulation was based on learning theory that conceptualized anxiety as a drive state and postulated that behaviors could be learned to eliminate the drive. Anxiety was viewed as having both response and stimulus properties. It was a response to prior internal and/or external anxiety-arousing stimuli. Its stimulus properties involve the potential to elicit new responses such as avoidance and escape. As such, it was argued that anxiety's stimulus properties could become associated with new responses, such as coping responses. AMT, therefore, does not require clients to identify the stimuli that precipitate their anxieties. Instead, the experience of anxiety itself is used to train the client in coping. The goal is to provide the client with a relaxation coping skill with which to deactivate anxiety once it occurs and to train the client in recognizing and using arousal as the cue to initiate that coping skill. In theoretical terms, AMT trains clients in responding to the response-produced cues of anxiety with relaxation, leading to the development of a new self-managed coping habit pattern.

Although some AMT procedures may appear similar to other behavior therapy methods using relaxation, there are several distinguishing characteristics of AMT. AMT initiates anxiety arousal during sessions rather than minimizing it as in desensitization. The goal of arousal is not extinction, but the opportunity to attend to the internal cues of anxiety arousal and to practice relaxation for

anxiety reduction. AMT uses homework to ensure transfer of training. Homework requires that clients apply relaxation coping skills in vivo. This practice ensures that skills acquired in therapy are transferred to real-life situations outside of treatment. Self-control is also emphasized. AMT actively fosters self-management by gradually requiring clients to assume more and more responsibility. Early in treatment therapists provide a great deal of control over both anxiety arousal and relaxation retrieval. However, clients gradually assume these responsibilities. Therapeutic instructions, fading of therapist control, and homework assignment help clients develop skills that increase their ability to control their anxiety. Because of the self-control element, AMT often leads to increased self-efficacy.

IV. APPLICATIONS AND EXCLUSIONS

Applications—Group AMT. AMT may be employed with individuals or groups. Groups can be relatively similar in their source of anxiety (e.g., groups of social phobics) or quite heterogeneous with widely differing sources of anxiety and stress. Group size should probably be limited to about eight. Research suggests that groups of over 25 are ineffective.

Group AMT requires several modifications from individual AMT. Therapy session duration should be extended by 20 to 30 minutes per session in order to attend to the increased number of clients and their various issues. If the treatment session cannot be lengthened, then the number of sessions should be lengthened to accommodate clients. Although individual AMT uses homework to develop both relaxation and anxiety scenes, this is particularly important in groups, if time is to be used efficiently. That is, clients must come to the early sessions with proposed scenes outlined in detail, so that group discussion time is saved for shaping up or crystallizing scene content. Since scene content varies across clients in group AMT, the therapist cannot provide detailed descriptions of the scene in order to stimulate visualization and anxiety arousal.

Group clients are asked to bring two scenes to each session, which are labeled “anxiety scene 1” and “anxiety scene 2.” Anxiety is elicited by giving the general instruction for clients to visualize “your first” or “your second anxiety scene.” Scenes are alternated by referring to the first or second anxiety scene, and clients are instructed that if one scene is not eliciting anxiety they are to continue to visualize the one that does. Exposure

length is also difficult to standardize during group sessions because clients might signal anxiety after different intervals of visualization. Therefore, in the initial sessions, the anxiety scenes should be visualized for 30 to 60 seconds, with timing started after approximately half of the group has signaled anxiety. In group applications, it is likely that clients will report various other sources of emotional distress (e.g., anger, guilt, embarrassment, depression, etc.). Therefore, it is important to make sure that clients apply relaxation to all sources of emotional distress. Often the final two to three sessions are used to focus on other emotionally distressing scenes in order to provide clients with in-session practice in dealing with such emotional issues.

Applications—Anxiety Conditions. Originally, AMT was developed and evaluated for use with chronically stressed and anxious individuals and for GAD. Over the years, there has been empirical support for its use with other anxiety conditions such as panic disorder, PTSD, simple and social phobias, multiple sources of anxiety and stress (e.g., an individual who is dealing with both work- and health-related stress), generally anxious and stressed medical outpatients, and anxiety- or stress-related health issues such as Type A behavior, tension headaches, diabetes, dysmenorrhea, and essential hypertension. AMT has also proven helpful to individuals who experience performance-related anxiety (e.g., anxiety that interferes with athletic performance, public speaking, or music recitals), even if the anxiety level is not sufficient to be diagnosed a phobic disorder. AMT has also been adapted to high general anger and situation-specific angers such as anger while driving.

Applications—Integration with Other Interventions. The coping skills in AMT can serve as one treatment component in complex treatment plans. For example, depressive disorders are often mixed with anxiety, tension, and worry. In such cases, a treatment plan could rely on AMT to address anxiety and could be followed by other psychological and biological interventions for the depressive disorder. Some studies using AMT to treat anxiety report that depression also declined. Possible reasons include the tendency for anxiety and depression to be correlated, or the reduction of depression due to the increase in efficacy from AMT.

AMT is easily included as an element of other psychological interventions. For example, AMT-like interventions have been successfully combined with cognitive restructuring in the treatment of GAD, panic disorder, social phobia, Type A behavior, and anger.

AMT has also been effectively combined with cognitive and behavioral interventions in the treatment of vocationally anxious individuals.

AMT may be used as an initial step to enable clients to respond to other psychotherapeutic interventions. For example, AMT might be used with a sexually abused client. Providing anxiety management skills may facilitate clients' ability to discuss and confront emotionally charged topics. Another potential application of AMT is in prevention or simply as a general coping skill for daily life stresses.

In summary, AMT can be a valuable part of an overall treatment plan. In integrated interventions it is suggested that AMT be implemented as the first step. It helps the client achieve anxiety reduction skills while at the same time building the therapeutic relationship and alliance. It can also reduce resistance to confronting anxiety-related therapeutic content, content that might be essential for other psychotherapeutic interventions. Since a side benefit of AMT is an increase in self-efficacy, possibly due to the self-control that is achieved, clients might feel more confident when facing other personal-emotional problem areas.

Exclusions and Contraindications. Few contraindications for AMT have been identified. The AMT model suggests several treatment considerations. AMT is an intervention that requires clients who have the cognitive-attentional processes and motivation necessary for performing its procedures. Clients must be able to follow instructions, develop and maintain anxiety imagery, and follow through on homework assignments. Individuals who cannot or are unwilling to engage in these activities are not good candidates for AMT. For example, a small number of individuals have great difficulty in visualizing events. An alternative intervention is required such as in vivo presentation of anxiety-arousing situations.

AMT is based on clients' readiness to develop self-control over their anxieties. Some clients do not hold such self-control expectancies and may prefer treatments involving minimal personal behavior change (e.g., anti-anxiety medication). Therapists must address client expectations about treatment goals and techniques before AMT is adopted.

Research suggests that some individuals develop relaxation-induced anxiety (i.e., relaxation training increases rather than reduces anxiety). Sometimes, this problem can be resolved by repeated practice of small relaxation training steps, a switch to an alternative relaxation training methodology, or counter-demand ex-

pectancies. However, if this issue cannot be resolved, other interventions should be employed.

Few studies have been reported concerning the effectiveness of AMT with children and the elderly. However, anecdotal evidence has shown that ethnic minority youth can respond to AMT and that children can develop relaxation skills and use imagery.

V. EMPIRICAL STUDIES

Many studies support the efficacy of AMT. In 1990 Richard Suinn reviewed the literature and concluded AMT to be effective with a wide variety of disorders.

AMT is effective with various phobias and situational anxieties. For example, AMT reduced social, math, test, and public speaking anxieties, and in some cases improved performance in these areas as well. A more recent study showed that both AMT and a cognitive intervention lowered math anxiety and improved math performance in math-anxious college students. Anxiety surrounding vocational indecision was reduced by AMT as well. Throughout these studies, AMT was as effective as or more effective than other interventions such as systematic desensitization, self-control desensitization, systematic rational restructuring, social skill building, and vocational counseling. Moreover, although AMT targeted specific phobias or anxieties, reductions of general anxiety were reported in several studies, suggesting that AMT was associated with response generalization.

High trait anxiety, GAD, panic and posttraumatic stress disorder have also been treated successfully with AMT. Effects were maintained at long-term followup, and, where measured, generalized effects were found on measures of depression and anger. AMT lowered anxiety levels and use of anxiety medications in a group of GAD and panic-disordered psychiatric patients. AMT and cognitive therapy lowered anxiety in outpatients with GAD and tended to be more effective than psychodynamic therapy. Also, AMT reduced anxiety, avoidance, and intrusions of trauma-related memories in Vietnam veterans with posttraumatic stress disorder. In addition, general anxiety, ratings of anger and anxiety, and overall psychiatric status were improved in schizophrenic outpatients receiving AMT.

Stress- and medically related conditions have also responded favorably to AMT. For example, AMT has lowered Type A behavior and general anxiety in Type A individuals, blood pressure levels in individuals with essential hypertension, stress in individuals with

diabetes, gynecological symptoms and general anxiety in women with dysmenorrhea, and stress in gynecological outpatients. Again, AMT tended to be as effective as other interventions and, where assessed, to show long-term maintenance.

AMT has also been successfully adapted to anger reduction. The procedures of AMT have been successfully adapted to control general anger and anger while driving. In these studies, the adaptation of AMT was generally as effective as cognitive and combined cognitive-relaxation interventions.

In summary, AMT is an empirically supported intervention. It is effective with situational anxiety and phobic conditions, as well as GAD, general anxiety, and posttraumatic stress disorder. It is also effective with stress-related medical conditions and anger. Where comparisons have been made to other interventions, it is generally significantly more effective than control conditions, and as effective as certain other cognitive-behavioral interventions. Where long-term follow-ups have been conducted, effects were well maintained. In all, there is a solid empirical literature supporting AMT. Moreover, since many of the outcome studies of AMT have been conducted in a group format, there is considerable support for group AMT as well.

VI. SUMMARY

Anxiety management training (AMT) is a brief behavioral intervention involving the use of relaxation as a skill for reducing anxiety. It may be conducted individually or in small groups, and it typically takes about eight sessions. AMT is founded on the principle that anxiety has stimulus properties that can serve as cues for relaxation as a coping response. AMT relies on relaxation training, in-session anxiety arousal through imagery and practice of relaxation as a coping skill, and graduated homework assignments to ensure transfer for real-life anxiety reduction. The first session is devoted primarily to relaxation practice and anxiety scene development. The next seven sessions are devoted to eliciting anxiety through anxiety-arousing imagery and initiating relaxation coping skills for anxiety reduction. In early sessions, anxiety arousal is moderate, and the therapist provides considerable structure and assistance in relax-

ation retrieval. However, over time and with client success in anxiety management, the therapist assistance is faded to client self-control, and the level of anxiety arousal is increased. Homework assignments involve applying relaxation coping skills outside of the treatment sessions to ensure transfer of relaxation coping skills to real-life application. Portions of latter sessions address issues of maintenance and relapse prevention and may address application to other distressing emotions as well. AMT is empirically supported with many anxiety- and stress-related disorders and conditions. AMT may be employed as a stand-alone intervention or be integrated with other behavioral and nonbehavioral interventions in a comprehensive treatment plan.

See Also the Following Articles

Anxiety Disorders: Brief Intensive Group Cognitive Behavior Therapy ■ Applied Relaxation ■ Applied Tension ■ Aversion Relief ■ Biofeedback ■ Complaints Management Training ■ Panic Disorder and Agoraphobia ■ Progressive Relaxation ■ Relaxation Training

Further Reading

- Daley, P. C., Bloom, L. J., Deffenbacher, J. L., & Steward, R. (1983). Treatment effectiveness of anxiety management training in small and large group formats. *Journal of Counseling Psychology* 30, 104–107.
- Durhan, R. C., Murphy, T., Allan, T., Richard, K., et al. (1994). Cognitive therapy, analytic psychotherapy, and anxiety management training for generalised anxiety disorder. *British Journal of Psychiatry* 165, 315–323.
- Pantalon, M. V., & Motta, R. W. (1998). Effectiveness of anxiety management training in the treatment of posttraumatic stress disorder: A preliminary report. *Journal of Behavior Therapy and Experimental Psychiatry* 29, 21–29.
- Suinn, R. M. (1996). Anger: A disorder of the future, here today. *The Independent Practitioner* 16, 149–151.
- Suinn, R. M. (1990). *Anxiety Management Training: A Behavior Therapy*. Plenum Press, New York.
- Suinn, R. M. (1975). Anxiety management training for general anxiety. In Suinn, R., and Weigel, R. (Eds.). *The Innovative Psychological Therapies: Critical and Creative contributions*, pp. 66–70, Harper and Row, New York.
- Suinn, R. M., & Deffenbacher, J. L. (1988). Anxiety management training. *The Counseling Psychologist* 16, 31–49.

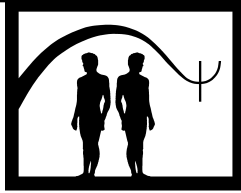

Applied Behavior Analysis

Alan E. Kazdin

Yale University

- I. Description of Treatment
 - II. Theoretical Bases
 - III. Essential Features of Applied Behavior Analysis
 - IV. Empirical Studies
 - V. Applications
 - VI. Issues and Challenges
 - VII. Summary
- Further Reading

GLOSSARY

antecedents Stimuli, settings, and contexts that occur before and influence behaviors. Examples include instructions and gestures from others.

baseline rate The frequency with which behavior is performed prior to initiating a behavior modification program; operant rate of behavior.

behavior Any observable or measurable response or act.

consequences Events that follow behavior and may include influences that increase, decrease, or have no impact on what the individual does.

contingency The relationship among antecedents (e.g., prompts, setting events), a behavior (the response to be changed), and consequences (e.g., reinforcers).

contingent on behavior An event (e.g., praise, tokens, time out) is contingent on behavior when the event is delivered only if that behavior is performed.

differential reinforcement Reinforcing a response in the presence of one stimulus (S^D) and extinguishing the response in the presence of other stimuli (S^A). Eventually, the re-

sponse is consistently performed in the presence of the S^D but not in the presence of the S^A .

discrimination Responding differently in the presence of different cues or antecedent events; control of behavior by discriminative stimuli.

discriminative stimulus (S^D) An antecedent event or stimulus that signals that a certain response will be reinforced. A response is reinforced in the presence of an S^D . After an event becomes an S^D by being paired with reinforcement, its presence can increase the probability that the response will occur.

experimental design The plan for evaluating whether the intervention, rather than various extraneous factors, was responsible for behavior change.

extinction A procedure in which the reinforcer is no longer delivered for a previously reinforced response.

functional analysis Evaluation of the behavior and of antecedent and consequences associated with the behavior. A functional analysis identifies the “causes” of behavior, that is, current conditions that are maintaining the behavior. These conditions are determined by directly assessing behavior, proposing hypotheses about likely factors that are controlling behavior, and testing these hypotheses to demonstrate the conditions that cause the behavior. The information from functional analysis is then used to guide the intervention by direct alteration of conditions so that the desired behaviors are developed.

functional relation The relation of behavior and an experimental condition or contingency. A functional relation is demonstrated if behavior systematically changes when the contingency is applied, withdrawn, and reapplied.

multiple-baseline design An experimental design that demonstrates the effect of a contingency by introducing the contingency across different behaviors, individuals, or situations at different points in time. A causal relationship between the experimental contingency and behavior is demonstrated if each of the behaviors changes only when the contingency is introduced.

negative reinforcement An increase in the likelihood or probability of a response that is followed by the termination or removal of a negative reinforcer.

operant Behavior that is emitted rather than elicited. Emitted behavior operates on the environment and responds to changes in consequences (e.g., reinforcement, punishment) as well as antecedents (e.g., setting events, stimuli).

operant conditioning A type of learning in which behaviors are influenced primarily by the consequences that follow them. The probability of operant behaviors is altered by the consequences that they produce. Antecedents too are involved in learning as cues (S^D , S^A) become associated with different consequences and can influence the likelihood of the behavior.

operational definition Defining a concept (e.g., aggression, social skills) by referring to the specific operations that are to be used for assessment. The “operations” or methods of measuring the construct constitute the operational definition.

positive opposite A behavior that is an alternative to and preferably incompatible with the undesired behavior. Suppression or elimination of an undesirable behavior can be achieved or accelerated by reinforcing a positive opposite. When the goal is to reduce or eliminate behavior, it is helpful to consider the positive opposite behaviors that are to be developed in its stead.

positive reinforcement An increase in the likelihood or probability of a response that is followed by a positive reinforcer.

positive reinforcer An event whose presentation increases the probability of a response that it follows.

prompt An antecedent event that helps initiate a response. Instructions, gestures, physical guidance, and modeling cues serve as prompts.

punishment Presentation of an aversive event or removal of a positive event contingent on a response that decreases the likelihood or probability of the response.

reinforcement An increase in the likelihood or probability of a response when the response is immediately followed by a particular consequence. The consequence can be either the presentation of a positive reinforcer or the removal of a negative reinforcer.

response cost A punishment procedure in which a positive reinforcer is lost contingent on behavior. With this procedure, unlike time out from reinforcement, no time limit to the withdrawal of the reinforcer is specified. Fines and loss of tokens are common forms of response cost.

response maintenance The extent to which changes in behavior are sustained after the program or the intervention phase is ended.

S^A An antecedent event or stimulus that signals that a certain response will not be reinforced.

schedule of reinforcement The rule denoting how many or which responses will be reinforced.

S^D See **discriminative stimulus**.

setting events Antecedent events that refer to context, conditions, or situational influences that affect the contingencies that follow. Such events set the stage for behavior-consequence sequences that are likely to occur.

shaping Developing a new behavior by reinforcing successive approximations toward the terminal response.

single-case experimental designs Arrangements for evaluating whether the intervention was responsible for change. The designs require continuous assessment of the target behavior(s) over time and changes in how and sometimes to whom or when the intervention is applied. The unique feature of the designs is that they permit causal inferences to be drawn about interventions as applied to the individual case.

spontaneous recovery The temporary recurrence of a behavior during extinction. A response that has not been reinforced may reappear temporarily during the course of extinction.

stimulus control The presence of a particular stimulus serves as an occasion for a specific response. The response is performed only when it is in the presence of a particular stimulus.

target behavior The behavior to be altered or focused on during the intervention. The behavior that has been assessed and is to be changed.

time out from reinforcement A punishment procedure in which access to positive reinforcement is withdrawn for a brief period contingent on behavior. Isolation from a group exemplifies time out from reinforcement, but many variations do not require removing the client from the situation.

token A tangible object that serves as a reinforcer. Poker chips, coins, tickets, stars, points, and check marks are commonly used as tokens. They derive their value from being exchangeable for multiple backup reinforcers.

token economy A reinforcement system in which tokens are earned for a variety of behaviors and are used to purchase a variety of backup reinforcers.

transfer of training The extent to which the changes in behavior during and after the program extend to settings, situations, or circumstances that were not included in the program.

I. DESCRIPTION OF TREATMENT

Applied behavior analysis is a specific area of research and intervention within behavior modification. Several characteristics of behavior modification include an emphasis on overt behavior, a focus on current determinants of behavior, and reliance on the psychology of learning as the basis for conceptualizing clinical problems (e.g., anxiety, depression) and their treat-

ment. The psychology of learning refers broadly to theory and research derived from different types of learning, including classical conditioning, operant conditioning, and observational learning (modeling). Applied behavior analysis draws primarily on operant conditioning as the basis for developing interventions.

Applied behavior analysis is not a technique or indeed even a set of techniques. Rather, it is an approach toward conceptualizing, assessing, and evaluating behavior and devising interventions to effect behavior change. The interventions focus on antecedents, behaviors, and consequences and how these can be altered to influence behavior. What is particularly remarkable is the scope of applications that have derived from applied behavior analysis. Apart from applications to many clinical problems seen in treatment, interventions have focused on a vast array of behaviors in everyday life. This contribution describes applied behavior analysis, the underlying principles and techniques, central features of the approach to assessment and evaluation, and how treatment and evaluation are intertwined.

II. THEORETICAL BASES

The underpinnings of applied behavior analysis derive from the work of B. F. Skinner (1904–1990), who developed and elaborated operant conditioning, a type of learning that emphasizes the control that environmental events exert on behavior. The behaviors are referred to as operants because they are responses that operate (have some influence) on the environment. Operant behaviors are strengthened (increased) or weakened (decreased) as a function of the events or consequences that follow them. Operants can be distinguished from reflex responses, such as a startle reaction

in response to a loud noise or squinting in response to bright light. Reflex responses are unlearned and are controlled by eliciting stimuli. Most of the behaviors performed in everyday life are operants. Examples include reading, walking, working, talking, nodding one's head, smiling, and other freely emitted responses. Operant conditioning is the type of learning that elaborates how operant behaviors develop and the many ways in which their performance can be influenced.

Beginning in the 1930s, Skinner's animal laboratory work elaborated the nature of operant conditioning, including the lawful effects of consequences on behavior. These lawful effects generated various principles of operant conditioning, highlighted in Table 1. These principles provide general statements about the relations between behavior and environmental events. Basic experimental and animal laboratory research has continued to flourish and is referred to as the experimental analysis of behavior. The principles have also served as the basis for developing interventions in applied settings such as the home, school, hospitals and institutional settings, business and industry, and the community at large. The application and evaluation of interventions derived from basic research on operant conditioning has emerged as its own area of research and is referred to as applied behavior analysis.

Laboratory work on the study of operant conditioning was characterized by a focus on overt behavior, assessment of the frequency of behavior over time, and the study of one or a few organisms (e.g., rats, pigeons) at a time. The focus on one or two organisms over time permitted the careful evaluation of how changes in consequences influenced performance and the lawfulness of behavior under diverse circumstances. Eventually, the approach was extended to humans. The initial goal was to see if lawful relations between behavior and

TABLE 1
Summary of Key Principles of Operant Conditioning

<i>Principle</i>	<i>Relation between environmental events and behavior</i>
Reinforcement	Presentation or removal of an event after a response that increases the likelihood or probability of that response.
Punishment	Presentation or removal of an event after a response that decreases the likelihood or probability of that response.
Extinction	No longer presenting a reinforcing event after a response that decreases the likelihood or probability of the previously reinforced response.
Stimulus control and discrimination	Reinforcing the response in the presence of one stimulus but not in the presence of another. This procedure increases the likelihood or probability of the response in the presence of the former stimulus and decreases the likelihood or probability of the response in the presence of the latter stimulus.

consequences demonstrated in animal laboratory research could be replicated in laboratory studies with humans and to investigate how special populations (e.g., adult psychiatric patients, mentally retarded children) responded.

By the late 1950s and early 1960s, operant conditioning methods were extended to human behavior outside the laboratory and focused on behaviors that were more relevant to everyday life. Initial demonstrations were conducted merely to see if environmental consequences could influence behavior outside of the context of a laboratory task. For example, could the irrational speech of psychiatric patients or interpersonal interactions of such patients with the staff be influenced by systematically providing attention and praise for positive, prosocial behavior? Several dramatic demonstrations in the early 1960s showed that marked behavior changes could be achieved. These demonstrations were unique because they included extensions of procedures developed in laboratory research, systematically applied consequences to develop behavior, carefully assessed behavior to evaluate the immediate effects of consequences, and demonstrated experimental control of the consequences. Experimental control was evident by showing that behaviors (e.g., delusional speech of psychiatric patients) could be increased and decreased as a function of systematically altering consequences in the environment (e.g., staff attention and praise). Of course, the control did not mean or imply that all behaviors could be influenced by environmental events or that current influences in the environment are the only causes of behavior. However, the early demonstrations raised the prospect that one way to intervene on many behaviors would be to alter antecedents and consequences and to do so in a systematic way. Laboratory research provided guidelines on how this might be accomplished. The early extensions of operant conditioning principles to human behavior began an area of research that is now formally recognized as applied behavior analysis.

III. ESSENTIAL FEATURES OF APPLIED BEHAVIOR ANALYSIS

Applied behavior analysis is an approach to intervention. The approach is characterized by attention to a specific set of influences and how they can be used to develop behavior as well as methods of assessment and evaluation. It is useful to describe these substantive and methodological components separately before conveying how they are intertwined.

A. Contingencies: The ABCs of Behavior

Behavior change in applied behavior analysis is achieved by altering the contingencies of reinforcement. The contingencies refer to the relationships between behaviors and the environmental events that influence behavior. Three components are included in a contingency, namely, antecedents (A), behaviors (B), and consequences (C). The notion of a contingency is important not only for understanding behavior but also for developing programs to change behavior. Antecedents refer to stimuli, settings, and contexts that occur before and influence behaviors. Examples include verbal statements, gestures, or assistance in initiating the behavior. Behaviors refer to the acts themselves, what individuals do or do not do, and the actions one wishes to develop or change. Consequences refer to events that follow behavior and may include influences that increase, decrease, or have no impact on what the individual does. Table 2 illustrates the three components of a contingency with simple examples from everyday life.

Antecedents include a number of potential influences on behavior. Setting events are one category of antecedents and refer to contextual factors or conditions that influence behavior. They are broad in scope and set the stage for the behaviors and consequences that follow. Examples include features of the situation, features of the task or demands presented to the individual, conditions within the individual (e.g., exhaustion, hunger, expectations of what will happen), or behaviors of others that influence the likelihood of specific behaviors that follow. For example, stress at work can influence the subsequent behavior of an individual when he or she returns home at the end of the day. The stress may influence interactions at home and reactions to other events (e.g., comments from a spouse, "bad" habits of a spouse). Setting events are important influences on behavior. The "same" request delivered to a child may lead to quite different responses depending on how the request is delivered, when, and in the context of other influences. Prompts are another type of antecedent event and refer to specific antecedents that directly facilitate performance of behavior. They are distinguished from setting events, which are more contextual, indirect, and broader influences. Common examples of prompts include instructions to engage in the behavior (e.g., "Please wash up before dinner"), cues (e.g., reminders or notes to oneself, lists of things to do), gestures (e.g., to come in or leave the room), ex-

TABLE 2
Three Components of a Contingency and Illustrations from Everyday Life

<i>Antecedent</i>	<i>Behavior</i>	<i>Consequence</i>
Telephone rings	Answering the phone	Voice of person at the other end
Wave (greeting) from a friend	Walking over to the friend	Visiting and chatting
Parent instruction to a child to clean the room	Picking up toys	Verbal praise and a pat on the back
Warning not to eat spoiled food	Eating the food	Nausea and vomiting

amples and modeling (e.g., demonstrations to show this is how the behavior, task, or skill is performed), and physical guidance (e.g., guiding a person's hands to show her how to play a musical instrument).

Behavior, the second part of the contingencies of reinforcement, refers to what an individual does and the goal of the program, that is, what one wants the individual to do. The goal of the intervention may be to increase performance in some way (e.g., initiating a behavior that never occurs, developing more frequent performance of behavior that is occurring, fostering longer periods or more consistent performance of the behavior, or fostering the behavior in new situations). In these instances, providing antecedents and consequences may be sufficient to increase or extend the behavior. In many other cases, the individual does not have the behavior in his or her repertoire or only has the behavior partially. The desired behavior may be so complex (e.g., driving a car, reading a story) that the elements making up the response are not in the repertoire of the individual. In these cases, one cannot merely wait for the behavior to occur and provide consequences; the response may never occur. The behavior can be achieved by reinforcing small steps or approximations toward the final response, a process referred to as shaping.

Consequences, the third component of the contingencies, refers to what follows behavior. For a consequence to alter a particular behavior, it must be dependent or contingent on the occurrence of that behavior. Behavior change occurs when certain consequences are contingent on performance. A consequence is contingent when it is delivered only after the desired behavior has been performed and is otherwise not available. When a consequence is not contingent on behavior, this means that it is delivered independently of what the person is doing. For example, praise might be used to increase the compliance of an oppositional child. To exert influence, praise would need to be contingent on performance, in this case on

instances of compliance. The example is helpful in another way. For a very noncompliant child, there may be no instances of the performance to praise. The use of antecedents to prompt compliance (e.g., prompts of precisely what the child could say), shaping to approximate compliance (e.g., partial compliance to simple requests), and praise contingent on performance can readily develop the behavior.

The principles of operant conditioning include the many ways in which consequences follow behavior. The principles can be translated into a very large number of techniques. For example, positive reinforcement was mentioned as a principle (Table 1). The positive consequences that can be applied contingently to alter behavior can include food, praise, attention, feedback, privileges, and activities. Indeed, often many of these are combined into a single reinforcement program where the individual can earn tokens (e.g., points, stars, tickets, or money) contingent on the desired behavior. The tokens are then used to purchase a variety of other reinforcers available in the setting. Many reinforcers (praise, attention, tokens) have broad applicability across many individuals and generally are effective. However, individual preferences and special features of the situation (e.g., at home, at school) can be readily incorporated into a behavior-change program.

Providing positive reinforcers after behavior can have a potent effect. Yet, identifying the reinforcers that might be used can oversimplify the task of changing behavior. To be effective, the consequences must be provided in special ways; these ways have been well studied in research. Merely providing some positive consequence for behavior is not likely to achieve changes unless several conditions are in place. Table 3 conveys several conditions that influence the effectiveness of reinforcement.

Although it is useful to distinguish antecedents, behavior, and consequences, they are interrelated. Antecedent events (e.g., setting events and prompts) often

TABLE 3
Factors in the Delivery of Reinforcement That Influence
Effects on Behavior

Contingent Application of Consequences

The reinforcer is provided only if the desired response is performed and otherwise not given.

Delay of Reinforcement

The reinforcer should be delivered immediately after the desired behavior.

Magnitude or Amount of the Reinforcer

Larger magnitude reinforcers (e.g., quantity of food, number of points, amount of money) increase effectiveness of reinforcement, up to a point that the individual might be satiated (e.g., if food is used).

Quality or Type of the Reinforcer

Reinforcers that are highly preferred lead to greater performance than do those that are less preferred.

Schedule of Reinforcement

When behavior is being developed, reinforcement after every occurrence of the response (continuous reinforcement) is much more effective than reinforcement for only some of the responses (intermittent reinforcement).

become associated with a particular behavior and its consequences. For example, in some situations (or in the presence of certain stimuli), a response may be reinforced, whereas in other situations (in the presence of other stimuli), the same response may not be reinforced. The concept of differential reinforcement is central to understanding stimulus events and their influence. Differential reinforcement refers to reinforcing a response in the presence of one stimulus or situation and not reinforcing the same response in the presence of another stimulus or situation. When a response is consistently reinforced in the presence of a particular stimulus (e.g., at home) and not reinforced in the presence of another stimulus (e.g., at school), each stimulus signals the consequences that are likely to follow. A stimulus whose presence has been associated with reinforcement is referred to as a discriminative stimulus (S^D). A stimulus whose presence has been associated with nonreinforcement is referred to as a nondiscriminative stimulus or (S^A or S^Δ). The effect of differential reinforcement is that eventually the reinforced response is likely to occur in the presence of the S^D but unlikely to occur in the presence of the S^A . When responses are differentially controlled by antecedent stimuli, behavior is said to be under stimulus

control. When there is stimulus control, the presence of a stimulus increases the likelihood of a response. The presence of the stimulus does not cause or automatically elicit the response but rather merely increases the probability that a previously reinforced behavior will occur.

Instances of stimulus control pervade everyday life. For example, the sound of a doorbell signals that a certain behavior (opening the door) is likely to be reinforced (by seeing someone). Specifically, the sound of the bell frequently has been associated with the presence of visitors at the door (the reinforcer). The ring of the bell (S^D) increases the likelihood that the door will be opened. In the absence of the bell (S^A), the probability of opening the door for a visitor is very low. The ring of a doorbell, telephone, alarm, and kitchen timer all serve as discriminative stimuli (S^D) and signal that certain responses are likely to be reinforced. Hence, the probability of the responses is increased. In a quite different context, when a robber confronts us, this is not an S^D for really friendly and social behaviors on our part. The cues that robbers present (weapon, hostile demeanor, outfit, context) suggest that probably only one response will be reinforced (e.g., compliance).

Stimulus control and discrimination illustrate how antecedents, behaviors, and consequences become connected. In applied behavior analysis, often the goal is to develop behavior in some situations (e.g., at home) or in multiple situations. Usually, it is important to develop behavior, so it transfers across many stimulus conditions; this can be accomplished during training, as mentioned later in this entry.

B. Assessment

Implementing an intervention requires clearly stating the goal, carefully describing the behaviors that are to be developed, and measuring these before the program begins. The main goal of a program is to alter or develop a particular behavior, referred to as the target behavior. There might well be multiple target behaviors.

Identifying the goal of the program in most cases seems obvious and straightforward because of the direct and immediate implications of the behavior for the adjustment, impairment, and adaptive functioning of the individual in everyday life. For example, many interventions have decreased such behaviors as self-injury (e.g., headbanging) among autistic children, anxiety and panic attacks, and driving under the influence of alcohol, and have increased such behaviors as

engaging in practices that promote health (e.g., exercise, consumption of healthful foods) and academic performance among individuals performing poorly at school.

More generally, behaviors are selected for intervention for any of several reasons. First is impairment, or the extent to which an individual's functioning in everyday life is impeded by a particular problem or set of behaviors. Impairment consists of meeting role demands at home, at school, and at work, interacting prosocially and adaptively with others, and not being restricted in the settings, situations, and experiences in which one can function. Second, behaviors that are illegal or rule-breaking too are brought to treatment. Illegal behaviors would include driving under the influence of alcohol, using illicit drugs, and stealing; rule-breaking that is not illegal might include a child leaving school repeatedly during the middle of the day or not adhering to parent-imposed curfew. Third, behaviors that are of concern to individuals themselves or to significant others serve as the basis for seeking interventions. For example, parents seek interventions for a variety of child behaviors that affect daily life but may or may not be severe enough to reflect impairment or rule-breaking. Examples might include toilet training, school functioning, and mild versions of other behaviors that, if severe, might lead to impairment. Finally, behaviors are focused on that may prevent problems from developing. For example, premature babies and children from economically disadvantaged environments are at risk for later school difficulties. Early interventions within the first months and few years of life are intended to develop pre-academic behaviors and avert later school difficulties. Also, developing behaviors to promote safety (e.g., in business and industry or in the home) or health are selected to prevent later problems.

A behavioral program usually begins with a statement from someone that there is a problem or a need to intervene to address a particular end. Global statements of behavioral problems are usually inadequate for actually beginning an intervention. For example, it is insufficient to select as the goal alteration of aggressiveness, learning deficits, speech, social skills, depression, psychotic symptoms, and self-esteem. Traits, summary labels, and personality characteristics are too general to be of much use. Moreover, definitions of the behaviors that make up such general labels may be idiosyncratic among different behavior-change agents (parents, teachers, or hospital staff). The target behaviors have to be defined explicitly so that they can actu-

ally be observed, measured, and agreed upon by individuals administering the program.

The general complaint (e.g., the child has tantrums) must be translated into operational definitions. Operational definitions refer to defining a concept on the basis of the specific operations used for assessment. Paper-and-pencil measures (questionnaires to assess the domain), interviews, reports of others (e.g., parents, spouses) in contact with the client, physiological measures (e.g., arousal, stress), and direct observation are the among the most commonly used measures in psychological research to operationalize key concepts. Several measures might be selected in any given intervention program, and no single measure can capture all components of the concept. In applied behavior analysis, emphasis is placed on direct observation of overt behavior because overt behavior is viewed as the most direct measure of the treatment focus. For example, if tantrums are of interest, it is useful to observe the tantrums directly and to see when they occur, under what circumstances, and whether they change in response to an intervention.

Once the target behavior(s) is carefully defined, observations are made to collect data on the problem. The observations may be made by tallying their occurrence within a period of time or recording whether or not they occurred in a particular time interval. The behavior is sampled on a continuous basis, usually daily or multiple times per week. For example, if the goal is to increase the social behavior of a withdrawn psychiatric patient, to develop completion of homework in an adolescent with academic difficulties, or to increase the activity of an elderly person in a residential home, the specific target behaviors will be defined and assessed directly. The purpose is to obtain the rate of performance prior to the intervention, referred to as the baseline rate. Because interventions are often conducted in everyday settings, parents, teachers, and others may be involved in the collection of this information. Careful assessment is central because the assessment data are used to make decisions about the treatment while the intervention is in effect.

C. Functional Analysis: From Assessment to Intervention

Functional analysis consists of a methodology of identifying the relation of a target behavior to antecedents and consequences and using this information to select the intervention. "Functional" emphasizes identifying the functions of the behavior, that is, the

TABLE 4
Hypothetical Examples of the Consequences or Purposes of Behaviors

<i>Behavior</i>	<i>Outcomes that may maintain that behavior</i>
Tantrum of a child before going to bed	Attention from a parent, extra time with the parents, reduction of parent's arguing with each other
Arguing or fighting with a spouse/partner	Affection and promises of life-long commitment that result from making up after the fight, time away from the spouse as he or she walks out for a few days
Complaining	Attention and sympathy from others, not hearing the complaints of others, personal relief or stress reduction as a function of expressing unfortunate conditions
Attaining good grades in school	Praise from others, success, reduction in anxiety about failing

Note: The functions of a behavior are usually determined on an individual basis so there is no single function that a particular behavior invariably serves for all or even most individuals. Indeed, different behaviors can serve the same function for two individuals, and the same behavior may serve different functions for two individuals.

purposes the behavior may serve in the environment or the outcomes that maintain the behavior. Table 4 provides some examples of behaviors and some of the functions the behaviors may serve. "Analysis" emphasizes the careful assessment and systematic evaluation to isolate precisely the factors that control behavior. The analysis consists of obtaining data about the hypothesized purposes that the behavior may serve and testing whether these purposes actually control or influence behavior.

The elements of functional analyses are assessment, development and evaluation of hypotheses about factors that control behavior, and intervention. Initially, assessment is designed to identify the relations of antecedents and consequences to the behavior of interest and hence the purposes or functions of the behavior. This assessment is likely to suggest circumstances or stimulus conditions with which the behavior is associated. For example, the behavior may appear to be more frequent at some times of the day rather than others, when some persons are present rather than others, and when certain effects or consequences occur.

The patterns raise hypotheses about what may be maintaining or controlling behavior. If at all possible, the hypotheses are tested directly by assessing the target behavior as various conditions are changed. The conditions in which the hypotheses are tested may be brief and transient merely to see if different conditions systematically influence behavior. This is an experimental phase designed to evaluate if the controlling conditions can be identified.

The information gained from manipulating conditions and from assessment under different conditions is used to help the client directly. Specifically, the conditions shown to influence behavior are altered to de-

crease inappropriate or deviant behavior and to foster appropriate, prosocial behavior. This is the intervention phase of functional analysis. The purpose of this phase is to put into place the condition that controls behavior to achieve a significant therapeutic change.

Consider, as an example, a child (Kathy, age 8) who frequently fought (physically) with her younger sister (Mary, age 4). The parents wanted to eliminate fighting. Both children were in the home from late afternoon (after school and day care) and were observed by the mother for several days from the afternoon until the children's bedtime. We asked the mother to chart two related behaviors when the children were together (in the same room). The first behavior was fighting and included arguing, shouting, and hitting. The second behavior was playing cooperatively or being together in an activity without the above behaviors. We recorded these latter behaviors because developing positive opposite behaviors typically serves as the focus of interventions that are stimulated by interests in decreasing deviant behavior. The behaviors were observed using a frequency count, that is, merely tallying the occurrence of any instance of the behavior. One minute of either behavior was scored as an instance of that behavior.

Table 5 includes two charts the mother was asked to use to track fighting (Chart A) and playing cooperatively (Chart B). The purpose of using a chart was to identify whether any patterns emerged and suggest the conditions that may contribute to the behavior. The entries in the chart are samples and reflect some of the information collected from the mother. After several days, it appeared (from Chart A) that Kathy's fighting with her sister occurred mostly during the following antecedent conditions: after school but before dinner, in the presence of the mother when she was by herself,

TABLE 5
Charts to Record Fighting (Chart A) and Playing Cooperatively (Chart B)—Sample Entries from the Charts

Chart A Episodes of Fighting

<i>Time/day/date</i>	<i>Antecedents situation/setting conditions/others present</i>	<i>Consequences</i>
Monday, 3:45 P.M.	Watching TV, no else home	Separated children, sent Kathy to her room, read to her for 15 min
Tuesday, 5:00 P.M.	Playing on the computer	Took Kathy to her room and talked with her about playing better with her sister, talked about what happened at school
Wednesday, 4:10 P.M.	Playing on the computer	Sent Kathy to her room and she showed me drawings and a poem she made at school.

Note: The behavior observed is the fighting of Kathy with her younger sister. Any entry (row) on the chart refers to a time in which an episode of fighting with her younger sister.

Chart B Episodes of Playing Cooperatively

<i>Time/day/date</i>	<i>Antecedents situation/setting conditions/others present</i>	<i>Consequences</i>
Monday, 7:00 P.M.	Watching TV; Bill (husband) and I watching with them	None
Tuesday, 4:00 P.M.	Watching TV; Marge (neighbor) in the kitchen with me	None
Thursday, 7:30 P.M.	Watching TV; no one else present	Watched until bath time and then went to bed

Note: The behavior observed was playing cooperatively, that is, together in the same room and without fighting. Any entry (row) on the chart refers to a time (5 minutes or more) in which the sister played cooperatively.

and when the girls were playing a game or watching television together. The consequences usually consisted of the mother intervening to stop the fight, sending Kathy to her room, and remaining in the room with Kathy until she calmed down. Chart B was rather interesting as well. Playing cooperatively was associated with the following antecedent conditions: the presence of another adult in the home (the father or a neighbor visiting the mother) and the time in which one or both parents were also in the room. No consequences systematically followed playing cooperatively. The parents felt that they ought to leave well enough alone—a strategy that is not helpful when one wants to develop specific behaviors. Here the undesired behavior was positively reinforced (with attention, time with mom), and the desired behavior was not.

Using information from the charts, we hypothesized that Kathy's fighting served as an occasion to have private time with the mother. Quite likely, time with the

mother was a positive reinforcer that inadvertently contributed to or maintained fighting. Kathy's interest in attention from the mother, obviously "normal" for any child, was heightened according to the mother, because of the strong sibling rivalry she had felt since her younger sister was born. Also of interest were the observations (Chart B) that playing cooperatively among the two children was not systematically associated with positive consequences.

Based on the baseline observations of the target behaviors (fighting, playing cooperatively) and the use of the charts, we generated the following simple hypothesis. Kathy's fighting served to provide time alone with her mother. The fighting only occurred when the mother was home without another adult because only on these occasions was the mother likely to provide the private and alone time with Kathy. That is, the mother probably was less likely to leave conversations with the husband or visiting friend even when Kathy was fight-

ing. We decided to begin directly with a simple intervention to test this hypothesis.

The intervention consisted of providing positive reinforcement (time with the mother) for cooperative play and time out from reinforcement (a period of time when opportunities for reinforcement were removed) for Kathy for fighting. When the girls came home from school/day care, Kathy was told she and the mother could have some play time together if she and her sister played cooperatively for 30 minutes. (Time alone also was provided afterwards with the sister.) Briefly, after the time elapsed without fighting, the mother effusively praised the girls and then played with Kathy in her room. If Kathy had a tantrum, she was sent to her room for 10 minutes and the mother did not remain in the room with her. Requiring longer periods of cooperative play to earn time with the mother and adding father and mother praise for cooperative play essentially eliminated all fighting within the first five days of the program. The functional analysis was helpful in conveying the many factors associated with fighting and suggesting what might be used to increase cooperative play.

In this simple example, the initial assessment suggested a pattern of factors related to the behavior. The pattern suggested a hypothesis, and this led directly to an intervention. In research, there is a separate step of testing the hypotheses experimentally before moving into the intervention. Usually, the tests are conducted in controlled laboratory conditions. The conditions are sometimes referred to as analogue testing because the behavior and events associated with it are evaluated in a contrived situation that is only roughly analogous to conditions in everyday life. Yet, if the laboratory conditions can identify and isolate possible influences (antecedents and consequences), these conditions are likely to exert similar effects in everyday life.

Several studies have evaluated self-injurious behavior among children and adults diagnosed with autistic disorder. A challenge has been eliminating such behavior. Functional analyses have evaluated several possible controlling factors. Three possibilities have been evaluated frequently, including (1) social attention provided for self-injurious behavior (i.e., positive reinforcement), (2) escape from the situation to reduce demands from others (i.e., negative reinforcement), or (3) the stimulation resulting from the behavior itself (i.e., reinforcement from tactile stimulation). Assessment is conducted for brief periods by an experimenter who presents these conditions in alternating order.

Each condition might be presented for one to several 10-minute periods. Plotting data separately for each condition often shows that one of the conditions is associated with changes in self-injury and others are not. More often than not escape from task demands seems to negatively reinforce self-injury. That is, the rate of self-injury is much higher when the experimenter ends the task as the person engages in self-injury. Once this is demonstrated, one can make escape from task demands contingent on noninjurious behavior rather than injurious behavior. Escape reinforces positive behavior, and in this way self-injury is no longer reinforced and can be eliminated.

Functional analysis represents a significant contribution of applied behavior analysis. The analysis can suggest specific antecedent conditions that promote or give rise to the behavior as well as identify the consequences maintaining behavior. Scores of demonstrations have shown how functional analysis can be used to identify controlling influences and then move to an effective intervention (see Sturmey, 1996). Consequently, a main benefit of functional analysis is in the treatment gains that have been achieved in many applications of reinforcement, punishment, and extinction.

Functional analysis is not merely a method of assessment and intervening but also a way of thinking about behavior. The way of thinking alerts us to the importance of considering a range of antecedents and consequences that may influence behavior. Also, the method provides a way of testing hypotheses to help the individual client. What in fact is controlling behavior, and how can this be translated into effective treatment? Functional analysis provides a means for answering these questions.

Functional analysis also provides a methodology for addressing important complexities of behavior. The first of these is that two (or more) individuals may be performing identical behaviors (e.g., getting into fights at school on the playground, coming late to work or to class, arguing with one's boyfriend or girlfriend), but for quite different reasons. Moreover, a given child may engage in two or more quite different behaviors that in some way serve the same purpose. For example, a child may have a tantrum at the dinner table every night and also get into trouble at school and be placed on detention. These are quite different behaviors; they bear no obvious resemblance, and they occur in different settings. It is possible that they serve a similar function, which might be, for example, that both bring the mother and father together to discipline the child.

Conducting a functional analysis is not always feasible. Also, controlling factors may not be obvious or evident in the day-to-day life of an individual if, for example, the consequences are intermittent or the behavior is reinforced by its own performance (e.g., the stimulation it provides). Detailed analyses and extended observations may not be feasible, either because the resources for observation are limited or because of the urgency to intervene (e.g., to stop a child's fighting).

Many of the techniques based on reinforcement, punishment, and extinction, and other contingency manipulations have proven to be enormously effective in situations in which functional analyses have *not* been done. This is useful to know especially because systematic but simple interventions are often surprisingly effective if they are carried out systematically. Even so, functional analysis has provided a powerful tool to identify the current factors in the environment that control behavior and to move to an intervention phase in which these factors are altered to promote prosocial and adaptive behavior.

D. Evaluation and Single-Case Designs

Assessment of the target behavior(s) is quite valuable for identifying the scope of the problem, and possible factors contributing to the problem as well as for evaluating whether there has been a change over the course of the intervention. Assessment may reveal that a change has occurred, but it does not show what *caused* the change. Proponents of applied behavior analysis are extremely interested in determining the causes of behavior change. The short-term benefits of interventions to the individual client and the long-term benefits of interventions for society at large will derive from understanding what produces change, the bases or reasons for the change, and the factors that one might alter to optimize the change. The prior comments on functional analysis convey explicitly how assessment can be used to identify factors that control behavior and then how this information is used to develop effective interventions. Evaluating the basis or reason for change extends beyond functional analysis. Whether or not one conducts a functional analysis, there is an interest in evaluating whether the intervention was responsible for change.

The cause of behavior change can be demonstrated in different ways. The clinical investigator who designs the intervention usually plans the situation to identify whether the intervention was responsible for

behavior change. The plan to demonstrate the cause of behavior change is referred to as the experimental design. The purpose of the experimental design is to identify the variables that influence, control, or are responsible for behavior change. In applied behavior analysis, this is referred to as the demonstration of a functional relation between the target behavior and the intervention. A functional relation is demonstrated when altering the experimental condition or contingency systematically changes behavior. Behavior is shown to be a function of the environmental events that produced change.

Different experimental designs can be used to show that the intervention, rather than extraneous events, was responsible for behavior change. The designs are referred to as single-case experimental designs. These designs are true experiments, which means that they represent a strong basis for drawing causal inferences. Although such designs can be used with large groups of individuals, their unique characteristic is that they can be used with individual cases (e.g., one patient or student). In single-case research, inferences are usually made about the effects of the intervention by comparing different conditions presented to one or a few individuals over time.

There are a number of basic requirements that single-case experimental designs share and that are fundamental to understanding how conclusions are drawn. The most fundamental design characteristic is the reliance on continuous assessment, that is, repeated observations of performance over time. The client's performance is observed on several occasions, usually before the intervention is applied and continuously over the period while the intervention is in effect. Typically, observations are conducted on a daily basis or at least on multiple occasions each week. These observations allow the investigator to examine the pattern and stability of performance. The pretreatment information over an extended period provides a picture of what performance is like without the intervention. When the intervention eventually is implemented, the observations are continued and the investigator can examine whether behavior changes coincide with the intervention. There are a number of experimental designs in which causal relations can be drawn between the intervention and behavior. An example of one design is provided here to illustrate the approach.

The multiple-baseline design demonstrates the effect of an intervention by showing that behavior change accompanies introduction of the intervention at different points in time. The key feature of the design is evalua-

tion of change across different baselines. Ideally, change occurs when the intervention is introduced in sequence to each of the baselines. Multiple-baseline designs vary depending on whether the baselines refer to different behaviors, different individuals, different situations, or time periods. For example, in the multiple-baseline design across behaviors, a single individual or group of individuals is observed. Data are collected on two or more behaviors, each of which eventually is to be altered. The behaviors are observed daily or at least on several occasions each week. After each of the baselines shows a stable pattern, the intervention is applied to only one of the behaviors. Baseline conditions remain in effect for the other behaviors. The initial behavior to which treatment is applied is expected to change, while other behaviors remain at pretreatment levels. When the treated behavior stabilizes, the intervention is applied to the second behavior. Treatment continues for the first two behaviors, while baseline continues for all other behaviors. Eventually, each behavior is exposed to treatment but at different points in time. A causal relation between the intervention and behavior is clearly demonstrated if each behavior changes only when the intervention is introduced and not before. (Examples of multiple-baseline designs are presented later in the chapter.)

Multiple-baseline designs are user friendly in clinical and other applications because the intervention is applied in a sequential fashion. The investigator may wish to change many different behaviors of an individual, a behavior of an individual across many different situations, or the behavior of many different individuals. Rather than introducing the intervention to all of these at once, the program initially focuses on only one behavior, situation, or individual. If the intervention is effective, then it can be extended to all of the other behaviors for which change is desired. As importantly, if the intervention is ineffective or insufficiently effective to achieve important changes, it can be altered or improved before it is extended.

Implementing a single-case experimental design during an intervention program is not always possible because of constraints of the situation. There are, however, many designs, some of which are more feasible and flexible than others. Whether or not a formal design or some approximation is used to evaluate the causal influence of the intervention, in applied behavior analysis some evaluation is conducted. It is essential to see if behavior changes occur with treatment, if these changes are important (i.e., have a palpable impact on the problem), and, to the extent possible, if the

intervention is likely to be responsible for change. Among approaches to treatment, the collection of ongoing data during the intervention, the use of this information to make changes in treatment, and the experimental evaluation of intervention effects are rather unique.

Use of the information collected during treatment and as part of an evaluation of that treatment warrants additional comment. Continuous assessment, unique to single-case designs, provides the investigator or clinician with feedback regarding how well the intervention is working. This is perhaps the main applied advantage of single-case designs, namely, the ability to see how or whether treatment is working and making changes as needed while the treatment or intervention is still in effect. Indeed, the success of interventions studied in applied behavior analysis not only stems from powerful procedures (e.g., reinforcement), but also from being able to identify weak treatment effects early and rectifying them. Clearly, the main advantage of the designs is that they allow careful investigation of an individual client. Thus, both the target focus and the interventions can be individualized to the circumstances and situation of the individual.

IV. EMPIRICAL STUDIES

Many different techniques can be derived from operant conditioning principles. It is not possible to review the evidence for each technique variation because of the scope of applications and weight of the evidence (see Further Reading). Examples are provided to illustrate the approach, selected techniques, and the type of evidence used to demonstrate effectiveness.

A. Reinforcement

Techniques based on positive reinforcement serve as the core interventions of applied behavior analysis. If the goal is to develop positive, adaptive behavior, reinforcement is obviously suitable because reinforcement operates to increase the behavior. Even if the goal is to reduce or eliminate behavior (e.g., stealing, aggression, gambling), positive reinforcement usually plays a central goal. Developing positive, prosocial behavior is effective as a way of eliminating or reducing maladaptive behavior. The positive prosocial behaviors that are reinforced are often opposite to or incompatible with the undesired behavior, so that increasing such behaviors (e.g., positive marital communication)

can be quite effective as a way of reducing undesirable behavior (e.g., arguing).

Intervention programs based on positive reinforcement have used attention, praise, feedback, and activities in which people like to engage as the reinforcing consequences for behavior. Often, multiple reinforcers are incorporated into a single program, referred to as a token economy. In a token economy, tokens function in the same way that money does in national economies. Tokens are earned and then used to purchase backup reinforcers, such as food and other consumables, activities, and privileges. The basic requirements of a token economy include specification of (1) the target behaviors, (2) the number of tokens that can be earned for performance of the behaviors, (3) the backup reinforcers that are available, and (4) the number of tokens the backup reinforcers cost.

As an illustration, token economies have been used extensively in psychiatric hospitals. In one of the most carefully evaluated programs, patients received tokens (colored plastic strips) for such behaviors as attending activities on the ward, group meetings, and therapy sessions; grooming, making one's bed, showering, and engaging in appropriate mealtime behaviors; and socially interacting. Tokens could be exchanged for a variety of backup events such as purchasing cosmetics, candy, cigarettes, and clothing; renting chairs or bedside stands for one's room; ordering items from a mail-order catalog; using a piano, record player, or radio; spending time in a lounge; watching television; having a private room, and sleeping late. As patients improved in the ward, they advanced to higher levels within the program, in which more reinforcers were available and higher criteria were set for performance. Patients could "buy" themselves off the system by doing well, and each carried a "credit card" that allowed free access to all of the available reinforcers as long as personal performance was up to standards. The program was very successful in reducing bizarre behaviors, improving social interaction and communication skills, and developing participation in activities. The gains were reflected in the number of patients discharged and in their adjustment in the community from one and a half to five years after the program ended.

Token reinforcement can be used with a group or with one or two individuals. For example, a token system was used to treat patients referred for drug addiction. Two adult males (Phil, age 28; Mike, age 35) were seen separately for cocaine addiction. Both also used marijuana, which apparently is the case for 40 to 50 percent of persons addicted to cocaine. Assessment of

cocaine and marijuana use was accomplished by urinalyses that detected use within the previous 72 hours. Assessment was conducted four times a week to provide opportunities for earning tokens. Points were provided when the assessment indicated no sign of cocaine use. Bonus points were given for extended periods without a sign of drug use. Points could be exchanged for small amounts of money or goods and services, including movie tickets, sporting events, ski-lift tickets, and dinner certificates. The purpose of using these backup rewards was not only to imbue the points with value but also to involve the individuals in prosocial activities and, it was hoped, to develop a reinforcing, drug-free lifestyle. After 12 weeks of the program, a maintenance phase was initiated to reduce the frequency of the checks on drug use. In the final phase, marijuana use was added to the program. To earn tokens, the tests had to show that the individual did not use cocaine or marijuana.

Figure 1 plots the number of negative urine specimens (no sign of drug use) in a cumulative graph for each person. The figure shows that when reinforcement was given for cocaine abstinence, tests for cocaine use were negative. Marijuana continued to be used until the final phase, in which abstinence from both cocaine and marijuana was reinforced. The sequence of interventions across two individuals seen at the clinic and across two drugs follows the criteria of a multiple-baseline design. The pattern suggests that the token reinforcement program was responsible for the change. Followup assessment, including reports from others (girlfriend, roommate) and from the clients themselves, indicated no use of cocaine but some occasional use of marijuana.

The adaptability of the token economy can be illustrated by moving from the focus on one or two individuals, in the previous example, to a larger-scale application in business and industry. For example, in one study the focus was on worker safety. The study was conducted at two open-pit mines, one in Wyoming and the other in Arizona. Uranium was extracted and processed at one of the mines; coal was extracted and processed at the other. The two mines used similar equipment (trucks, bulldozers) and procedures (strip mining, crushing, storing materials). The goals of the program were to decrease job-related injuries, days lost from work due to such injuries, and costs (due to medical care, insurance, and equipment damage) among employees in each mine.

An incentive in the form of tokens (trading stamps) was provided at the end of each month to workers who

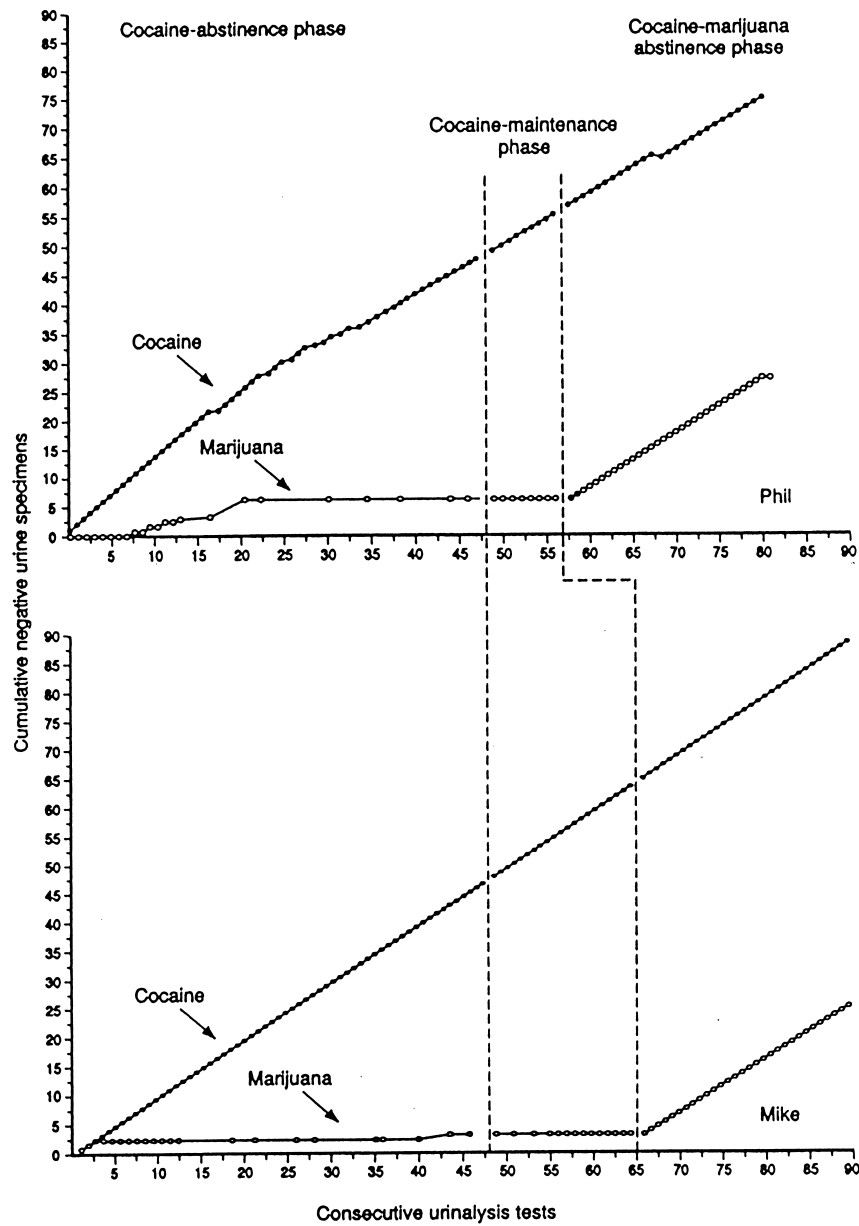

FIGURE 1 Cumulative number of negative cocaine and marijuana urinalysis results obtained with Phil and Mike during three phases of treatment as a function of tests conducted throughout treatment. Cocaine and marijuana test results are presented by closed and open symbols, respectively. Steep slopes in the cumulative record indicate change; horizontal lines indicate no change. [Budney, A. J., Higgins, S. T., Delaney, D. D., Kent, L., & Bickel, W. K. (1991). Contingent reinforcement of abstinence with individuals abusing cocaine and marijuana. *Journal of Applied Behavior Analysis*, 24, 657–665.]

had not been injured or had not required medical care because of an accident. Trading stamps were also given to all members of a group that worked under a particular supervisor if no one in the group had been injured.

Bonus stamps were available to workers whose suggestions for improving safety in the facility were adopted. Trading stamps could also be lost (response cost) for missing work due to injury or for causing an accident.

The trading stamps could be exchanged at a nearby redemption center that carried hundreds of items, such as small appliances, barbecue grills, spice racks, and clocks. The program was introduced to each mine in a multiple-baseline design and integrated with the mine's routine practices for several years. Figure 2 shows a marked reduction in the number of accidents among workers (upper panel) as well as a reduction in monetary costs to the company (lower panel).

Token economies have been used with a variety of populations, including persons with mental retardation, prisoners, geriatric or nursing home residents, persons who abuse alcohol and drugs, outpatient children and adults, and members of the armed forces (e.g., in basic training). Similarly, the various settings in which token economies have been applied include the home, schools, institutions, hospitals, day-care centers, nursing homes, and business and industry. Probably the setting most often used is in the home where parents use points, marks on a chart, or stars on a temporary basis to foster behaviors such as completing chores, homework, and taking care of pets. Simple reinforcement programs are an excellent way to manage behavior, to move away from nagging, reprimands, and punishment in general. Usually in such applications tokens are not "needed." That is, the behavior could be changed with prompts, praise, and shaping. Yet, the tokens provide a useful way to structure and prompt parent behavior so that the consequences are applied systematically.

The discussion of reinforcement has emphasized token reinforcement because this is an adaptable system for integrating several behaviors and reinforcers. In many applications, reinforcers such as praise and privileges have been extremely effective in changing the behavior of children, adolescents, and adults in the diverse settings, mentioned previously. Apart from the diversity of reinforcers (e.g., praise, activities), programs can vary on whether the reinforcers are delivered on the basis of how the individual or group performs and who administers the program (e.g., parents, teachers, peers). Indeed, the range of options accounts for the broad applicability of reinforcement procedures. For example, in school settings, peers (older classmates at the school) often are involved in administering reinforcers to others for academic behavior (e.g., completing assignments correctly) or social interaction (e.g., appropriate initiations of contact with others). Peer-administered reinforcement programs have been effective in many applications. Interestingly, the individual whose behavior is reinforced changes, as would be expected. In addition, the peers

who administer the program often show marked improvements in the target behaviors and hence share in the benefits of the intervention.

B. Punishment

The types of aversive events used and how they are applied in behavioral programs differ greatly from punishment practices in everyday life. In behavioral interventions, rarely is punishment used by itself. Rather, punishment is part of a larger program based on positive reinforcement that develops adaptive behavior. There are many reasons for emphasizing positive reinforcement, even when the goal is to suppress or eliminate some undesirable behavior. Perhaps most significantly, deviant behavior often can be eliminated effectively with little or no punishment. There are a variety of ways of delivering reinforcement to support behaviors incompatible with the deviant behavior that work quite well to eliminate undesired responses.

Punishment is also deemphasized because it does not train an individual regarding what to do. Merely suppressing behavior and training the individual in what not to do will not necessarily foster the desired or appropriate behaviors. Indeed, without an effort to develop behaviors through positive reinforcement, punishment may not be very effective as a way of changing behavior in the long term. The suppressed responses are likely to return unless some other behaviors have replaced them.

Punishment often is associated with undesirable side effects, such as emotional reactions (crying), escape from and avoidance of situations (e.g., staying away from a punitive parent), and aggression (e.g., hitting others). None of these is necessary for behavior to change. Punishment can foster undesirable associations with regard to various agents (parents, teachers), situations (home, school), and behaviors (doing homework). An important objective in child rearing, education, and socialization in general is to develop positive attitudes and responses toward these agents, situations, and behaviors; their frequent association with punishment may be counterproductive. For example, screaming at a child to practice a musical instrument is not likely to develop a love of music. For all of these reasons, programs emphasize positive reinforcement.

Proponents of behavioral techniques are extremely concerned with abuse and misuse of punishment. Such abuse and misuse have been shown to foster serious problems in children and adolescents. For example, use of harsh punishment in the home is related

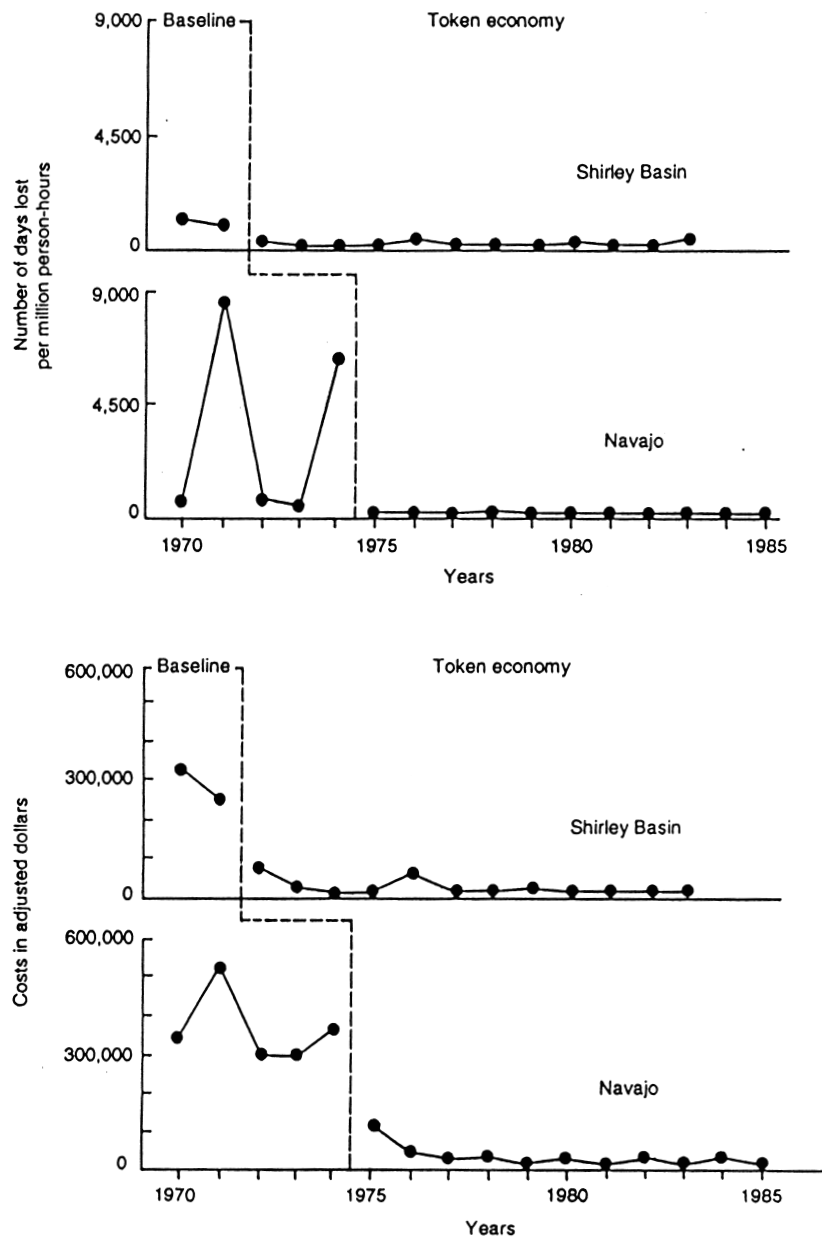

FIGURE 2 Yearly number of days lost from work per million person hours worked, resulting from work-related injuries (upper figure) and yearly cost, adjusted for hours worked and inflation, resulting from accidents and injuries (lower figure). [Fox, D. K., Hopkins, B. L., & Anger, W. K. (1987). The long-term effects of a token economy on safety performance in open-pit mining. *Journal of Applied Behavior Analysis*, 20, 215-224.]

to later deviant and delinquent behavior of the child. Both physical and verbal punishment (reprimands) can increase the very behaviors (noncompliance, aggression) that parents, teachers, and others wish to suppress.

In applied behavior analysis, when punishment is used, it usually consists of withdrawing positive events. The most commonly used form is time out from reinforcement, which refers to the removal of a positive reinforcer for a brief period of time (e.g., a few minutes).

During the time-out interval, the client does not have access to the positive reinforcers that are normally available in the setting. For example, a child may be isolated from others in class for five minutes. During that time, he or she will not have access to peer interaction, activities, privileges, and other reinforcers that are usually available.

A variety of time-out procedures have been used effectively. In many variations, the client is physically isolated or excluded in some way from the situation. The client may be sent to a time-out room or booth, a special place that is partitioned off from others (in the classroom, at home, or in an institution). In other variations, the client is not removed at all. For example, in one variation, developed initially in a special education classroom, children received praise and smiles (social reinforcement) from the teacher for performing their work. Each child in the class was given a ribbon to wear around his neck. The ribbon signified to the child and the teacher that the child could receive social and, occasionally, food reinforcers that were administered while the children worked. When any disruptive behavior was performed, time out was used. It consisted of removing the child's ribbon for three minutes. Without the ribbon, the child could not receive any of the reinforcers normally administered (e.g., attention from the teacher). This time-out procedure effectively reduced disruptive classroom behavior.

In general, time out provides an excellent alternative to many of the forms of punishment used in everyday life, such as reprimands and corporal punishment. Very brief time out, for several seconds or a few minutes, has been effective. Longer periods of time out (e.g., 10, 20 minutes) do not necessarily increase the effectiveness of the procedure. Indeed, brief and contingent time out is quite effective, especially if many reinforcers are available in the setting and these are administered for positive behavior.

Another punishment procedure is referred to as response cost and also consists of loss of a positive reinforcer. Response cost entails a penalty of some sort contingent on behavior. With response cost, there is no time period during which positive events are unavailable, as is the case with time out. Typically, response cost consists of a fine. Examples of response cost in everyday experience include fines for traffic violations or overdue books, fees for late filing of income tax or for registering for classes beyond the due date, and charges for checks that "bounce." (Although these examples illustrate response cost, the examples do not reflect punishment administered in ways that maximize behavior

change. Conditions to maximize the impact of response cost include immediacy and schedule of the fine and reinforcement for alternate behavior, to mention a few.) In applied behavior analysis, fines usually consist of loss of tokens (chips, stars, points) that are provided for positive behavior in a token economy.

As an example, response cost was used to reduce aggressive and disruptive behavior in the classroom of four preschool boys (ages 3–5). The children engaged in such behaviors as throwing things, damaging other children's materials, hitting, and screaming. Response cost consisted of providing a child with five laminated smiley faces attached to a larger sheet. The chart was labeled Good Behavior Chart and posted in the classroom for all to see. Each time the child engaged in one aggressive behavior, a smiley face was taken away. The teacher stated the reason for the loss of the smiley face and provided a reprimand. If the child retained at least one smiley face at the end of the 40-minute period, he could purchase special rewards (e.g., being the teacher's helper, access to a favorite toy). Consistent performance over at least four or five days was reinforced with additional incentives (a special grab bag). Response cost was introduced in a multiple-baseline design across children. As is evident in Figure 3, aggressive behavior changed markedly as the intervention was introduced.

Many other punishment procedures are available such as the contingent use of effort (tasks, chores), loss of privileges, and requiring individuals to rectify or correct the situation their behavior may have altered. As noted previously, the primary use of punishment in applied behavior analysis is as a supplement to a positive reinforcement program. Punishment by itself raises all sorts of objections and concerns and often is not very effective. However, mild punishment (e.g., brief time out, response cost) when supplemented with positive reinforcement for prosocial behavior can be extremely effective. Although reinforcement by itself can often be used to eliminate undesirable behaviors, the addition of very mild punishment often augments the effectiveness of the reinforcement program.

A difficulty in using punishment at all is that people familiar with punishment in every day life may implement aversive events in ways that do not enhance efficacy or that promote problems (e.g., screaming, hitting, trying to evoke emotional responses). Shouting, hitting, screaming, making threats, or shaking someone, not all that rare in the home and classroom and indeed in parent-child and

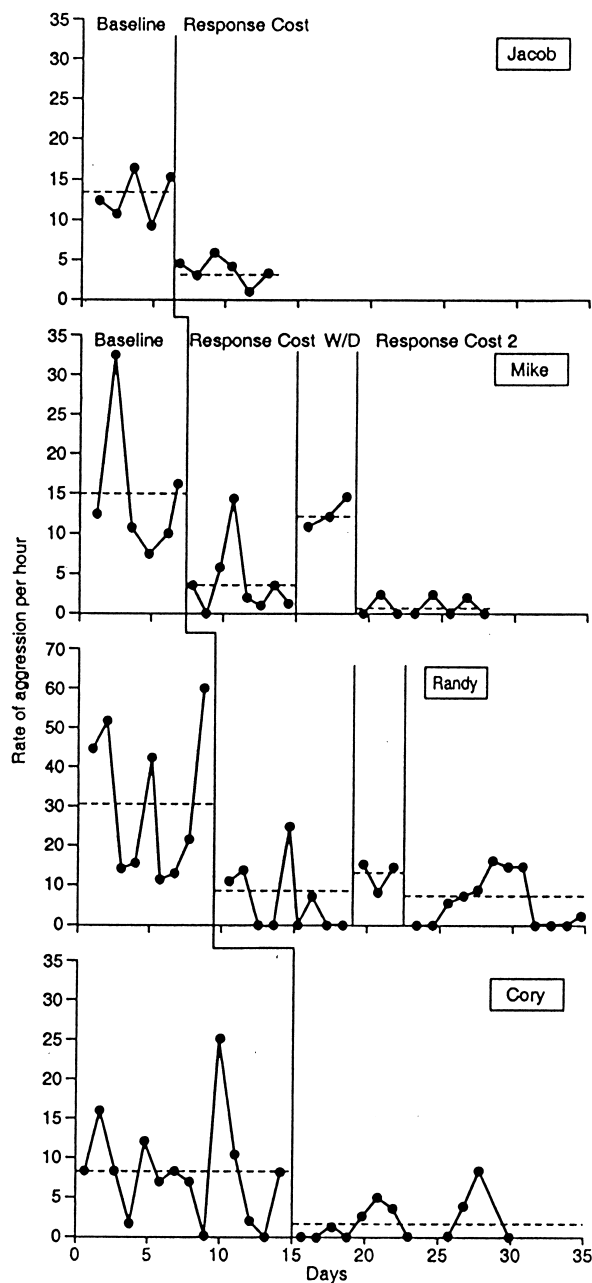

FIGURE 3 Rate of aggressive behavior during baseline and treatment conditions across subjects. [Reynolds, L. K., & Kelley, M. L. (1997). The efficacy of a response cost treatment package for managing aggressive behavior in preschoolers. *Behavior Modification*, 21, 216–230.]

spouse–spouse interactions, are not events used in applied behavior analysis. A danger of implementing punishment is that well-designed programs (e.g., two minutes of time out contingent on behavior), if not

monitored carefully, may drift into one of these other punishment procedures.

C. Extinction

Many maladaptive behaviors are maintained by consequences that follow from them. For example, temper tantrums or interrupting others during conversations are often unwittingly reinforced by the attention they receive. When there is interest in reducing behavior, extinction can be used by eliminating the connection between the behavior and the consequences that follow. Extinction refers to withholding reinforcement from a previously reinforced response. A response undergoing extinction eventually decreases in frequency until it returns to its prereinforcement level or is eliminated.

Extinction has been successfully applied to diverse problems. As an illustration, extinction was used to reduce awakening in the middle of the night among infants. Nighttime waking, exhibited by 20 percent to 50 percent of infants often is noted as a significant problem for parents. Parents may play a role in sustaining night waking by attending to the infant in ways that reinforce the behavior. In this program, parents with infants (8 to 20 months old) participated in an extinction-based program to decrease nighttime awakening. Waking up during the night was defined as a sustained noise (more than one minute) of the infant between onset of sleep and an agreed-upon waking time (such as 6:00 A.M.). Over the course of the project, several assessment procedures were used, including parent recording of sleep periods, telephone calls to the parents to check on these reports, and a voice-activated recording device near the child's bed. After baseline observations, parents were instructed to modify the way in which they attended to night wakings. Specifically, parents were told to ignore night wakings. If the parent had a concern about the health or safety of the child, the parent was instructed to enter the room, check the child quietly and in silence with a minimum of light, and to leave immediately if there was no problem.

The program was evaluated in a multiple-baseline design across seven infants. Figure 4 shows the frequency of night wakings each week for the children during the baseline and intervention periods. As is evident in the figure, the frequency decreased during the intervention period. Followup consisted of assessment approximately three months and then two years later, which showed maintenance of the changes. The figure is instructive for other reasons. Two weaknesses of extinction programs were evident. First, extinction effects tend to be gradual.

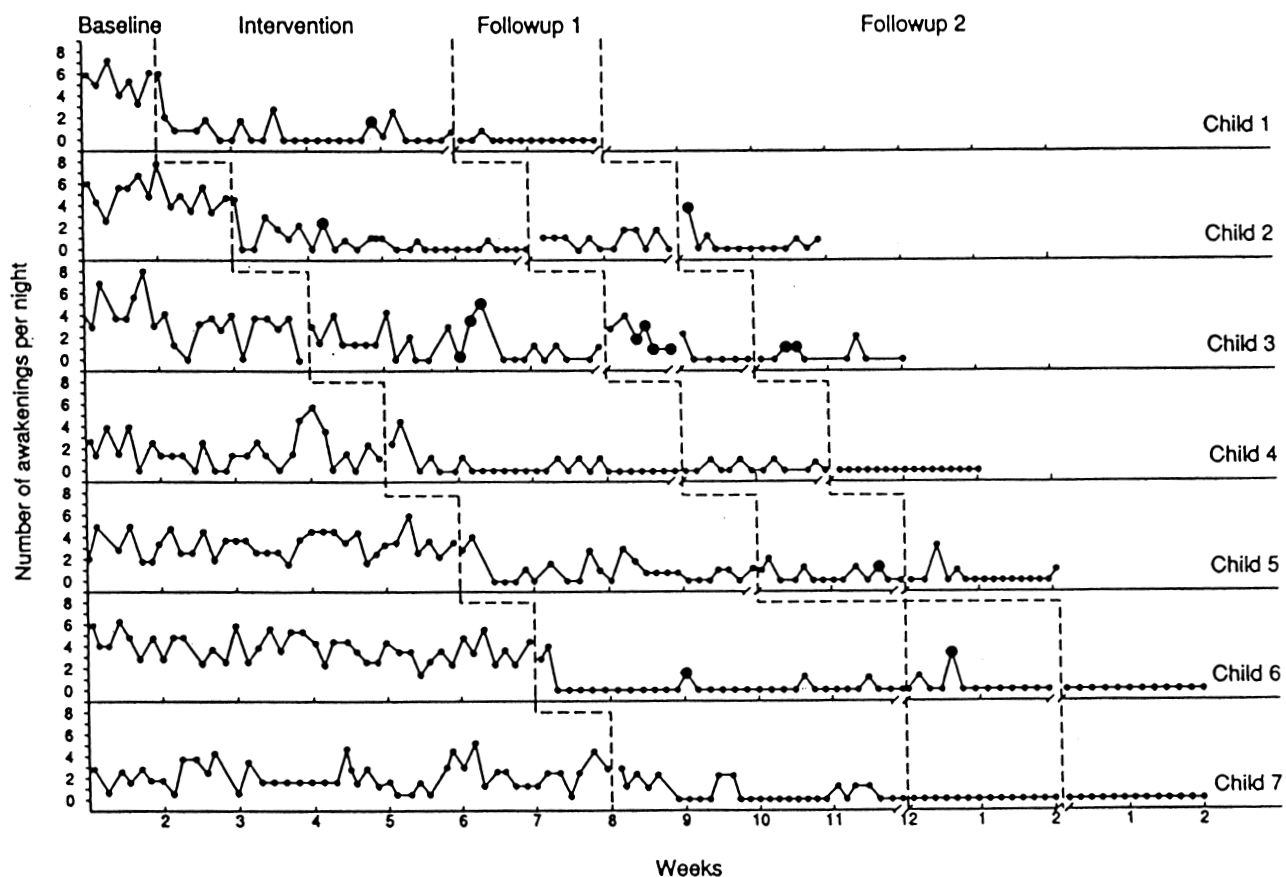

FIGURE 4 Frequency of night wakings per week for seven infants treated with extinction. The program was evaluated in a multiple-baseline design across infants. Followup 1 and 2 represent evaluation at three months and two years after the initial intervention program, respectively. The solid, large dots denote nights in which the infant was ill. [France, K. G., & Hudson, S. M. (1990). Behavior management of infant sleep disturbance. *Journal of Applied Behavior Analysis*, 23, 91-98.]

Second, during extinction the behavior may momentarily recover (i.e., emerge for one or two occasions) even though it has not been reinforced, a phenomenon referred to as spontaneous recovery. Figure 4 shows both the gradual nature of extinction and repeated instances of spontaneous recovery during the intervention and followup phases. The prospect of accidental reinforcement (e.g., attention to the behavior) during these periods requires special caution on the part of parents.

A related issue pertains to Child 3 (in Figure 4), who did not profit from the program. Parents reported difficulty in distinguishing the usual night wakings from those associated with illness of their child. Additional data revealed that these parents attended relatively frequently to nonillness awakenings during the intervention but improved during the first followup phase. The parents cannot be faulted. The pattern of behavior and eventual improvement draw attention to the difficulty

in ignoring behavior and discriminating when behavior does and does not warrant attention. In any case, the demonstration is clear in showing that extinction generally was quite effective in decreasing night waking among infants.

Typically, extinction is used in conjunction with positive reinforcement. The main reason is that the effectiveness of extinction is enhanced tremendously when it is combined with positive reinforcement for behavior incompatible with the response to be extinguished. Also, the gradual effects of extinction, the emergence of the undesired behavior (spontaneous recovery), and untoward side effects are mitigated when extinction is combined with positive reinforcement. A limitation of extinction is that it is not always easy (without functional analysis) to identify what reinforcers are maintaining behavior, especially if the reinforcers are quite intermittent and hence not evident each time the be-

havior occurs. As with the use of punishment, extinction by itself does not teach the positive behaviors to be developed and may be associated with undesirable side effects. For all of these reasons, extinction usually is combined with positive reinforcement for appropriate or prosocial behavior.

Many reports have shown the successful application of extinction alone or in conjunction with other procedures (particularly reinforcement). Hypochondriacal complaints, vomiting, obsessive comments, compulsive rituals, and excessive conversation in the classroom are among the diverse problems that have been treated with extinction and reinforcement. Such applications are particularly noteworthy because they reveal that a number of maladaptive behaviors may be maintained at least in part by their social consequences.

D. General Comments

Interventions based on positive reinforcement, punishment, and extinction, merely sampled in this contribution, have been quite effective among diverse clients, settings, and target behaviors. The effectiveness can be traced to two features of applied behavior analysis. First, the principles of operant conditioning reflect potent influences on behavior. Positive reinforcement, for example, has a strong influence on behavior and has been demonstrated across multiple species and circumstances. Experimental and applied research have identified many of the conditions on which effective applications depend (e.g., immediacy and schedule of delivering consequences). Consequently, there are clear guidelines on how to apply many of the interventions effectively.

Second, the assessment and evaluation of applied behavior analysis contributes directly to program effectiveness. Ongoing measurement is made of client performance, whether the problem is changing, and to what extent. This means that during the intervention, weak, mediocre, or no effects of treatment can be identified and remedied. There are scores of applications in which programs produced mediocre effects. Alterations or additions were made in the program that then achieved the desired changes. Other approaches to treatment usually do not provide ongoing assessment and hence do not have the benefit of this immediate feedback to help decision making in treatment. Related, functional analysis is a special way in which assessment, evaluation, and intervention are interrelated. With functional analysis, the factors that are maintaining an undesired behavior or not supporting a desired behavior can be precisely identified. When functional

analysis is possible, current causes of behavior are demonstrated and the information is used to develop an effective intervention.

V. APPLICATIONS

Perhaps one of the most striking features of applied behavior analysis is the scope of applications. Table 6 samples some of the applications to illustrate the breadth of the approach. Interventions have been carried out in diverse settings such as the home, at school, institutions (hospitals, rehabilitation centers, nursing homes), business and industry, and the community. Indeed, it is safe to say no other psychological intervention or approach has been applied as widely to human behavior.

The focus of behavior analysis is often on the individual. Indeed, this is strongly suggested by reliance on single-case experimental designs. Already mentioned was the fact that these designs can be applied to groups or to interventions implemented on a large scale. For example, one program (Behavior Analysis Follow Through Project) was implemented in elementary school grades over a period of several years and grade levels. The program included more than 7,000 children in approximately 300 classrooms (from kindergarten through third grade) in 15 cities throughout the United States. The program relied heavily on token reinforcement to promote academic performance and several other components, such as instructing children in small groups within the class, using academic curricula that permitted evaluation of student progress, specifying performance criteria for teachers and students, and providing special training and feedback to teachers regarding their performance and the progress of their students. The gains in academic performance of students who participated in the program were markedly greater than were the gains of students in traditional classrooms. Moreover, those gains were still evident two years after the program had been terminated and the children in the program had entered classrooms where token reinforcement was not in effect.

In large-scale programs, as for example with all people who work in a corporation, who live in a particular city or neighborhood, or who live in a dormitory, it may not be feasible to provide consequences (e.g., positive reinforcers) based on the performance of each individual. Difficulties in monitoring individual performance or insufficient resources to administer reinforcers to each individual raise special obstacles. Yet, in such circumstances, group contingencies may play an especially

TABLE 6
Sample of the Scope of Applications of Applied Behavior Analysis

<i>Context/setting</i>	<i>Interventions have been effective in ...</i>
Therapy/treatment settings	Treating a broad range of psychological problems and psychiatric disorders including anxiety (e.g., fears, obsessive compulsive disorders, panic attacks), depression, substance use and abuse (e.g., drug, alcohol, cigarettes), conduct problems, hyperactivity, autism, and eating disorders.
Education	Improving academic performance, studying, achievement, grades, classroom deportment, creative writing, participation in activities, as relevant to elementary, middle, and high school students; mastery of the subject matter at all levels including college students. Many programs in school settings have focused on behaviors beyond the usual domain of education because schools provide a useful place to deliver the interventions. Thus, behavioral programs have been applied to reduce or prevent cigarette smoking, alcohol and drug use, and unprotected sex among adolescents.
Medicine and health	Teaching individuals to detect early signs of disease (e.g., cancer checks through self-examination), protect against sexually transmitted diseases, reduce pain associated with invasive medical procedures (e.g., lumbar taps) or postoperative recovery, and adhere to medical regimens (e.g., for cancer, diabetes).
Business and industry	Teaching workers to engage in practices that reduce accidents (e.g., when using equipment), improve health or overcome problems that compete with health and work (e.g., alcohol use, cigarette smoking). Helping individuals to obtain jobs (e.g., how to seek jobs, interview skills), improve on-the-job performance, reduce absenteeism, tardiness, improve employee customer interactions, and reduce shoplifting among customers.
Sports and athletics	Improving coaching practices, performance of athletes (e.g., in football, gymnastics, tennis, swimming, and track) and stress management among athletes.
Everyday life	Training parents to interact with their children for parents who are in special situations (e.g., handicapped child), for children who are in special situations (e.g., abused, neglected children) and parents without special difficulties or obstacles; training children to engage in safe behaviors (e.g., use of seat belts, crossing streets) or ward off dangerous situations (e.g., responding to would-be abductors). Training the elderly in nursing homes to increase physical activity and engage in more social interactions with others. Training individuals to engage in safe-driving practices, conserve energy in homes, and recycle wastes.

important role. For example, in some business organizations, special incentives are provided if a group (e.g., 90 percent of all employees) engages in a behavior of interest (e.g., donates to a charity, participates in an exercise program designed to improve health). In these situations, the interest in developing a particular behavior across many people lends itself well to group contingencies. The effectiveness of such contingencies is evaluated by charting the behavior of the group rather than the performance of one or a few individuals.

VI. ISSUES AND CHALLENGES

Although interventions based on operant conditioning principles have been extremely effective in diverse applications, many issues and challenges emerge in their application. Two salient issues pertain to the de-

mands of implementing the techniques effectively and the importance of ensuring that the behaviors are maintained and transfer to multiple settings or conditions beyond those in which the intervention program was in effect.

A. Implementation and Program Effectiveness

The principles of reinforcement, punishment, and extinction and the techniques derived from those principles are relatively simple. Moreover, the techniques resemble practices used in everyday life, which make the behavior-change programs deceptively simple. For example, parents who are learning behavioral techniques for managing their children invariably note that these techniques are not new and that they have been using the techniques all along. They often

assert that their use of reinforcement (praise or allowance) or time out (sending the child to his or her room) has not worked. Parents are usually correct in this assertion. Yet, careful inquiry or direct observation of parent behavior in the home reveals that the procedures they have tried are faint approximations of the ways in which reinforcing and punishing consequences are used in applied behavior analysis. For example, positive reinforcers need to be contingent on performance and delivered immediately after behavior and on a continuous or close to continuous schedule, especially at the beginning of the program. As important, the target behaviors need to be carefully specified, so that reinforcement can be applied consistently and the results can be measured to see whether the program is having an impact. Rarely are these conditions in place in the causal applications of incentives or disincentives for behavior (e.g., at home or at school).

Interventions usually require consideration of antecedents, behaviors, and consequences and quite specific ways of delivering consequences. In fact, what distinguishes behavior modification techniques from everyday uses of reward and punishment is *how* the techniques are applied and evaluated. Several conditions influence whether reinforcement, punishment, and extinction are effective, and hence the interventions are more than merely providing some consequence for behavior. Once these conditions (e.g., use of prompts, shaping) are faithfully rendered, one may be in a better position to say that the procedures have not worked.

Interventions based on the principles of operant conditioning bring to bear important influences to change behavior. Yet, the techniques do not always achieve the desired outcomes. There have been many instances in which behavioral programs failed to achieve the desired changes. No change may have occurred, or the change may be too small to make an important difference in the lives of the clients or those with whom they interact. The most common reason for program failures pertains to poor, mediocre, and inconsistent implementation of the contingencies. Interestingly, several studies have shown that slight modifications in the program when clients have failed to respond often produce the desired behaviors. In some cases, the changes occur from implementing the program in ways more conducive to producing change (e.g., more immediate reinforcement). In other cases, the procedures are changed. For example, defiant and aggressive child behavior in the home or at school may not be altered by simply having parents praise appropriate child behavior. The undesired behaviors may not decrease until mild punishment (time out, response cost) is added to the contingencies.

A significant challenge is the training of behavior-change agents (e.g., parents, teachers, staff of the institution, peers who carry out the program). Many successful programs have devoted considerable attention to ensuring that these behavior-change agents are well trained. Once these change agents have been trained, their behaviors are often monitored carefully to ensure that the contingencies are carried out correctly. Without careful training and monitoring, the care with which interventions are implemented may deteriorate over time. Assessment and monitoring of those who implement the intervention may need to become a permanent part of the setting (e.g., school, hospital). For example, large-scale applications of behavioral programs in schools often include assessment and monitoring of teacher and student behavior to ensure that the techniques are implemented correctly and that children are learning. The assessment and supervision practices are central to the effectiveness of the procedures, hence, their incorporation as part of the program is critically important. A major challenge is not just changing client behavior, but also changing the behavior of those responsible for implementing the program.

B. Response Maintenance and Transfer of Training

Interventions discussed in this chapter clearly show that behavior can be changed. Two critical questions are whether the changes will be maintained once the special programs are ended and whether the changes during and after the program will extend to settings, situations, or circumstances that were not included in the program. These concerns reflect response maintenance and transfer of training, respectively. Maintenance of behavior changes might not be expected after an intervention program is ended. If the client responds to changes in the contingencies of reinforcement, one might expect changes to be lost after the intervention is terminated. Similarly, if clients make discriminations about the situations in which the intervention is and is not in effect, one might expect changes in behavior to be restricted to those situations in which the program was in effect.

Early in the development of applied behavior analysis, almost exclusive attention was devoted to changing behavior and indeed seeing whether significant behaviors of impaired populations (e.g., persons with mental retardation or psychiatric disorder) could be significantly helped by the interventions. As change became demonstrated in diverse contexts and settings, further attention was accorded to procedures that can be used during a

program to promote response maintenance and transfer of training. Currently, there are several procedures that can be implemented during an intervention program that help to ensure that the desired behaviors are maintained and are not restricted to situations, persons, or settings associated with the intervention when it was initiated. Table 7 highlights several strategies that are used after behavior has been developed to foster maintenance and transfer of the changes.

As an illustration, transfer of training was systematically trained in one program to ensure that the behaviors extended to the situations of interest after training. In this program, adult mentally retarded women were trained in sexual abuse prevention. Sexual abuse of individuals with mental retardation is a significant problem rarely discussed in the media or in the con-

text of sexual abuse more generally. In this project, the investigators trained women to refuse sexual overtures from others, to say no, to leave the situation, to tell the incident to others, and to use similar behaviors when inappropriate approach responses were made to them. Training was conducted with pairs of women in which they practiced the target behaviors (what they would say and do) in a set of hypothetical situations. Training developed the desired behaviors using role play, practice, feedback, and praise. Then tests were provided in a realistic situation in which an unknown male made approach responses. The results revealed that the behaviors developed in the training sessions but did not transfer very well to ordinary situations. Then training was then conducted in more everyday situations with confederates (research assistants

TABLE 7
Selected Strategies to Develop Response Maintenance and Transfer of Training

<i>Technique</i>	<i>Brief description</i>
Programming naturally occurring reinforcers	After behavior has been established with a special program (e.g., token economy), the consequences that are more readily available in the natural environment (e.g., attention from others) are used to influence behavior.
Gradually removing or fading the contingencies	The intervention can be removed or faded by making the consequences increasingly intermittent or more delayed after the behavior is well established. Also, the intervention can be organized into levels so that as behavior is performed consistently, the incentives increase but there is less frequent and immediate control the contingencies exert over behavior.
Expanding stimulus control	During training, the desired behavior may become associated with specific stimulus conditions such as who administers the program, the setting, or circumstances (e.g., time of the day). After behavior is developed, stimulus control can be expanded by introducing a few other instances or examples (e.g., extending the program to more than one time). Behavior changes can be extended generally in this way and not all conditions or circumstances of interest need to be incorporated into training to achieve broad generalization across conditions.
Training the general case	A systematic way of ensuring transfer of training by specifying the set of stimulus situations across which a behavior is to be performed after training has been completed, defining the range of relevant dimensions or characteristics across which they vary, defining the range of response variations or the different behaviors required across the set of stimulus situations, and selecting and teaching examples that sample from the range of the stimulus and response domains of interest.

Note. For elaboration of these methods, see Kazdin, 2001.

working for the study) who made approach responses. As the behaviors developed, training ceased and assessments were made unobtrusively. The results indicated that the behaviors now carried over to everyday situations. In addition, assessment in everyday situations one month after the program ended indicated that the behaviors were maintained. The study conveys the importance of introducing into training the situations to which one wants the behavior to generalize.

Behaviors occasionally are maintained after the program is ended and transfer to novel settings, even if no special procedures are in place to foster these extensions. However, to ensure maintenance and transfer, special procedures often are introduced before the program is completely ended. Typically several procedures (e.g., as those identified in Table 7) are combined to ensure maintenance and transfer and have been shown to be effective in many applications of treatment.

VII. SUMMARY

Applied behavior analysis refers to an approach toward treatment that includes an emphasis on antecedents, behaviors, and consequences and how these can be arranged to promote behavior change and a methodological approach toward assessment and evaluation. The interventions rely on principles of operant conditioning (reinforcement, punishment, extinction, stimulus control) and the scores of techniques that can be derived from these principles. The scope of interventions has been remarkable and encompasses individuals ranging from infants to the elderly in diverse settings (e.g., home, school, nursing homes, facilities for delinquents, prisoners, psychiatric patients, businesses, and the community at large). Also, many medical (e.g., adherence to medication, recovery from surgery, dieting and exercise), psychological problems (e.g., various psychiatric disorders), and educational objectives (e.g., reading, academic competence) have served as target foci. The diversity of applications derive from the generality of the principles and their well-established bases in laboratory research.

Implementing the techniques that derive from the principles represents a significant challenge. Altering the contingencies of reinforcement has special requirements if behavior change is to be achieved. Consequently, the seeming simplicity of the interventions is deceptive. A program involving praise or token reinforcement for behavior can easily succeed or fail based on how systematically and consistently the consequences are provided. The special feature of applied behavior analysis that also

contributes to the effectiveness of the interventions pertains to the systematic assessment and evaluation of behavior-change programs. Collection of ongoing data while the program is in effect allows one to make changes to ensure that the desired outcomes are achieved.

Acknowledgments

Completion of this article was facilitated by support from the Leon Lowenstein Foundation, the William T. Grant Foundation (98-1872-98), and the National Institute of Mental Health (MH59029).

See Also the Following Articles

Classical Conditioning ■ Conditioned Reinforcement ■ Contingency Management ■ Functional Analysis of Behavior ■ Negative Reinforcement ■ Operant Conditioning ■ Positive Reinforcement ■ Response Cost ■ Time-Out ■ Token Economy

Further Reading

- Baer, D. M., Wolf, M. M., & Risley, T. R. (1968). Some current dimensions of applied behavior analysis. *Journal of Applied Behavior Analysis, 1*, 91–97.
- Baer, D. M., Wolf, M. M., & Risley, T. R. (1987). Some still current dimensions of applied behavior analysis. *Journal of Applied Behavior Analysis, 20*, 313–328.
- Bushell, D., Jr. (1978). An engineering approach to the elementary classroom: The Behavior Analysis Follow Through project. In Catania, A. C. & Brigham, T. A. (Eds.), *Handbook of applied behavior analysis* (pp. 525–563). New York: Irvington.
- Iwata, B. A., Vollmer, T. R., & Zarcone, J. R. (1990). The experimental (functional) analysis of behavior disorders: Methodology, applications, and limitations. In Repp, A. C. & Singh, N. N. (Eds.), *Perspectives on the use of nonaversive and aversive interventions for persons with developmental disabilities* (pp. 301–330). Sycamore, Illinois: Sycamore.
- Kazdin, A. E. (1978). *History of behavior modification: Experimental foundations of contemporary research*. Baltimore: University Park Press.
- Kazdin, A. E. (2001). *Behavior modification in applied settings* (6th edition). Pacific Grove, California: Thompson.
- Miltenberger, R. G., Roberts, J. A., Ellington, S., & Galensky, T. (1999). Training and generalization of sexual abuse prevention skills for women with mental retardation. *Journal of Applied Behavior Analysis, 32*, 385–388.
- Paul, G. L., & Lentz, R. J. (1977). *Psychological treatment of chronic mental patients: Mileu versus social learning program*. Cambridge, MA: Harvard University Press.
- Skinner, B. F. (1953). *Science and human behavior*. New York: Free Press.
- Sturmey, P. (1996). *Functional analysis in clinical psychology*. Chichester, England: John Wiley & Sons.

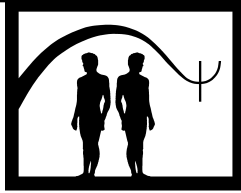

Applied Relaxation

Lars-Göran Öst

Stockholm University

- I. Description of Applied Relaxation
 - II. Theoretical Basis for Applied Relaxation
 - III. Applications and Exclusions
 - IV. Empirical Studies
 - V. Summary
- Further Reading

GLOSSARY

application training The use of rapid relaxation in anxiety-arousing situations to reduce and eventually abort anxiety reactions.

cue-controlled relaxation The association of the cue “Relax” with the state of relaxation.

differential relaxation Practicing being relaxed in those muscles not necessary to tense for the activity at hand.

progressive relaxation The tensing and relaxing of 23 major muscle groups.

rapid relaxation A very brief relaxation used in natural situations to become relaxed quickly (20–30 seconds).

release-only relaxation Relaxing the muscle groups without the prior tension.

I. DESCRIPTION OF APPLIED RELAXATION

A. General Features of Applied Relaxation

Applied relaxation (AR) is a cognitive-behavioral coping technique first described by Chang-Liang and Den-

ney in 1976 and later extensively developed by Lars-Göran Öst during the late 1970s and early 1980s. Applied relaxation takes as its starting point the abbreviated progressive relaxation (PR) developed by Joseph Wolpe in the 1950s as part of systematic desensitization. However, PR is not suitable as a coping technique since it takes 15–20 minutes for the patient to go through the various muscle groups in order to become relaxed. The relaxation has to be reduced into a “portable” skill that patients can use in any situation when needed. Applied relaxation is a technique that in a number of steps teaches patients to relax rapidly, the goal being 20–30 seconds, in natural situations where their problems occur.

The first step of PR training, usually takes 2 weeks of practice and the time to become relaxed is 15–20 minutes. The second step, release-only relaxation, is commonly practiced for 1 week and the time to relaxation is reduced to 5–7 minutes. The third step, cue-controlled relaxation, also requires a week of practice, and relaxation is achieved in 2–3 minutes. The fourth step is differential relaxation, which is practiced for 2 weeks and relaxation is achieved in 1 minute and the time is reduced to 1 minute. The fifth step, rapid relaxation, is also practiced for 2 weeks allowing the patient to become relaxed in 20–30 seconds. The final step, application training, usually takes 2 weeks, and now the rapid relaxation is used in natural anxiety-arousing situations.

1. Rationale for AR

In any cognitive behavior therapy it is important that patients understand the rationale for the treatment in

question. The therapist should give an easily understandable theoretical description regarding the patient's problem and a description of how AR is scheduled and supposed to work. When presenting the treatment rationale it is also useful to give the patients a written version (1–2 pages) that they can read during the presentation and take home to examine more carefully. Below is an example of a rationale that might be used in the treatment of a person with panic disorder.

During a panic attack you are likely to feel very anxious and experience a lot of symptoms, such as palpitations, muscle tension, sweating, breathlessness, and dizziness. Usually, the attack seems to come “out of the blue” in other words without warning, making you want to leave the situation. As you leave and get home to safety the symptoms dissipate, but you are usually exhausted and fear what will happen the next time you have a panic attack.

There is a treatment method called AR that can help you cope with and eventually stop the anxiety symptoms altogether. The first thing you do in this treatment is to observe your panic attacks in order to become aware of the very first sign(s) of a panic attack coming on. The observations are recorded in a panic diary, and over the next couple of months you will realize that even if the panic attack starts rapidly there is usually a period of 30–60 seconds between the first sign and the full-blown panic attack. It is during this period you have a chance to do something to prevent the symptoms from developing further, such as “to nip it in the bud.” Thus, these signs are used as an “alarm clock” to apply a relaxation technique that will counteract the anxiety symptoms.

Most patients wonder how it is possible to relax in such a short time? What you do in AR is to start by learning PR which takes 15–20 minutes. In PR you briefly tense and then relax the big muscle groups of your body. After practicing that for two weeks you then work on relaxing by using the release-only procedure, omitting the muscle tensing portion of the technique. This reduces the time it takes for you to get relaxed to 5–7 minutes. The next step is called cue-controlled relaxation, a step in which you learn to associate the self-instruction “Relax” with the state of relaxation. Then follows differential relaxation with the purpose of teaching you to do various activities while being relaxed in the muscles that don't have to be actively engaged in those activities. In this phase you might practice relaxing while sitting, standing, and walking. The next step is called rapid relaxation, which usually takes 20–30 seconds, and during this step you practice to relax in natural, but not anxiety-arousing situations.

In the final phase, application training, you apply the skill of relaxing rapidly in those situations in which panic symptoms occur. Over the 8–10 weeks of training you record your panic attacks in the panic diary. This monitoring results in a lot of information about the first signs that tell you a panic attack is coming on. By applying rapid relaxation as soon as you experience the first sign you will learn that you can stop the anxiety symptoms from escalating to a high level. After a few weeks you will be able to abort the first signs or symptoms altogether. When the panic attacks have disappeared you will have the opportunity to follow a maintenance program to keep your relaxation skill fine tuned and ready to apply whenever you may need it in the future.

After the therapist has provided the treatment rationale patient questions are answered. The patient is then encouraged to take the written description home and read it carefully in order to discuss it with the therapist at the next session, during which time the treatment starts.

2. Homework Assignments

Since therapists usually only see patients once a week, the relaxation training requires that patients practice at home twice per day the skills presented in session. Practice is recorded on self-monitoring forms provided by the therapist. On these forms the patient records the degree of relaxation experienced immediately before and after the practice, the approximate duration of the practice, and any comments the patient may have. The scale for rating the degree of relaxation is a 0–100 scale, where 50 is the “normal state” (neither relaxed nor tense). A 0 means complete relaxation and 100 means maximal tension/anxiety. The same form is used for the first four steps of AR training, while alternative forms are used during rapid relaxation and application training.

It is also important to realize that it is rare to find patients that can complete every weekly practice assignment. Patients are instructed to make a note regarding the reason for missing a practice session. Furthermore, it is emphasized that it is better to practice only once a day in a calm and nonstressful situation than twice a day if both practice occasions are carried out during a fairly high level of time pressure. If patients do not have time to practice more than once a day, treatment will take longer.

3. Transitions

Patient records of the relaxation training progress at home serve as the therapist's guide in deciding when it is time to proceed to the next step in treatment. When patients experience an average increase in relaxation

from immediately before to after homework practice of 20–30 points, such as a prerating of 50 and a postrating of 20–30 on the 0–100 scale, it is time to continue. It is not necessary for patients to achieve very high levels of relaxation (ratings of 0–10) in order for the AR skill to be acquired.

B. Observation of Early Signs of Anxiety

In order for applied relaxation to work optimally patients must use the relaxation technique as early as possible in the response to an anxiety reaction or a panic attack. Reacting quickly to the first signs of anxiety greatly increases the patients' ability to employ AR effectively. In order to increase the patient's awareness of the initial signs of anxiety, homework assignments involve observing and recording these reactions. In the panic diary the patient records the situation, the symptoms of the panic attack, and the severity of the attack (0–100), as well as the very first signs that were experienced.

Therapist and patient examine the panic diary and focus on identifying the earliest signs of the onset of the panic attacks. An attempt is made to determine what the patient felt, thought about, or did just before the first symptom occurred. Sometimes it can be advantageous to let patients imagine their most recent panic attack. This procedure often assists patients in remembering things that they did not notice while recording the actual attack. Besides making the patient more aware of the early signs of anxiety, it is important to get an approximate estimate of the time between the first sign and the peak of the panic attack. As patients realize that this time period is perhaps as long as 30 seconds to several minutes, confidence that they will be able to apply AR to the early signs of anxiety and prevent it from developing into a panic attack begins to grow.

It is valuable to collect and summarize the reported early signs of anxiety. These recordings provide a database for use later in treatment. In particular, in the application phase of AR these data will allow the therapist to present to patients a systematic summary of early signs ranked by frequency and perhaps divided according to some systematic grouping. This list will prove useful as patients begin to apply AR in real life situations.

C. Progressive Relaxation

Before starting PR training, patients should be given a rationale for the PR. It should be noted that PR is easily learned and does not require any special abilities.

The method involves learning to relax by first tensing and then relaxing different muscle groups in the body. Briefly tensing muscles makes it easier to experience the contrast between a tensed and a relaxed muscle, and to notice tension in various muscles during daily activities. The different muscle groups that are included can be conceived of as a menu from which patients can choose. There is absolutely nothing sacred about the constellation of muscle groups. The important thing is that as patients achieve a high degree of relaxation, they need not always follow the PR instructions to the letter. For some patients the tensing/releasing of a certain muscle group can lead to an experience of increased tension in that muscle. If that is the case, that particular muscle group may be deleted from the relaxation training.

Progressive relaxation training begins with demonstrating to patients exactly how the different muscle groups are to be tensed and relaxed. The therapist sits opposite the patient and models the procedure across the different muscle groups, while the patients simultaneously perform these behaviors. Below is a list showing the muscle group and the order in which tensing/relaxing exercises are presented.

1. Tense your right hand (make a tight fist)
2. Tense your left hand (make a tight fist)
3. Tense both hands (make tight fists)
4. Tense your biceps
5. Tense your triceps (stretch your arms without lifting them)
6. Wrinkle your forehead by raising your eyebrows
7. Wrinkle your eyebrows (bring them tight together)
8. Close your eyes tight
9. Tense your jaw muscles by biting your teeth together
10. Push the tip of your tongue against the roof of your mouth
11. Press your lips together
12. Push your head back against the top of the chair
13. Bend your head forward, touching your chin to your chest
14. Raise your shoulders towards your ears
15. Raise your shoulders towards your ears, and move them in a circular motion
16. Breathe with calm regular breaths
17. Take a deep breath; fill your lungs and hold your breath
18. Tighten your stomach muscles
19. Pull your stomach inward
20. Bend your back in a curve

21. Tense your thighs by pressing your heels to the floor
22. Point your feet and toes down (forward)
23. Point your feet up towards your face

During relaxation training patients are prompted to sit as comfortably as possible, loosen tight fitting clothes, and close their eyes. Room lights can be dimmed and the therapist's tone of voice should be low and somewhat monotonous, without being sleep inducing. Furthermore, it is important to remember that it is the relaxation and not the tension that is the important part of PR. The tension is only included as a contrast to the relaxation. The relation between the duration of time the patient tenses and relaxes the different muscle groups must be 1:2 or 1:3; that is, if a muscle is tensed for 5 seconds, the following relaxation interval should be at least 10–15 seconds.

D. Release-only Relaxation

The introduction provided before the start of the release-only phase of PR is that this step is intended to reduce the time it takes for the patient to become relaxed from 15–20 minutes with the PR to about 5–7 minutes, and to help them learn to relax without having to tense muscle groups. Patients are told they will be instructed to focus on the different parts of the body and are asked to relax as much as possible. If, after having tried to relax they still feel tension in a muscle, they should tense the muscle briefly and then relax it (such going back to the procedure used during the PR). During this phase of training the therapist adjusts the instruction to a pace which allows patients time to perform the tension-release exercises when necessary.

Below is an example of the instructions used in this phase: "Breathe with calm, regular breaths and feel how you relax more and more with each breath ... Just let go Relax your forehead ... eyebrows ... eyelids ... jaws ... tongue and throat ... lips ... and your entire face Relax your neck ... shoulders ... arms ... hands ... and all the way out to your fingertips Breathe calmly and regularly ... and let the relaxation spread to your stomach ... waist and back Relax the lower part of your body, your buttocks ... thighs ... calves ... feet ... and all the way down to the tips of your toes Breathe calmly and regularly and feel how you relax more and more with each breath ... Continue to relax like that for a while [Pause for about 1 minute.] Now take a deep breath, hold it ... and let the air out slowly ... slowly ... Notice how you relax more and more."

E. Cue-Controlled Relaxation

The purpose of cue-controlled relaxation (CR) is for the patient to learn to associate the self-instruction "relax" with a relaxed state, and further reduce the time it takes to become relaxed. Cue-controlled relaxation may be introduced to patients as follows: "Most of us have probably been in situations where we or an acquaintance have been very nervous. In that situation we often get the advice to 'take it easy and relax.' This advice very seldom works since it is given when we are already mentally and physically at a high arousal level. In order to relax in these situations you must practice pairing the relax self-instruction with the relaxed state. Once you can successfully make yourself relaxed, you then need to start practicing this cued relaxation in increasingly more stressful settings."

The session starts by the patient relaxing on their own with the help of the release-only version of PR, which the patient has been practicing for 1–2 weeks. When having achieved a deep degree of relaxation the patient signals the therapist by lifting one index finger. Focus in CR is on the breathing and in following the therapist's instructions on the pace of their breathing pattern. Just before breathing in, the therapist says "inhale" and just before breathing out, the therapist says "relax." This is done 4–5 times. Then the patient is instructed to think "inhale" and "relax" silently in pace with the breathing rhythm. After the patient has been doing this on their own for about 2 minutes, the therapist comes back with the instruction "inhale ... relax" a further 4–5 times, after which the patient takes over and does this exercise covertly for a couple of minutes. This practice sequence only takes about 10 minutes and after a break of 10–15 minutes during which one can do other things (such as going over the panic diary), it is suitable to repeat the entire instruction during the session.

F. Differential Relaxation

1. Introduction to Differential Relaxation

In order for AR to be an effective coping skill it must be "portable," The patient should be able to use it in practically any situation and not be constricted to a comfortable armchair in the home or in the therapist's office. The primary purpose of differential relaxation (DR) is to teach the patient to relax in other situations besides in the comfortable armchair. The secondary purpose of DR is to learn not to be tense in the muscle groups not being used for the activity at hand.

2. Instruction of Differential Relaxation

The session starts with the patient sitting in the armchair relaxing on their own with the help of CR. When the patient has signaled that they are relaxed, they then follow the instruction to perform certain movements with different parts of the body while at the same time concentrating on being as relaxed as possible in the rest of the body. During the performance of these movements the patient should scan the body often (i.e., think through the different muscle groups) in order to discover possible tensions, and in that case they should relax away these tensions. After the patient has signaled that they are relaxed the following instruction is given.

“Continue to relax as much as possible in the entire body. While you do that ... open your eyes and look around in the room without moving your head. Look to your left ... and to your right ... up to the ceiling ... and down to the floor. Concentrate on relaxing as much as possible in the rest of the body ... Now do the same thing but also turn your head in order to take in a larger field of vision. Look to the left ... and to the right ... up to the ceiling and down to the floor. Good! Take the head back to a comfortable position and relax as much as possible. Let your arms rest against the elbow rests and now lift the right hand a bit from the support. Concentrate on the relaxation in the left hand and arm ... now stretch the arm straight out ... and straight up in the air ... focus on the relaxation in the left arm ... and now take the right arm back to a comfortable position on the armrest. Relax as much as possible in your right arm and do the same thing with the left arm. Lift the left hand a little bit from the armrest. Concentrate on the relaxation in the right hand and arm ... Now stretch the arm straight out ... and straight up in the air ... Focus on the relaxation in the right arm ... and take the left arm down to a comfortable position on the armrest. Relax as much as possible in the left arm and the entire body ... Now bend the right foot up towards the face while you concentrate on relaxing in the left foot ... and stretch the right leg straight out. Focus on the relaxation in the left leg ... and take the right leg down and relax. Relax as much as possible in the right leg and now do the same thing with the left leg. Bend the left foot up towards the face while you concentrate on relaxing in the right foot ... and stretch the left leg straight out. Focus on the relaxation in the right leg ... and take the left leg down and relax. Relax as much as possible in the left leg and the entire body; the head, the arms, the chest, and legs.”

After finishing the instruction you should ask the patient to note the degree of relaxation after using CR

when signaling to the therapist, before starting to do the movements, and after all the exercises have been completed. What you often find is that the patient has achieved a good degree of relaxation and performing the movements has not led to less relaxation; in many cases the relaxation has instead been deeper after the exercises. You should also ask the patient to estimate how long it took them to become relaxed, which almost always gives the instructor the chance to praise the patient for achieving the relaxation in a shorter time than was estimated.

3. Further Steps in Differential Relaxation

After practicing in an armchair, the same procedure is repeated while the patient is sitting in an ordinary chair. Then you can let the patient sit in an office chair by a desk and perform various activities that are natural to that situation, such as writing, typing, and making phone calls. These three components usually cover one session and during the next session you proceed by teaching the patient to relax while standing, and doing the same activities as while sitting, except for the use of their legs. Finally, the patient should practice being relaxed while walking. In this situation it is an advantage to have a fairly long corridor to practice in.

G. Rapid Relaxation

1. Introduction to Rapid Relaxation

The purposes of rapid relaxation (RR) are to teach the patient to relax in natural but not anxiety-arousing situations, and to further reduce the time it takes to become relaxed. The goal for this is 20–30 seconds. In order to reach these goals the patient should use rapid relaxation 15–20 times a day in natural situations. At this stage it is very important that the therapist spends some time to thoroughly go over the goals with the patient and to write down suitable situations that function as signals for RR training. The therapist asks the patient to describe what an ordinary day looks like to them and what they do between getting out of bed in the morning through going to bed at night. Among those activities that the patient does one can choose signal situations in such a way that it make up at least 15 practice occasions per day.

2. Instruction of Rapid Relaxation

When the patient is relaxing in natural situations during this phase of AR the relaxation has largely been reduced. The patient is instructed and the therapist models the following sequence:

1. Take a deep breath and slowly let the air out
2. Think "relax" quietly each time you breathe out
3. Scan your body for any signs of tension and relax as much as possible in the situation
4. Stay in the relaxed state for 30–60 seconds.

If, after doing all the above, the patient still feels that they haven't achieved a deep enough degree of relaxation, one can take one more deep breath as described above. In some cases the entire sequence can be repeated for a third time. After this the patient should be content with the degree of relaxation achieved. Otherwise there is a risk that the patient will trigger symptoms of hyperventilation, which of course counteracts the purpose of RR.

H. Application Training

1. Introduction to Application Training

The only rationale you give the patient at this stage is that it is now time to start practicing in reality what they have learned in theory. Before starting this phase it is very important to give the patient an instruction that sets their expectations at the right level. You remind the patient that applied relaxation is a skill and as with any other skill it takes practice to refine it. This means that the patient should not expect that AR functions at 100% the first time it is applied, such as with a panic attack. Instead, one must be satisfied with the anxiety not increasing as much as it had before, but that it levels out at a mild to moderate level. It is very important that the patient does not get demoralized but that they continue to apply AR every time they are in an anxiety situation. Relatively soon one will notice an effect from AR, and eventually the anxiety reactions will dissipate altogether.

Before the patient goes out into real life situations and starts applying the relaxation in these situations, one must go over the list of early signs that the therapist has put together during the course of the treatment. First, the patient should try to describe by heart the early signs that have been recorded during their panic attack. Second, the patient should be given the list that the therapist has collected as a memory aid for them to start applying the relaxation technique in real-life situations. In this way, the patient's awareness of these early signs is increased directly during the phase where the application is going to take place.

2. Practical Application Training

A majority of panic patients do not think that they have a need for any special form of application training.

For these patients it is enough to give them a rationale before starting the application training. This is to get their expectations at the right level, after which they are confident enough to start applying the relaxation skill in real life panic situations.

In some panic patients it has turned out to be useful to provoke a "mini-attack" during therapy for which one can practice applying AR. In this situation different methods to provoke a panic reaction can be used and the choice of the method used is dependent on which of the techniques most readily provoke panic symptoms in the patient. Voluntary hyperventilation during 1–2 minutes with 30 breaths per minute will in 50–60% of the patients produce symptoms that remind them of, or are the same as, a naturally occurring panic attack. If this technique is used, it is appropriate to let the patient breathe normally using stomach breathing instead of taking a deep breath at the beginning of rapid relaxation, since the latter might be a continuation of the hyperventilation. Another technique that can be useful in some patients is using physical exercise such as letting the patient run up and down the stairs for a couple of minutes in order to get them to palpitate, which in turn one fears is the beginning of a panic attack. In patients where dizziness is an important panic symptom one can spin the patient around on an office chair for 20–30 seconds.

One further possibility is to let the patient imagine a difficult panic attack that has occurred to them before or during treatment. In this situation it is suitable to have the therapist describe the situation and the panic symptoms to the patient and letting the patient signal by raising a finger when they experience the first sign of anxiety in the current situation. When the patient has signaled, one should let them keep the image of that situation for a while (4–5 seconds) and then you should instruct the patient to stop thinking about the described situation and use AR to counteract the reactions.

II. THEORETICAL BASIS FOR APPLIED RELAXATION

So far there are no developed theoretical models to explain the mechanism of AR. However, it is possible to use a modification of the type of vicious circle explanation that has been developed for cognitive therapy in panic disorder. This model assumes that independently of what kind of an eliciting stimulus or what type of initial reaction follows there is an interaction between physiological and cognitive reactions, culminating in a

panic attack. The purpose of AR is to break the vicious circle as quickly as possible in order to stop the first signs of anxiety from escalating into a panic attack. As the patient starts using the application skill they are fully occupied by concentrating on that skill and thus the probability is lower that the chain of negative thoughts will start to develop.

Since there are no studies regarding the mechanism of change for AR at this time one can only speculate concerning this issue. Personally, I believe that AR works through the patient having acquired the skill to rapidly achieve a state of relaxation, which counteracts the anxiety reactions both on a physiological and a cognitive level. Perhaps Bandura's self-efficacy theory can be used in this regard. There are at least three contributing factors which cannot be disregarded:

1. *The reduction of the general tension level in the body.* As this happens the probability is reduced that small stressors will, when they are added to the ambient tension level, lead to the patient ascending over the panic threshold.

2. *Increased awareness and knowledge about anxiety reactions.* As the patient learns to identify early signs of anxiety they will learn more about what anxiety is and experience it in a more differential way instead of a "big black lump" or "lightning out of the blue."

3. *Increased self-confidence.* By using the relaxation skill in natural situations and noticing that it works, one can reduce or abort the anxiety altogether. The patient develops an increased confidence in their own ability to do something proactive. The patient is no longer a helpless victim of panic.

III. APPLICATIONS AND EXCLUSIONS

Applied relaxation is a coping technique that was primarily developed for the treatment of nonsituational anxiety or panic attacks. However, research and clinical applications show that it is a method that is useful for many different disorders.

In randomized clinical trials, AR has been evaluated for specific phobias such as social phobia, agoraphobia, panic disorder, generalized anxiety disorder, tension headache, mixed headache, migraine, pain (low back and upper extremities), epilepsy, tinnitus, Ménière's disease, hearing impairment, nonulcer dyspepsia, and also to improve the immune defense system in cancer patients. Furthermore, nonrandomized pilot studies

have evaluated AR for stress reactions, insomnia, menopausal symptoms, genital herpes and as a stress-management technique for collegiate field hockey players, soccer players, and novice rock climbers.

In some of the disorders, not including anxiety, a combination of AR and other behavioral methods have been used. In general, AR seems to be a suitable treatment method for problems where the main component is anxiety or stress reactions, or at least is an important part of the problem. Different physiological reactions should also be part of the problem picture of the patient.

So far there are no direct contraindications in the research or clinical application of AR. The fact that AR has been used for schizophrenic patients, without the predicted "psychotic breakthrough" that psychodynamic therapists talk about, speaks for its utility in a wide range of psychiatric, psychosomatic, and somatic problems.

IV. EMPIRICAL STUDIES

There are 33 studies published between 1981 and 2000, 15 of those studies included various anxiety disorder patients, while the remaining 18 focused on different somatic disorders (headache, pain, epilepsy, tinnitus, Ménière's disease, hearing impairment, dyspepsia, and cancer).

In 19 of the studies, AR was compared to a control condition (waitlist or attention-placebo). In all instances, AR yielded significantly better results.

These studies contain 28 comparisons between AR and another active treatment. AR was found significantly more effective than progressive relaxation in panic disorder, than cognitive treatment in agoraphobia, and nondirective therapy in generalized anxiety disorder. AR was less effective than cognitive therapy in two studies of panic disorder.

AR was found as effective as exposure in claustrophobia, blood phobia, and agoraphobia; as with cognitive therapy in panic disorder, GAD, and tinnitus; as with self-instructional training in social phobia and dental phobia; as with social skills training in social phobia; as with applied tension and the combination of AR and applied tension in blood phobia; as with imipramine in panic disorder; as with anxiety management training for anxiety in schizophrenic patients; as with the combination of AR and cognitive therapy in GAD; as with progressive relaxation in mixed headache; as with biofeedback and the combination of

AR and biofeedback in pain; as with the combination of AR and an operant program in pain; and as with transcutaneous nerve stimulation in Ménière's disease. Finally, the combination of AR and an operant program was as effective as CT and the operant program, and the operant program alone, in pain patients. This combination was also more effective than regular treatment in another study of pain patients.

The conclusion that can be drawn from this is that (with two exceptions) AR is more effective than, or as effective as, other well established treatment methods for various anxiety disorders and psychosomatic/somatic disorders.

Twenty-four of the 33 studies report follow-up results on average 11 (range 4–24) months after the completion of treatment. A comparison of the percent improvement on the most important measure in each study showed that the mean pre-post change was 53% and the mean pre-follow-up change was 60%. Thus, not only were the treatment effects for AR maintained almost a year after treatment, but there was a small further improvement during the follow-up period.

V. SUMMARY

Applied relaxation is a coping technique consisting of a series of steps which teaches the patient to reduce the time it takes to become relaxed from 15–20 minutes to 20–30 seconds and to apply this skill in naturally occurring anxiety situations. The treatment usually takes 8–10 weeks to complete and clinical experience and research show that 90% of the patients acquire the skill of being able to relax rapidly. While first developed for nonsituational anxiety disorders, AR has successfully been applied to other anxiety disorders as well as various psychosomatic and somatic disorders, such as headache, pain, epilepsy, tinnitus, dyspepsia,

and cancer. A summary of the randomized clinical trials shows that AR is significantly more effective than control conditions and as effective as various well-established treatment methods with which it has been compared. Follow-ups, on average 11 months after the end of treatment, show that not only have the treatment effects been maintained, but also on average there is a further improvement.

See Also the Following Articles

Anxiety Management Training ■ Applied Tension ■ Behavioral Treatment of Insomnia ■ Homework ■ Progressive Relaxation ■ Relaxation Training ■ Restricted Environmental Stimulation Therapy ■ Stretch-Based Relaxation Training

Further Reading

- Borkovec, T., & Whisman, M. (1996). Psychosocial treatment for generalized anxiety disorder. In M. Mavissakalian, & R. Prien (Eds.), *Long-term treatments of anxiety disorders* (pp. 171–199). Washington, DC: American Psychiatric Press.
- Chambless, D. L. & Gillis, M. M. (1994). A review of psychosocial treatments for panic disorder. In B. E. Wolfe, & J. D. Maser (Eds.), *Treatment of panic disorder: A consensus development conference* (pp. 149–173). Washington, DC: American Psychiatric Press.
- Clark, D. M. (1989). Anxiety states: Panic and generalized anxiety. In K. Hawton (Eds.), *Cognitive behaviour therapy for psychiatric problems: A practical guide*. (pp. 52–96). Oxford, UK: Oxford University Press.
- Fisher, P., & Durham, R. (1999). Recovery rates in generalized anxiety disorder following psychological therapy: An analysis of clinically significant change in the STAI-T across outcome studies since 1990. *Psychological Medicine*, 29, 1425–1434.
- Linton, S. (1994). Chronic back pain: Activities training and physical therapy. *Behavioral Medicine*, 20, 105–111.

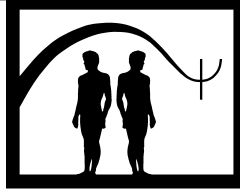

Applied Tension

Lars-Göran Öst

Stockholm University

- I. Description of Applied Tension
 - II. Theoretical Basis for Applied Tension
 - III. Applications and Exclusions
 - IV. Empirical Studies
 - V. Case Illustration
 - VI. Summary
- Further Reading

GLOSSARY

application training The application of the tension technique when experiencing the early signs of a blood pressure drop while being exposed to blood stimuli.

blood-injury-injection phobia The fear and avoidance of seeing blood, injuries or receiving an injection or other invasive medical procedures.

diphasic pattern The initial increase followed by a sharp decrease of blood pressure when exposed to blood stimuli.

early signs The very first (idiosyncratic) signs that the blood pressure is dropping.

tension technique The tensioning of the arms, the chest, and the leg muscles.

I. DESCRIPTION OF APPLIED TENSION

A. General Features of Applied Tension

Applied tension (AT) is behavioral coping technique, first described by Kozak and Montgomery in 1981 in a

case study and later developed within Öst's research project on the treatment of blood-injury-injection phobia. It consists of two components: the learning of an effective tension technique, and the application of this technique while being exposed to blood-injury stimuli. In its original form AT is a five-session treatment with homework assignments to carry out between sessions, but later research has shown that a one-session (2 hours) version is as effective. Both versions will be described.

B. The Physiological Response Pattern

When a patient with a specific phobia encounters the phobic stimuli the typical response pattern is an immediate activation of the sympathetic branch of the autonomic nervous system (i.e., increase of heart rate, blood pressure, skin conductance, etc.). If the patient remains in the situation there is a gradual reduction back to baseline levels. In contrast to this, patients with blood-injury phobia, and to a lesser extent those with injection phobia, usually show a diphasic pattern. After an initial increase in blood pressure and heart rate there is a sharp decrease in these variables, which eventually leads to fainting when the cerebral blood pressure has fallen below a critical level. This is illustrated by Figure 1 describing the blood pressure of a blood phobic patient treated in our clinic. The 10-minute baseline shows a rather stable systolic blood pressure (SBP) around 120 mmHg and diastolic blood pressure (DBP)

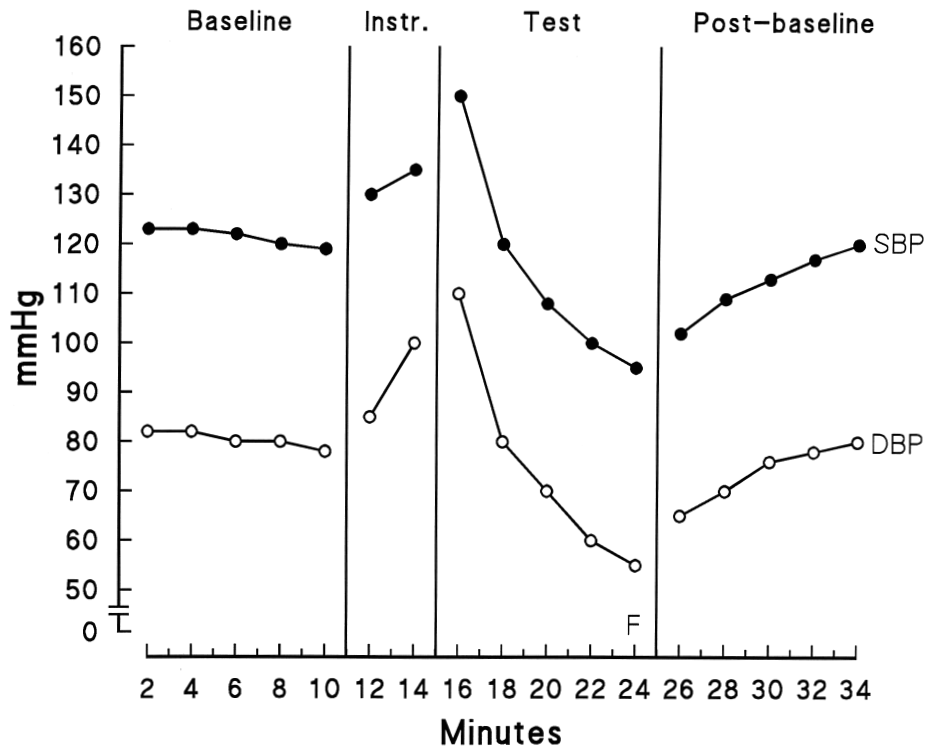

FIGURE 1 Systolic (SBP) and diastolic (DBP) blood pressure during the different phases of the blood phobia test situation. Baseline = 10 minutes rest, Instr. = instruction about the upcoming test and waiting for it, Test = watching a 30-minute videotape of thoracic surgery, Post-baseline = 10 min of recording after the patient had regained consciousness, F = fainting.

around 80 mmHg. During the 4-minute instruction phase there is an increase in both SBP (to 135) and DBP (to 100), which is continued during the first assessment of the test period (150 and 110, respectively) when the patient is watching a videotape of thoracic operations. This is the first phase of the diphasic reaction. Then there is a drop in both SBP (to 95) and DBP (to 55) 10 minutes into the tape when the patient fainted. This is the second phase. During the post-baseline there is a gradual recovery back to baseline levels.

There are different hypotheses in the literature attempting to explain this diphasic response pattern but so far none has very much research evidence.

C. Rationale for AT

After having described the diphasic pattern the therapist gives the following explanation of how AT is going to work.

Since the second phase of the response consists of the drop in blood pressure your blood flow in the brain is

also reduced and before fainting you will feel dizziness and other fainting sensations. In order to reverse this progression you need to acquire a coping skill that can be applied rapidly in any situation which triggers these sensations. Applied tension is this skill which produces an increase in blood pressure and cerebral blood flow. The method has three parts: (1) learning the actual tension technique, (2) learning to identify the very first signs of the drop in blood pressure, and (3) applying the tension technique when being exposed to various blood-injury stimuli that trigger the fainting sensations. The tension technique consists of tensioning the large body muscles; the arms, the chest, and the legs for short periods of time. By being exposed to different stimuli under my supervision you will gradually be more and more efficient at identifying the early signs and apply the tension technique so that the reduction in blood pressure will not be so dramatic, and you will get the curve to turn upward. The tension technique is easy to learn but like any other skill it takes practice to master it. You cannot expect to be perfect at it at once but with experience you will be better and better. The goal is that you should be able to encounter these situations without having stronger reactions than people in general.

After giving a rationale like this the therapist should encourage the patient to ask questions if there is something that is not clear to him or her. One frequently asked question is what happens if the first signs come on very rapidly and I am not good or quick enough to prevent the fainting; will everything be in vain? The answer is that it is no disaster if you faint during a therapy session. On the contrary, this will give you the opportunity to practice applying the tension technique as soon as you regain consciousness. Then you will learn that you recover much more rapidly than you have done so far, in 15 to 20 minutes instead of 3 to 4 hours.

D. Outline of the Treatment Program

1. The First Session

The initial part of session 1 consists of a behavior analysis concerning the patient's experiences when encountering blood-injury stimuli. This should focus on what the patient usually does in the situation, if he or she has fainted, how often this has occurred, how long the patient has been unconscious, and particularly what were the symptoms that the patient experienced before fainting. These early signs can be idiosyncratic, for example, dizziness, cold sweat, tunnel vision, ringing in the ears, a queasy sensation in the stomach, and nausea. It is important to list these symptoms carefully and in their order of occurrence since they are used as cues for applying the tension in later sessions. After having completed the behavior analysis the therapist describes the rationale as outlined earlier.

The last part of the first session consists of teaching the patient the correct tension technique. However, before starting with this it is imperative to assess the patient's blood pressure to get a baseline measure before tensing and to rule out high blood pressure. Then the therapist models the tension technique by sitting in front of the patient and showing him or her to tense the gross body muscles—arms, chest, and legs—and to keep tensing for 10 to 15 seconds, or long enough to feel a sensation of warmth rising in the face. Then the tension is released and the patient goes back to normal without attempting to relax. After a pause of 20 to 25 seconds there is a new tension of 10 to 15 seconds followed by a release and pause. After five cycles of tensing–releasing the therapist once more assesses the patient's blood pressure, and usually this will indicate an increase from baseline with 4 to 5 mmHg of DBP and 8 to 10 mmHg of SBP.

As homework assignment the patient should do five practice sessions per day, which only takes about 4 minutes when it includes five cycles as described above. One

problem that a few of our patients have reported while carrying out the homework is headache. This is probably due to a tension that is too intensive and/or too frequent, and is solved by instructing the patient to reduce both intensity and frequency of the tension practice.

2. The Second and Third Sessions

During the second and third session the patient is shown a series of slides (about 30) of wounded or mutilated people. When the first slide is shown on the screen in front of the patient he or she is instructed to introspect and scan for the very first sign that the blood pressure is dropping, while watching the picture. As soon as the first symptom is detected the patient describes what it is, and if the reaction is not too strong the therapist assesses the patient's blood pressure to obtain a pretensing level. Then the patient applies the tension and keeps applying it (with brief periods of release) until he or she can watch the slide without experiencing the symptom. Then the therapist once more assesses the blood pressure to obtain a post-tensing level, and at the end of the session pre- and post-tensing levels can be compared. When the patient can watch the slide for about a minute it is time to continue with the next slide and repeat the process. The aim is to complete the first 15 slides during session 2 and continue with the next 15 slides during session 3.

During these two sessions the job of the therapist is very similar to a sports coach: setting the stage for the initial BP drop, encouraging the patient to observe the first signs, and coaching him or her to apply the tension technique quickly enough and persistently, in order to reverse the physiological response.

Between sessions the patient has the same homework assignment as after the first session, that is, five practice occasions of tension–release tension per day.

3. The Fourth Session

For the fourth session the patient is taken to the hospital's blood donor center in order to provide him or her with a natural situation in which the application of tension technique can be practiced. To begin the patient is guided around the center by a nurse who also describes how the blood is managed. Then the patient watches other blood donors donating blood, and finally has a blood sample of his or her own withdrawn. The purpose of this is to assess if the patient is suitable to become a blood donor, since donating blood regularly is one way in which the patient can maintain the skill he or she has acquired during the treatment period.

One problem that might arise is if the patient has to use the tension technique during the venipuncture,

which may make it difficult, or impossible, for the nurse to draw blood. The therapist should anticipate this problem and teach the patient differential tension, that is, to be relaxed in the nondominant arm while at the same time tensing the dominant arm, the chest, and the legs.

4. The Fifth Session

For the final session the patient is brought to the department of thoracic surgery at the university hospital where he or she can observe an open-heart or lung surgery from an observation room one story above the operating theater. During this session the patient has many opportunities to practice application of the tension technique, and the therapist's primary responsibility is to coach the patient to do so. Should the patient faint, which rarely happens, the therapist will help the patient to regain consciousness and then use the tension technique for a while in order to be able to resume exposure to the operating scene as soon as possible. First the patient should be lying on the floor, then sitting on the chair but turned away from the operating table, and then gradually turning toward it while tensing continuously if necessary.

5. The Maintenance Program

At the end of session 5 the therapist describes the maintenance program to the patient. This starts with a review of the progress that the patient has made so far, and then follows a description of what the patient could do in the next 6 months in order to maintain, and further, this improvement. An agreement is made between therapist and patient that the latter should continue exposing himself or herself to blood-injury stimuli at least twice a week. Examples of situations are looking at pictures of wounded people, watching TV programs of surgical procedures, talking to others about such things, watching others donate blood, and donating blood oneself. The patient has specific forms to fill out and mail to the therapist once every four weeks. Upon receiving a form the therapist calls the patient on the phone and talks with him or her for 10 to 15 minutes about the experiences of the past period. The patient also is taught the difference between a setback and a relapse, and is given a set of instructions on what to do in case a setback occurs.

E. A Brief Version of AT

In an attempt to investigate whether the five-session version of AT described above could be abbreviated into a one-session treatment a study was undertaken in my clinic. The one-session AT was maximized to 2 hours, since pilot cases indicated that the large amount

of muscle tension during an ordinary 3 hour session would lead to quite a lot of muscle soreness. This would, in turn, make it difficult for the patient to focus the concentration on what is necessary (i.e., observing the very first signs of drop in blood pressure).

The one-session AT starts with the same rationale as above. Then follows 15 minutes of tension training with the blood pressure assessment before and after to demonstrate to the patient that he or she can increase the blood pressure in a nonexposure situation. The application training uses 10 of the 30 slides used for the five-session AT, but the procedure is the same as described earlier. If time permits further exposure to blood-injury stimuli can consist of talking about blood situations, looking at blood in a test tube or at a bloody bandage, having a finger pricked, and so on. The purpose of the application training is the same as for the longer version, that is, for the patient to acquire the skill to recognize the drop in blood pressure and to apply the tension technique to reverse this curve, and abort the reaction altogether. After the session the patient is given the same homework assignment as in the five-session AT: to practice the tension technique five times a day.

The outcome of the study indicated that the one-session AT was as effective as the five-session treatment on almost all of the measures. Thus, from a clinical point of view the brief treatment may be preferable since it does not involve taking the patient to a blood donor center or a thoracic surgery department.

II. THEORETICAL BASIS FOR APPLIED TENSION

According to the rationale for AT this coping technique works because by tensing the large body muscles the patient can stop the blood pressure from falling too low, and then increase it to a normal level for the individual patient. As a consequence of this the cerebral blood flow will not decrease below a critical level and the patient will not faint.

What evidence is there for this explanation? In the three randomized clinical trials of AT done at my clinic the patients ($N = 40$) increased their blood pressure significantly from the pre- to the post-tensing phase while being continuously exposed to slides of wounded people. The mean SBP increases were 13.6, 17.0, and 16.2 mmHg, and the corresponding means for DBP were 5.8, 7.8, and 12.4, respectively. This indicates that blood phobic patients can acquire the tension skill after 1 week of practice and use it effectively during the treatment sessions at the clinic. Unfortunately, we have not been able

to assess BP during sessions 4 (blood donor center) and 5 (thoracic surgery). Furthermore, our physiological equipment has not allowed us to assess cerebral blood flow, but other researchers have shown that the tension technique also leads to an increase in this parameter.

Another question concerning the mechanism of change for AT is whether the whole package consisting of the tension technique and exposure to blood-injury stimuli is necessary to obtain a good result. If this is not the case, which of the two components is the most important for the treatment effect? In one of our studies AT was compared with tension-only and exposure-only, and the results showed AT and tension-only to be equally effective and more so than exposure-only. In a subsequent study AT for one session and tension-only for one session were as effective as AT for five sessions. Thus the conclusion that can be drawn is that it is the coping technique (i.e., learning to tense and when to use it) that is the important component in AT.

III. APPLICATIONS AND EXCLUSIONS

AT was specifically developed for patients with blood-injury phobia and it has turned out to be the treatment of choice for this subgroup of specific phobia. In DSM-IV injection phobia is included in the same diagnostic category and about 50% of patients with injection phobia have a history of fainting in their phobic situations. For these I recommend teaching them the tension technique, but this is not enough; they also must be exposed to various injections, venipunctures, and pricking of fingers so that they acquire the skill of differential tension of the muscles (if necessary) while the nurse carries out these procedures.

Since very few patients with other anxiety diagnoses have a history of fainting when encountering their phobic stimuli there is very little need for AT in other instances. Patients with panic disorder often experience dizziness in their panic attacks, but they do not have a drop in blood pressure. Whether AT could have a beneficial effect on this subjective feeling of dizziness requires systematic research. However, there might be a risk of increasing the BP too much in patients who have a normal or elevated BP to start with.

If a patient has a diagnosed hypertension, temporal arthritis, or previous stroke one should be cautious with the tension training and assess the BP frequently to make sure that the BP does not rise to a level that is too high. However, it may be the case that blood phobic

patients with essential hypertension do not react as readily with the drop in blood pressure that is characteristic of blood-phobic patients.

IV. EMPIRICAL STUDIES

So far we have completed three clinical trials of AT in patients with blood-injury phobia. These are summarized in Table 1. The conclusion that can be drawn from these studies is that AT is an effective treatment, which yields better effects than exposure. However, it also seems that the application phase is of less importance than acquiring the coping skill; learning the tension technique well and having the knowledge of when and how to use it seem to be the most important factors in AT. Our latest study also indicates that an abbreviated one-session (2 hours) treatment is as effective as the full 5-hour AT, which is good news to the practicing therapist who may not have easy access to a blood donor center and a thoracic surgery department.

V. CASE ILLUSTRATION

A 24-year-old female patient had suffered from her blood phobia for 10 years, but never actually fainted in the phobic situation since she had always managed to escape or avoid these situations altogether. She had a father and a sister who also had blood phobia. When testing her before treatment her mean baseline values were SBP 122 and DBP 79 mmHg. During the instruction phase these values increased to 133 (SBP) and 87 (DBP) and at the beginning of the test phase there was a large increase to 161 (SBP) and 100 (DBP). This was, however, followed by a dramatic decrease to 94 (SBP) and 54 (DBP), and the patient fainted after watching the videotape of thoracic operations for 4 minutes. After being unconscious for a brief period (10 to 15 seconds) the patient's blood pressure gradually approached baseline without quite reaching the initial level. After receiving the AT the patient managed to watch the entire videotape (30 minutes) without any drop in blood pressure and no fainting behavior whatsoever. She did not have to use the tension technique at the posttreatment assessment and when asked about this she explained that she now felt very confident that she could cope with a drop in blood pressure, should it occur. At the 1-year follow-up the improvements were maintained and during that year the patient had encountered a number of blood-phobic situations and coped very well with them. At one occasion she even

TABLE 1
Clinical Trials of AT in Patients with Blood-Injury Phobia

Study	Treatments	Treatment time (hr)	N	Drop-out (%)	Measures	Results	Percent improvement	Follow-up (months)
Öst et al. (1989)	1. Applied tension	5	10	0	Behavioral test	1=2=3	1:100, 2:73, 3:90	6
	2. Applied relaxation	9	10	0	A. Rating of fainting	1=2=3	1:100, 2:94, 3:89	
	3. Combination 1+2	10	10	0	Self-rating of anxiety	1=2=3	1:56, 2:44, 3:89	
Öst et al. (1991)	1. Applied tension	5	10	0	Behavioral test	1=3>2	1:100, 2:64, 3:100	12
	2. Exposure <i>in vivo</i>	5	9	0	A. Rating of fainting	1=3>2	1:97, 2:41, 3:95	
	3. Tension-only	5	9	0	Self-rating of anxiety	1=2=3	1:54, 2:48, 3:37	
Hellström et al. (1996)	1. Applied tension: spaced	5	10	0	Behavioral test	1=2=3	1:88, 2:100, 3:100	12
	2. Applied tension: massed	1	10	0	A. Rating of fainting	1=2=3	1:71, 2:78, 3:71	
	3. Tension-only: massed	1	10	0	Self-rating of anxiety	1=2=3	1:58, 2:67, 3:57	

assisted at the scene of a traffic accident without experiencing any fainting sensations.

treatment for blood phobia and the effects are maintained at follow-up 1 year later.

VI. SUMMARY

Applied tension is a coping method specifically developed for the treatment of blood-injury phobia (and to some extent injection phobia). This method specifically focuses on the original physiological responses, which are characteristic of blood phobia: the diphasic pattern with an initial increase and then a rapid decrease in blood pressure. The first step of AT consists of teaching the patient an effective tension technique, which leads to an increase in blood pressure. The patient is taught to tense the arms, the chest, and the leg muscles, and by assessing the patient's blood pressure the therapist can demonstrate that the tension really increases blood pressure. The second step is to expose the patient to various blood-injury stimuli (slides of wounded people, blood donation, and thoracic surgery) so that he or she can practice applying the tension as soon as the very first signs of a drop in blood pressure, are experienced. Randomized controlled trials show that AT is an effective

See Also the Following Articles

Anxiety Management Training ■ Applied Relaxation

Further Reading

- Hellström, K., Fellenius, J., & Öst, L-G. (1996). One vs. five sessions of applied tension in the treatment of blood phobia. *Behaviour Research and Therapy*, 34, 101–112.
- Öst, L-G. (1992). Blood and injection phobia: Background, cognitive, physiological, and behavioral variables. *Journal of Abnormal Psychology*, 101, 68–74.
- Öst, L-G., Fellenius, J., & Sterner, U. (1991). Applied tension, exposure in-vivo, and tension-only in the treatment of blood phobia. *Behaviour Research and Therapy*, 29, 561–574.
- Öst, L-G., & Sterner, U. (1987). Applied tension. A specific behavioral method for treatment of blood phobia. *Behaviour Research and Therapy*, 25, 25–29.
- Öst, L-G., Sterner, U., & Fellenius, J. (1989). Applied tension, applied relaxation, and the combination in treatment of blood phobia. *Behaviour Research and Therapy*, 27, 109–121.
- Page, A. C. (1994). Blood-injury phobia. *Clinical Psychology Review*, 14, 443–461.

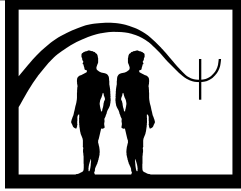

Arousal Training

Marita P. McCabe

Deakin University, Burwood, Australia

- I. Description of Treatment
 - II. Theoretical Bases
 - III. Empirical Studies
 - IV. Summary
- Further Reading

GLOSSARY

classical conditioning The main feature of this form of conditioning is that the originally neutral conditioned stimulus, through repeated pairing with the unconditioned stimulus, acquires the responses originally given to the unconditioned stimulus.

operant conditioning This type of conditioning involves the strengthening of an operant response by presenting a reinforcing stimulus if the response occurs.

I. DESCRIPTION OF TREATMENT

Arousal training is a technique that is used in the treatment of a number of clinical conditions. The essential aspect of the treatment involves training individuals to detect their levels of arousal, which are then the focus of treatment. Patients are trained either to further enhance arousal levels or to reduce levels of arousal, depending on what is required for a successful outcome.

This article focuses on two quite different conditions that utilize arousal training: enuresis and inorgasmia in

females. These two conditions have been selected because (1) there is a reasonable body of literature that relates to the use of arousal training with these conditions; and (2) the treatment of enuresis involves training the individual to lower arousal levels, whereas the treatment of inorgasmia involves training to increase arousal levels.

Arousal training among children with enuresis generally involves teaching the child to use a waking device to prevent them from wetting the bed. Parental involvement is an important aspect of therapy. The focus of the therapy is on teaching the child the physiological sensations that precede nocturnal enuresis (i.e., their arousal levels), so that he or she wakes and goes to the bathroom to urinate rather than wetting the bed. Thus, the focus of the training is on increasing the percentage of dry nights rather than on eliminating bed-wetting.

This technique uses a signal alarm device. When the child wets the bed, a moisture-sensing device near the genitals is activated and triggers an alarm. This alarm can either be a sound or a vibrating device. Both mechanisms have been found to be effective in waking children. Only a couple of drops of urine are necessary to trigger the alarm. Through this process the child gradually learns the physiological sensations associated with a full bladder and wakes to urinate in the bathroom without the sound of the alarm.

Reward systems are very important for this training to work (e.g., rewards for dry nights). Both the parents and child must be highly motivated. Involvement in training

entails recording the child's responses to the alarm and monitoring his or her progress. The success rate for therapy is in the 92% range, but the course of therapy can be two or three months. Reward systems need to remain in place for at least three weeks after complete dryness has been achieved. Relapse rates are higher if the alarm system is removed after shorter dry periods.

Arousal training for inorgasmia among women involves utilizing mechanisms that enhance sexual arousal. Women with inorgasmia generally demonstrate low levels of arousal, so therapy needs to focus on mechanisms designed to increase arousal levels. The focus of this arousal training needs to be directed toward both subjective and physiological levels of arousal. In an excellent 1995 review of the literature, Laan and Everaerd demonstrated how research studies have indicated the independence of these two dimensions of arousal, particularly among women. Thus, arousal training needs to focus on mechanisms that will enhance both aspects of arousal.

The most commonly used measure of physiological sexual arousal among women is vaginal vasocongestion. This is generally achieved by using a vaginal photoplethysmograph which measures both vaginal blood volume and vaginal pulse amplitude, with vaginal pulse amplitude generally being seen as the most accurate measure of sexual arousal. Strategies to increase physiological levels of sexual arousal include measures to reduce anxiety and sexual threats and also increasing the salience of the sexual stimulus. Although there is some speculation about the factors that need to be addressed to increase sexual arousal, the exact mechanism whereby this is achieved has not been developed or evaluated. Subjective sexual arousal generally involves an assessment of the woman's subjective evaluation of her arousal levels on a rating scale.

Sexual arousal in women has been shown to be enhanced using arousal training. Marita McCabe and her colleague have suggested that training focus on both response imagery (that is, sexual fantasy which relates to the woman's own sexual responses) and stimulus imagery (that is, sexual fantasy which relates to sexually stimulating situations), as well as relaxation. Thus, arousal training needs to focus on both a woman's responses to sexual fantasy and her generation of sexually stimulating scripts in order to effectively increase her levels of subjective sexual arousal. They also suggested that arousal training should focus on strategies to decrease performance concerns, since levels of performance anxiety were inversely related to subjective sexual arousal.

Clearly, more research needs to be conducted on the most useful treatment strategy to increase female sexual arousal. It would appear that arousal training is effective in the treatment of subjective sexual arousal, but the specific elements to include in this training process still need to be clarified. Enhancement of physiological sexual arousal among women has been largely neglected. Research needs to focus on the elements that are most useful in arousal training programs to improve the physiological levels of arousal, and also on the relationship between physiological and subjective arousal in the treatment of inorgasmia.

II. THEORETICAL BASES

Enuresis may have either an organic or a psychological etiology. This discussion focuses on the psychological explanation for development of the disorder and on the reason for the effectiveness of arousal training in its treatment. It has been proposed that the waking alarm described earlier works through classical conditioning. Repeated pairings occur between the sensation of a full bladder, the child wetting the bed, the sound of the alarm, and the child waking up. In time, the child learns to wake to the sensation of a full bladder prior to wetting the bed. Thus, the training is focused on the eventual association between a full bladder and waking up. Arousal training for enuresis also utilizes operant conditioning. Children may perceive the sound of the alarm, waking in the night, and cleaning up as an aversive condition, and so may learn to avoid this situation by learning to keep dry.

Both of these behavioral approaches use the theoretical underpinning of conditioning to increase the child's self-control of nocturnal bed-wetting behaviors. The basic assumption behind this approach is that lack of bladder control is a learned response. Arousal training, using either classical or operant conditioning, is designed to reverse change these behaviors.

Inorgasmia is viewed as being due to low physiological levels of arousal or perceived low levels of arousal for the subjective dimension, and arousal training is needed to alter this situation. Imagery training, which focuses on both stimulus and response imagery, is used to increase arousal levels. Consistent with proposals regarding imagery training among inorgasmic women, it would appear that reinforcement of appropriately recalled stimulus or response imagery during imagery training is an essential ingredient in the treatment of inorgasmia. Thus, operant conditioning would seem to

be an appropriate theoretical position to explain the effectiveness of arousal training with this disorder. Such an explanation is consistent with other approaches used to explain the treatment of inorgasmia.

Sexual arousal has been conceptualized as an emotion, which results from the interaction between cognitive processes and physiological response systems. Therefore, in order to experience subjective sexual arousal, individuals need to be able to accurately detect these bodily sensations. There appear to be substantial individual differences in the awareness of basic bodily sensations, which are related to genital responsiveness, perception thresholds, and attentional focus. A stimulus may convey different meanings, depending on the learning experiences of the individual (i.e., the individual's history), and so the interpretation placed on the current circumstances.

It has been argued that people learn to be sexual. For women, this learning process involves tuning into a wide range of situational and physiological cues. Appraisal of the current situation (based on prior learning experiences), in combination with feedback from genital sensations, combines to lead to subjective sexual arousal in women. Thus, arousal training to treat inorgasmia needs to reverse this learning process by dealing with feedback from both the interpretation of the situation and genital responses.

III. EMPIRICAL STUDIES

Arousal training has been shown to be extremely effective in the treatment of enuresis, provided it is maintained for a sufficient period of time, and implemented appropriately by parents. Clearly, if the enuresis is due to a physiological condition, the problem needs to be treated using appropriate medication. These medications, and their effectiveness, will not be considered in this chapter, for this discussion focuses primarily on the treatment of enuresis due to a psychological etiology.

Van Londen and colleagues demonstrated that arousal training obtained a 98% success rate with nonclinical boys and girls with nocturnal enuresis between the ages of 6 and 12 years. Even 2½ years after the initial training, 92% of children were continent. This compared with a success rate of 84% where reward reinforcement only was used, and 73 percent where the urine alarm was used without any rewards. The 2½ year success rate for these two approaches was 77% and 72%, respectively. The majority of children in the arousal training condition who experienced a relapse did so only once (62%),

and most of these relapses were treated successfully by parents reinstating arousal training techniques (60%), without seeking professional help.

In contrast to these results, Walling only reported a success rate of 70% using an alarm. However, Walling's paper does not make clear if the respondents were drawn from a clinical population and if all aspects of arousal training (reinforcement as well as the alarm) were used in treatment. Schulman, Colish, von Zuben, and Kodman-Jones also found a success rate of 56% using an alarm in the treatment of their clinical patients with enuresis. However, this rate was significantly better than the use of medication (18% and 16% for two different medical interventions).

In reviews of studies to treat nocturnal bed-wetting, it was found that the most effective treatment for enuresis was dry bed training and an enuresis alarm. The data also demonstrated that success was more likely when the problem was maturational and less likely in situations where there was a psychiatric disorder of the child, severe family stress, lack of concern by child and parents, or urological dysfunction. Medication was shown to have limited usefulness and was effective primarily when there was a physiological cause for the enuresis.

Other researchers have reported up to 90% effectiveness with a short-term conditioning techniques for enuresis. However, closer examination of these techniques demonstrates that they involved the use of an alarm, but this was not accompanied by reinforcement from the parents for dry nights. Within this literature there are major difficulties in comparing results across different studies. The severity of the children's enuresis, the level of support provided by the parents, the number of treatment sessions, as well as the focus of the treatment program, all show substantial variability across studies. These factors will undoubtedly impact on the effectiveness of the arousal training procedure.

It appears that arousal training in its various forms is the most effective treatment for enuresis. This is most likely to be successful if both the child and the parents are highly motivated, and the therapist acts to clearly communicate the strategies to be employed and assists in the maintenance of motivational levels within the family.

A number of studies have evaluated the effectiveness of arousal training in the treatment of inorgasmia in women. In a review of studies that examined the factors that contributed to sexual arousal among women, it was found that masturbation frequency, coital frequency, and having a positive opinion about erotic stimulus and a

higher awareness of vaginal lubrication were the most significant predictors of both subjective and physiological sexual arousal. These results would suggest that respondents who have a positive attitude to their sexual responses, and who are attuned to their levels of arousal, are more likely to experience higher levels of both physiological and subjective sexual arousal. Thus, arousal training would be expected to be an effective therapy with women experiencing inorgasmia.

This prediction is supported by studies by McCabe and her colleagues that employed imagery training to enhance sexual arousal among inorgasmic. Imagery training was used in both of these studies to desensitize inorgasmic women to the anxiety and fears that they held regarding sexual arousal and orgasmic responding. This process of desensitization was designed to enhance both physiological arousal and subjective levels of arousal. It was, therefore, a form of arousal training that was designed to operate at both the physiological and subjective level. The data from both studies demonstrated some level of effectiveness using these techniques.

A problem with using arousal training among women who experience inorgasmia is that there may be habituation to stimuli. As yet, there appear to be no clear data on the circumstances under which habituation occur, and some sexual stimuli continue to retain their sexual-arousing capacities despite repeated exposure.

Further studies need to be conducted on arousal training for inorgasmia, and the effectiveness of the treatment programs needs to be contrasted with both alternative treatment programs that do not utilize arousal training strategies and wait-list controls. Although theoretically one would expect arousal training to be a useful approach for the treatment of inorgasmia, until these studies are completed it is difficult to draw any confident conclusions about the effectiveness of this type of therapy among inorgasmic women.

IV. SUMMARY

Arousal training is a therapeutic technique that uses learning principles to either decrease or increase levels of arousal in order to achieve an appropriate therapeutic outcome.

This approach has been used effectively in the treatment of nocturnal enuresis among children. Interventions are most likely to be effective if both the child and the parent are highly motivated, and if the arousal alarm in combination with reinforcement is used in the treatment regime. It is also important to continue treatment

for a number of weeks after the child has a dry bed in order to firmly establish the new learning processes.

Arousal training also appears to be effective in the treatment of inorgasmia in women. Learning theory can be used to explain the development of this sexual dysfunction, and inorgasmic women have been shown to experience low levels of sexual arousal. Although further research is needed to determine other strategies to enhance arousal, preliminary research would suggest that imagery training is an effective mechanism to increase arousal levels.

Further research needs to be conducted to determine the effectiveness of arousal training with other clinical disorders.

See Also the Following Articles

Bell-and-Pad Conditioning ■ Classical Conditioning ■ Nocturnal Enuresis ■ Operant Conditioning ■ Orgasmic Reconditioning ■ Sex Therapy

Further Reading

- Delany, S. M., & McCabe, M. P. (1988). Secondary inorgasmia in women: A treatment program and case study. *Sexual and Marital Therapy, 3*, 165–190.
- Everaerd, W., & Laan, E. (1995). Desire for passion: Energetics of sexual response. *Journal of Sex and Marital Therapy, 21*, 253–261.
- Friman, P., & Volmer, D. (1995). Successful use of the nocturnal alarm for diurnal enuresis. *Journal of Applied Behavioral Analysis, 28*, 89–90.
- Gimpel, G. A., & Warzak, W. J. (1998). Clinical perspectives in primary nocturnal enuresis. *Clinical Paediatrics, 37*, 23–30.
- Houts, A. C., Berman, J. S., & Abramson, H. (1994). Effectiveness of psychological and pharmacological treatments for nocturnal enuresis. *Journal of Consulting and Clinical Psychology, 62*, 737–745.
- Laan, E., & Everaerd, W. (1995). Determinants of female sexual arousal: Psychophysiological theory and data. *Annual Review of Sex Research, 6*, 32–76.
- Levin, R. (1992). The mechanism of human female sexual arousal. *Annual Review of Sex Research, 3*, 1–48.
- Marcovitch, H. (1993). Treating bedwetting: Bladder exercises, star charts, enuresis alarms, and now ERIC. *British Medical Journal, 306*, 536–537.
- Purcell, C., & McCabe, M. P. (1992). The impact of imagery type and imagery training on the subjective sexual arousal of women. *Sexual and Marital Therapy, 7*, 251–260.
- Schulman, S. L., Colish, Y., von Zubin, F. C., & Kodman-Jones, C. (2000). Effectiveness of treatments for Nocturnal Enuresis in a heterogeneous population. *Clinical Paediatrics, 39*, 359–367.
- Walling, A. D. (1999). Nocturnal enuresis. *American Family Physician, 60*, 644.

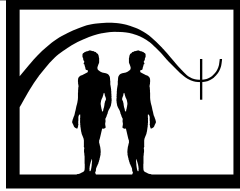

Art Therapy

Marcia Sue Cohen-Liebman

Philadelphia Children's Alliance, MCP Hahnemann University, and American Art Therapy Association

- I. Definition
- II. Background
- III. Theoretical Constructs
- IV. Materials/Media
- V. Artistic Developmental levels
- VI. The Art Therapist
- VII. Educational Requirements
- VIII. Art Therapy Credentials Board
- IX. American Art Therapy Association
- Further Reading

interests, concerns, and conflicts. Art therapy practice is based on knowledge of human developmental and psychological theories, which are implemented in the full spectrum of models of assessment and treatment.

Art therapy is an effective treatment for the developmentally, medically, educationally, socially, or psychologically impaired. It is practiced in mental health, rehabilitations, medical, educational, and forensic institutions. Populations of all ages, races, and ethnic backgrounds are served by art therapists who provide services to individuals, couples, families, and groups.

GLOSSARY

art therapy A human service profession that utilizes art media, images, the creative process, and patient/client responses to art productions as reflections of an individual's development, abilities, personality, interests, concerns, and conflicts.

American Art Therapy Association (AATA) A 5000-member association founded in 1969 that is governed and directed by a nine-member board elected by the membership.

I. DEFINITION

Art therapy is a human service profession that utilizes art media, images, the creative process, and patient/client responses to art productions as reflections of an individual's development, abilities, personality,

II. BACKGROUND

Art therapy emerged as a distinct profession in the 1930s. Since that time art therapy has grown into an effective and important method of communication, assessment, and treatment. Sound theoretical principles and therapeutic practices govern the modality. The theoretical orientation of art therapy includes psychoanalytic theory as well as art education.

III. THEORETICAL CONSTRUCTS

Two schools of thought are fundamental to the profession of art therapy: Art Psychotherapy and Art as Therapy. Both have contributed to the progressive de-

velopment of the field. Often basic tenets associated with both schools of thought are integrated in the practice of art therapy. Psychoanalytic tenets provide the basis for both methods of practice.

Margaret Naumburg is credited with the first use of art expression as a therapeutic modality. She encouraged her patients to draw spontaneously and to free associate to their drawings in the 1940s. Her use of art was based on psychoanalytic theory and practice. She believed that art therapy was dynamically oriented and was dependent on the transference relationship between patient and therapist. For Naumburg therapeutic art expression allows for a symbolic communication, which bypasses difficulties encountered with verbal communication. Naumburg encouraged the patient to discover for himself or herself the meaning of his or her artwork. Art psychotherapy is a process-oriented approach that involves art behavior, clinical behavior, and the associations of the patient. The latter is fundamental to comprehending a client or patient's understanding of his or her imagery.

In contrast, Edith Kramer concentrated on the integrating and healing properties of the creative process itself. Her theories evolved out of her work with children in the 1950s. For Kramer the healing quality inherent in the creative process explains the usefulness of art in therapy. In art as therapy, the therapist functions as an auxiliary ego and assumes a supportive role. Sublimation is a key component associated with Kramer's work. Judy Rubin in 1984 explained that in the creative act (art making), conflict is reexperienced, resolved, and integrated.

For Naumburg, art making assisted the therapeutic process. Kramer focused on the art making believing that the creative process in and of itself was intrinsically therapeutic.

Myra Levick in 1983 recognized the correlation between emotional development, intellectual development, and creative expression that is fundamental to art therapy. Levick also developed criteria for the identification of defense mechanisms of the ego in graphic productions. This knowledge assists with the identification of areas of fixation as well as conflicts and issues that are central to the individual.

IV. MATERIALS/MEDIA

Media is a term used to describe art materials. Media encompass a variety of items including two- and three-dimensional materials. An art therapist is familiar with the inherent properties and resulting qualities of the

media as well as what may be evoked by the introduction of certain materials. The art therapist assesses the stimulus potential of the media in conjunction with the coping skills of the client/patient in an effort to introduce appropriate materials and tasks. The art therapist is trained to comprehend what is being expressed with regard to the media. Different media evoke different responses and convey different messages.

Art materials exist on a continuum from structured to unstructured. Structured media have a definitive shape and form and make a definitive mark. Two-dimensional art materials are representative of structured media, including pencils, crayons, markers, and pastels. Unstructured media, such as clay or paint, require the user to give the media shape and form. It does not make a consistent line and is more subject to gravity. The art therapist's capability to comprehend and interpret what is being expressed with regard to the media is fundamental to the practice of the modality. This information provides the art therapist with insight regarding underlying issues, conflicts, and concerns.

V. ARTISTIC DEVELOPMENTAL LEVELS

A phase-specific developmental sequence has been associated with children's drawings. Although different phases or stages have been identified by different researchers, children's artistic development is sequential and contingent on mastery of skills. Knowledge of typical developmental variants is essential to understanding the graphic productions created by children. Many factors and influences will contribute to maturation in developmental spheres including artistic. Cathy Malchiodi in 1998 explored developmental aspects of children's drawings in her text, *Understanding Children's Drawings*.

VI. THE ART THERAPIST

Art therapists are skilled in the therapeutic use of art. Art therapists use their backgrounds as artists and their knowledge of art materials in conjunction with clinical skills. The art therapist treats clients/patients through the use of therapeutic art tasks. While the art therapy process uses art making as a means of nonverbal communication and expression, the art therapist makes use of verbal explorations and interventions. Art therapists do not own art or the healing that comes from its use.

The therapeutic use of art distinguishes the art therapist from other helping professions. The art therapist may act as a primary therapist or as an adjunct within the treatment team, depending on the needs of the institution and the treatment objectives of the patient. Art therapists function in many capacities including supervisors, administrators, consultants, and expert witnesses.

VII. EDUCATIONAL REQUIREMENTS

Professional qualification for entry into the field requires a master's degree from an accredited academic institution or a certificate of completion from an accredited institute or clinical program. Specialized training programs include didactic instruction and practicum experience. Graduate art therapy training programs are commonly associated with medical colleges or universities. The designation art therapist registered, ATR, is granted to individuals who have successfully completed the required educational and professional experience.

VIII. ART THERAPY CREDENTIALS BOARD

The Art Therapy Credentials Board, Inc. (ATCB), an independent organization, grants postgraduate registration (ATR) after reviewing documentation of completion of graduate education and postgraduate supervised experience. The Registered Art Therapist who successfully completes the written examination administered by the ATCB is qualified as Board Certified (ATR-BC), a credential requiring maintenance through continuing education credits.

IX. AMERICAN ART THERAPY ASSOCIATION

The American Art Therapy Association (AATA) was established in 1969 as a nonprofit organization. AATA is governed and directed by a nine-member board that is elected by the membership. Current membership is approximately 5000 members in five membership categories. Affiliate chapters exist throughout the country and promote the field of art therapy at the local level. Educational, professional, and ethical standards for art therapists are regulated by the American Art Therapy Association.

The Mission statement of the American Art Therapy Association is as follows:

The American Art Therapy Association, Inc. (AATA) is an organization of professionals dedicated to the belief that the creative process involved in the making of art is healing and life enhancing. Its mission is to serve its members and the general public by providing standards of professional competence, and developing and promoting knowledge in, and of, the field of art therapy.

Conceptually, AATA's philosophy, goals, and objectives endeavor to ensure credentialed art therapists deliver the highest standard of care possible to the general public. AATA's mission fosters the highest level of quality services from professional, highly trained art therapists. AATA's vision for the 21st century is the inculcation and recognition of art therapy as an integral part of all health care delivery systems.

For more information regarding the profession of art therapy and the National Association contact: The American Art Therapy Association, Inc. (AATA), www.arttherapy.org. For more information regarding registration and certification contact: The Art Therapy Credentials Board, Inc. (ATCB), atcb@nbcc.org.

Resources available from AATA include professional preparation literature as well as art therapy literature. Sample brochures include: *Art Therapy the Profession*, *Art Therapist Model Job Description*, *Fact Sheet*, *Membership Survey*, *Ethical Considerations Regarding The Therapeutic Use Of Art By Disciplines Outside The Field Of Art Therapy*, *Art Therapy in the Schools*, *Educational Programs*, and *Ethics Document*.

Acknowledgment

Some material reprinted with permission from the American Art Therapy Association Inc. All rights reserved.

See Also the Following Articles

Alternatives to Psychotherapy ■ Biblical Behavior Modification ■ Cinema and Psychotherapy ■ Therapeutic Storytelling with Children and Adolescents

Further Reading

- Junge, M., & Asawa, P. (1994). *A history of art therapy in the United States*. Mundelein, IL: The American Art Therapy Association, Inc.
- Levick, M. (1983). *They could not talk and so they drew: Children's styles of coping and thinking*. Springfield, IL: Charles C. Thomas.

- Levick, M. (1998). *See what I'm saying: What children tell us through their art*. Dubuque, IA: Islewest Publishing.
- Lowenfeld, V., & Brittain, W. L. (1987). *Creative and mental growth*. New York: Macmillan.
- Malchiodi, C. (1998). *The art therapy sourcebook*. Los Angeles, CA: Lowell House.
- Malchiodi, C. (1998). *Understanding children's drawings*. New York: Guilford Press.
- Moon, B. (2000). *Ethical issues in art therapy*. Springfield, IL: Charles C Thomas.
- Naumburg, M. (1987). *Dynamically oriented art therapy: Its principles and practices*. Chicago, IL: Magnolia Street Publishers.
- Olivera, B. (1997 Winter). Responding to other disciplines using art in therapy. *AATA Newsletter*, XXX, 17.
- Rubin, J. (1984). *Child art therapy*. New York: Van Nostrand Reinhold.
- Rubin, J. (1999). *Art therapy: An introduction*. Philadelphia, PA: Brunner/Mazel.
- Wadeson, H. (1980). *Art psychotherapy*. New York: John Wiley & Sons.

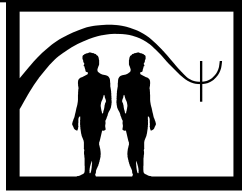

Assertion Training

Eileen Gambrill

University of California at Berkeley

- I. Description of Treatment
 - II. Theoretical Bases
 - III. Applications and Exclusions
 - IV. Empirical Studies
 - V. Case Example
 - VI. Summary
- Further Reading

GLOSSARY

- behavior rehearsal** Practicing behaviors of interest.
- coaching** Providing corrective feedback to develop a skill.
- cognitive restructuring** Helping clients to increase self-statements that contribute to attaining valued outcomes and to decrease self-statements that have the opposite effect.
- discrimination training** Reinforcing a behavior in one situation and not in others in order to increase the rate of a behavior in situations in which it will be reinforced (followed by positive consequences or avoidance or decrease of negative consequences).
- exposure** Being in the presence of certain stimuli.
- generalization** The occurrence of a behavior in situations similar to the one in which it was established.
- hierarchy** A ranked order of items such as situations ranked in relation to degree of anxiety they create.
- maintenance** The continuation of a behavior over time.
- model presentation** Presenting exemplars of behavior that observers can imitate.
- self-management** Setting goals and arranging cues and consequences to attain certain goals.
- stimulus control** Procedure for altering the rate of behavior in a situation by rearranging antecedents to behaviors of interest.

The aim of assertion training is to enhance interpersonal effectiveness in social situations. Positive consequences may be forgone because of anxiety in social situations. Assertion training emphasizes the extent to which we can influence our social environment by being active in its construction. In 1973 Joseph Wolpe defined assertive behavior as “The proper expression of any emotion other than anxiety toward another person.” Lack of effective social skills may result in a variety of maladaptive behaviors. Assertion training often in combination with other methods, has been used to address a wide variety of presenting complaints including substance abuse, aggressive and explosive behaviors, and obsessive-compulsive behaviors. It has been used to help people make friends, arrange dates, and acquire needed help (e.g., on the part of individuals with learning disabilities). Essentially, assertive skills are effective social influence skills acquired through learning.

The terms “assertive behavior” and “assertion” (or “assertiveness”) training have been replaced by the terms “effective/competent social behavior” and “social skills training.” Some authors use the term “assertive behavior” to refer to a circumscribed set of behaviors such as refusing requests. One problem with use of the term “assertive behavior” is confusion of “assertion” with “aggression.” Another potential disadvantage is encouraging a trait approach to social behavior that obscures the situational specificity of social behavior; that is, a client may be appropriately assertive in some situations (effective in achieving desired outcomes such as arranging

future meetings with a friend), passive in other (e.g., refusing favors), and aggressive in others (e.g., requesting changes in behavior). Assertion training differs from social skills training in emphasizing individual rights and obligations. For example, an advantage of the phrase “assertive behavior” for some groups such as women is an emphasis on taking the initiative to enhance social and other opportunities. There is an activist stance. If intervention is successful, anxiety in interpersonal situations decreases and assertive responses are used when a client believes these would be of value in attaining personal and social goals; clients may be indifferent to situations that previously caused discomfort, such as minor digs and slights, and misconceptions of situations as rejecting (perhaps due to oversensitivity) should decrease. Discussion of the limiting effects of stereotyping and role expectations may result in greater sensitivity to certain situations (such as belittling sexist remarks) and greater likelihood of assertive reactions in such situations.

I. DESCRIPTION OF TREATMENT

Assertion training usually consists of a variety of components, including instruction, model presentation, behavior rehearsal, feedback, programming of change, and homework assignments. Other procedures that may also be used, depending on what is found during assessment, include self-instruction training, relaxation training, cognitive restructuring (e.g., decreasing unrealistic expectations or beliefs), and interpersonal problem-solving training (helping clients to effectively handle challenging situations that arise in social situations such as reactions of anger that get in the way of maintaining friendships). Written material may be used to provide instructions and to clarify differences among aggressive, assertive, and passive behaviors in a situation. For example if you believe you have been treated unfairly by a professor, you could appropriately speak to your instructor about your concerns (be assertive), say nothing (be passive), or yell at the instructor (be aggressive). Selection of intervention methods should flow directly from assessment. This provides information about the nature of a client’s current cognitive (what they say to themselves), emotional (what they feel), and behavioral (what they do) repertoires in relation to desired goals and related situations, as well as likely consequences of and options for rearranging the environment. Role-playing during assessment (acting out what is usually done as well as what a client thinks

he or she should do) may reveal that the client has many effective components of needed skills, and it may be decided that instructions and prompts during rehearsal will be sufficient to develop and refine needed skills. If effective behaviors are not used because of anxiety, intervention may focus on enhancing anxiety management skills. However, if needed social skills are absent, procedures designed to develop them, such as instructions, model presentation, and practice, may be needed. Discrimination training is required when skills are available but are not used in situations in which they would result in valued outcomes. This is designed to increase a behavior in situations in which it will be followed by positive outcomes and/or decrease it in situations in which negative outcomes are likely. Assessment may reveal that effective behaviors simply have to be placed under new stimulus control (i.e., prompted, perhaps by self-instructions, in certain situations). For example, effective ways of requesting favors from a friend may be of value in work situations but not be used there. Training may be carried out individually or in a group setting. A session may focus on developing effective behavior in one situation or on increasing a specific behavior of value in a range of similar situations (friendly reactions such as smiling).

A. Instructions

Instructions concerning effective behavior may be given verbally or presented in written, audiotape, or filmed form. This is often combined with model presentation and coaching during role-plays. Specific behaviors are identified to increase, decrease, stabilize, or vary and their relationship to desired goals described. Instructions may be given concerning only one behavior at a time, which is then role-played, or more than one behavior may be reviewed depending on the available skills (entering repertoires) of each client. What not to do (e.g., smile or giggle while requesting a change in an annoying behavior) as well as what to do (e.g., look at the person, face the person) are described.

B. Model Presentation

Instruction, model presentation, rehearsal, and coaching can be used when clients lack requisite behaviors in certain situations or when there is a need to refine behaviors. The need to use modeling will be influenced by the complexity of the skill to be acquired and nature of the entering repertoires (available skills) of clients. The greater the complexity of the skill and

the more lacking the initial repertoire, the greater the value of model presentation is likely to be. An advantage of model presentation is that an entire chain of behavior can be illustrated and the client then requested to imitate it. Nonverbal as well as verbal behaviors can be demonstrated and the client's attention drawn to those that are especially important. For example, a client can be asked to notice the model's eye contact, hand motions, and posture. Models of both effective and ineffective behavior may be presented. The model may verbalize (say aloud) helpful positive thoughts during role plays if effective social skills are hampered by negative thoughts such as "I'll always be a failure," "I'll never succeed." At first, appropriate self-statements can be shared out loud by the client when imitating the model's behavior (e.g., "Good for me for taking a chance"), and then, by instruction, gradually moved to a covert level. Donald Meichenbaum in 1972 found that models who display coping responses (for example, they become anxious and then cope effectively with this) are more effective than are models who display mastery response (they do not experience any difficulty in a situation).

Effective behaviors may be modeled by the counselor, or written scripts, audiotape, videotape, or film may be used. Essential elements of various responses can be highlighted and written models offered. The advantage of written material is that it can be referred to on an as-needed basis. In addition, the client may be asked to observe people with effective behavior who are in similar roles and to write down the situation, what was done, and what happened. This increases exposure to a variety of effective models, offers examples to use during rehearsal and may increase discrimination as to when to use certain behaviors and when not to do so, and offers opportunities for vicarious extinction of anxiety reactions through observation of positive outcomes following assertive behavior (that is, negative emotional reactions decrease via observation of what happens to others). The opportunity to see how negative reactions to assertive reactions can be handled may be offered as well. Client observations are discussed, noting effective responses as well as other situations in which assertive behaviors may be usefully employed.

C. Behavior Rehearsal and Feedback

Following model presentation, the client is requested to practice (rehearse) the modeled behavior. Corrective feedback is offered following each rehearsal.

Specific positive aspects of the client's performance are first noted and praised. Praise is offered for effective behaviors or approximations to them, and coaching provided as needed. The focus is on improvements over baseline levels (what a client can do before intervention is initiated). Thus, approximations to hoped-for outcomes are reinforced. Critical comments such as "You can do better" or "That wasn't too good," are avoided. The client is encouraged to develop behaviors that are most likely to result in positive consequences. A hierarchy of scenes graduated in accord with the client's anxiety may be used for role-playing. Role-playing starts with scenes that create low levels of discomfort. Clients who are reluctant to engage in role-playing can be requested to read from a prepared script. As comfort increases, role-playing can be introduced. If a client is too anxious to read from a script, relaxation training may be offered as a prelude to role-playing. When there are many skills to be learned, one behavior at a time may be focused on. Each role-play may be repeated until required levels of skill and comfort are demonstrated.

Models and instructions are repeated as needed, and rehearsal, prompts, and feedback continued until desired responses and comfort levels are demonstrated. Rehearsal alone (without previous model presentation or other instructions), may be effective when skills are available or relevant behaviors are simple rather than complex. The situations used during role-playing should be clearly described and closely resemble real-life conditions. Instructions prior to practice or signals during practice can be used to prompt specific responses. Instructions given before a client practices a behavior "prompt" her to engage in certain behaviors rather than others. Perhaps a client did not look at her partner during the role-play and is coached to look at others while speaking. Checklists may be prepared for clients as reminders about effective behaviors. Covert modeling or rehearsal in which clients imagine themselves acting competently in social situations may be as effective as actual rehearsal if clients possess needed social behaviors (but do not use them) and if social anxiety is low. Home sessions in which clients engage in covert rehearsal can be used to supplement rehearsal in office sessions. Not only does behavior rehearsal provide for learning new behaviors, it also allows their practice in a safe environment and so may reduce discomfort. Rehearsal involves exposure to feared situations. This exposure is considered to be a key factor in decreasing social anxiety, especially if people remain in the situation even when they are anxious and act effectively in spite of their discomfort.

D. Programming of Change

Specific goals are established for each session. Perhaps only one or two behaviors will be focused on in a session, or the initial repertoire might be such that all needed verbal and nonverbal behaviors can be practiced. Assessment of the client's behavior in relation to given situations will reveal available behaviors and training should build on available repertoires. Hierarchies ranked in terms of the degree of anxiety or anger that different social situations create can be used to gradually establish effective assertive skills and lessen anxiety. Rehearsal starts with situations creating small degrees of anger or anxiety. Higher-level scenes are introduced as anxiety or anger decreases. Thus, introduction of scenes is programmed in accord with the unique skill and comfort levels of each client. Improvements are noted and praised. Praise for improvement should be in relation to a client's current performance levels.

E. Homework Assignments

After needed skill and comfort levels are attained, assignments, graded in accord with client comfort and skill levels, are agreed on to be carried out in the natural environment. Assignments are selected that offer a high probability of success at a low cost in terms of discomfort. Careful preparation may be required if negative reactions may occur in real life. A clear understanding of the social relationships in which assertive behavior is proposed is needed to maximize the likelihood of positive consequences and minimize the likelihood of negative outcomes when assertive behaviors are used. For example, a parent may be likely to become verbally abusive if his son makes certain requests. This possibility should be taken into account (e.g., by encouraging behaviors unlikely to result in abuse, or by using some other form of intervention such as family counseling). Coping skills should be developed to handle possible negative reactions before asking the client to carry out new behaviors. With some behaviors, such as assertive behaviors in service situations, unknown individuals may be involved. Clients can be coached to identify situations in which positive reactions are likely. For example, in service situations such as returning a defective purchase, clients can be coached to approach clerks who appear friendly rather than ones who scowl and look as if they have had a bad night.

When effective social behavior occurs without difficulty in easy situations, more difficult ones are then attempted. Clients are instructed to offer positive self-

statements ("I spoke up and it worked!") for effective behavior. Practice, coaching, and model presentation provide instruction concerning the essential elements of effective behavior, and clients are encouraged to vary their reactions in appropriate ways. As with any other assignment, a check is made at the next meeting to find out what happened. Client logs (records) describing relevant behaviors and the situations in which they occurred can be used to provide a daily record of progress and guide selection of new assignments. Information reviewed may include what was said and done; when it was said and done; how the client felt before, during, and after the exchange; whether positive self-statements were provided for trying to influence one's social environment (even though the attempt failed); and what consequences followed the client's behavior. If an ineffective response was given in a situation, clients can be asked to write down one that they think would be more effective. This will provide added practice in selecting effective behaviors. Positive feedback is offered for effective behaviors, additional instructions given as necessary, and further relevant assignments agreed on. Motivation to act assertively may be enhanced by encouraging clients to carry out mini cost-benefit analyses in situations of concern in which they compare costs and benefits of acting assertively (versus passively or aggressively).

F. Cognitive Restructuring— Changing What Clients Say to Themselves

Thoughts relevant to assertive behavior include helpful attributions (casual accounts or behavior), realistic expectations ("I may not succeed; no one succeeds all the time"), helpful rules ("when in doubt think the best"), self-reinforcement for efforts to improve and positive consequences, problem-solving skills, and accurate perception and translation of social cues (e.g., noting and accurately interpreting a smile as friendly). In addition, cognitive skills (e.g., distraction) are involved in the regulation of affect (e.g., anger or anxiety). Unrealistic beliefs (such as "I must always succeed") and other kinds of thoughts such as negative self-statements that get in the way of assertive behavior should be identified and replaced by helpful self-statements and beliefs. This process is initiated during assessment and continues during intervention. Discussion of beliefs about what is proper assertive behavior and who has what rights

should be held during assessment in the process of selecting goals. Cognitive restructuring may include altering unrealistic expectations, altering attitudes about personal rights and obligations, and/or self-instruction training in which clients learn to identify negative self-statements related to effective social behavior and to replace them with positive self-statements.

Self-management aspects of assertive behavior include identifying situations in which assertion is called for (and when it is not), monitoring (tracking) the consequence of assertion, and offering helpful self-feedback. The likelihood of effective social behaviors may be increased by covert (to one's self) questions that function as cues such as What's happening?, What are my choices?, What might happen if...?, Which choice is better?, How could I do it?, How did I do?

G. Anxiety Reduction Methods

Relaxation training could be provided if anxiety interferes with use of assertive skills. The specific method selected to alter anxiety will depend on the cause(s) of anxiety (e.g., negative thoughts, a past history of punishing consequences because of lack of skills), and/or unrealistic expectations ("Everyone must like me").

H. Encouraging Generalization and Maintenance

Generalization refers to the use of assertive behaviors in situations other than those in which training occurred. *Maintenance* refers to their continued use over time. Steps that can be taken to increase the likelihood of generalization and maintenance of assertive behaviors include recruiting natural reinforcers (e.g., involving significant others), reinforcement for using behaviors in new situations (e.g., self-reinforcement), and use of a variety of situations during training. Generalization and maintenance can be encouraged by use of homework assignments and self-monitoring (e.g., keeping track of successes). Situational variations that may occur in real life that influence assertive behavior should be included in practice examples to encourage generalization and maintenance. For example, a woman may have difficulty refusing unwanted requests in a variety of situations (e.g., with friends as well as supervisors at work). If so, practice should be arranged in these different situations. Self-reinforcement may encourage the development and maintenance of new behaviors. Such reinforcement may be of special relevance in maintaining behaviors that are

sometimes followed by punishing consequences. Clients can be encouraged to reward themselves for making efforts to exert more effective influence over their social environment, even though they are not always successful (e.g., if a woman tries to speak up more during a meeting and fails to gain the floor, she should reward herself for trying).

II. THEORETICAL BASES

A key assumption behind assertion training is that we often lose out on positive outcomes or suffer negative ones because of ineffective social behavior. For example, we may not get a job that we want because we lack the skills to speak up and present ourselves well in a situation. We may not be effective in meeting friends because we do not initiate conversations. A value stance as well as an intervention strategy is associated with assertion training. It is assumed that people have a right to express their feelings in a manner that subjugates neither others nor themselves, and that well-being includes this expression. Joseph Wolpe and Andrew Salter emphasized the importance of expressing our feelings, both positive and negative, in a way that does not detract from the rights and obligations of others. This applies to the overly reticent as well as to those who are overly aggressive. Those in the former group fail to assert their rights, whereas those in the latter group achieve their goals at the expense of others. Individual rights and obligations are emphasized in a context of increasing positive gains both for oneself and others. Such training implies that it is adaptive to express ourselves in appropriate ways, and distinguish situations in which restraint is called for from those in which assertion would be best. It is considered maladaptive and unfair to be taken advantage of, to allow oneself to be unduly imposed on, and to be intimidated. It is assumed that life will be more reinforcing if we are active in the construction of our social environments. Obligations include considering the rights of others. Clients are encouraged not only to consider their own rights and obligations in a situation but those of others as well. What is viewed as a right or obligation varies in different cultures and ethnic groups, and counselors will have to be careful not to impose their cultural standards on groups in which these are not appropriate (e.g., negative consequences and/or loss of positive consequences may result). Steps are taken to deal with anxiety about possible negative reactions by the development of positive self-instructions and effective social and relaxation skills (as needed).

It is assumed that behaviors, thoughts, and feelings are interrelated. For example, negative thoughts about ourselves may interfere with expressing and acting on our feelings (e.g., initiating conversations, answering questions in class). These thoughts and lack of action may, in turn, create anxiety or feelings of depression because of a loss of positive consequences or negative consequences. If we speak up (assert ourselves) and acquire valued consequences in situations in which we were reticent in the past, this makes it easier to act on future occasions because we are less anxious. Joseph Wolpe emphasized the importance of reciprocal inhibition; that is, if we engage in a response that is incompatible with anxiety in a certain situation, this will “countercondition” anxiety reactions and it will be easier to perform this opposite type of response in the future. Speaking up rather than not saying anything was viewed as one kind of incompatible response (i.e., to anxiety). Research in this area suggests that it is exposure that contributes to positive effects. That is, simply getting in a situation in which we are anxious and performing effectively in that situation seems to be the effective ingredient in decreasing anxiety and encouraging assertive behavior on future occasions.

III. APPLICATIONS AND EXCLUSIONS

Assertion training requires a careful descriptive analysis of relevant interpersonal relationships. If this analysis indicates that assertion would have unavoidable negative effects, as it may for example in abusive relationships, this would not be recommended. Other methods must be explored. Clients must be willing to act differently in real-life situations and have the self-management skills to do so (e.g., remind themselves to act differently). Cultural differences regarding what behaviors will be effective in certain social situations must be considered. Effective social behavior is situationally specific; what will be effective in one situation may not be in another.

Assertion training may be carried out in groups. A group offers a number of advantages including a variety of models, multiple sources of support, normalization and validation of concerns, and the availability of many people to participate in role-plays. Groups usually include from 5 to 10 sessions lasting one and a half to two hours each. Decisions must be made about how to structure sessions (for example, each session could be structured around a specific kind of assertive reaction). Assertion training in groups has been carried out with a

variety of individuals, including college students, parents, public welfare clients, people with various psychiatric diagnoses, and women. Group training may be especially important for women. Because of their socialization, women compared to men may require more social support and more opportunities to observe assertive women in order for them to express their preferences.

IV. EMPIRICAL STUDIES

Both single case and group designs have been used to evaluate the success of assertion training. Single-case designs are uniquely suited for evaluating progress with individual clients. Here, baseline levels of performance of an individual are compared with performance levels of that individual during intervention. Research suggests that assertion training can be effective with a number of different types of clients in pursuit of a number of different outcomes. Programs focused on altering cognitions believed to be related to ineffective social behavior have sometimes been found to be as effective as those focused on altering overt behavior, suggesting an equivalence of effect across cognitive methods and assertion training. There are some indications that a combination of methods is most effective. However, some studies that purport to show that cognitive methods are as effective as social skills training in enhancing social skills do not include individual assessment of specific entry level skills and do not design individually tailored programs based on this assessment. This lack may underestimate the potential value of assertion training. A number of studies show that instructions alone (without modeling) are not sufficient to develop appropriate social behaviors with some clients labeled “schizophrenic.”

Comparison of the effectiveness of assertion training in different studies is often hampered by the use of different criteria for selection of subjects, different training programs, and different criteria for evaluating progress. Evaluation is sometimes limited to changes in self-report or role-play measures, leaving the question unanswered as to whether beneficial changes occur in real life. Altering behavior in one kind of situation such as refusing requests, does not necessarily result in changes in behavior in other kinds of situations such as initiating conversations. Package programs may be used leaving the question “What are the effective ingredients of assertion training?” unanswered. Use of package programs may also be a waste of time and effort in including unneeded components. Use of global self-report

measures to assess change in specific areas may result in underestimating success of assertion training in relation to behavior in specific situations. Assertion training may do little to alter political, social, and economic sources of inequity; it is individually focused. There is thus the danger of blaming clients for problems that do not originate with them. The ideology of success through "mind power" (changing what you think), which is especially prevalent in America where assertion training flowered, requires vigilance to discourage programs that offer only the illusion of greater influence over one's social environment.

V. CASE EXAMPLE

Richard Eisler and his colleagues Michel Hersen and Peter Miller in 1974 used assertion training with a 28-year-old house painter admitted to a hospital after he had fired a shotgun into the ceiling of his home. His history revealed periodic rages following a consistent failure to express anger in social situations. His behavior was assessed by asking him to role-play in social situations in which he was unable to express anger. These included being criticized by a fellow employee at work, disagreeing with this wife about her inviting company to their home without checking with him first, and his difficulty refusing requests made by his 8-year-old son. An assistant played the complementary role in each situation (wife, son, or fellow employee). The client's reactions were videotaped and observed through a one-way mirror. Review of data collected revealed expressive deficits in four components of assertion: (1) eye contact (he did not look at his partner when speaking to him), (2) voice loudness (one could barely hear what he said), (3) speech duration (responses consisted of one- or two-word replies), and (4) requests (he did not ask his partner to change his or her behavior).

Twelve situations that were unrelated to the client's problem areas but that required assertive behavior were used during training. Each was role played five times in different orders over sessions. Instructions were given to the client through a miniature radio receiver. Instructions related to only one of the four responses at any one time. Thus during the initial scenes he was coached to look at his partner when speaking to him, and during the second series he was coached to increase the loudness of his voice but received no instructions concerning any other response. During the fourth series, he was coached to speak longer, and during the last, instructed to ask his partner for a behavior

change. Feedback was provided concerning his performance after each role-play. Each response increased after specific instructions regarding this were given and effects generalized to the specific situations that were problematic for this client. Ratings of his behavior were made by reviewing videotapes of his performance.

VI. SUMMARY

Assertion training is designed to increase competence and decrease social anxiety in social interactions. It may be carried out in individual or group meetings. Both broad and narrow definitions of assertive behavior have been used, ranging from definitions that restrict the term to behaviors such as refusing unwanted requests to broad definitions that include a wide range of behaviors involving the expression of both positive and negative feelings. The distinctions among assertive, passive (doing nothing), and aggressive (e.g., yelling) behavior are made with assertion referring to effective behavior. Assertive training differs from social skills training in its emphasis on personal rights and obligations. There is a philosophy or ideology that accompanies assertion training that does not accompany social skills training. A number of procedures are usually involved in assertion training, including instructions, model presentation, behavior rehearsal and coaching, feedback, programming of change, homework assignments, and the cultivation of attitudes and beliefs that encourage assertive behavior. The more outstanding the behavior deficits and need for behavior refinement, the more likely that instructions, model presentation, and rehearsal will be required. Intervention may also include efforts to replace negative thoughts with positive self-instructions. Homework assignments are a component of assertion training, and client-recorded logs can be reviewed to offer feedback and to encourage use of effective skills. Careful assessment is required to identify skills needed and relevant situations, to determine whether there are discrimination problems in relation to when certain behaviors can most profitably be used, to identify unrealistic beliefs or expectations that may interfere with assertive behavior, and to determine whether negative self-statements or lack of effective self-management skills interfere with effective behavior. Sources of assessment data include the interview, self-report measures such as the Assertion Inventory, role-playing, and observation in the natural environment.

Research to date indicates that assertion training is effective in helping clients achieve a variety of valued

outcomes in real-life settings. Assertion training is usually individually focused. It thus may not redress political, social, and economic inequities that impede change. Planning for generalization and maintenance will be required to increase the likelihood that desired behaviors will occur in relevant situations and will be maintained. Has the term “assertive behavior” outlived its usefulness? As a term connoting a traitlike approach to behavior, it has. As a term that is sometimes confused with aggressive reactions, it has not been helpful. As a term that highlights our potential for influencing our social environments, it has been helpful.

See Also the Following Articles

Anger Control Therapy ■ Avoidance Training ■
 Bibliotherapy ■ Communication Skills Training ■
 Discrimination Training ■ Heterosocial Skills Training ■
 Homework

Further Reading

- Alberti, R. E., & Emmons, M. L. (2001). *Your perfect right: Assertiveness and equality in your life and relationships* (8th ed.). San Luis Obispo, CA: Impact.
- Assertion Inventory (2001). In K. Corcoran & J. Fischer (Eds.), *Measures for Clinical Practice: A sourcebook* (3rd ed.) Vol. 2: *Adults* (pp. 64–65). New York: Free Press.
- Eisler, R. M., Hersen, M., & Miller, P. M. (1974). Shaping Components of Assertive Behavior with Instructions and Feedback. *American Journal of Psychiatry*, *131*, 1344–1347.
- Gambrill, E. (1995). *Assertion training*. In W. O'Donohue & L. Krasner (Eds.), *Handbook of psychological skills training: Clinical techniques and application* (pp. 81–118). Boston: Allyn & Bacon.
- Meichenbaum, D. (1971). Examination of model characteristics in reducing avoidance behavior. *Journal of Personality and Social Psychology*, *17*, 298–307.
- Rakos, R. F. (1991). *Assertive behavior: Theory, research and training*. New York: Routledge.
- Wolpe, J. (1973). *The practice of behavior therapy*. New York: Pergamon.

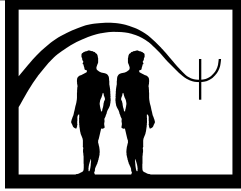

Assisted Covert Sensitization

Joseph J. Plaud

Cambridge Center for Behavioral Studies, New School for the Learning Sciences, and Brown University

- I. Description of Treatment
 - II. Theoretical Basis
 - III. Empirical Studies
 - IV. Clinical Case Study
 - V. Summary
- Further Reading

GLOSSARY

assisted covert sensitization A behavioral strategy in which standardized scripts are employed to guide the client through clinically relevant scenarios in which ultimately aversive imaginal consequences are presented.

covert conditioning A family of behavior therapy procedures which combine the use of imagery with the principles of operant conditioning.

I. DESCRIPTION OF TREATMENT

Covert sensitization represents one of the major psychotherapeutic, behavioral techniques to be applied to the remediation of sexual deviations. Techniques such as covert sensitization, olfactory aversion, and faradic or electrical aversion therapy have in common the clinical goal of reducing sexual arousal to deviant stimuli through the introduction of aversive events. Covert sensitization is a form of conditioning therapy in which a behavior and its precipitative events are paired with some aversive stimulus in order to promote avoidance

of the precipitative events and thereby to decrease the undesirable behaviors. In 1990, the originator of the procedure, Joseph Cautela and A. J. Kearney defined the conditioning procedure as follows:

Covert conditioning refers to a family of behavioral therapy procedures which combine the use of imagery with the principles of operant conditioning. Covert conditioning is a process through which private events such as thoughts, images, and feelings are manipulated in accordance with principles of learning, usually operant conditioning, to bring about changes in overt behavior, covert psychological behavior (i.e. thoughts, images, feelings) and/or physiological behavior (e.g. glandular secretions).

In covert sensitization, the aversive stimulus usually consists of an anxiety-inducing or nausea-inducing image that may be presented verbally by the therapist or imagined by the client. The aversive scene is individually created, and is specific to each client's problem behavior. Covert sensitization has frequently been successfully employed by itself (as described by Brownwell and Barlow in 1976; Curtis and Presley in 1972; Dougher, Crossen, Ferraro, and Garland in 1987; Haydn-Smith, Marks, Buchaya, and Repper in 1987; Hayes, Brownwell, and Barlow in 1978; Hughes in 1977; King in 1990; McNally and Lukach in 1991; and Maletzky and George in 1973) as well as in combination with other techniques (as discussed by Kendrick and McCullough in 1972; Moergen, Merkel, and Brown in 1990; Rangaswamy in

1987; and Stava, Levin, and Schwanz in 1993) in the treatment of sexual deviance.

Assisted covert sensitization is a basic variant of the covert sensitization procedure in which standardized scripts are employed to guide the client through clinically relevant scenarios in which ultimately aversive imaginal consequences are presented. A study conducted by Plaud and Gaither in 1997 illustrates the clinical methodology used in assisted covert sensitization, and will now serve as a case illustration of the use of assisted covert sensitization in the treatment of a paraphilia.

II. THEORETICAL BASIS

The principles of learning and behavior have been integrated into many of the most commonly employed therapy techniques in use today with sexual deviations, or the paraphilias, as discussed by Gaither, Rozenkranz, and Plaud in 1998. Abel and Blanchard in 1976 stated 25 years ago that "The problem of deviant sexual behavior was one of the earliest areas of psychopathology to which behavioral techniques were applied, and it continues to be a major area of research and treatment." The earliest behavioral theories of sexual deviations were based on a classical conditioning paradigm. Theorists such as Binet in 1888, Jaspers in 1963, and Rachman in 1961 believed that these deviations were the result of accidental pairings between stimuli that naturally elicited sexual arousal and originally neutral stimuli. According to Jaspers in 1963, "Perversion rises through the accidents of our first experience. Gratification remains tied to the form and object once experienced, but this does not happen simply through the force of simultaneous association with that former experience."

Why some individuals choose to incorporate deviant stimuli into their masturbatory fantasies is also explained using a conditioning hypothesis. One factor is the stimulus value of "deviant" stimuli, which is continually strengthened through the pairing of these stimuli with ejaculation. According to a conditioning model, nondeviant stimuli or fantasies, at the same time, undergo extinction (a decrement in responding) as a result of their lack of pairing with ejaculation. Another contributing factor is a common belief held by sexual deviants that a normal sex life is not possible. This belief, according to McGuire and colleagues in 1965, may develop from a number of different sources including aversive adult heterosexual experiences, or feelings of physical or sexual inadequacy. These re-

searchers found that in 45 cases, all of the patients held this belief before their first deviant sexual encounter. This leads one to the conclusion that the belief (a covert behavior) may play a precipitating role in the development of sexual deviations (overt behaviors) rather than being an effect of the deviation.

Sexual deviations may be best understood through a combination of classical and operant conditioning processes, according to O'Donohue and Plaud in 1994, and Plaud and Martini in 1999. Deviant sexual behavior begins with an accidental pairing of an "abnormal" or deviant stimulus with sexual arousal and/or ejaculation, giving this stimulus a high amount of erotic value. Thus, through a classical conditioning process, the deviant stimulus begins to elicit sexual arousal. The deviant stimulus is then incorporated into sexual fantasies during masturbation, which is reinforced by ejaculation. Thus, ejaculation serves as a reinforcer for the covert behavior of deviant fantasizing.

III. EMPIRICAL STUDIES

McGuire and colleagues in 1965 discussed the implications of their hypothesis for the treatment of sexual deviations. First, the authors stated that "since the original conditioning was carried out in most cases to fantasy alone, treatment also need only be to fantasy." Thus, in the treatment of deviations such as pedophilia, it is not necessary to present the subject with children, but only with fantasies involving children. Another implication of this hypothesis is that therapists can warn their patients of the conditioning effects of orgasm on the immediately preceding fantasy. Finally, according to McGuire and colleagues, "positive conditioning to normal heterosexual stimuli can follow the same lines as it is deduced that the deviation followed."

A study conducted by Lamontagne and Lesage in 1986 nicely illustrates the use of covert sensitization in the treatment of exhibitionism. The subject in this study was a 37-year-old male who had been exposing himself several times per week. The treatment consisted of covert sensitization techniques and allowing the client to privately expose himself at home with his wife. Before treatment, this client had fantasized about exhibitionism approximately 60% of the time during masturbation, and 30% of the time during sexual intercourse with his wife. In the covert sensitization sessions, the subject imagined exposing himself to a woman who would then angrily scold him. As another part of the aversive image, he imagined losing his wife

because of the exhibitionism. Thus, the deviant fantasy was paired with two powerfully aversive images. In combination with the covert sensitization procedures, the client was allowed to expose himself two times per week at home with his wife. This private exposure was always followed by either masturbation or sexual intercourse without deviant fantasies. Also, the client was instructed not to masturbate unless his wife was present, so that nondeviant sexual fantasy and behavior could be promoted. A posttreatment follow-up indicated that the subject had not publicly exposed himself for 2 years. It would seem that the treatment rendered the exhibitionism appropriate, and even socially acceptable, since it occurred in the privacy of the home. Interestingly, the couple even reported that their sex life improved following treatment.

The underlying theory of this treatment approach is probably best thought of as a combination of classical and operant conditioning processes. The therapist works with a client to develop an aversive image that will be paired with the precipitative events, and with the image of the deviant behavior itself, according to a classical conditioning paradigm. The aversive image serves as the unconditioned stimulus (UCS). The images of the precipitative events, being continually paired with the UCS, become the conditioned stimulus (CS). Both the conditioned response (CR) and the unconditioned response (UCR) consist of a negative reaction that may be emotional (e.g., fear), physiological (e.g., nausea), or in some other way repulsive. Once the client's deviant behavior has been classically conditioned, the client should begin to actively avoid or escape the situations associated with the deviant behavior. The precipitative events, as well as the behavior itself, should elicit a negative reaction, and thus be aversive.

According to the principles of operant conditioning, and specifically of negative reinforcement, the client should behave in ways that would minimize contact with the aversive stimulus, in this case the precipitative events and the deviant behavior. If the client does pursue the deviant behavior further, hopefully the treatments will have at least reduced the effectiveness of the reinforcement for the deviant behavior, which should lead to a lower frequency of the behavior. It would also be possible for classical conditioning to work alone, if the CR was so powerful that it rendered the person unable to engage in the deviant behavior, or consisted of a response that was incompatible with the deviant behavior. For example, if the CR was extreme anxiety or fear, and the deviant behavior required an erect penis, it may be the case that the CR would preclude the possibility

of erection, and thereby preclude the occurrence of the deviant behavior.

Lamontagne and Lesage in 1986 combined classical conditioning and operant conditioning in their covert sensitization treatment approach. Another important part of their treatment consisted of the operant reinforcement of private exposure through orgasm from masturbation or intercourse, both of which took place with the client's wife. Essentially, only the context of the exhibition behavior changed, not the behavior itself. The client learned that the behavior would be reinforced in one situation (at home with his wife), while it would either be extinguished or punished in any other situations.

IV. CLINICAL CASE STUDY

The client in this case study of the use of assisted covert sensitization was a 24-year-old male. The client was originally referred for a penile plethysmographic evaluation by a local human service center psychologist in relation to a show cause hearing for his failure to progress in group treatment at the human service center, which ultimately led to his termination from the group. The group treatment focused on psychoeducational issues relating to human sexuality, consent and victim empathy issues, appropriate and inappropriate sexual behavior, and disclosure to other members of the group. The client chose not to participate actively in any phase of the group treatment. The client had an extensive history of sexually abusive behavior. He earlier pled guilty to a charge of sexual assault, and was serving probation at the time of the initiation of therapy services. According to police records, when he was 19 years old the client engaged in sexual activities with a 15-year-old male. The victim reported that the client attempted anal intercourse on approximately 15 occasions. It was reported that the client ejaculated on a "couple" occasions, although there was no notation of anal penetration, oral sexual contact, or masturbation. The victim also reported on several of these sexual encounters that the client would gain compliance by the victim through purchasing soft drinks, and that consent by the victim to sexual interactions was verbally coerced by the client. The client denied engaging in anal intercourse and verbally coercive activities, and indicated that the victim engaged in sexual activities, including masturbation, in a mutual fashion.

The client's penile responses during the course of therapy were recorded by a penile plethysmograph utilizing a Type A mercury-in-rubber penile strain gauge.

During the original assessment of the client's sexual preferences, penile tumescence was continually monitored as he listened to sexually explicit audiotapes. A total of 18 standard audio scripts were presented during the initial assessment. These were descriptions of two adult homosexual interactions, two adult heterosexual interactions, two acts of adult female exhibitionism, two adult female rapes, one male child physical aggression, one female child physical aggression, one male child nonphysical coercion, one female child nonphysical coercion, three male child fondling, and three female child fondling. The client's subjective reports of sexual arousal were assessed by having him rate how aroused he felt using a 10-point Likert scale (0 = not at all aroused, 9 = extremely aroused).

Results of this assessment component before initiating assisted covert sensitization indicated that the client was aroused by adult females; however, he also displayed an active pattern of arousal toward stimuli depicting sexual activities with a male child, specifically anal intercourse. Based on these data, three "deviant" categories that elicited the greatest levels of sexual arousal—fondling a male child (MPF), coercing a female child into sexual activity (FPC), and fondling a female child (FPF)—were noted, and a follow-up recommendation was made for the client to participate in eight sessions of assisted covert sensitization in addition to being readmitted to group treatment at the local human service center.

Shortly after the initial assessment was conducted, an assisted covert sensitization protocol was begun. The client was given a consent form and full explanation of the procedure, and all questions were answered concerning the procedure. The initial assisted covert sensitization session was scheduled for the following week. During the week, audiotapes were developed for treatment. These tapes contained 3-minute descriptions of a deviant sexual activity (MPF, FPC, or FPF) followed by a description of a possible negative (aversive) consequence for this type of activity. The consequences were either legal (e.g., being beaten up by the father of the child and then being arrested) or physiological (e.g., feeling very nauseous and vomiting) in nature. The development and implementation of these guided scripts represents the "assisted" component in assisted covert sensitization.

When the client arrived for the first session, an abbreviated assessment was conducted to obtain baseline measurements of his sexual arousal to MPF, FPC, and FPF stimuli, as well as mutually consenting heterosexual (FAD), and mutually consenting homosexual (MAD) activity.

Following a 10-minute break the treatment was initiated, involving the presentation of 10 MPF stimuli described earlier. At the end of the session, the client was given a copy of the tape and instructed to listen to and visualize the sexual activity as well as the aversive consequences being delivered five times per day. The remaining five sessions were conducted at 1-week intervals apart beginning with Session 1.

During Session 2, the client was presented with the same 10 MPF stimuli from the previous session, and again instructed to listen to the tape five times per day until the next session. In Sessions 3 and 4, the same procedures were followed with the exception that MPF stimuli were presented only two times and FPC stimuli were presented the other times. The client was again provided with a copy of the new tape and instructed to listen to it five times per day between sessions (with explicit instructions to visualize the stimuli being presented). In Sessions 5 and 6 FPF stimuli were presented six times, MPF two times, and FPC two times each.

After completion of Session 6, the client returned to the clinic for a 30-day follow-up assessment. The same stimuli from the baseline assessment were used to determine present patterns of sexual arousal. The same procedure was again followed 3 months later in a final follow-up assessment.

The client's physiological data for the initial assessment, pretreatment assessment, 30-day follow-up, and 90-day follow-up were calculated and converted to percentages of full erection. This was computed by subtracting his minimum penile circumference for an entire session (e.g., assessment period) from his maximum penile circumference for each trial (the presentation of one audiotaped stimulus represents a trial) and dividing this number by 3. Three centimeters is thought to reflect the circumference change most males undergo from flaccidity (no sexual arousal) to complete engorgement (maximum sexual arousal). This number was then multiplied by 100 to give a percentage of full erection. Thus, percentage of full erection data give an indication of absolute levels of arousal. In other words, the client's response to each stimulus is viewed in this manner independently of the other stimuli presented in the session. It was found that the stimuli elicited less arousal each time the client was assessed during the assisted covert sensitization procedure.

The client's physiological data for the assessments were next converted to standardized scores (z-scores). Z-scores form a distribution in which the mean of the

distribution equals zero (0) and the standard deviation is 1.0. Using this scoring method, the client's sexual preferences are expressed as positive z-scores, while negative z-scores reflect sexual aversions. The greater that a score falls from zero, the stronger the preference or aversion. Thus, a score of +2.0 indicates a greater preference than a +1.2, while a score of -2.0 indicates a greater repulsion than a score of -1.2. Z-scores, then, give an indication of relative arousal or preferences and aversions among a group of stimuli. It was found that in the initial assessment, four of the five categories including the three that were treated, were positive and above 0.50. Looking across the assessments for each of the deviant categories, it was clear that the client's arousal to these decreased across time, although his arousal to adult mutually consenting sexual activity (FAD) indicated that this was clearly his most preferred stimulus in all assessments except for the 30-day follow-up, in which mutually consenting heterosexual activity (MAD) was the most preferred stimulus.

The client's self-report of sexual arousal using the 10-point Likert scale (0 = not at all aroused, 9 = extremely aroused) for each category of stimulus across the four assessments, yields an indication of an individual's subjective experience of arousal, which is not always perfectly related to his physiological responding. Once again, it was found that FAD stimuli elicited the greatest levels of arousal, whereas all others dropped off to 0.

The client clearly showed clinical progress in both his physiological and self-report of arousal toward sexually deviant stimuli that were the main areas of concern, using the assisted covert sensitization procedure. Recall that the underlying behavior principle of covert sensitization is most often theorized to be a combination of classical and operant conditioning, as described earlier. Given decrements in physiological arousal and self-report normally observed in covert sensitization procedures, such as in the present case study, it is logical to conclude that the aversive image associated with deviant sexual arousal (the UCS) becomes a CS by virtue of its being contingently paired with the UCS (classical conditioning). Also, it is logical and theoretically coherent to conclude that both the conditioned response (CR) and the unconditioned response (UCR) consist of a negative reaction that may be emotional (e.g., fear), physiological (e.g., nausea), or in some other way repulsive, which further serves to negatively reinforce avoidance or escape behavior (operant conditioning).

V. SUMMARY

Assisted covert sensitization represents an empirically validated approach to treating sexually deviant behavior patterns, focusing on both the covert and overt behavioral manifestations of inappropriate sexual arousal patterns, and therefore assisted covert sensitization is a main line behavior therapy technique in the treatment of sexual offenders.

See Also the Following Articles

Coverant Control ■ Covert Positive Reinforcement ■ Covert Reinforcer Sampling ■ Orgasmic Reconditioning ■ Self-Control Desensitization ■ Sex Therapy ■ Systematic Desensitization

Further Reading

- Abel, G. G., & Blanchard, E. B. (1976). The measurement and generation of sexual arousal in male sexual deviates. In M. Hersen, R. Eisler, & R. M. Miller (Eds.), *Progress in Behavior Modification*, Vol. 2 (pp. 99-133). New York: Academic Press.
- Binet, A. (1888). *Le fétichisme dans l'amour*. Paris. Doin, ed.
- Brownwell, K. D., & Barlow, D. H. (1976). Measurement and treatment of two sexual deviations in one person. *Journal of Behavior Therapy and Experimental Psychiatry*, 7, 349-354.
- Cautela, J. R., & Kearney, A. J. (1990). Behavior analysis, cognitive therapy and covert conditioning. *Journal of Behavior Therapy and Experimental Psychiatry*, 21, 83-90.
- Curtis, R. H., & Presley, A. S. (1972). The extinction of homosexual behaviour by covert sensitization: A case study. *Behavior Research and Therapy*, 10, 81-83.
- Dougher, M. J., Crossen, J. R., Ferraro, D. P., & Garland, R. (1987). The effects of covert sensitization on preference for sexual stimuli. *Journal of Behavior Therapy and Experimental Psychiatry*, 18, 337-348.
- Gaither, G. A., Rosenkranz, R. R., & Plaud, J. J. (1998). Sexual disorders. In J. J. Plaud & G. H. Eifert (Eds.), *From behavior theory to behavior therapy* (pp. 152-171). Boston: Allyn & Bacon.
- Haydn-Smith, P., Marks, I., Buchaya, H., & Repper, D. (1987). Behavioral treatment of life threatening masochistic asphyxiation: A case study. *British Journal of Psychiatry*, 150, 518-519.
- Hayes, S. C., Brownwell, K. D., & Barlow, D. H. (1978). The use of self-administered covert sensitization in the treatment of exhibitionism and sadism. *Behavior Therapy*, 9, 283-289.
- Hughes, R. C. (1977). Covert sensitization treatment of exhibitionism. *Journal of Behavior Therapy and Experimental Psychiatry*, 8, 177-179.
- Jaspers, K. (1963). *General psychopathology*. Manchester, England: Manchester University Press.

- Kendrick, S. R., & McCullough, J. P. (1972). Sequential phases of covert reinforcement and covert sensitization in the treatment of homosexuality. *Journal of Behavior Therapy and Experimental Psychiatry*, 3, 229–213.
- King, M. B. (1990). Sneezing as a fetishistic stimulus. *Sexual and Marital Therapy*, 5, 69–72.
- Lamontagne, Y., & Lesage, A. (1986). Private exposure and covert sensitization in the treatment of exhibitionism. *Journal of Behavior Therapy and Experimental Psychiatry*, 17, 197–201.
- Maletzky, B. M., & George, F. S. (1973). The treatment of homosexuality by 'assisted' covert sensitization. *Behavior Research and Therapy*, 11, 655–657.
- McGuire, R. J., Carlisle, J. M., & Young, B. G. (1965). Sexual deviation as conditioned behavior. *Behavior Research and Therapy*, 2, 185–190.
- McNally, R. J., & Lukach, B. M. (1991). Behavioral treatment of zoophilic exhibitionism. *Journal of Behavior Therapy and Experimental Psychiatry*, 22, 281–284.
- Moergen, S. A., Merkel, W. T., & Brown, S. (1990). The use of covert sensitization and social skills training in the treatment of an obscene telephone caller. *Journal of Behavior Therapy and Experimental Psychiatry*, 21, 269–275.
- O'Donohue, W. T., & Plaud, J. J. (1994). The conditioning of human sexual arousal. *Archives of Sexual Behavior*, 23, 321–344.
- Plaud, J. J., & Gaither, G. A. (1997). A clinical investigation of the possible effects of long-term habituation of sexual arousal in assisted covert sensitization. *Journal of Behavior Therapy and Experimental Psychiatry*, 28, 281–290.
- Plaud, J. J., & Martini, J. R. (1999). The respondent conditioning of male sexual arousal. *Behavior Modification*, 23, 254–268.
- Rachman, S. (1961). Sexual disorders and behavior therapy. *American Journal of Psychiatry*, 118, 235–240.
- Rangaswamy, K. (1987). Treatment of voyeurism by behavior therapy. *Child Psychiatry Quarterly*, 20, 73–76.
- Stava, L., Levin, S. M., & Schwanz, C. (1993). The role of aversion in covert sensitization treatment of pedophilia: A case report. *Journal of Child Sexual Abuse*, 2, 1–13.

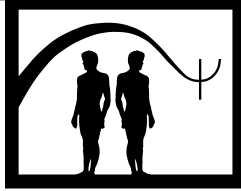

Attention Training Procedures

Alice Medalia

Albert Einstein College of Medicine

- I. Description of Treatment
 - II. Theoretical Bases
 - III. Empirical Studies
 - IV. Summary
- Further Reading

Attention training refers to the procedures used to improve attention deficits as they impact on cognitive and social aspects of functioning. This article reviews the various training techniques that are used, the conceptual underpinnings of the treatment procedures, and studies of treatment efficacy.

GLOSSARY

- anhedonia** A psychological condition evidenced as an inability to experience pleasure in activities that normally produce it.
- avolition** Lack of intent or will to perform activities.
- contextualization** Placing the learning exercise in a context so that the practical utility and link to everyday interests and activities are obvious to the learner.
- errorless learning** The elimination of trial and error approaches to learning by beginning with easily mastered exercises and slowly increasing the difficulty level.
- generalization** The transfer of a learned skill or behavior to other situations besides the one where the training occurred.
- intrinsic motivation** The motivation to do an activity because performance of that activity is in and of itself rewarding. Contrasts to extrinsic motivation, which occurs when there are external rewards for performing an action.
- reaction time** Time taken to respond to an auditory, visual, or proprioceptive stimulus.
- shaping** Process of systematically reinforcing an individual for demonstrating behaviors that increasingly approximate a target behavior.

I. DESCRIPTION OF TREATMENT

Remediation of attentional impairments is approached with different techniques depending on the aspect of attention that requires improvement, and the specific characteristics of the population being treated. The actual process of remediating attention typically includes various exercises that are done in a controlled treatment setting with the ultimate goal of increasing attention performance in everyday life. Before treatment begins, assessment of the particular needs of the patient is done. This assessment forms the basis for a treatment plan, and also can serve as a baseline measure in studies of treatment effectiveness.

A. Assessment

The assessment includes a thorough history that helps to identify the etiology of the attention problems. Medical and psychiatric history identifies conditions known to affect attention and other cognitive functions, and establishes the extent to which attention problems are

state (episode) versus trait (interepisode) related. Current medications and other treatments are reviewed with note made of how they are tolerated by the individual. Medication and electroconvulsive therapy (ECT) induced attention impairment is treated by titrating the dose, or changing drug class to minimize cognitively toxic effects. Assessment also includes educational and occupational history to identify baseline/premorbid functioning. Current functioning is reviewed with an emphasis on identifying how attentional impairments are evidenced in everyday life. Ability to attend during therapeutic activities, at school, in work, and in social situations is evaluated. Some formal testing of attention is done to provide objective data on how the patient's attention compares to a normative group. This testing includes measures of different aspects of attention such as ability to encode, focus, and sustain attention. Some of the commonly used tests are Digit Span, Coding, Cancellation Tests, Continuous Performance Test (CPT), as well as others. Ability to stay on task in therapeutic or vocational activities may be quantified as time on task or rated with scales. Some assessment of differences in ability to attend to auditory versus visual stimuli can be done.

Learning style is discussed as a way of increasing and assessing patient awareness of cognitive strengths and weaknesses. Patient awareness of attention deficit and how it impacts on their functioning is assessed, as is motivation for treatment and attitude about learning. Ultimately, this assessment identifies how attention processes are functioning relative to those of an age (and education) matched group, possible etiologies for the impairment, areas to focus on in attention remediation, and treatment techniques most suited to the learning style and needs of the patient. The assessment, inasmuch as it is done in one of the first meetings with the cognitive remediation staff, should also serve to engage the patient in treatment. As in any first therapeutic encounter, the cognitive remediation assessment not only assesses but also lays the groundwork for a productive therapeutic collaboration between the patient and the provider.

B. Treatment Plan

A treatment plan in cognitive remediation delineates the overall goal, the specific objectives, and the interventions. For example, the overall goal may be to improve ability to focus and sustain attention. The specific objectives may be to increase ability to stay on task from 15 minutes to 45 minutes, or to improve performance on the CPT. Specific objectives include some measures of test performance and some functional

measures to show that the attention training has generalized outside the remediation setting. The interventions indicate the actual attention training procedures to be used and the person who will be doing them.

C. Treatment Interventions

1. Computer-Based

There are several computerized attention training exercises that have been developed for head-injured patients and these have also been used with psychiatric populations. The Orientation Remedial Module (ORM) is a program developed at NYU Rusk Institute that has a number of attention training exercises and a reaction time test that can be administered before and after each training session. The tasks are intended to improve arousal, alertness, rapid and well-modulated responsiveness, scanning, target detection, and rapid processing of simple information. There are five modules (attention reaction conditioner, zeroing accuracy conditioner, visual discrimination conditioner, time estimates, and rhythm synchrony conditioner) that involve receiving auditory and visual stimuli and eliciting a series of simple visual-motor responses. Progression through one module builds skills necessary for subsequent modules. The tasks are somewhat engaging and feedback is provided to the patients about their performance.

Captain's Log software, available through BrainTrain, and the training exercises developed by Bracey are examples of other computer-based cognitive training packages that include tasks intended to improve auditory and visual attention. There are a number of software exercises available through different vendors, all designed to improve attention, in head-injured or ADHD populations. Although there is no software designed specifically for use by psychiatric populations, some success has been reported in the application of the exercises to this patient group. Psychiatric patients often have severe motivational problems that can affect response to any treatment. Characteristics of software that are best suited to populations with motivational problems include engaging presentation of material, options for personalizing and controlling aspects of the task, frequent feedback, and placing the activity in appealing, relevant contexts. Educational software, developed for use in primary and secondary curriculums, is frequently designed with these features, and some include exercises to improve attention and memory.

Computer-based software exercises are intended to be worked on by individuals, but it is possible to have several individuals working simultaneously at separate computer stations. Depending on the patient profiles,

one therapist typically works with one to four clients. The therapist monitors and facilitates productive engagement in the activity and guides the patient to appropriate exercises.

2. Noncomputer-Based

Attention is sometimes the focus of group exercises done within the context of psychiatric rehabilitation. These exercises are rarely as purely cognitive as those done on the computer and are often done in conjunction with the computer exercises to facilitate generalization to an ecologically meaningful context. For example, Integrated Psychological Therapy (IPT) is a highly structured group therapy approach that includes five subprograms, three of which are devoted to development of those cognitive abilities thought to be the prerequisite for effective social interaction. Attention is the focus of a few of these IPT exercises; for example, one task requires verbatim repetition and paraphrasing of what another group member said. A wide variety of other group exercises that target attention can be accessed through occupational therapy manuals. For example, a group exercise to tone visual scanning and vigilance may involve a version of I Spy, whereby patients search a highly intricate picture for target objects.

For those clients who are so severely attentionally impaired that they are unable to tolerate group formats, behavioral techniques such as shaping can be integrated into the skills training. Shaping refers to the systematic reinforcement of behaviors that increasingly approximate a target behavior. When the goal is to enhance social attention, the behaviors that indicate attentiveness, such as keeping eyes open or looking at the speaker, can be reinforced. Shaping techniques can be used to enhance social aspects of attention or to develop attention in nonsocial contexts such as target detection.

Other noncomputer-based attention tasks can be done individually or in a group with each patient working on his or her own exercises. Some exercises are actually versions of attention tests that are instead used to train performance. For example, cancellation tasks that require the patient to scan a paper and mark all the target stimuli, and coding tasks that are similar to Digit Symbol, can be used as a remediation or assessment tool. These exercises are best used in conjunction with other tasks since there is a disadvantage associated with exclusive use of outcome measures as a remediation tool. Generalization of skill is promoted when target behaviors are paired with multiple cues in multiple contexts, something that does not happen when the outcome measure is the only remediation tool used.

3. Holistic versus Targeted Treatment Approaches

Attention training is typically done in the context of a comprehensive treatment program. Whereas a targeted approach would focus on the purely cognitive, nonsocial aspects of attention, a holistic approach addresses both the cognitive and social aspects of attention. Issues of awareness, self-esteem, and learning style are appreciated as having a potential impact on cognition, and they are therefore addressed in the remediation sessions.

4. Intensity and Duration of Treatment

There are no conclusive data to provide guidelines on these treatment parameters. Many studies of treatment efficacy used a model of three sessions per week. There is considerable variability in the duration of treatment. The more comprehensive programs, which target several cognitive functions in addition to psychosocial skills, typically involve 6 to 12 months. More focused programs, which target nonsocial aspects of cognition, typically involve 10 to 24 sessions. The length of each treatment session may vary from 30 to 60 minutes.

II. THEORETICAL BASES

Impairment in attention is a common symptom of severe psychiatric illness. Patients with schizophrenia perform poorly on tasks that require vigilance, quick responses, or sustained attention. Because these deficits are evident during and between episodes of active psychosis and have been noted in individuals at risk for schizophrenia, they are considered to be trait or vulnerability markers of the disease. Patients with bipolar and unipolar depression, especially if the illness is treatment refractory or has accompanying psychotic features, also have severe problems with attention. Attention has several aspects, and it is possible for some elements of attention to remain intact while others are deficient. For example, the ability to encode information, which can be measured by Digit Span, is differentiated from the ability to sustain attention and maintain readiness to respond to a signal. Tasks such as the CPT measure vigilance or ability to sustain attention, ability to be ready to respond to a target, and not to respond to noise or nontargets.

Impairments in attention have been associated with functional outcome in psychiatric patients. In schizophrenia, impaired encoding and vigilance has consistently been associated with poor social problem solving and difficulty benefitting from rehabilitation

services. Psychosocial skills training is a form of rehabilitation that is widely available for people with persistent psychiatric illness, and it is intended to teach basic life skills such as social interacting, illness management, independent living, and leisure skills. The patients with schizophrenia who have more severe attentional problems are least likely to acquire skills in these programs. The attentional problems make it difficult for them to process the information given in groups, and they may not be able to sustain attention for the duration of the sessions.

Medication does not have a major impact on attention in schizophrenia. There appears to be a positive impact on the gross attentional problems associated with acute psychotic decompensation but the enduring attentional problems that are seen throughout the course of the illness are surprisingly resistant to medication. In the affective disorders, medication can significantly reduce attention problems if attentional deficits are state related and the illness responds to psychopharmacologic intervention. In the treatment refractory patients, attentional problems tend to persist. Furthermore, some medications, such as lithium, can impair attention. Many medications, if not in the therapeutic range, or if idiosyncratically tolerated, can cause attention impairment.

Because attentional problems are so prevalent in the psychiatric disorders, often so unresponsive to pharmacological intervention, and because they are associated with outcome and ability to benefit from treatment, they are targeted for remediation. This remediation is typically done within the context of rehabilitation programs, serving people who have persistent psychiatric illness. As acute care has become increasingly triage oriented, remediation of cognitive deficits is more likely found in outpatient settings or long-term inpatient facilities. Major influences on the development of attention remediation models in psychiatry come from neuropsychology, behavioral learning theory, educational theory, and rehabilitation psychology.

A. Neuropsychology and Attention Remediation

Neuropsychology, and the related field of cognitive psychology, have made major contributions to our understanding of the attentional system, at the levels of both cognitive operations and neuronal activity. The attention system is believed to be composed of subsystems that perform different but interrelated cognitive functions. These different subsystems are mediated by

different anatomic areas that together work as a network. Neuropsychology has emphasized the importance of studying the cognitive origins of psychiatric disorders. From this perspective, the disorders in attention and information processing are seen as critical links in the causal chain leading to formation of schizophrenic symptoms. Attention impairments are not necessarily seen as directly causal in symptom formation but rather as a vulnerability factor that when coupled with other vulnerability factors and stresses, contribute to the onset of psychosis. Sometimes these attention deficits are referred to as nonsocial cognitive deficits, inasmuch as they refer to pure cognitive functioning, or the basic cognitive processes that operate regardless of environmental context. The profile of attention impairment informs the intervention strategy. Those deficits that are vulnerability factors or that limit functional outcome are considered the important ones to target for intervention.

Attention remediation has long been the focus of treatment in programs for the head injured and many remediation exercises have been developed to improve attention in the head injured. These exercises show the influence of neuropsychological models of attention in their singular focus on specific nonsocial aspects of attention. The ability to focus, encode, rapidly process and respond, maintain vigilance, and avoid distraction from competing stimuli, are all aspects of attention that may be isolated for remediation in these exercises. Often these exercises are computerized to facilitate standardization of presentation, precise measurement of response, and frequent feedback. Because nonsocial aspects of attention have been identified as vulnerability factors in schizophrenia, the exercises are considered relevant in psychiatric rehabilitation as well.

Given the ultimate goal of improving attention in real-life contexts it is important that the gains made on laboratory tasks of attention generalize outside the remediation setting. For this to happen there must be an appreciation of how skills are best learned and what factors influence recovery. It is in this regard that learning and educational theory, and rehabilitation psychology have had the most influence.

B. Learning Theory and Attention Remediation

The use of techniques such as shaping, errorless learning, and frequent positive feedback show the influence of behavioral and learning theory. Errorless learning refers to the careful titration of difficulty level

so that the patient learns without resorting to trial and error, and has a positive experience with increasing challenge. Shaping and positive feedback are integral components of the social learning approach of Paul and Lentz, and have been used extensively to decrease maladaptive behaviors in the chronic, highly regressed psychiatric patient. Although Paul's social learning approach was not developed for use with cognitively impaired individuals, methods such as shaping and positive reinforcement have since been found effective for treating attention impairment. Learning theory has also indicated some of the factors that promote generalization of skill. Within the remediation exercises, target behaviors need to be paired with multiple cues, ideally in various contexts, so that the behavior will be elicited in multiple settings. In attention training this occurs when the focus/execute response is paired with auditory, visual, and social cues in a variety of tasks. Patients who do multiple tasks that exercise the ability to focus and quickly execute a response are more likely to improve than those whose training is limited to repetitive execution of one task.

C. Educational Psychology and Attention Remediation

Apathy, anhedonia, and avolition are frequent symptoms in the severely mentally ill, and these motivational problems compromise engagement in treatment. Educational psychology has shown that engagement in a learning activity is most likely to occur when the person is intrinsically motivated, that is, when the person finds the learning experience compelling and not when the person is compelled by external forces to do it. Intrinsic motivation and task engagement occur when the tasks are contextualized, personalized, and allow for learner control. Contextualization means that rather than presenting material in the abstract it is put in a context whereby the practical utility and link to everyday life activities are obvious to the student. In attention remediation, a decontextualized focusing task would require the person to press a button every time a red square appeared on the otherwise blank computer screen. A contextualized focusing task would require the person to assume the role of pedestrian in a task that simulated the experience of responding to crosswalk signals. Personalization refers to the tailoring of a learning activity to coincide with topics of high interest value for the student. Learner control refers to the provision of choices within the learning activity, in order to foster self-determination. In attention training, this

occurs when the patient can choose task features such as difficulty level or presence of additional auditory cues when doing a visual vigilance exercise. Intrinsic motivation, depth of engagement in the task, amount learned, and self-efficacy can all be increased when task design incorporates educational principles.

D. Rehabilitation Psychology and Attention Remediation

Rehabilitation psychology emphasizes an integrated approach to the patient that appreciates the complex interaction of cognitive, emotional, and environmental variables in the recovery process. From this perspective, attention deficits are not seen simply as a manifestation of neuropsychological dysfunction, but rather social-cognitive dysfunction. Rehabilitation psychology favors a more interactive, learning process approach to attention remediation over the formal didactic exercises used in a purely cognition-oriented program. This allows for the social and emotional as well as the cognitive needs of the patient to be addressed and promotes a smooth interplay of cognitive and emotional variables in everyday functioning.

E. Rationale for Computer-Assisted Exercises

Computer-based technology is used in attention training because it is possible to give frequent and consistent feedback, there are opportunities for positive reinforcement, the learning experience can be individualized and personalized, there are opportunities for giving control over the learning process, difficulty levels can be individualized so that the task is challenging but not frustrating, and the student can be given ample opportunity to apply the targeted skill in contextualized formats. The computer itself simply provides the overall learning platform; the software provides the learning tools. The design of the software program and whether or not it incorporates basic educational principles, largely dictates whether the remediation experience will be frustrating or engaging. Computer exercises exert a remedial effect on attention through two broad categories of mechanisms: specific and nonspecific. Specific mechanisms refer to those aspects of the activity that focus specifically on attention. The nonspecific mechanisms refer to those aspects of computer activity that promote or facilitate skill acquisition without directly targeting attention. An example of a nonspecific mechanism would be self-pacing, an option many tasks provide. Self-pacing provides a measure of

control, which is known to facilitate learning. Both the specific and nonspecific mechanisms contribute meaningfully to the overall therapeutic effect.

III. EMPIRICAL STUDIES

The largest and best controlled studies of treatment efficacy indicate a positive effect of attention training. These effects can be seen both in terms of improved performance on pure measures of (nonsocial) attention and improvement in social and psychological functioning. Patients exposed to computerized attention exercises such as the ORM have been shown to improve both on the remediation exercises themselves and on the CPT, an independent measure of ability to focus and sustain attention. Noncomputerized attention training such as the IPT groups, which offer exercises to improve attention in social contexts, has also been demonstrated to improve performance on some aspects of pure, nonsocial attention. Performance on the Span of Apprehension, which requires rapid scanning of stimulus features, was improved in patients exposed to 6 months intensive IPT training. There is also evidence that computerized and noncomputerized attention training impacts on social competence and psychological status as measured by such instruments as the AIPSS and BPRS. Shaping techniques used in group therapy to improve social aspects of attention have been found to improve ability to stay on task as measured in minutes, in small samples of chronic treatment refractory patients, some who had low IQ. Well-controlled, large treatment efficacy studies are still rather scarce and replication of results is required. Many parameters have yet to be studied, for example, optimal intensity and duration of treatment, characteristics of treatment responders and nonresponders, and optimal balance of focus on social and nonsocial aspects of attention.

IV. SUMMARY

Attention impairment is a common symptom of psychiatric disease. In schizophrenia, attention impairment is associated with poor outcome, deficient social skills, and diminished ability to benefit from rehabilitation and skills training. The attention system is composed of subsystems that perform different but interrelated cognitive functions such as the ability to focus, encode, rapidly process and respond, maintain vigilance, and avoid

distraction from competing stimuli. These aspects of attention can be differentially impaired and the first step in designing a treatment program is to identify the type of attentional problems that will be the target of intervention. Both the purely cognitive and more social aspects of attention can be addressed in the remediation program. The procedures available for remediation of attention include computerized and noncomputerized exercises that may be done individually or in groups. Computerized exercises tend to focus on the more purely cognitive aspects of attention, whereas group exercises often target attention as it applies in a social setting.

Given that attention deficits are not simply a manifestation of neuropsychological dysfunction, but rather social-emotional-cognitive dysfunction, remediation procedures that emphasize an integrated approach to the patient are more likely to appreciate the complex interaction of cognitive, emotional, and environmental variables in the recovery process. Attention remediation has been found to be effective in improving performance on pure measures of (nonsocial) attention and social and psychological functioning. Replication of well-controlled treatment efficacy studies is needed. Many treatment parameters have yet to be researched, for example, optimal intensity and duration of treatment, characteristics of treatment responders and nonresponders, and the various contributions of specific and nonspecific treatment effects.

See Also the Following Articles

Differential Attention ■ Neuropsychological Assessment

Further Reading

- Green, M. F., Kern, R. S., Braff, D., & Mintz, J., (2000). Neurocognitive deficits and functional outcome in schizophrenia: Are we measuring the "right stuff"? *Schizophrenia Bulletin*, 26, 119–136.
- Hogarty, G. E., & Flesher, S. (1999). Practice principles of cognitive enhancement therapy for schizophrenia. *Schizophrenia Bulletin*, 25, 693–708.
- Medalia, A., & Revheim, N. (1999). Computer assisted learning in psychiatric rehabilitation. *Psychiatric Rehabilitation Skills*, 3, 77–98.
- Medalia, A., Aluma, M., Tryon, W., & Merriam, A. E. (1998). Effectiveness of attention training in schizophrenia. *Schizophrenia Bulletin*, 24, 147–152.
- Nuechterlein, K. H., & Subotnik, K. L. (1998). The cognitive origins of schizophrenia and prospects for intervention. In T. Wykes, N. Tarries, & S. Lewis (Eds.), *Outcome and inno-*

- vation in psychological treatment of schizophrenia (pp. 17–41). New York: John Wiley & Sons.
- Silverstein, S. M., Valone, C., Jewell, T. C., Corry, R., Nghiem, K., Saytes, M., & Potrude, S. (1999). Integrating shaping and skills training techniques in the treatment of chronic, treatment-refractory individuals with schizophrenia. *Psychiatric Rehabilitation Skills*, 3, 41–58.
- Spaulding, W., Reed, D., Sullivan, M., Richardson, C., & Weiler, M. (1999). Effects of cognitive treatment in psychiatric rehabilitation, 25, 657–676.

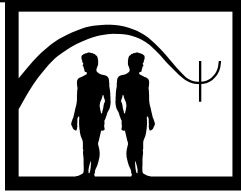

Aversion Relief

Paul M. G. Emmelkamp and J. H. Kamphuis

University of Amsterdam

- I. Description of Treatment
 - II. Theoretical Bases
 - III. Empirical Studies
 - IV. Summary
- Further Reading

GLOSSARY

aversion relief A therapeutic procedure in which the occurrence of desired behavior leads to the cessation of an aversive stimulus.

aversion therapy A variety of specific techniques based on both classical and operant conditioning paradigms intended to change maladaptive behavior.

covert sensitization The pairing in imagination of undesired behavior with covert negative consequences.

negative reinforcement Removal of an aversive stimulus that leads to an increase of the future probability of the desired response.

punishment A method of behavior control in which an undesired response is followed by a noxious stimulus, thus leading to a reduction of the future probability of the undesired response.

I. DESCRIPTION OF TREATMENT

Aversive methods were used widely in the 1960s and 1970s, but for a variety of reasons these methods are less accepted today. Aversive methods are used for treating maladaptive approach behavior, such as alco-

hol dependence, smoking, overeating, obsessive-compulsive behavior, and various forms of deviant sexual behavior. Furthermore, perhaps most controversial, aversive methods have also been used in patients with autism and mental retardation.

Aversive conditioning is intended to produce a conditioned aversion to, for example, drinking or deviant sexual interest. *Aversion therapy* includes a variety of specific techniques based on both classical and operant conditioning paradigms. With aversive conditioning in alcohol-dependent subjects, a noxious stimulus (unconditioned stimulus, UCS) is paired with actual drinking (conditioned stimulus, CS) or with visual or olfactory cues related to drinking. A variety of aversive stimuli have been used, the most popular of which were electric shock and nausea- or apnea-inducing substances. *Covert sensitization* is a variant of aversive conditioning wherein images (e.g., of drinking situations or of deviant sexual stimuli) are paired with imaginal aversive stimuli. It is actually “covert” because neither the undesirable stimulus nor the aversive stimulus is actually presented, but these are presented in imagination only. “Sensitization” refers to the intention to build up an avoidance response to the undesirable stimulus.

In *aversion relief* the subject is enabled to stop the aversive stimulus by performing more appropriate behavior, which will lead to feelings of relief. For example, deviant sexual stimuli (e.g., pictures of nude children) may be the UCS followed by the onset of shock (CS), while the cessation of shock is preceded by the appearance of pictures of nude adult women. The procedure is

intended to condition the pleasant experiences associated with the cessation of shock (aversion relief) to adult females, while the unpleasant experiences associated with the onset of shock are conditioned to children.

A classical example of aversion relief therapy in children with autism was presented by Lovaas and his co-workers. Autistic children were asked to approach the therapist. If the child did not approach, shock was delivered and continued until an approach was made. Subsequently, shocks could be avoided by approaching within 5 seconds of the request. This application of aversion relief led to a dramatic increase in the approach behavior of autistic children and had maintained its effect nine months later without further shocks.

A common example of aversion relief therapy is the application of bitter-tasting substances on the thumb in children who engage in thumb- or finger-sucking activity. Thumb- or finger-sucking will now lead to a bad taste, which will stop as soon as the child withdraws the thumb or finger out of the mouth (aversion relief).

Aversion relief has also been applied in treating anxiety disorders by Solyom and colleagues, including obsessive compulsive behavior, specific phobias, and agoraphobic avoidance. Solyom detailed an aversion relief procedure in the context of agoraphobic avoidance. Patients were repeatedly guided through audiotaped self-generated narratives of phobic avoidance. The vignettes might be interspersed with short pauses after which mild electric shocks (ES) were delivered. Patients could terminate the shock by pressing a button and continuing the taped approach scenario. For a particular female patient the narrative was: *"I am getting dressed ... 15 sec ... ES, button pressed (by patients to terminate ES) to leave my home, as I am getting prepared and put my make-up on ... 15 sec ... ES, button pressed, the bell rings ... 15 sec ... ES button pressed. My heart is beating very fast I answer the bell and my boyfriend comes in, he says ... 15 sec ... ES button pressed, let's go Mary, ... 15 sec ... ES button pressed, the party is already on."*

Covert sensitization might be considered an imaginal variant of aversion relief and is also referred to as aversive imagery. Before the formal treatment by covert sensitization begins, it is important to gather detailed information concerning the characteristics associated with the maladaptive approach behavior to be changed. This information is essential in order to develop realistic scenes for the patient. Furthermore, some time is spent in providing the treatment rationale. It is explained that the problem (e.g., drinking) is a strongly learned habit that must be unlearned by the association

of the pleasurable situation (e.g., drinking) with an unpleasant stimulus (feelings of nausea and vomiting).

The procedure will be illustrated with a case of a male alcohol-dependent patient. In this procedure, the patient first learns to relax. When he is able to relax, he is asked to close his eyes and to visualize very clearly a drinking situation. For example, he may be asked to visualize himself in a pub, looking at a glass full of beer, holding the glass in his hand, and having the glass touch his lips. Then he is asked to imagine that he begins to feel sick to his stomach and that he starts vomiting all over himself and the female bartender. Then he is told to imagine that he rushes outside, or that whenever he is tempted to drink but refuses to do so, the feeling of nausea goes away and he will feel relieved and relaxed (aversion relief).

It is important to use as many aversive details as possible. A verbatim account might run as follows: *Your stomach feels rather nauseous. As you look at the glass, puke comes up into your mouth. As soon as you smell the beer, you cannot hold it any longer: you vomit. It goes all over your hand, and your glass. Snot and mucous comes out of your nose, you can see it floating around in the beer. There is an awful smell. As you look at this mess you just can't help but vomit again and again. The female bartender gets some on her shirt and pants. You see her shocked and disgusted expression. You run out of the bar and you feel better and better.*

The patient is usually asked to repeat the scenes presented during the therapy sessions a number of times daily until the next appointment. These scenes can be written on pocket-sized cards. The patient is instructed to carry these cards and to read these scenes several times a day. Furthermore, the patient is also instructed to use this procedure immediately upon noticing an urge to drink. Thus, a lot of *in vivo* conditioning occurs in actual temptation situations, when the patient applies the procedure in the prescribed manner outside the therapist's office.

II. THEORETICAL BASES

Aversion relief procedures are rooted in learning theory. Decreasing the frequency of a behavior by presenting an aversive stimulus immediately after an inappropriate response is a case of punishment. Increasing the rate of a behavior by removing aversive stimuli contingently following a desired response is termed negative reinforcement. Escape responses produce relief from aversive stimuli; this procedure is

called aversion relief. For example, shock during alcohol sipping could be avoided or escaped by spitting out the alcohol. The aversion relief component of the treatment of alcoholics utilizes a desirable response (e.g., spitting out alcohol) as a potential positive reinforcing stimulus, deriving its positive quality from its contiguity with escape.

In covert sensitization, the imagining of an aversive situation (e.g., vomiting) as soon as the individual has an urge to perform the undesired behavior (e.g. drinking) is usually considered a punishment procedure: An aversive stimulus is made to follow the inappropriate response to be reduced. According to punishment theory, response frequency can be expected to decrease when the noxious stimuli are contiguous with that response. Initially, the aversive stimulus should be presented on a continuous basis, but later on a partial schedule can be used. The aversion relief part of covert sensitization can be considered an escape procedure, which occurs when a particular stimulus terminates the presentation of a noxious stimulus. Eventually, cues that initially led to urges will gradually become discriminatory stimuli for avoidance behavior.

Although there is some evidence that covert sensitization may lead to a favorable outcome in patients with addictions and deviant sexual interest a number of theoretical issues remain unresolved, which cast doubt on the presumed theoretical underpinnings of covert sensitization. First, although scene presentation in covert sensitization includes aversion relief, the addition of this component to the overall effectiveness of the procedure has not been evaluated. Moreover, Emmelkamp and Walta found that the effects of covert sensitization could better be explained by cognitive factors such as outcome expectancy than by conditioning. In their experimental study, half of the participants (smokers) were led to believe that they participated in an experimental study on the physiological effects of imagining smoking scenes, whereas the other half were informed that they received a bonafide treatment. All participants were treated with covert sensitization. Only the smokers who expected that they received an effective treatment showed a significant reduction in smoking rate. Thus, the results of this study suggest that cognitive factors (i.e., expectancy of improvement) rather than conditioning factors may account for the positive effects achieved with covert sensitization. Others have also questioned the conditioning explanation of covert sensitization, since covert sensitization using backward conditioning was found to be as effective as covert sensitization using forward conditioning. If covert sensiti-

zation acted by conditioning, the backward procedure should be considerably less effective than one administering the same conditioned and unconditioned stimuli, in the same number of trials, but in a forward conditioning paradigm.

III. EMPIRICAL STUDIES

Most of the studies attesting to the effectiveness of aversion relief as a principal treatment have been uncontrolled case studies. Procedures based on aversion relief have been successfully applied in specific phobias, obsessive compulsive behaviors, obesity, aphonia, torticollis, writing cramp, transvestism, fetishism, and other deviant sexual interests. Results with thumb-sucking are not always positive. Nathan Azrin and his co-workers compared aversion relief therapy (using a bitter-tasting substance) with habit reversal in 32 children with thumbsucking. At three-month followup, 47% of the habit-reversal children had stopped thumbsucking, compared to 10% of the aversion relief children. These findings suggest that aversion relief may be of little value in reducing thumbsucking. However, the parents in the aversion relief therapy were only instructed by phone, whereas the therapist saw the habit reversal children and their parents in a single session. Given this methodological flaw, the results must be viewed with caution.

Much of the research on the effectiveness of aversion relief in anxiety disorder patients comes from research conducted by L. Solyom and his colleagues. The largest study to date involved 50 phobic patients randomly assigned to flooding in imagination, systematic desensitization in imagination, aversion relief, phenelzine, or placebo. On psychiatric rating, aversion relief was found to be more effective than the other methods. However, results are difficult to interpret since the patients in the aversion relief therapy received twice as many therapy sessions (24 sessions) as compared to patients who received flooding or systematic desensitization (12 sessions). In an earlier study by the same research group, the effects of aversion relief were investigated in agoraphobics. In this study, overall improvement was rather small. Patients rated their main phobia as unimproved.

Although some uncontrolled case studies suggest that aversion relief may be of some value in patients with obsessive-compulsive rituals and patients with pure obsessions, the only controlled study into the effectiveness of aversion relief with obsessive-compulsive

patients found this treatment to be ineffective. Or, as Kapche concluded in an earlier review of Aversion Relief Therapy (ART): "While ART does not apparently hinder treatment, there is no strong evidence that it is beneficial." Perhaps as a byproduct of the demonstrated effectiveness of exposure *in vivo* procedures, little interest has since been shown in evaluating the effectiveness of aversion relief in patients with anxiety disorders.

Several studies have evaluated the effects of covert sensitization among alcoholics, but the findings of most of these studies are difficult to interpret due to severe methodological limitations. One study provided some evidence that conditioned nausea could be produced in a number of alcoholics receiving covert sensitization treatment. Approximately 90% of patients who remained in treatment for at least six covert sensitization sessions reacted with genuine nausea responses as evidenced by swallowing, muscular tremor, and facial grimacing and occasionally by actual vomiting, but only two-thirds of these subjects developed some degree of conditioned nausea. Conditioned nausea was defined as "nausea arising as a direct consequence of the subject's focusing on pre-ingestive or ingestive concomitants of typical drinking scenes." Significant degrees of extended abstinence were observed for conditioned nausea subjects as opposed to other participants. Another well-controlled study found covert sensitization more effective than insight-oriented therapy and routine milieu treatment in alcohol-dependent inpatients. In both studies, participants were inpatients in a traditional alcoholism rehabilitation program. Thus, conclusions with respect to covert sensitization as a primary form of treatment are not warranted.

A number of studies have been reported that used covert sensitization to reduce deviant sexual interest, primarily exhibitionists. The largest series ($n = 155$) was reported by Barry Maletzky, which included a followup ranging from one to nine years. Generally, results of covert sensitization were positive, but a number of issues preclude more definite conclusions. For example, in the Maletzky studies, about half of the exhibitionists received other procedures in addition to covert sensitization. Moreover, these studies did not include control groups, and progress was evaluated by means of self-report only. Furthermore, there is some support in a number of controlled case studies for the effectiveness of covert sensitization in pedophilic child offenders, but controlled group studies have not yet been reported. Maletzky addressed the issue of whether there is a difference in outcome between self-referred and court-referred pedophiliacs ($n = 38$). Treatment

consisted of 24 weekly sessions of covert sensitization and was followed by "booster" sessions every three months for three years. When assigning 75% reduction in covert and overt pedophile behavior as a criterion for improvement, 89% of the self-referred and 73% of the court-referred subjects were rated as improved. Several measures showed a slight superiority of response in the self-referred group. Inspection of the police records over a three-year period revealed that the self-referred group had no charges, while the court-referred group had four charges.

IV. SUMMARY

Despite its strong empirical basis in learning theory and the interest it evoked in the 1970s, few controlled studies have evaluated the effects of aversion relief therapies in clinical patients. Although a number of studies have reported successful treatment in a variety of disorders (e.g., alcohol dependence, smoking, overeating, and anxiety disorders), it should be noted that most reports involved (a series of) case studies. Apparently, the literature on aversion relief dried up in the early 1980s: A Psychinfo literature search revealed no new references in the 1990s, 7 references in the 1980s, and 18 and 5 articles in the 1970s and 1960s, respectively. This does not specifically concern aversion relief as such but involves nearly all aversive methods. Apparently, only covert sensitization has not gone totally out of fashion.

One of the main reasons behind the absence of recent controlled research into the effects of aversion relief procedures may be that aversive stimulation has become an increasingly controversial ethical issue. Some have argued that aversive methods are justified only when the behavior is seriously dangerous to the individual and when no alternative treatment options are available. Internationally, many institutions no longer allow aversive methods. In addition, in most institutions it is current practice to require that aversive methods using electric shock obtain prior approval by the human rights committee. To be approved, one typically needs to demonstrate that (1) alternative treatment options have failed or are unjustified, (2) the client (or parents) has given informed consent, and (3) colleagues have approved this technique as professionally justified.

Interest in aversion relief therapy may also have waned because alternative (and less intrusive/objectionable) treatments have been found to be at least as effective. For example, in the area of anxiety disorders

in vivo exposure methods are now considered the gold standard, and there is little reason to believe that aversion relief therapy will be able to surpass the effects achieved with exposure therapy. Similarly, in the area of alcohol dependence, alternative cognitive behavioral procedures (e.g., motivational interviewing, coping skills training, and relapse prevention) have been developed and evaluated in large multicenter trials, such as the MATCH project.

See Also the Following Articles

Anxiety Management Training ■ Assisted Covert Sensitization ■ Avoidance Training ■ Covert Reinforcer Sampling ■ Matching Patients to Alcoholism Treatment ■ Negative Reinforcement ■ Sex Therapy

Further Reading

Azrin, N. H., Nunn, R. G., & Frantz-Renshaw, S. (1980). Habit reversal treatment of thumbsucking. *Behaviour Research & Therapy*, 18, 395–399.

Emmelkamp, P. M. G. (1994). Behavior therapy with adults. In A. Bergin & S. Garfield (Eds.) *Handbook of psychotherapy & behavior change* (pp. 379–427). New York: Wiley.

Emmelkamp, P. M. G., & Walta, C. (1978). The effects of therapy-set on electrical aversion therapy and covert sensitization. *Behavior Therapy*, 9, 185–188.

Kapche, R. (1974). Aversion-relief therapy: A review of current procedures and the clinical and experimental evidence. *Psychotherapy: Theory, research and practice*, 11(2), 156–162.

Lichstein, K. L., & Hung, J. H. F. (1980). Covert sensitization: An examination of covert and overt parameters. *Behavioral Engineering*, 6, 1–18.

Maletzky, B. M. (1991). *Treating the sexual offender*. Newbury Park, CA: Sage.

Sheldon, J., & Risley, T. R. (1990). Balancing clients' rights. The establishment of human-rights and peer-review committees. In A. S. Bellack, M. Hersen, & A. E. Kazdin (Eds.), *International handbook of behavior modification and therapy* (pp. 227–250). New York: Plenum.

Solyom, L. (1971). A comparative study of aversion relief and systematic desensitization in the treatment of phobias. *British Journal of Psychiatry*, 119(550), 299–303.

Solyom, L. (1972). Variables in the aversion relief therapy of phobics. *Behavior Therapy*, 3(1), 21–28.

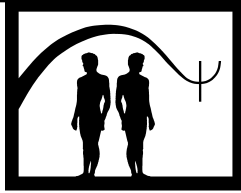

Avoidance Training

James K. Luiselli

The May Institute Inc., Norwood, Massachusetts

- I. Description of Treatment
- II. Theoretical Bases
- III. Empirical Studies
- IV. Summary
- Further Reading

GLOSSARY

- avoidance-responding* Behavior that postpones (prevents) contact with an unpleasant consequence event.
- escape-responding* Behavior that terminates ongoing contact with unpleasant stimulation.
- negative reinforcement* An increase in behavior as a result of terminating or postponing an unpleasant stimulation or consequence event.

Avoidance training is an intervention approach used with children and adults that incorporates nonpreferred and unpleasant consequences to treat behavior disorders. Individuals are taught to refrain from problem responses or to demonstrate acceptable alternative responses by avoiding contact with the nonpreferred and unpleasant consequences. This entry reviews the conceptual foundations of avoidance training, use of the procedure in clinical psychology, and supportive research findings.

I. DESCRIPTION OF TREATMENT

An understanding of avoidance training can be gleaned from the following “everyday life” example. Motorists frequently exceed the speed limits posted on our highways. If a driver in such a situation sees a blinking light ahead and determines that it is a police vehicle, the driver responds by reducing speed and conforming to the specified limit. In this example, the driver’s behavior of slowing down avoids a possible encounter with law enforcement that, in turn, leads to a negative consequence (receipt of a speeding ticket). Responding occurs in this way because the driver may have previously been stopped by police or may have observed such activity with other motorists. As described subsequently, this description includes all of the components integral to avoidance training.

When implemented for therapeutic purposes, avoidance training follows a five-step process: (1) identifying the problem behavior to be reduced, (2) selecting a response to serve as replacement for the problem behavior, (3) choosing a negative consequence, (4) pairing the negative consequence with the problem behavior, and (5) allowing the child or adult to avoid the negative consequence. A more detailed description of each step follows.

Behaviors that are the target of avoidance training usually are those that interfere with personal well-

being, social adjustment, school performance, occupational functioning, and the like. Thus, a child may show extreme noncompliance with parental requests, or an adult may argue excessively with co-workers. However, skill deficits also are addressed through avoidance training. A child, for example, may have a health-compromising condition because she or he has a chronic problem of eating a very limited amount of food. Here the issue is not the presence of a specified “challenging” behavior but instead the absence of a skill. In most cases, simultaneous elimination of a problem and acquisition of a replacement behavior is the objective of avoidance training.

The issue of a skill deficit is most relevant to step 2 in the avoidance training paradigm: the selection of a replacement behavior. Recall that a primary objective of avoidance training is to strengthen one or more responses that can substitute for the problem. However, one must determine whether the replacement behavior is a skill that the child or adult possesses but does not perform regularly or is a skill that the child or adult has not learned. Failure to demonstrate a skill that is within a person’s repertoire is a difficulty with performance. Not using a skill because it has not yet been learned is a difficulty with acquisition. Accordingly, how a skill deficit is manifested will have implications for whether avoidance training is warranted as intervention and, if so, what the replacement behavior should be.

The third step in the process of avoidance training is to choose a negative consequence that eventually will be paired with the display of the problem behavior or the absence of the requisite skill. A negative consequence is unpleasant and produces distress for the individual. For this reason, certain ethical and clinical concerns must be embraced when considering avoidance training. During the 1960s and 1970s, many publications in the behavior modification and behavior therapy literature described avoidance training applications that relied on “noxious” (aversive) types of stimulation such as electric shock, distasteful solutions, and foul odors. These stimuli are highly invasive and, over time, have fallen out of favor with behavioral practitioners. As revealed in the subsequent section on empirical studies, the “later generation” research concerning avoidance training typically has incorporated negative consequences that are less restrictive and intrusive. Nevertheless, these interventions expose individuals to unpleasant conditions and, therefore, must be selected and formulated cautiously.

Step 4 of avoidance training is to implement the contingency in which the negative consequence is con-

tacted. The contiguous pairing of behavior and consequence allows the individual to learn the avoidance function that is intended to promote alternative responses. Repeated trials usually are programmed to hasten learning effects. It should be noted, however, that informing an individual about the relationship between behavior and the negative consequence may also produce a desirable outcome. In this situation, the negative consequence is not experienced directly, and controlling effects are achieved through verbal mediation (i.e., the individual is told “what will happen”).

The final step is the continued exposure of the individual to conditions where the negative consequence is avoided following the demonstration of the alternative behavior. The objective here is to maintain clinical improvement for an extended duration.

The following illustration depicts how the five steps in an avoidance training protocol would be instituted. The example is a school-age child who exhibits disruptive behaviors in the classroom such as talking out of turn, annoying other students, and using materials to make noise. Because of these behaviors, the child does not complete academic assignments. The classroom teacher determines that one way to reduce these interfering behaviors is to require the child to complete all assignments in order to participate in daily recess periods. If motivated to complete the assignments, it is likely that the problem behaviors will decrease. This depiction qualifies as avoidance training because the undesirable consequence of not having recess can be avoided when the child completes academic assignments. The child learns this contingency when she or he experiences the loss of recess because of incomplete performance. Or, to reiterate a previous point, simply informing the child about the conditions governing participation in recess may be sufficient to produce the behavior objective

II. THEORETICAL BASES

The theoretical foundation of avoidance training rests with the concept of negative reinforcement. Reinforcement principles form the basis of operant learning theory that is commonly associated with the research and writings of B.F. Skinner. Positive reinforcement is the presentation of a pleasurable consequence following a behavior, with the result that the frequency of the behavior increases over time. By contrast, negative reinforcement is the removal or postponement of a non-pleasurable consequence following a behavior. Negative

reinforcement has the same objective as positive reinforcement, which is to increase behaviors that are appropriate, useful, and functional for an individual. With negative reinforcement, the removal or postponement of undesirable consequences is an effect that is “pleasurable” to the individual and makes it more likely that the behavior producing that effect will occur more frequently.

Negative reinforcement can operate in two ways. In one instance, a behavior can occur that terminates or reduces the intensity of ongoing stimulation that is unpleasant. The behavior would be described as “escape.” With the second operation, a behavior can postpone or prevent the unpleasant stimulation and would be described as “avoidance.” Escape responding, therefore, requires that behavior be demonstrated in the presence of the unpleasant (negative) stimulation, whereas avoidance responding occurs in the absence of the unpleasant (negative) stimulation.

On a clinical level, the distinction between escape-generated and avoidance-generated behavior is an important one because it is defined by the presence or absence of negative conditions. Imagine an adolescent boy in a psychiatric hospital who is confined to a room (seclusion) because he becomes “out of control” on the inpatient unit. Being in the room is unpleasant for the boy, and he learns that this condition can be terminated by being released from the room when he composes himself. Regaining his control is reinforced negatively because it allows him to escape a contemporaneous, unpleasant condition. Learning by avoidance would be evident when confinement to the room is not encountered by the boy because he behaves properly without “losing control.” Here, negative reinforcement functions because the boy’s desirable behavior prevents room confinement.

Avoidance training can be traced to experimental animal research. Under conditions termed free operant avoidance, electric shocks were delivered automatically to a rat through a device on the grid floor of a small metal chamber. The shocks were programmed to occur at preset intervals via a recycling timer. A second timer postponed shock onset by a particular duration each time the rat pressed a lever. This type of experimentation revealed different patterns of lever-press responding as a function of variables such as shock intensity, temporal parameters between intervals, and the schedule of shock presentations. Related research concerned the study of “discriminated avoidance” in which a neutral stimulus was programmed to precede electric shock. The neutral stimulus functioned as a “warning

signal,” and if the rat exhibited a specific behavior during the time between the onset of the signal and the noxious stimulation, the electric shock would be prevented. The behavior of the rat is “discriminated” because it does not occur in the absence of the signal. This acquisition of discriminated avoidance with lower animals serves as an analog for avoidance training applications with humans.

III. EMPIRICAL STUDIES

As a preview to the presentation of research concerning avoidance training with children and adults, several considerations should be the focus of attention. First, in contrast to other procedures within behavior modification and behavior therapy, there has been less emphasis on avoidance training as a first-line strategy to clinical intervention. This fact likely results from the requirement that unpleasant consequences must be incorporated when programming avoidance training. For many professionals, it is unpalatable to add distress to the life of a child or adult who already is experiencing adjustment difficulties. Even in cases where avoidance training may be clinically justified, it can be an arduous task arranging the conditions wherein negative consequences are arranged contiguously with behavior or are introduced within everyday settings.

A second issue is that where avoidance training has been supported by empirical research, the procedure frequently is combined with other treatment methods. It is rare, in fact, to find studies that have not described such multicomponent intervention. Again, inclusion of negative consequences in the therapeutic process dictates that additional (e.g., positive reinforcement) procedures be used.

Finally, the early history of avoidance training in clinical practice addressed problems, and included certain negative consequences, that are not consistent with contemporary standards. One example is research conducted during the 1960s in which children who had autism and were not responsive to social interaction were treated through avoidance training with electric shock. A therapist issued the instruction, “Come here,” and an electric current was passed through the grid floor. The children “escaped” the aversive stimulation when they approached the therapist. They then learned to avoid the shock by responding quickly to the social instruction.

Other research, reported in the 1970s, used electric shock in an avoidance training paradigm to “treat”

women and men who were homosexual and wished to change their sexual orientation. The clients viewed slides that were projected on a screen and included pictures of same-sex adults, clothed and nude, that were rated as attractive. Viewing the slides for a fixed duration produced an electric shock. The shock could be avoided by pressing a switch, which terminated the slide, before the predetermined viewing time elapsed. Another component of this procedure was to have a slide of the opposite sex appear when the preceding same-sex slide was removed. This strategy was an attempt to build in counterconditioning in which opposite-sex adults would become appealing because they were paired with the relief (a positive event) experienced when shock was avoided.

The preceding examples provide an historical perspective from which to view avoidance training, but they do not represent acceptable, present-day treatments. For one, electric shock is extremely invasive stimulation that behavioral psychologists essentially have abandoned and ceased to defend as viable treatment. Relative to children with autism and other developmental disabilities, many training procedures and effective interventions have been validated that do not rely on aversive methods or subject individuals to painful consequences. As per the description of adult homosexuality, the professional community no longer judges this form of sexual orientation as an illness or pathology. Furthermore, if a homosexual woman or man sought assistance to change her or his sexual orientation, avoidance training of the type described would not be implemented.

More benign examples of avoidance training can be found in the treatment literature with children who received intervention for feeding disorders. Several studies have evaluated avoidance training that targeted chronic food refusal. Children with this problem do not consume food orally or may eat only select food items. In many cases, the food refusal is volitional in that there is no physical cause for the behavior. One type of intervention in such cases has been to place food on a utensil, bring the utensil to the child's lips, instruct the child to "take a bite," and wait several seconds for the child to consume the food. If independent eating does not occur, a therapist prompts mouth-opening by gently pushing against the child's jaw and depositing the food. The physical guidance delivered by the therapist functions as mildly unpleasant stimulation that can be avoided by the child opening his or her mouth after the verbal instruction is given.

Reference to the literature on child behavior problems reveals that avoidance training has been incorporated in many interventions that include contingent effort. Effort procedures require that when an individual exhibits a behavior that disrupts the environment or causes property destruction, the effects of such behavior must be corrected. Thus, children who break objects during an episode of agitation must clean up and restore the surroundings to their previous condition. This increased response effort associated with cleanings is avoided by refraining from the problem behaviors.

IV. SUMMARY

Avoidance training is an approach to clinical intervention that is founded on the principle of negative reinforcement. Children and adults learn to avoid negative and unpleasant consequences by not exhibiting problem behaviors or by demonstrating acceptable alternatives. Avoidance training as a therapeutic procedure can be linked to operant learning theory that was studied in the animal laboratory. In contrast to other behavior-change procedures, avoidance training is used less frequently in clinical practice. Because the procedure requires exposing a child or adult to unpleasant conditions, it must be considered cautiously and implemented with great care in those situations where it can be justified clinically.

See Also the Following Articles

Aversion Relief ■ Behavioral Weight Control Therapies ■ Conditioned Reinforcement ■ Eating Disorders ■ Electrical Aversion ■ Negative Reinforcement ■ Operant Conditioning

Further Reading

- Iwata, B. A. (1987). Negative reinforcement in applied behavior analysis: An emerging technology. *Journal of Applied Behavioral Analysis*, 20, 361.
- Matson, J. L., & DiLorenzo, T. M. (1984). *Punishment and its alternatives*. New York: Springer.
- Sidman, M. (1966). Avoidance behavior. In W. K. Honig (Ed.), *Operant behavior: Areas of research and application*. New York: Appleton.
- Wilson, G. T., & O'Leary, K. D. (1980). *Principles of behavior therapy*. Englewood Cliff, NJ: Prentice Hall.



Backward Chaining

Douglas W. Woods and Ellen J. Teng

University of Wisconsin-Milwaukee

- I. Description of Treatment
 - II. Theoretical Basis
 - III. Empirical Studies
 - IV. Summary
- Further Reading

number of other behaviors in individuals with developmental disabilities and who are typically developing. This article will present a description of the procedure along with the theoretical basis and empirical support for its use.

GLOSSARY

- chaining** Process by which an organism learns an ordered sequence of behaviors.
- discriminative stimulus** A stimulus in the presence of which a particular behavior is reinforced.
- reinforcement** A process in which a behavior is followed by the presentation of a stimulus and as a result, produces an increase in the future probability of that behavior.
- target behavior** The behavior of interest, or the behavior to be altered.
- task analysis** A step in the backward chaining procedure in which the entire target behavior is broken down into smaller sequential steps.

Backward chaining is a procedure used to establish relatively complex sequences of behaviors in organisms. Although the procedure was originally applied to nonhumans, it has been adopted for use with humans. Typically, backward chaining is used to improve the independent functioning of individuals with developmental disabilities, but it can also be used to establish a

I. DESCRIPTION OF TREATMENT

Many human tasks involve a number of simple, but separate, motor behaviors that when organized into a specific sequential fashion, produce a desired outcome. For example, the task of brushing one's teeth can be broken down into the following simple behaviors: picking the toothbrush up, reaching for the tube of toothpaste, grasping the tube of toothpaste, putting paste on the brush, putting the brush in the mouth, moving the brush back and forth across the teeth, rinsing the mouth, and rinsing the toothbrush.

Even a relatively simple task such as brushing one's teeth consists of a number of component behaviors (which themselves, could be further broken down) that must be completed in a specific sequence before an acceptable outcome can be achieved (i.e., clean teeth). In most cases, humans learn such sequences of behavior (called chains) without focused instruction. However, in some cases, focused instruction is required as may be the case for persons with developmental disabilities.

To aid in establishing chains of behavior in humans, applied psychologists have borrowed strategies

originally designed by basic researchers in the area of operant conditioning. Practitioners have adopted three such strategies including whole-task chaining, forward chaining, and backward chaining. The focus of this article is on backward chaining.

Backward chaining is implemented in the following fashion. First, the clinician must identify the chain of interest and the target behavior from completing the chain. For example, assume that the clinician wishes to train a client with low functioning to make sandwiches. In this case, the chain of interest is sandwich making and the target behavior would be consuming the sandwich.

After the target chain and target behavior have been identified, the clinician must conduct a task analysis. When doing a task analysis, the clinician breaks the target chain into discrete component behaviors. For example, the task analysis of the sandwich-making chain may consist of the following components: taking a plate out of the cupboard, taking two slices of bread out of the bag, taking the lunch meat and mustard out of the refrigerator, putting one slice of bread on the plate, putting the meat on the sandwich, putting the mustard on the meat, placing the remaining slice of bread on top, and lifting the sandwich to the open mouth.

Although it clearly can be seen that the aforementioned task analysis could be broken down into more specific behaviors, the level of specificity used in creating the task analysis should be matched with the client's level of functioning. Clients with lower functioning may require a task analysis that breaks the chain into very simple and specific components, whereas clients with higher functioning may do well with a less simplified task analysis.

On completion of the task analysis, the actual chaining procedure begins. In backward chaining, the first behavior learned by the client is the last component behavior in the chain. On completion of the final behavior in the chain, the person receives the reinforcer associated with the outcome of the chain (called the terminal reinforcer). In the aforementioned chain, the first behavior learned by the client would be lifting a prepared sandwich to the mouth, and the resulting reinforcing outcome would be consuming a bite of the sandwich. To teach the sandwich lifting, the clinician should start by providing a verbal prompt to engage in the chain of behavior (e.g., "Alice, make a sandwich for yourself.") and then model the behavior for the client. After the clinician models the behavior, he or she should then provide the verbal prompt again followed by a physical prompt for the client to do the same behavior. After the client lifts the sandwich to her mouth, she should be allowed to

take a bite and should be praised at the same time. After the final behavior in the chain occurs reliably when the verbal prompt is given, the clinician should begin to train the second-to-last step in the chain.

When training the second-to-last step, all the steps in the chain should be completed by the beginning of that step. Continuing with the previous example, in teaching the second-to-last step in the chain, the sandwich would be completely made except that the last slice of bread would not be on the sandwich. When training this task, the clinician would again provide the verbal prompt (e.g., "Alice, make a sandwich for yourself."), model the specific task (putting the last slice on the sandwich) and complete the remainder of the chain (lifting the sandwich to the mouth and taking a bite). After the modeling, the clinician would provide the verbal prompt then physically prompt the client to engage in the novel step (i.e., putting the last slice of bread on the sandwich), provide praise for doing so, and prompt the completion (if necessary) of the remaining steps in the chain.

After the client is reliably implementing the second-to-last link followed by the completion of the remainder of the chain, the clinician should begin training the third-to-last step using the aforementioned procedures. This sequence should continue until the client has learned the entire sequence and can implement the entire chain contingent on the verbal prompt (e.g., "Alice make a sandwich for yourself.").

II. THEORETICAL BASIS

Backward chaining was developed by operant learning researchers to systematically train complex sequences of behaviors. The term chaining refers to the way in which the behaviors pertaining to a specific sequence are linked together. In backward chaining, the behaviors are learned in a reverse order from how the chain is performed. In other words, the final step in the chain is learned first, followed by the next-to-last step and so on. Each link in the behavioral chain is evoked by a discriminative stimulus and reinforced by the consequences of the behavior involved in the link. For example, in early learning studies, a discriminative stimulus (e.g., a red light) was presented to the organism. If the organism made the correct response (e.g., pressing a lever), food was presented. Not only was the lever pressing reinforced, but the red light was also established as a reinforcing stimulus. When the operant chamber was rearranged so the organism had to do another behavior (e.g., wheel running) to produce the red

light, it soon did so and then completed the chain of pressing the lever and receiving food. In this case, the presence of the wheel became a discriminative stimulus for wheel running, which was reinforced by the appearance of the red light. The red light, in turn served as a discriminative stimulus for the lever pressing that was reinforced by the final outcome of food presentation.

In the applied arena, backward chaining is conceptualized in a similar fashion. The outcome of the chain is equivalent to the food received by the non-human organism in the operant chamber. The discriminative stimulus for the last link in the chain is the situation present immediately prior to engaging in the last behavior. Using the previous applied example, the discriminative stimulus would be the completed sandwich lying on a plate prior to being picked up. As the clinician moves backward to the next step in the chain, the completed sandwich will not only function as a discriminative stimulus for picking the sandwich up, but the sight of the completed sandwich will function as a reinforcer for the preceding behavior in the chain (e.g., putting the last piece of bread on top of the mustard-covered sandwich). This process will continue until the original verbal prompt begins to function as the discriminative stimulus that will initiate the entire behavioral chain.

As can be seen from these examples, an individual learning a sequence of behavior through backward chaining repeatedly experiences the effect of the terminal reinforcer presented at the end of the chain as each link is added. This theoretical advantage of backward chaining distinguishes it from other methods of chaining such as forward chaining, in which the first step of a sequence is taught first and then linked to the second step and so on, or whole-task chaining, in which all the steps, from start to finish, are attempted on each trial. In the latter two cases, the terminal reinforcer is not presented until the person has successfully learned all steps in the behavioral chain.

III. EMPIRICAL STUDIES

Backward chaining was first implemented in an operant laboratory by B. F. Skinner in 1938. After demonstrating the effectiveness of backward chaining in studies with non-human animals, the procedure was first applied to humans in an effort to develop more effective instructional methods in classroom settings. Since then, backward chaining has been applied in diverse settings and found to be effective in teaching specific skills. In this section, the clinical utility of backward chaining is briefly

reviewed. Included are brief discussions of variables to consider when using this technique, such as target populations and behaviors, treatment outcome variables, and a comparison of backward chaining to other chaining procedures, including a brief discussion on when backward chaining methods should be implemented.

A. Client Populations

Research demonstrates that backward chaining has been successfully used with diverse populations ranging from children to elderly adults. Although some research has demonstrated the effectiveness of this procedure with persons who are typically developing the majority of studies have focused on individuals with developmental disabilities. Within this latter population, backward chaining has been extensively used and found to be particularly effective in teaching skills to children and adults with mild to profound mental retardation and to children with other developmental disorders such as autism. It is not clear why research has focused so heavily on evaluating backward chaining in persons with developmental disabilities, but it may be the case that persons who are typically developing often do not require the intensive type of training to establish behavior sequences as provided by the procedure.

B. Targeted Behaviors

Among persons who are typically developing, backward chaining has been effective in treating children with specific speech problems such as misarticulation. In 1987, Edna Carter Young used backward chaining as part of a procedure to retrain the speech of two toddlers who frequently omitted weak syllables or consonants. Essentially, the procedure involved teaching the child to say the last part of a word first and then incorporating that part into the word. For example, to learn to say the word monkey, the child was first taught to say key, and then join it to the rest of the word, mon, thereby producing the word monkey.

Some evidence also suggests that backward chaining can be an effective teaching method for learning novel tasks. For example, in 1990, Daniel W. Ash and Dennis H. Holding used backward chaining as one method of teaching students without prior musical experience to play different sequences of musical notes on an electric piano. Likewise, other studies examining the effectiveness of backward chaining methods in flight simulation tasks have demonstrated it to be an effective method in teaching various components of aircraft landing.

Although the prior examples demonstrate the use of backward chaining with persons who are typically developing the procedure is most commonly used to teach skills to persons with developmental disabilities. Within this population, backward chaining has been widely applied in teaching various independent living skills to children and adults. Examples include hygiene skills such as self-grooming, teeth brushing, and toileting, socialization, and travel skills. For example, in 1979, Barbara Gruber and colleagues used backward chaining to teach four institutionalized males with profound retardation to walk independently from their place of residence to school. Such efforts have been instrumental in allowing persons with developmental disabilities to live in less restrictive environments such as group homes.

Not only has backward chaining been used to teach self-help skills to persons with developmental disabilities, it has also been successful in helping children with autism to learn to speak in short sentences. In addition, several studies have demonstrated the effectiveness of backward chaining in treating children who refuse to eat or drink. For example, in 1996, Louis P. Hagopian and colleagues used backward chaining as part of a procedure to treat a 12-year-old boy with autism and mental retardation who completely refused liquids. After obtaining a baseline measure of the boy's drinking and conducting a task analysis, backward chaining was implemented. In this case, drinking water from a cup was the target response, and the chain consisted of three segments: (1) bringing the cup of water to the mouth, (2) accepting water into the mouth, and (3) swallowing. To implement this backward chain, the boy was first reinforced by being given access to a preferred activity for 90 sec when he swallowed after being prompted to do so, and then he gradually swallowed a small amount of water from a syringe. In the third step, he was required to bring a cup containing a small amount of water to his mouth, accept the water into his mouth, and swallow the water before reinforcement was delivered. Using this procedure, Hagopian and colleagues were able to successfully teach the boy to gradually drink an increasing quantity of liquids.

C. Variables Used to Determine Outcome Effectiveness

As with most behavioral interventions, the structure and goal of an intervention is determined after an assessment is conducted. Similarly, depending on the goal of the intervention, the way in which its effectiveness is measured will vary across situations. Therefore,

there is no one set criterion against which to measure the effectiveness of a backward chaining procedure. Instead, there are a number of variables that are commonly used to gauge its effectiveness. In a review of chaining techniques by Fred Spooner and colleagues in 1984, the major dependent variables of interest include (1) time to criterion (predetermined number of successful performances of entire chain determined by the trainer), (2) number of incorrect responses (steps of the chain performed incorrectly), (3) number of correct responses (steps of the chain performed correctly), (4) rate of correct responses (number of correctly performed steps of the chain performed in a given period of time), and (5) rate of incorrect responses (number of incorrectly performed steps of the chain performed in a given period of time).

Although there has been some question regarding how to determine the effectiveness of a training procedure, variables should be selected based on the goal of the behavior that is being taught. For example, in 1980, Richard T. Walls and colleagues noted that number of errors often serve as the critical measure because errors may impede subsequent learning. On the other hand, if speed is more important than accuracy in learning the behavioral sequence, then rate should be selected as a measure of outcome effectiveness.

D. Comparing Backward, Forward, and Whole-Task Chaining

Comparative research on the effectiveness of the different chaining methods has produced mixed results. Several studies involving individuals with developmental disabilities have revealed that forward and backward chaining were more effective methods for teaching new skills compared to a whole-task approach. For example, in 1981 Richard T. Walls and colleagues compared all three chaining methods and found that forward and backward chaining resulted in fewer errors when teaching adults with moderate retardation to assemble objects, compared to the whole-task chaining method. In this study, there were no significant differences between forward and backward methods.

On the other hand, in 1983, Fred Spooner and colleagues compared only backward to whole-task chaining when teaching adults with profound retardation to assemble objects and found that whole-task chaining required fewer trials to reach criterion than backward chaining.

Research comparing the effectiveness of chaining methods remains equivocal. However, as Gregory J.

Smith suggested in 1999, the mixed results regarding the effectiveness of different chaining methods may be due to the fact that different populations were used in various studies, and different types of behaviors were taught. Therefore, no direct comparisons among chaining methods can be made without first taking these variables into account.

Similarly, as a review of the research suggests, there does not seem to be one method that is more effective than the others across all situations, rather, it is more probable that the effectiveness of the chaining method used is dependent on several factors, including variables associated with the learner (such as level of cognitive functioning) and the type of behavior being taught. Therefore, when deciding which chaining methods to use, clinicians should consider their client's level of intelligence and the type of behavior being taught.

E. When Backward Chaining Should Be Implemented

In general, the backward chaining method has been found to be effective and most appropriate for use with individuals with cognitively lower functioning including persons with developmental disabilities. However, it is also appropriate to use with individuals with higher functioning when a behavior is more complex and difficult, often involving many steps. In this case, backward chaining may be preferred over a whole-task approach because it can be particularly effective in teaching the person one component of the behavioral sequence at a time, before attempting to chain all the components together. Furthermore, backward chaining may be more effective than other chaining methods in situations when client motivation is low or when a response is infrequent or absent, because other chaining methods will limit the client's access to the terminal reinforcer.

IV. SUMMARY

Generally, backward chaining is an effective technique used to teach a complex sequence of behaviors to

humans. Although it has also been used with persons who are typically developing, it has been predominantly applied when teaching basic daily living skills to persons with developmental disabilities. The essential feature of backward chaining is teaching a sequence of behaviors in reverse order, starting with the last step in the behavioral sequence. Although it is unclear if backward chaining is more effective than other chaining procedures, one advantage of backward chaining is that the terminal reinforcer is always delivered as the individual completes each step.

See Also the Following Articles

Behavior Therapy: Historical Perspective and Overview ■ Chaining ■ Classical Conditioning ■ Conditioned Reinforcement ■ Forward Chaining ■ Home-Based Reinforcement ■ Operant Conditioning

Further Reading

- Ash, D. W., & Holding, D. H. (1990). Backward versus forward chaining in the acquisition of a keyboard skill. *Human Factors*, 32(2), 139–146.
- Gruber, B., Reeser, R., & Reid, D. H. (1979). Providing a less restrictive environment for profoundly retarded persons by teaching independent walking skills. *Journal of Applied Behavior Analysis*, 12, 285–297.
- Hagopian, L. P., Farrell, D. A., & Amari, A. (1996). Treating total liquid refusal with backward chaining and fading. *Journal of Applied Behavior Analysis*, 29, 573–575.
- Smith, G. (1999). Teaching a long sequence of behavior using whole task training, forward chaining, and backward chaining. *Perceptual and Motor Skills*, 89, 951–965.
- Spooner, F. (1984). Comparisons of backward chaining and total task presentation in training severely handicapped persons. *Education and Training of the Mentally Retarded*, 19(1), 15–22.
- Spooner, F., & Spooner, D. (1984). A review of chaining techniques: Implications for future research and practice. *Education and Training of the Mentally Retarded*, 19, 114–124.
- Spooner, F., Weber, L. H., & Spooner, D. (1983). The effects of backward chaining and total task presentation on the acquisition of complex tasks by severely retarded adolescents and adults. *Education and Treatment of Children*, 6(4), 401–420.

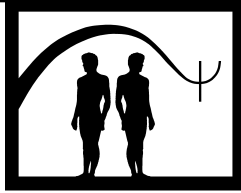

Beck Therapy Approach

Judith S. Beck

Beck Institute for Cognitive Therapy and Research, University of Pennsylvania

- I. Description of Treatment
 - II. Theoretical Basis
 - III. Efficacy
 - IV. Summary
- Further Reading

be time limited, problem solving oriented, and structured. Both patient and therapist are quite active. The treatment emphasizes having patients learn to identify and modify their distorted or dysfunctional thoughts and beliefs and to change their dysfunctional behavior. In doing so, patients' mood, symptoms, functioning, and relationships improve.

GLOSSARY

automatic thought An idea that seems to arise in one's mind spontaneously, in verbal or imaginal form.

belief One's basic understandings of oneself, one's world, and other people.

cognition A thought, image, rule, attitude, assumption, or belief.

cognitive distortion A type of thinking error.

schema A relatively stable and enduring mental structure that exerts a significant influence over one's processing of information.

Cognitive therapy is a system of psychotherapy, based on a comprehensive theory of psychopathology and personality. Its theoretical underpinnings have been empirically supported, and the therapy itself has been demonstrated to be effective in over 325 outcome studies for a wide range of psychiatric disorders. Treatment is based on specific cognitive formulations of each disorder and on the individual cognitive conceptualization of each patient. Cognitive therapy tends to

I. DESCRIPTION OF TREATMENT

Cognitive therapy is based on the cognitive model that describes the relationship between people's perceptions and interpretations of situations and their reactions (emotional, behavioral, and physiological). When people are in distress, their thinking is often characterized by faulty information processing; their perceptions are often invalid, or not completely valid. For example, a depressed woman makes only two mistakes when word processing a long document at work and thinks, "I can't do *anything* right." This thought is called an "automatic thought," because it seems to pop up spontaneously in her mind. Before therapy, she may have been only vaguely aware of these kinds of thoughts, if at all. She may have been much more cognizant of her reaction: her affect (sadness), her dysfunctional behavior (leaving work early), and/or her physiological response (heaviness in her body).

In therapy, patients learn to cue themselves when they notice their negative reactions so they can identify

their automatic thoughts. Then they learn techniques of evaluating the validity and utility of their thoughts. When they correct their distorted thinking, they have a more positive reaction: their affect lifts, their behavior becomes more functional, they have an improved physiological response. Much of the therapy is organized around helping patients directly change their thinking and behavior and solve problems.

Treatment varies somewhat from disorder to disorder and patient to patient, though there are several basic principles described elsewhere by the author.

1. Cognitive therapy is based on an ever-evolving formulation of patients and their problems according to a cognitive framework.
2. Cognitive therapy requires a sound therapeutic alliance.
3. Cognitive therapy emphasizes collaboration and active participation..
4. Cognitive therapy is goal oriented and initially focuses on current problems.
5. Cognitive therapy is educative and emphasizes relapse prevention.
6. Cognitive therapy aims to be time limited.
7. Cognitive therapy sessions are structured.
8. Cognitive therapy teaches patients to identify, evaluate, and respond to dysfunctional thoughts and beliefs.
9. Cognitive therapy uses a variety of techniques to modify thinking, mood, and behavior.

These principles are described below.

Cognitive therapists conceptualize patients in cognitive terms, that is, they seek to understand how patients' beliefs give rise to specific thoughts in current situations and influence their reactions. When patients have long-standing personality problems, therapists also seek to understand how patients have historically interpreted events, often since childhood, and how these interpretations have influenced (and still influence) their ideas about themselves, their worlds, and others.

Therapists also identify the maladaptive behavioral "coping" strategies patients develop to get along in the world. For example, a therapist hypothesized that because of genetic predisposition and early abuse, Beth developed the belief that she was bad and defective. Fearful that others would view her negatively, she developed the coping strategy of always putting on a good face. Otherwise, she believed, people would see her "real" self and reject her.

Treatment is based on an ever-evolving conceptualization as therapists collect additional data to confirm,

disconfirm, or modify their hypotheses. A Cognitive Conceptualization Diagram (Figure 1) aids therapists in concretely formulating their conceptualization. Therapists check out their conceptualization with patients to ensure they are on the right track.

A strong therapeutic alliance is an essential part of cognitive therapy. Therapists build the alliance by working collaboratively with the patient as a "team," demonstrating care, concern, and competence; providing rationales before using various strategies; summarizing patients' narratives to ensure accurate understanding; checking hypotheses and formulations with patients; solving problems; eliciting feedback at the end of sessions (and during sessions, if they infer a negative reaction); and helping patients quickly to reduce symptoms.

It is often more difficult to establish a strong therapeutic alliance with patients who have dysfunctional relationships outside of therapy. They often bring dysfunctional beliefs about themselves and other people to the therapy relationship (e.g., "If I trust other people, I'll get hurt."). When such a belief interferes with a "standard" approach, therapists help patients elicit, test, and respond to patients' distorted ideas about the therapist and about therapy.

Therapists as well as patients are quite active during the therapy session. Therapists continually engage in Socratic questioning, as they ask patients open-ended questions to collect data, elicit key thoughts, uncover the meaning of their thoughts, identify beliefs, test the evolving conceptualization, and evaluate thoughts and beliefs. Collaboration is an important principle of cognitive therapy: therapist and patient work together to identify and understand the patient's problems and perspectives. They collaborate in setting goals, defining and solving current problems, and devising tests to assess the accuracy of their thinking.

Initially the focus is on the present, helping patients identify and modify their thinking about distressing situations, solving problems, and changing behavior. Toward the middle of therapy, there is an additional emphasis on modifying maladaptive beliefs. In the final stage of therapy, relapse prevention strategies are emphasized. In actuality, therapists use relapse prevention strategies from the beginning of therapy, as they not only help patients change their thinking and behavior but also instruct patients in how to do so themselves. An important goal of therapy is to teach patients to become their own therapists.

Cognitive therapy is generally a relatively brief form of psychotherapy. Most straight-forward depressed and anxious patients achieve remission with six to twelve sessions of therapy (weekly at first, then spaced further

COGNITIVE CONCEPTUALIZATION DIAGRAM

Patient's name: Sally Date: 2/22
 Diagnosis: Axis I Major depressive episode Axis II None

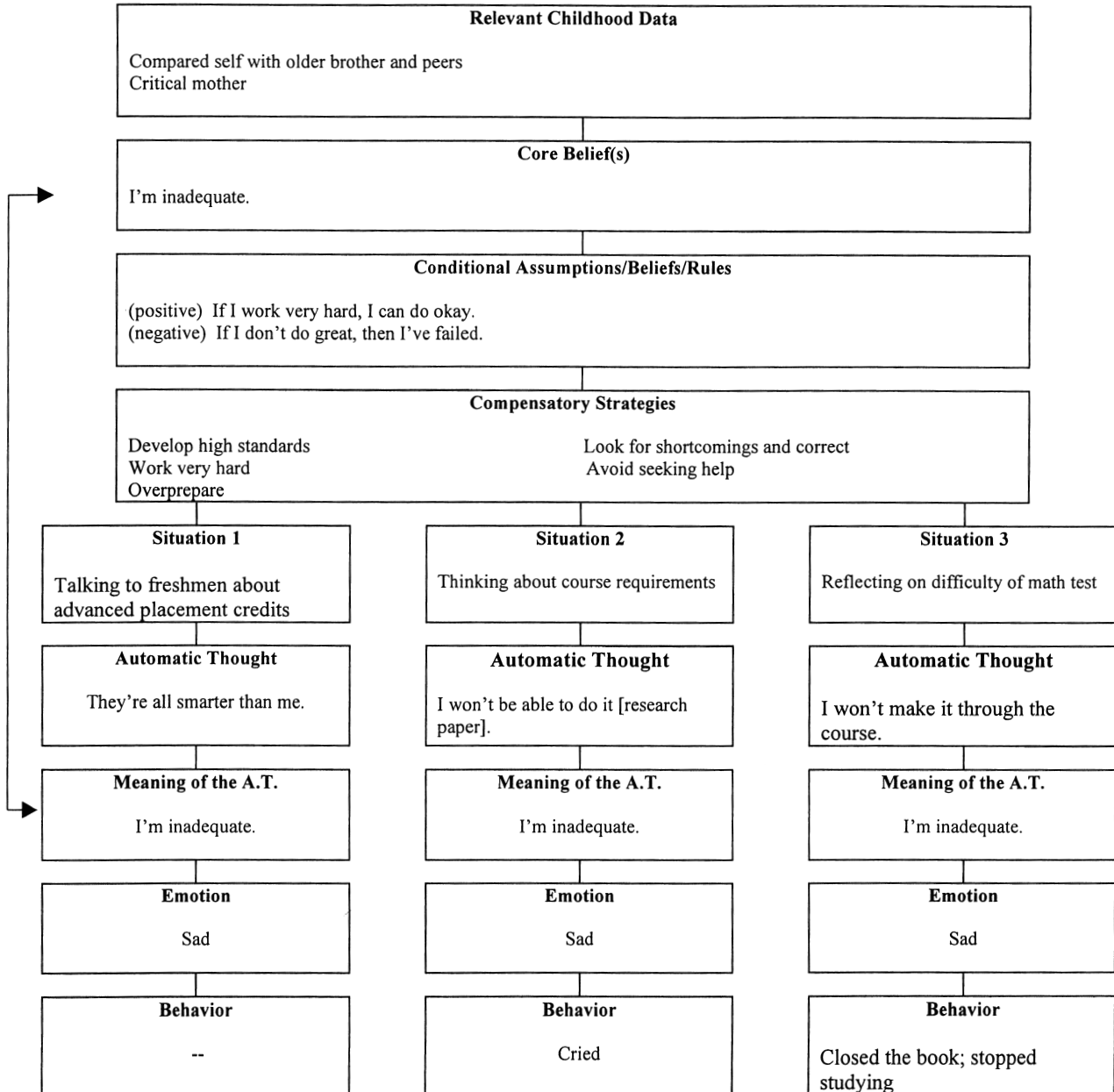

FIGURE 1 Cognitive Conceptualization Diagram. From Judith Beck, *Cognitive Therapy: Basics and Beyond*. © Judith S. Beck, 1993. Reprinted with permission of Guilford Press.

apart). Patients with more complex disorders, comorbid diagnoses, severe or chronic symptoms, or personality pathology may require (sometimes significantly) longer treatment.

Cognitive therapy sessions generally follow a certain structure. At the beginning therapists obtain an objective and subjective account of patients' symptoms, general mood, progress, and behavior in the past week.

They jointly set an initial agenda; patients are asked to label the most important problem(s) they want to work on during the session. They make a “bridge” from the previous session, asking patients to recall important conclusions from the previous session, significant events during the past week, and what they gained or learned from the self-help assignments (“homework”) they did. They also ask patients whether they predict any special problems will arise in the coming week.

This additional data often leads to additional agenda items. The agenda is collaboratively prioritized. The session is then organized around the problems on the agenda. Patients and therapists collaboratively decide which problem to focus on first. In the context of discussing a problem, therapists gather data to refine their conceptualization and teach patients skills, such as identifying and critically evaluating their distorted thinking and using behavioral and problem-solving techniques. Homework assignments are also generated by the discussion.

Before moving on to another problem, therapists ask patients to summarize their conclusions from the discussion and ensure that they are likely to do the agreed-on assignments. At the end of each session, patients summarize the most important points of the session, and therapists elicit their feedback about the session.

Cognitive therapists use many different types of techniques to modify patients’ thinking, mood and behavior, including

- *Cognitive*: identifying, evaluating, and modifying thoughts, images, and beliefs
- *Behavioral*: activity monitoring and scheduling, skills training, graded tasks, distraction, exposure, response prevention
- *Problem solving*: specifying problems, responding to automatic thoughts and beliefs that interfere with problem solving, brainstorming and choosing solutions, implementing solutions and evaluating outcomes
- *Emotional*: regulation of affect through engaging in self-soothing activities, relaxation, controlled breathing, distraction, seeking support, reading therapy notes
- *Physiological*: medication (if indicated), exercise, reducing caffeine and other drugs, focusing externally instead of internally
- *Interpersonal*: correcting faulty beliefs, learning communication, assertiveness and other social skills, solving interpersonal problems (bringing family members or significant others into therapy, if indicated)
- *Environmental*: weighing advantages and disadvantages of making changes in living or work environments (if indicated), responding to thoughts that interfere with making needed changes
- *Supportive*: demonstrating empathy, regard, caring, acceptance, and accurate understanding of patients’ internal reality through verbal and non-verbal responses
- *Experiential*: roleplaying; using imaginal techniques to respond to automatic thoughts in the form of images; inducing images to heighten affect (to uncover key cognitions) or to reduce affect; restructuring the meaning of traumatic events through the re-experience of key memories in imaginal form in the presence of heightened affect, then using guided imagery and/or psychodrama techniques
- *Psychodynamic-like*: helping patients identify and evaluate automatic thoughts that arise and dysfunctional beliefs that become activated during the therapy session, particularly dysfunctional ideas about the therapist or therapy, then guiding them to generalize what they learned to relationships outside of therapy; drawing connections between beliefs (learned earlier in life and maintained throughout the patient’s life) and his/her interpretations and reactions to current situations

These techniques, whether they are specifically cognitive in nature or not, result in cognitive change. Much of the therapeutic work in cognitive therapy, however, is devoted toward directly identifying and modifying inaccurate or dysfunctional thoughts and assumptions. Therapists often use a worksheet, the *Dysfunctional Thought Record* (DTR) to help patients record and respond to their thoughts and assumptions in a structured way (Table 1).

Although DTRs are used with many patients, they generally are adapted for (or discussed verbally with) patients who might not be able to grasp them fully. Patients are encouraged to use questions such as the following to help them evaluate and devise alternative responses to their dysfunctional thinking:

- What is the evidence that my automatic thought is true? What is the evidence on the other side, that my automatic thought might not be true, or not completely true?
- What is an alternative explanation or an alternative viewpoint?
- What is the worst that could reasonably happen and how would I cope? What is the best that could happen? What is the most realistic outcome?

TABLE 1
Dysfunctional Thought Record

Directions: When you notice your mood getting worse, ask yourself, "What's going through my mind right now?" and as soon as possible jot down the thought or mental image in the Automatic Thought Column.

Date/time	Situation	Automatic thought(s)	Emotion(s)	Adaptive response	Outcome
	1. What actual event or stream of thoughts, or daydreams or recollection led to the unpleasant emotion? 2. What (if any) distressing physical sensations did you have?	1. What thought(s) and/or image(s) went through your mind? 2. How much did you believe each one at the time?	1. What emotion(s) (sad/anxious/angry/etc.) did you feel at the time? 2. How intense (0–100%) was the emotion?	1. (optional) What cognitive distortion did you make? 2. Use questions at bottom to compose a response to the automatic thought(s). 3. How much do you believe each response?	1. How much do you now believe each automatic thought? 2. What emotion(s) do you feel now? How intense (0–100%) is the emotion? 3. What will you do (or did you do)?
Friday, 2/23 10 A.M.	Talking on the phone with Donna.	She must not like me any more. 90%	Sad 80%		
Tuesday, 2/27 12 P.M.	Studying for my exam.	I'll never learn this. 100%	Sad 95%		
Thursday, 2/29 5 P.M.	Thinking about my economics class tomorrow. Noticing my heart beating fast and my trouble concentrating.	I might get called on and I won't give a good answer. 80% What's wrong with me?	Anxious 80% Anxious 80%		

Questions to help compose an alternative response: (1) What is the evidence that the automatic thought is true? Not true? (2) Is there an alternative explanation? (3) What's the worst that could happen? What could I do to cope? What's the best that could happen? What's the most realistic outcome? (4) What's the effect of my believing the automatic thought? What could be the effect of changing my thinking? (5) What should I do about it? (6) If (friend's name) was in the situation and had this thought, what would I tell him or her?

From Judith Beck *Cognitive Therapy: Basics and Beyond*. © Judith S. Beck, 1995. Reprinted with permission of Guilford Press.

TABLE 2
Typical Thinking Errors

Cognitive distortions

1. *All-or-nothing thinking* (also called black-and-white, polarized, or dichotomous thinking): You view a situation in only two categories instead of on a continuum.
Example: “If I’m not a total success, I’m a failure.”
 2. *Catastrophizing* (also called fortune telling): You predict the future negatively without considering other, more likely outcomes.
Example: “I’ll be so upset, I won’t be able to function at all.”
 3. *Disqualifying or discounting the positive*: You unreasonably tell yourself that positive experiences, deeds, or qualities do not count.
Example: “I did that project well, but that doesn’t mean I’m competent; I just got lucky.”
 4. *Emotional reasoning*: You think something must be true because you “feel” (actually believe) it so strongly, ignoring or discounting evidence to the contrary.
Example: “I know I do a lot of things okay at work, but I still feel like I’m a failure.”
 5. *Labeling*: You put a fixed, global label on yourself or others without considering that the evidence might more reasonably lead to a less disastrous conclusion.
Example: “I’m a loser.” “He’s no good.”
 6. *Magnification/minimization*: When you evaluate yourself, another person, or a situation, you unreasonably magnify the negative and/or minimize the positive.
Example: “Getting a mediocre evaluation proves how inadequate I am. Getting high marks doesn’t mean I’m smart.”
 7. *Mental filter* (also called selective abstraction): You pay undue attention to one negative detail instead of seeing the whole picture.
Example: “Because I got one low rating on my evaluation [which also contained several high ratings] it means I’m doing a lousy job.”
 8. *Mind reading*: You believe you know what others are thinking, failing to consider other, more likely possibilities.
Example: “He’s thinking that I don’t know the first thing about this project.”
 9. *Overgeneralization*: You make a sweeping negative conclusion that goes far beyond the current situation.
Example: “[Because I felt uncomfortable at the meeting] I don’t have what it takes to make friends.”
 10. *Personalization*: You believe others are behaving negatively because of you, without considering more plausible explanations for their behavior.
Example: “The repairman was curt to me because I did something wrong.”
 11. *“Should” and “must” statements* (also called imperatives): You have a precise, fixed idea of how you or others should behave, and you overestimate how bad it is that these expectations are not met.
Example: “It’s terrible that I made a mistake. I should always do my best.”
 12. *Tunnel vision*: You only see the negative aspects of a situation.
Example: “My son’s teacher can’t do anything right. He’s critical and insensitive and lousy at teaching.”
-

From Judith Beck, *Cognitive Therapy: Basics and Beyond*. Adapted with permission from Aaron T. Beck. Reprinted with permission of Guilford Press.

- What is the effect of my believing this automatic thought? What could be the beneficial effects of changing my thinking?
- If [name of specific close friend or family member] were in this situation and had this thought, what would I tell him or her?
- What should I do now?

Teaching patients to identify their typical *cognitive distortions*, or types of thinking errors, also helps them understand the relative invalidity of many of their negative thoughts (Table 2). When emotionally distressed, people tend to make many more errors in their interpretations of events than usual. Matthew, for example, consistently displayed all-or-nothing thinking (“Either I’m the best or

I’m a failure.”), mind reading (“They [his co-workers] are probably laughing behind my back.”), fortune telling (“I’ll never catch up.”) and labelling (“I’m a total loser.”)

Other techniques used to help patients evaluate their automatic thoughts include:

- behavioral experiments (where patients directly test thoughts or assumptions such as, “If I try to get more done, I’ll just fail.”)
- imagery work (using imagery techniques in response to spontaneous, negative images)
- coping cards (collaboratively composing statements, graphics, or pictures for patients to read during the week to remind themselves of important learnings from previous sessions)

After patients learn the skill of modifying their automatic thoughts, therapists start emphasizing their cognitions at the belief level. An intermediate level of belief contains attitudes, rules, and assumptions that may have been understood, but unexpressed, before therapy. Therapists often seek to understand patients' intermediate beliefs in assumption form. For example, Peter had a dysfunctional attitude, "It's terrible to make a mistake." His rule was, "I can't make mistakes." His assumption, which was more easily subject to a behavioral test was, "If I make a mistake, terrible things will happen."

Core beliefs are a deeper level cognition. They are rigid, overgeneralized, global, dysfunctional, and largely inaccurate understandings that people have of themselves, their worlds, and other people, such as "I am unlovable," "I am helpless," "Other people will hurt me," "The world is a hostile place."

Key dysfunctional beliefs can be identified in several ways. Sometimes patients (especially depressed patients) express their beliefs directly, as automatic thoughts ("I'm a complete failure.") Beliefs may be inferred by examining the consistent themes in automatic thoughts across situations. Cynthia, for example, had frequent thoughts such as, "Mary won't want to spend time with me," "No one will want to talk to me at the party," "My friends don't really know me very well," "If I try to get closer to Jane, she'll reject me," and "People don't seem to like me much." One of Cynthia's central beliefs, expressed indirectly in the thoughts above, was that she was unlovable.

A third way to uncover beliefs is to ask patients the *meaning* of their typical automatic thoughts: "If this automatic thought is true,..."

- what does that mean?
- what's the worst part about it?
- what does it say about you as a person?

Many of the techniques used to help patients evaluate their automatic thoughts can be used to evaluate core beliefs as well. Before working on belief modification, however, therapists present an explanatory model to patients, so they can better understand why they are absolutely convinced of the validity of a belief, even though the belief may be inaccurate or largely inaccurate. An information processing model helps them understand how and why they easily assimilate data confirming their core belief but ignore or discount positive data that disconfirm their belief. Patients learn, with their therapists' help, to bring this kind of information processing under conscious control. Much of the therapy from this point on is directed toward helping patients develop alternative

(more accurate and functional) perspectives of negatively perceived events and to become aware of, and process without discounting, positive data and events.

Other methods for the modification of core beliefs about the self are the use of extreme contrasts ("How much of a failure are you compared to [a specific person whom the patient sees as an extreme failure]?"), metaphors, and cognitive continua (which help patients see that their beliefs are at an extreme, instead of on a continuum). Therapists may help patients recall childhood events from which their core beliefs arose (or through which their beliefs became strengthened) and then evaluate the validity of those beliefs at that time and at the current time. This process allows patients to restructure the meaning of important childhood or adolescent experiences at an intellectual level. They may need experiential techniques to restructure the meaning at an "emotional" or "gut" level.

II. THEORETICAL BASIS

Beck originally based his cognitive treatment for depression on his cognitive theory of depression that has been largely supported in hundreds of subsequent studies. Cognitive theory posits that people tend to perceive and interpret situations in characteristic ways that color their feelings and shape their behavior. People often have spontaneous "automatic thoughts" about their past, current, or future situations. Because automatic thoughts are generally "silent," people are more apt to be aware of their subsequent emotions, behavior, or physiological reactions. Automatic thoughts are often fleeting, sometimes telegraphic in nature, and, when recognized, highly plausible to the individual—even when incorrect or dysfunctional. When people are in emotional distress, their thinking becomes more rigid, primitive, and distorted. They make characteristic errors, or cognitive distortions, and may begin to ruminate or obsess.

At a deeper level, when people are emotionally distressed, their maladaptive beliefs (their basic understandings of themselves, their worlds, and other people) become activated. These beliefs influence their perception and interpretation of their experience. Individuals may begin to develop a preponderance of negative thinking.

Beliefs are ideas embedded in mental structures in the mind called "schemas." Relatively adaptive schemas may predominate when people are not distressed. When they develop a psychiatric disorder, however, their negative cognitive schemas, which may have been dormant or

latent, start to dominate and influence their thinking. A particular “mode” (composed of a network of interrelated cognitive, affective, motivational, and behavioral schemas) may become activated and profoundly affect individuals’ thinking, motivation, mood, and behavior. The mode represents the constellations at the core of full-blown disorders such as depression or paranoia.

How do people develop negative beliefs? These basic rules, formulas, and concepts are influenced by genetic predisposition and develop in response to environmental events. A child who is verbally abused at school, for example, may start to believe that she is unlikable. If she has supportive parents, however, her belief may be tempered, and she may see herself as predominately likeable. If, in her twenties, though, she is rejected by a significant other, her latent belief of unlikability may become activated again, and she may be vulnerable to developing a depressive disorder.

Cognitive theory posits a diathesis-stress model to explain the occurrence of emotional disorders. Individuals may be relatively psychologically healthy until a congruent stressor activates their dysfunctional beliefs. These beliefs start to bias how they process information. People who have relatively strong autonomous personalities, for example, are usually adversely affected when their efficacy, freedom, or mobility is threatened or reduced. If they are not also high in sociotropy, however, they may be relatively less affected by interpersonal disruption or loss (and vice versa).

Joe, for example, was relatively well-adjusted until three stressors occurred. In the first semester of his senior year in high school, he began to have difficulty in one of his courses, he was dropped by his school’s varsity basketball team, and he started a challenging and demanding after school and weekend job. He started to have negative thoughts about himself and his performance. “I must be stupid. I can’t believe I did so badly on those math tests.” “It’s humiliating to be dropped from the team. I’m such a loser.” “I don’t understand what to do. This job is too hard. I can’t do anything right.”

Joe had an underlying specific vulnerability to situations in which his sense of efficacy was challenged, and he began to attend selectively to experiences that supported his view of himself as inadequate. He began to interpret more and more situations in light of this belief (his performance in other classes, his estimation of his general intellectual and athletic abilities, his standing among his peers). Feeling inadequate, he began missing classes, avoiding basketball practice, doing his homework superficially, skipping work, and spending a lot of time in bed, watching television. A recognition of these dysfunctional behaviors strengthened Joe’s nega-

tive beliefs of inadequacy and failure that led to increasingly negative and dysfunctional thinking that led to a deteriorating mood and more dysfunctional behavior, in an escalating downward spiral.

Beck and colleagues have developed specific cognitive formulations for the major psychiatric disorders. Depression, for example, is characterized by negative thoughts about the self, experience, and future (“I’m worthless, the world presents too many obstacles, I’ll always be a basket case.”). Anxious patients’ thoughts reflect overestimations of threat and underestimations of resources (“It’s very likely terrible things will happen and I won’t be able to cope.”). Patients with panic disorder make catastrophic misinterpretations of physiological or mental sensations (“This unreal feeling in my head means I’m going crazy.”). Obsessive-compulsive patients make misinterpretations of their negative thoughts and images (“My imagining that I will stab my friend with this knife means I’m out of control. I really might harm her.”). Hypomanic patients have an inflated view of themselves and their future (“I am so powerful, I can do anything I want.”).

Specific beliefs for each personality disorder have also been identified. Patients with dependent personality disorder, for example, believe they are weak and helpless and others are strong. Paranoid patients believe other people are potentially dangerous and that they could be harmed if they are not watchful. Avoidant patients believe they are defective and others will reject them.

These kinds of negative, global, rigid beliefs may have originated in childhood or adolescence in people with long-standing problems, and their beliefs may be more or less continuously activated. Typically, they develop certain guidelines or rules to help them cope with these painful ideas. Histrionic patients may believe, “If I am dramatic, people will pay attention to me and they will accept me.” The corresponding negative belief, however, is “If people don’t pay attention to me, it means I’m nothing.” Obsessive-compulsive personality disorder patients believe, “If I control myself and others, setting up systems of order, then I’ll be okay. But if I don’t, my world will fall apart.” Narcissistic patients hold the belief, “If people give me the respect and entitlements I want, it will show I’m superior. But if they don’t, it means I’m inferior.” Eating disorder patients believe, “If I control my eating, I’ll be thin, and therefore acceptable. But if I don’t, my eating will go out of control, I’ll gain weight and be unacceptable to myself and others.”

When individuals’ beliefs are extreme, they display overdeveloped behavioral strategies (compensatory or coping) to protect themselves or compensate for their perceived deficiencies, and they tend to use these

strategies in an indiscriminatory manner, even when they are maladaptive. They fail to develop a broad range of strategies that would be more adaptive in many situations. Dependent patients, for example, inordinately rely on others, borderline patients reject others to avert being rejected themselves, substance abuse patients use drugs or alcohol to avoid intolerable emotion, hypochondriacal patients continually check their bodies for signs of disease or infirmity.

The relationships among an individual's developmental experiences, his or her core beliefs, assumptions, and compensatory strategies are illustrated in the top half of Figure 1. The bottom half shows how these underlying factors influence the individual's interpretation of and reaction to current situations. This conceptualization helps guide the therapist in modifying patients' dysfunctional thinking and behavior.

III. EFFICACY

Andrew Butler and Judith Beck conducted an analysis of fourteen meta-analyses of cognitive therapy outcome studies in 2000. They found substantial support for the efficacy of cognitive therapy in 325 studies, comprising 9,000 patients. Cognitive therapy was found to be somewhat superior to antidepressant medications in the treatment of adult unipolar depression. A significant finding was that depressed patients treated with cognitive therapy had half the *relapse* rate (30%) of those who had taken medication (60%). Cognitive therapy was found to be superior to supportive and nondirective therapies for adolescent depression and equally effective as behavior therapy for obsessive-compulsive disorder. Cognitive therapy was superior to a number of miscellaneous psychosocial treatments for sexual offenders. Cognitive therapy was also efficacious in the treatment of bulimia nervosa.

Other research studies have demonstrated the efficacy of cognitive therapy for generalized anxiety disorder, panic disorder, and hypochondriasis. It has also been shown to be effective for inpatient depression, posttraumatic stress disorder, substance abuse, phobias, social phobia, marital problems, and some personality disorders. Combined with pharmacotherapy, it is effective for the symptoms of bipolar disorder and even schizophrenia.

Recently, cognitive therapy has been used in medically related disorders, and there is substantial support for its efficacy in the treatment of chronic pain,

chronic fatigue syndrome, migraine headaches, and non-cardiac chest pain, among others.

IV. SUMMARY

Cognitive therapy is a form of psychotherapy that has been empirically supported in over 325 outcome studies for a variety of psychiatric disorders, psychological problems, and medical conditions with psychological components. It is based on the cognitive model: that individuals' interpretations and perceptions of current situations, events, and problems influence how they react emotionally, behaviorally, and physiologically. Treatment varies according to the cognitive formulation of patients' disorders and therapists' cognitive conceptualizations of specific patients. Generally, cognitive therapy is short term, structured, collaborative, educative, and focused on working toward specific behavioral goals, solving current problems, alleviating symptoms, and providing relapse prevention strategies.

See Also the Following Articles

Behavior Therapy: Historical Perspective and Overview ■
 Behavior Therapy: Theoretical Bases ■ Cognitive Appraisal Therapy ■ Cognitive Behavior Group Therapy ■ Cognitive Behavior Therapy ■ Eating Disorders

Further Reading

- Alford, B. A., & Beck, A. T. (1997). *The integrative power of cognitive therapy*. New York: Guilford Press.
- Beck, A. T. (1997). The past and future of cognitive therapy. *Journal of Psychotherapy Practice and Research*, 6, 1–10
- Beck, A. T., Freeman, A., Pretzer, J., Davis, D., Fleming, B., Ottaviani, R., Beck, J., Simon, K., Padesky, C., Meyer, J., & Trexler, L. (1990). *Cognitive therapy of personality disorders*. New York: Guilford Press.
- Beck, A. T., Rush, A. J., Shaw, B. F., & Emery, G. (1979). *Cognitive therapy of depression*. New York: Guilford Press.
- Beck, J. S. (1995). *Cognitive therapy: Basics and beyond*. New York: Guilford Press.
- Clark, D. A., Beck, A. T., & Alford, B. A. (1999). *Scientific foundations of cognitive theory and therapy of depression*. New York: Guilford Press.
- Clark, D. M., & Fairburn, C. G. (Eds.). (1997). *Science and practice of cognitive behavioral therapy*. New York: Oxford University Press.
- Salkovskis, P. M. (Ed.). (1996). *Frontiers of cognitive therapy*. New York: Guilford Press.
- Tarrier, N., Wells, A., & Haddock, G. (Eds.). (1998). *Treating complex cases: The cognitive behavioral therapy approach*. London: John Wiley & Sons.

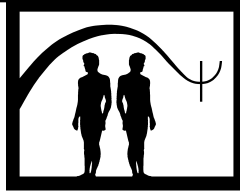

Behavioral Assessment

David C. S. Richard Stephen N. Haynes
Eastern Michigan University University of Hawaii at Manoa

- I. Description of Behavioral Assessment
- II. Theoretical Bases
- III. Goals and Objectives of Behavioral Assessment
- IV. Features of Behavioral Assessment
- V. Methods of Behavioral Assessment
- VI. Factors Affecting Inferences Made from Behavioral Assessment Data
- VII. Clinical Case Formulation
- VIII. Computers and Behavioral Assessment
- IX. Summary
- Further Reading

GLOSSARY

accuracy The correctness, precision, and exactness of psychological measurement.

antecedent event A stimulus or event that occurs prior to a response or subsequent event.

content validity The degree to which elements of an assessment instrument are representative of, and relevant to, the targeted construct for a specific assessment purpose. Applied to behavioral assessment, content validity refers to the degree to which a selected assessment method facilitates collection of data that are representative of behavior in the client's natural environment.

context (setting) A naturally occurring environmental unit having physical, behavioral, and temporal properties. The context may affect the response of an individual to presented stimuli, often through classical or operant conditioning.

dimension, of a behavior problem or causal variable A property of an event, or series of events, that can be quantified

(e.g., frequency, duration, magnitude, cyclicity, or rate of an event).

facets The components that contribute to an overall whole, as in facets of a construct or variable.

functional analysis The identification of important, controllable, causal functional relations relevant to the expression of a target behavior for an individual. The term also is used to describe the experimental manipulation of hypothesized controlling variables as a means of determining functional relations.

functional analytic clinical case model (FACCM) A vector graphic representation of a clinical case formulation. Causal relationships between variables are expressed using unidirectional or bidirectional arrows. Clinical case models visually express (1) the importance of a target problem, (2) relationships among target problems, (3) relationships between target problems and their effects, (4) the modifiability of antecedent or causal variables, (5) the clinical utility or importance of antecedent or causal variables, (6) the role of unmodifiable causal variables (i.e., original causal variables), and (7) the role of moderating variables. Path coefficient calculations suggest which causal variables, if modified, would likely lead to the greatest amount of change in the client's presentation.

functional relation A relation between two events that may be expressed in the form of an equation. A functional relation does not imply a causal relation. Examples of a functional relation include the conditional probability that one event may occur given another event (e.g., permitting a child to play a video game after his or her homework is completed), covariation between two events (e.g., the correlation between increased heart rate and self-reported distress during an imaginal exposure trial), and the identification of

controlling variables for a behavior problem through experimental manipulation.

idiographic assessment An assessment strategy emphasizing the individual or individual case. Idiographic assessment procedures often are not standardized, and observed relations and results are not necessarily generalizable across persons or groups.

level of inference (specificity) The number of elements or components subsumed by the variable label. An example of a higher level construct is “depression” since the label subsumes multiple lower-level phenomena such as motoric slowness, sad affect, insomnia, eating disturbances, and other more specific variables.

nomothetic assessment An assessment strategy in which judgments are based on the comparison of measures from the target person with data on the same instrument gathered from other persons, such as the use of normative or comparison groups.

phase-space relationship The expected, or realized, time-course context of a variable. The phase state of a variable is its historical and projected curve at the time of measurement.

reactive effects The degree to which the behavior of an observed individual is modified by the assessment method.

response class A group of behaviors that are topographically dissimilar yet produce the same functional effect.

response contingency A conditional relationship between two variables such that the occurrence of one variable or event is dependent on the occurrence of the other variable or event.

response mode The form, type, or method of behavior. Response modes are organizational categories or a taxonomy of behavior. Response modes can include motor, verbal, cognitive, and physiological events (or a combination of these, such as emotion).

state of a variable The current level of the variable when measured. Unlike the phase of a variable, the state does not provide information on the variable’s historical course.

stimulus class A set of topographically dissimilar stimuli that evoke either the same behavior or a set of behaviors that have similar functions.

target behavior A response, or response class, that has been selected by the clinician for measurement and modification.

treatment utility The degree to which data from one or more assessment instruments, or from a model of clinical case formulation, are associated with increased treatment effectiveness.

I. DESCRIPTION OF BEHAVIORAL ASSESSMENT

Within the broad scope of psychological assessment, behavioral assessment is distinguished by its emphasis on empirically supported, multimethod, and multi-informant assessment of precisely defined, observable behaviors. Consistent with respondent, operant, and

social learning traditions, behavioral assessment emphasizes the measurement of contemporaneous causal variables and environmental response contingencies using empirically validated assessment instruments. Thus, behavioral assessment includes a family of methods and instruments that measure behavioral change through direct and indirect observation of clients’ behavior problems and the variables that maintain those problems. While the variables that cause or maintain a client problem often reside in an individual’s external environment, assessment of covert events (e.g., cognitions, physiological responses) have been incorporated within a behavioral assessment framework.

In pretreatment applications, data collected during behavioral assessment must be synthesized by the clinician and this synthesis, in the form of a behavioral clinical case formulation, often guides treatment selection. Clinical case formulations are a series of hypotheses that may be evaluated in light of an ongoing clinical information collection process. As such, behavioral assessment is an iterative process—it is an ongoing, hypothesis-testing approach to clinical assessment. Assessment methods and resulting clinical judgments may be adapted to new information that causes the clinician to reevaluate initial hypotheses of client functioning (see Fig. 1). Contemporary behavioral assessment emphasizes the dynamic and contingent relationship between assessment, clinical case formulation, hypothesis testing, and intervention.

II. THEORETICAL BASES

Behavioral assessment is an integral adjunct to behavior therapy and, like behavior therapy, evolved from basic behavioral research. Behavioral psychology has frequently been divided into two related models of learning: respondent conditioning and operant conditioning. Early work in respondent conditioning demonstrated that both humans and nonhumans learned new behavioral responses as a function of the association of extrinsic stimuli. Early in the twentieth century, Ivan Pavlov showed that dogs could learn new reflexive behavior after being presented with a series of paired stimulus associations. Shortly thereafter, John B. Watson and Rosalie Rayner showed that, in humans, emotional responding to a previously neutral stimulus could be acquired by pairing a neutral stimulus with a loud noise. Treatment methods based on respondent conditioning principles would later be refined by Mary Cover Jones, Joseph Wolpe, and others.

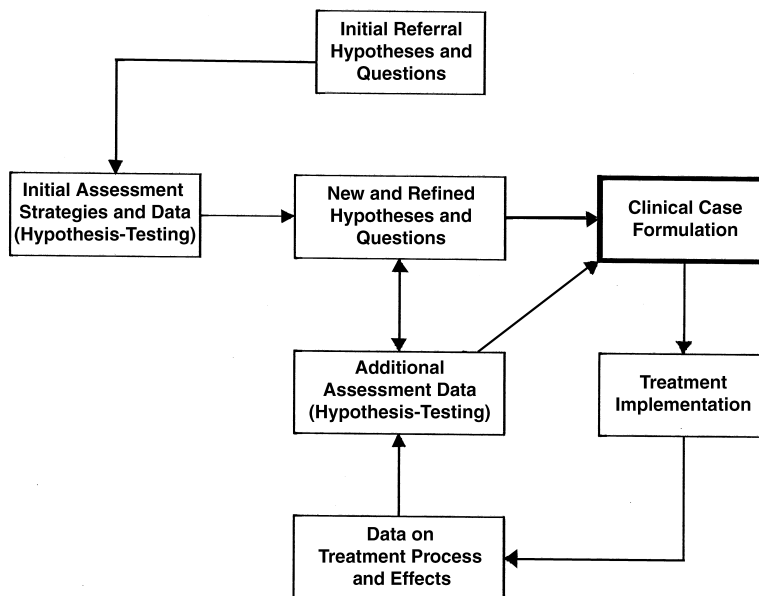

FIGURE 1 A dynamic model of behavioral assessment. Adapted from Haynes and O'Brien (2000), *Principles and practice of behavioral assessment*. New York: Kluwer Academic/Plenum Publishers.

The operant, or instrumental, model of learning is illustrated by the work of E. L. Thorndike and B. F. Skinner. Thorndike found that learning occurred when behavior was instrumental in, or had the effect of, achieving a reward (e.g., cats would learn a novel behavior if the effect of engaging in the behavior was instrumental in acquiring food). Thorndike called this principle “the Law of Effect.” Skinner extended Thorndike’s work by identifying the effects of specific types of consequences on behavior. According to Skinner, reinforcing consequences increased the rate of behavior while punishing consequences decreased the rate of behavior. Behavior that was not reinforced eventually was extinguished from the animal’s repertoire and the rate of extinction depended on the organism’s reinforcement schedule history.

Behavioral principles, initially studied in animal laboratories, formed the foundation of behavior therapy and have guided the development of behavioral assessment methods. Because antecedent events and response contingencies shape and affect an individual’s behavioral repertoire, a goal of behavioral assessment is to identify those events and contingencies that maintain behavior. Antecedent events and response contingencies that maintain the rate of behavior are called controlling or maintaining variables. The identification of controlling variables and their relationship to the target behavior is called a functional analysis. Thus, an important goal of behavioral assessment is to identify

variables that maintain a target behavior (i.e., the behavior to be modified) in a functional analysis.

For example, behavioral assessment with a Vietnam veteran diagnosed with posttraumatic stress disorder might identify certain conditional stimuli (e.g., the sound of a truck backfire, the whir of helicopter blades) as having a high probability of eliciting flashbacks and emotional responses because of their similarity to, or association with, aversive historical events. Operant responses may initially help the client cope with anxiety (e.g., drinking alcohol to induce intoxication and facilitate avoidance). Thus, a two-factor model of the patient’s behavior incorporating both respondent and operant principles would form the basis of a functional analysis for the patient (see Mowrer’s 1947 work).¹

III. GOALS AND OBJECTIVES OF BEHAVIORAL ASSESSMENT

The primary objectives of behavioral assessment include identifying (1) target behavior problems (i.e., the problems that are to be modified) and establishing

¹ Whereas Mowrer emphasized a two-factor model of conditioning, contemporary behavioral models stress the importance of family functioning, biological determinants, cognition, cultural processes, and other factors when assessing functional relations.

TABLE 1
Goals of Behavioral Assessment

-
1. Supraordinate goal: Increase the validity of clinical judgments
 2. Obtain informed consent from client
 3. Select an appropriate assessment method (e.g., direct observation, indirect observation, psychophysiological measurement)
 4. Determine if consultation and referral are appropriate (e.g., determine if medication consultation with a psychiatrist is appropriate when working with a child diagnosed with attention deficits)
 5. Development of a clinical case formulation
 - a. Identify behavior problems and their interrelations
 - b. Identify causal variables and their interrelations
 6. Design of intervention programs
 - a. Identify client intervention goals and strengths
 - b. Identify variables that may moderate intervention effects (e.g., occupational status, family support, other life stressors)
 - c. Assess client knowledge of goals, problems, and interventions
 - d. Evaluate any medical complications that could affect intervention process or outcomes
 - e. Identify potential side effects of intervention
 - f. Assess acceptability of intervention plan for client
 - g. Assess time and financial constraints of therapist and patient
 7. Intervention process evaluation
 - a. Evaluate intervention adherence, cooperation, and satisfaction
 - b. Evaluate client–therapist interaction and rapport
 8. Intervention outcome evaluation (immediate, intermediate, and ultimate intervention goals)
 9. Diagnosis (behavioral assessment strategies can be used to increase the validity of information on which diagnosis is made)
 10. Predicting behavior (e.g., dangerousness and self-harm assessment)
 11. Informed consent (i.e., inform clients and other relevant parties about the strategies, goals, and rationale of assessment)
 12. Nonclinical goals
 - a. Theory development (e.g., evaluating learning models for behavior problems)
 - b. Assessment instrument development and evaluation
 - c. Development and testing of causal models of behavior disorders
-

Note. Table adapted from Haynes & O'Brien (2000), *Principles and practice of behavioral assessment*. New York: Kluwer Academic/Plenum Publishers.

whether the problems involve behavioral excesses or deficits; (2) causal and moderating variables that influence target behavior dimensions; (3) immediate,

intermediate, and ultimate intervention goals; and (4) any adaptive or appropriate alternative behaviors to the target behaviors. In addition, behavioral assessment data form the foundation for a functional analysis, suggest appropriate intervention strategies, can be used to evaluate ongoing intervention efforts, may identify therapy process variables that can affect treatment outcome, and can inform diagnostic decision making. Table 1 outlines the multifaceted goals of behavioral assessment.

The supraordinate goal of behavioral assessment is to increase the validity of clinical judgments to facilitate clear formulation and treatment selection. Ultimately, the formulation should have treatment utility. Treatment utility is the degree to which data from one or more assessment instruments, or from a model of clinical case formulation, are associated with increased treatment effectiveness.

The selection, evaluation, and refinement of treatment goals and strategies can be among the most complex and vexing tasks that clinicians face. Haynes, Leisen, and Blaine in 1997 reviewed 20 studies that examined the relationship between components of a functional analysis and treatment outcome. They found that the studies were moderately supportive of the treatment utility of a functional analysis but that methodological limitations limited the inferences that could be drawn from the studies. At the very least, it is reasonable to assume that interventions are more likely to be effective if there is a close relationship between the causal variables identified in the preintervention assessment and those variables targeted for modification during the intervention.

Although an accurate functional analysis is a goal of behavioral assessment, factors other than the functional analysis can influence client responsiveness to treatment. Examples of other factors that can affect treatment outcome include the quality of treatment delivery, cooperation of persons in the client's environment, the client's cognitive and physical limitations, cultural and ethnicity factors, the developmental level of the client, and therapist–client rapport. Because so many factors may affect treatment outcome, isolating the putative effects of a functional analysis on treatment outcome is difficult.

Information collection can only occur in the context of a fully informed client who understands the rationale and strategies of the assessment. The goals of assessment and treatment should be carefully discussed with the client when possible and should reflect a cooperative approach. In addition, the clinician should discuss with the client hypotheses of functional relations operating in the client's life.

IV. FEATURES OF BEHAVIORAL ASSESSMENT

A. Assessment Strategies

Behavioral assessment emphasizes repeated measurement, quantification, multimethod and multimodal assessment, and assessment of behavior as it occurs naturally. Although assessment of behavior on just one occasion may provide an estimate of its current state, it does not provide information regarding changes in behavioral patterns over time, or the phase of the behavior. For example, how a therapist interprets a Beck Depression Inventory (BDI) score of 25, which suggests clinical levels of depression, depends significantly on the previous week's BDI score and the pattern of BDI scores over previous sessions. If a score of 25 represents a 10-point drop from the client's last BDI results, the clinician might infer that the depression may be less severe today than it was a week ago. However, a 10-point change in the opposite direction would be interpreted quite differently.

Interrupted time series designs are sometimes used in behavioral assessment to assess state–phase relationships. These strategies emphasize repeated measurement of behaviors, assessment of at least one causal variable across time, and systematic manipulation of hypothesized causal variables. They are powerful designs for measuring both the state and the phase of a behavior and assessing cause–effect relationships between a behavior and its hypothesized maintaining variables.

The behavioral assessment paradigm also emphasizes data quantification—the assignment of numbers to variables targeted in an assessment. For example, assessors may obtain measures of a client's self-reported level of anxiety in group social situations using a subjective units of distress scale. Measures might also include the frequency with which one marital partner compliments another during a problem-oriented discussion, the proportion of times a child's self-injurious behavior is followed by attention from a teacher, or blood pressure readings obtained during exposure to laboratory stressors. Although qualitative information and judgments are always part of a behavioral clinical case formulation, quantified data are very useful in time series assessment, can help identify functional relations, and facilitate the evaluation of treatment effects. Quantified data can also be presented in graphical form to facilitate inferences regarding behavior change.

In order to minimize error and make informed hypotheses about client functioning, behavioral assessment emphasizes repeated measurement across multiple as-

essment instruments, informants, contexts, settings, and response modes (e.g., behavioral, physiological, cognitive). The rationales for these strategies are (1) clients often behave differently across situations as a function of contingencies and contexts associated with each situation; (2) multiple measures across time help capture the dynamic nature of behavior and functional relations; and (3) informants differ in their source of information about a client and data from each informant may include unique sources of measurement error. Overall, these assessment strategies help reduce the effect of measurement error from any single information source.

The emphasis on multimodal assessment recognizes that different response modes (e.g., behavioral, physiological, cognitive) may demonstrate different time courses, may vary in their responsiveness to hypothesized causal variables, and may differ in their response to a therapeutic intervention. For example, combat veterans treated with exposure techniques (e.g., imaginal exposure, systematic desensitization) for posttraumatic stress disorder often report reduced nightmares and intrusive thoughts; however, little or no change may occur in other modes of responding. Thus, changes in one mode may not necessarily be accompanied by commensurate changes in another mode if the modes are controlled or maintained by different variables.

The emphasis on environmental variables means that behavioral assessment emphasizes a social-systems view of behavior problems—client behavior problems can best be understood by taking into consideration medical, family, work, cultural, religious, and other social systems. For example, a case formulation of a child with aggressive behavior problems may need to take into account contextual cues that evoke hitting and other aversive behaviors. However, a comprehensive case formulation might also include consideration of the quality of parenting practices or whether the educational setting is structured in a way that positively facilitates a teacher's ability to manage the child's aggressive behaviors. A successful intervention to reduce the aggressive behaviors of such a child might involve family therapy and intervention within the structure of the classroom in addition to traditional behavior management strategies.

B. Behavior Problems, Levels of Analysis, and Behavioral Dimensions

Often, the initial task of the behavioral assessor is to identify and specify the client's behavior problems, most often on the basis of client self-report or the report of a

referral source (e.g., a teacher, counselor). To guide initial intervention foci, behavior problems are ordered in terms of importance. In many cases, consultation with the client will facilitate selection of the most important target behaviors. However, when the client is not able to provide meaningful information about the relative importance of behavior problems (e.g., clients with cognitive limitations), behaviors that are dangerous to the client or to others are often selected as the first intervention target.

The level of specificity of a behavior problem refers to the number of elements or component behaviors that are subsumed by the variable label. Behavior problems characterized by low specificity are molar in their construction and subsume one or more behavioral facets. For example, the diagnostic construct major depression is a molar level construct that includes several observable, and more specific, behavior facets such as changes in eating and sleep patterns and low rates of pleasurable activities. Behavior problems with greater specificity have fewer clinically important facets, require less inference for observation, and often are more amenable to behavioral assessment methods and measurement.

Measurement of behavior implies measurement of one or more dimensions of behavior. A behavioral dimension is a property of an event, or series of events, that can be quantified. The dimension most often modified in a behavioral treatment program is rate, or the frequency of behavior per unit of time. For example, although the ultimate goal of an overweight client might be to lose weight, the immediate goal may be to decrease daily high caloric snacking and increase the frequency of daily exercise. Treating a child with autism often means decreasing the rate of self-injurious behaviors while increasing development and frequency of self-help skills. Behavioral marital therapy might include decreasing the rate of negative or sarcastic remarks while increasing the rate of proactive verbal communication and problem-solving.

Other dimensions often measured in behavioral assessment include (1) the magnitude or intensity of the behavior (e.g., decreasing the intensity of a fear or anxiety response); (2) the duration of the behavior (e.g., decreasing perseveration on a task, increasing time studying, increasing time in the presence of a feared stimulus); (3) the latency of behavioral responses (e.g., decreasing response time to a stimulus); (4) interresponse time (e.g., the time between two instances of a response; for example, the time between two instances of a child's disruptive behavior in a classroom); and (5) qualitative aspects including the physical features of the behavior or its topography (e.g., the types of errors

a child with a stuttering problem makes) and acceptability (e.g., whether the behavior is appropriate in a given social context, whether the behavior is compatible with societal expectations or laws, or the client's own moral standards). An important task of the behavioral assessor is to identify which of the above response dimensions is the most appropriate dimension to modify and to design an assessment plan that facilitates accurate measurement of that dimension.

Finally, responses must be recorded in some way using a reliable and accurate data coding system. The most common recording systems include paper-and-pencil forms, electromechanical devices, audio and video recording, and computerized data entry. Data collected during self-monitoring is often recorded in a journal or self-monitoring diary. Psychophysiological data are frequently recorded using a polygraph machine. Even with highly standardized assessment methods, reliability and accuracy of recording should not be assumed. Reliable and accurate measurement of behavior is as much dependent on the definition and level of specificity of the variable being measured as it is on the methods by which the behavior is recorded.

V. METHODS OF BEHAVIORAL ASSESSMENT

A distinctive feature of the behavioral assessment paradigm is the variety of assessment methods available to the behavioral assessor. Table 2 provides a listing of common behavioral assessment methods. We now introduce each behavioral assessment method, discuss examples of the behavioral assessment method drawn from the empirical literature, and review factors that affect the validity of inferences that are derived from each behavioral assessment method.

A. Behavioral Observation

1. Naturalistic Behavioral Observation

Naturalistic behavioral observation is a behavioral assessment method in which an individual is observed in his or her natural environment (e.g., home, school, work), usually in a context that is most associated with a problem behavior. Typically, observations are made on a predetermined schedule by one or more observers. A time sampling interval is determined *a priori* (e.g., 20-second periods, 5-minute periods) and the observer records the occurrences of the target behavior and/or other relevant events during the interval. Multiple observers are often used and percentage agreement or

TABLE 2
Behavioral Assessment Methods

Method	Types and descriptions	Instruments and measurement devices
Behavioral observation	Naturalistic behavioral observation involves measurement of overt behavior in the individual's natural environment. <i>Example:</i> Observe a child's behavior in a classroom or at home. Analogue behavioral observation involves the measurement of a client's overt behavior in a contrived situation that is analogous to situations the client is likely to encounter in his or her environment. <i>Example:</i> Code marital interactions during a marital therapy session.	Child Behavior Checklist Direct Observation Form; Revised Edition of the School Observation Coding System; Marital Interaction Coding System.
Behavioral rating scales	Completed by individuals who are either familiar with a client's behavior or have the opportunity to directly observe a client's behavior. <i>Example:</i> Have a parent and teacher complete a child behavior checklist.	Child Behavior Checklist; Motivation Assessment Scale.
Self-monitoring	Systematic self-observation and recording of parameters (e.g., frequency, intensity) of targeted behaviors, environmental events, cognitions, and/or mood states. <i>Example:</i> Have a client diagnosed with anorexia nervosa complete an eating diary after each meal.	Self-monitoring forms are usually individually tailored to an individual's target behavior problem(s).
Psychophysiological assessment	Measurement of physiological and motoric components of behavior problems using a variety of measurement devices, especially electromyographic, EEG, cardiovascular, and electrodermal measures. <i>Example:</i> Record heart rate, galvanic skin response, and blood pressure of trauma survivor while the client listens to a script recounting the traumatic event.	Polygraphs, heart rate monitors, amplifiers are available through several commercial companies.
Self-report	Behavioral Interview: A structured or semistructured interview that assesses dimensions of a client's behavior, behavior–environment interactions, behavioral contexts, and the functional relation of the behavior(s) with other controlling variables. <i>Example:</i> Interview inmates in a residential drug treatment facility using the Drug Lifestyle Screening Interview (see Walters, 1994). Behavioral Questionnaire: A measurement instrument completed by the client, or individuals that know the client well, that assesses (1) behavioral dimensions and (2) functional relations of behaviors with cognitions, emotional states, and other controlling variables. <i>Example:</i> Have a client complete the State and Trait Food Cravings Questionnaire to identify conditions under which food cravings occur and the cues that elicit cravings.	Functional Analysis Interview Form; Drug Lifestyle Screening Interview; Alcohol Use Inventory Motivation Assessment Scale; State and Trait Food Cravings Questionnaire

other statistics are calculated (e.g., kappa) to ensure reliable data recording.

Naturalistic behavioral observation has been used as an assessment method to assess a wide array of behaviors. For example, Gulley and Northrup in 1997 observed two

children diagnosed with attention deficit–hyperactivity disorder (ADHD) in their classrooms and systematically varied each child's daily dose of methylphenidate (MPH). By observing multiple, operationally specific behaviors over time (e.g., social behavior, disruptive behavior,

efficiency at solving math problems, responses to comprehension problems), they were able to show the dosage level of MPH that was associated with the greatest improvement across behaviors. Teacher ratings corresponded with the academic, behavioral, and social measures for one participant, but not the other, suggesting that teacher ratings were not necessarily sensitive to changes in behavior as a function of medication dose.

Data collected using naturalistic behavioral observation can be affected by both participant-related and observer-related error variance. On the participant side, reactivity to the assessment method can change the rate of a participant's behavior and make it less likely that observed behavior reflects behavior as it naturally occurs in the environment. Reactivity effects are discussed in more detail at the end of this section.

Observer-related error variance can affect the accuracy of observations in a potentially endless number of ways. For example, the degree of observer training can affect observer reliability and accuracy. Cumbersome recording forms or poorly operationalized behaviors can lead to unreliable coding. Raters can "drift" in their ratings if their understanding or application of coding rules decays over time. Other observer-related factors include observer attentional lapses during recording intervals, contamination of data if an observer is aware of another observer's recordings, errors in time-sampling parameters (e.g., frequency and duration of the time-sampling parameters are incongruent with the dimensions of the observed behavior), behavioral sampling errors (e.g., an important behavior is not included in the behavioral coding system), and observer knowledge of patient status. Frequent accuracy checks of observer ratings should be made by an independent auditor to ensure that observer agreement indices do not fall below an acceptable level (e.g., .80). If the accuracy of an observer's ratings is below the criterion, retraining should be initiated.

The validity of inferences drawn from naturalistic observation also depends on the choice of observation setting. As a general rule, observation should occur in situations where the problem behavior is most likely to occur. Because the dimensions of behavior often vary across situations and contexts, selecting the most relevant naturalistic setting for observation is an important decision.

How the data are aggregated and displayed can have a significant bearing on the validity of inferences as well. Naturalistic behavioral observation data may provide useful information when data are aggregated across many minutes but not in shorter intervals, and vice versa. In addition, how the data are interpreted af-

fects the validity of inferences that are made. A common interpretive strategy for observational data is to graph data and intuitively interpret the results. O'Brien in 1995 showed, however, that individuals using intuitive estimation methods often underestimate the magnitude of highly correlated variables and overestimate the magnitude of weakly correlated variables.

2. Analogue Behavioral Observation

Analogue behavioral observation is a behavioral assessment method in which a clinician observes a client's behavior in a contrived environment (e.g., a waiting room, play room, clinical setting) to assess variables hypothesized to influence behavior. Although analogue assessment is a direct measure of behavior, the target behavior is observed outside of the individual's natural environment. A special section of the journal *Psychological Assessment* (Vol. 13, No. 1) is devoted to a discussion of analogue behavior observation.

There are several classes of analogue behavioral assessment. Each class includes many different instruments for measuring behavior. A role-play is an analogue behavioral assessment class in which a client performs one or more behaviors in a contrived social situation. An experimental functional analysis is a structured observation session in which clients are observed while variables hypothesized to control or maintain a target behavior are systematically introduced and withdrawn. Family and marital interaction tasks is a class of analogue behavioral assessment in which members of a familial unit interact with one another on a task specified by the assessor that is relevant to the family or couple. Behavioral avoidance tests are often used to assess a person's response to a feared stimulus by measuring proximity to the stimulus (e.g., how close, in feet, a person with a snake phobia can come to a snake in a glass cage) or other approach behavior.

Other analogue behavioral observation techniques include enactment analogues, in which the individual is observed performing a newly acquired skill; contrived situation tests, in which a novel situation is presented to an individual to determine whether the individual can apply newly learned skills; think-aloud procedures, in which a person reports his or her thoughts during performance of a behavior; and response generation tasks, in which an individual engages in, or generates, one or more response options to a stimulus event. Variants of analogue behavioral observation have been used to assess a wide array of behavioral problems and phenomena. Hundreds of studies have employed the technique to assess marital interactions, child behavior

problems, adult social functioning, and countless other behavioral disorders.

The utility of the analogue observation in helping the clinician generate hypotheses about functional relations depends on the degree to which the analogue context includes the elements that affect the behavior problem in the natural environment. For example, McGlynn and Rose in 1998 observed that anxious patients usually fear stimulus classes, rather than a single stimulus, and that one analogue session would be unlikely to include the myriad of feared stimuli present in the client's natural environment. Analogue behavioral observation is most likely to be a cost-effective alternative to naturalistic behavioral observation when the targeted behavior(s) occurs with high frequency in the analogue situation and is not reliably or accurately measured using other less costly assessment methods (e.g., questionnaires, rating scales).

Analogue observation sessions are more likely to provide important information regarding functional relations than behavioral rates. For example, couples may exhibit a higher frequency of negative comments toward one another during an initial assessment interview than they would at home where they could more easily avoid their spouse or partner. Alternatively, behaviors that occur only in private contexts may not occur at all in an analogue situation (e.g., battering, verbal threats). Researchers have long noted that partial-interval recording in analogue settings underestimates high rate responding, does not produce valid estimates of behaviors of short durations, and can misrepresent temporal relationships between behaviors and events.

The novelty of the assessment environment may make it more likely that irrelevant behaviors, rather than the target behavior, are observed. For example, a child who is defiant toward his parents may be stimulated by unfamiliar objects and toys in an observation room and may not interact with a parent as a result. Nonetheless, role-play activities may still permit observation of related variables and their dimensions (e.g., tone of voice, eye contact, frequency of reflective statements made by each partner).

All forms of analogue behavioral assessment require a coding or rating system in which the assessor quantifies a dimension of behavior. For example, Heyman and Vivian in 1993 developed the Rapid Marital Interaction Coding System (RMICS) to facilitate analogue observation of marital communication styles. In 2001 Heyman and colleagues found that observation periods as brief as 15 minutes were sufficient to obtain stable estimates of most RMICS codes in maritally distressed couples. However, in happily married couples, some variables

and behaviors (e.g., dysphoric affect, withdrawal) were observed too infrequently to be reliably coded in brief laboratory interactions.

Analogue behavioral assessment methods and their respective coding systems have generally not been subjected to the type of psychometric rigor common for other psychometric instruments. For example, reports of analogue assessment methods often do not include information about (1) the goals of the analogue assessment, (2) the specific behaviors, functional relations, constructs, and facets to be measured, (3) the response modes and dimensions to be measured, (4) the methods of data collection, (5) how the specific scenarios, situations, and instructions might affect client behavior, or (6) a discussion about how dimensions of individual differences (e.g., sex, religion, age, ethnicity, sexual orientation) might influence responses. One of the major difficulties in evaluating the usefulness of analogue assessment, especially in the assessment of child behavior problems, is the lack of standardization demonstrated by most available measures.

Closely related to standardization is the issue of reliability, or consistency of measurement. The reliability of analogue behavioral observation coding systems is generally not well studied. For example, one researcher concluded that only 20% of published marital communication studies included reliability information for the constructs that were studied. Another researcher concluded that no test-retest reliability data are available for parent-directed-play coding systems or free-play behavior coding systems.

Additionally, the external validity of most analogue assessment measures has not been well investigated. External validity, in the analogue context, is the degree to which behavior observed in the analogue setting is representative of the client's behavior in his or her natural environment. Norton and Hope in 2001 concluded that the evidence concerning the external validity of role-play methods is "equivocal" and data on the external validity of other analogue assessment classes are either insufficient or absent.

B. Behavioral Rating Scales and Behavioral Checklists

A behavioral rating scale is an assessment instrument completed by a clinician or a third party (e.g., significant other, teacher, parent, peer) that includes items that assess one or more targeted client behaviors. A behavioral checklist is similar to a behavioral rating scale but often includes fewer items and may include dichotomously scored response options. Many behavior

rating scales and behavioral checklists have been standardized using a normative sample of individuals and aggregate raw data into standardized scale scores or global scores.

Behavioral rating scales are frequently divided into two classifications: narrow band behavior rating scales and broad band behavior rating scales. Narrow band behavior rating scales include items that sample from a small number of domains and are not intended to be global measures of an individual's behavior. Broad band behavior rating scales usually include more items, sample from a wider spectrum of behaviors, and are often used to screen for more than one disorder or behavioral syndrome.

For example, behavioral checklists and behavioral rating scales are the most popular methods of gathering information in assessing ADHD. Narrow band measures include the 55-item Social Skills Rating System, which divides item content into three narrow domains: problem behaviors, social skills, and academic competence. Another narrow band instrument is the Disruptive Behavior Rating Scale (DRS). The DRS includes item content covering oppositional defiant disorder, ADHD, and conduct disorder. Broad band behavioral rating scales include the Child Behavior Checklist (CBCL) and the Conners Parent and Teacher Rating Scales. Both the CBCL and the Conners Scales provide several scale scores and include versions for parents, teachers, and youths to complete. The popularity of these behavioral assessment methods can be attributed to their cost-efficiency, ability to quantify the opinions of important persons in a client's life, and their ease of administration. In addition, the most widely used instruments (e.g., the CBCL) rest on an extensive foundation of empirical literature that testifies to their reliability and validity.

Although behavioral rating scales and behavioral questionnaires are popular, it should be emphasized that they are indirect measures of behavior. As indirect measures, data collected using behavioral rating scales and behavioral checklists reflect a rater's retrospective impression of a client's behavior rather than an objective recording of the rate at which behavior occurs, as with naturalistic behavioral observation methods. Consequently, all behavioral rating scales and behavioral checklists are subject to rater bias regardless of the rigor with which the instrument is designed. Although indirect observation of behavior can be useful in behavioral assessment, its limitations need to be understood by the behavioral assessor.

In addition to being indirect measures of behavior, behavior rating scales and behavioral checklists rarely provide information pertaining to the functional relations of variables. Most behavior rating scales and behavioral checklists include items that measure topographical behavioral dimensions rather than functional relations. To some degree, the contextual variability of behavior can be addressed by having multiple informants complete the instrument provided each informant observes the client in different contexts (e.g., having a parent and a teacher complete the same rating scale). A thorough functional assessment, however, requires greater attention be paid to other variables that may be maintaining the behavior (e.g., the type of reinforcement received for an oppositional behavior; whether the problem behavior results in avoidance of an aversive event or situation).

C. Psychophysiological Assessment

Psychophysiological assessment involves recording and quantifying various physiological responses in controlled conditions using electromechanical equipment (e.g., electromyography, electroencephalography, electrodermal activity, respiratory activity, electrocardiography). Which response or response system is measured depends on the purpose of the assessment. Psychophysiological measurement has been used to assess autonomic balance (e.g., heart rate, diastolic blood pressure, salivation), habituation to environmental stimuli, reactivity to traumatic imagery, orientation response, and other physiological systems.

Frequently, the behavioral assessor is not so much interested in the behavior measured by the equipment as what may be inferred from the behavior. For example, a large literature exists with regard to the psychophysiological measurement of responses to anxiety-eliciting stimuli. Keane and co-workers in 1998 showed that male military veterans with posttraumatic stress disorder (PTSD) exhibited greater changes in psychophysiological responding (i.e., increased heart rate, skin conductance, systolic and diastolic blood pressure) when presented a series of trauma-related cues than did veterans without PTSD. Other studies have found increased physiological responsivity in females with PTSD and increased heart rate responses to startling tones in individuals with PTSD.

Selection of the eliciting stimulus, or stimuli, and the response modes to monitor during a psychophysiological assessment are important considerations, especially when investigating responses to trauma-related cues.

For example, research has consistently shown that individuals are more physiologically reactive to scripts detailing their own personal experiences than to standardized scripts detailing either neutral scenes or traumatic situations. Synchronous responding to stimuli across physiological modes has not, however, been generally observed. For example, Blanchard, Hickling, Taylor, Loos, and Gerardi in 1994 found that heart rate and electrodermal activity, but not systolic or diastolic blood pressure, were responsive to audiotaped scripts describing a motor vehicle accident the participant survived.

All of these studies demonstrate how psychophysiological assessment can be used to identify behavioral differences in individuals, provide criterion-related validity for psychiatric diagnoses, and can be used as a clinical marker of client change since clinical improvement has been associated with changes in physiological indices. However, psychophysiological assessment is often cumbersome, expensive, and, depending on the client and his or her problems, may not provide information that sheds light on the functional relations of variables operating in a client's life. In addition, psychophysiological information does not inherently possess greater validity or is more objective than other behavioral assessment methods. Data from a psychophysiological assessment require interpretation in the context of convergent evidence from other assessment methods (e.g., a behavioral interview, analogue behavioral observation) in order for the information to be clinically meaningful.

D. Self-Monitoring

Sometimes neither naturalistic nor analogue behavioral observation methods are feasible. For example, a behavior may occur only in private (e.g., vomiting in a client diagnosed with bulimia nervosa), may not be directly observable (e.g., negative self-statements), may occur in contexts that cannot be easily observed in the natural environment (e.g., problematic interactions with a work superior), or may not be easily replicable in an analogue assessment context (e.g., group social gatherings). In these situations, clients may be asked to self-monitor their own behavior. Self-monitoring refers to any assessment method in which clients record observations of their own behavior to a recording form. While most self-monitoring studies have reported methodologies in which the client records data on a predetermined schedule (e.g., hourly, daily, when an event occurs), recent research has explored the use of electronic pagers,

wrist terminals, ambulatory measurement devices, and handheld computers to signal, and sometimes record, client behavior.

Most self-monitoring recording instruments are designed to maximize the chance of observing a functional relation between a behavior and an extrinsic variable. A common self-monitoring record is an A-B-C log. An A-B-C log is a serial record of the antecedent events (A) that occur prior to the behavior (B) and the consequences (C) or events that follow the behavior. A-B-C logs are useful in identifying environmental events that are functionally related with a problem behavior. Variants of the A-B-C log are the basis of most self-monitoring recording forms. For example, daily food records have been used by researchers studying clients diagnosed with bulimia nervosa. Daily food records typically provide space for the client to record the time of a meal, the food and liquid that was consumed, where the food was eaten, the type of eating event (e.g., meal, snack, binge, purge), and the circumstances surrounding the food intake. Some researchers have used a daily obsessional thought record to assess obsessions, mood, and other cognitive variables. Other recording formats include paper-and-pencil diaries and computerized diaries.

The accuracy of self-monitoring data can be affected by several factors. For example, one difficulty in having HIV-positive males self-monitor sexual behavior is that the activity of self-monitoring may affect rates of sexual behavior (i.e., reactivity to the assessment method). In addition, clients who are unlikely to comply with self-monitoring instructional sets should be assessed by other means. Eating disorders researchers have pointed out that clients with anorexia pose significant challenges for a self-monitoring assessment methodology. Clients with anorexia may distort their reports of caloric intake in order to mislead therapists and avoid negative consequences from family and friends. Thus, the validity of self-monitoring data may be affected by the type of eating disorder and the context of the monitoring. Clients who restrict their intake, and are keeping food diaries for themselves, are likely to be accurate in their recording. However, if the recording is in a treatment context, accurate recordings are less likely to occur because of the constellation of influences that could affect the client's report. Other variables that are known to affect the accuracy of self-monitoring data include the number of behaviors to be monitored, social desirability, demand characteristics, the length of the recording period, the client's awareness of accuracy

checks, availability heuristics, the client's emotional state when making a recording, and degree to which the client was trained in self-monitoring.

The wisdom of using self-monitoring techniques with children has also been questioned. Shapiro and Cole in 1999 concluded that children can be reliable monitors of their own behavior but that the technique frequently leads to reactive effects that can change the rate of behavior. Peterson and Tremblay in 1999 concluded that self-monitoring in children is likely to be inaccurate if the behavior is contrary to medical advice, when a behavior is supposed to occur but the child deliberately fails to perform it, when the behavior is socially inappropriate or embarrassing, when the child is not motivated to self-monitor behavior, or when the child may have difficulty monitoring the behavior (e.g., thumbsucking).

Several strategies may enhance both the accuracy of collected data and the probability of client compliance. For example, researchers recommend scheduling accuracy checks, selecting target behaviors that are not difficult to code and record (e.g., self-monitored motoric responses as opposed to verbal responses), training participants in self-monitoring, contracting with individuals, providing reinforcement contingent on accurate recording, providing a recording device that is unobtrusive, limiting the number of behaviors to be monitored, and selecting behaviors that have a positive rather than negative emotional valence.

E. Self-Report Instruments

1. Behavioral Interviews

A behavioral interview is a set of structured or semi-structured queries designed to elicit responses regarding (1) one or more overt target behaviors, (2) behavior–environment interactions, (3) the most relevant behavioral dimensions, and (4) relations of the behavior(s) with hypothesized maintaining variables. Behavioral interviews differ from traditional clinical interviews in that they are structured, focus on overt behavior and behavior–environment interactions, are sensitive to situational sources of behavioral variance, focus on current rather than historical behaviors and determinants, and define behavior at a molecular rather than molar level.

Behavioral interviews are sometimes cumbersome and time consuming to administer. However, the recent development of behaviorally oriented computerized assessment applications has made efficient collection of behaviorally relevant data less problematic. For exam-

ple, Albert Farrell has developed a computer program that helps both clinicians and clients assess client behavior problems and monitor treatment progress. Farrell's program has become a seamless part of the assessment procedures of a university clinic.

2. Behavioral Questionnaires

A behavioral questionnaire is a series of questions, often in Likert-type format, that include item content designed to assess the functional relations of extrinsic variables with a target behavior. In contrast to traditional clinical questionnaires, behavioral questionnaires usually include questions that assess antecedent events, the effects of the behavior problem, and acquire data on one or more behavioral dimensions. For example, Cepeda-Bineto, Gleaves, Williams, and Erath in 2000 designed a food cravings questionnaire with items that assess cues that trigger food cravings, positive reinforcement that comes from eating, relief from negative states as a result of eating, physiological states associated with hunger, and emotions surrounding food cravings and eating.

3. Issues in the Use of Self-Report Instruments

Behavioral assessors have historically been somewhat skeptical of the inferences made from self-report data. Objections include the role that client biases, memory errors, and other factors might play in degrading the accuracy of self-reports. However, some behavioral problems are difficult to observe directly and the client's self-report may be the only source of information concerning the dimensions of the target behavior. For example, Sobell, Toneatto, and Sobell in 1994 concluded that self-reports are a valuable, cost-efficient, and reasonable source of information when assessing patients with substance abuse problems. However, they issued the caveat that inaccurate self-reports are most likely to occur when (1) individuals may violate social conventions or the law by admitting to engaging in a behavior or (2) individuals are unable to provide accurate self-reports (e.g., a demented patient, a very young child).

Although behavioral questionnaires may be inexpensive to administer, have face validity for patients, and are easily scored, behavior therapists should be cautious when making inferences from instruments that are not developed from a behavioral framework. Traditional clinical questionnaires often yield global or aggregate scores that are insensitive to the conditional nature of behavior, the functional relation of behavior to antecedent events and consequences, and the variability of behavior across situations and contexts. In addition, variables are often defined at a molar level that is not

sensitive to variability of component behavioral facets. Many individuals exhibit discordance across response modes (i.e., behavioral, physiological, cognitive) while most self-report questionnaires produce scale or global scores that imply uniform responding.

Inferences drawn from questionnaire data are also attenuated by the fact that self-report and observer ratings often only modestly agree. For example, some researchers have reported significant mean differences between self- and peer-reported interpersonal problems. In one study reported in 1999, Handwerk, Larzelere, Soper, and Friman had parents of 238 troubled children complete the CBCL and the children complete the Youth Self-Report (YSR), the self-report version of the CBCL. They found that parental ratings of the frequency and intensity of their child's problem behaviors were over a standard deviation higher than the self-reports made by the children. The discrepancies were apparent across all scales, and in the same direction (i.e., parents > children) regardless of age, sex, site, and parent informant. These results suggest a lack of agreement of parent and child's appraisals of the child's behavior. Another implication is that the estimated severity of a child's behavior will depend on whether a clinician places more weight on a child's self-report or a parent's rating of the child's behavior. The assumption that responses to a questionnaire or behavioral interview accurately reflect dimensions of client behavior is generally not warranted. Inferences based on questionnaire and interview results should be cross-checked against data collected via other methods.

VI. FACTORS AFFECTING INFERENCES MADE FROM BEHAVIORAL ASSESSMENT DATA

All behavioral assessment methods include variance that is attributable to the behavior being measured and variance that is due to measurement error. The validity of clinical inferences can be affected by the content validity of an instrument, reactivity of individuals to the assessment process, and the degree of accuracy in measurement.

A. Content Validity

Content validity refers to the degree to which elements of an assessment instrument are relevant to and representative of the targeted construct. With regard to behavioral assessment, content validity refers to whether

the methods and instruments chosen for conducting the assessment capture all important aspects of client functioning. For example, in assessing a client complaining of depression, the inferences derived from the assessment would be limited to the degree that the assessor failed to assess the component facets of depression and the various modes of responding. A strategy that focused solely on identifying cognitions surrounding depressive symptoms might not identify important behavioral patterns (e.g., lack of activity) that contribute to the client's low mood. Thus, assessment strategies that incorporate multiple methods of information gathering across multiple modes of responding are likely to minimize error variance associated with any one assessment method.

B. Reactivity

Reactivity refers to changes in behavior that occur in a person who is being observed as a function of the assessment process. Reactivity effects can occur in all behavioral assessment methods and can lead to behavioral increases or decreases depending on the behavior that is being observed. Reactivity effects are often associated with the duration of observation, the amount of change in the environment associated with the observation, the identity of the observers, the amount of instructions provided subjects, the goals of assessment, and the methods of data reporting. Korotitsch and Nelson-Gray in 1999 suggested that variables affecting self-monitoring reactivity include the valence of the target behavior (desirable behaviors tend to increase in frequency), motivation for change, the topography of the target, the schedule of recording, concurrent response requirements, the timing of recording, goal-setting feedback and reinforcement, and the nature of the recording device. Reactivity may be mitigated or eliminated by allowing participants to habituate to the changes introduced to their environment because of the assessment procedure. For example, if a video recorder is introduced to a classroom, allowing the camera to be present for a few days before beginning measurements may allow children to habituate to its presence.

Emerging technological innovations can also minimize reactivity effects in some situations. For example, Boyce and Geller in 2001 reported a study in which the experimenters observed automobile driving behaviors by utilizing several hidden cameras strategically placed in a moving automobile. The cameras were the size of a pinhead and recorded what the driver saw on the road during a 45-minute drive, the driver's face,

the location of the driver's hands, and road markings on the highway. The four video channels were funneled to a quad-multiplexer that integrated the camera views and time stamped the videotape record. The video images were later coded in 15-second intervals for safe driving techniques (e.g., correct turn signal use, maintaining a safe following distance from another vehicle). The results showed that older participants engaged in less risky driving behaviors than younger participants. In addition, male drivers did not take more risks than female drivers, leading the authors to suggest that previous research suggesting greater risk-taking behavior by males may be an artifact of the self-report methods that were used.

C. Accuracy

Although many definitions of accuracy have been proposed in the behavioral literature, accuracy refers to the extent to which data collected during a behavioral assessment approximates the true state of nature. In behavioral assessment, accuracy is relevant to both the recording (i.e., data coding) and the reporting (i.e., interviewee responses) of behavior.

Accuracy may be attenuated in several ways. Researchers have long noted that accuracy of self-monitoring data can be affected by the response mode that is monitored (i.e., cognitive, motor, or physiological behavior). Low-frequency, overt motor behaviors appear to be more accurately recorded than high-frequency, verbal behaviors for most individuals.

Accuracy can also be affected by recorder bias. Recorder bias may result from a potentially endless number of factors: inattention, carelessness, poor training, errors in selection of intervals during which behavior is recorded, technical difficulties, and so forth. When multiple raters observe behavior, calculating the degree to which any one rater agrees with the other raters can help identify raters who may be systematically biasing their observations and, hence, their data.

Accuracy of reporting can fluctuate over time as a function of a variety of respondent variables. For example, Carr, Langdon, and Yarbrough in 1999 concluded that the accuracy of clients self-report is subject to (1) biased or inaccurate recall of behavioral occurrences and (2) the changing functions of behavior. In addition, modifying a client's recognition and understanding of a problem behavior may affect both rates of responding and the client's estimates of behavioral rates. For example, a client may not initially be aware of the environmental cues that reliably precede a panic attack (e.g.,

being in a public place). However, a functional analysis may make the client aware of a relationship between the behavior and the context and make it more likely that the client is able to cope with previously anxiety-eliciting situations. As a result, the client may experience a decrease in frequency of panic attacks.

VII. CLINICAL CASE FORMULATION

Ultimately, behavioral assessment must inform treatment planning and increase the probability that maximally efficacious treatments are implemented. The importance of developing a clinical case formulation based on assessment results has been recognized by workers endorsing diverse models of psychopathology. However, integration of assessment tools from diverse, and sometimes incompatible, theoretical models has not been successful.

Increasingly, clinical case formulation is being viewed by behavior therapists as a crucial contribution to successful treatment outcome. Recent volumes on clinical case formulation highlight the prominent role case formulation plays in treatment planning. However, appreciation for the importance of clinical case formulation in the behavioral paradigm is a relatively recent phenomenon. Behavioral models of clinical case formulation have focused on the identification of antecedent conditions and behavioral effects that maintain the target problem. Clinical case formulations have spanned a wide array of disorders and behaviors including transient tic disorder, delusional speech in schizophrenia, trichotillomania, obsessive-compulsive disorder, developmental disabilities, chronic cough, and borderline personality disorder.

However, the necessity of conducting a clinical case formulation, while intuitively appealing, remains a subject of some debate. Studies confirming the utility of an *a priori* case formulation are difficult to design for several reasons because numerous intervening variables that are extraneous to the case formulation can affect a client's behavior (e.g., client-therapist rapport, quality of treatment delivery, duration of the client's presenting problems, frequency and strength of the client's responses, response class parameters of the client's behavioral repertoire). Nonetheless, some authors have suggested that treatment outcome is more related to the accuracy of the clinical case formulation than to intervention strategies. For example, Persons, Curtis, and Silberschatz in 1991 proposed the formulation hypothesis, which suggested that successful treatment outcomes depends on the accuracy of the initial

case formulation, thereby elevating the role of clinical case formulation to a level on a par with, and even superior to, treatment delivery. Objections to the formulation hypothesis include the observations that (1) treatment outcome is affected by a wide variety of factors extrinsic to the therapeutic context, and (2) clients sometimes improve in the absence of a formal clinical case formulation.

A. The Cognitive-Behavioral Case Formulation Model

Jacqueline Persons and her colleagues have developed a cognitive-behavioral case formulation model (CB) that focuses on the identification of overt behaviors and the underlying cognitive mechanisms hypothesized to control the behaviors. The therapist works with the client to create a behavior problems list, a list of specific beliefs about himself or herself that may affect the client's behavior problems, and a list of external events and situations that activate core beliefs. From these data, a set of working hypotheses are developed regarding the functional relations of problem behaviors and maintaining variables. Causal mechanisms in CB are often presumed to be underlying cognitions and are assessed using a multiple-choice questionnaire.

Persons and her associates have found that clinicians trained in the CB show moderate agreement in their lists of clients' overt problems. Doctoral-level training, clinical formulation training, experience in cognitive-behavior therapy, and greater psychotherapy experience have been associated with better agreement in problem identification but not in identifying schemas that may be influencing the client's behavior.

B. A Problem-Solving Approach to Clinical Case Formulation

Whereas the model described by Persons and her colleagues emphasizes the identification of core schemas that underlie behavioral problems, Arthur and Christine Nezu have conceptualized assessment and therapy as a problem-solving process composed of the following components:

1. *Problem orientation*: The clinician conceptualizes the client's problem as multiply determined by psychological, biological, and social influences.
2. *Problem definition and formulation*: The clinician assesses the behavioral problem across multiple response modes (e.g., behavioral, cognitive, affective,

physiological) and contexts, considers historical and developmental information, and gathers data from standardized measures, behavioral observation, and psychophysiological measures.

3. *Generation of alternatives*: The clinician considers different treatment options and creates a list of possible target variables, solutions, and interventions.
4. *Decision making*: The clinician evaluates the clinical utility of each treatment and selects the one that is likely to be most effective for the client.
5. *Solution implementation and verification*: The clinician works with the client using the selected treatment option and assesses outcome.

A visual summary of the case formulation is provided by means of a clinical pathogenesis map. The map is a flow diagram summarizing the relationship between stressful events, historical factors, contemporaneous events, and behavior problems.

C. Functional Analytic Clinical Case Modeling

Another case formulation model has been developed by Stephen Haynes and his colleagues. A functional analytic clinical case model (FACCM) is a means of schematically representing a functional analysis² using vector graphic diagrams, as discussed by Haynes, Leisen, and Blaine in 1997. FACCM variables include original causal variables, causal variables, moderating variables, client behavior problems, and effects of client problems. Original causal variables are variables that affect client behavior, either directly or through their effects on other causal variables, and are not modifiable (e.g., events that happened in the past, medical conditions). Causal variables are variables that affect the client's problems and are presumed to be modifiable. Client problems are behaviors or cognitions exhibited by the client that are evoked or maintained by causal variables. Finally, the effects of client problems are events or processes that follow, and may be consequences of, client problems. In addition to identifying the above variables, FACCMs communicate the hypothesized strength of each variable in the model,

² The definition of the term "functional analysis" varies within behavioral psychology and across disciplines that use behavioral principles. In applied behavior analysis, the term refers to the systematic manipulation of variables to estimate functional relations. We use Haynes and O'Brien's more broad use of the term in 1990 to refer to the identification of "important, controllable, causal and noncausal functional relations applicable to specified behaviors in the individual."

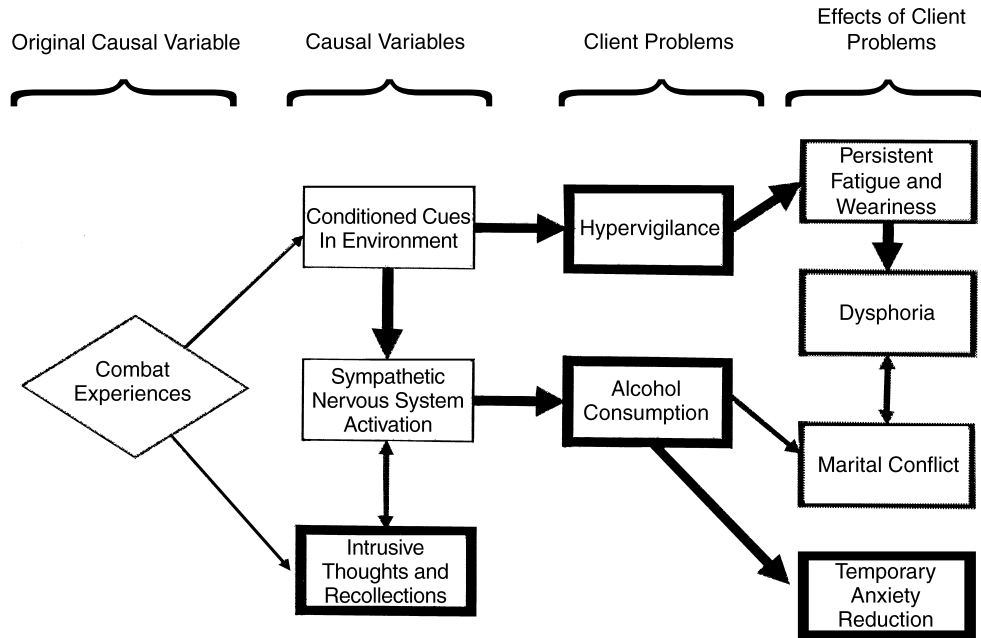

FIGURE 2 A functional analytic clinical case model (FACCM) of a Vietnam war veteran’s drinking behavior and hypervigilance. *Note.* Using the example of the war veteran provided in the article, an FACCM can show both respondent and operant conditioning at work. An original causal variable, the combat experience, is paired with a variety of innocuous stimuli (smells, sounds, etc.) that will later remind the veteran of his combat experiences through respondent conditioning and generalization. The trauma of the combat experience leads to intrusive thoughts and recollections long after the veteran returns from the combat theater. Both environmental cues and the intrusive thoughts and recollections have the potential to elicit sympathetic nervous system activation (e.g., increased heart rate, respiration). Sympathetic nervous system activation can also reciprocally elicit intrusive thoughts and recollections (e.g., an increase in heart rate through exercise can trigger a combat memory). The main client behavior problems thus involve alcohol consumption, which has the effect of temporary anxiety reduction and is maintained through negative reinforcement, and hypervigilance of environmental stimuli (i.e., conditioned cues in the environment). Sustained hypervigilance has the effect of creating a persistent sense of fatigue and weariness. In tandem with marital conflict caused by excessive alcohol consumption, the fatigue resulting from the client’s hypervigilance contributes to another effect, dysphoria.

the modifiability of causal variables, the strength and causal direction of relationships between variables, and the importance of each behavior problem. A computer program developed by Haynes, Richard, and O’Brien in 2000 conducts a path analysis that takes into account all variable relationships in an FACCM and rank orders the effect of each causal variable on the model.

FACCMs are usually specific to a context and are not assumed to be equally valid for individuals with topographically similar target behaviors. FACCMs are dynamic in that they are expected to change as more assessment information becomes available and the variables affecting a target behavior change. Figure 2 is an

example of an FACCM for a Vietnam war veteran addressing client behavior problems of excessive alcohol consumption and hypervigilance.

D. Commentary

The three models described by Persons, Nezu and Nezu, and Haynes provide frameworks by which clinicians can assess and understand functional relations in a clinical case. The models provide a systematic, generalized way of thinking about functional relations rather than suggesting causal mechanisms for a specific behavior or any of its dimensions. In this way, clinical

case formulation models can be thought of as templates that guide conceptualization of functional relations across disorders.

An interesting question for future research involves the degree to which the various clinical case formulation models lead clinicians to hypothesize different functional relations in the same client. In addition, researchers have yet to determine conclusively whether clinical case formulation models enhance treatment outcome and which models, if any, are more likely to produce incremental treatment gains.

VIII. COMPUTERS AND BEHAVIORAL ASSESSMENT

In the future, behavioral assessment will be increasingly augmented by the use of computer technology. Already, researchers have developed computer programs that help the behavioral assessor efficiently collect, store, and analyze data. Programs are now available that ease data collection and analysis across all the major methods of behavioral assessment. For example, software for event recording has replaced earlier electromechanical devices and paper-pencil recording formats. Tapp, Wehby, and Ellis in 1995 developed the Multiple Option Observation System for Experimental Studies (or MOOSES). The software eases event-based recording, interaction-based recording, duration recording, and interval recording of observed behavior. The software is also capable of several types of data analysis (e.g., interobserver agreement, sequential analysis, duration of events within behavioral states). Similarly, Noldus in 1991 reported the development of an early MS-DOS-based coding system called The Observer, and a subsequent multimedia revision, that allow researchers to construct complex coding templates and code behavioral responses as they occurred. Other computerized observational coding systems are available to behavioral researchers and have been extensively reviewed in the literature.

Self-monitoring software has also been developed for handheld devices. An advantage of handheld devices is that they promote assessment of momentary states in the natural environment. Recent research has found that assessment of momentary states may yield results that are significantly different from participant's retrospective ratings of their behavior and skills. For example, some researchers have reported that retrospective self-report measures of coping skills were very poor predictors of how well individuals actually cope in stressful situations.

Several clinically applicable handheld software programs have been described in the literature in recent years. Newman, Kenardy, Herman, and Barr Taylor in 1996 used a Casio PB-1000 handheld computer to prompt patients with panic four times per day to report anxiety levels and occurrence of panic attacks. During the client's office visit, data were uploaded to a desktop computer, stored in a database, and then analyzed. Reports were generated that summarized client responses to the computer. Others have recently reported using handheld devices to record frequency of smoking behavior, measure reaction time during a prolonged, simulated submarine crisis, measure stress reactions in the natural environment, and assess obsessive-compulsive, fibromyalgia, and dementia symptoms.

The extent to which handheld devices will be successfully incorporated into the clinical practice depends on cost-effectiveness, technological, and psychometric issues. With regard to cost-effectiveness, handheld devices may be prohibitively expensive for clinicians to use with clients given that the devices are at higher risk for being lost, not returned, or damaged. In addition, software that is robust enough to be generalized to a wide array of behavior problems is not currently available for handheld devices.³ Even if the software was readily available, efficient methods for conducting data analyses and incorporating results into treatment planning have yet to be developed. Additionally, the technological learning curve may dissuade some clinicians from using these devices at all. From a psychometric standpoint, the effect collecting data using a handheld device has on client behavior (e.g., reactivity effects) is not well understood. Despite these considerations, however, computer and handheld technology should continue to play an important role in the evolution of behavioral assessment.

IX. SUMMARY

Behavioral assessment emphasizes the measurement of variables that are highly specific and require low

³ However, the tools for developing such software are readily available. For instance, Microsoft offers copies of Embedded Visual Basic 3.0 free of charge through its Web site. The software allows developers to create user interfaces for a number of handheld and palm-top devices and debug the software in an emulated mode on a desktop computer platform. Data saved in an Embedded Visual Basic application can be downloaded to Microsoft Access for analysis. In order to run Embedded Visual Basic 3.0, users should have the Windows NT 4.0 or Windows 2000 operating systems installed on their development computers.

levels of inference, over multiple assessment periods, across multiple methods and modes of responding. The behavioral assessment paradigm is closely tied to behavioral principles first elucidated almost 100 years ago. The vitality of behavioral assessment and behavior therapy is evidenced by the exponential growth of journals devoted to their study.

The behavioral assessor may choose from a variety of assessment methods (e.g., naturalistic behavioral observation, analogue behavioral observation, psychophysiological measurement, behavioral rating scales, self-monitoring, behavioral interviews, and behavioral questionnaires). The ultimate goal of behavioral assessment is to facilitate clinician hypotheses about client functioning and develop a clinical case formulation that will suggest the most efficacious treatment intervention. Several behavioral and cognitive-behavioral researchers have developed clinical case formulation models in recent years and the importance of these models in focusing treatment planning continues to increase. With the development of sophisticated handheld and desktop computer applications that ease data collection and analysis, the family of behavioral assessment methods should continue to evolve as the most useful way to assess the relationship and importance of variables operating in a client's life.

See Also the Following Articles

Behavioral Case Formulation ■ Behavioral Consultation and Therapy ■ Behavioral Therapy Instructions ■ Documentation ■ Functional Analysis of Behavior ■ Neuropsychological Assessment ■ Objective Assessment

Further Reading

- Blanchard, E. B., Hickling, E. J., Taylor, A. E., Loos, W. R., & Gerardi, R. J. (1994). The psychophysiology of motor vehicle accident related posttraumatic stress disorder. *Behavior Therapy, 25*, 453–467.
- Boyce, T. E., & Geller, E. S. (2001). A technology to measure multiple driving behaviors without self-report or participant reactivity. *Journal of Applied Behavior Analysis, 34*, 39–55.
- Carr, E. G., Langdon, N. A., & Yarbrough, S. C. (1999). Hypothesis-based intervention for severe problem behavior. In A. C. Repp & R. H. Horner (Eds.), *Functional analysis of problem behavior: From effective assessment to effective support* (pp. 9–31). Belmont, CA: Wadsworth.
- Cepeda-Benito, A., Gleaves, D. H., Williams, T. L., & Erath, S. A. (2000). The development and validation of the State and Trait Food-Cravings Questionnaire. *Behavior Therapy, 31*, 151–173.
- Farrell, A. D. (1999). Evaluation of the Computerized Assessment System for Psychotherapy Evaluation and Research (CASPER) as a measure of treatment effectiveness in an outpatient clinic. *Psychological Assessment, 11*, 345–358.
- Gulley, V., & Northrup, J. (1997). Comprehensive school-based behavioral assessment of the effects of methylphenidate. *Journal of Applied Behavior Analysis, 30*, 627–638.
- Handwerk, M. L., Larzelere, R. E., Soper, S. H., & Friman, P. C. (1999). Parent and child discrepancies in reporting severity of problem behaviors in three out-of-home settings. *Psychological Assessment, 11*, 14–23.
- Haynes, S. N. (1993). Treatment implications of psychological assessment. *Psychological Assessment, 5*, 251–253.
- Haynes, S. N. (2000). Behavioral assessment of adults. In G. Goldstein & M. Hersen (Eds.), *Handbook of psychological assessment* (pp. 471–502). London: Elsevier Science.
- Haynes, S. N. (2001). Clinical applications of analogue behavioral observation: Dimensions of psychometric evaluation. *Psychological Assessment, 13*, 73–85.
- Haynes, S. N. (2001). Introduction to the special section on clinical applications of analogue behavioral observation. *Psychological Assessment, 13*, 3–4.
- Haynes, S. N., Gannon, L. R., Orimoto, L., O'Brien, W. H., & Brandt, M. (1991). Psychophysiological assessment of poststress recovery. *Psychological Assessment: A Journal of Consulting and Clinical Psychology, 3*, 356–365.
- Haynes, S. N., Leisen, M. B., & Blaine, D. D. (1997). Design of individualized behavioral treatment programs using functional analytic clinical case models. *Psychological Assessment, 9*, 334–348.
- Haynes, S. N., & O'Brien, W. H. (2000). *Principles and practice of behavioral assessment*. New York: Kluwer Academic/Plenum Publishers.
- Haynes, S. N., Richard, D. C. S., & Kubany, E. (1995). Content validity in psychological assessment: A functional approach to concepts and methods. *Psychological Assessment, 7*, 238–247.
- Heyman, R. E., Chaudhry, B. R., Treboux, D., Crowell, J., Lord, C., Vivian, D., & Watters, E. B. (2001). How much observational data is enough? An empirical test using marital interaction coding. *Behavior Therapy, 32*, 107–122.
- Heyman, R. E., & Vivian, D. (1993). *RMICS: Rapid Marital Interaction Coding System: Training Manual For Coders*. Unpublished manuscript. State University of New York, Stony Brook.
- Korotitsch, W. J., & Nelson-Gray, R. O. (1999). An overview of self-monitoring in assessment and treatment. *Psychological Assessment, 11*, 415–425.
- McGlynn, F. D., & Rose, M. P. (1998). Assessment of anxiety and fear. In A. S. Bellack & M. Hersen (Eds.), *Behavioral assessment: A practical handbook* (4th ed., pp. 179–209). Boston, MA: Allyn & Bacon.
- Mowrer, O. H. (1947). On the dual nature of learning: A reinterpretation of "conditioning" and "problem solving." *Harvard Educational Review, 17*, 102–148.

- Newman, M. G., Kenardy, J., Herman, S., & Barr Taylor, C. (1996). The use of hand-held computers as an adjunct to cognitive-behavior therapy. *Computers in Human Behavior*, 12, 135–143.
- Nezu, A. M., & Nezu, C. M. (1993). Identifying and selecting target problems for intervention: A problem-solving model. *Psychological Assessment*, 5, 254–263.
- Noldus, L. P. J. J. (1991). The Observer: A software system for collection and analysis of observational data. *Behavior, Research Methods, Instruments, and Computers*, 23, 415–429.
- Norton, P. J., & Hope, D. A. (2001). Analogue observational methods in the assessment of social functioning in adults. *Psychological Assessment*, 13, 59–72.
- O'Brien, W. H. (1995). Inaccuracies in the estimation of functional relationships using self-monitoring data. *Journal of Behavior Therapy and Experimental Psychiatry*, 26, 351–357.
- Orr, S. P., Laskio, N. B., Metzger, L. J., Berry, N. J., Ahern, C. E., & Pitman, R. K. (1998). Psychophysiological assessment of women with posttraumatic stress disorder resulting from childhood sexual abuse. *Journal of Consulting and Clinical Psychology*, 66, 906–913.
- Persons, J. (1993). Case conceptualization in cognitive-behavior therapy. In Kevin T. Kuehlwein & Hugh Rosen (Eds.), *Cognitive therapies in action: Evolving innovative practice* (pp. 33–53). San Francisco, CA: Jossey-Bass.
- Persons, J. B., & Bertagnolli, A. (1999). Inter-rater reliability of cognitive-behavioral case formulations of depression: A replication. *Cognitive Therapy and Research*, 23, 271–283.
- Persons, J. B., Curtis, J. T., & Silberschatz, G. (1991). Psychodynamic and cognitive-behavioral formulations of a single case. *Psychotherapy*, 28, 608–617.
- Persons, J. B., Mooney, K. A., & Padesky, C. A. (1995). Inter-rater reliability of cognitive-behavioral case formulations. *Cognitive Therapy and Research*, 21–34.
- Persons, J. B., & Tompkins (1997). Cognitive-behavioral case formulation. In T. D. Eells (Ed.), *Handbook of psychotherapy and case formulation* (pp. 314–339). New York: Guilford Press.
- Peterson, L., & Tremblay, G. (1999). Self-monitoring in behavioral medicine: Children. *Psychological Assessment*, 11, 458–465.
- Sobell, L. C., Toneatto, T., & Sobell, M. B. (1994). Behavioral assessment and treatment planning for alcohol, tobacco, and other drug problems: Current status with an emphasis on clinical applications. *Behavior Therapy*, 25, 533–580.
- Tapp, J., Wehby, J., & Ellis, D. (1995). A multiple option observation system for experimental studies: MOOSES. *Behavior Research Methods, Instrumentation, and Computers*, 27, 25–31.

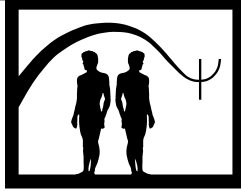

Behavioral Case Formulation

Jennifer R. Antick and Johan Rosqvist

Pacific University

- I. Description of Behavioral Case Formulation
 - II. Theoretical Bases for Behavioral Case Formulation
 - III. Empirical Bases for Behavioral Case Formulation
 - IV. Summary
- Further Reading

GLOSSARY

- antecedents** Events, environmental circumstances, thoughts, behaviors, statements, emotions just prior to the onset of the behaviors targeted for change.
- consequences** Events, internal or external, that immediately follow the targeted behavior(s).
- punishment** Any consequence, internal or external, that decreases the likelihood that a targeted behavior will occur in the future.
- reinforcement** Any consequence, internal or external, that increases the likelihood of a targeted behavior occurring in the future.
- single case design** Applying scientific methods to a clinical case utilizing an $n = 1$.

Case formulation is a process in which a therapist collects information regarding the presenting concerns of a therapy client, describes the client and how a problem(s) came about, and summarizes what the primary problem is as well as what skills and resources the client brings to therapy. The ultimate purpose of case

formulation is to suggest how to proceed in making alterations in the individual's behavior with the intent of creating solutions to the presenting problem(s). Behavioral case formulation utilizes behavioral and learning theories in this process, emphasizing observable behaviors and environmental factors that influence the initiation, alteration, or maintenance of problematic and more useful behaviors. This article outlines the basic processes involved in case formulation from a behavioral perspective.

I. DESCRIPTION OF BEHAVIORAL CASE FORMULATION

Behavioral case formulation is a process in which therapists seek to describe clients, their strengths and resources, stressors, and current concerns in the context of specific, observable, and measurable indicators. Behavioral case formulation has been described as testable hypotheses that connect presenting problems to one another, explains why the problems have developed, and provides predictions of the patients' behavior based on those hypotheses. Other descriptions include references to scientific or empirical methods applied to clinical cases or to considering each case as a minipsychological experiment. An interesting example of this approach is the single case design in which empirical methods are used in the case formulation and treatment of a single individual.

The behavioral emphasis on applying scientific methods assumes several things: (1) behavior may be understood in scientific terms, (2) behavior is sufficiently predictable that we may draw inferences based on earlier behavioral patterns to predict future behavior, (3) behavior may be internal or external, but observable in some fashion by the client and others, (4) behavior is strongly although not exclusively influenced by the environment, (5) all clients present with existing skill sets, resources, and useful observations that can be utilized during behavioral therapy, and (6) we can further alter behavior patterns systematically through the application of scientific and learning principles. The first step of behavioral case formulation is an observation period during which the therapist and client jointly begin collecting information about the presenting concerns of the client. During this phase of treatment the client and clinician identify the target problem(s), including intensity, severity, duration, and the contexts (who is present and what happens just before during and after the problem) in which the problem(s) occurs. Target difficulties in behavioral therapy may be (1) behavioral excesses, occurring more than is desirable in a given context (2) behavioral deficits, not occurring as frequently as desirable in a given context, (3) skills deficits, for example coping or problem-solving skills deficits, or (4) behavioral anomalies, such as behaviors that are inappropriate for any person at any age in any context.

Gathering this information can be accomplished through direct clinical observation, interviews, self-report instruments, self-monitoring, and other assessment methods.

Direct clinical observation is theoretically the most accurate method of data collection. Observation allows the clinician–scientist to witness and therefore evaluate firsthand the relevant external environmental factors and make hypotheses about what would result in the desired change. In application, however, direct observation is neither very practical nor particularly objective. First, as stated earlier, target behaviors may be internal and not directly observable by the clinician. When this is the case, extra time must be taken by the clinician and client to jointly identify external signs of the internal experience so that they may develop observable criteria for success. Second, human behavior patterns change when a person is aware of being observed and covert observation presents such significant ethical concerns as to render it inappropriate in most circumstances. In addition, even well trained observers show bias, seeing what is expected. However, even with its potential pitfalls, direct observation may provide the most valuable information in the case of child behavior analysis.

Interviewing is the most common method of gathering relevant clinical information. The clinical interview may be unstructured, structured, or semistructured. Unstructured interviews offer a great deal of flexibility for the client to discuss personal concerns in the order that makes the most sense and may assist in developing rapport. The cost of that flexibility, however, may be a loss of salient information, timeliness, objectivity, and reliability across interviews. Structured interviews offer greater detail and the likelihood of a thorough and consistent assessment at the cost of rapport and flexibility. Semistructured interviews such as the SCID-I (Structured Clinical Interview for the *DSM IV*) appear to offer the best of both worlds with increased reliability and predictable production of clinically useful data.

Assessment instruments may also be helpful in the data-gathering phase of behavioral case formulation. “Objective” standardized self-report instruments usually require clients to make quantitative or forced qualitative responses to specific questions. These standardized assessment instruments are helpful in balancing some of the subjectivity common to interviewing methods. They allow for the questions to be asked consistently at each administration, scores can be compared to other administrations (if test-retest reliability is sufficiently high) and to other clients’ scores or “normal” population scores. They are also quite practical, making repeated information collection inexpensive (over time) and fairly quick relative to obtaining the same information through interview. For example, a common depression questionnaire may take as little as 5–10 min for the average adult to complete when the interview needed to ask the same questions may easily require 20–30 min to complete. Although standardized instruments as a group often have much better test-retest reliability and interrater reliability than interviewing methods, there are a number of disadvantages to the use of standardized questionnaires. Clients often state that they do not prefer to complete the instruments on a frequent basis. Because of this, clients may answer questions in a habitual pattern rather than answering each question uniquely. Validity (the extent to which a questionnaire measures what it is intended to measure) is also a concern as questionnaires cannot anticipate the way individuals will express themselves or explain their experiences. It is a common occurrence in clinical practice to have clients scratch out items or choose not to answer items on an assessment instrument because it does not directly pertain to their experience. This requires further time from the clinician to ask for the relevant information in interview format, thereby reducing the initial utility of the instrument. It is noteworthy that several authors have found that the

clinician's effectiveness in treatment as well as the client's willingness to complete outcome assessment measures may be enhanced when the instruments are immediately scored and the client and clinician get rapid feedback about the results.

Self-observation or self-monitoring may be an effective option to direct clinical observation. As discussed earlier, humans are natural scientists and with some coaching, most clients can become excellent observers of their own behavior. Some theorists have reasoned that this process may be therapeutic in and of itself, increasing the likelihood of follow-through on therapy assignments and resolution of nontargeted problems before they need to become the focus of therapy. Examples of common self-monitoring tasks include the client noting the intensity, frequency, duration, context, and so on of the target behavior(s) such as intensity of depressive feelings on a 1–10 scale, frequency of crying spells, duration of time spent sleeping in bed, and contextual information (antecedents and consequences) of pain behaviors. As with other methods, self-monitoring or self-observation may be biased, may be simply inaccurate, may have numerous omissions of important data, and may include erroneous information. Practically speaking, if the client does not want to fill the observation sheets out on a regular basis, the information will not be particularly useful. Utility of self-monitoring tasks may be enhanced by reinforcement of the behaviors required to fill them out, by directly using the information brought in (no matter how much is available or unavailable), and by refining the self-monitoring forms to emphasize that which is most salient to the client at that time.

Regardless of which methods are used, the emphasis of the initial data sort includes

1. A description of who the client is in behavioral terms
2. What this person's concerns—problems are from their perspective
3. What is the person ready and willing to work on first
4. What personal or environmental strengths and resources are available
5. What the person's most effective learning strategy is
6. What strategies to remedy the problem have already been attempted (with an emphasis on that which has been successful under some circumstances)
7. A detailed accounting of an example of the problem behavior—behavior chain
8. The antecedents to the problem behavior(s)
9. The consequences to the problem behavior
10. The reinforcing properties of the environment
11. The functional relationships between the environment and behavior
12. How have these developed
13. How have they persisted
14. What in the environment can produce change now
15. What change has been produced in the past
16. A detailed accounting of how change occurred in the past
17. A detailed accounting of the exceptions to the problem
18. Identification of the antecedents and consequences of the exceptions to the problem
19. Identification of significant life events
20. Identification of family history of presenting concerns
21. Information about client's medical condition
22. Information about any substance use including prescribed medications, over-the-counter medications, illegal drugs, or herbal supplements.

Together, these indicators are used to formulate the hypothesis about the problem, how it formed, how it is maintained, and how it may be resolved.

This formulation becomes the foundational underpinning of a course of behavioral treatment and is updated through continuous assessment in the course of treatment refining the hypotheses over time. It is of note that discussing the context in which the problem occurs (or when exceptions to the problem occur) is a prime opportunity to utilize the expertise of the client and to create rapport through positive reinforcement of the client's efforts and differential reinforcement of scientific thinking processes. As humans are natural scientists and hypothesis testers, the client is likely to have formed hypotheses in attempting to remedy the problem prior to seeking external help. In fact, the client may already know "how" to fix the problem but is having difficulty implementing the solution or may have had success fixing the problem in certain contexts but not others. An expert clinician will partner with the client from the beginning of the information gathering or observation phase. It is also important to note here that the information gathered should include hypotheses about the potential effect of making a change in that person's behavior or environment. For example, will changing the target behavior(s) result in reinforcement from the environment or, instead, punishment or loss of previous reinforcement? Will making a change elicit a significant desirable or undesirable response from the environment resulting in a likelihood of short and unsustainable therapeutic gains? The ecology of the

change is an essential part of the hypothesis to be tested in the modification phase of behavioral case formulation.

Now that the target behaviors have been observed, discussed, reported, or otherwise recorded, and hypotheses have been formed about how they began, have been maintained, and how they can be modified, the modification phase begins. The therapist at this point may find that seemingly clear terms are not operationalized sufficiently to proceed. In this case, the clinician and client can refine their terms and make certain that the focus is on the observable, specific, and measurable. Specific behaviors rather than labels or traits are the hallmark of a behavioral approach such that external signs of internal experience are defined as well. Although diagnoses are required by most third-party payers and many institutions as an aspect of treatment planning, there is little agreement as to their clinical utility in behavioral case formulation. Because it is often required, it is recommended that the client and clinician partner in the diagnostic process finding the best-fitting category. It may be necessary to discuss the purpose of a diagnosis (for most clinicians it appears to be for communication with other professionals and for payment structures) and to work toward the least severe and most inclusive diagnostic category possible, minimizing the negative stigma associated with diagnoses.

Together the client and clinician devise a modification methodology, based on the clinician's expertise and skills and client's readiness and willingness to engage in specific, observable, and measurable behavior change. This phase involves clarifying which specific behaviors will be targeted in which order, which methods will be used to observe the change, and how the clinician and client will measure the amount of change. They will further establish a timeline for the testing of the hypotheses (i.e., treatment phase of eight sessions over 8 weeks) and agree on what exact interventions will be implemented (i.e., exposure, relaxation procedure, self-reinforcement schedule). How the changes will be implemented and how the changes and effort will be monitored are particularly important parts of this phase. It is common to utilize the previously chosen observation methodologies with modifications to reduce the amount of time required. For example, a pre- and posttest battery of methods may be proposed with a simple rating system and utilization of one short standardized instrument at each session. Applying scientific principles, the methodology is updated throughout the formulation, and the hypotheses are revised and then sequentially tested. As the clinician and client obtain more relevant data, they gain greater specificity of modification method.

II. THEORETICAL BASES OF BEHAVIORAL CASE FORMULATION

Behaviorists contend that all behavior is understood in context, and that all behavior is systematically variable. Behavioral therapists contend that although individuals vary from one another in their response to similar environmental stimuli, they will frequently develop their own idiosyncratic behavior patterns that can be defined, observed, and measured. These patterns are the focus of behavioral theory and of behavioral therapies. The basic theoretical framework is that effective clinical intervention is dependent on an accurate understanding of the factors that initiate and maintain behavior(s). The factors that initiate and maintain behaviors include antecedents and consequences. Antecedents are the events that immediately precede the targeted behaviors. Like the target behaviors, they can be overt or covert. They are not considered causal but, instead, are said to mitigate the likelihood of a behavior occurring. This relationship with the targeted behavior is strengthened in conjunction with consequences. Consequences are events that immediately follow the targeted behavior(s). These are also overt or covert and can either increase or decrease the likelihood of a behavior occurring. When an increase in a consequence increases the likelihood of a behavior occurring again it is termed positive reinforcement. When the decrease in an unpleasant consequence increases the likelihood of a particular behavior, it is called negative reinforcement. Negative consequences reducing the likelihood of a particular behavior are called punishment. An increase in a negative consequence that reduces the likelihood of a particular behavior is termed positive punishment. A decrease in a consequence that reduces the likelihood of a particular behavior is called negative punishment. In practical terms, different types of punishment are often grouped together and may also be referred to as "mitigating factors." Behavior therapists assert that antecedents and consequences govern both normal and abnormal behavior.

These basic principles yield the following theoretical explanations of undesirable behavior:

1. The excessive use of punishment or aversive stimuli can produce behavioral anomalies, emotional disturbance, and "traumatic" conditioning
2. Inadequate opportunities for learning may result in an inadequate repertoire of skills
3. Reinforcement of inappropriate behavior may result in behavioral excesses, behavioral deficits, or behavioral anomalies

4. Failure to reinforce appropriate behavior may result in behavioral excesses, behavioral deficits, or behavioral anomalies
5. Lack of models or poor models may result in an individual failing to develop a functional behavioral repertoire
6. Poor discrimination skills may result in failure to discriminate between situational variables determining what behavior is appropriate or inappropriate
7. Inadequate self-reinforcement may result in an individual seeking an excess of external reinforcement, social skills deficits, or insufficient emotion regulation

These hypotheses for abnormal behavior reinforce the basic theoretical construct that stimulus–response chains can be identified for any given behavior or set of behaviors. It is of note that early behavioral theorists used a strict definition of behavior that included only that which is externally observable. More recent theorists such as David Barlow and Aaron Beck suggest that internal, or covert, behaviors are governable by the same principles as overt behaviors and therefore equally malleable by the application of learning principles. Current theorists continue to emphasize that the key is in targeting specific, observable, and measurable behaviors; identifying what initiates and reinforces behavior; and then making systematic adjustments (behavior therapy methods) to the behavior chain to create the desirable result.

III. EMPIRICAL BASES FOR BEHAVIORAL CASE FORMULATION

Behavior therapy and its constituent methodologies have been extensively studied, and are, at present, “a favored child” among therapies. One reason for this is that behavioral case formulation requires specificity, the utilization of hypothesis formation, and systematic hypothesis testing. Behavioral methodologies are the clinical equivalent to scientific methodologies and, as such, lend themselves to empirical study. It is said that behavioral methods are studied more than any other therapies. The most recent findings suggest that behavioral and cognitive-behavioral methods consistently produce positive therapeutic results, are easily individualized to the needs of the client, and are, by design, replicable. Behavioral methodologies have been proven to be more effective than medications for most anxiety problems. Studies also show that behavioral methods are more effective with depressive disorders than any other therapy modality and

are recommended as the treatment of choice in conjunction with medication therapy for a number of depressive disorders. Behavioral methods have also been proven effective for externalizing behavior disorders, anger management problems, learning difficulties, social skills deficits, coping skills deficits, pain management, compliance issues in medical treatments, and sleep problems.

IV. SUMMARY

Behavioral case formulation is a method by which a clinician–scientist seeks to understand and then summarize the concerns and strengths of a therapy client. It has long been considered the scientific method applied to therapy. It is a process by which therapists systematically investigate targeted behaviors, form hypotheses about how the targeted behaviors came about, and hypothesize about how they are maintained. The hypotheses form the basis for treatment in which the clinician and client jointly alter individual factors in the internal or external environment (testing the hypotheses) and make observations about the results. Based on these observations, the methodology continues to be modified until the desired result is achieved. Clients are often taught the basic methods involved so that they can maximize the benefit from the process and generalize what they learn to other areas of their life.

See Also the Following Articles

Behavioral Assessment ■ Behavioral Consultation and Therapy ■ Behavioral Therapy Instructions ■ Documentation ■ Functional Analysis of Behavior ■ Objective Assessment

Further Reading

- Cormier, S., & Cormier, B. (1998). *Interviewing strategies for helpers: Fundamental skills and cognitive behavioral interventions* (4th ed.). Pacific Grove, CA: Brooks/Cole.
- DuPaul, G. J., & Ervin, R. A. (1996). Functional assessment of behaviors related to attention-deficit/hyperactivity disorder: Linking assessment to intervention design. *Behavior Therapy, 27*, 601.
- Eells, T. D. (Ed.), (1997). *Handbook of psychotherapy case formulation*. New York: Guilford.
- Ladany, N., Marotta, S., & Muse-Burke, J. L. (2001). Counselor experience related to complexity of case conceptualization and supervision preference. *Counselor Education & Supervision, 40*, 203.

- Malatesta, V. J. (1990). Behavioral case formulation: An experimental assessment study of transient tic disorder. *Journal of Psychopathology and Behavioral Assessment*, 12, 219.
- Margison, F. R., Barkham, M., Evans, C., McGrath, G., Clark, J. M., Audin, K., & Connell, J. (2000). Measurement and psychotherapy: Evidence-based practice and practice-based evidence. *British Journal of Psychiatry*, 177, 123.
- McAndrew, J. (1989). Obsessive-compulsive disorder: A behavioral case formulation. *Journal of Behavior Therapy and Experimental Psychiatry*, 20, 311.
- Steketee, G. (1994). Behavioral assessment and treatment planning with obsessive compulsive disorder: A review emphasizing clinical application. *Behavior Therapy*, 25, 613.
- Turkat, I. D. (Ed.), (1985). *Behavioral case formulation*. New York: Plenum.

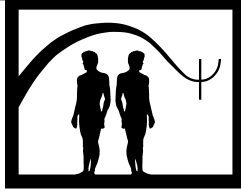

Behavioral Consultation and Therapy

Mark E. Ehrlich and Thomas R. Kratochwill

University of Wisconsin, Madison

- I. Description of Treatment
 - II. Theoretical Bases
 - III. Applications and Exclusions
 - IV. Empirical Studies
 - V. Case Illustration
 - VI. Summary
- Further Reading

treatment acceptability The degree to which the consultee approves of a particular treatment plan.

treatment integrity The degree to which a particular treatment plan is implemented as intended.

GLOSSARY

baseline The period during which behavior is observed before any treatment is implemented.

developmental consultation A form of behavioral consultation that involves sequential, planned treatment of a large number of behavior problems, frequently related to a major psychological disorder or dysfunction.

operant learning A behavioral theory which holds that behaviors are learned by the consequences (reinforcement or punishment) associated with them.

problem-centered consultation A form of behavioral consultation that involves treatment of a small number of specific behavior problems.

punishment Any consequence of a behavior that decreases the frequency of the behavior.

reinforcement Any consequence of a behavior that increases the frequency of the behavior; loosely synonymous with the common term *reward*. Positive reinforcement involves providing something desirable to the individual, while negative reinforcement involves removing something undesirable from the individual's environment. Both positive and negative reinforcement have the function of increasing the frequency of the behavior they follow.

I. DESCRIPTION OF TREATMENT

A. Overview and Fundamental Characteristics

Behavioral consultation is a treatment modality that involves at least three individuals: the client, the consultee, and the consultant. The client is typically a child who is exhibiting some sort of behavior problem and needs psychological services. The consultee is typically a caregiver for the client, usually a parent or teacher, but it could be a peer. The consultant is a mental health professional, trained in a variety of treatment practices and techniques. Through the consultation process, the consultant and consultee work together to address the challenging behaviors displayed by the client. The consultation process also can be used to increase the skills and social competencies of the client.

Each individual has specific roles and responsibilities in the consultation process. The consultant works with the consultee to elicit a clear description of the behavior problem(s) and goals, examine possible explanations for the behavior, develop a plan for treatment, and formulate a method for evaluating the effectiveness of the treatment. The consultee implements the treatment with

the client and collects data that are used to evaluate treatment efficacy. After the treatment has been implemented for a sufficient period of time to permit evaluation, the consultant and consultee together decide whether to maintain, modify, or discontinue the treatment program. It must be emphasized that the treatment is typically implemented by the consultee in this process, although in some cases the consultant and consultee may share this role. This strategy distinguishes consultation from traditional psychotherapy, where the treatment is administered directly by the mental health professional (the therapist). For this reason, consultation is considered an indirect mode of service delivery.

Consultation is also a problem-solving process. In fact, the traditional term behavioral consultation is now usually replaced by the term “problem-solving consultation.” Very specific, carefully defined problems are targeted for treatment. In most cases, the process of consultation focuses on remediating a few targeted behavior problems, rather than addressing more general concerns about the client. This type of consultation is called problem-centered consultation. A second type of consultation, called developmental consultation, can be invoked to deal with a wider array of client problems, including comprehensive assessment and treatment of major disorders. Developmental consultation involves repeated application of the same steps used in problem-centered consultation; problems are addressed in sequence to produce broad improvements in client functioning. Ultimately, the goals of both types of consultation are twofold: to attain an acceptable level of client behavior, and to teach the consultee a process for handling other behavior problems exhibited by other children. The first goal is accomplished by implementation of a treatment plan designed for the identified client. The second goal is accomplished by having the consultee participate in every stage of the consultation process, and in so doing develop their skills and understanding of how to approach children’s challenging behaviors.

Five stages of the consultation process have been identified: initiation of a consulting relationship, problem identification, problem analysis, plan implementation, and plan evaluation. In textbook cases, problem identification, problem analysis, and plan evaluation are readily accomplished through single interviews of approximately one hour each between the consultant and consultee. Initiating a consulting relationship typically occurs at the same time as the problem identification interview. Plan implementation is the lengthiest

part of the process and is usually carried out by the consultee during the consultee’s day-to-day interactions with the client in the natural setting.

B. Initiation of a Consulting Relationship

Successful initiation of the consulting relationship is crucial to the success of the treatment process. It is important for consultants to use positive interpersonal skills in their interactions with consultees. Some characteristics that appear to enhance the relationship between the consultant and consultee include active listening by the consultant and consultant acceptance of the consultee’s perspective through nonjudgmental statements, openness, nondefensiveness, and flexibility.

In traditional behavior consultation, the establishment of a collaborative relationship between the consultant and consultee during the initiation stage is viewed as essential to the ultimate success of the consultation process. Each participant contributes his or her own knowledge and expertise to the case. The consultant brings professional knowledge of treatment procedures (e.g., behavioral principles) and the consultative process. The consultee brings knowledge of the client and the problems that the client is exhibiting. The consultant’s and consultee’s knowledge bases are combined through the consultation process to achieve effective problem resolution.

It is important during the initiation stage for the consultee to attain a clear understanding of the stages of the consultation process, and to identify the roles and responsibilities of each participant at each stage. In this way, appropriate focus will be maintained through the process, allowing for organized development, implementation, and evaluation of a treatment plan. To assist the consultee in understanding the consultation process, it is essential for the consultant to review and discuss the stages of the process—and the roles and responsibilities of each person at each stage—during the initiation of the consultation relationship.

C. Problem Identification

The second stage of the consultation process is known as problem identification. The primary goal of this stage is for the consultant to elicit a clear description of the client’s problem behavior and/or social or academic difficulties. In consultation, a behavior problem is defined as a discrepancy between the actual and desired behavior level. Thus, it is very important to arrive

at a clear understanding of both the client's current behavior and the desired behavior level. Often, however, descriptions initially provided by consultees are vague and incomplete. For instance, a teacher may say, "Billy has problems getting along with peers." Although this description gives some general information about the area of concern, it does not provide specific information essential for understanding the problem and planning a treatment. At this point, the consultant needs to elicit such particulars. This specific information is usually obtained by asking the "W" questions—such as who, what, where and when the behavior occurs. For instance, the consultant might ask, "what does Billy do when he is having trouble getting along with peers," and "when does this behavior occur?" Answers to these specific questions help the consultant and consultee obtain a clear picture of the problem situation, which will later be used to develop an appropriate treatment. For instance, Billy's problems could range from failing to initiate conversations with peers to physically attacking peers when they invite him to play. Knowing the precise nature of Billy's behavior problem is essential for developing an appropriate treatment. The most desirable descriptions of problem behaviors in consultation are those that refer only to the observable aspects of the behavior, are unambiguous, and fully specify all aspects of the behavior—thereby distinguishing the problem behavior from other behaviors that are not of concern. Such clear descriptions are called operational definitions.

Sometimes, in the course of problem identification, more than one behavior is of concern to the consultee in more than one situation. If the list of problem behaviors is relatively short, problem-centered consultation is generally the most appropriate treatment modality. If the list is long, developmental consultation may be the best option. In either case, the therapeutic process works best when only one or two behaviors are chosen for treatment at a time. Thus, the consultant must elicit from the consultee a prioritized list of concerns that will be targeted for treatment. In problem-centered consultation, the consultant and consultee focus their immediate efforts on the top one or two concerns on the list. After those issues have been satisfactorily addressed through consultation, the process may be used again to address the next one or two concerns on the list (provided they have not changed in the meanwhile). For developmental consultation, the consultant must help the consultee recognize at the outset that numerous iterations of the consultation process will be necessary to address the various problem behaviors dis-

played by the client. These behaviors are addressed in a planned sequence, designed to most effectively produce broad improvements in client functioning.

By the conclusion of the problem identification stage, the consultant and consultee should have an understanding of the "ABCs" of the highest priority problem behavior(s). The "A" refers to the antecedent conditions that regularly come before the behavior occurs; the "B" refers to a clear description of the behavior itself; and the "C" refers to the consequences that follow the client's behavior. All of this information is necessary for a full understanding of the problem to be addressed and in planning a treatment to remediate the problem(s).

Another important part of the problem identification process, which can be completed only after the ABCs of the behavior are understood, is to decide on the specific goal(s) for the treatment. Goals are typically expressed as desired increases or reductions in the frequency, duration, or severity of identified behaviors. Setting specific goals helps the consultant and consultee focus on the most important problems and ensures that these behaviors are addressed in the remainder of the consultation process. Equally as important, goal setting is essential for determining the success of the treatment(s) applied.

The last step of problem identification involves establishing a baseline for the problem behavior(s). The baseline refers to the level of the behavior before treatment is started. In textbook cases, the consultee agrees to record the occurrence of the problem behavior for a representative period of time following the problem identification interview—perhaps two weeks. In practice, if the behavior problem is severe, it may be necessary to rely on retrospective records and to proceed immediately to the problem analysis stage. In either case, it will be important to have the most accurate information possible regarding the occurrence of the problem behavior before treatment is begun, so that any changes in behavior level with treatment can be measured and the effectiveness of the treatment can be evaluated accurately.

The importance of thorough problem identification in the consultation process can hardly be overemphasized. Without successful problem identification, the behavior of concern remains partly unknown. It will be very difficult to design an effective treatment, and any treatment attempted will likely be applied in inappropriate situations. Thus, the problematic behavior will not be addressed consistently (if at all), and change is unlikely to occur. Moreover, if the behavior is not

clearly identified, it will be impossible to monitor accurately any changes in the behavior, and the effect of the treatment cannot be accurately evaluated. Research in the field has shown that clear problem identification is a major factor closely associated with successful treatment outcomes in consultation.

D. Problem Analysis

Problem analysis is the third stage of the consultation process. In this stage, the consultant and consultee work to identify particular antecedents and consequences that may be influencing the problem behavior. The process of identifying the relevant connections between antecedents, behaviors, and consequences is known as “functional assessment” because the function performed by each factor is evaluated. Once the functional assessment is completed, a treatment plan may be formulated. The plan may involve changing relevant antecedents to the problem behavior, consequences of the problem behavior, or both. If the plan involves changes in consequences, contingencies that reinforce the behavior problem are removed. In addition, new contingencies are instituted to reinforce alternative, positive behaviors (e.g., prosocial skills and social competencies). Usually, the new contingencies involve providing the client with some type of reward for displaying the alternative, positive behavior. In practice, it may be wise to identify a number of rewards that clients would find motivating, and either to rotate the rewards periodically or to allow clients to choose a reward for which they will work. Both strategies have the advantage of preventing clients from becoming satiated with a single type of reward; the latter strategy also allows clients to select the most motivating reward and encourages them to “buy into” the treatment process by participating actively in its application. It should be stressed that well-designed treatments emphasize use of reinforcement to increase appropriate behavior, rather than punishment to decrease problem behaviors. In this way, clients receive positive feedback about their performance, which may have the additional benefits of enhancing self-esteem, increasing willingness to cooperate in the treatment, improving rapport with the caregiver (the consultee), and preventing defiant behavior.

Another strategy frequently used in treatment design is removing or altering antecedents that may trigger the problem behavior. This technique can be a very easy and effective means of changing client behavior, for it may prevent the problem behavior from ever getting started. For example, telling a young girl that she has to

wash up for dinner in two minutes, rather than that she has to quit playing immediately, may be sufficient to prevent a temper tantrum. The first strategy allows the child to finish the current activity and includes a promise of a generally pleasurable event (dinner), whereas the second strategy signals only the immediate end to playtime. In some cases, removal or significant alteration of antecedents may not be feasible. For instance, a young child may always have to get into the car to be taken to school, even if getting into the car for school triggers a temper tantrum. Nonetheless, in those cases where antecedents can be removed or substantially altered, rapid improvements in client behavior may occur with minimal consultee effort during plan implementation.

Another strategy that may be helpful in plan design is for the consultant and consultee to select an established treatment technique that “matches” the problem or concern, based on empirical research supporting the match. Increasingly, a number of behavior therapy procedures have been shown to work effectively with children when implemented by mediators.

The last step in problem analysis is to set initial goals for clients. It is usually too much to expect the client to obtain the final, desired goal level right away. To facilitate client success during the early stages of the treatment, initial goals that are attainable by the client must be set. Generally, these goals will be well short of the ultimate desired behavior level and may represent a very modest improvement in behavior over baseline level. Nonetheless, such intermediate goals must be used. If attainable goals are set, the client will begin to experience success, and will be rewarded and reinforced for appropriate behavior. This success will result in performance of appropriate behavior at the initial goal level. Once this step is achieved, the goal may be raised in another increment that is attainable by the client. This process is repeated as necessary until the desired end behavior level is attained.

E. Plan Implementation

Plan implementation is the next stage of the consultation process. It is the only stage that is generally the sole or primary responsibility of the consultee. Typically, the teacher or parent carries out the treatment by changing the antecedents and consequences in the natural setting (usually home or school) as planned, so that problem behavior is no longer reinforced, and positive, alternative behaviors are rewarded. If the treatment has been designed appropriately for the client,

the problem behaviors will begin to decrease and positive behaviors will increase.

During this stage, it is critical that the client's behavior level is closely monitored. The consultee must make periodic records of the client's behavior. This monitoring is essential for determining the success of the treatment during the plan evaluation stage. The consultant and consultee should hold brief but regular meetings during the treatment process to discuss and evaluate client progress. Once the client achieves the initial goal, successively higher goals are set. In an ideal situation, the client will show continuous improvement and meet each successive goal.

If the client consistently fails to attain a certain goal level, the consultant and consultee must determine the reason for failure. One possibility that always should be considered is that the goal level was too high. If this appears to be the case, the treatment may be continued by returning to the last behavior level that the client successfully achieved, and then increasing the goal level in smaller increments than previously attempted.

Another possibility that always should be considered is that the design of the treatment was flawed. For instance, it is possible that the consultant and consultee did not correctly identify all the reinforcing consequences of the behavior problem during the functional assessment. In this case, the client still may be receiving sufficient reinforcement to continue the problem behavior, despite the changes made. Thus, the treatment must be re-designed to remove the remaining reinforcing contingencies. It also is possible that the rewards instituted for positive alternative behaviors were not sufficiently motivating. In this situation, new rewards must be identified that are sufficiently attractive to change the client's existing behavior pattern.

A treatment may also fail because it is not implemented as intended. In technical terms, the treatment may lack integrity. A wide variety of factors may be responsible for consultee failure to make the planned changes. Some common reasons include lack of time, improper understanding of the precise changes that need to be made, or interference from outside sources. If it appears that the consultee did not carry out the treatment as planned, the consultant and consultee should carefully review the difficulties that arose and should make appropriate modifications to the plan. In extreme cases, the whole treatment plan may need to be reformulated. It is a fundamental principle of behavior consultation that treatments must be implemented as intended to produce the desired positive effects.

Once the causes of failure have been identified and a revised plan has been formulated, the implementation phase begins again, usually starting at the last goal level successfully achieved by the client. Although one may hope that treatments always will succeed on the first round of implementation, often several rounds are necessary to attain the ultimate desired goal. Design and implementation of treatments is a complex process, and participants should anticipate a certain degree of frustration and backtracking in a significant proportion of cases.

F. Plan Evaluation

Plan evaluation, the final stage of the consultation process, occurs at the end of a somewhat lengthy course of treatment—either at the end of a time limit set by the consultant and consultee for the consultation process, or when it appears that the client has attained maximum benefit from the treatment program. The consultant and consultee together review the client's progress. Data collected by the consultee are essential for assessment of client progress. Generally, case study methods using an AB design are applied to evaluate progress. In AB designs, the "A" refers to the baseline period before the treatment was started, and the "B" refers to the treatment phase after the treatment plan was implemented. The level of the problem behavior in these two phases is compared to determine client progress. Ideally, if data have been collected by the consultee over a period of weeks during both the baseline and treatment stages, it may be graphed for easy visualization of trends.

Figure 1 displays a sample graph for a treatment designed to reduce a child's problem behavior of calling out answers in class. The problem behavior was at a relatively high and fairly constant level during the baseline phase. It then fell to progressively lower levels through the month following treatment implementation. At the time of the last data recording, the behavior had reached the desired goal of only once or twice per day.

An important decision that must be made during the plan evaluation interview is whether to maintain, modify, or terminate the treatment. If it appears that the client is making significant progress but has not yet achieved the ultimate goal, the usual choice is to maintain the treatment and continue the consultation process. If it appears that the client has not achieved the ultimate goal and is making little progress toward it, two options are available: (1) the treatment may be

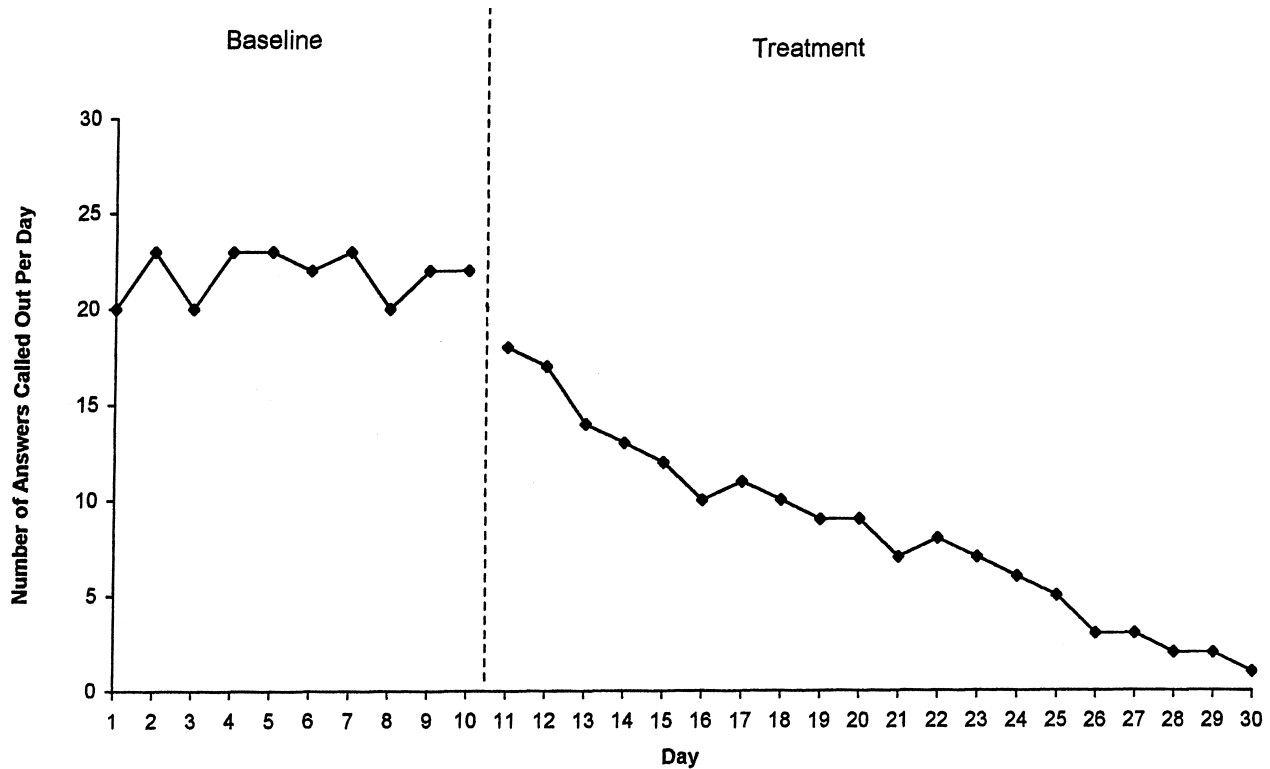

FIGURE 1 Sample graph showing baseline and treatment phases of a successful treatment for calling out answers. Baseline refers to data collected before the treatment was implemented. Treatment refers to data collected after the treatment was implemented.

substantially modified, or (2) consultation may be terminated and other treatment modalities pursued. If, on the other hand, the client has achieved the target goal, it may be appropriate to terminate the program. Generally, the most desirable outcome of consultation is for the client to continue at the newly achieved behavior level without special support. In the ideal case, there will be naturally occurring, positive consequences for appropriate behavior—such as parent and teacher approval, academic success, or maintenance of good peer relationships—which do not involve specially designed contingencies and will continue to reinforce the client's new behavior in the absence of special rewards. In practice, however, abruptly terminating the treatment may result in the return of the problem behavior, especially in cases that did not involve teaching the client new skills. One recommended solution to this dilemma is gradually fading out the treatment. For example, the client continues to receive reinforcement for maintaining appropriate behavior, but the amount or—more commonly—frequency of reinforcement is gradually decreased. In this way, the importance of the rein-

forcers associated with the treatment is gradually decreased, allowing the natural, positive consequences of appropriate behavior to become more salient to the client. Also, the client learns to perform the desired behavior for fewer special rewards. Eventually, the special support becomes unimportant, and the client will continue to perform the desired behavior without it.

To this point, the focus of consultation has been on improving client behavior. In the plan evaluation stage, however, it is also important for the consultant to help the consultee recognize and generalize the skills they have learned and used through the consultation process. At least two types of generalization may occur. The consultant should help the consultee realize that similar treatments might work with other clients with similar problems. In addition, the consultant should help the consultee realize that they can apply the same problem-solving steps used in consultation to many kinds of behavior problems displayed by different clients—either on their own or through additional work with a consultant, if necessary. Thus, plan evaluation not only serves the needs of the client

in the current case, but also prepares the consultee to achieve greater success in handling future behavior problems with other children.

II. THEORETICAL BASES

As the name implies, behavioral consultation historically has been associated most strongly with behavioral schools of psychology. The theory underlying traditional behavioral consultation involves direct adaptation of behavioral principles, particularly principles of operant learning. Generally, it is assumed that inappropriate behavior is learned and maintained by reinforcement received for performing the behavior. Two types of reinforcement may be distinguished. Positive reinforcement occurs when the client obtains some desired object. The desired objects may be tangible, such as food or toys, or intangible, such as attention. Negative reinforcement occurs when something undesirable is removed from the environment as a result of inappropriate client behavior. For instance, children may be excused from doing chores, or from solving math problems, if they have a temper tantrum. It is important to distinguish negative reinforcement from punishment, which is the application of some undesirable consequence for inappropriate behavior.

Drawing on operant principles, the treatment strategy most commonly adopted in behavioral consultation is to modify the reinforcing contingencies which occur in the client's environment. The reinforcing contingencies associated with the problem behavior are removed, as far as possible. Reinforcing contingencies are added for alternative, positive behaviors. The end result is that clients will learn the alternative, positive behavior because there is no longer any gain associated with the problem behavior, and they may obtain new reinforcement by behaving appropriately.

Operant learning theory also recognizes that behaviors are triggered by antecedent conditions. The individual may learn that a particular behavior is reinforced only under specific conditions—that is, when certain antecedents are present. (Providing reinforcement under only specific conditions is known as “differential reinforcement.”) For instance, a child may learn that dawdling is negatively reinforced when the teacher says it's time to do math, but not when the teacher says it's time for recess. Thus, the child performs the behavior when—and only when—those antecedents are present. This principle leads to another strategy that is often used in consultation: changing of antecedents, or

“stimulus control.” Those antecedents that trigger the behavior are removed from the environment. Conversely, antecedents that trigger appropriate behaviors may be added to the client's environment. For instance, a child may be allowed to play only with “good” friends with whom he or she behaves appropriately.

One intriguing implication of traditional behavioral theory applied to consultation is that if the process is pursued properly, it must eventually meet with success. If clients do not initially terminate their inappropriate behavior and replace it with the desired positive behavior, it is because the contingencies involved in learning and maintaining the behaviors were not adequately addressed in the initial treatment plan. It is possible that all the contingencies maintaining the problem behavior were not removed, or the rewards for alternative positive behavior were not sufficiently desirable to the client. In either case, the plan may be reformulated, and the treatment may be attempted again. In theory, it is always possible to remove the contingencies associated with the problem behavior and to institute sufficiently reinforcing contingencies to support the alternative positive behavior. The only difficulties (which may be considerable) lie in the practical aspects of correctly identifying and removing all the reinforcing contingencies for the problem behavior, and providing sufficiently reinforcing contingencies for the positive behavior.

A number of additions and elaborations have been made to these fundamentals of behavior theory applied to consultation. One important addition is the concept of the extinction burst. Observations of clients who have been treated using behavioral methods indicate that when the treatment is first put into effect, the occurrence of the problem behavior actually may increase. This phenomenon may be particularly evident if the treatment plan calls for ignoring the problem behavior rather than giving the client attention for it. In such cases, almost all clients initially attempt to obtain their usual reinforcement by increasing the severity or duration of the problem behavior. This “extinction burst” occurs because the client has not yet broken the old associations between the behavior problem and its reinforcing contingencies, or has not made the new associations between the alternative positive behavior and its reinforcing contingencies. In practice, the consultee must simply continue to carry out the treatment plan, despite the temporary increase in the client's problem behavior. If the consultee continues with the plan, and the plan adequately addresses reinforcing contingencies for the

old and new behaviors, the extinction burst will soon fade, and the problem behavior will be replaced.

In recent years, several expansions have been made that go beyond application of traditional behavioral principles to the practice of consultation. It has been recognized that changing the contingencies associated with various behaviors may not be sufficient to cause clients to improve their behavior. Clients may not possess the skills necessary to perform any positive, alternative behaviors to the problem behavior. In this case, even if clients are motivated to change, it may be impossible for them to alter their behavior because they do not know what else to do. The remedy in these situations is to provide the client with skill training. Skill training serves to teach clients what positive, alternative behaviors they should perform, and how they should carry out those behaviors in practice. At times, skill training can be a lengthy process, especially for clients with significant cognitive or emotional challenges.

In a similar vein, it has been recognized that consultees also may need training in methods of providing the appropriate consequences agreed upon during plan design. Sometimes consultees are unfamiliar with the techniques of providing positive reinforcement to clients. For instance, consultees may need training and practice in providing specific verbal praise for positive client behaviors. Conversely, consultees may lack skill in promptly and calmly enforcing consequences for inappropriate behavior, such as making the child go to his or her room after a single warning.

There also has been interest recently in incorporating additional forms of treatment with those derived from traditional behavioral principles. For instance, literature on effective teaching is replete with techniques for teachers to maximize their instructional effectiveness. Strategies drawn from this body of literature may facilitate improved client behavior in the classroom and may be incorporated into consultation treatments. These strategies typically bear some relation to behavioral antecedents and consequents, but do not derive from traditional behavior theory.

Another important movement is to include empirically supported treatments in the consultation program. A number of mediator-based treatments have been found to be effective with certain types of behavior problems. There is a growing body of empirical literature documenting appropriate matches between particular treatments and specific behavior problems. A recent focus in consultation is selecting treatments that have been shown to match particular behavior prob-

lems. These treatment procedures are often derived from diverse theoretical orientations, including behavior therapy.

In current work in problem-solving consultation, treatments drawn from various branches of psychology other than traditional behavior theory have been incorporated into what has been traditional behavioral consultation. For instance, cognitive techniques in which the client stops or alters the thought processes that lead to inappropriate behavior have been used in the treatment programs. In future work, the fundamental stages of consultation—initiation of the relationship, problem identification, problem analysis, treatment application, and plan evaluation—may continue to provide a framework for the consultative process, while treatment design is expanded to incorporate additional techniques from nonbehavioral schools of psychology.

In sum, it is clear that traditional behavioral consultation is strongly grounded in traditional behavior theory, particularly theories of operant learning. Fundamental principles of operant learning continue to guide the practice of behavioral consultation. Nonetheless, the field of behavior consultation is clearly evolving to incorporate new advances in psychology, as already witnessed by the inclusion of empirically supported treatments and skill training approaches for both clients and consultees.

III. APPLICATIONS AND EXCLUSIONS

One of the great strengths of behavioral consultation is its range of applicability. In theory, behavior consultation can be used with any client with any identifiable behavior problem. Moreover, as long as appropriate reinforcing contingencies can be addressed, appropriate skill training is supplied to the client and consultee, and the treatment is faithfully applied by the consultee, a successful outcome is anticipated. In this sense, behavior consultation represents an especially promising treatment delivery option.

Another great advantage of behavioral consultation derives from the indirect nature of the process. As emphasized earlier, the consultee is primarily responsible for administering the treatment to the client, which is the most time-consuming phase of the process. Thus, consultation can be an extremely efficient means of service delivery from the standpoint of consumption of professional consultant time and resources. A psychologist may be able to work on several consultation cases

in the same time that would be required to conduct a single direct treatment.

There are also considerable advantages to treatment by having the consultee act as the primary treatment agent. Because the consultee is typically a caregiver for the client, the consultee usually spends substantial periods of time with the client on most days. Thus, the client can receive continuous and ongoing treatment. In addition, the treatment usually takes place in the natural setting, where the problem behavior actually occurs. This context permits immediate, on-the-spot application of the strategies developed in the treatment plan. Finally, because the consultee can readily observe the client's behavior in the natural setting, the consultee can collect extensive data on client behavior, which permits thorough evaluation of plan effectiveness.

It is clear that behavioral consultation has a wide range of applicability and offers a means to efficiently use both consultant and consultee resources. Nonetheless, there are certain challenges that must be faced in the process. One of these challenges has already been discussed: it can be difficult to identify correctly and change all the relevant antecedents and consequences for the behavior problem, and to provide sufficiently motivating rewards for performance of alternative, desirable behaviors.

Two other challenges that can disrupt the consultation process deserve special mention. The first is the problem of treatment acceptability, which refers to consultee willingness to implement the treatment. If the consultee is very willing to implement the treatment, it has a high degree of acceptability; if the consultee is not willing to implement the treatment, it has a low degree of acceptability. Research has indicated that treatments with a high degree of acceptability are more likely to be implemented by the consultee. Treatments with a low degree of acceptability probably will not be implemented by the consultee and will provide no benefit to the client. The issue facing the consultant is how to facilitate the design of treatments with a high degree of acceptability.

A number of factors that influence acceptability have been identified. Time required for the treatment appears to be a major factor. Treatments that require less time are preferred over those that require more time. Other important concerns include whether the treatment is positive or negative (i.e., emphasizes rewards for good behavior vs. punishment for bad behavior), the complexity of the treatment, and fairness to other children in the setting. In general, it appears that positive treatments are more acceptable than negative ones,

more complex treatments are more acceptable for more severe problems, and treatments are more acceptable if they are perceived as fair to all children in the setting. The most critical point to remember, however, is that the treatment must be acceptable to the particular consultee who will administer the treatment to the client. Thus, the personal perspective and concerns of the consultee must be taken into account during treatment planning; otherwise, no treatment will occur, and the problem will persist. It is important for the consultant to ask the consultee during the planning phase whether he or she finds the treatment acceptable. If the consultee indicates that the treatment is not acceptable, it must be modified before any attempt at implementation is made.

The issue of acceptability must be distinguished from another challenge associated with consultation: the problem of treatment integrity. Treatment integrity refers to whether the treatment is implemented as planned. Unlike the issue of acceptability, integrity does not involve consultee attitude toward the treatment, or consultee intention. Treatment integrity refers to what actually happens during the plan implementation stage. If the treatment is implemented as intended, it has a high degree of integrity. If it is not implemented as intended, it has a low degree of integrity. Treatment integrity represents a considerable challenge to the efficacy of consultation. In one study, only half the consultees who verbally agreed to implement a treatment actually carried the plan through to completion.

A number of factors affect treatment integrity. Some of the factors are identical to those that influence treatment acceptability. Time involved appears to be the major determinant of both integrity and acceptability. Treatments that require large amounts of consultee time typically have a low degree of integrity, as well as a low level of acceptability. Other important factors related to integrity include the complexity of the treatment, the number of treatment agents, and the perceived effectiveness of the treatment. In general, it appears that more complex treatments have lower integrity. Adding to the number of treatment agents also seems to lower integrity, while obtaining information that supports the effectiveness of the treatment increases integrity. The most important point, however, is that the consultant needs to work with the consultee to identify possible detractors to treatment integrity for the specific plan under consideration. The consultant also needs to develop ways to overcome those obstacles before any attempt is made to implement the plan.

The upshot of these considerations is that although consultation has a nearly unlimited range of applicability in theory, there are critical practical considerations that may interfere with its use in any real-world case. It is vital that consultants be aware of issues of treatment acceptability and integrity, and work with consultees to develop treatments that are highly acceptable and likely to possess a high degree of integrity. These issues may be addressed while planning the treatment by talking openly with consultees about whether the treatment is acceptable to them and problem solving about obstacles that may interfere with implementation (i.e., reduce treatment integrity). If issues of acceptability and integrity can be resolved, there is a good chance that the plan will be carried out faithfully, and the client will receive ongoing treatment for the behavior problem, when and where it occurs.

IV. EMPIRICAL STUDIES

A number of studies have been conducted to document the effectiveness of consultation. Several different variables have been examined to evaluate separate aspects of the consultation process.

As previously discussed, the two main goals of behavioral consultation are improving the client's behavior and enhancing the consultee's knowledge and ability to handle children's challenging behaviors. From reviews of studies reported in the literature, it appears that in most cases, some or all aspects of the client's behavior improve significantly with behavioral consultation. It also appears that in most cases, some or all aspects of consultee knowledge and ability improve significantly with consultation. Additional research has revealed that most teachers who have participated in consultation cases believe that their own professional skills have improved as a result of consultation. Moreover, teachers in schools with consultants tend to view children's behavior problems as less severe than teachers in schools without consultants. Referral rates among teachers who have participated in consultation drop rapidly after four to five years, suggesting that these teachers may gain the confidence and ability to handle children's behavior problems on their own. Notably, teachers and administrators rate consultation as one of the most important services provided by school psychologists, and school psychologists rate consultation as one of their most preferred professional activities.

These findings suggest that consultation is a very beneficial and highly regarded treatment modality. In-

terestingly, however, most of the research on the effectiveness of consultation was completed in the late 1970s or early 1980s, rendering the results somewhat dated. In addition, some of the outcome research appears to suffer from certain methodological shortcomings. In fact, recent commentaries have noted that solid evidence is lacking for certain supposed positive results of behavioral consultation, such as the ability of consultees to apply the skills they have learned to other cases. In addition, there is contradictory evidence on other points, such as the need for equality in the relationship between the consultant and consultee. In sum, although the preponderance of existing evidence indicates that behavioral consultation is an effective and desirable treatment modality, further studies are needed to evaluate the efficacy of traditional consultation strategies and methods.

V. CASE ILLUSTRATION

To describe the elements of behavioral consultation, we will consider the hypothetical, somewhat ideal case of "Jimmy." Jimmy is a third grade student. His teacher, Ms. Thompson, has reported that Jimmy often "acts out" in class and that his behavior is disruptive to other students. Jimmy often spends so much time acting out that he completes very little of his work. She believes that Jimmy has attention deficit hyperactivity disorder (ADHD), and has asked the school psychologist what can be done about Jimmy's behavior.

To successfully initiate the consulting relationship, it is important for the school psychologist to begin by listening to Ms. Thompson's concerns about Jimmy. One of the first steps that the psychologist needs to take after hearing Ms. Thompson's account of the situation is to discuss the nature of the consultative process, the stages of consultation, and the roles and responsibilities of each participant at each stage. Ms. Thompson appears to believe that the psychologist will either work directly with Jimmy to "cure" his disorder or will provide her with a "quick fix" solution that will promptly eliminate the behavior problem. Such beliefs can be common among consultees who have not participated in the consultation process before and do not understand the indirect nature of service delivery. The consultant must make clear that he and Ms. Thompson will collaborate on developing a treatment to improve Jimmy's behavior, which Ms. Thompson will implement in the classroom. Contrary to traditional, direct service models, that consultant probably will not conduct individual therapy

with Jimmy, nor will he simply give a one-step solution to Ms. Thompson. The consultant needs to describe the stages of the consultation process (e.g., problem identification, problem analysis, plan implementation, and plan evaluation) so that Ms. Thompson is aware that she and the consultant will work together, and that a certain amount of time and effort will be required before Jimmy's behavior can be effectively treated. The consultant also needs to emphasize that he brings professional training in behavior principles to the relationship, while Ms. Thompson contributes her knowledge of Jimmy, her classroom expertise, and her knowledge of effective instructional techniques. Thus, the consultant can work with Ms. Thompson to identify behaviors for treatment, develop a treatment plan, and monitor treatment effectiveness. Ms. Thompson, however, will implement the plan in the classroom setting and will act as the primary agent of change.

Once Ms. Thompson understands the nature and stages of consultation, problem identification may be started. Ms. Thompson's early statements that Jimmy "acts out" give some indication of the type of behavior problem but do not describe the behavior in a clear way. The consultant begins by asking Ms. Thompson to describe exactly what Jimmy does when he "acts out." Ms. Thompson reports that Jimmy will rock in his chair, fidget, play with items from his desk, get out of his seat, and wander around the room.

The consultant pursues further description of the behavior by asking how often Jimmy displays these behaviors, how long they go on for, and how severe they are. Ms. Thompson replies that the behaviors seem to occur in streaks of 15 to 30 minutes, occurring two or three times per day. The behaviors are sufficiently severe that Jimmy only gets about one-quarter of his work done, and other students have complained to Ms. Thompson that they cannot concentrate when Jimmy is acting up.

The consultant now has a reasonably clear picture of Jimmy's problem behaviors. In the consultant's professional knowledge, Ms. Thompson's concerns about Jimmy fall into the category of "academic-engaged" behavior. At this point, however, there is no information that might indicate what triggers Jimmy's "nonengaged" behavior or what reinforces its occurrence. The consultant proceeds to ask important "W" questions: when the behaviors occur, in what setting they occur, who is present when they occur, and what happens after Jimmy performs the behaviors.

Ms. Thompson reports that Jimmy's challenging behaviors seem to occur when the class begins new seat-

work assignments. Knowing that there are different types of seatwork, the consultant asks for additional clarification about what types of seatwork assignments Jimmy is doing when the behavior occurs. Also, there are typically more than two or three periods of seatwork per day in most third grade classes, so it seems that something else must be triggering Jimmy's behavior in certain situations. Ms. Thompson indicates, however, that she is not aware of any particular work types associated with the behavior at the moment. Moreover, the setting (Ms. Thompson's classroom) and the people present are consistently the same.

The consultant now turns to what happens once Jimmy begins to display the nonengaged behaviors. Ms. Thompson reports that she attempts to direct Jimmy to sit still and do his work. She indicates that she gives verbal directions, or verbal reprimands, or stands next to him until he settles down and starts working. The consultant asks how Jimmy responds to these attempts to make him work. Ms. Thompson indicates that Jimmy may start his work but soon begins some other nonengaged behavior. The consultant asks if any other treatments have been tried with Jimmy, and Ms. Thompson indicates not.

The consultant now has a fairly clear understanding of the antecedents, behavior, and consequences regarding Jimmy's behavior problem, as far as Ms. Thompson can describe them during this interview. The antecedent appears to be starting seatwork assignments. The behavior includes a variety of nonengaged activities, such as rocking in the chair, rummaging through his desk, fidgeting, and getting out of his seat. The consequences seem to be that Jimmy receives a fair amount of attention from Ms. Thompson and does not do much of his work.

The consultant and Ms. Thompson discuss goals for Jimmy. Ms. Thompson at first indicates that she wants Jimmy to work like the other children in her class. The consultant pursues further clarification of her statement in order to obtain a specific description (e.g., an operational definition) of the desired behavior. In operational terms, Ms. Thompson wishes to increase Jimmy's on-task behavior to the same level as that of the other students, and to increase his work completion to the same level as other students, although she cannot describe more specifically what levels of on-task behavior and work completion she desires at the moment.

Finally, the consultant requests that Ms. Thompson record data on Jimmy's behavior for a two-week period. Ms. Thompson is understandably impatient to begin treatment, so the consultant explains the importance of

obtaining baseline data for treatment evaluation. With this understanding of the significance of behavior observation, Ms. Thompson agrees.

The consultant knows that in most circumstances, the most informative type of data to have on academic behavior is the amount of time spent working on academic tasks, relative to the amount of time spent off-task. The consultant suggests that Ms. Thompson observe Jimmy during representative seatwork assignments and record the amount of time he is engaged in academic work. Ms. Thompson indicates, however, that she does not think she has time to make such detailed observations. The consultant, aware that Ms. Thompson is unlikely to carry out any procedure that requires too much time, discusses with her alternative strategies for data collection. They agree that she will go over Jimmy's seatwork assignments, and they note the amount of work completed. Although this technique does not directly address the problem of engaged behavior, it certainly addresses the problem of work completion. Moreover, work completion is likely correlated with Jimmy's on-task behavior, so this technique represents a reasonable compromise for data collection.

The consultant also realizes that the current understanding of antecedents for Jimmy's behavior is incomplete, as is the current understanding of the desired behavior level. The consultant asks Ms. Thompson to make further notes of when Jimmy's behavior occurs (including time of day and specific seatwork tasks), as well as to note the level of work completion by other children in the class, so that a specific goal for Jimmy may be formulated. Ms. Thompson agrees.

The problem identification interview is now concluded. Ms. Thompson's willingness to collect behavior observations indicates that good rapport has been established between the consultant and consultee. A generally clear description of the ABCs of the behavior has been obtained; where vagaries remain, the consultant has arranged for Ms. Thompson to collect additional relevant information. The availability of baseline data will ensure accurate assessment of treatment effectiveness, at least with respect to work completion. Because only two specific behavior problems have been identified, problem-centered consultation appears to represent a more appropriate treatment modality for Jimmy than developmental consultation at the present time.

The consultant and Ms. Thompson meet two weeks later for the problem analysis interview, after Ms. Thompson has collected the baseline data. The interview begins with a review of the data collected. Com-

plete data for the entire consultation period are displayed in Figure 2; at the time of the problem analysis interview, only the data in the "baseline" region of the graph actually would be available. The data generally confirm Ms. Thompson's initial reports that Jimmy completes only about one-fourth of his work. With respect to the times of occurrence, Ms. Thompson reports that Jimmy's behavior occurs at various times of the day. Hence, time does not appear to be an important factor in determining Jimmy's behavior. Ms. Thompson notes, however, that Jimmy's behavior occurs whenever the seatwork assignments involve writing. The consultant realizes that this is an important additional specification to the antecedent conditions for Jimmy's problem behavior.

Ms. Thompson also reports the level of work completion among other children in her class whom she regards as good students. These children completed approximately 90% of their seatwork.

The consultant and consultee now conduct a functional assessment of the conditions that trigger and maintain Jimmy's behavior. Considering what has been learned about the ABCs of Jimmy's behavior, they hypothesize that Jimmy's behavior is related to working on writing assignments. They hypothesize further that his off-task behavior is both positively and negatively reinforced. It is negatively reinforced in that he is able to avoid doing writing assignments, which he dislikes. It is positively reinforced in that he receives considerable attention from Ms. Thompson when he engages in these behaviors.

Using this information, the consultant and consultee now work to formulate a treatment plan. They decide on a plan that involves several components. Ms. Thompson will no longer pay attention to Jimmy when he displays off-task behavior. Instead, she will provide praise to Jimmy when he is appropriately engaged in his seatwork. In addition, Jimmy will earn rewards for work completion involving writing. He will be awarded stickers for completing a specified amount of his work. When he earns five stickers, he also will receive a prize from Ms. Thompson's selection of rewards that she uses with her class on special occasions. Jimmy will be allowed to pick the reward he wants to work for in advance. Ms. Thompson indicates that the treatment plan is very acceptable to her, and she does not anticipate significant difficulties with implementation—indicating that treatment integrity is likely to be high.

This treatment plan has a number of desirable features. It is a "positive" plan, in the sense that Jimmy has

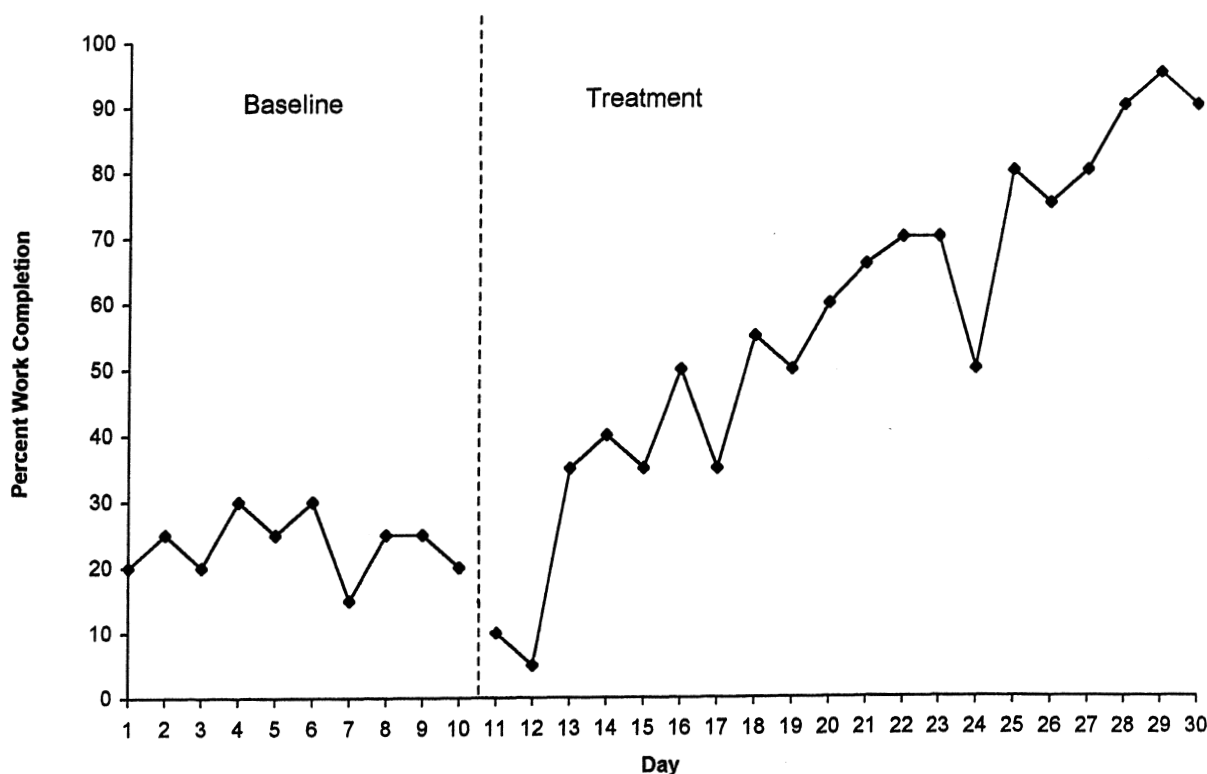

FIGURE 2 Jimmy's work completion.

the opportunity to earn rewards rather than working to avoid punishment. It is also positive in that desirable, positive behaviors (staying engaged and achieving work completion), which are alternatives to Jimmy's problem behaviors, are specified. It is easily implemented because the rewards are easy to give; providing verbal praise as the desired behavior is occurring requires little effort and can be very motivating. In fact, the use of verbal praise seems especially promising in this case, since there is already evidence that Jimmy is motivated by teacher attention. It is also easy for Ms. Thompson to check Jimmy's work completion; indeed, this task is one she performs on an informal basis for all students. Giving stickers is an easy, commonly utilized procedure, and using rewards that are already available and in use in Ms. Thompson's classroom is a straightforward matter. Allowing Jimmy to pick rewards in advance helps to ensure that he will find something motivating to work for and will have a clear awareness of what he can gain by behaving appropriately. Also, allowing Jimmy to pick from a selection of rewards helps to ensure that he will not burn out or "satiated" on one particular reward. All of these factors contribute to the

high degree of acceptability, and anticipated integrity, of the treatment.

The final step in problem analysis is to determine goals for Jimmy. Ms. Thompson has decided that she wants Jimmy to attain 90% work completion on writing seatwork, like other good students do. She believes that Jimmy's off-task behavior will decrease as his work production increases; therefore, she wants to focus on increasing his work completion. The consultant agrees that this approach is a reasonable one and is supported by research. Now the consultant and Ms. Thompson must determine an attainable initial goal. Because Jimmy is completing only about one-fourth of his writing seatwork at the present, it is too much to expect that he will achieve full work completion immediately. Instead, the consultant and Ms. Thompson agree that an initial goal of one-third of the work is reasonable. Jimmy will receive a sticker every day when he completes one-third of his work. Once this goal has been consistently attained, it will be raised to half his work, then two thirds, three quarters, and finally 90% of his work. In addition, Ms. Thompson will praise Jimmy when she notices him on task.

At the conclusion of the interview, Ms. Thompson agrees to start the treatment at the beginning of the following week. She will continue to collect data on work completion as during baseline, so that baseline and treatment stages may be compared. The consultant and Ms. Thompson agree to meet briefly twice per week to review Jimmy's progress and to determine whether changes are needed in the treatment plan.

Ms. Thompson proceeds to implement the treatment. She explains the new reward system to Jimmy, and she allows him to pick a reward to work for during the first week.

Data from the first two days, as depicted in Figure 2, show an immediate decrease in Jimmy's work completion. Ms. Thompson also reports that Jimmy's nonengaged behavior increased considerably during this time. This increase in problematic behavior, and the corresponding decrease in work production, is probably an extinction burst, which the psychologist anticipates. Although Ms. Thompson is initially discouraged by this worsening in Jimmy's behavior, the psychologist explains the phenomenon to her and encourages her to continue the treatment.

On the third day there is a sudden improvement in Jimmy's behavior, and he earns his first sticker for completing one-third of his work. He is learning that he will no longer receive attention for his inappropriate behavior and that positive consequences are now associated with engaged behavior and work completion. As a result, his on-task behavior and work completion increase significantly. Ms. Thompson and the consultant, however, decide to maintain the same goal until Jimmy has earned stickers for three days in row, to ensure that he has firmly associated his new behavior with success. After earning three stickers in a row, the goal is raised to completing one-half of his seatwork.

Over the next few weeks, Jimmy attains higher and higher behavior goals. Goals are raised after Jimmy earns stickers for three days in a row. As the goals are slowly raised, his behavior improves to meet them. Full data on Jimmy's work completion are displayed in Figure 2. Occasionally, Jimmy has off days when he does not earn stickers (such as Days 17 and 24), but the treatment program is continued as planned because he is able to achieve his goals fairly regularly. If some point had been reached where Jimmy consistently failed to achieve his goal, the consultant and Ms. Thompson would have met to discuss possible causes for the difficulty and develop appropriate modifications to the treatment plan.

After the fourth week, the consultant and Ms. Thompson meet for the plan evaluation interview. They review the data collected through treatment, and they conclude that Jimmy has attained the desired behavior level determined during the problem identification interview. Ms. Thompson, however, wonders whether suddenly discontinuing the treatment program will bring a return of the problem behavior. The consultant applauds Ms. Thompson's awareness of the potential danger of abruptly terminating the treatment procedure. He indicates that it is usually best to use some sort of fading procedure in which the frequency of rewards is gradually decreased while Jimmy continues the appropriate behavior. In this way, Jimmy's appropriate behavior becomes less dependent on special reward contingencies. The consultant and Ms. Thompson decide to require two days of 90% work completion to earn stickers, then three days, and finally up to one week. If he maintains appropriate behavior at that point, it seems likely that Jimmy will no longer require special rewards for the behavior, and the treatment program will be ended.

In the plan evaluation interview, the consultant also asks Ms. Thompson whether she believes similar treatments might work with other children. Ms. Thompson indicates that she believes so and is able to name other situations where she would use similar methods. The consultant also asks if Ms. Thompson believes she could use the problem-solving steps they have used in consultation to address other challenging behaviors displayed by other children. Ms. Thompson expresses confidence in her ability to do so. The consultant and Ms. Thompson agree that Ms. Thompson is capable of finishing the fading portion of the treatment without additional consultant input. At this point, the consultative relationship may be ended, because it appears that both client and consultee have achieved maximum benefit.

It is important to note what has not been addressed through the consultation process. Ms. Thompson's initial impression, that Jimmy suffers from ADHD, was not addressed because a short list of only two specific related behavior problems (nonengaged behavior and failure to complete work) was generated. These behaviors were adequately treated through the problem-centered consultation process, and Ms. Thompson reports no other concerns about Jimmy. Thus, there seems to be no need to pursue developmental consultation to address wide-ranging ADHD issues at this time. If Ms. Thompson's list of concerns about Jimmy had included a wider variety of problems which appeared, in the

consultant's professional knowledge, to be related to ADHD, a developmental consultation approach might have been used to address issues of broad psychological dysfunction.

VI. SUMMARY

Behavioral consultation represents a unique form of therapy with many positive features. Because it is an indirect form of service delivery, the professional time and resources of the consultant can be used with particular efficiency. The knowledge and skills of the consultant and consultee are combined through the consultative process to design the best treatment possible. Because consultation has a very specific, problem-solving focus, the most problematic behaviors exhibited by the client are given full attention. In addition, solid grounding in behavioral principles and treatments supported in the empirical literature ensures that a wide range of sound treatment strategies are available. Focusing on the specific behavior exhibited by a single client, however, permits individualized treatment. Moreover, implementation of the treatment by a caregiver in the natural setting promotes the success of the treatment. The focus on a specific behavior also permits extensive data collection and thorough evaluation of treatment effectiveness. Finally, by involving the consultee in the entire process, the consultee learns principles of problem resolution, which may be applied to the challenging behaviors exhibited by other children.

Consultation brings its own challenges as well. It can be difficult to accurately identify all the antecedent and consequent conditions that contribute to the behavior problem. Conducting a thorough and labor-intensive functional assessment increases the chance that all relevant conditions will be correctly identified on the first attempt, but participants must recognize that in some

cases, initial problem analysis may not yield all relevant information. Without such knowledge, it can be difficult to design effective treatments. In addition, problems of treatment acceptability and treatment integrity must be addressed. Because the consultee is the primary treatment provider, the treatment plan must meet with the consultee's approval and must be sufficiently easy to implement in practice in the natural setting. It is well known that consultees often balk at the time, effort, or other interfering factors associated with otherwise potentially useful treatments. Thus, consultants must work diligently to see that the consultee's perspective and situation are taken into account through the consultation process. With appropriate consultant skill and effort, however, great benefits may accrue to both the client and the consultee through the process of behavioral consultation.

See Also the Following Articles

Behavioral Assessment ■ Behavioral Group Therapy ■ Behavioral Therapy Instructions ■ Behavior Therapy: Historical Perspective and Overview ■ Behavior Therapy: Theoretical Bases ■ Primary-Care Behavioral Pediatrics

Further Reading

- Bergan, J. R., & Kratochwill, T. R. (1990). *Behavioral consultation and therapy*. New York: Plenum Press.
- Kratochwill, T. R., & Bergan, J. R. (1990). *Behavioral consultation in applied settings: An individual guide*. New York: Plenum Press.
- Kratochwill, T. R., Elliott, S. N., & Stoiber, K. C. (in press). Best practices in school-based problem solving consultation. In A. Thomas & J. Grimes (Eds.), *Best practices in school psychology—IV*. Washington, DC: National Association of School Psychologists.
- Zins, J. E., Kratochwill, T. R., & Elliott, S. N. (Eds.). (1993). *Handbook of consultation services for children*. San Francisco: Jossey-Bass.

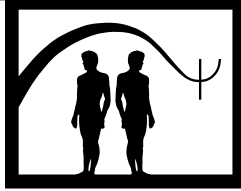

Behavioral Contracting

Brad Donohue and Lisa Solomon Weissman

University of Nevada, Las Vegas

- I. Overview of Contingency Contracting
- II. Developing the Behavioral Contract
- III. Theory
- IV. Applications and Exclusions
- V. Case Illustration
- VI. Summary
Further Reading

GLOSSARY

behavioral contract A verbal or written agreement that specifies contingencies of behavior between two or more persons or parties for a specified duration.

reward A desired action or product that is provided to an individual contingent on adequate performance of a target behavior.

target behavior An action that is the focus of change in a contingency contract.

Behavioral contracting, or contingency management, is a therapeutic tool used by mental health practitioners to facilitate a desired change in identified unacceptable behaviors. The following sections underscore the basic tenets of contingency contracting, including its conceptual framework, methodology, and application.

I. OVERVIEW OF CONTINGENCY CONTRACTING

A behavioral contract is a verbal or written agreement that specifies the relationship of behavior between two or more persons for a specified duration. The behavioral contract is typically initiated by mental health professionals in therapeutic settings as a means of motivating patients to initiate and maintain desired behavior. In utilizing behavioral contracting, it is assumed that the patient has the abilities to perform the behaviors that are specified in the contract. There are two general methods of contracting, quid pro quo, and good faith.¹ In the quid pro quo method, a contingency is established between two or more individuals such that the performance of a specified behavior by one participant is contingent on the performance of a specified behavior by the other participant. For instance, if a married couple is dissatisfied with the cleanliness of their kitchen, a husband might agree to dry and put the dishes in the cabinet if the wife agrees to wash the dishes. This method of contracting is best utilized when there is equal status among its participants (e.g., married couple, friends).

In a good faith contract, significant others of the patient agree to provide the patient with a desired product or action (i.e., reward), but only on the patient's

¹ Some consider the good faith contract a quid pro quo arrangement.

successful completion of the respective target behavior. Significant others are usually persons who are of higher authority status than the patient (e.g., parent, employer, supervisor). An example of this method of contracting would be a parent permitting his bed-wetting 6 year old to view television from 5 to 7 p.m. if the child evidences continence during the preceding night.

Although verbal contracts may be implemented when contingencies are unsophisticated, the terms of a behavioral contract are usually specified in a written record. It is common to have all involved parties, and ideally, a neutral witness (e.g., therapist), acknowledge their support of the contract by signing the document. It is also customary to include an ongoing record of the performance of target behavior, and provision of agreed on consequences. This behavioral exchange is reviewed regularly so that target behaviors are accurately monitored, and earned consequences are provided in a timely manner. To strengthen the contingency relationship specified in the contract, some contracts specify that tokens (e.g., small chips) be provided to patients immediately after the target behavior is performed. These tokens may be exchanged at a later time for specified rewards. This "token economy" system is particularly effective with children, psychotic individuals, or those persons who evidence dementia or mental retardation, because these individuals sometimes experience problems with their memory and often evince difficulties delaying their gratification. Point systems are similar in that the performance of each target behavior is assigned a point value, and each reward requires the exchange of a specified number of points. For instance, an adolescent male might earn three points for washing the car, and later exchange these three points to obtain a ride to the park from his parent.

II. DEVELOPING THE BEHAVIORAL CONTRACT

Five stages are involved in establishing a behavioral contract: (1) identifying the target behaviors, (2) identifying the rewards, (3) negotiating the contingency plan, (4) establishing and role playing the monitoring process, and (5) and ongoing review of the behavioral exchange. The following sections underscore generic applications involved in the implementation of a good faith contract following these stages.

A. Identification of Target Behaviors

Identified patients are usually the individuals who are expected to improve their behavior, as these indi-

viduals are the persons who seek treatment for their problems, or are brought to treatment because their problems negatively affect themselves or others. Target behaviors are usually elicited from friends or family members of the patient, or from external sources (e.g., staff member, therapist, behavior problem checklist). However, when patients are insightful of their problem behavior, they should be involved in generating their own target behaviors, particularly when they are motivated to improve their behavior.

Target behaviors may be identified during clinical interviews (e.g., "What chores would you like your son to do more often?"), or "which lists" (e.g., "List the three most important things you would like your husband to do, ideally."). It is imperative that target behaviors are well defined, because vaguely defined behaviors are susceptible to misinterpretation and disagreement among participants. For instance, a father's initial request to have his son "take the trash to the street curb regularly" might be further specified in the contract to include the specific actions desired, when and where the actions would need to be performed, and for how long (e.g., "Bring the contents of all waste baskets in the house to the end of the driveway every Friday at 7 a.m. for 6 months."). Along a similar vein, participants must be able to monitor target behaviors so that appropriate consequences may be provided. Indeed, if a mother is incapable of recognizing her daughter's use of illicit drugs, drug use should not be targeted in the behavioral contract. Rather, the contract should include target behaviors that are more identifiable, and that have been associated with the girl's use of illicit drugs (e.g., coming home immediately after work in the evening, attending classes at school).

Of course, the patient must be capable of performing the target behavior. If not, the patient must be taught to perform the behavior, or the behavior must be modified or excluded from contractual consideration. For instance, if a child is incapable of studying 2 consecutive hours due to problems associated with inattention, study time may be distributed across several occasions (e.g., four study periods of 30-min duration, with each study period being separated by 1 hr of playtime). As an alternative, overall study time could be reduced initially and later increased gradually as study skills improved. Last, the behavioral contract should include only those target behaviors that are expected to be functional, or reinforcing, to the patient after the contract is discontinued.

B. Identification of Rewards

Rewards are provided to patients after target behaviors are adequately performed, and it is imperative that

the patient strongly desires the rewards that are specified for use in the contract. As with the elicitation of target behaviors, potential rewards may be obtained from significant others of the patient, the patient, or external sources. The patient is relied on as the primary source of rewards, as this individual must ultimately decide if the reward will provide sufficient external motivation to perform the target behaviors that are specified in the behavioral contract. Rewards are typically elicited from patients during clinical interviews, or from the administration of reinforcer menus (a list of age-appropriate rewards), and wish lists (i.e., "If you could make three wishes, what would you wish for?"). In generating potential rewards, a significant other may be instructed to specify what the patient has been observed to do in the patient's free time so that access to these activities can be made contingent on performance of target behaviors. However, it is more common to simply ask the significant other what the patient would probably like as rewards. As might be expected, the patient must confirm potential rewards that are generated from significant others or external sources. This allows the patient to determine all rewards that are utilized in the contract and also provides the patient an opportunity to enhance each reward (e.g., use of mother's car on the weekdays may not be desired, although use of the car during the weekend may be extremely desired). The relative strength of rewards is often determined by instructing the patient to rate the desirability of each potential reward, utilizing a Likert-type scale (e.g., 0 = *not desired at all*, 6 = *extremely desired*).

When significant others are responsible for the contingent provision of rewards, the rewards must be under the control of the significant other. If the patient did not earn the reward as specified in the contract, the significant other must have the ability to restrict the patient from experiencing the reward. Similarly, if the patient has earned the reward, the significant other must provide the reward in a timely manner, and as delineated in the contract. Indeed, compliance with contingencies set forth in the behavioral contract assists in establishing trust between all involved parties.

C. Negotiating the Contingency Plan

Once target behaviors and rewards are identified, a contingency plan is negotiated with the mental health professional assuming the role of an arbitrator. In this process, the mental health professional reviews the identified target behaviors and rewards with the patient only and instructs the patient to determine a fair contingency plan. The patient's initial contingency plan is

brought to the significant other for approval, or modification. If changes are desired by the significant other, modifications are performed, and the revised plan is presented to the patient for approval, or modification. Contingency plans go back and forth in this manner until a plan is mutually adopted by both parties. At any time in the aforementioned negotiation process, a therapist may bring both parties together to expedite compromise. If the patient refuses to participate in the negotiation process, or if the patient is incapable of participating in the negotiation process, the significant other solely determines the contingency plan.

D. Establishing and Role Playing the Monitoring Process

After the contingency plan is adopted, the monitoring process is established and practiced. The patient and significant other agree to get together at a mutually satisfactory time to review, and record, all target behaviors that were performed during that day, including rewards that were earned and provided. This meeting time is usually anchored to a fairly reliable event (e.g., immediately prior to retiring for the evening) and occurs daily at a convenient location in the patient's residence.

It is very important that the behavioral exchange process is role played prior to its implementation in the patient's environment. The role-play process is best initiated as soon as the contract contingencies are established during the initial session. The behavioral exchange process consists of reviewing the monitoring of target behaviors, and the provision of earned rewards. In this endeavor, the mental health professional initially models the role of the significant other in reviewing the contingency contract (i.e., simulates the role of a significant other in initiating the review of the behavioral contingencies at home). In addition to demonstrating the review process, modeling helps to determine if target behaviors are too difficult, or if problems are likely to occur in the contract. In modeling the role of the significant other, the mental health professional reviews the list of target behaviors and descriptively praises the patient for having performed target behaviors that day. The completion and/or noncompletion of target behaviors are recorded, and the patient is provided rewards that were earned that day. Modeling continues until all target behaviors are reviewed, and there is no confusion among the participants. The patient and significant other are then asked to role play the contingency review for the same day. Feedback is given by the mental health professional during this role play to assist the monitoring and behavioral exchange

process. Last, participants are instructed to review the contract in the patient's environment on a daily basis until the next intervention session.

E. Ongoing Review of the Behavioral Exchange

Future intervention sessions focus on praising the patient for the performance of outstanding target behaviors, ensuring that the contract is implemented fairly, and modifying the contract, as needed. The mental health professional attempts to determine if the significant other monitored targeted behaviors adequately, and if rewards were provided as specified in the contract. The mental health professional also determines that no unearned rewards were obtained by the patient. The most frequently occurring modifications to the contract involve the addition and deletion of target behaviors, and the addition of rewards.

III. THEORY

Behavioral contracting owes much of its theoretical underpinnings to the tenets of B.F. Skinner's operant conditioning. Indeed, it has been established that if a given behavior increases in frequency consequent to the application of a stimulus, the stimulus is deemed a positive reinforcer. Thus, in behavioral contracting there is an attempt to modify the patient's environment such that the patient's positive reinforcers will only be available on successful completion of target behaviors. If the target behaviors are truly functional to the patient, the contingent rewards may be gradually eliminated as the patient begins to experience naturally occurring reinforcers. For example, the frequency of a child's completed homework assignments may increase consequent to the child's receipt of a dime per each completed assignment. However, the child's homework may continue to be performed long after the dime is discontinued because natural reinforcers for the completion of homework would probably begin to occur within the duration of the contract (e.g., praise from teacher and parents, respect from other students, personal pride, school awards). Moreover, on practicing homework repeatedly, this behavior may become habitual, and an expected way of acting. As Aaron Beck's self-regulation theory posits, the child would identify himself as an individual who regularly performs homework well. If behaviors occurred that were inconsistent with this child's homework completion, the child

would be inclined to regulate his behavior to be consistent with his beliefs (i.e., an individual who performs homework well).

IV. APPLICATIONS AND EXCLUSIONS

As mentioned earlier, behavioral contracting may be utilized by therapists, psychologists, and other mental health professionals to facilitate improvement in the behaviors of their patients. Persons entering into the contract are usually the identified patient, and those who are interested in the patient's welfare (i.e., staff members, teachers, family members, friends, employers). Behavioral contracting procedures are appropriate across ethnicity and gender, and usually are appropriate for children who are 3 or more years of age, or the developmental equivalent. Contracting procedures may be implemented in a variety of settings, including medical and psychiatric hospitals, outpatient mental health clinics, residential drug rehabilitation centers, schools, camps, and detention centers.

A self-monitoring contract, may be implemented when significant others are unavailable, and the patient is motivated to contingently reinforce her/himself only for the performance of target behaviors. However, this type of contracting suffers from inherent problems, most notably the patient's lack of objectivity in monitoring target behaviors, and failure to comply with contingencies due to forgetting and lack of willpower. Therefore, behavioral contracting is best utilized when significant others are available to monitor target behaviors, and enforce the agreed on contingencies.

V. CASE ILLUSTRATION

The following case illustration, the details of which were obtained from a study conducted by the first author, underscores the importance of utilizing contingency contracting as a motivational tool. Karen, a 12-year-old, Hispanic female, presented to an outpatient psychology clinic with a 5-month history of eating only stage II baby food and frozen yogurt. She complained that her throat was too constricted to swallow solid foods. The onset of her refusal to eat solid foods occurred after she choked on a piece of steak. She was reported to be 106 pounds at that time (i.e., the 50th percentile in weight for a girl her age). During the initial assessment session, Karen weighed 85.5 lbs., and

appeared to be losing about .5 lb. per week. A psychological examination revealed that Karen evidenced conversion disorder. This disorder is indicated when the individual believes deficits in voluntary motor or sensory functioning are present that suggest a neurological or medical condition. However, the symptoms have no identifiable organic etiology.

The first four intervention sessions focused on encouraging Karen to eat solid foods, encouraging family support, and encouraging her to eat foods of increasing viscosity during the intervention sessions. Karen was taught to focus on relaxing her throat muscles during meals. The aforementioned interventions resulted in an initial increase of about 1.5 lbs. However, after only 1 week of intervention, she refused to attempt new foods and evidenced no further gains in her weight for 3 weeks.

In an effort to reinstate her motivation to attempt lumpier foods, and consequently gain more weight, the therapist added contingency contracting to the intervention plan. Specifically, if Karen gained 1 lb. per week, and continued to attempt foods with greater viscosity, she maintained "green status." Green status meant that she would receive one therapy session per week instead of two sessions, eat home meals in a room of her choice instead of being restricted to the dining room, be able to make long distance phone calls to her brother to report treatment gains, be able to leave the dinner table as soon as her meal was consumed instead of being restricted to the table for about 40 min, and be able to go to the grocery store with her mother to choose her favorite foods. She was provided a bonus opportunity that included a plane ticket to visit her out-of-state brother if she gained 5 lbs. Her parents also planned surprise celebration activities with Karen and bought her new clothes, when she was on green status. If she failed to gain 1 lb. per week, she was put on "red status," which meant that Karen did not have an opportunity to earn the preceding rewards.

Contingency contracting resulted in her attempts to eat with foods of greater viscosity, and immediate and sustained weight gain (i.e., approximately 1 lb. per week during 6 weeks of contingency contracting). At the 10-month follow-up assessment, she reportedly weighed 100 lbs. an increase of 14 lbs. since contingency contracting was implemented. During the follow-up interview, Karen's mother revealed that Karen was eating a

variety of nutritious foods fairly regularly, although she was described by her mother as a "light eater."

VI. SUMMARY

A behavioral contract is a verbal or written agreement that specifies the relationship of behavior between two or more persons for a specified duration. The behavioral contract is most often initiated by mental health professionals in therapeutic settings to motivate patients to perform desired behaviors. In quid pro quo contracting, the performance of a specified behavior by one participant is contingent on the performance of a specified behavior by the other participant. Good faith contracting requires a participant to provide rewards to another participant for the completion of target behaviors. Establishing a behavioral contract involves identification of target behaviors and rewards, negotiating a contingency plan, establishing and role playing the monitoring process, and conducting an ongoing review of the behavioral exchange.

See Also the Following Articles

Behavioral Weight Control Therapies ■ Contingency Management ■ Good Behavior Game ■ Neuropsychological Assessment ■ Operant Conditioning ■ Token Economy

Further Reading

- Ayllon, T., & Azrin, N. (1968). *The token economy: A motivational system for therapy and rehabilitation*. Englewood Cliffs, NJ: Prentice Hall.
- Donohue, B., Thevenin, D. M., & Runyon, M. K. (1997). Behavioral treatment of conversion disorder in adolescence. *Behavior Modification, 21*, 231–251.
- Fuller, P. (1995). Contingency management retrospective. *Behavior & Social Issues, 5*, 21–34.
- Higgins, S.T., & Silverman, K. (Eds.). (1999). *Motivating behavior change among illicit-drug abusers: Research on contingency management interventions*. Washington, DC: American Psychological Association.
- Kirschenbaou, D. S., & Flanery, R. C. (1984). Toward a psychology of behavioral contracting. *Clinical Psychology Review, 4*, 597–618.
- Petry, N. M. (2000). A comprehensive guide to the application of contingency management procedures in clinical settings. *Drug & Alcohol Dependence, 58*, 9–25.

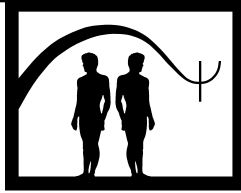

Behavioral Group Therapy

Brian J. Cox

University of Manitoba

Steven Taylor

University of British Columbia

- I. Description of Treatment
 - II. Theoretical Bases
 - III. Case Illustrations
 - IV. Applications and Exclusions
 - V. Empirical Studies
 - VI. Summary
- Further Reading

in vivo exposure Systematically confronting “real life” feared situations, conducted repeatedly in a graded fashion.

subjective units of distress A rating scale used by the therapist and group members to record and communicate degree of distress anticipated or experienced during exposure tasks. The scale ranges from 0 (no fear or distress) to 100 (extreme fear or distress).

GLOSSARY

automatic thoughts The content of one’s stream of consciousness, consisting of thoughts or images that may be positive (e.g., “I can deal with this situation”) or negative (“I’m a loser”).

cognitive distortions Distortions in the way information is processed such as the tendency to exaggerate the aversiveness of unpleasant events (catastrophizing) or the tendency to classify events in black and white categories (e.g., “success” vs. “failure”). Cognitive distortions can arise from dysfunctional beliefs.

diaphragmatic breathing Paced breathing exercises used in panic control treatment to counter hyperventilation and physiologic hyperarousal.

dysfunctional beliefs Basic assumptions the person holds about the self, world, or future (e.g., “I am fundamentally flawed,” “The world is a dangerous place,” “My life will never improve”). Such assumptions are considered to be dysfunctional if they impair the person’s life or give rise to emotional problems.

interoceptive exposure Systematically confronting feared bodily sensations (e.g., accelerated heart rate) that serve as interoceptive fear cues.

I. DESCRIPTION OF TREATMENT

Behavioral group therapy (BGT) is an effective, efficient psychotherapy that has been successfully adapted to treat a wide variety of psychological disorders, and occasionally to address psychosocial aspects of physical ailments (e.g., irritable bowel syndrome). BGT shares some characteristics with other forms of group psychotherapy and is not simply a didactic, classroom-style approach to skills acquisition. At the same time, it is also a unique group therapy in several respects. The content is structured, both within and across sessions. Compared to group therapy in general, the design of BGT is specific toward the target problem, even in some of the more “generic” forms of BGT that tackle groups of problems. BGT is multimodal in nature whereby a package of treatment components is assembled to address the multidimensional nature of most forms of psychopathology. Finally, the number of sessions is generally fixed and the duration of treatment is measured in weeks rather than months. BGT uses closed groups of medium size (e.g., 6 to 8 individuals),

and is often preceded by one-on-one interviews with prospective group members and one of the therapists in order to establish diagnoses and assess suitability for group therapy. Following formal treatment, a more informal group open to “graduates” of the BGT program is often useful to provide booster sessions for those who require it.

There are important advantages to offering behavior therapy in a group setting. The first reason is efficiency. More people can be helped with less therapist time, although it can require more administrative coordination and scheduling. In the case of relatively homogeneous groups that are organized around the primary disorder, there comes the reassuring sense of common, shared experience for many individuals. Perhaps the most important advantage of the group format is that the role of the therapist can be systematically decentralized and instead a self-help approach is encouraged. Group members can act as supportive coaches in reviewing and engaging in exposure exercises, and can work together in cognitive restructuring. Group cohesion and a self-help orientation can promote self-reliance and ultimately self-efficacy and mastery. Accordingly, terms like “program” may be preferable to “therapy,” and “group member” may be preferable to “patient.”

The next section provides a theoretical overview of BGT. Immediately following this overview we present two case illustrations of BGT. The first involves a protocol for panic disorder with agoraphobia, and serves to highlight different types of exposure techniques in BGT. The second BGT protocol has more cognitive components and is designed to treat generalized social phobia. The chapter concludes with a brief discussion of applications and exclusions for BGT, along with a summary of the current empirical knowledge base.

II. THEORETICAL BASES

BGT is based on contemporary conditioning and cognitive theories of emotional disturbance. Current conditioning models assume that emotional reactions can be learned in multiple ways, including classical conditioning, transmission of information from one person to another, and observing other people react emotionally to stimuli. Classical conditioning, as conceived in contemporary models, is a process of learning to associate a stimulus with a particular outcome. In other words, it is a process whereby the person develops expectations about the consequences of a particular stimulus. The experience of being mauled by a

dog can lead the person to associate dogs with harm. This expectancy thereby gives rise to fear and avoidance of dogs.

Contemporary cognitive theories of emotional disturbance have their origins in the pioneering work of Aaron Beck and Albert Ellis. These models posit that emotional problems are not directly caused by aversive events, but are the result of the person's beliefs about the event. Thus, a given event (e.g., a canceled visit from one's mother-in-law) could elicit any number of emotional responses (e.g., disappointment, joy, annoyance) depending on the person's interpretation of the event. Cognitive theories propose that dysfunctional beliefs are prime sources of emotional disorders. A person who held the belief that “My world must always be predictable” would become distressed at the mother-in-law's canceled visit. In comparison, a person who believed that “You have to expect the unexpected” may react with mild disappointment.

Dysfunctional beliefs give rise to automatic thoughts, which form part of the person's stream of consciousness. A person who believed that “I am a failure as a person” might have a stream of negative automatic thoughts such as “Nobody likes me,” “What's the point in trying,” and “I'll never succeed.” Such thoughts arise when particular life events occur that are relevant to the person's dysfunctional beliefs. A person who believed that “My worth depends on my ability to be a good mother” might not become terribly upset if she lost her job, but would become profoundly despondent if somebody criticized her child-rearing practices. Thus, emotional problems arise when particular life events interact with particular dysfunctional beliefs.

Dysfunctional beliefs also give rise to a variety of cognitive distortions, which are aberrations in the processing of information. A person who believed that “People are always trying to exploit me” would be concerned about being taken advantage of, and therefore vigilant for such occurrences. As a result, the person would tend to overlook the altruistic acts of others. This is an example of overfocusing on the negatives. Other examples of cognitive distortions are shown in Table 1. Cognitive restructuring exercises, as described elsewhere in this chapter, are used to replace dysfunctional cognitions (thoughts, beliefs, and distorted information processing) with more adaptive forms of thinking.

How do cognitive and conditioning theories fit together? It might seem that these are two completely different ways of conceptualizing emotional problems. However, the two theories are quite compatible, and

TABLE 1
Examples of Cognitive Distortions

<i>Distortion</i>	<i>Description</i>
All-or-nothing thinking	Classifying events in black and white categories; e.g., regarding some as either “good” or “bad”; appraising your performance as either “perfect” or “a complete failure.”
Overfocusing on negatives	Focusing on negative events to the exclusion of positive events; e.g., focusing on all the times that you have failed, and ignoring the times you succeeded.
Catastrophizing	Exaggerating the aversiveness of unpleasant events; e.g., regarding your anxiety as “excruciating and never ending” rather than “unpleasant and short-lived.”
Demandingness	Imposing rigid rules and demands on oneself or others; e.g., “people <i>should</i> take care of me”; “I <i>must</i> be a success at my career.”
Personalization	Taking personal responsibility for events where there is insufficient evidence that you were responsible; e.g., when a friend fails to phone, you interpret this as due to some personal failing (“I’m boring to talk to”) instead of considering the other possibilities (“She didn’t call because she had a migraine”).

have been synthesized in the emotional processing model (developed by Edna Foa and Michael Kozak). According to this model, emotions are represented in networks (structures) stored in long-term memory. Consider, for example, the network underlying a person’s social phobia. The network contains stimulus information (e.g., authority figures, oneself as a social object), response information (e.g., representations of one trembling, sweating, blushing, and fleeing), and meaning information (e.g., concepts such as “danger” and “threatening”). The elements of information are linked together. For our social phobic, “authority figures” is linked to “threatening” (a stimulus-meaning link); “self” is linked to “weak and ineffectual” (another stimulus-meaning link); “authority figures” is linked to “blush, trembling, and flee” (stimulus-response link); and “threatening” is linked to “fear” (meaning-response link). Thus, each emotional network consists of an interconnected matrix of stimulus, response, and meaning information. Stimulus-response links can be acquired by conditioning or other forms of learning, and stimulus-meaning or response-meaning links can represent dysfunctional beliefs (e.g., “Authority figures are threatening”). In this way the emotional networks combine elements of conditioning and cognitive theories.

Networks are activated by incoming stimuli that match its stimulus, response, or meaning information. Activation of the network evokes emotion and associated responses such as escape or avoidance. Networks underlying emotional problems are modified by, first, activating the network (via presenting the person with relevant stimuli) and then by incorporating corrective

information. This is known as emotional processing. Exposure exercises and cognitive restructuring techniques are both methods of modifying networks underlying emotional problems. Skills training (e.g., assertiveness training) is another way of modifying the networks. As a result of emotional processing, links are changed and meaning information is modified. For example, the stimulus-meaning link might change from “authority figures are threatening” to “authority figures are generally benign.” In summary, the interventions used in BGT aim to modify the patient’s emotional networks so that the latter become more adaptive.

III. CASE ILLUSTRATIONS

A. Panic Disorder with Agoraphobia

Panic disorder with agoraphobia (PDA) is characterized by sudden, intense episodes of anxiety (panic attacks) that often occur unexpectedly. The attacks are usually associated with feelings of impending doom and are composed of physical symptoms (e.g., shortness of breath, dizziness, racing heart) along with catastrophic thoughts (e.g., thoughts that one is dying, going crazy, or losing control). Agoraphobia frequently accompanies panic disorder and is defined as a fear of being in places where escape may be difficult or help not forthcoming in the event of a panic attack. Situations that are either avoided or require the presence of a trusted companion include public transportation, being in crowds or lineups, and traveling long distances.

From a cognitive behavioral perspective, panic attacks are viewed as arising from catastrophic misinterpretations of bodily sensations, and phobic avoidance is seen as a conditioned response. BGT for PDA is composed of several modules delivered over 10 sessions and the protocol is a group adaptation of the individual treatment developed by David Barlow and colleagues. Because of space limitations, and to avoid redundancy with other chapters, we will highlight group adaptations rather than cognitive-behavior principles and techniques in general.

Session 1: The introductory session involves setting group members at ease. Some members may have difficulty being in a group setting or in not sitting next to the doorway. A brief explanation of a Subjective Units of Distress scale (SUDS) can give everyone a common meter to express their anxiety at that time, and there is often a relief that the high state anxiety is not an isolated experience. The scale ranges from 0 (no fear or distress) to 100 (extreme fear or distress). Following the introduction of therapists and some brief group rules about the importance of confidentiality, attendance, and homework assignments, a brief introduction and history from each group member is sought (e.g., location of first panic attack, treatment history). Listening to others' histories can be reassuring for many group participants, but some may become distressed for fear of "picking up" new variants of catastrophic "what if?" thoughts, and this can be addressed from a cognitive perspective. An effort is made to have every group member make at least some contribution, and this is true throughout the sessions. Group members are provided a schedule and overview of coming sessions. Using a blackboard or easel, more detailed descriptions of panic attacks are then solicited from group members. The attacks are broken down into component physical symptoms and associated cognitions. An informative exercise is to ask individuals about the worst thing that has happened during an attack, so that they can see that worst-case feared outcomes (e.g., loss of consciousness) are in fact extremely rare. Situations that people avoid are then listed (e.g., strenuous exercise, public transportation). Safety nets (e.g., availability of cellular phone) are also included. Using the information now listed the therapist can suggest thematic links between internal sensations, associated thoughts or interpretations and the role of escape, control, and phobic avoidance. In short, the cognitive behavioral model and rationale can be presented using the information provided by group members as illustration. At the end of the session SUDS ratings are again elicited from group members. In most cases there will have been a decrease over

the 2 hours and this can be used as an example of *in vivo* exposure "in action." Homework consists of a self-directed, behavioral approach test to get an estimate of baseline functioning. This involves assignments where participants are asked to enter feared situations (e.g., travel five blocks by bus) and rate their peak SUDS levels during the exercise.

Session 2: This session contains much of the corrective psychoeducational information about panic (e.g., nature of fear and fight/flight response). Sensitivity to anxiety and other physical sensations and the process of catastrophic misinterpretation in panic attacks is included. Information about the role of escape, avoidance, and the maintenance of fear then follows, with the message that "what is learned can be unlearned." Wherever feasible, group members are called on to provide examples of the various components. Realistic goals are then discussed and targets identified. Homework consists of self-directed exposure of a mildly feared situation with the instruction to remain in the situation until anxiety has noticeably decreased. An example of diary construction is reviewed in order to record the situation, time, SUDS, and thoughts experienced during exposure tasks.

Session 3: Exposure exercises are reviewed for each group member. The theme of this session is the rationale and implementation of exposure. This might begin with drawing a graph showing gradual reduction of anxiety with repeated exposure exercises of sufficient duration. Implementation includes detailed construction of a hierarchy of feared situations in collaboration with group members. Handouts on techniques for coping with anxiety and panic are provided and reviewed. Examples of helpful coping self-statements are provided and also solicited from group members. The importance of graded, self-directed exposure is emphasized and at least three exposure exercises per week are encouraged. The involvement of spouse, significant other, or friend as a "coach" may be discussed. Finally, goals are set for the therapist-assisted exposure session in Session 4.

Session 4: This session involves therapist-assisted *in vivo* exposure. If two therapists are present the group is divided according to the theme of the situational exposure and it is certainly easier to implement group exposure if a co-therapist or assistant is available. However, a situation such as a shopping mall provides a number of different exposure opportunities that can accommodate most group members (e.g., escalators, elevators, lineups, heights). In addition to providing support, the therapist can work with individuals to identify and challenge "hot cognitions" (i.e., those occurring in the moment) and to

observe and correct problematic breathing (e.g., holding breath). Exposure to situations that can be followed up with self-directed exposure is encouraged.

Session 5: *In vivo* exposure tasks from Session 4 and from homework exercises are reviewed, and group members are called on to participate in solving problems that may arise (e.g., modification of exposure tasks, additional coping techniques). The remainder of the session is devoted to (1) interoceptive exposure, which involves confronting internal feared sensations and (2) exploring the nature of effective and ineffective breathing patterns, which include diaphragmatic, paced breathing and hyperventilation, respectively. A group approach to these behavioral techniques is particularly helpful because of the support of other group members, the ability to create a shared common experience, and the opportunity to solicit and to provide feedback from individuals other than the therapist. Similar to *in vivo* exposure, a repeated graded approach is utilized in interoceptive exposure. Of the various interoceptive exposure exercises, voluntary hyperventilation (with therapist participation) is one that is particularly appropriate to a group setting. Education and practice of diaphragmatic, paced breathing is conducted toward the end of the session. Most individuals find it to be a relaxing exercise, and they are asked to rehearse this coping skill to effectively acquire it for their antipanic arsenal. Homework exercises are outlined.

Session 6: It is roughly the halfway point in the course of treatment and considerable time is taken to check in with each group member to review progress and problem-solve as a group where necessary. If time permits, further interoceptive tasks can be conducted (e.g., spinning in a chair to induce dizziness). The session concludes with outlining self-directed exposure exercises and planning the next therapist-assisted exposure session.

Session 7: By this time, there is generally good group cohesion and many group members can help each other as coaches. For example, traveling on a crowded bus might prove challenging to some members whereas a shopping mall destination may prove challenging to others.

Session 8: Following a review of homework exercises, the session begins with progressive muscle relaxation. An audiotape is used and is available to group members. A taped version also allows the therapist(s) to participate alongside other group members. Relaxation strategies, including the paced breathing exercises, are reviewed. General and specific changes in attitudes and thinking styles are reviewed, especially in the context

of challenging catastrophic interpretation of internal sensations. Thoughts and concerns about future group termination are discussed. The session concludes with outlining self-directed exposure exercises and planning the last therapist-assisted exposure session.

Session 9: The last *in vivo* session is more of a group exposure rather than a therapist-assisted exposure, and an attempt is made to keep therapist contact to a minimum. Subgroups might also be formed. For many individuals the goal is to encounter a very challenging event, often something that has been discussed for some time and also something that is entertaining (e.g., going to an amusement park, seeing a movie in a large theatre).

Session 10: The final session usually begins with a group discussion about the previous week's exposure session, and this allows a progression into a more general discussion about gains that have been made in the past several weeks. Remaining challenges and strategies for overcoming them are discussed. The importance of continued self-directed exposure in achieving long-term goals is highlighted. Members can provide feedback to each other on gains observed while in group and during group exposure sessions. Relapse prevention strategies are discussed. Self-help support groups for "graduates" of cognitive behavioral programs may be available. Appropriate self-help books for more general issues are recommended. Often the group concludes with coffee and doughnuts and this adds to the positive, "graduation" ambience.

B. Generalized Social Phobia

Generalized social phobia (GSP) is a common and disabling disorder that affects many areas of a person's life. Situations commonly avoided include presentations to small or large groups, being observed while eating or drinking, and many forms of social interaction (e.g., initiating a conversation). Dysfunctional attitudes and extreme negative thinking appear to play an important role in the etiology and maintenance of the disorder. Phobic avoidance is a major feature of GSP and so exposure therapy is indicated. However, because of the way that people with GSP interpret their social interactions, even seemingly successful social encounters can be perceived as failures through a critical dissection or "postmortem" ruminative process. Accordingly, cognitive restructuring is an important component of treatment. Behavioral group therapy for social phobia was pioneered by Richard Heimberg and colleagues and is arguably the nonpharmacologic treatment of choice for this condition. Because of the psychological complexity of GSP

this cognitive approach is more intensive, and requires more therapist skill and experience, than BGT for PDA. Groups are smaller (e.g., six members) and of longer duration (12 sessions). Within-session exposure sessions (role playing) accompanied by cognitive strategies are a major focus of the therapy. Individuals with severe social deficits are more appropriate for behavioral social skills training. Some individuals will have high levels of criticism toward others in addition to self-criticism, and their interpersonal style may be inappropriate for this type of group approach. Prior to the formal group treatment, one or two individual sessions with each member is conducted in order to explain the cognitive behavioral model and rationale, and to help alleviate anticipatory anxiety surrounding group therapy.

Session 1: The introduction and orientation is similar to BGT for PDA except that the state anxiety in the group is generally much higher. The therapist therefore takes a “go slow” approach and acknowledges the demands of the situation. Often the subjective, internal experience of anxiety will be disproportionately greater than outward, observable signs of anxiety, and it is useful to point this out. It helps address automatic thoughts such as “Everyone looks so calm and I’m falling apart—I’m not ready to be in a group,” and also encourages group members to look at each other and make eye contact. These types of exercises can be done in a sensitive and humorous way and helps set group members at ease so that they are able to process the information provided. The therapist can also provide his or her own SUDS level, which is generally far above 0, and this can serve to highlight the adaptive functions of moderate anxiety. Individual experiences of symptoms, cognitions, and situations avoided are elicited, and again an attempt is made to call on every group member. The rationale for both cognitive and behavioral treatment components is reviewed using the specific examples provided by group members. As a cognitive exercise, members are asked to verbalize their negative automatic thoughts about the group program (e.g., “This may work for others, but it will never work for me”). A structured diary to record automatic thoughts is reviewed and distributed.

Session 2: After a brief review of CBT theory from the previous week, the diaries are discussed. Considerable time may be spent with each group member to begin the difficult process of identifying the nature and extent of negative thinking. Fears of negative evaluation may be linked to extreme self-criticism. Some group members may become tearful or may temporarily leave the room. When it becomes appropriate, the thoughts

surrounding this experience should be reviewed and other group members can be called on to provide their thoughts and feelings to counter the automatic thoughts of the individual who became upset. Subsequently, other group members can be called on to elicit their own negative automatic thoughts (e.g., “Oh God, I should be doing something to help”). Compared to BGT for PDA, this group program spends more time in the present on within-group issues. More therapist effort is required to build group cohesion. Group members can be informed that it is important to identify all negative thinking before attempting to change it and that is a painful exercise at first. A list of cognitive distortions is provided and is reviewed using examples provided by group members.

Session 3: Diaries of automatic thoughts and associated cognitive distortions are reviewed. While the therapist might help each member uncover additional automatic thoughts, other group members can be called on to help identify appropriate cognitive distortions. Considerable time may still be required for each group member. The remainder of the session is devoted to the rationale and principles of exposure.

Session 4: Cognitively, the group now moves toward challenging the automatic thoughts once they are identified through a variety of cognitive restructuring techniques. This process will likely have already begun for some members following the awareness of cognitive restructuring. The goal is to challenge (e.g., “Do I know for certain that X will happen”), rather than to “replace” negative thinking. Behaviorally, exposure is now more formally incorporated in the construction of fear hierarchies for each member.

Session 5: Self-directed exposure assignments from the hierarchy are reviewed. Several “lessons” (information and skills acquisition) are presented. These lessons are brief (15 to 20 minutes) modules that are partly didactic and occasionally involve role playing on the part of the therapist (ideally two therapists can role play social interactions). The first lesson is on the role of fear of negative evaluation and its consequences (e.g., heightened self-focused attention) in social phobia. Cognitively, the challenging of automatic thoughts means that they are no longer uncritically accepted as valid, and members are now encouraged to generate reasonable (rational) responses to the automatic thoughts. An effort is made to make these responses reality-based with the recognition that they will likely not “feel” right at first and that this shift takes time. Group members are encouraged to generate additional possible reasonable responses for each other when weekly diaries are

reviewed. Exposure homework assignments are developed for implementation during the following week.

Sessions 6 through 9: The format of these sessions is to begin with a lesson. The remaining themes include effective conversation, perfectionism, anticipatory anxiety, assertiveness, and control. These exercises can involve the participation of group members. For example, the lesson on conversation begins by having the therapist allow a long silence. This “pregnant pause” is then used to elicit individuals’ reactions and automatic thoughts around initiating and maintaining conversation. The remainder of each group session is devoted to cognitive restructuring. The process evolves from identifying and challenging automatic thoughts to understanding underlying dysfunctional belief systems. Self-directed exposure is continued based on the situations listed in the hierarchies.

Sessions 9 through 11: The bulk of these sessions is composed of *in vivo* exposures or “role-plays.” The goal is to have two role-plays for each group member over the course of treatment. Role-plays will have been discussed with group members as early as the individual, pregroup interviews. Because it is a taxing exercise for many individuals it is reserved until the second half of the group therapy protocol. The simulated exposures are designed to be as realistic as possible and can include social interactions (e.g., initiating conversation at a party) and formal presentations (e.g., delivering a retirement speech). Props are used (e.g., drinking glasses) and furniture arranged to enhance realism. Immediately prior to the exposure the therapist meets with the central role-play member and rehearses the situation, assists in identifying all automatic thoughts, and gauges the SUDS rating of the anticipatory anxiety. Immediately following the exposure, a debriefing session occurs with all group members to discuss the role-play. Automatic thoughts are reviewed as well as the success of various methods of challenging them. The debriefing is very much a group exercise, because members can provide direct feedback to automatic thoughts (e.g., “Everyone can see how badly my hand is shaking—they think I am weak”). Unlike most social situations, the debriefing following the role-play allows all group members to find out what others were thinking, the strengths and shortcomings of their performance, how noticeable their anxiety was, and so forth. This type of feedback, especially because it is not coming solely from the therapist, can provide powerful evidence to counter the postmortem rumination that can occur after seemingly successful social encounters.

Session 12: The final session reviews the gains that each participant has made. Members are asked to reflect

on how their perceptions of being in a group environment has changed from being a form of *in vivo* exposure to being in a safe place. Members can provide feedback to each other on changes observed over the course of the program. Remaining challenges are identified and necessary steps to achieve long-term goals are outlined. Most members have had significant social anxiety since adolescence or “as long as they can remember,” and they can be reminded that the realistic goal of the group was “to launch, rather than to cure.” Relapse prevention, support groups, and appropriate self-help books are also discussed. An informal period with coffee and doughnuts often concludes the group and serves both as a final group exposure and as a positive, “graduation” experience.

IV. APPLICATIONS AND EXCLUSIONS

Almost any behavioral therapy that is used in an individual (one-to-one) format can be implemented as a group therapy. Examples include behavioral treatments for mood disorders, anxiety disorders, eating disorders, and substance-use disorders. Group size, session duration, and session frequency can be adapted to fit the specific needs and resources of a given treatment setting. Groups typically consist of 8 to 10 patients and 1 to 2 therapists. Group sessions are typically 2 to 2.5 hours, and last from 10 to 14 weeks.

BGT can be either generic or problem-specific. Generic groups impart general skills, such as social skills training or cognitive restructuring techniques. Such groups can therefore contain patients with a variety of different problems. A group might consist of a mix of patients with mood and anxiety disorders. Generic groups are most effective when they impart skills relevant to all group members. Cognitive restructuring, for example, would be useful for most people with emotional disorders. Other interventions, such as exposure exercises, are useful for only some patients (e.g., those with phobias) and therefore are used sparingly in a generic group treatment.

Problem-specific programs treat more homogeneous groups of patients. Examples of panic disorder and social phobia programs were described earlier. Other examples include protocols specifically for depressed patients, and protocols specific for patients with bulimia nervosa. There has been little research on whether generic or specific programs are most effective. Patients with emotional disorders are likely to

have more than one problem. A patient with posttraumatic stress disorder, for instance, is also likely to have a comorbid mood disorder. These patients would benefit from a generic program, which teaches skills relevant to each of the person's problems. However, generic programs are not always sufficient. Sometimes it is important for the patient to receive specific treatment, focusing on his or her main problem.

There are several factors to bear in mind when deciding whether or not a patient is suitable for group rather than individual therapy. Patient preference and therapist resources are important considerations. For many treatment programs, the problem of long waiting lists has been addressed by conducting most treatment in groups, thereby increasing the number of patients that can be treated at a given time. Patients desiring individual treatment may have to wait longer for a therapist to become available. Group composition is another important consideration in selecting participants. Ideally, groups contain patients with approximately the same level of impairment. Patients who are functioning either at a much higher or much lower level than other group members may feel alienated from the group, and the interventions may not be optimal for the patient's problems. To illustrate, consider a group program for major depression, which would consist of behavioral exercises (distraction training, mastery and pleasure exercises) and cognitive restructuring. Patients with moderate depression tend to benefit from each of these interventions. Patients with severe depression are most likely to benefit from behavioral exercises. Accordingly, a patient with severe depression would not benefit from the interventions used in a group consisting mostly of patients with moderate depression. Such a patient would be best treated either individually or in a group of patients who are all severely depressed.

A related consideration in selecting group versus individual treatment concerns the interpersonal style of the patient. Patients who are very hostile or suspicious may prove to be too disruptive for inclusion in group therapy. For the most part, however, most patients suitable for individual therapy can be effectively treated in group therapy.

V. EMPIRICAL STUDIES

Few studies have directly compared the efficacy of group versus individual treatments. More often, these formats have been compared in meta-analyses, which are statistical methods for combining data from large

numbers of outcome studies in order to evaluate the efficacy of various interventions. Research has revealed few differences between the efficacy of group versus individual protocols for treating specific disorders. The formats have been found to be equally effective for a variety of disorders, including social phobia, posttraumatic stress disorder, panic disorder, and other disorders. Thus, the average patient benefits as much from group as from individual therapy. Finally, although particular patients may benefit more from one format than another, research has revealed few ways of reliably identifying these patients. An important area for further research in CBT in general is the identification of individual differences in suitability for these treatment modalities.

VI. SUMMARY

BGT is an effective treatment strategy that can be applied to a number of different conditions and context. It is a structured approach that contains both generic and specific modules, depending on the nature of the target condition. Most forms of BGT include both exposure and cognitive restructuring. Homework exercises and review of activities outside of group are an important feature. BGT is a relatively short-term treatment and the number of sessions is fixed. An important goal is to impart effective coping skills and to promote self-efficacy. BGT is also an approach that transports well—in many instances it can be effectively delivered by paraprofessionals outside of specialty clinics.

See Also the Following Articles

Anxiety Disorders: Brief Intensive Group Cognitive Behavioral Therapy ■ Cognitive Behavior Group Therapy ■ Group Psychotherapy ■ Psychodynamic Group Psychotherapy ■ Self-Help Groups ■ Therapeutic Factors

Further Reading

- Craske, M. G., & Barlow, D. H. (1993). In D.H. Barlow (Ed.), *Clinical handbook of psychological disorders (2nd ed.)*. New York: Guilford.
- Fedoroff, I. C., & Taylor, S. (2001). Psychological and pharmacological treatments for social phobia: A meta-analysis. *Journal of Clinical Psychopharmacology*, 21, 311–324.
- Foa, E. B., & Kozak, M. J. (1986). Emotional processing of fear: Exposure to corrective information. *Psych. Bull.* 99, 20.
- Hawton, K., Salkovskis, P. M., Kirk, J., & Clark, D. M. (Eds.). (1989). *Cognitive behaviour therapy for psychiatric problems: A practical guide*. Oxford: Oxford University Press.

- Hope, D. A., & Heimberg, R. G. (1993). Social phobia and social anxiety. In D.H. Barlow (Ed.), *Clinical handbook of psychological disorders (2nd ed.)*. New York: Guilford.
- Sank, L. I., & Shaffer, C. S. (1984). *A therapist's manual for cognitive behavior therapy in groups*. New York: Plenum.
- Taylor, S. (2000). *Understanding and treating panic disorder: cognitive-behavioural approaches*. New York: Wiley.
- van Etten, M., & Taylor, S. (1998). Comparative efficacy of treatments for posttraumatic stress disorder: A meta-analysis. *Clinical Psychology and Psychotherapy*, 5, 126.

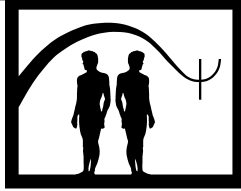

Behavioral Marital Therapy

Gary R. Birchler

University of California, San Diego

- I. Description of Treatment
 - II. Theoretical Bases
 - III. Applications and Exclusions
 - IV. Empirical Studies
 - V. Case Illustration
 - VI. Summary
- Further Reading

GLOSSARY

exchange theory The quality of social relationships is influenced by the interdependence of reinforcement and the reward–cost ratio of behaviors exchanged in these relationships.

social learning theory Interpersonal behavior is determined by controlling variables in the social environment and by individuals' cognitive-perceptual processes that are used to interpret these behaviors.

Behavioral marital therapy (BMT) is a well-known and empirically validated psychoeducational approach to the assessment and treatment of marital distress. BMT originated in the late 1960s and has evolved into a comprehensive and systematic therapeutic approach that features multimethod assessment procedures and at least two primary intervention components: communication and problem-solving training and behavioral exchange techniques. Although focus on interpersonal behavior

change is a hallmark of the approach, developments over the past decade have incorporated the evaluation and modification of cognitive and affective variables that may serve to mediate marital dysfunction.

I. DESCRIPTION OF TREATMENT

Since its inception in the late 1960s, behavioral marital therapy (BMT) has incorporated a multimethod assessment approach to the conceptualization and treatment of distressed marriages, followed by interventions inspired primarily by the tenets of social learning theory. The approach has been subjected to rigorous empirical investigations and, as a result, it has evolved over three decades to include not only behavioral variables, but also the investigation and incorporation of cognitive and affective variables. Moreover, the name of the approach itself, traditionally called behavioral marital therapy, has given way to behavioral couples therapy in many settings. The idea is that, in practice, the approach can be applied as effectively to treat nonmarital relationships (e.g., heterosexual couples living together, same-sex relationships, any adult dyad attempting to establish and maintain an intimate relationship), as well as to treat married couples.

A. Assessment

BMT has a fairly distinct tradition of beginning the couple evaluation process by employing three or four

different methods of gathering information to understand the problems and strengths of a given relationship and to plan various interventions to accomplish the therapeutic goals. First, there are a series of semi-structured clinical interviews, typically 2 to 3 sessions, which often include separate meetings with each partner as well as meeting the couple in a conjoint format. In general, the objectives of these so-called assessment interviews are to (1) screen clients for the appropriateness of couple therapy, (2) determine the nature and course of events related to partners' presenting complaints, (3) determine the goals and objectives of the partners for couple therapy, (4) establish an effective therapeutic relationship, and (5) orient the couple to the therapist's orientation and approach to treatment.

Each partner has one or more reasons for initiating couple therapy. Typically, in the first meeting, the therapist will help the partners to develop a problem list, which indicates each person's perception of the various problems in the relationship. Problems can be categorized into matters of content and process. Problematic content areas often include finances, sex, dealing with in-laws, raising children, struggling with partners' annoying personality traits or mental illnesses, or coping with specific stresses that adversely impact the marriage, such as unemployment, major physical illnesses, or other traumatic events external to the couple relationship. Process concerns have to do with *how* the couple interacts. Typical complaints include ineffective ways of communicating with one another and discord regarding how they attempt to solve problems and manage marital conflicts.

It is also important during the evaluation stage to ascertain the partners' respective goals and expectations for couple therapy. For example, are they both committed to the relationship or is one partner planning separation or divorce? Are the identified problems negotiable for both partners? Are their goals and expectations realistic given partners' levels of competence and motivation? Before making a viable treatment plan, all these interpersonal competence and motivational issues must be considered. Finally, the initial interviews allow for the therapist to establish a therapeutic relationship with the couple. The therapist must gain sufficient credibility and trust and offer hope that the partners' pain, suffering, dissatisfaction, and distress can be addressed effectively. If this step is not accomplished, likely the couple will not continue with therapy. One way to aid in the accomplishment of this preliminary bonding is to explain in advance the purpose and value of the various evaluation and intervention procedures. What is expected from the

clients? What are the role and responsibilities of the therapist? How will information be gathered and what is the prognosis for resolving their problems? An open discussion about what will be done and why is another hallmark of the BMT approach.

A second fairly unique assessment procedure used in BMT to gather diagnostic information about the couple is the administration of various questionnaires and inventories to learn about specific strengths and problem areas. The discussion of specific measures is beyond the scope of this article. Suffice it to say that there exist several standardized measures that are designed to assess one or more of the following variables: global relationship satisfaction; communication skills and deficits; areas of change requested by the partners; types of conflict; intensity levels of conflict and styles of conflict resolution; partners' cognitions, expectations, and beliefs about the relationship that may be causing problems; sexual function and dissatisfaction; participation in pleasurable events and rewarding social activities; and steps toward divorce. BMT practitioners typically ask the couple to complete a selected set of these instruments either before or at the very beginning of the evaluation process. Often feedback and interpretation of the results are given to the couple regarding their responses.

The third assessment procedure that is routinely associated with the practice of BMT is observation and analysis of a sample of *in vivo* marital conflict interaction. That is, couples are helped to identify an existing issue about which they have disagreement; they are asked to spend 10 to 15 minutes in the session talking together in a demonstration of just how they go about attempting to resolve an existing marital conflict. The therapist may or may not leave the room to less obtrusively observe and/or to videotape the communication sample for later review and analysis. The conflict resolution communication sample provides unique and important information regarding the level of problem-solving skill the couple possesses to resolve relationship conflicts and the extent to which improvement in these processes will become treatment goals.

In many programs associated with BMT, a fourth assessment procedure involves asking partners to collect data about events and interactions that occur in their home environments. In an attempt to obtain reliable information about the baseline (i.e., before treatment) frequency of certain events (e.g., arguments per week in which either partner loses one's temper), partners may be asked to observe and count the frequency of these events. Accordingly, later when treatment interventions are introduced, partners may again be asked

to count these events to determine if improvement has occurred. Some BMT programs gather these data as part of the assessment stage; others may postpone this so-called spouse observation procedure until the formal intervention stage of treatment.

In conclusion, the multimethod assessment procedures employed by BMT practitioners provide both converging and diverging types of information that are used in a systematic manner to conceptualize relationship dysfunction (and relationship strengths) and to formulate a treatment plan (i.e., interventions).

B. Interventions

From its inception, the traditional interventions associated with BMT have included communication and problem-solving skills training and behavioral exchange techniques. Over the years, in many empirical studies, both interventions have been shown to be highly correlated with marital satisfaction. Although “communication problem” is probably the number one complaint of couples seeking therapy and most therapy approaches work on improving communication between partners in some manner, the hallmark of BMT has been direct training in skill acquisition. The therapist is likely to employ a basic communication training manual, such as *We Can Work It Out*, written by Clifford Notarius and Howard Markman in 1993. Throughout the course of treatment, the therapist employs any number of the following types of interventions to help couples modify their patterns of miscommunication and to acquire improved problem-solving skills: didactic instruction, behavioral rehearsal, coaching and feedback about practicing the skills, videotape feedback, and regular homework assignments to support generalization of the new skills into the home environment. Often, the couple learns to improve basic expressive and listening skills first and then is taught how to apply these skills progressively to the various problems in their relationship. Thus, a second phase of communication training emphasizes skills related to problem-solving and conflict management. Typically, some variation of the universal problem-solving model is taught, which includes five remedial steps that are designed to modify the couple’s maladaptive interaction patterns: agenda building, mutual definition of the problem, brainstorming, implementing the solution, and evaluation or modification of the initial plan.

Usually concurrent with the communication and problem-solving interventions is the introduction of behavioral exchange techniques. Based on the principles of social learning theory and exchange theory, emphasis is

placed on helping partners to define and instigate increases in positive behaviors and to reduce negative behaviors that are exchanged by partners in their home environment. A technique called contingency contracting may be employed, where partners enter into written behavioral contracts to increase or decrease certain targeted behaviors. If the behavioral goal is accomplished, a reward for the individual or couple may be earned; if failure to perform the agreed-on behavior occurs, a punishment may be invoked. More recently, using a bank account analogy, practitioners of BMT have helped distressed couples to reduce or eliminate what either partner might experience as withdrawals from the relationship bank account (e.g., criticisms, starting arguments, inconsiderate or disliked behaviors) and to make positive deposits into the relationship account (e.g., initiate quality activities together, increase caring behaviors or other behaviors that partners find pleasing). Over the course of couple therapy, a systematic approach is employed whereby at first the easiest changes are made, followed by work on the more difficult areas of partner interaction and compatibility. Unlike the communication and problem-solving interventions, which take place largely within the therapy sessions, behavioral exchange assignments are carried out in the couples’ home environments. Much emphasis is placed on developing homework assignments that are likely to be successful and that achieve the couples’ desired goals.

As a therapeutic approach, BMT also is known for applying the same two basic interventions described above to specific areas of interaction with which distressed couples often have to contend. For example, several sessions may be devoted to systematically enhancing communication about and designing home-based behavioral interventions for parent training, sexual dysfunction, financial management, and mild cases of domestic violence. BMT also has been effectively applied as a concurrent or secondary treatment to manage partner’s individual problems, especially when these problems adversely affect the relationship or the quality of the relationship causes or exacerbates these individual problems. Examples of individual problems often treated, in part, with BMT include anger management, depression and anxiety management, and substance abuse.

Finally, during the past decade, in particular, many clinical investigators have developed models of couple therapy that have expanded the traditional BMT approach to incorporate the identification and modification of important cognitive and affective variables. That is, part of the communication and problem-solving training

that is done during BMT may well include helping partners to recognize and alter certain maladaptive cognitions that interfere with the well-being of the relationship. For example, if partners have unrealistic expectations or beliefs about their partners or the relationship, or if they have certain biases, prejudices, or make faulty attributions, then these cognitive variables may appropriately be targets of therapeutic intervention. Partners can be taught to recognize these beliefs or persistent themes both in the treatment sessions and at home, to determine their accuracy and influence on the relationship, and to make modifications if appropriate. Similarly, it is recognized that affective variables (i.e., feeling reactions) often developed over time within the individual partners may be playing important roles in causing or maintaining relationship distress. Primarily within therapy sessions, partners can be helped to explore the origins of certain negative, disruptive, or intimacy-inhibiting feelings. For example, fears of rejection or abandonment, avoidance of conflict, and anger outbursts that occur out of proportion to the present situation are all feeling states that can serve to influence the relationship negatively. Clients may be helped to consider the possibility of learning how to understand and manage these types of feelings more constructively.

In summary, over three decades of development, BMT has offered a psychoeducational, behaviorally oriented approach to the assessment and treatment of couple distress that has been expanded to include interventions targeting maladaptive behaviors, cognitions, and affective variables and instigating positive changes in these modes of function for the betterment of the couple relationship.

II. THEORETICAL BASES

BMT has generally been defined as the application of social learning theory and behavioral exchange principles to the treatment of marital distress. During the past decade, BMT has expanded to include an analysis of cognitive and affective variables that influence or control behavior. Social learning theory posits that interpersonal behavior is determined by a combination of variables related to what happens in an individual's social environment and to one's cognitions and perceptions about these events. Accordingly, as regards marital interaction and satisfaction, the social or interpersonal environment is a primary determinant. If these theories suggest that behavior is a function of its antecedents and consequences and that the perceived quality of a relationship is primarily a function of the behaviors exchanged be-

tween partners, then interventions designed to promote rewarding (i.e., positively perceived) behaviors and to reduce or eliminate punishing (i.e., negatively perceived) behaviors would help improve partners' satisfaction with the marriage.

Cognitive and perceptual processes have been theorized to mediate between overt behavioral exchanges. Partners' personal interpretations or attributions regarding the occurrence and/or meaning of the behaviors can be critical regarding their value in the relationship. For example, if a wife has a desperate fear and prevailing belief that her husband does not love her, it may be that otherwise positive behaviors emitted by the husband will not be appropriately recognized by her. Moreover, if his intended positive value is not received, she may even criticize or discredit him for offering the behavior. Additionally, affect as experienced by the partners is theorized to play an important role in controlling both functional and dysfunctional processes in intimate relationships. For example, if the husband was neglected emotionally as a child, he may have learned to experience a disproportionate negative emotional response when his wife attempts to be more independent and self-sustaining than is comfortable for him. Helping both partners to discover and to understand this emotional connection between his family-of-origin upbringing and their marital events may facilitate attitudinal and/or behavioral changes that can help to improve the situation.

Taking principles of social learning theory toward a theory of therapeutic change in couple therapy means assessing which attitudes, behaviors, and related problems constitute the complaints and target variables for intervention. The goal is to increase the rewarding and to decrease the punishing behaviors exchanged between partners and to identify and improve the nature of any cognitive and affective mediating variables that may influence the occurrence and interpretation of these behaviors.

III. APPLICATIONS AND EXCLUSIONS

Generally speaking, BMT is most appropriately considered when couple distress is the primary problem or when certain nonrelationship factors have caused significant relationship distress, and the couple, as a unit, needs therapeutic attention. There are no known restrictions in the application of BMT to diverse ethnic, racial, national, age, gender, or socioeconomic groups. However, regarding couple-specific features, BMT is thought to be most effective when the partners possess

the abilities to collaborate toward mutual objectives of change, to offer support and accommodation to one another while addressing the problems at hand, and, when necessary, to compromise with one another in resolving their defined problems. When these criteria are met, a combined emphasis on behavior exchange and communication/problem-solving interventions has been quite effective. In comparison, because BMT is fundamentally change-oriented, the approach may be less effective when the couple's level of relationship distress is very high, one or both partners' commitment to the marriage is low, the issues in conflict are unlikely to change, the couple is invested in maintaining traditional sex roles, or the couple is unable or unwilling to collaborate, accommodate, or compromise with one another. In these cases, while couple therapy may be indicated, an approach less focused on behavior change probably would be more effective (e.g., integrative behavioral couple therapy, emotion-focused couple therapy, insight-oriented couple therapy).

Of course, in terms of exclusions, there are a number of situations where couple therapy, in general, is not the treatment of choice—at least initially. If either partner's level of individual psychopathology is too severe to be managed or treated in conjoint therapy, alternative treatments should be considered (e.g., hospital inpatient milieu, individual or group psychotherapy, and/or pharmacotherapy). For example, certain personality disorders (i.e., antisocial personality disorder, ASPD) may include a predisposition and learning history regarding the use of physical violence to gain or maintain control of someone. Cases featuring domestic violence and including individuals with ASPD often are not appropriate for BMT. Similarly, therapists may encounter other instances of major individual psychopathology where BMT is excluded, at least as the primary treatment of choice, such as active psychoses, disabling disorders of depression, anxiety, or substance abuse. In such cases, the individual problems should be treated in lieu of BMT. If and when the individual problems are treated and they are improved at least to the point where a relationship focus is appropriate in therapy, then BMT may well be indicated as a concurrent or secondary treatment approach.

IV. EMPIRICAL STUDIES

In a review of the empirical literature on BMT in 1998, Donald Baucom and his associates indicated that over two dozen well-controlled studies have been performed evaluating the efficacy and effectiveness of

BMT. BMT is the most widely evaluated form of marital treatment. For the past three decades, many direct studies and several meta-analytic investigations of multiple studies have confirmed that BMT, as an integrated approach, is a statistically and clinically efficacious treatment when compared to waiting list control groups and nonspecific treatment or placebo control groups. In general, the research has not found the specific components of BMT (i.e., behavioral exchange vs. communication/problem-solving training) to be differentially effective, nor has BMT been demonstrably more or less effective than other marital therapy approaches to which it has been compared directly.

Regarding the impact of BMT on couples' lives, reviews of multiple studies suggested that based on various relationship assessment scores obtained pre- and posttreatment, 56 to 66% of the couples treated with BMT improved significantly and 35 to 54% reported that their levels of marital satisfaction changed from the clinically distressed to the nondistressed scoring ranges. Follow-up outcome data from these studies suggest that most couples maintain these gains for 6 months to a year, with some relapse indicated 2 to 4 years following treatment. Finally, given the limited data available, it appears that over 90% of couples treated with BMT find the approach worthwhile and would recommend it to a friend in need; the couple dropout rate for couples entering BMT has been estimated at only 6%. In conclusion, in many empirical studies completed over 30 years of investigation, BMT has been shown to be a valid, efficacious, and effective treatment for marital distress.

V. CASE ILLUSTRATION

A. Intake Session and Inventory Assessments

A friend referred Cindy and Bob to the clinic. They were in their early thirties, had been married for 6 years, and had two daughters, aged 2 and 4. It was the second marriage for Bob, a boiler repairman and mechanical engineer, and the first for Cindy, who was occupied as a housewife and mother. During the initial clinical interview the co-therapist team asked about presenting complaints and the precipitating event leading to the initiation of therapy. When asked, "Why are you seeking help now?" Bob said that he had recently admitted to having an affair with a young woman he had met during his rather extensive car racing activities. Bob claimed that since the birth of their second

child Cindy's role had become almost exclusively one of mothering instead of being a wife (i.e., a loving sexual partner). With their relationship and sex life faltering, Bob became more involved with car racing activities, met an attractive, seductive girl, and succumbed to the affair over a period of several months. Beset with guilt and the frustration regarding spouses' increasingly incompatible roles, however, he finally told Cindy about the affair.

Cindy, claiming that management of the young children and house required a huge amount of her time, asserted that Bob did not appreciate her responsibilities. He was very unhelpful with these tasks and, while spending less and less time at home, he became more and more demanding and resentful about their lack of sexual activity. Cindy, in a fairly unemotional presentation, indicated that she felt hurt, angry, and abused regarding the affair. Nevertheless, the decision to seek professional help was primarily Bob's in that he wanted to "make or break" the marriage in order to relieve his ambivalence and frustration.

To summarize the content of the first session, the presenting complaints from Bob were inability as yet to emotionally divorce himself from his lover, lack of affection and sex from Cindy, Cindy's tendency to spend more money than they had, and Cindy's excessive attention to children and house. Current relationship strengths that Bob noted were their ability to be effective, loving parents and a basic caring and love for one another. Cindy cited the major problem areas as Bob's general lack of commitment to her and the family, the quantity and quality of sexual interaction, and a desire for a reduction in the one or two nights each week and most of every other full weekend that Bob devoted to racing. Strengths noted by Cindy were their mutual caring for one another, good senses of humor, and being good parents. At the end of the initial session an agreement was made to complete the marriage evaluation process. A marital relationship assessment battery was distributed and the baseline results, obtained within 1 week, are listed in Table 1. The posttherapy scores also are tabulated for later reference.

Very briefly, the pretherapy data in Table 1 indicated that both partners are distressed and dissatisfied with the relationship, Bob significantly more than Cindy (Inventory #1). Bob has seriously entertained the idea of separation and divorce and has initiated certain discussions outside the relationship; Cindy has taken significantly fewer steps toward divorce (Inventory #2). In terms of self-attributions of self-esteem, psychological tension and anxiety, and physical symptoms (Inventory #3), Bob

TABLE 1
Marital Relationship Assessment Battery:
Pre- and Posttherapy Scores

Inventory	Pretherapy		Posttherapy	
	Bob	Cindy	Bob	Cindy
1. Locke-Wallace MAS	47	85	104	116
2. Marital Status Inventory	7	3	7	3
3. Self-Description Inventory				
Self-esteem	6.4	4.3	6.1	5.6
Psychological distress	1.4	3.4	1.8	2.4
Physical symptoms	0.4	1.2	0.5	0.8
4. Areas of Change Questionnaire	16	10	9	4
5. Response to Conflict Scale				
Self-appraisal	2.8	1.0	1.9	0.7
Spouse appraisal	1.4	3.1	1.2	2.1
6. Inventory of Rewarding Activities				
Proportion of activities alone	55%	25%	27%	15%
With spouse only	12%	28%	31%	35%
With spouse and other adults	13%	18%	14%	14%
With family	2%	21%	17%	20%
With other adults, not spouse	18%	8%	11%	12%
Time distribution				
Working	24%	5%	24%	10%
Sleeping	25%	33%	28%	35%
Rewarding activities	32%	9%	22%	21%
Neutral or nonrewarding	20%	52%	26%	34%
7. Sexual Activity				
Worry about sex (0-8 scale)	0	5	2	3
Frequency of intercourse (Past month)	3	7	8	9
Want spouse to initiate sex (-3 to +3)	3	-1	2	0

Note: While quantitative inventories are an important part of BMT, detailed description of the inventories is beyond the scope of this article. Briefly, however, Inventory (Inv.) #1 measures global marital satisfaction; a score of 100 discriminates happy from unhappy couples. Inv. #2 measures steps toward divorce, range 0-14, a score of 4 or greater indicates significant risk. Inv. #3 measures the three named variables regarding individual function; range is 0-8. Inv. #4 measures conflict potential in domestic activities; happy couples average 7 total and unhappy 28 total for husband plus wife scores. Inv. #5 measures spouses' perceptions of maladaptive conflict responses, 0-8 scale; happy couples average 1.35 per person, unhappy couples average 2.77. Inv. #6 measures proportion of rewarding activities each partner engages in, in five social formats. Happy couples endorse a balance of activities across all formats, including about 35% activities with spouse only. Inv. #7 measures various aspects of sexuality: worry, frequency, and initiative.

demonstrated a pattern that strongly suggested denial and minimization of the negative aspects of these dimensions. Generally, such a pattern suggests one is likely to deny or rationalize one's own contribution to marital difficulties and to emphasize the faults of one's partner. In contrast, Cindy's results suggested mild-moderately-low self-esteem, psychological distress, and physical symptoms. The Areas of Change Questionnaire scores (Inventory #4), which total 26 for the couple, fell within the range for distressed couples. Bob's potential conflict score was higher than Cindy's, reflecting his withdrawal from the domestic environment. The Response to Conflict Scale (Inventory #5) indicated that both partners viewed Cindy's responses to conflict as within the normal range, whereas they perceived Bob as responding in a more intense and maladaptive fashion. The Inventory of Rewarding Activities (Inventory #6) can be interpreted in several ways. The gross indicators are, however, that during the past month, Bob has engaged in a majority of elective activities alone and a relatively high proportion with other adults, excluding his spouse. His profile suggested relative deficiencies in elective activities with spouse and family. This pattern was largely the consequence of Bob's long-term withdrawal from the family and his increased outside activities with his racing friends. Cindy's proportions of elective activities were more generally appropriate for a satisfied marriage. Regarding time distribution, in a typical 168-hour week, note that Bob slept an average of only 6 hours a night. He also claimed a solid proportion of rewarding activities. In stark contrast to Bob and consistent with other available data, Cindy indicated very little rewarding time and an overwhelming amount of neutral or nonrewarding activities: 78% of her waking hours! Finally, data about sexual activity (Inventory #7) confirmed that sex was a major problem area. Whereas Bob characteristically denied that sex was a personal concern, he nevertheless indicated a low monthly frequency and called for significantly more initiation by Cindy. In contrast, Cindy did admit to worrying about sex, indicated a desire for Bob to initiate requests less frequently, and reported a higher monthly frequency. In summary, the inventories documented the level and nature of marital dysfunction in many areas. For this couple, there was certainly sufficient self-reported distress to warrant marital therapy.

B. Communication Sample

The 10-minute videotaped communication sample was obtained at the outset of the second evaluation ses-

sion. The conflict issue selected for problem-solving was Bob's involvement in car racing activities. Here is a representative sample of their interaction.

Bob: What is it about my racing?

Cindy: It's just that you spend so much time at it. Last night you worked on the car, tonight you have a meeting and then you will be gone all weekend.

B: Yes, but this is an important race and then there won't be another one until Long Beach. [3 weeks later.] Besides you're invited to come.

C: I know, but I am not able to manage those kids all day by myself and at night you would rather party anyway than be with us. Last time you said you would be home by six and you got home at midnight.

B: I know. I already told you I'm sorry about that? We get so wired all day that it's hard to leave without having a few beers and winding down. What's wrong with that?

C: Nothing! I want you to have a good time, but you promised you would come home early. And when you come home that late you are too tired the next day to do anything with us.

B: [Said with disgust.] Well, maybe I should quit racing, but it's the only fun thing I do!

C: [With resignation.] No ... you need an outlet, but the kids and I need some time with you too.

At this point, the pattern was set. The remainder of the discussion went similarly round and round. This couple is conflict-avoidant. Little direct anger was expressed throughout the interaction; however, they concurred during debriefing that they probably would not have carried on such a discussion at all at home. As it was, they spent most of their time describing the problem and summarizing their own positions. There was minimal evidence of understanding one another, expression of feelings, or problem solution statements. Unlike many couples, however, they did manage to stay on the topic, they shared the talk time, and they demonstrated fair-to-good nonverbal sending and listening skills. Unfortunately, their natural pattern at home was to withdraw from potential conflict discussions even before reaching the level of wheel-spinning problem description evident in the observed sample.

C. Treatment Goals and Interventions

By the end of the evaluation period, good rapport had been established between therapists and clients, there was a consensus on the problems and goals of therapy, and a treatment contract was set for 10 sessions. Goals

and intervention methods are indicated in Table 2 in the tentative order of sequence.

D. Treatment Progress

At the outset both Bob and Cindy seemed motivated to improve their marriage. While admitting to some emotional ambivalence about being with wife versus lover, Bob indicated that he wanted to stay with the family and make the marriage more rewarding. He had terminated contacts with his lover. Bob and Cindy made very good early progress. In fact, with only an average amount of direction, encouragement, repeated assignments, and reinforcement by the therapists, they did quite well through the beginning stage of therapy and part way through the middle stage.

The difficulties arose when goal 7 (in Table 2) was broached through explicit focus on treatment goal 8. Treatment session number six had ended with an assignment extending goal 2 into sexual interaction. The therapists designed the assignment carefully so it would be successful. On a given day, Bob agreed to come home by 5 P.M., to shower, and to help Cindy feed and bed the kids by 8 P.M. That would leave about 3 hours for them to have a nice, jointly prepared dinner, to relax for awhile, and then to engage in a pleasurable sexual encounter. The therapists suspected that if major resistance were going to emerge, it would be associated with movement toward increased intimacy (i.e., confronting the risk of rejection) through a sexually oriented assignment. Their concerns were well founded. Possibly giving off mixed signals, after dinner the two combined to fail the assignment. Bob started to watch the news on TV waiting for Cindy to initiate the romance; she thought he was too comfortable and not interested in having sex and got involved in a different activity. During the therapy session, exploration of cognitions and feelings indicated that Cindy was still a little unsure of herself as a competent sexual partner and thus was reluctant to initiate affectionate interaction. At the same time, she became aware of lingering, if unexpressed, resentment about Bob's affair. She wanted to be given special attention and to be seduced. In Bob's case, he was still vulnerable to their old interaction pattern and his self-defeating thinking style: "If Cindy really cares about me, knowing that I want sex and affection, she will initiate it; I'm tired of always having to be the initiator." In addition, Bob admitted that although he had no contact with his girlfriend, he still occasionally experienced strong feelings for her. The therapists pointed out that such expectations and

TABLE 2
Treatment Plan for Bob and Cindy

Goals	Interventions
1. Establish collaborative set	Persuasion and didactic instruction in systems thinking; homework assignments that require and reward couple collaboration; therapist reinforcement for teamwork
2. Increase contact time for Bob and Cindy; Bob and family	Negotiation, structured homework assignments, e.g., caring activities, mutually rewarding couple and family activities
3. Increase couple communication	Basic communication skills training in session; graded assignments at home—assigned reading, discussion, and exercises.
4. Increase Cindy's independent rewarding activities	Negotiated resource allocation, e.g., money for babysitters; homework assignments
5. Increase problem-solving and conflict-resolution skills	In-session training in problem solving and conflict-management skills; structured homework
6. Resolve financial management issues	Apply problem-solving skills; establish budget
7. Increase Bob's father role and decrease his "sex-deprived, errant husband" role; increase Cindy's wife role and decrease her "overburdened mother-housewife" role	Systematic assignments above that foster one role over the other; therapist reinforcement of role shifts; techniques of dealing with blocks to progress
8. Increase quality of sexual interaction	Graded assignments, e.g., caring activities; structured exercises, e.g., sensate focusing; communication skills about sexual interaction
9. Resolve Bob's ambivalence concerning wife versus lover	A planned and eventual consequence of all the above

mixed emotions were likely to be self and relationship defeating, particularly when left nonverbal (i.e., as hidden agenda). The remainder of the session was devoted to the careful design of another romantic evening together with encouragement to explicitly discuss their ongoing expectations and feelings.

Over the final few sessions, with much more open communication, they were able to reconstruct a better sex life. The therapeutic emphasis was on mutual responsibility for initiation of and response to sexual behaviors. Bob learned that in exchange for less frequency (e.g., two to three rather than five encounters per week) that quality could be improved in terms of Cindy's responsiveness, enthusiasm, and active participation. Moreover, with modest decreases in Bob's working late and racing activities, there was increased contact time available for the full gamut of family and relationship business. This included sex and affection sometimes initiated by Cindy.

E. Posttherapy Assessment and Follow-Up

The posttreatment communication sample reflected increased collaboration and assertiveness during conflict resolution by both partners. The Marital Relationship Assessment Battery posttherapy results are presented in Table 1. These data suggested significant improvements in many of the relationship indicators. At 6-week follow-up, both partners claimed that they had maintained the improvement in marital satisfaction.

VI. SUMMARY

Behavioral marital therapy consists of fairly distinct assessment and intervention phases. First, a multi-method assessment of the behavioral problems and strengths of the distressed relationship is accomplished through the use of semistructured clinical interviews, standardized marital inventories, observed samples of problem-solving conflict resolution in the clinic, and possibly information derived from spouse observation in the home environment. Based on the results for a given couple, a treatment plan is devised that typically

includes at least two major interventions designed to improve presenting complaints: communication and problem-solving training and behavioral exchange assignments. In this context, couples learn how to improve the ratio of pleasing-to-displeasing behaviors, how to be more open and effective in communicating about important relationship issues, and how to more effectively solve problems and manage their marital conflicts. The primary focus is on applying interpersonal behavior change technology. However, partners' cognitions and affective states also are considered and may be targeted for intervention. After a typically brief course of therapy (i.e., 12 to 20 sessions), posttherapy assessments are repeated and one or more follow-up sessions are planned to assess and to help maintain gains made in treatment.

See Also the Following Articles

Behavioral Group Therapy ■ Couples Therapy: Insight Oriented ■ Family Therapy ■ Psychodynamic Couples Therapy ■ Spouse-Aided Therapy

Further Reading

- Baucom, D. H., Shoham, V., Mueser, K. T., Daiuto, A. D., & Stickle, T. R. (1998). Empirically supported couple and family interventions for marital distress and adult mental health problems. *Journal of Consulting and Clinical Psychology*, 66, 53.
- Birchler, G. R., & Schwartz, L. (1994). Marital dyads. In M. Hersen & S. M. Turner (Eds.), *Diagnostic interviewing*, 2nd Ed. New York: Plenum.
- Jacobson, N. S., & Margolin, G. (1979). *Marital therapy: Strategies based on social learning and behavior exchange principles*. New York: Brunner/Mazel.
- Notarius, C., & Markman, H. (1993). *We can work it out: Making sense of marital conflict*. New York: Putnam.
- Stuart, R. B. (1980). *Helping couples change*. New York: Guilford.

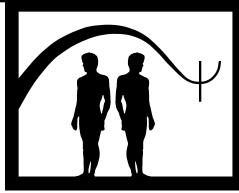

Behavioral Therapy Instructions

Amy M. Combs-Lane, Joanne L. Davis, Adrienne E. Fricker, and Ron Acierno

Medical University of South Carolina

- I. Description of Treatment
- II. Theoretical Bases
- III. Empirical Studies
- IV. Summary
- Further Reading

convey information and provide direction to clients in the context of making behavioral changes. This article will provide a detailed description of instructions for behavioral therapy and a review of theory and empirical studies pertaining to the manner in which instructions are provided by behavior therapists.

GLOSSARY

antecedent variable An environmental stimulus that cues a particular behavioral response, including both emotional or physiological responses (e.g., sadness, fear, panic) and instrumental responses (e.g., escape in response to a feared stimulus). An antecedent event for a spider phobic would be seeing a spider.

consequent variable Reinforcement or punishment that follows a particular behavioral response (e.g., praise, approval, attention, monetary reward, removal of privilege).

modeling Learning that occurs from the observation of others and observation of the consequences of another's behavior, as well as any imitative change in behavior that follows.

psychoeducation Educational materials designed to explain the manner in which psychological phenomena occur and to provide a rationale for specific treatment approaches.

role-playing Acting out ways of handling real-life situations for the purpose of modifying maladaptive ways of responding and replacing them with more adaptive ones, or for learning and practicing a newly acquired skill. Also referred to as behavioral rehearsal.

Instructions for behavioral therapy encompass a variety of methods that behavior therapists employ to

I. DESCRIPTION OF TREATMENT

In behavioral therapy, instructions to clients tend to be specific, structured, and directive. Behavior therapists maintain a focus on specific problems, as opposed to underlying causes or traits, and assess the antecedents, consequences, and maintaining factors for behavior. Although goals for treatment are often developed in collaboration with clients, behavior therapists take primary responsibility for the direction of therapy sessions, establishing the agenda and structuring the session. Instructions are conveyed through psychoeducation, direct feedback, homework assignments, and specific techniques.

A. Psychoeducation

Behavior therapists provide information that is designed to educate clients about therapeutic processes, including conceptualization of the target problem, procedures to be used, effectiveness of a given procedure, likelihood of change, and the respective roles of therapist and client in achieving behavioral change.

In educating clients about the conceptualization of a problem, behavior therapists provide explanations of presenting symptoms from a learning theory perspective, focusing on factors that serve to maintain problem behaviors. Concrete examples are often provided, and clients are encouraged to think of prior learning experiences that illustrate specific concepts. For instance, in explaining factors that often serve to maintain a fear of public speaking, the therapist may ask the client to recall past experiences with public speaking in order to identify maladaptive cognitions (e.g., “I am making a fool of myself”) and behaviors (e.g., talking quickly, leaving the situation in order to avoid speaking) that were present.

Behavior therapists rely on the empirical literature to guide treatment choices and provide explanations of the rationale for treatment. In addition to providing verbal explanations of a problem’s causes and subsequent rationale for treatment, clients are often provided with educational materials in written form, and asked to read the materials as homework assignments. The ultimate goal of educating clients about the conceptualization of the problem and treatment procedures is to arrive at a consensus regarding the treatment plan and implementation.

Considerable attention has been devoted to the study of a client’s expectations of change and the roles of client and therapist in bringing about change. In general, behavior therapists attempt to understand the client’s expectations of therapy, to correct misperceptions, to educate clients about the rationale for selecting certain procedures, and to motivate clients to have positive expectations for change.

B. Direct Feedback

Behavior therapists provide instructions through direct feedback. Target behaviors are assessed on an ongoing basis and feedback is provided regularly throughout treatment. In-session observations provide a sample of behavior and may indicate progress toward specific goals. Specific suggestions are made regarding behavioral changes. For example, in working with an individual with depressed mood, a behavior therapist may provide feedback that decreased activity and withdrawal from others are contributing to the client’s depression. Therefore, behavioral activation strategies may be recommended, and in collaboration with the client, a specific plan established for ways to increase activity level.

C. Homework Assignments

Behavior therapists incorporate homework assignments in treatment in order to bring about change and encourage generalization of behaviors to environmental contexts outside of the therapy session. Examples of homework assignments include practicing a relaxation exercise two times per day, engaging in daily *in vivo* exposure practices, and completing a writing assignment. Specific instructions are provided regarding how to complete homework assignments. The parameters for assignments may include the duration and frequency of tasks, how to structure the environment, and efforts to anticipate factors that may interfere with successful completion of the assignment. Often, monitoring forms are provided so that clients can record the occurrence of specific behaviors between sessions, as well as provide documentation of completed exercises. For example, clients may be asked to monitor daily mood and anxiety levels using a 10-point scale or to record cognitions that occurred in the context of specific tasks.

D. Specific Techniques

Behavioral therapists provide instructions through a variety of methods. Throughout treatment, teaching, modeling, and role-playing may be used to instruct clients in how to engage in particular behaviors. The following three techniques are often combined in a single session.

1. Didactic Teaching

Behavior therapy relies on didactic teaching to explain behavioral concepts and to instruct clients in how to complete exercises. Individuals are often presented with psychoeducational materials in both verbal and written formats, with the aim of informing them of the various factors that are maintaining maladaptive behaviors. For instance, in presenting information regarding diaphragmatic breathing to individuals with a history of panic attacks, behavior therapists may provide a description of the physiology of panic, followed by an explanation of how certain cognitive and behavioral responses, such as hyperventilation, serve to maintain and increase physiological responses. The therapist may then proceed to explain the rationale for diaphragmatic breathing and demonstrate this technique in session.

2. Modeling

Therapists employ modeling to demonstrate appropriate performance of certain behaviors. With

modeling instructions may be presented both verbally and visually. Although it is possible to utilize a videotaped or imagined model, often the therapist serves as the model in session, demonstrating a specific technique, then asking the client to imitate the behavior. Using diaphragmatic breathing as an example, the therapist may first describe the procedure, ask the client to watch while the technique is demonstrated, and then have the client perform the procedure. Feedback is then given to clients regarding their performance. Specific criteria are often established for the client to ensure the procedure is being performed properly. For instance, in behavior therapy designed to improve the interaction between parent and child, parents are instructed to demonstrate a certain number of descriptive statements and praises in an allotted time frame.

3. Role-Playing

Role-playing is employed in behavior therapy to modify maladaptive responses and replace them with new responses. Role-playing may also be used to instruct clients in how to perform a newly acquired behavior or to engage in a behavior in a given context. Therefore, role-playing is an example of behavioral rehearsal in that behaviors are repeatedly acted out until they become part of the individual's behavioral repertoire. This type of instruction is most commonly applied with interpersonal difficulties, especially when problems are associated with assertiveness or social skills.

Role-playing allows the therapist to teach a behavior, to observe the client performing the behavior, and to have the client perform the behavior in the presence of stimulus cues that are likely to be present in real-life situations. For example, a therapist may demonstrate ways of responding assertively to a controlling and demanding spouse. The client may then anticipate certain reactions the spouse may have and the therapist can role-play these reactions so as to provide a closer approximation to real-life circumstances.

II. THEORETICAL BASES

Behavioral therapy represents an approach that is empirically based and strongly rooted in learning theory. The direct and structured manner in which instructions are provided in behavioral therapy reflects a scientific approach. Therapists develop a hypothesis about factors that are maintaining maladaptive behav-

ior, select a method of modifying the behavior, provide instruction in how to achieve behavioral change, monitor progress toward the stated goal, and ensure that behavioral change generalizes to appropriate contexts. Progress toward specific goals is assessed systematically over the course of therapy through monitoring exercises, observations of behavior in session, and information gathered from collateral sources, if pertinent.

III. EMPIRICAL STUDIES

There is a paucity of empirical investigations that have directly addressed the manner in which *instructions* per se are given in behavioral therapy. The closest approximation comes from studies that have evaluated nonspecific treatment effects, referred to as "placebo" effects, in evaluating the effectiveness of behavioral therapy in comparison to more traditional forms of psychotherapy. Nonspecific effects refer to those factors associated with the conduct, rather than content, of psychotherapy: the relationship between the therapist and client, expectations for improvement in the context of a helping relationship, a rationale that establishes the expectation of change, and procedures that involve the interaction of the therapist and client.

Hans Eysenck's work, spanning more than 40 years, has examined the placebo effect as it relates to the evaluation of psychotherapy outcomes. Eysenck has summarized research on psychotherapy effectiveness and concluded that behavior therapy, in comparison to traditional psychotherapies (e.g., psychodynamic, client-centered, Gestalt, rational-emotive), has evidenced greater effect sizes, over and above that which can be attributed to placebo. In current psychotherapy outcome research, there is an effort to differentiate active treatment components from nonspecific effects, holding nonspecific aspects constant across treatment conditions.

IV. SUMMARY

Instructions for behavioral therapy encompass a variety of methods and techniques that behavior therapists employ to provide direction to clients in order to achieve behavioral changes. Behavior therapists maintain a directive stance, establish a specific agenda for therapy sessions, and structure the course of therapy

toward the achievement of specific treatment goals. Behavior therapists utilize psychoeducation, direct feedback, homework assignments, and specific techniques, such as modeling and role-playing, to convey specific concepts and to assist clients in achieving behavioral change.

See Also the Following Articles

Behavioral Assessment ■ Behavioral Consultation and Therapy ■ Behavioral Group Therapy ■ Behavior Therapy: Historical Perspective and Overview ■ Behavior Therapy: Theoretical Bases ■ Role-Playing

Further Reading

- Eysenck, H. J. (1994). The outcome problem in psychotherapy: What have we learned? *Behaviour Research and Therapy*, 32, 477.
- Goldfried, M. R., & Davison, G. C. (1994). *Clinical Behavior Therapy*. New York: John Wiley & Sons.
- Masters, J. C., Burish, T. G., Hollon, S. D., & Rimm, D. C. (1987). *Behavior therapy: Techniques and empirical findings*, 3rd ed. Orlando, FL: Harcourt Brace Jovanovich.
- Mueser, K. T., & Liberman, R. P. (1995). Behavior therapy in practice. In B. Bongar, & L. E. Beutler (Eds.). *Comprehensive textbook of psychotherapy: Theory and practice*. New York: Oxford University Press.

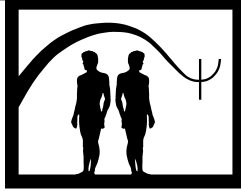

Behavioral Treatment of Insomnia

Jack D. Edinger

Veterans Affairs and Duke University Medical Centers

- I. Nature and Significance of Insomnia
 - II. Theoretical Basis for Behavioral Insomnia Therapies
 - III. Description of Behavioral Insomnia Therapies
 - IV. Empirical Studies
 - V. Summary
- Further Reading

treatment effect size A statistic that reflects the average amount of difference (expressed as a fraction of the pooled standard deviation) observed between a treated and untreated group of patients.

GLOSSARY

cognitive-behavioral insomnia therapy A multifaceted treatment approach designed both to reduce dysfunctional beliefs about sleep and correct sleep-disruptive habits.

insomnia A form of sleep disturbance characterized by difficulty initiating or maintaining sleep or by chronically poor sleep quality. Accompanying the nocturnal sleep difficulty are daytime complaints (e.g., fatigue, poor concentration) and, at times, more serious signs (e.g., poor work performance, compromised social functioning) of dysfunction.

paradoxical intention A treatment strategy in which an individual is instructed to purposefully engage in a feared activity in order to reduce performance anxiety that confounds associated goal-directed behavior.

relaxation therapies A group of behavioral treatments that involve formal exercises, which when practiced repeatedly, lead to increased ability to lower psychological and physiological levels of arousal.

sleep restriction A behavioral strategy in which time in bed at night is restricted in order to encourage a more consolidated sleep pattern.

stimulus control A structured behavioral regimen designed to disassociate a problem behavior or conditioned autonomic response from a specific environmental setting.

Insomnia is a highly prevalent and significant health concern resulting from varied causes. Often misconceptions about sleep and myriad sleep-disruptive habits serve important roles in perpetuating this type of sleep problem. In such cases, behavioral therapies designed specifically to address these perpetuating factors are often required to eradicate the observed sleep difficulties. This chapter briefly describes insomnia, considers the cognitive and behavioral anomalies that contribute to this condition, and reviews the most commonly employed behavioral insomnia therapies.

I. NATURE AND SIGNIFICANCE OF INSOMNIA

Insomnia, characterized by difficulty initiating, maintaining, or obtaining qualitatively satisfying sleep is a widespread health complaint. Like the common cold, most individuals have experienced at least transient bouts of nocturnal sleep difficulty due either to an impending stressful (e.g., final exam) or exciting (e.g., a long-awaited vacation trip) event or due to

acute medical or environmental factors. However, slightly over one-third of the adult population complains of recurring, intermittent sleep difficulties whereas 9 to 10% endure chronic, unrelenting insomnia problems. Although many health care professionals as well as the lay public may minimize its significance, insomnia may have notable short- and long-term consequences. At a minimum, insomnia results in daytime fatigue, decreased mood, and general malaise. In more protracted cases it may cause impaired occupational and social functioning. In addition, there is substantial evidence that insomnia dramatically increases risks for medical complaints, alcohol and drug abuse, and serious psychiatric illnesses. Moreover, insomnia alone contributes to increased health costs and utilization among affected individuals and, in turn, escalates health care costs for society in general. Indeed, insomnia sufferers may collectively spend well over \$285 million per year for prescription sleeping pills whereas the projected annual direct, treatment-related costs of insomnia to the U.S. population may be as high as \$92.5 billion. Thus, chronic insomnia represents a significant public health problem that warrants early detection and treatment.

II. THEORETICAL BASIS FOR BEHAVIORAL INSOMNIA THERAPIES

As might be surmised by the above discussion, sleeping pills remain the most popular treatment for those chronic insomnia sufferers who report sleep complaints to their physicians. Indeed, as many as 50% of those patients who complain of insomnia to their physicians are treated with sedative hypnotics or sedating antidepressant medications to address such complaints. Although these agents may be useful in the management of transient insomnia, they generally fail to provide long-term relief for those with more chronic sleep disturbances. Patients who use hypnotics on a long-term basis often suffer such unwanted effects as drug tolerance, dependence, hang-over, short-term memory loss, and a gradual return of their sleep problems. Side effects may be particularly problematic among elderly hypnotic users who are at increased risk for toxic drug interactions and serious falls resulting from oversedation. Although some recently developed sleeping pills hold the promise of reduced side effects, all currently available sleep

medications represent only symptomatic treatments that fail to address the underlying factors sustaining insomnia. Thus, even the most recently developed sleeping pills often provide little lasting relief for those with chronic sleep disturbances.

Insomnia, as a symptom, often heralds underlying psychiatric, medical, or substance abuse disorders that require treatment before the sleep disturbance can be resolved. Nonetheless, effective and enduring insomnia treatment in many cases requires additional strategies designed to reestablish normal functioning of the human biologic sleep system. According to the 1988 theory of Wilse Webb, normal sleep functioning is regulated by homeostatic mechanisms that respond to increasing periods of wakefulness by increasing the propensity to sleep, circadian mechanisms that regulate the timing of sleep onset and offset, and environmental and behavioral factors that may serve to facilitate or inhibit the sleep process. Assuming adequate functioning of the homeostatic and circadian systems as well as sleep-conducive environmental/behavioral conditions, normal, subjectively satisfying sleep results. However, disruption of normal homeostatic or circadian functioning and/or disruptive environmental/behavioral conditions may contribute to sleep disturbances.

For many insomnia sufferers, normal sleep/wake functioning becomes chronically disrupted through the development of poor sleep habits and conditioned emotional responses that either interfere with normal homeostatic or circadian processes or serve as environmental/behavioral inhibitors to sleep. For example, daytime napping or spending extra time in bed in pursuit of elusive, unpredictable sleep may interfere with normal homeostatic sleep-controlling mechanisms and serve to reduce sleep drive on the ensuing night. Alternately, the habit of remaining in bed well beyond the normal rising time following a poor night's sleep may disrupt the circadian sleep-wake rhythm and make the subsequent night's sleep more difficult. Additionally, the repeated association of the bed with unsuccessful sleep attempts may eventually result in a conditioned arousal in the home sleeping environment. Finally, failure to discontinue mentally demanding work and allot sufficient wind down time before bed may make subsequent sleep initiation very difficult. Because any of these factors may contribute to and perpetuate sleep difficulty, behavioral/psychological interventions that correct these anomalies are often required to eradicate the chronic sleep difficulty.

III. DESCRIPTION OF BEHAVIORAL INSOMNIA THERAPIES

Formal applications of behavioral interventions to insomnia were first reported in the 1950s but such treatments did not gain much popularity until the 1970s. Over the past 30 years, various behavioral insomnia therapies have been developed, tested, and, at times, modified. The nature and specific focus of these treatments has varied significantly in that some are composed of fairly formalized “exercises” designed primarily to address sleep-related performance anxiety and excessive bedtime arousal, whereas others include fairly regimented behavioral prescriptions designed to eliminate sleep-disruptive habits. The following discussion provides brief descriptions of the most commonly employed behavioral insomnia therapies.

A. Relaxation Therapies

Since the late 1950s a host of formal relaxation therapies including progressive muscle relaxation training, autogenic training, imagery training, biofeedback, and hypnosis have all been used to treat insomnia. Common to these approaches is their focus on such factors as performance anxiety and bedtime arousal, which often perpetuate sleep difficulties. Regardless of the specific relaxation strategy employed, treatment entails teaching the insomnia sufferer a formal exercise or set of exercises designed to reduce anxiety and arousal at bedtime so that sleep initiation is facilitated. Typically multiple weekly or biweekly treatment sessions are required to teach relaxation skills that the patient is encouraged to practice at home in order to gain mastery and facility with self-relaxation. The goal of all such treatments is that of assisting the insomnia sufferer in achieving sufficient relaxation skills so that insomnia resulting from sleep-related performance anxiety and bedtime arousal can be minimized or eliminated.

B. Stimulus Control

This approach, introduced by Richard Bootzin in 1972, is based on the assumption that both the timing (bedtime) and setting (bed/bedroom) associated with repeated unsuccessful sleep attempts, over time, become conditioned cues that perpetuate insomnia. As a result, the goal of this treatment is that of reassociating the bed and bedroom with successful sleep attempts. Stimulus control achieves this endpoint by curtailing sleep-incompatible activities in the bed and bedroom

and by enforcing a consistent sleep-wake schedule. In practice, stimulus control requires instructing the insomnia sufferer to (1) go to bed only when sleepy; (2) establish a standard wake-up time; (3) get out of bed whenever awake for more than 15 to 20 minutes; (4) avoid reading, watching TV, eating, worrying, and other sleep-incompatible behaviors in the bed and bedroom; and (5) refrain from daytime napping. From a theoretical perspective, it is probable that strict adherence to this regimen not only corrects aberrant, sleep-disruptive conditioning, but it also likely reestablishes a normal sleep drive and sleep-wake rhythm. From a practical viewpoint, this treatment has appeal since it is easily understood and usually can be administered in one visit. However, follow-up visits are usually conducted to ensure compliance and achieve optimal success.

C. Paradoxical Intention

As the name implies this treatment strategy employs a form of reverse psychology to address sleep difficulties. Designed mainly to address the excessive performance anxiety that contributes to sleep onset difficulties, this treatment instructs the insomnia sufferer to remain awake as long as possible after retiring to bed. In essence, the insomnia sufferer is placed in the paradoxical position of having to perform the activity of not sleeping when in bed. If the individual complies and genuinely tries to remain awake in bed, performance anxiety over not sleeping is alleviated and sleep becomes less difficult to initiate. Like the other treatments, an initial visit to provide treatment instructions and follow-up sessions to support the patient and ensure compliance are usually recommended when administering this intervention.

D. Sleep Restriction

Sleep restriction therapy (SRT) is a behavioral insomnia therapy wherein sleep improvements are achieved primarily by limiting or restricting the time allotted for sleep each night so that the time spent in bed closely matches the individual's actual sleep requirement. The treatment, first introduced by Arthur Spielman and colleagues in 1987, grew out of the observation that many insomnia sufferers spend excessive time in bed each night in efforts to obtain their elusive sleep. Indeed, many such patients may experience excessive time awake each night simply *because* they are allotting far too much time for sleep. Typically this treatment begins by having the insomnia sufferer maintain a sleep log on

which a record of each night's sleep is kept. After the insomnia sufferer has maintained a sleep record for 2 to 3 weeks, the average total sleep time (ATST) is calculated from the information recorded. Subsequently an initial time-in-bed (TIB) prescription may either be set at the ATST or at a value equal to the ATST plus an amount of time that is deemed to represent normal nocturnal wakefulness. However, unless there is persuasive evidence to suggest the individual has an unusually low sleep requirement, the initial TIB prescription is seldom set below 5 hours per night. Subsequently, the TIB prescription is increased by 15 to 20 minute increments following weeks the insomnia sufferer, on average, is sleeping greater than 85 or 90% of the TIB and continues to report daytime sleepiness. Conversely TIB is usually reduced by similar increments following weeks wherein the individual, on average, sleeps less than 80% of the time spent in bed. Since TIB adjustments are usually necessary, SRT typically entails an initial visit to introduce treatment instructions and follow-up visits to alter TIB prescriptions.

E. Cognitive Therapy

Underlying and supporting insomnia sufferers' performance anxiety and sleep-disruptive habits are a host of dysfunctional beliefs and attitudes about sleep. Beliefs that sleep is unpredictable and uncontrollable or that one must obtain 8 hours of sleep at night to function each day can add to anxiety about sleep and, in turn, interfere with the sleep process. Furthermore, insufficient knowledge about how one should respond to a night of poor sleep may lead to practices such as daytime napping or "sleeping in," which disrupt the ensuing night's sleep. Given increasing recognition of these types of sleep-related misconceptions, therapeutic strategies that specifically target these cognitions may be useful in insomnia treatment. Hence, cognitive therapy designed to correct these dysfunctional beliefs, either through formalized patient education modules or via the cognitive restructuring method similar to that commonly used in cognitive therapy with clinically depressed individuals, is often employed in the treatment of insomnia sufferers. Once again, usually multiple sessions of such treatments are provided in clinical applications of these cognitive therapies.

F. Cognitive-Behavioral Therapy

This treatment strategy might best be regarded as a second-generation behavioral insomnia treatment that

evolved from the above described strategies. Cognitive-behavioral insomnia therapy or CBT typically consists of one of the cognitive therapy strategies used in combination with both stimulus control and sleep restriction therapies. One presumed advantage of this treatment is that it includes treatment components that address the range of cognitive and behavioral mechanisms that perpetuate insomnia. As a result, this treatment should be more universally effective across insomnia sufferers regardless of their presenting complaint (i.e., sleep onset complaints vs. sleep maintenance difficulty). Admittedly, CBT is a multicomponent and seemingly more complex treatment than those previously described. Nonetheless, in practice, this intervention usually requires no more therapist or patient treatment time than do the less complex first-generation treatments reviewed above. Often CBT's cognitive therapy and behavioral instructions can be provided in no more than eight sessions, but some CBT models utilize as few as 2 to 4 sessions in their clinical applications. However, most current CBT proponents employ multiple treatment sessions to provide those they treat sufficient support and follow-up.

IV. EMPIRICAL STUDIES

Since their emergence, the behavioral insomnia therapies have been studied extensively. Indeed, well over 100 published studies have tested one or more of these treatments. A critical review of this voluminous literature is a daunting task and well beyond the scope of this chapter. Fortunately, in 1995 Douglas Murtagh and Kenneth Greenwood conducted a critical review of this literature in order to determine the general and relative effectiveness of the various behavioral insomnia therapies. In this review, they employed special statistical procedures to estimate treatment effects sizes for the behavioral insomnia therapies in general and for each treatment considered individually. As used in these analyses, the term treatment effect size reflected the average amount of difference (expressed as a fraction of the pooled standard deviation) observed between treated and untreated insomnia sufferers. Hence, a hypothetical effect size of 0.5, expressed in such terms, would indicate that treated individuals, on average, showed a half standard deviation improvement greater than those who were not treated. In clinical treatment studies, effect sizes in the 0.2 range are considered small, those in the 0.5 range are considered medium, and those 0.8 or greater are considered large.

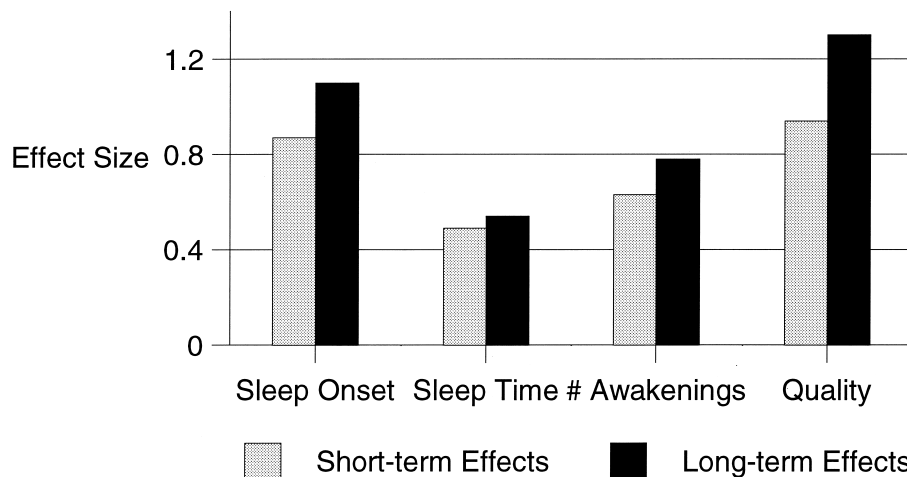

FIGURE 1 Short-term and long-term treatment effects for the behavioral insomnia therapies. [Adapted from Edinger, J., & Wohlgemuth, W. K. (1999). *Sleep Med. Rev.*, 3, 1–18, by permission of W. B. Saunders.]

Figure 1 shows the treatment effect sizes reported by Murtagh and Greenwood for the behavioral insomnia therapies in general. This figure shows both the short-term (i.e., at the conclusion of treatment) and long-term (i.e., at follow-up) effect sizes for the behavioral insomnia therapies, considered collectively, for a number of subjective (sleep log) measures including sleep onset latency, number of nocturnal awakenings, total sleep time, and subjective sleep quality. It should be noted that all of the treatment effect sizes shown are in the medium to high ranges. Furthermore, these data indicate that patients treated with the behavioral insomnia therapies tend to appreciate additional improvements through extended follow-up periods, which averaged 8 months in length for the studies Murtagh and Greenwood considered. Such findings are particularly encouraging inasmuch as the behavioral treatments are devoid of the previously mentioned side effects and lack of long-term effectiveness noted with many sleeping pills.

When comparing the behavioral insomnia therapies with each other, Murtagh and Greenwood noted that stimulus control therapy produced larger treatment effect sizes than did the other treatments particularly on measures reflecting difficulty falling asleep, the number of nocturnal awakenings noted, and overall perceived sleep quality. Relaxation therapies and treatment combinations that usually included stimulus control and relaxation techniques produced the largest improvements in nocturnal sleep time. It should be noted, however, that the studies considered in this critical review included highly screened and selected insomnia sufferers

who generally had no accompanying medical or psychiatric illnesses. As a result, the effectiveness of these treatments in applied clinical settings with more “real world” patients remains questionable. Furthermore, most of these studies focused on sleep onset problems and excluded individuals who solely or primarily complained of sleep maintenance difficulties. This is particularly unfortunate because insomnia sufferers with sleep maintenance complaints far outnumber those who solely complain of a difficulty falling asleep. Finally, the relatively newer CBT approaches were not considered in this review because only in the last few years have well-controlled studies of this approach been reported. Hence, the findings reported by Murtagh and Greenwood leave several important questions about the behavioral insomnia therapies unanswered.

Over the past 5 years an increasing number of studies conducted to test CBT approaches have been published. This growing literature has shown that CBT is a promising insomnia treatment for a various types of insomnia sufferers. Specifically, these studies have shown that CBT produces clinically significant sleep improvements among those who suffer from either sleep onset or sleep maintenance difficulties. Furthermore, studies have shown that this modality is effective among insomnia patients who additionally suffer from significant sleep-confounding medical (e.g., chronic pain syndromes) and significant psychiatric (e.g., depression) disorders. Moreover, some very recent research has shown that paraprofessionals can be trained to administer effectively these treatments in “real world”

primary care settings. Finally, results of these studies generally show moderate to high treatment effect sizes across a variety of outcome measures. Although far from conclusive, these findings suggest that CBT is a promising behavioral insomnia therapy that likely represents an advancement over the first-generation therapies from whence it evolved.

V. SUMMARY

Chronic insomnia is a fairly prevalent and significant health concern that often is perpetuated by dysfunctional beliefs about sleep, heightened anxiety, and a host of sleep-disruptive compensatory practices. Whereas sleeping pills are often prescribed for this condition, such treatment may be encumbered with side effects and usually fails to address the psychological and behavioral anomalies sustaining the sleep problems. In contrast, the behavioral insomnia therapies are each specifically designed to address one or more of these perpetuating mechanisms. Research has shown that first-generation behavioral insomnia therapies such as stimulus control and relaxation training are moderately to highly effective particularly for ameliorating sleep onset difficulties with highly screened and perhaps clinically skewed samples. However, recent studies suggest that a multifaceted cognitive-behavioral therapy, which targets both dysfunctional sleep-related beliefs and sleep-disruptive habits, appears effective for sleep onset and sleep-maintenance insomnia. Furthermore, very recent studies suggest that this treatment is effective in applied clinical settings. These results are encouraging and suggest that behav-

ioral insomnia therapy has a deserving and important niche in the management of those insomnia sufferers who seek treatment.

See Also the Following Articles

Applied Relaxation ■ Behavioral Weight Control Therapies ■ Cognitive Behavior Therapy ■ Paradoxical Intention ■ Progressive Relaxation ■ Relaxation Training ■ Self-Help Treatment for Insomnia

Further Reading

- Chesson, A., Jr., Anderson, W. M., Littner, M., Davila, D., Hartse, K., Johnson, S., Wise, M., & Refecas, J. (1999). Practice parameters for the nonpharmacologic treatment of chronic insomnia. *Sleep*, 22, 1128.
- Edinger, J. D., & Wohlgemuth, W. K. (1999). The significance and management of persistent primary insomnia: The past, present and future of behavioral insomnia therapies. *Sleep Medicine Reviews*, 3, 1.
- Morin, C. M., Colecchi, C., Stone, J., Sood, R., & Brink, D. (1999). Behavioral and pharmacological therapies for late-life insomnia: A randomized controlled trial. *Journal of the American Medical Association*, 281, 991.
- Morin, C. M., Hauri, P. J., Espie, C. A., Spielman, A. J., Buysse, D. J., & Bootzin, R. R. (1999). Nonpharmacologic treatment of chronic insomnia. *Sleep*, 22, 1134.
- Murtagh, D. R., & Greenwood, K. M. (1995). Identifying effective psychological treatments for insomnia: A meta-analysis. *Journal of Consulting Clinical Psychology*, 63, 79.
- Stepanski, E. J. (2000). Behavioral therapy for insomnia. In M. H. Kryger, T. Roth, & W. C. Dement (Eds.), *Principles and practice of sleep medicine (3rd ed.)*. Philadelphia: W. B. Saunders.

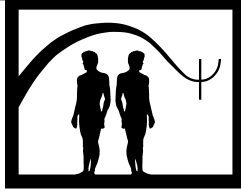

Behavioral Weight Control Therapies

Donald A. Williamson

Pennington Biomedical Research Center

Joy R. Kohlmaier and Marney A. White

Louisiana State University

- I. Description of Treatment
 - II. Theoretical Bases
 - III. Applications and Exclusions
 - IV. Empirical Studies
 - V. Case Illustration
 - VI. Summary
- Further Reading

GLOSSARY

classical conditioning Pavlovian or respondent conditioning that involves pairing a neutral stimulus with a stimulus that elicits an unconditioned response to yield a conditioned response to the neutral stimulus.

follow-up A specific point in time (e.g., 3 month follow-up), after which treatment has been terminated, when the researcher evaluates the stability of the results of the treatment intervention.

genotype genetic site for a particular characteristic.

kg of weight (1) = 2.2046 pounds.

meta-analysis A statistical technique in which the findings from a number of studies are combined to determine whether significant trends emerge.

reinforcement Contingent positive and negative events that follow a behavior and serve to increase the likelihood that a behavior will be repeated in the future.

resistance training Weight-lifting.

self-monitoring Keeping records of daily food intake and physical activity.

shaping The process of gradually learning a complex behavior by breaking the behavior into smaller parts and learning the components in succession.

stimulus control A technique used to limit or decrease the number of environmental cues that are associated with eating.

very low calorie diets (VLCDs) Dietary prescription in which daily caloric intake is limited to less than 800 kcal.

The behavioral treatment of obesity focuses on altering lifestyle by modifying one's eating habits and physical activity in order to achieve weight loss. The goal of this treatment is to achieve a negative energy balance, which is achieved via burning more energy than is consumed by eating. This article will present an overview of the behavioral treatment of obesity including a description of treatment, the theoretical bases underlying treatment, the applications and exclusions of treatment, the empirical studies investigating the efficacy of treatment, and a case illustration demonstrating the treatment approach.

I. DESCRIPTION OF TREATMENT

A. Basic Philosophy of Treatment

As described in the next section, lifestyle behavior modification for obesity is based on changing eating habits and physical activity to yield negative energy balance, that is, burning more energy than is consumed via eating. During the initial phase of treatment (approximately 26 weeks), weight loss occurs at a rate of approximately 1 to 2 lb. (.5 to 1 kg) per week and

gradually tapers to a weight plateau. After this first phase, the goal of treatment is weight maintenance, where the person learns to balance energy intake and energy expenditure. This section describes the primary components of lifestyle behavior modification during these two phases of treatment.

B. Components of Behavioral Weight Loss Interventions

1. Self-Monitoring

A central feature of behavioral weight loss interventions is self-monitoring of eating and exercise habits. Self-monitoring generally involves recording food intake and intentional efforts to increase physical activity. This monitoring should occur at the time of each behavioral event, that is, at each meal or snack or immediately after a bout of exercise. Self-monitoring also generally involves recording (1) environmental events associated with eating and exercise (e.g., place and time of day), (2) cognitive and emotional reactions (e.g., eating in response to stress), and (3) hunger ratings before and after eating. Self-monitoring serves several purposes: (1) enhanced awareness of habits, patterns of behavior, and amount of food eaten at meals and snacks, (2) record of behavior that can be used to evaluate progress and to set goals for reinforcement, and (3) dietary record that can be analyzed for the adequacy of the person's nutritional intake across time.

2. Stimulus Control

Stimulus control procedures are designed to alter the relationship between antecedent stimuli and eating and exercise habits. Commonly used stimulus control procedures are (1) eating at the same time and place at each meal, (2) slowing eating by putting utensils down between bites, (3) eating on small plates, (4) resisting the urge to have seconds, (5) eating while seated, (6) leaving a small amount of food on one's plate, (7) serving small portions of food, and (8) exercising at the same time each day. These procedures serve several functions: (1) extinction of the conditioned association between certain environmental events and unhealthy eating or exercise habits, (2) conditioning of a three meal/day eating pattern that is associated with specific environmental cues, (3) slowing the pace of eating, and (4) developing a consistent pattern of physical activity that becomes habitual.

3. Reinforcement/Shaping

As noted in the next section, the natural consequences of eating (e.g., the good taste of food and reduction of hunger) facilitate the development of overeating habits,

whereas the natural consequences of exercise (e.g., fatigue and muscle soreness) facilitate the development of a sedentary lifestyle. Furthermore, as a person gains weight, the natural consequences of exercise become even more aversive, resulting in less physical activity as obesity increases. Finally, the natural consequences of eating and exercise make conditioning of these habits highly probable. Unfortunately, alteration of the natural consequences of eating is essentially impossible without pharmacological or surgical intervention. On a more positive note, the development of healthy physical activity habits makes some of the natural consequences of exercise less aversive over time. Nevertheless, because these natural consequences are so difficult to modify, behavioral programs have typically tried to modify other reinforcers (e.g., social reinforcement or monetary rewards for behavior change).

The principle of shaping is generally employed when reinforcement contingencies are formulated. Shaping refers to setting small, but reasonable goals at first, and then gradually making them more challenging over the course of treatment.

4. Goal Setting

Behavioral weight control programs are generally very "goal oriented." Typically, the person will set a weight goal, a calorie goal, and an exercise goal. Also, individualized goals are usually established. These goals might include such things as cessation of eating certain types of foods (e.g., soft drinks), walking up stairs instead of using elevators, or modification of snacks (e.g., eating fruit instead of ice cream). As a general rule, the person is instructed to monitor success and failure in making these behavioral changes and this information is reviewed in each therapy session.

5. Behavioral Contracting

To enhance the person's motivation for achieving these goals, a procedure called behavioral contracting is often used. Behavioral contracting involves clearly specifying behavioral goals in terms of frequency, duration, or intensity (e.g., "I agree to walk at least 30 minutes per day for at least five days per week"). A behavioral contract generally includes some type of reinforcement contingency for successful attainment of the goal (e.g., "if I meet my exercise goal for this week, I will reward myself by purchasing a copy of my favorite magazine").

6. Meal Planning

Goals related to nutrient intake may take many forms (e.g., calories, fat grams, or dietary exchanges). In general, research has shown that explicit meal plans are

most effective for compliance. An explicit meal plan might include an actual menu to be followed each day. The use of portion-controlled foods that are prepackaged for use in diets can be quite useful for persons who have difficulty following a more general meal plan. Ideally, a dietitian should manage this aspect of the program.

7. Modification of Physical Activity

Programs to increase physical activity generally include increasing exercise and decreasing sedentary behavior. Research has found that aerobic exercise is the most effective form of exercise prescription and that compliance is best when the exercise program is incorporated into their normal lifestyle.

8. Problem-Solving

Formal training in problem-solving is a common component of most behavioral weight control programs. This type of training involves assisting the person to (1) identify problems that are obstacles to successful weight management; (2) define the problem in objective behavioral terms; (3) brainstorm about potential solutions to the problem; (4) conduct a cost/benefit analysis for each solution; (5) select a solution and develop a plan of action; and (6) evaluate the success or failure of the plan of action and revise it, based on this evaluation. This component of treatment is often useful in modifying obstacles that negatively impact compliance with the basic behavioral weight management program.

9. Social Support

Enhancement of social support for behavior change has been found to be a very important factor in successful weight management. Social support may be derived from a spouse, family member, or friends. In the treatment of childhood or adolescent obesity, involvement of the parents in the therapy program has been found to be very useful. Enhancement of social support is best accomplished by inviting family members and friends to attend some of the therapy sessions. In these sessions, support persons learn to reinforce healthy behavior change and are discouraged from engaging in actions that sabotage progress toward behavior change.

C. Components of Behavioral Weight Maintenance Programs

1. Relapse Prevention

Returning to old, unhealthy habits is a primary cause of relapse and regain of weight that has been lost. Relapse prevention programs generally assist in the identification of situations that place the person at risk for

returning to old, unhealthy habits and to develop specific plans to manage these high-risk situations. For example, parties might be a high-risk situation for overeating. The person might develop a plan of action that involves healthy eating before going to the party to reduce hunger and standing or sitting in areas that are away from tempting foods. Relapse prevention programs also often include a discussion of the distinction between lapses and relapse. People often engage in “all-or-nothing” thinking so that when they deviate from the behavioral prescriptions of the program, they feel as though they have failed, resulting in loss of motivation and returning to old habits.

2. Booster Treatment

Booster treatment generally involves periodic therapeutic contact during the period of weight maintenance. This therapeutic contact may take many forms, including face-to-face sessions, scheduled telephone calls, or asynchronous internet exchanges. Because obesity is now viewed as a chronic illness, most experts believe that some type of booster treatment may be needed over the course of an entire lifetime, if weight loss is to be successfully maintained.

3. Tool-Box Approach

In recent years, there has been a growing trend toward individually tailoring treatment. To accomplish individualized treatment plans, the weight management therapist needs a “tool box” with many therapeutic “tools.” For example, during the weight maintenance phase, the tools might include special programs to manage the holiday season or periodic portion-controlled diets to lose 5 to 10 pounds that have been regained.

II. THEORETICAL BASES

There is a significant genetic component to the development of obesity, and it is generally believed that some interaction of genetics and environment may predispose selected persons to gain weight. For example, one genotype may predispose someone who consumes a diet high in fat to become obese. Another genotype may predispose someone who consumes a high carbohydrate diet to become obese. The focus of a behavioral intervention incorporates modification of eating behaviors and physical activity to yield energy imbalance. Figure 1 illustrates the relationship between body weight and changes in energy intake and energy expenditure.

When the energy consumed exceeds the amount of energy burned, the long-term result is excess body

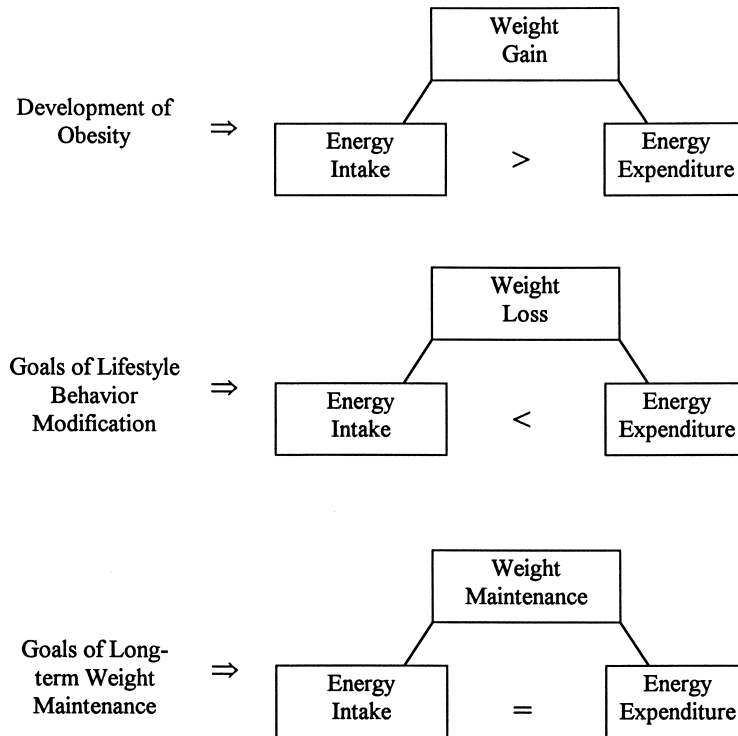

FIGURE 1 Body weight as a function of energy intake and energy expenditure.

weight caused by storage of “extra” energy in body fat stores. The primary source of energy consumption is the food (and beverages) that individuals consume. Energy expenditure, or the energy that individuals “burn” is derived from several sources: (1) physical activity (about 25%), (2) basal metabolic rate (about 70%), and (3) the thermic effect of food (about 5%). Metabolic rate and thermic properties of food are not easily altered by behavior. However, certain drugs can increase (or decrease) these metabolic responses. Therefore, behavioral weight loss programs generally focus on the modification of eating behavior and energy expenditure that results from increased physical activity.

The term positive reinforcement refers to environmental events that increase the likelihood that a behavior will be repeated. The reinforcing properties of eating may include the taste and pleasurable sensations associated with eating food, a feeling of wellness associated with eating or with physiological sensations of satiety. In general, individuals are likely to engage in a behaviors in order to achieve short-term, immediate reinforcement. As such, individuals who are highly motivated by the immediate consequences of eating may be prone to overeat. Conversely, the short-term consequences of physical ac-

tivity may be somewhat unpleasant for some individuals; physical exercise may be associated with fatigue, muscle soreness, and boredom. When trying to motivate change of these habits, it is important to emphasize the long-term consequences of healthy eating and physical activity. The long-term consequences of healthy eating are weight loss and improved health; the long-term consequences of physical activity include increased energy, weight loss, and general health improvements. Indeed, once individuals engage in a regular physical activity regimen, it is likely that the short-term consequences of exercise will become rewarding (i.e., muscle soreness diminishes, and individuals may experience improved mood following exercise).

Classical conditioning refers to the set of circumstances by which cues in an individual's environment become associated with a particular behavior. When an environmental stimulus is repeatedly paired with a behavior, the stimulus itself becomes a “trigger” to elicit a behavioral reaction. In the case of eating behavior, many aspects of the environment may become associated with hunger sensations and with eating. The smell or sight of food may become conditioned stimuli to eating and therefore trigger hunger sensations. This association is

conditioned because the smell and sight of food are repeatedly paired with eating behavior. However, additional stimuli, when paired with eating, may become associated with feelings of hunger. For example, if an individual habitually eats while watching television, then hunger sensations can be elicited by watching TV (independently of physiological hunger). It is important to distinguish between physiological and psychological hunger. Physiological hunger refers to the physical process by which the body signals a need to eat. Psychological hunger refers to the perception of hunger, which may be independent of energy depletion. Psychological hunger is often the result of classical conditioning. For example, after repeatedly eating while watching TV, the television may become a conditioned stimulus for "hunger." In essence, television watching will elicit hunger sensations. In response to this type of conditioning, stimulus control procedures are implemented to limit the cues or stimuli in an individual's environment that are associated with eating.

Obesity is not a psychiatric disorder. However, it has been estimated that as many as 10 to 25% of individuals seeking obesity treatment engage in binge eating behavior. It is important to note, however, that not all obese individuals binge eat. As defined by the *American Psychiatric Association Diagnostic and Statistical Manual for Mental Disorders, 4th Edition*, binge eating occurs when one consumes an amount of food that is significantly larger than normal in a discrete period of time. During binge episodes, individuals report feelings of loss of control over their eating. Research indicates that binge eating frequently arises in response to dietary restraint; as individuals engage in strict dietary restriction, they experience strong physiological hunger, which then leads them to binge eat. Further, individuals with rigid rules about the kinds of foods they will allow themselves to eat may engage in binge eating once they have broken a rule about eating. Binge eating may also arise in response to negative emotions; because eating is a pleasurable activity for most people, the binge episode may serve to ease the negative mood. However, binge eating is frequently followed by feelings of extreme guilt and other negative emotions, which may therefore perpetuate the cycle of binge eating.

III. APPLICATIONS AND EXCLUSIONS

In general, behavioral weight control therapies should be matched to the individual. Because of the lifestyle be-

havior change required by the program, an individual's motivation for treatment and willingness to implement the behavioral changes required must be assessed. For example, certain individuals may not be willing to take medication or may be resistant to particular aspects of a behavioral program. Treatment effectiveness will be contingent upon the client's willingness and ability to engage in all aspects of the weight loss regimen.

Cultural issues may also influence a client's willingness and motivation to lose weight. For example, the stigma of obesity varies across cultures. Women, more than men, are likely to attempt weight loss for appearance reasons. Men are more likely to enter into obesity treatment programs when they believe that their overweight status has deleterious health effects. African Americans are less likely to experience social pressures to lose weight and may therefore be less motivated to seek treatment. For some people, it may be beneficial, therefore, to emphasize the health-related benefits of weight loss rather than the appearance-based reasons for weight loss.

In addition, an individual's physical health must be considered when prescribing caloric restriction and a physical activity regimen. A physician should be consulted to assess the safety of caloric restriction. Likewise, a dietitian or nutritionist should be consulted in formulating dietary recommendations. Individuals with Type II diabetes or cardiovascular disease may require special diets and medical monitoring throughout the course of any weight loss program. Further, overweight individuals may experience knee or other joint problems; in such cases physical activity may be limited. Consultation with a medical doctor, physical therapist, and/or exercise physiologist is indicated in such cases.

It is also important to consider the psychological sequelae of obesity. In American culture, there is a stigma associated with obesity. The "obesity stereotype" is that people who are overweight tend to be less socially competent, lazier, and less intelligent than normal weight individuals. In addition, most obese people have experienced various forms of discrimination and teasing about their weight. As a result, obese people often suffer from low self-esteem and may be very concerned about their body shape. In addition, many individuals may have attempted unsuccessfully to lose weight in the past, or they may have lost weight only to regain it later. A pattern of unsuccessful weight loss attempts frequently leads to frustration and lowered self-esteem. It is important that clinicians remain sensitive to these issues when treating obesity.

Finally, it is important to identify individuals with eating disorders. The most common type of eating disorder

associated with obesity is binge eating disorder. Binge eating disorder is characterized by recurrent episodes of binge eating in which the individual consumes large amounts of food and perceives a loss of control over eating. Unlike the pattern of behavior observed in bulimia nervosa, binge eating episodes in binge eating disorder do not occur with compensatory behaviors to prevent weight gain (e.g., fasting, purging, exercise). Binge eating disorder occurs in less than 2% of obese people, although binge eating as a behavioral symptom is much more common (10% to 25%). Other problems that are often observed include bulimia nervosa, nonpurging type and preoccupation with body size and shape, as the source of all of the person's problems. When such problems are identified, the treatment strategy should incorporate a component to reduce the frequency of binge episodes and overconcern with body size and shape. In addition, clinicians should carefully monitor the emergence of other eating disorder symptoms that may emerge over the course of treatment.

IV. EMPIRICAL STUDIES

A. Early Studies (1967–1990)

Behavioral methods for the treatment of obesity were first applied over 30 years ago. In 1967, Richard B. Stuart was among the first to describe the application of learning principles to the treatment of obesity. His first behavioral program successfully treated eight overweight women, who attained an average weight loss of 17 kg over a 12-month period. It was Stuart's early success story that sparked researchers' interest in this approach to the treatment of obesity.

The research studies that followed in the 1970s were modeled on Stuart's behavioral weight control program; however, there were some notable differences in the application of the treatment protocol. In Stuart's program, he used an individualized approach, tailoring the program to fit the needs of the individual patient. Treatment sessions took place three times per week for the first 4 to 5 weeks, then less frequently as treatment progressed. The studies of the 1970s that followed Stuart's early studies moved in a different direction. These studies delivered treatment to small groups of 6 to 10 persons and usually met once per week for 12 to 16 weeks. As noted by Don A. Williamson and Lori A. Perri, in 1996, this approach to behavioral weight loss treatment resulted in less impressive results (average weight loss of about 4 to 5 kg).

Since the 1970s behavioral treatment programs for obesity have been intensified in terms of length and aggressiveness, yielding average weight losses of about 8.5 kg. However these weight losses usually occur in the short term and are not maintained in the long term, after treatment ends. Most persons who receive behavioral weight control regain much of the weight that was lost, although the regain of weight usually takes about 5 years. On average, most people reach their maximum point of weight loss about 6 months after the initiation of treatment. After treatment ends, weight regain ensues, and over a period of time, persons gradually regain the weight that was lost over the 6 months of treatment.

B. Intensive Lifestyle Behavior Modification (1990–2000)

1. Increased Duration of Treatment

After the trend of regaining weight was noted, behavioral researchers in the 1990s tried to identify more effective long-term strategies. One strategy was to increase the length of treatment. Treatment length increased from an average of 8 weeks in 1974 to an average of 21 weeks by the 1990s. Comparable increases in weight loss have occurred with increases in treatment duration. In 1974 the average weight loss associated with the 8-week treatment protocol was 3.8 kg, and in 1990, the average weight loss associated with a 21-week treatment protocol was 8.5 kg. In 2000, Robert W. Jeffery and colleagues estimated that average weight losses in behavioral treatment studies have increased by approximately 75% between 1974 and 1994, and that this approximate doubling of average weight loss has occurred in conjunction with the approximate doubling of treatment duration in the last 20 years. In 1989, M. Perri, A. Nezu, E. Patti, and K. McCann reported that treating participants for 40 weeks as opposed to 20 weeks was associated with more weight loss. In a review of this research in 1998, Perri concluded that extended contact with participants yielded better weight loss. Therefore, longer duration of treatment has been consistently associated with greater weight loss.

2. Very Low Calorie Diets and Meal Planning

One way of improving weight loss is to incorporate a very low calorie diet (VLCD), defined as less than 800 kcal/day, into the treatment protocol. Most behavioral

weight control programs have used low calorie diets (LCD), which usually consist of approximately 1200 to 1500 kcal/day. Thomas A. Wadden and Albert J. Stunkard's initial study, which was conducted in 1986, and studies that followed, consistently found that a VLCD combined with behavior therapy was more successful than a LCD combined with behavior therapy, in producing more initial weight loss (in the short term); however, this initial weight loss did not improve long-term outcome. Williamson and Perrin reported on the results of several studies, which used VLCDs in addition to behavior therapy. They noted that the addition of behavior therapy to a VLCD, in the active treatment phase, did not yield weight loss above that usually associated with VLCDs alone; however, the addition of behavior therapy did seem to slow the rate of weight regain.

In addition to VLCDs, diets that are more structured have also been emphasized. According to Rena Wing, food provision (actually providing the persons with the appropriate food) was effective in improving the amount of initial weight loss in one study, but was no more effective in the long term than was a condition that had a standard calorie goal of 1000 to 1500 kcal/day. Subsequent studies have found that the most important component of food provision is the provision of structured meal plans and grocery lists (not the provision of food, *per se*), which appear to exert their effects by assisting people in selecting healthy foods, and by creating a regular meal pattern (i.e., breakfast, lunch, dinner).

3. Exercise

Unlike the dietary approaches mentioned above, increased attention to exercise has been related not only to enhanced short-term weight loss, but also long-term weight loss. In fact, the benefit of exercise has been particularly effective in the long term. Recent research has focused on type of exercise that may produce the best weight losses. In 1995, R.E. Anderson and colleagues found no differences in treatment programs using aerobic exercise, resistance training (weight lifting), or the combination of aerobic exercise and resistance training (although all yielded significant weight losses). In 1985, Leonard Epstein and colleagues reported that lifestyle exercise (e.g., using stairs instead of an elevator), produced somewhat more weight loss in children than did aerobic exercise, although both of these types of exercise promoted far better weight maintenance than did calisthenics. Similarly, in 1995, these researchers found that children who were taught to decrease sedentary activities had greater decreases in percent

overweight than the group that was taught to increase aerobic exercise. Kelly D. Brownell and Thomas A. Wadden, in 1992, speculated that exercise may be beneficial in the long term for physiological or psychological reasons. It is possible that exercise is effective in the long term because it increases lean body mass, elevates metabolic rates, or decreases appetite. With regard to the psychological effects of activity, the authors noted that even the smallest amounts of exercise (e.g., parking further away from a store) can have positive effects on mood and self-efficacy.

4. Social Support

Enhancement of social support has been tested as a means of improving long-term weight loss. The most common way to enhance social support has been to include spouses or significant others in the treatment process. A 1990 meta-analysis revealed that there are both short-term and long-term benefits to including spouses in obesity treatment. In 1999, Wing and Jeffery found similar results with the inclusion of friends in the treatment process, revealing that persons who entered treatment with friends had better success at maintaining weight losses 6 months after a 4-month behavioral treatment program.

5. Increased Therapist Contact During the Maintenance Phase

Obesity researchers have tested the impact of increasing therapist contact during the weight maintenance phase, as a means of facilitating long-term success. In 1984, Perri and colleagues found that the addition of posttreatment therapist contact via the telephone and mail significantly enhanced maintenance of weight loss for a group that received behavior therapy plus relapse prevention training. In the same year, Perri reported similar results with the use of booster sessions to enhance maintenance of weight loss. In 1989, Perri and colleagues reported that women in a behavioral weight control program that received 1 year of additional contact (biweekly treatment contacts of various sorts), maintained their weight losses better than the group of women who received no contact during the maintenance phase. In recent years the internet has been employed as a means of increasing therapist contact to improve long-term weight maintenance, and preliminary results of this approach are encouraging.

6. Relapse Prevention

Relapse prevention components have been tested as one means of achieving better long-term weight

maintenance. In 1996, Williamson and Perrin concluded that development of the skills to respond immediately to overeating or to a small weight gain is useful to prevent relapse. In 1995, Rita G. Drapkin, Rena R. Wing, and Shaul Shiffman reported that those subjects who were able to generate more coping responses to hypothetical high-risk situations were most successful in weight management.

7. Secondary Prevention

Secondary prevention of obesity, aimed at children, appears to be a promising approach for the treatment of obesity. In 1990, Leonard H. Epstein and colleagues found that when comparing a therapy program attended by both child and parent (in which both were reinforced for weight loss and behavior change), the children lost more weight than those children who attended a child only program, without a parent (in which only the child was reinforced for behavior change), or a nonspecific control treatment (which reinforced families for their attendance). At 5- and 10-year follow-ups, the children in the child and parent treatment program had significant decreases in overweight when compared to the nonspecific control group, and the children in the child only group were midway between these two groups. These findings suggest that early interventions with overweight children may be a useful method of preventing chronic obesity in adulthood. Because obese children are 6.3 times more likely to be overweight adults than are nonobese children, Wing has advocated secondary prevention targeting obese children as an important public health initiative.

8. Pharmacotherapy

Drug therapy has been used in conjunction with behavior therapy to improve weight loss and maintenance. Currently, there are three medications that can be used for short-term weight loss. These are (1) phentermine, (2) the combination of caffeine and ephedrine, and (3) phenylpropanolamine. In terms of long-term weight loss, Michael Weintraub, in 1992, conducted a 3-year trial of fenfluramine and phentermine ("fen-phen"). Although this drug combination appeared to be very promising and attracted widespread attention, "fen-phen" was found to be associated with heart valve damage in a substantial number of its users, and was abruptly taken off of the market in 1997. Despite this health scare, the enthusiasm for the possibility of new long-term drugs to aid in weight loss has not been lost. The Food and Drug Administration has now approved two weight loss medications for long-term use. In 1996,

sibutramine (Meridia), a serotonin reuptake inhibitor, was approved and in 1999, orlistat (Xenical), a medication that inhibits digestion of dietary fat, was approved. Jeffery and colleagues assert that most weight control medications to date have shown maximum efficacy when combined with behavior modification programs. However, in general, the addition of behavior therapy does not seem to prevent the regaining of weight after medication is withdrawn. Thus, current research evidence indicates that neither medication, behavior therapy, nor the combination of the two "cures" obesity. Instead, this research suggests that obesity is best conceptualized as a chronic medical condition that requires continuous management.

9. Chronic Disease Concept

In 1998, the Obesity Education Initiative Expert Panel (of the National Institutes of Health) reported that obesity is now recognized as a chronic disorder that requires continuous care. Today, behavioral weight control therapies conceptualize the treatment of obesity in terms of a chronic disease. Behavioral weight control therapies for obesity are clearly effective treatments for weight loss, but like all other treatments for obesity (with the possible exception of surgery), behavior therapy does not lead to long-term maintenance of weight loss, after weight loss treatment is terminated, but behavior therapy plays many important roles in the management of obesity: (1) behavior therapy may be useful when used in a stepped care approach for the moderately obese, who have not been successful at losing weight without the help of a professional, (2) behavior therapy could be used with persons who are withdrawing from pharmacotherapy and who may benefit from behavior therapy in an effort to maintain weight loss, and (3) behavior therapy may be useful for persons who are able to maintain weight loss, by establishing behavior therapy support groups to provide social and therapeutic support for the long term. In order for such an approach to be effective, major centers would need to establish long-term counseling programs and make them available at little or no cost to obese patients. By using this public health approach, obesity could be addressed in an ongoing manner as a chronic illness, as opposed to an acute disease.

V. CASE ILLUSTRATION

Brian was a 20-year-old Caucasian male who weighed 323 lb. with a height of 6 ft 2 in. Brian had

been overweight since childhood. His identity was highly connected to being obese. For example, he delivered pizzas and took great pride in consuming multiple pizzas if they could not be delivered. His friends were amazed at his appetite and ability to consume very large quantities of food. He was enrolled in college, but was on the verge of flunking out of school at the time of the referral. He reported eating binges, but they were atypical in that they were not secretive and he did not experience guilt or negative feelings following the binges. He had never seriously attempted dieting to lose weight and he was very sedentary, but in generally good health other than his rather significant obesity. His family was intact, with a mother, father, and older brother, who had experienced problems related to substance abuse.

Brian was seen in individual therapy for over 2 years. Family therapy was also incorporated into the treatment plan. Treatment followed the protocol described by Williamson and colleagues in 1996. Initially Brian was seen once per week in individual therapy and the frequency of therapy sessions was gradually faded to bi-weekly and then once per month over the course of the first year. He was seen about once per month during the second year of therapy. All components of the behavioral management program (described earlier) were used in Brian's therapy program, including self-monitoring, stimulus control procedures, reinforcement/shaping, goal setting, behavioral contracting, problem-solving, meal planning, modification of physical activity, relapse prevention, and enhancement of social support. Toolbox approaches were used to individualize treatment. Behavioral therapy for binge eating was used to modify skipping meals and cognitive approaches were used to modify beliefs about the "benefits" of binge eating. Also, family therapy was used to alter the communication patterns of the family. Brian's parents and brother talked about Brian in terms of being the obese son with the big appetite. They gave him considerable attention for his "huge appetite" and mildly scolded him for engaging in dietary restraint. Family therapy was devoted to reverse the behaviors to which the family members attended so that they reinforced efforts to control eating. They learned to help Brian eat three healthy meals per day and did not attend to eating binges.

At first, Brian struggled with the behavioral weight management program. Over the course of the first 3 months, he lost only 4 pounds, primarily because he continued to engage in binge eating. However, from months 3 through 6, he was more successful and lost an additional 36 pounds. During the next 6 months, he

began to substantially increase physical activity. He began running and lifting weights. During this 6-month period, he lost 40 more pounds. Over the second year, Brian consolidated most of the behavioral changes that he had made and continued to increase his physical activity. He eventually lost 100 pounds and weighed between 220 and 225 pounds. He graduated with a bachelor's degree in finance and eventually enlisted in the military. He is now a career officer in the military and has successfully maintained his weight loss for the past 10 years. He is married and has two children. He reports that he occasionally has urges to binge, but can control the urges with effort to direct his attention away from eating and by focusing upon engaging in exercise. He never developed symptoms indicative of an eating disorder although he clearly emphasizes the importance of exercise as a means of managing his body weight.

VI. SUMMARY

Behavioral weight control therapies involve two primary phases: (1) weight loss, and (2) weight maintenance. During the period of weight loss, energy intake via eating is reduced and energy expenditure due to physical activity is increased. A variety of therapeutic techniques are used to modify these habits. During the period of weight maintenance therapy, the person learns to match energy intake (eating habits) with energy expenditure (exercise). Research has found that long-term therapeutic support is often required for long-term weight maintenance.

See Also the Following Articles

Behavioral Contracting ■ Classical Conditioning ■
Controlled Drinking ■ Eating Disorders: Psychotherapy ■
Positive Reinforcement ■ Self-Control Therapy

Further Reading

- Bray, G., Bouchard, C., & James, P. (Eds.). (1999). *Handbook of obesity*. New York: Marcel Dekker.
- Jeffery, R. W., Epstein, L. H., Wilson, G. T., Drewnowski, A., Stunkard, A. J., & Wing, R. R. (2000). Long-term maintenance of weight loss: Current status. *Health Psychology, 19*, 5.
- Perri, M. G. (1998). The maintenance of treatment effects in the long-term management of obesity. *Clinical Psychology Science and Practice, 5*, 526.
- Williamson, D. A., & Perrin, L. A. (1996). Behavior therapy for obesity. *Endocrinology and Metabolism Clinics of North America, 25*, 943.

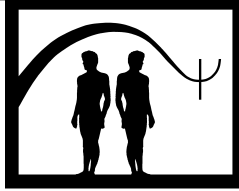

Behavior Rehearsal

Arnold A. Lazarus

Rutgers University and Center for Multimodal Psychological Services

- I. Description of Treatment
 - II. Theoretical Bases
 - III. Empirical Studies
 - IV. Summary
- Further Readings

GLOSSARY

cognitive-behavior therapy This therapy involves a set of principles and techniques that stress the reciprocal relationship between thoughts and feelings. Its underpinnings rest on experimental psychology, particularly social learning theory. Most normal and abnormal behaviors are considered to be maintained and modified by environmental events. In treatment, the emphasis is primarily on current determinants of behavior. Direct problem solving is an integral part of this form of therapy.

modeling Basically, modeling consists of learning by observation. For example, a client may accompany the therapist to a store to observe the assertive return of faulty merchandise. Therapists may perform several target behaviors, which the client imitates and then adopts into his or her own repertoire.

role-playing There are many settings in which acting the part of another person for educational or therapeutic purposes proves helpful. For example, employees may be trained, via role-playing, to handle problems with customers, to present an impressive sales pitch, to learn how best to interact with their superiors or subordinates, and so forth. In therapy, clients may rehearse ways to cope with stress and family conflicts.

self-efficacy People estimate and judge their own capabilities of organizing and executing various courses of action. Their behaviors will be heavily influenced by whether or not they perceive themselves as capable of attaining specific goals. In many situations, to successfully accomplish a desired outcome, a person needs to be convinced of his or her effectiveness, strength, or power to do so.

social learning theory A point of view that explains simple and complex behaviors by combining data derived from conditioning with known facts of cognitive mediation. Thus, there is emphasis on overt learning (e.g., habits), vicarious learning, and symbolic activity (e.g., language) to account for the development, maintenance, and modification of behavior.

social skills training Social skill is a construct that includes a broad array of interpersonal competencies including assertiveness, warmth, empathy, conversational facility, perceptiveness, good listening skills, and clarity of verbal expression. In therapy, where a deficit in any of the aforementioned factors is behind a client's distress, he or she will be trained (via role-playing, modeling, and didactic instruction) to try to remedy the situation.

I. DESCRIPTION OF TREATMENT

A. Definition

The term behavior rehearsal is used to describe a specific procedure that aims to replace deficient or inadequate social or interpersonal responses by efficient and effective behavior patterns. The patient or client

achieves this by practicing the desired forms of behavior under the direction of a therapist. Thus, before asking for a raise, an employee might be advised to rehearse exactly what to say and how to say it.

Cognitive-behavior therapy emphasizes that psychological problems may stem from misinformation (faulty reasoning, dysfunctional beliefs, erroneous ideas) and missing information (skill deficits, gaps in knowledge). Clients who do not know how to behave appropriately and effectively in specific situations must be taught the necessary skills. The therapist responds much like the director in a movie who coaches a character actor to master a role. Thus, take for example a man who is at a loss for words when receiving unfair criticism from his employer. Typically, the therapist will commence by playing the part of the employer, while the client endeavors to respond appropriately. The enactment is usually audiotaped or videotaped so that the client may analyze the playback. The client then assumes the role of his employer, while the therapist models an appropriate response to the criticism. Again, recorded playbacks may be reviewed. Special attention is paid to expressive elements (speech content, as well as paralinguistic factors such as voice, pace, pitch, and tone). In addition, nonverbal behavior is scrutinized, especially eye contact and facial expression. The client enacts the role again and again until he and the therapist are satisfied with his performance. At this stage, the client is encouraged to test his skills in the actual situation.

A brief account of an actual case history may clarify the foregoing:

A 32-year-old architect had consulted several therapists for help with his feelings of depression and anxiety. They discussed his childhood, interpreted his dreams, and one of his doctors prescribed antidepressant medication—all to no avail. The client had become aware of cognitive-behavior therapy and decided to consult a psychologist who was well versed in this approach.

During the first session, it became clear that his problems had developed soon after he became a fully fledged architect and started looking for a job. Although his grades in school had been excellent, he never obtained employment that matched or utilized his abilities. He was usually hired by small firms on a temporary basis and was given work to do that was beneath him. He had applied to many distinguished organizations, went on interviews, but was never hired.

What methods should be used to help this frustrated and unhappy man? Is there any evidence that his problems could best be resolved by delving into his past, in-

terpreting his dreams, or simply encouraging him to ventilate his dissatisfactions? The answer is "No." Regrettably, many therapists still believe in and adhere to these old-fashioned methods. Yet modern psychotherapy has come to regard the best treatment process as a form of education, where clients are trained to remedy gaps in their repertoires.

Therefore, after giving the architect some psychological tests and studying a detailed life history inventory that he had filled out—thereby obtaining an overview of his past and present functioning—the therapist was able to select a treatment strategy that made the most sense. One factor stood out. The client's communication style was extremely unimpressive. He mumbled, swallowed his words, spoke too softly, and made little eye contact—none of which inspired much confidence or respect. Given his unfortunate style and demeanor, it seemed likely that prospective employers would not be impressed. Thus, "behavior rehearsal" was administered.

Therapist and client role-played job interviews. The therapist pretended that he was a potential employer, and the client discussed his credentials and answered questions. A tape recorder was switched on. In listening to some five minutes of the simulated interview, it was evident that the client had undersold himself and had come across poorly. The therapist then switched roles—he was now the architect, and he demonstrated how the client could emphasize his excellent training and occupational strengths, make eye contact, project his voice, and speak clearly. Over four hour-long sessions that took place over two weeks, the therapist and client rehearsed different interviews, stressing nonverbal aspects such as eye contact, firm handshakes, and good posture, and they practiced exactly what the architect would say and how he would sound. Not surprisingly, the client then went on a real job interview and gained employment with a highly prestigious company at a salary that was indeed commensurate with his abilities. He no longer complained of depression or anxiety. At a followup interview a year later he described himself as "generally more confident" and said he was "doing extremely well."

II. THEORETICAL BASES

We have already alluded to the social learning theory paradigm as the base on which behavior rehearsal rests. In 1958, Joseph Wolpe, one of the pioneers of behavior therapy, borrowed the term psychodrama to describe role-playing scenarios that were used to encourage

unassertive clients to stand up for their rights. He emphasized that unlike Moreno's original psychodrama, it did not consist of encouraging clients to act out their underlying attitudes in relationships. Instead, with the therapist playing the role of someone to whom the client ordinarily reacted with excessive anxiety, he or she was directed to behave in a new, usually assertive manner. Wolpe's assumption was that this outward display of new (assertive) behavior would reciprocally inhibit the anxiety. He stressed that when the client is able to deal successfully with the "play" situations in the office, it is a steppingstone toward dealing with the real-life situation. Instead of calling this process "psychodrama," I pointed out that the play-acting of prescribed behavior might better be called behavior rehearsal, and this became the accepted term.

In a book that Wolpe and I co-authored in 1966, the following statement appears:

Where the patient's reaction pattern is considered deficient or inappropriate, he is required to re-enact the incident while the therapist plays the role of the other person(s). The therapist may then switch roles and act the part of the patient, sometimes presenting a deliberately over-dramatized picture of assertion, thus affording the patient an opportunity for learning adaptive responses by imitation.

This perspective opened the door for behavior rehearsal to be construed as a process of social influence that transcended the reciprocal inhibition explanation that new behaviors control the underlying anxiety. It tied behavior rehearsal to the vast literature on role-playing, and it went beyond a focus on assertive training to the much broader realm of social skills training.

Today, self-efficacy as propounded by Albert Bandura may be the theoretical base that most aptly accounts for the value of behavior rehearsal. Before venturing into any course of action, a person first needs to feel capable of achieving success. Entering a situation unprepared, unrehearsed, and feeling unskilled is unlikely to yield a successful outcome. Individuals' beliefs about their own degree of efficacy will determine whether they feel optimistic or pessimistic, what courses of action to pursue, how much effort to expend in trying to achieve specific goals, and the degree of perseverance likely to be displayed in the face of impediments. Many studies have confirmed the significant role of perceived self-efficacy in human adaptation, coping, and change. These findings extend far beyond the consulting room or the clinic and include educational systems, business organizations, athletic teams, and even the power plays in

urban neighborhoods with violent crime. In the clinical arena, it is not surprising that when clients are trained, rehearsed, coached, instructed, and guided towards a desired achievement or end, their sense of self-efficacy increases dramatically.

III. EMPIRICAL STUDIES

Behavior rehearsal is part of the general field of social skills training and a variety of role-playing techniques that have been developed. As already mentioned, the method has been widely used and includes areas that fall outside the clinical or psychotherapeutic arena. Thus, reports abound in which it has been applied to employees in business and industry (e.g., for handling problems with customers). Behavior rehearsal has been used extensively in helping people deal with stress in family conflicts. For example, it has been applied to marital situations where the partners' distress is a function of poor communication styles. The case has even been made for regarding the entire enterprise of psychotherapy in terms of skills training.

Many years ago (1966) I conducted a study in which behavior rehearsal was compared to nondirective therapy and advice in effecting behavior change. Clients with response deficits in assertiveness and other interpersonal transactions were randomly assigned to receive specific role-playing and behavior rehearsal procedures, they were treated via nondirective person-centered (Rogerian) reflection, or they were given advice on how to deal with their difficult situations.

If, for instance, a client complained that he felt resentful of his older brother's plans to admit their aged father to a nursing home without first discussing the matter with him, the person-centered therapy might have proceeded as follows:

Therapist: So you are angry and perhaps hurt that you were not consulted in the matter.

Client: Right. Frankly, I know of a far better facility, and I wish he had shown me the courtesy and respect of discussing it with me.

Therapist: You feel disrespected.

Client: Yes I do. It's as if my opinions do not count. I'm informed about it when the matter is fait accompli.

Therapist: So it was too late for you to provide potentially helpful information.

Client: Correct. I think I should share my feelings about this with my brother. But I'm not sure how to go about it.

Therapist: You don't quite know what to say to him.

Client: I want to get my point across without making unnecessary waves.

Therapist: You're not quite sure how to go about it.

A client in the advice-receiving mode would be managed more or less as follows:

Therapist: I think it would be good for you to get it off your chest and tell him how you feel about it.

Client: I agree, but I wonder how I can do it without causing needless resentment:

Therapist: Well, when you bring up the topic, don't put him down, don't chastise him. Discuss your own feelings. Use "I feel" messages and not "You are" messages. Do you know what I mean by this?

Client: I think so.

Therapist: Well, in essence, do not say to him "You are wrong for not having discussed it with me." Rather say, "I feel hurt that I was left out of it."

Client: But how should I bring up the subject?

Therapist: You can always say something like, "I want to chat with you about the way I feel about the nursing home dad is in."

Client: Okay. I guess I could then say that Greenacres is a much better place for the elderly.

Therapist: Right. And then you could say that you wish he had discussed the matter with you before making a final decision.

Client: Sounds good to me.

Therapist: So when will you talk to him about it?

Client: Probably this week.

Therapist: Good. The sooner the better because it is playing on your mind.

The behavior rehearsal procedure would have been conducted along the following lines:

Therapist: Let's pretend that I'm your brother. I'll switch on the tape recorder, and we can have a little dialogue and then listen to it.

Client: Fine.

Therapist: Okay. Why don't you start?

Client: Actually, I'm not quite sure how to start the conversation.

Therapist: How about saying, "I want to discuss the nursing home dad is in?"

Client: (role-playing) There's something I need to talk to you about. I've been treated as if I'm chicken liver. You didn't even ask me for my opinion about which nursing home would be best for dad.

Therapist: Let's stop a moment. You have launched an attack. Let's just listen to that brief playback on the recorder. Don't you agree that it will put your brother on the defensive?

(Client and therapist review the brief opening salvo.)

Client: I see what you mean.

Therapist: Let me be you now, and let's put on the recorder again. (role-playing) I feel hurt and put down that I was never asked for any input re dad's future.

Client: I didn't think of asking you because you have never shown much interest in the matter. All I knew was that you'd prefer dad to be within commuting distance from us.

Therapist: (no longer role-playing) Is this what he'd say to you?

Client: Yes. I'm pretty sure of it.

Therapist: All right. How would you respond?

Client: I'd probably say, "That's garbage! I'm just as interested in dad as you are."

Therapist: You are still on the attack.

Client: Well, that's what I'm afraid of. I'm so mad at him. I'd probably just blow up.

Therapist: Then let me be you now. (role-playing) I'm very concerned about dad's comfort and his welfare. I want the best for him. I think there are far better facilities.

Client: Don't be such a jerk. How come you are suddenly such an expert on nursing homes?

Therapist: Let's not miss the point. All I am saying is that I feel entitled to be involved in the family decision making, and I am also asking if several places had been looked into.

Client: (no longer role-playing) I see what you're doing. You are simply sticking to the issues.

Therapist: Exactly. Now let's start from the beginning. Talk to your brother.

Client: (role-playing) I want to share some feelings with you about dad and the nursing home situation. In the first place, I am bothered that I was not consulted, and second, I wonder if he is now in the best vicinity around here.

Therapist: That's much better. But you were looking down at your feet. Try to look him in the eye. Now let's go over the entire conversation and see if you can avoid launching an attack.

It is perhaps not surprising that, at the following therapy session, clients who received behavior rehearsal are far more inclined to report having confronted the issue than those who received advice or nondirective therapy. When conducted in groups, behavior rehearsal is often even more robust. Role-playing in a group is apt to be more authentic. For example, a man who is awkward about asking women out on a date is more likely to benefit when role-playing in a group with an attractive woman than when the male therapist plays this particular role. Peer pressure in a group and the wider range of feedback available also tend to augment positive outcomes.

IV. SUMMARY

Social skills training is one of the important aspects of social learning approaches to clinical problems. The implication is that many people fail in their interpersonal dealings because they have response deficits—they do not know how best to approach others, how to make assertive rather than aggressive responses, and how to express their feelings in an adaptive manner. Coaching, training, and modeling are integral aspects of the specially focused role-playing procedures called behavior rehearsal. This technique has been widely applied within and outside clinical situations to include business organizations, athletic teams, and educational settings. When used in a group, behavior rehearsal tends to be especially effective.

See Also the Following Articles

Behavioral Group Therapy ■ Cognitive Behavior Therapy ■ Efficacy ■ Heterosocial Skills Training ■ Modeling ■ Role-Playing

Further Readings

- Bandura, A. (1995). *Self-efficacy in changing societies*. New York: Cambridge University Press.
- Bandura, A. (1997). *Self-efficacy: The exercise of control*. New York: Freeman.
- Lazarus, A. A. (1966). Behavior rehearsal vs. nondirective therapy vs. advice in effecting behavior change. *Behaviour Research and Therapy*, 4, 209–212.
- Lazarus, A. A. (2000). Multimodal therapy. In R. J. Corsini & D. Wedding (Eds.), *Current psychotherapies*. Itasca, Illinois: Peacock.



Behavior Therapy: Historical Perspective and Overview

John P. Forsyth and Jill Sabsevitz

University at Albany, State University of New York and the Center for Stress and Anxiety Disorders

- I. Brief History of the Conceptual Evolution of Behavior Therapy
- II. Conceptual Foundations of Behavior Therapy
- III. The Science and Practice of Conceptually Driven Behavior Therapy
- IV. Summary
Further Reading

GLOSSARY

applied behavior analysis Uses techniques derived from operant conditioning to modify behaviors of personal and social importance based on the notion that behavior is a function of its consequences.

behavior Behavior is what organisms do. With humans, behavior includes public or overt actions (e.g., walking, talking) and covert actions such as thinking, feeling, emoting, remembering, problem solving, self-observing, and the like. Some behavior therapists define behavior narrowly in terms of observable overt actions, whereas others consider all overt and covert actions as behavior.

behavior analysis An integrated basic and applied branch of psychology concerned with the prediction and control (influence) of behavior via identification and manipulation of consequences that follow behavior. This view is grounded in the philosophy of science known as radical behaviorism. The applied branch of behavior analysis is often used synonymously with behavior modification, and terms such as applied behavior analysis. Clinical behavior analysis is a newer branch of behavior analysis most closely affiliated with outpatient psychotherapy.

behaviorism A conceptual framework that is grounded in a unique view of human behavior and mental life: a frame-

work that underlies a science of behavior, not the science itself. Behavioral science comprises findings, principles, laws, and theories resulting from behavioral research, whereas behaviorism entails the philosophy, ideology, assumptions, and values implicit in a science of behavior. Behavior therapy is part of behaviorism but is not synonymous with it.

behavior modification Set of procedures (e.g., contingency management, time out, positive reinforcement) that are derived largely, but not exclusively, from behavior analysis, operant learning principles, and theory.

behavior theory Refers to overarching conceptualizations of human behavior grounded in basic behavioral science and principles of learning. There are many behavior theories that more or less share this basic set of features.

behavior therapy Comprises the systematic application of operant and respondent learning principles and contemporary learning theory for the purposes of scientific understanding and the alleviation of human suffering in therapy. This approach values objectivity and demands that rigorous empirical standards of proof be applied to treatment development and ongoing evaluation of psychosocial treatment outcomes.

cognitive-behavior therapy A branch of behavior therapy that considers cognition as something other than behavior and therefore requires a unique conceptual system and procedures to account for it. Cognition is said to mediate or cause other behavior, and faulty cognitive processes are believed to contribute to the etiology, maintenance, and treatment of abnormal behavior. Traditional behavior therapists, who hold to the monistic assumption that cognition is behavior, regard the hyphenated term cognitive-behavioral as a redundancy.

contextualism A philosophical world view, most affiliated with the writings of Stephen Pepper and philosophy of sci-

ence known as radical behaviorism, that takes as its root metaphor the actions of the whole organism in its context.

epistemology A branch of philosophy concerned with the nature and origins of knowledge (e.g., what is known or knowable). Though behavior therapists are not generally committed to any single epistemological theory, they do generally adhere to an empiricist epistemology.

mechanism A philosophical position that adopts as its root metaphor the machine and the parts that drive its operation. Mechanists uphold that the whole can be derived from the sum of its parts, and that discovery of the parts (e.g., thought, emotion, overt behavior) and the relations among parts are critical to explaining human behavior. Mechanists generally uphold a correspondence-based truth criterion and are generally nomothetic in their reasoning.

methodological behaviorism A normative theory about the scientific conduct of psychology and claims that psychology should concern itself with the observable behavior of organisms (human and nonhuman animals), not mental events such as thoughts, feelings, and other similar private constructions. The reason is that private events fail to meet the criterion of public agreement. In this view, reference to mental events adds nothing to explaining the variables controlling behavior. Mental events are private entities that, given the necessary publicity of science, do not form proper objects of empirical study. Methodological behaviorism is at the core of John B. Watson's (1878–1958) behaviorism, *not* Burrhus F. (B. F.) Skinner's (1904–1990) radical behaviorism.

monism A philosophical position that stipulates that what one observes and talks about is a real and physical world—one world of substance existing in space or time. Monism is at the core of behaviorism and a behavioristic world view and is reflected in the thesis that behavior (thoughts, physiological events, overt actions) is one stuff (i.e., physical) and situated in relation to a real physical world in space and/or time: a view that is the antithesis of Cartesian dualism, but not synonymous with reductionism.

pragmatism A view, espoused originally by Charles Pierce and later developed by William James, that focuses attention on practical goals and outcomes, or making a difference. The general pragmatist notion is that “a difference must make a difference to be a difference.”

radical behaviorism A philosophy of science associated with the writings of B. F. Skinner and the activities of those operating within the basic and applied branches of behavior analysis. Radical behaviorism is a contextualistic, monistic, functionalistic, wholistic, and pragmatic philosophy of science: one that rejects the truth by agreement criterion of methodological behaviorism and considers events taking place in the private world within the skin. Private events are not called unobservable and are not dismissed as subjective but are to be interpreted and explained using the same scientific terms used to explain all other behavior. This is what is “radical” about radical behaviorism.

scientist–practitioner model Originated out of the 1949 conference in Boulder, Colorado. The model stipulated a framework for training clinical psychologists such that clinical psychologists should be (a) producers of scientific knowledge, (b) consumers of scientific knowledge, and (c) evaluators of knowledge via data-driven outcomes assessment in their work with those they serve.

social learning theory A theory, developed by Albert Bandura, proposing that the influence of environmental events on the acquisition and regulation of behavior is largely determined by cognitive processes. Expectancies and vicarious learning play a central role, and the person is viewed as an agent and an object of environmental influences.

vicarious learning Stipulates that humans can learn simply by observing others, and that such learning does not require positive or negative reinforcement.

Behavior therapy comprises a set of activities involving the systematic application of operant and respondent learning principles and contemporary behavior theory for the purposes of scientific understanding and the alleviation and prevention of human suffering. This should not be taken to mean that there is unanimity of voice among those calling themselves behavior therapists with regard to this view of behavior therapy. Long-standing disagreements exist over the very definition of behavior therapy, including the range of acceptable intervention methods and explanatory concepts that fall within its purview. Yet, the distinguishing foundational tenets of behavior therapy, remain rooted in behaviorism, learning principles, and behavior theory, and the science-based application of such principles, coupled with a strong empirical foundation, in therapy. Though not all behavior therapists ascribe to this view (in fact, many do not), those that do are practicing behavior therapy consistent with the original intent of the term.

Nowadays, the science and practice of behavior therapy are often equated with a range of intervention techniques (called behavioral, cognitive-behavioral, and sometimes cognitive only) aimed at modifying and changing problematic human behavior and fostering development of more adaptive functional behaviors. To be sure, an impressive array of empirically supported psychosocial intervention technologies emanated from the behavior therapy movement, and many such technologies now dominate the psychotherapy scene as treatments of choice for a wide range of problems. One could argue that practitioners from other psychotherapeutic orientations who employ such

interventions are, in fact, practicing behavior therapy. Yet, behavior therapy is more than the mere application of behavioral intervention technology, more than using an experimental approach, more than taking an empirical approach in working with clients, and certainly more than a focal interest in behavior. Indeed, this small set of intellectual commitments is shared somewhat by psychologists of varying persuasions, and particularly those that ascribe to the scientist–practitioner model. As is outlined, behavior therapy comprises a shared set of working conceptual assumptions and values that help frame answers to basic research and applied questions and ultimately is what behavior therapists do when attempting to alleviate an increasingly wide range of human suffering in individuals, couples, groups, organizations, communities, and so on. This approach is most uniquely and closely aligned philosophically, conceptually, and methodologically with behaviorism and an experimental approach to solving basic and applied problems rooted in principles of learning and behavior theory; hence the name “behavior” therapy is most aptly used to distinguish this approach to science and practice from other approaches that are data based and empirically driven but neither philosophically nor conceptually rooted in behaviorism and behavior theory. Our intent here is to elucidate the conceptual assumptions and behavioral values that are somewhat unique to the behavior therapy movement and to show how such conceptual assumptions guide the science and practice of behavior therapy. We begin with an overview of the evolution of behavior therapy as a unique approach to psychological science and practice.

I. BRIEF HISTORY OF THE CONCEPTUAL EVOLUTION OF BEHAVIOR THERAPY

Behavior therapy was conceived in a psychotherapeutic climate that was more than ready for it, but not quite ready to embrace it. At the time of behavior therapy’s formal inception in the early 1950s, the mental health care scene was largely dominated by psychiatrists, many of whom were trained in medicine first, and second in classic psychoanalysis, or what was the then dominant Freudian or neo-Freudian psychoanalytic framework. Treatment focused largely on unearthing unconscious processes believed to be the real reasons for psychopathology and suffering. Therapy was long term, often taking years not weeks, and the disease model of the etiology, diagnosis, and treatment of psychological

disorders served as the prevailing conceptual framework. Psychiatrists ruled the roost with regard to mental health care, and psychologists often played second fiddle to them. Persons in psychotherapy often devoted considerable time and resources to delve into their pasts to uncover unconscious and hidden conflicts believed to underlie their problems, with the hope that, in the hands of a skilled psychoanalyst, they would achieve insight (i.e., making the unconscious conflicts consciously accessible), and ultimately a cathartic cure. Treatment was also driven more by hunch and clinical intuition than by science and data. Empirical accountability, or treatment decisions supported and guided by data, was virtually nonexistent. Public mistrust about psychotherapy, including social stigma about mental disorders, was at an all time high. Something had to change, and the early behavior therapy pioneers were poised to offer an alternative approach that would forever revolutionize mental health care.

A. Early Developments and Precursors

Various theories and procedures common to contemporary behavior therapy were described before behavior therapy, or even psychology, was established as a scientific and professional discipline. For instance, in first-century Rome, Pliny the Elder placed spiders in the glasses of alcohol abusers to cure them of their addictions. Today, that technique is referred to as a form of aversive counterconditioning. A procedure similar to imaginal desensitization was outlined in 1644 by Sir Kenelm Digby and involved the association of aversive imagery with pleasing circumstances. John Locke in 1693 described in vivid detail a procedure for the treatment of an animal phobia that we would now call *in vivo* exposure therapy. In the 18th century, the “Wild Boy of Aveyron” received an intervention that many would currently view as comprising positive reinforcement and modeling procedures. In his 1890 book, *Principles of Psychology*, William James described a case of a child who had become extremely fearful following an experience of being burned by a candle and, in so doing, showed a remarkable conceptual grasp of conditioning before conditioning had been formally introduced within American psychology. A point system or token economy, or what many would identify as an operant procedure, was implemented by Alexander Manconchi in the 1800s to prompt inmates at the Royal British penal colony to obey prison rules. As Isaac Marks noted in his 1981 text, *Cure and Care of Neuroses*, even Freud

and his followers periodically affirmed the role of exposure in treatment of fears and phobias, and other procedures, from diverse areas such as Chinese medicine, Zen Buddhism, Morita therapy, folk practices of aboriginal tribes in Malaysia, and psychotherapy practices resemble what many would call behavioral interventions. Though these and other examples are certainly of historic interest, none appears to have influenced the development of behavior therapy directly (if at all). The more direct antecedents of the behavior therapy originated from a confluence of factors occurring within early-20th-century psychology.

B. The Beginnings of a Behavioral Revolution within Psychology

Psychology in the early part of the 20th century was struggling with its own identity as a science. Psychology prior to 1913 was considered a science of mental life, and the chief method of studying mental life and experience was introspection. Introspection and its variants represented an attempt to systematically unearth the contents, structures, and functions of consciousness via complex and often convoluted methods of teaching research participants to accurately observe and report on their own private experiences. Introspectionism, as it came to be called, was essentially a doctrine that upheld that the hidden world of private mental life mattered and that consciousness was a worthy topic of psychology that distinguished it from other sciences as a science in its own right.

That all changed in 1913, with the publication of the first of two lectures John B. Watson delivered before the Columbia University Psychological Seminary, titled *Psychology as the Behaviorist Views It*. In the first of these lectures, which appeared in *Psychological Review* and became well known as the “behaviorist manifesto,” Watson argued forcefully against consciousness as psychology’s subject matter and introspection as psychology’s method of choice. Instead, he maintained that psychology is and should be a purely objective experimental branch of natural science, whose theoretical goal is the prediction and control of behavior. In so doing, Watson tried to provide a coherent rationale to legitimize behavioral methods that had been in use since the 1870s with animals and humans and to redefine psychology’s subject matter as observable behavior, not mind, with its chief methods being direct observation and measurement of behavior. In effect, Watson maintained that one could understand the mind by understanding relations between antecedent environmen-

tal stimuli (S) and reflexive or elicited behavioral responses (R); a view now familiar to many as an early form of stimulus–response, or S–R psychology.

John B. Watson’s relatively short career in psychology and as an academic was indeed influential, and he can be credited for bringing the work of Russian physiologist Ivan Pavlov, and particularly Pavlov’s work on the conditioned reflex, to American psychology and proselytizing its theoretical and applied importance. Indeed, by the early 1920s, Watson and his wife Rosalie Rayner had demonstrated the acquisition of conditioned fear of a white rat in the now-classic case study of Little Albert, and the subsequent generalization of such fear to other white furry objects. This demonstration was derived from conditioning procedures set forth originally by Ivan Pavlov: procedures that came to be known as Pavlovian or classical conditioning in the United States and abroad. By 1924, Mary Cover Jones went on to demonstrate how fears could be treated via social imitation (now known as modeling) and exposure to a feared stimulus without anticipated negative consequences: a procedure that extends basic knowledge of Pavlovian classical conditioning principles, such as extinction via nonreinforced exposure, to the applied realm. With this successful demonstration, the seeds of what would become behavior therapy were planted. Though it took about 25 years for Watson’s ideas and those of his followers to catch on, by the early 1930s, Watsonian behaviorism—sometimes referred to as methodological behaviorism—and its variants had taken center stage within American psychology. Psychology had ceased to be the science of consciousness and had become the science of behavior *sine qua non* observable behavior.

C. Post-Watson Era of the 1930s and 1940s: Enter the Neobehaviorists

Few of Watson’s ideas had survived intact in the 1930s, and many of his neobehaviorist contemporaries began to take psychology and behaviorism in new and quite different directions. Psychology as a science of behavior was retained during this period, and behaviorism flourished in academic departments around the United States. New theories of learning and conditioning revolved around major neobehaviorist figureheads, such as Clark Hull, Edwin Guthrie, Edward Thorndike, B. F. Skinner, and Edward Tolman. Each of these individuals, in turn, laid the conceptual and scientific groundwork for what would later become behavior therapy.

At the peak of his career Clark Hull was one of the, if not the, most influential behaviorists in the world and devoted most of his life to developing a sophisticated behavioral theory of adaptive behavior. His interest in mechanical devices and mathematics would become a metaphor for how to conceptualize the nature of human behavior and mental life. Like the other neobehaviorists to follow, Hull viewed consciousness as phenomena in need of explanation, not as explanatory devices in their own right. Indeed, Hull's behaviorism emerged from his view that Watsonian behaviorism was crude and seriously flawed. Hull gave close attention to Ivan Pavlov's work and saw in it a way to study conditioning as a means to achieve his goal of an experimental science of thought processes conceived as mental habits. Just as a machine operates according to relations among parts, Hull deduced that human behavior functions similarly via relations among habits that are established through associative conditioning processes. Indeed, Hull's thinking about human behavior as "machine-like" was a direct outgrowth of his interest in mechanical devices, and machine design became a model of theoretical structure to explain the human machine. Logic and deductive thinking were the cornerstones of Hull's psychology, and hierarchical theory building in terms of conditioned habits and habit chains the model of human action. Hull's theoretical system eventually collapsed under its own weight, but Hullian notions would play a large role in the conceptual thinking of early behavior therapists, particularly Hull's focus on precision and scientific rigor, rejection of subjectivity, conceptualization of Pavlovian conditioning in terms of habit formation and mediation, and use of the hypothetico-deductive method. Though Hull's emphasis on logic did not have any real import in the thinking of behavior therapists, his mechanistic view of psychological science and human behavior did. As we see shortly, mechanism is very much part of contemporary behavior therapy.

Edward Tolman is similarly important for his purposive behaviorism: a brand of behaviorism that was explicitly cognitive from the start and, in many respects, is the precursor of modern cognitive theory and the cognitive-behavioral movement within behavior therapy. Tolman identified himself as a behaviorist, eschewed introspection, downplayed Pavlov's reflexology, opposed the behaviorism of John B. Watson, outright rejected Thorndike's connectionism, and openly embraced Gestalt psychology and contextualism as a philosophy. In his 1932 classic, *Purposive Behavior in Animals and Men*, Tolman disputed the mechanistic pic-

ture of behavior presented by many versions of behaviorism and insisted that behavior is inherently purposive and cognitive, with purpose and cognition being part of the contextual behavioral whole as manifest in behavior, not as mentalistic entities apart from behavior. In this work Tolman foreshadowed the concept of what would be known as the intervening variable: a concept that represents an attempt to legitimize talk and inferences about cognitions, purposes, and the like by anchoring such inferences in terms of observable antecedent and consequent events. Eventually Tolman would move his thinking in the direction that knowledge about the world is mediated by cognitive representations of that world, and that purposes and cognitions would have to be assigned a hypothetical rather than observed status. Tolman adumbrated what would become a major source of conceptual disagreement in behavior therapy, with some behavior therapists emphasizing the causal status of cognition, while others maintaining that cognitions are not causes of behavior, but merely more behaviors in need of explanation.

Last, while the neo-behaviorists Edward C. Tolman and Clark L. Hull were vying for ascendancy within experimental psychology, a young student of animal behavior, B. F. Skinner was at work articulating the philosophy and science of a new brand of behaviorism that would forever revolutionize psychology and behavior therapy. Unlike his behaviorist contemporaries, Skinner argued that most animal and human learning is shaped and maintained by consequences following behavior; that behavior is both elicited (in a Pavlovian sense) and emitted (in an operant consequential learning sense) and must be understood in relation to environmental contextual variables; and that behavior is what organisms do, including thinking, feeling, emoting, problem solving, and what are traditionally referred to as cognitions. For Skinner, the skin was merely an arbitrary boundary between public and private events: a boundary that presented a particular challenge for a scientific account of private life, but not for the philosophy of that science. Indeed, unlike John B. Watson, Skinner's radical behaviorism was radical precisely because he maintained that a science of behavior must provide an adequate account of events occurring within the skin (e.g., cognitions, emotions) in a manner consistent with other known laws and principles used to account for other behavior (both private and publically observable). What Skinner rejected was the use of mentalistic lay terminology (e.g., anxiety, fear, creativity, joy) and hypothetical constructs as explanations in a science of behavior, not the very real phenomena to which such

terms may refer. In his 1938 book, *The Behavior of Organisms*, Skinner outlined the beginnings of this new research program with laboratory animals: a program that emphasized the scientific goals of prediction and control (one goal, not two) of behavior via intensive experimentation with individual organisms across time. This program, in turn, eventuated in what came to be known as operant psychology, or the field of basic and applied behavior analysis. It would be almost a decade later before Skinner's ideas would take hold in behavior therapy, and when they did, they were compartmentalized as falling under the aegis of behavior modification and applied behavior analysis.

By the end of the 1940s, behaviorism had reached its zenith within American academic psychology and was, in many respects, poised for a precipitous decline two decades later with the rise in popularity of cognitive theory and cognitive experimental psychology in the 1960s. Before such a decline would take place, behaviorism and behavioral thinking would first revolutionize the face of applied clinical psychology as an alternative to psychoanalysis. That revolution, became known as behavior therapy.

D. 1950s: The Dawn of Behavior Therapy across Three Continents

Behavior therapy emerged on the psychotherapeutic scene in the early 1950s as an applied extension of experimental psychology, which was still predominantly behavioristic in its approach. Applied psychology, on the other hand, was dominated largely by psychiatrists, and a disease model of psychopathology and human suffering. According to this model, abnormal behavior was considered symptomatic of an underlying mental illness, or a psychic disturbance or personality conflict similar to a medical disease. Clinical psychology, as a profession, was a newcomer having only been recognized formally in 1949 in the years shortly following World War II. Though early clinical psychologists, trained as they were within the scientist-practitioner model set forth by the delegation at the 1949 Conference in Boulder, Colorado, were poised to establish behaviorism in mental health care, and hence what came to be known as behavior therapy, they did not. Newly trained clinical psychologists during this period, though trained as scientists within the predominant experimental and behavioristic mold, turned to the then-dominant Freudian and neo-Freudian conceptual framework for their clinical inspiration as practitioners. Indeed, there was no real viable competing alterna-

tive framework for the practice of clinical psychology. Though Andrew Salter's 1949 book, *Conditioned Reflex Therapy*, describing human neurosis in Pavlovian conditioning terms had just come on the scene, and John Dollard and Neil Miller offered a compelling behavioral translation of Freudian concepts in 1950, neither text seemed to have any appreciable impact in producing a behavioral applied psychology anchored in behavioral science. In fact, Dollard and Miller's efforts to bring Freudian concepts in line with conditioning principles was predicated on the tenuous assumption that classic Freudian psychoanalysis was, indeed, efficacious as a treatment for psychological problems. This assumption, of course, was just that, an assumption without any hard data to support it. As controversy mounted regarding the efficacy of psychotherapy in general, many began to seek out alternatives. One such alternative that was about to emerge as a dominant player was behavior therapy.

Behavior therapy was established through the tenacious and somewhat independent efforts for several pioneers, including Joseph Wolpe and his student Arnold Lazarus in South Africa, the experimental and clinical work of Monty B. Shapiro and Hans J. Eysenck at the Maudsley Hospital in London, England, and efforts of Andrew Salter, O. R. Lindsley, and B. F. Skinner in the United States. All shared an interest in the extrapolation of experimental findings and principles from laboratory research with animals to explain human behavior, and predominantly—with the exception of Lindsley and Skinner—the acquisition and elimination of neurotic anxiety. The early pioneers shared a sense of unity, common purpose, and a revolutionary passion for the science itself and what the science could offer individuals, groups, and society at large. Most of the early founding members had one foot planted in the basic experimental science and one in the clinic and moved between both nimbly and with grace. The early behavior therapists understood behaviorism, behavior theory, behavior principles, and how to put them to use creatively to achieve practical purposes in therapy. Behavior therapy was, in many respects, considered the applied application of behavioral science, much as engineering represents the applied extension of physics. Early behavior therapy entailed a behavioral core: a core that was reflected in a rigorous scientific approach aimed at developing a science of human behavior and use of that knowledge to achieve practical therapeutic goals. Armed with only a handful of powerful theoretical ideas and treatment techniques, Wolpe, Lazarus, Eysenck, and Skinner, along with a few colleagues and students

(e.g., Cyril Franks, Andrew Salter, Stanley Rachman, Leo Reyna) took on the psychoanalytic and psychiatric establishment at universities and in applied clinical settings across three continents. In so doing, the pioneers of the behavior therapy grounded psychotherapy squarely in the context of behavioral science.

Two highly influential books also appeared during this time that helped to establish behavior therapy as a unique approach to the understanding and amelioration of human suffering in psychotherapy: namely Joseph Wolpe's (1953) *Psychotherapy by Reciprocal Inhibition*, and B. F. Skinner's (1958) *Science and Human Behavior*. Skinner's 1958 text showed how the principles of reinforcement and punishment could be put to practical use in understanding and modifying otherwise complex human behavior in and outside of therapy. Though Skinner was not a behavior therapist, he was tenacious throughout his long life in showing how the principles derived from basic behavioral science had broad practical relevance. Wolpe's 1953 book, on the other hand, offered a more narrow conceptualization of human neurosis in terms of Pavlovian and Hullian learning principles coupled with a dash of neurobiology, while also introducing new therapy techniques derived from such experimentally derived principles (i.e., systematic desensitization, assertion training), and impressive outcome data to back them up. To this day, Wolpe's carefully documented program of treatment development, a program that included his own basic laboratory research with cats and clinical outcome data on more than 100 individual cases, remains the largest single-case replication series in the history of psychology.

In the ensuing years, data supporting the efficacy of behavior therapy began to mount at a rapid rate. Soon others increasingly joined the behavioral inner circle and rallied together to promote a rigorous experimental epistemology with regard to treatment development and analysis of therapeutic processes and outcomes, and against what was perceived as a conceptually rich, but practically useless, psychoanalytic approach to psychotherapy and behavior change. Behavior therapy began to grow and with that growth came concern about the nature and meaning of the term *behavior therapy*: a term first coined in 1953 by Ogden Lindsley, B. F. Skinner, and Harry Solomon in a monograph describing the application of operant procedures in a psychiatric hospital setting. By 1958, Arnold Lazarus offered an explicit definition of behavior therapy as *the application of objective, laboratory-derived therapeutic techniques to the treatment of neurotic patients*. One year later, Hans Eysenck would define behavior therapy more broadly as

the application of modern learning theory to the treatment of psychiatric disorders. The definition of what constitutes behavior therapy would continue to undergo substantial revision in the decades to follow such that the conceptual foundations of behavior therapy—rooted in behaviorism, learning theory, and principles of learning—would be replaced by the more general affiliation of behavior therapy with psychological science, empiricism, a data-driven approach to treatment, and a specific brand of therapy or therapeutic techniques. The dissolution of behavior therapy's behavioristic conceptual core began in earnest in the 1960s, and in many respects, has not recovered since.

E. The 1960s and Beyond: Behavior Therapy Comes of Age and Grows a Belly

By the 1960s, the behavioral revolution in mental health care was on its way to being won, and behavior therapy was considered a viable alternative framework to the prevailing psychiatric medical model of human suffering. Two behavior therapy journals, *Behaviour Research and Therapy* and *The Journal of Applied Behavior Analysis*, were established, and several highly influential anthologies outlining the fundamentals of this approach appeared, including Hans Eysenck's *Behavior Therapy and the Neuroses* and his later book *Experiments in Behavior Therapy*, and Leonard P. Ullmann and Leonard Krasner's *Case Studies in Behavior Modification*, and an edited volume by Cyril Franks titled *Behavior Therapy: Appraisal and Status*. Behavior therapy underwent substantial growth during the tumultuous 1960s, and with that growth came increasing diversification, internal dissent, and self-critical evaluation. It was the decade, as Cyril Franks recently put it, of oversimplification with regard to behavior theory and behavioral principles, grandiose claims regarding the effectiveness of behavior therapy, and intolerance from within and from without.

In 1966, the founders of behavior therapy established a professional organization, first named Association for Advancement of Behavior Therapies (plural), and later modified in 1968 to reflect the singular Association for Advancement of Behavior Therapy. The name change occurred, in part, to convey the sense that behavior therapy was primarily a conceptual approach to science and practice, not a collection of professionals united by an interest in behavior change technologies. Most behavior therapists shared a common, though by no means uniform, learning-theory orientation and interest in a general behavioral approach. Yet, many were attracted to

the promise of behavior therapy mostly for its pragmatic approach and its empiricism, particular as applied to treatment development and implementation, and data-driven therapy outcomes assessment. Behaviorism, as the conceptual core of behavior therapy, was gradually replaced by more pluralistic views, and behavior therapy came to be defined within much broader sociopsychological models. Such models emphasized empiricism and altering a person's behavior *directly* through the application of *general* psychological principles, not necessarily behavioral learning principles. Early behavioral approaches, grounded as they were in behavioristic thinking and animal research, were increasingly viewed as too narrow and simplistic to account for complex human behavior. Particularly controversial was the capacity of behaviorism and behavior theory to account for the role of cognition in relation to problematic behavior seen in outpatient clinics with highly verbal adults. This controversy was never satisfactorily resolved and came to a head with the 1969 publication of Albert Bandura's highly influential text, *Principles of Behavior Modification*. In that text, Bandura outlined his social learning theory approach, emphasizing the importance of vicarious learning, cognitive mediation, and the self-regulatory function of human behavior. Ironically, social learning and cognition were always part of post-Watsonian behaviorism and early behavior therapy, and particularly the writings of B. F. Skinner and Arthur Staats. Yet, the behavioral conception of cognition as behavior to be explained in terms of principles of learning was seen as limited; a view that persists to this day.

By the mid-1960s, behavior therapy had grown a belly and the song, bell, and hammer of the early days were replaced by increasing pluralism, numerous heterogeneous treatment procedures with different theoretical rationales, and open debate about the conceptual basis and methodological requirements of behavior therapy. Without a common enemy, behavior therapists began to fight battles with themselves about the very nature of behavior therapy and what constituted an adequate definition. Such criticisms, and even outright dissent, reached as far as the halls of Congress and state and local governments, resulting in withdrawal of research funding, forced abandonment of treatment programs, and legislation that otherwise banned some techniques used routinely by behavior therapists on the grounds that they violated the rights of patients and others. It turned out that much of the criticism was due, in large part, to public misunderstanding about behavior therapy, including poor understanding about behaviorism on the part of those calling themselves behavior thera-

pists. Indeed, during this period, it was common for behavior therapy to be wrongly associated with sterilization programs applied to black persons with retardation, insulin shock therapy applied to psychotic patients in institutionalized settings and without their consent, the use of coercive procedures such as punishment or shock to control behavior, and general charges of manipulation and dehumanization. Even within psychology, behavior therapy was often viewed as mechanistic, in an inhumane coldhearted sense. Behavior therapists were likewise increasingly guilty of misunderstanding and misapplication of behaviorism, behavior theory, and behavioral principles in the applied arena. Most often this would take the form of simplistic and rigid extrapolations of behavioral learning principles from animal research to explain interesting and important facets of human behavior (e.g., thinking, emotion). The result of attempts to squeeze such principles into an analysis of problematic human behavior (e.g., cognition, emotion, self-control) was often met with frustration and frank failure. The same sort of misaligned extrapolation occurred with regard to behavioral theories in the context of psychotherapy, and often with similar poor results. Such difficulties served, in part, to foster the cause of the more ecumenical strands of behavior therapy that were increasingly becoming more popular, particularly Albert Bandura's social learning approach, Arnold Lazarus's multimodal therapy, Aron Beck's cognitive therapy, and eventually the perspective known as cognitive-behavior therapy.

By the mid 1970s and throughout the ensuing two decades, behavior therapy's behavioristic conceptual core had eroded, and few behavior therapists turned to behavioral thinking for their clinical inspiration. The unbridled enthusiasm of the late 1950s and 1960s was replaced by a more cautious optimism and concern by some that behavior therapy had lost its behavioristic conceptual moorings and, in so doing, had become indistinguishable from the rest of applied empirical psychology. Clinical scientists and practitioners were increasingly drawn to behavior therapy for its empiricism, not for its behaviorism. Cognitive conceptualizations and cognitive-behavior therapy became the rule, and behavioristic behavior therapy the increasing exception. Behavior therapists began to incorporate empirical methods and concepts from experimental and social psychology, and psychological science more generally. Treatment development and implementation proliferated, numerous doctoral-level behavior therapy training programs were now well established. Behavior therapists' identity as empiricists disappeared as other

approaches to therapy began to participate in clinical trials. It gradually became apparent that empiricism could be exported to any approach, not just behavior therapy. Behavior therapists were left without a unique theoretical legacy, and gradually behavior therapy and cognitive-behavior therapy became one of many strands in mainstream clinical psychology: an approach without an overarching theory and one far removed from the behaviorism from which it initially emerged. In many respects, behavior therapy had become nothing more than the personification of the conceptually neutral scientist-practitioner model of clinical psychology.

F. Contemporary Behavior Therapy Nearing the Age of Fifty

Behavior therapy in the year 2001 looks quite different from the behavior therapy of the 1950s. Behavior therapists have long since won the fight for legitimacy in the mental health care arena; the success of behavior therapies for a wide range of problems is well established. Behavior therapies are in vogue, and behavior therapists have few real adversaries. Armed with data in hand, behavior therapists are leading the charge to demonstrate that psychosocial interventions work to alleviate a broad range of human suffering. Randomized clinical trials, efficacy, effectiveness, manualized treatments, dissemination, treatment outcomes assessment, accountability, time efficiency, cost containment, treatment quality and integrity, and managed care are now common buzz words. There are relatively few behavior therapists with one foot planted in basic behavioral science and the other foot in the clinic. Few of those calling themselves behavior therapists are thoroughly familiar with behaviorism and contemporary principles of learning from behavioral science, and even fewer look to behavior theory and behavioral principles for clinical inspiration. Ironically, it is precisely this approach that paved the way for behavior therapy's early successes: one that contemporary behavior therapy seems to have lost sight of, particularly judging the need for the thematic title—*Bridging the Gap from Science to Clinical Practice*—of the 1994 annual meeting of the Association for Advancement of Behavior Therapy. Most behavior therapists identify themselves loosely as cognitive-behavior therapists and do not see use of this hyphenated term as a conceptual redundancy. Novel treatment innovations are few and far between, and the modus operandi is to transport existing treatments almost whole cloth (e.g., relaxation training) to diagnostically dissimilar clinical conditions and test for their

efficacy within large-scale randomized clinical trials. In many ways, behavior therapists have suffered from their own inadequate training in philosophy of science and have become radical empiricists, logical positivists, and, to use B. F. Skinner's terminology, methodological behaviorists. In doing so, behavior therapists have fallen into the trap of mechanistic thinking, of dualism, and of deemphasizing the importance of behavior principles and behavior theory. Behavior therapy's treatment technologies are now finding their way into the hands of nonbehavioral practitioners who, by virtue of their training, have little affiliation with behavior therapy, behavior principles that drive the treatment technology, and behaviorism. Though dissemination is an important and potentially beneficial development, it also illustrates that one need not be trained behaviorally to use a behavioral intervention successfully. Interest in the conceptual foundations of behavior therapy, and the practice of conceptually driven behavior therapy is, for the most part, seen as irrelevant for the successful implementation of behavioral intervention technologies. What it means to be a behavior therapist is now, more than ever, anyone's guess.

II. CONCEPTUAL FOUNDATIONS OF BEHAVIOR THERAPY

The conceptual foundations of behavior therapy owe much to the historic evolution of behaviorism, not in the sense of its impressive products vis-à-vis treatment interventions, but the development of a unique way of framing basic and applied problems. To use the term conceptual to describe the foundations of behavior therapy may, at first glance, appear like a contradiction. The reason has to do with the meaning of the adjective term conceptual: a term which is derived from the Latin words *conceptus* and *later concipere* that, when translated literally, means "the act of conceiving thought," or "existing or dealing with what exists only in the mind." This view, of course, was characteristic of introspectionism that dominated psychology in the late 19th and early 20th century: an approach that early behaviorists, and eventually behavior therapists, vociferously rejected. Antonyms of the word conceptual, such as practical, pragmatic, realistic, concrete, material, substantial, and tangible, more aptly describe the values shared by those calling themselves behavior therapists, or at least behavior therapists of the behavioristic stripe. Yet, use of the adjective "conceptual" in the context of behavior therapy is still useful, for it captures the

essence of behavior therapy as a loosely interconnected set of assumptions and values—ways of conceiving and understanding human behavior—that invariably influences the science and applied practice of behavior therapy. Conceptual is also useful as an acknowledgement that behavior therapy, like most branches of psychological science, is value laden, not value free. Whether we like it or not, conceptual values do play a role in how scientists and practitioners talk about behavior, what topics they deem worthy of their attention in research and therapy, the manner in which a therapist formulates a client's presenting problems in therapy, how one interprets data, and the criteria one adopts for truth and explanation, to name a few. These and other value-laden issues are at the core of all science and therapeutic practice and deserve our attention.

Gerald Zuriff, in his classic 1985 text, *Behaviorism: A Conceptual Reconstruction*, noted that behaviorism is not simply the science of behavior developed by behaviorists at the turn of the 19th century, but rather a conceptual framework underlying that science. Behaviorism is about the assumptions, values, and presuppositions implicit in a science of behavior, including applied practice. Behaviorism is certainly not a monolithic approach; there are many philosophical and conceptual strands of behaviorism. Today some behavior therapists share a strong family resemblance with behaviorism, but many more do not. In the purest sense of the term, behavior therapy refers to a conceptual view grounded in a science of behavior and principles of learning: one that values pragmatism, objectivity, prediction and control as mutually entailed scientific and practical goals, an empiricist epistemology, a monistic view of behavior, functionalism, structuralism, and either mechanism or contextualism as overarching philosophies.

The conceptual underpinnings of contemporary behavior therapy are more often implicit than explicit and are often mentioned by contemporary behavior therapists in passing as merely of historical interest only. Edwin Erwin, a philosopher by training, is the only person to have written a text devoted exclusively to the philosophical, conceptual, and moral foundations of behavior therapy, and that was in 1978. Almost a decade later, Rosemary Nelson and Steven Hayes edited a 1987 book devoted specifically to the conceptual foundations of behavioral assessment. Clarifying the conceptual foundations of behavior therapy should be of contemporary interest, if for no other reason than to understand more fully how such assumptions and values guide basic and applied activities, and more generally to dispel common misconceptions about what constitutes

practicing as a behavior therapist. Indeed, it does appear that the tide is slowly shifting back to an interest in the conceptual core of behavior therapy, as indexed by the expansive content of articles written by three generations of behavior therapists that appeared in a 1997 two-part special series of the journal *Behavior Therapy* titled "Thirty Years of Behavior Therapy: Promises Kept, Promises Unfulfilled," and a 1999 edited monograph titled *From Behavior Theory to Behavior Therapy*. Our intent in the remaining sections is to make explicit the conceptual framework driving the activities of those calling themselves behavior therapists.

A. Core Conceptual Assumptions and Values

At the time of behavior therapy's initial development, psychology was largely behavioristic, experimental psychology was primarily, though not exclusively, behavioristic, and the pioneers of behavior therapy were aligned with what was the predominant behavioristic view in American psychology; though not entirely by training (e.g., Joseph Wolpe was trained as a psychiatrist in medicine and classic psychoanalysis). The core of behavior therapy's conceptual framework emerged out of behaviorism, not independently of it, and certainly not out of thin air in reaction to classic psychoanalysis. Behavior therapy's original identity was rooted squarely in behavioral thinking; the development and creative implementation of applied treatment technology represent two of several products of that thinking. The redundancy here in this logical historic syllogism is deliberate and is meant to clarify a conceptual confusion that permeates contemporary behavior therapy. The confusion rests with the meaning of the terms behavior therapy and behavior therapist. Early on both terms referred to a behavioral way of thinking: one grounded in the belief that behavioral science (not any brand of psychological science) would develop a rich conceptual network, set of laws and principles, and powerful intervention technologies that could be put to use to explain and alleviate, with precision and scope, a wide range of human suffering. As we have seen, behavior therapy and behavior therapist have come to mean a loose association with behavioral science and a psychology of learning, and a more general affinity with experimental approach, empiricism, cognitivism, treatment technologies, and the application of findings from psychological science more generally. Behavior therapy, in effect, has become what behavior therapists do, and what behavior therapists do has come to include just

about everything that has data to back it up. Though such issues are complex and certainly deserving of more discussion, we would like to turn our attention to conceptual issues that characterize behavioral strands of behavior therapy in the original sense of the term. Such strands, in turn, can be framed within two overarching philosophical frameworks: mechanism and contextualism, respectively.

B. Mechanistic and Contextualistic Strands of Behavior Therapy

1. Mechanism

Early forms of behavioral thinking were predominantly mechanistic and reductionistic, and so too was behavior therapy. A mechanistic philosophy takes as its goal the identification of essential building blocks that compose the fundamental structure. The parts are viewed as primary from which the whole is derived. Central to this view is that the parts of the machine reflect an objective reality awaiting discovery, and that the goal of the analyses is to elucidate principles, foundational laws, and theories that can be used to categorize the parts, relations among parts, and forces that together explain the functioning of the machine. Truth is based, in large part, on correspondence between objective reality and the belief in the presumed underlying mechanisms or structures, many of which are hypothesized but not observed directly. John B. Watson's original S–R reflex thesis was mechanistic, and so too were the S–R learning theories that predominated psychology through the middle part of the 20th century. Mechanistic models, emphasizing mediational links between stimulus–response and hypothetico-deductive theorizing, were in vogue until the 1960s when they were replaced by the equally mechanistic computer simulations and information processing models from cognitive psychology.

Contemporary behavior therapy, including much of psychology, has not liberated itself entirely from mechanistic thinking, examples of which include talk of stimulus and response as immutable events with fixed properties, misunderstanding of principles of learning (e.g., considering positive reinforcement as synonymous with the delivery of M&M candy or use of verbal praise), conceptualizing conditioning preparations as equivalent with conditioning processes (e.g., viewing laboratory Pavlovian conditioning preparations as the only way to establish respondent eliciting functions: a position that we now know is incorrect), or attempts to define behavior and learning principles structurally apart from con-

text. More recent examples of such thinking in behavior therapy include the triple-response mode concept, in which abnormal behavior is conceptualized as a loosely organized system of partially independent relations between verbal-cognitive, physiological, and overt-motoric behavioral responses; symptom-focused and diagnosis-driven treatments, most of which are eliminative in nature (i.e., the symptoms are the problem, reduce or eliminate the symptoms, and thus fix the problem); and theoretical views that give causal or mediational primacy to cognitive activity as something other than behavior in explaining the origins, maintenance, and treatment of psychopathology and suffering. Added to this list would be a focus only on the topography of behavior, not its function or relation to contextual determinants; model building, and particularly models that speak of “structures” (i.e., parts) and their relations as composing explanation; and most nomothetic approaches based on aggregate groups of clients from whom inferences are made about the functioning of the human machine in the individual case. It should be noted that there is nothing inherently problematic with mechanistic thinking. The point is to recognize mechanistic thinking when one confronts it, including its assets and liabilities. Most mechanistic thinking has roots in early forms of behavioral thinking, particular the writings of John B. Watson, and the mediational neobehaviorists such as Clark Hull, Edward Tolman, Edwin Guthrie, O. B. Mower, but not B. F. Skinner.

2. Contextualism

Unlike mechanism, varieties of scientific contextualism (e.g., descriptive, functional, hermeneutic) take as their root metaphor the “act in context” or what one might think of behavior understood in and within an environmental context. It makes no sense for a contextualist to speak of parts from which the whole is derived, much as it makes no sense to speak of making love as reducible only to the actions of the genitalia, or the firing of neurons in the brain. The total unit of analysis is not reducible to mechanical collections of smaller units such as behaviors or symptoms. The unit of analysis is the whole organism in relation to its situated context: a view similar to the behavior analytic concept of the operant. What this means is that when one changes the context, one changes the organism—the event or behavioral whole—under consideration. Thus, contextualists anchor their analysis of behavior always in relation to the context and focus their interventions at the level of contextual variables that can be changed and influenced directly. Contextualists are

also inherently pragmatic and avoid claims about ultimate truth or reality. Accordingly, truth (with a small t) is judged not in any absolute sense, but rather by successful working. In other words, how well does the particular analysis help to achieve a priori practical goals? Knowledge claims, therefore, are dependent on achieving practical goals, and absolute Truth (with a capital T) held in conditional abeyance.

Modern incantations of contextualism, particularly functional contextualism, are most likely to be found within the branch of behavior therapy affiliated with the writings of B. F. Skinner and his philosophy of science known as radical behaviorism: namely applied behavior analysis and clinical behavior analysis. Contextualistic behavior therapists of the functional stripe prefer to talk about the function or purposes of behavior, rather than in terms of structures or behavioral topography only; are inherently practical and inductive in approach and method (i.e., doing what works in the most direct manner possible); eschew diagnostic thinking as a framework, but may use psychiatric diagnoses if they help achieve practical ends; are more likely to frame the analysis at the level of the individual case; and direct their interventions at changing those contextual variables of which behavior is a function. The aim of the functional contextualist is, as Tony Biglan and Steven C. Hayes noted in 1996, to develop an organized system of empirically based concepts and rules that allow behavioral phenomena to be predicted and influenced with precision, depth, and scope. Prediction and influence entail joint analytic goals: goals that are achieved when one can identify contextual variables that permit prediction of the behavior of interest, and when manipulation of such contextual features influences the nature and function of the behavior. Practically speaking, the independent variables of interest are understanding how the contextually situated actions of the therapist in therapy results in changes in the client's behavior in, and particularly outside, therapy where it really counts. Of course, the mechanistic branch of behavior therapy shares similar practical interests but adopts a different set of criteria for truth and explanation.

C. Behavior Therapy's Mixed Conceptualizations of Behavior

Two very different conceptualizations of behavior have permeated behavioral thinking. The traditional mechanistic view, owing much to John B. Watson, holds that behavior is what can be observed directly. This view, in turn, leads to a sort of dualism: behavior is what

can be seen and objectively and independently observed by others, whereas what cannot be objectively observed by others is not behavior. As an example, walking would be considered behavior, but thinking about walking would not. This view creates obvious problems, particularly when dealing with how to talk about events occurring within the skin, such as thoughts, emotions, beliefs, and the like. As we have seen, the solution offered in the 1960s was to incorporate cognitive and social learning conceptualizations to address the word beneath the skin and to restrict behavioral conceptualizations for behavior that can be observed. This solution, in turn, created its own set of problems—a sort of conceptual dualism, for now cognition and emotion were considered something other than behavior and therefore required a unique conceptual system to account for them, while behavior would still be conceptualized as overt motor acts to be explained in terms of operant and respondent learning principles. Many behavior therapists still make such somewhat erroneous distinctions: distinctions that contributed, in part, to the view that behaviorism and a science of learning are of limited conceptual value in explaining human behavior. After all, a great deal of human behavior and suffering cannot be observed directly and occurs only privately to an audience of one—the individual experiencing the private events, but this fact alone does not obviate an adequate behavioral account of such events. This is precisely the point B. F. Skinner made repeatedly throughout his writings: a point that seems to have been lost in mainstream behavior therapy.

Applied and clinical behavior analysts conceptualize behavior quite differently than do most mainstream behavior therapists. Whereas mainstream behavior therapists conceptualize behavior as divided into three separate but related parts (cognition, physiology, and overt behavior), behavior analysts consider the organism as an integrated whole; cognition is behavior, just as physiology is behavior. Behavior is what people do, but behavior is not the focal interest of behavior analysts. Unlike mainstream behavior therapists who take the behavior-as-subject-matter view (including cognition, emotion, physiology), behavior analysts operating within a contextual framework take a behavior-in-relation-to-context view. This monistic position avoids the conceptual dualism by conceptualizing all actions as behavior, including those that cannot be observed directly. It also rejects the perspective that one dependent variable (e.g., a thought) could be conceptualized as a cause of another dependent variable (e.g., another thought, overt behavior, physiology): a view that should not be taken

to mean that such private events are unimportant, however. Rather, behavior analysts prefer to talk about events occurring within the skin using the same terms used to talk about behavior that can be observed directly: namely established principles of operant and respondent learning. No new terms are invented to describe and explain private events—private events are on equal status with all other behavior to be explained and are interpreted in a manner that permits prediction and influence with scope and precision.

D. Behavior Therapy's Conception of Causation and Explanation

A behavioral conception of causation and explanation is grounded in the view that the causes of behavior reside in the determinants of behavior, not the properties of behavior. The determiners of behavior, in turn, are viewed as ultimately residing outside the behaving person. Explanation of behavior, therefore, is cast in terms of both prediction and influence over those environmental variables of which behavior is a function.

This conception of behavioral causation and explanation has been subject to its fair share of criticism. Chief among the criticisms are that this view of behavioral causation ignores the role of free will, beliefs or expectations, purposes and intentions, perception, knowledge, memories, ideas, thoughts, and feelings in guiding human action. Most psychologists, including those affiliated with strands of behavior therapy, give causal or mediational primacy to such private events in explaining human behavior, and much of the psychiatric system of diagnosis is similarly construed in terms of private events as causes of human suffering. The mechanistic core of social learning theory and other neobehavioristic and cognitive positions explains why self-efficacy and other related phenomena are considered causal. For the mechanist, structural characteristics of the behavioral system are considered behavioral mechanisms, and thus causal entities. Yet, whether such events can be construed as causes of other behavior is another matter for which there is, at present, no convincing data. Indeed, the entire field of psychology has yet to develop a technology to isolate specific private events (thought A), and not other potentially causal variables (thought B or C, physiological event F, environmental contingencies X, Y) as causes of say action Z, and there is, at present, no technology to measure directly the hypothesized private psychological processes in question. Sophisticated brain imaging technology provides a window on electrical and glucose changes in the brain, but not thoughts, feelings,

and their causal role in human action. Likewise, a person's verbal report about what they are thinking at a given moment may have nothing to do with what they were actually thinking at that moment. Indeed, we all know from commonsense social experiences that there are times when we think one thing, but say and do something quite different (e.g., a person might think "my boss is a real jerk, and then smile and with an outstretched hand say "nice to see you boss"). The issue here is not whether such private events are real and exist—they are, but whether they can be construed as causes based on available evidence and technology.

John Watson made the mistake of rejecting such events as unimportant for a behavioral science, whereas B. F. Skinner restored the importance of the inner private world in a science of behavior. Most contemporary "behavioristic" behavior therapists do not reject the very real psychological events occurring beneath the skin and acknowledge that such events can and sometimes do exert some controlling relation to other behavior, including what are loosely referred to as memories, expectancies, or feelings. What some behavior therapists do reject is talk about private events as causes, and explanations that are based solely on such events. The reasons for this rejection are pragmatic and scientific. Behavior therapists maintain that the goals of science are prediction and influence (i.e., control). The only means of achieving direct control over behavior is to manipulate environmental variables. Placing the causes, and hence explanation of, behavior inside the person puts the behavior therapist at a distinct disadvantage because there is no way to identify and influence such presumed causes directly when they are within the person. For example, saying that one thought caused another thought, an emotional response, or overt action begs the question as to what caused the first thought, how does one know, and most important what can be done about it? Contextually oriented behavior therapists resolve this issue by conceptualizing the causes of behavior as residing outside the person in the social-verbal context and direct their analyses and interventions there that, ironically, is the same context in which all therapists ultimately operate to affect clinically meaningful change.

E. Behavior Therapy's Conception of Abnormality and Human Suffering

The behavioral view of abnormal behavior is predicated on the notion that life experience gives rise to normal behavior and an adaptive range of functioning

just as life experience can produce maladaptive behavior and human suffering. To explain “normal” and “maladaptive” behavior in any absolute sense is somewhat contrary to the conceptual view of those calling themselves behavior therapists. Rather, it is maintained the similar principles of learning that result in functional behavior also can produce dysfunctional behavior. Dysfunctional and functional behavior is a matter of degree, not of kind. Maladaptive, abnormal, or dysfunctional in this sense represent complex learning, most likely attributable to deficit or inappropriate environmental contingencies. Abnormality is more than constellations of symptoms as outlined in the *Diagnostic and Statistical Manual of Mental Disorders, 4th ed.*; abnormality reflects, at the core, learning processes that are either excessive or deficit, and otherwise interfere with a person’s ability to live a full and valued life. This view of abnormal behavior has survived more or less intact and leads directly to behavior change efforts that attempt to modify deficit and inappropriate environmental contingencies that maintain and promote problems in living. The assumption that abnormal behavior is learned, and constrained somewhat by biological factors, translates into a humanistic view whereby the environment, not the person suffering, is largely at fault. The pragmatic leanings of behavior therapists further constrain the analysis to the present context in which the variables controlling problematic behavior can be identified and influenced directly, including factors controlling clients’ tendency to respond to their own responses (i.e., past memories, physical symptoms, other thoughts, or their own behaviors). This conception is also optimistic in the sense that if one learned to behave in a given way, then one can also learn to behave differently, and hence live a different life posttherapy. Therapy, therefore, is viewed as a means to construct and teach more adaptive repertoires and to deconstruct problematic behavior–environment relations that contribute to ongoing suffering.

III. THE SCIENCE AND PRACTICE OF CONCEPTUALLY DRIVEN BEHAVIOR THERAPY

Behavior therapy is both a science of behavior and a conceptually driven scientific approach to therapy and treatment development. Here the emphasis is on the word *approach*. As an approach, behavior therapy entails the values and ideals of the scientist–practitioner model, but is not synonymous with it. Though all behavior ther-

apists are, by definition, scientist–practitioners, not all scientist–practitioners are behavior therapists. Though behavior therapists tend to value rigorous empirical standards of proof and experimental methods, such features could just as easily be used by those favoring psychoanalysis, Gestalt, or humanistic approaches to therapy. Practicing in accordance with such values does not, therefore, make a psychoanalyst a behavior therapist, and use of behavioral interventions, say by a Gestalt psychologist in treating a phobia, would not necessarily mean that the Gestalt therapist is really a behavior therapist in disguise. Saying that behavior therapy draws on psychological science or social psychology for inspiration, or that it involves environmental change and social interaction, fails to disqualify just about all other data-based forms of psychotherapy that are increasingly becoming mandatory in managed behavioral health care. Thus, something more than an empirically or experimentally minded approach is needed to establish the unique identity of behavior therapy. The critical question here is what do behavior therapists do that justifies calling themselves “behavior therapists” as opposed to “psychotherapists” or simply “scientist–practitioners?” As is outlined, the main distinguishing feature is not in what behavior therapists do in research or practice, but with how they talk about what they do.

A. Behavior Therapy: True to Its Conceptual Roots

Behavior therapy is, at the core, rooted in the belief that behaviorism, and the basic branches of behavioristic science, can and do provide a coherent set of assumptions and precise sets of laws, facts, and principles with enough scope, or at least the potential for scope, to help understand and alleviate a wide range of problematic behavior and suffering. This view, of course, was characteristic of early behavior therapy, in which the pioneers set their sights on scientific understanding with at least one eye on practical utility. Initially, behavior therapists conceived of themselves as behavioral scientists investigating and applying basic learning principles to change human behavior. Those involved in treatment viewed their work as derived from basic laboratory research and behavior theory, and basic researchers saw important applied applications of their work. Behavior therapists spoke the same language as basic researchers (though not necessarily with their clients), much as physicians use a consistent set of terms derived from biology and medical science. They used the same set of terms and concepts not for dogmatic reasons, but

because it made sense to do so. Imagine that an engineer, when faced with the new challenge of designing a bridge, threw up his hands and said that “the laws of physics simply do not apply to this project,” or worse yet went about designing the bridge without regard for the new and known laws of physics. Most would say that such behavior would be foolish, and practically speaking would disconnect this engineer’s work from valuable and important knowledge derived from the science of physics. Behavior therapists go about their work in a similar fashion and interpret complex human phenomena (e.g., cognition, emotion) in a language consistent with the basic science. Such interpretations are central to initial assessment and ongoing assessment, hypothesis generation, and case formulation, selection of treatment targets, and ultimately what behavior therapists do next in attempting to ameliorate the problem(s) that a client(s) may present in therapy. Integration of the basic and applied branches of behavioral science is and remains characteristic of this work: a coherent, but far from uniform, formula that paved the way for many, if not most, of the available treatment technologies used by behavior therapists today.

At present, there is no indication that behavior therapy “true to its roots” has failed. What has happened, however, is that many behavior therapists have failed to see the conceptual richness of behaviorism and the promise of what behavioral science has to offer. For example, many behavior therapists, including nonbehavioral practitioners, would likely be surprised to learn that behavior analysts are increasingly addressing complex human phenomena such as the self, knowing, meaning, purpose, cognition, attention, emotion, verbal-regulatory processes involved in psychopathology, attributions, expectancies, and topics familiar to clinical psychologists such as transference and countertransference, resistance, suicide, anxiety, depression, and the most vexing clinical question as to how the talk that goes on between therapist and client in psychotherapy leads to clinically meaningful change outside of therapy (where it really counts). These and other developments, including new psychosocial treatment innovations for adults (e.g., functional analytic psychotherapy, acceptance and commitment therapy), have occurred because behavior therapists and clinical behavior analysts have extended new and known facts of learning systematically to address clinically important phenomena. That is, over the last two decades behavior analysts have pushed the limits of behaviorism and behavioral science and have developed a rich, coherent behavioral psychology of cognition and other

complex human phenomena and without the need for a cognitive or “other” brand of psychology. When behavior therapists think and act behaviorally, whether in laboratory, clinic, schools, organizations, they are behaving consistently with the controversial and oft misapplied Kuhnian concept of a paradigm—a disciplinary structure organized by a coherent set of basic assumptions, analogies used to clarify the basic assumptions, conventions (i.e., epistemology, methods, units of analysis), exemplars of classic works, and terminology to facilitate communication amongst its members.

B. Behavior Therapy: The Received View

According to received view, behavior therapy was never all that behavioristic to begin with, that behaviorism and behavior theory were too narrow as a basis for the conceptual development of behavior therapy, and that learning principles could only take behavior therapy so far. What was offered instead was a behavior therapy stripped of its behavioristic core: a behavior therapy that welcomed all of psychological science, and increasingly behavioral neuroscience, into its fold. The reasoning behind this move is unclear but can probably be traced to the presumed limits and failures of the behavioral paradigm and other social developments occurring during the 1960s. Whether the limits and failures were truly that, or simply reflected a lack of familiarity with behaviorism, is another matter for which we have no definitive answer. Yet, the outgrowth of the move away from a behavioral core is quite clear—many so-called behavior therapists have no unique identity and behavior therapy is but one of several growing branches of empirical science that aims to understand variables that, either in whole or in part, contribute to the etiology, maintenance, and treatment of psychological suffering. The prevailing view is that complex human behavior problems require complex solutions, many of which are outside the limits of behaviorism. The practice of behavior therapy has come to mean using the broad base of psychological science to understand and alleviate human suffering. Thus, drawing on the diverse array of psychological science for potential conceptual, empirical, and methodological solutions makes perfect sense: that is, so long as one believes that through pluralism and breadth comes clarity.

Though it is quite clear that behavior therapy has been an enormously successful experiment, it is not entirely clear that the perpetuation of increasing conceptual pluralism is responsible, let alone beneficial. The pace of novel treatment approaches, particularly those we know

not only that they work but also why they work, has slowed considerably since the late 1960s. The trend over the last decade has been to import behavioral interventions shown to be effective for one problem and to test for the efficacy for different problems, either alone or in combination with other interventions. The problem with technique-oriented interventions is that they fail to capture what is unique about behavior therapy: its methodology, its functional analytic approach, its theory, its scientific core, and its behaviorism. Behavior therapists have been retreating from their behavioral core since the early 1970s and have suffered a great deal of identity confusion as a result. In 1976, Goldfried and Davison defined behavior therapy essentially as “applied experimental psychology.” Soon, the application of any research in psychology was incorporated into the definition, and behavior therapists tended to identify themselves with scientific rigor first and foremost, and only secondarily (if at all) with developing behavior therapy as a conceptually coherent scientific paradigm. Though the behavioral core is still very much part of behavior therapy, it has been compartmentalized as relevant for specific kinds of questions, problematic behaviors, and interventions, particularly those with clear origins in a psychology of learning. This is not what the founders of the behavior therapy movement had intended behavior therapy to become: a point underscored repeatedly by Cyril Franks, and the late Joseph Wolpe, Hans Eysenck, and B. F. Skinner.

IV. SUMMARY

Though psychoanalysis was the dominant force in the first and much of the second half of the 19th century, behavior therapy appears to be poised to be the dominant player in the 21st century. Ironically, many predicted that behavior therapy would, in effect, wither away and die by the end of the 1970s. This, of course, did not happen. Behavior therapy remains a vibrant and increasing popular approach to understanding and alleviating human suffering: an approach that shares the values espoused by managed behavioral health care, namely treatment accountability, treatment quality, efficacy, time efficacy, and cost-effective care. Behavior therapy is strong, if not dominant, in academic and mental health settings in the United States, parts of Europe, and in countries such as Australia and New Zealand that never had a strong psychoanalytic tradition. If anything has died, it is this: behavior therapy’s unique conceptual identity in behaviorism and behavioral thinking.

Behaviorism has been a reference point for ideological debates in psychology since the early part of the 20th

century, and behavior therapy has taken more than a few blows on the chin for its behaviorism. Behaviorism initially emerged as a reaction against psychology’s preoccupation with consciousness and introspectionism. Behavior therapy emerged in the 1950s as a reaction against the applied incarnation of a psychology of consciousness—naming Freudian psychoanalysis and its cousins (e.g., Gestalt and Rogerian psychotherapy). This reaction was not merely empirical or experimental, it was conceptually driven, it was behavioral, it was behaviorism and behavioral science in action. Behaviorism has been on the retreat within behavior therapy since the rebellious 1960s. In its place, behavior therapists embraced cognitivism and bio-psycho-social conceptualizations. This so-called cognitive revolution was seen as an advance, for it once more legitimized speculation about consciousness and theories derived from clinical intuition and commonsense about consciousness and events occurring within the skin. Under the banner of empiricism, behavior therapy welcomed all of psychological science under its roof, and soon a new conceptual system—a cognitive system—supplanted behaviorism, and talk of behavior was relegated once more to a place outside the skin where it could be observed directly. This cognitive revolution was, in many respects, a conceptual 180-degree *revolution of the wheel* back to a level of inference, albeit highly sophisticated and data driven, that behaviorism reacted so vehemently against early on. A similar 180-degree spin occurred when behavioral thinking was relegated once again to observable behaviors. It is only recently that behavior therapists have come to terms with the view that empiricism is one part of science: a part that behavior therapy can no longer claim as its own. The other part, so often ignored in the equation, is the recognition that science and practice are fundamental human activities: activities that are influenced, to a great extent, by values. Even other so-called hard sciences are increasingly recognizing that science is inherently value laden, not value free.

A sense that behavior therapy entails a coherent set of values and conceptual assumptions has been lost for some time, leaving many behavior therapists with an increasing sense of identity confusion. Indeed, there is something intellectually dissatisfying about identifying one’s professional identity with research falling under a diagnostic label, promotion of a particular assessment device, one of several microtheories or models of psychopathology, or a new or existing treatment technology for a particular psychiatric disorder. By contrast, conceptually grounded science and practice have a certain richness about them that transcends the fads and fancies of a particular era. For these and other reasons

the wheel seems to be shifting back to an interest in behaviorism, particularly the value of a coherent conceptual identity within behavior therapy.

Some behavior therapists will no doubt disagree with grounding behavior therapy in behaviorism, behavioral talk, and the like; however, there is good reason to do so. Behaviorism is a philosophy and an ideology, a way of framing questions of scientific and practical importance. Behaviorism is not, by definition, dogmatic, nor does behavior thinking entail that one should reject by fiat all other nonbehavioral approaches to psychological science. Rather, it is the behavior of some scientists that may have made behaviorism appear that way. Behaviorism has always entailed an openness to a behavioral scientific analysis of the phenomena studied within the purview of other branches of science. A science of behavior is, at the core, an attempt to develop more effective ways of talking about human behavior and its alleviation. Behaviorism is, in many respects, a looking glass that undoubtedly influences the questions one asks, the methods one adopts, how one sees the world, the criteria one adopts for truth and explanation, how one talks about their research and applied work, and ultimately what one does as a result. This behavioral looking glass is difficult to master for it runs counter to how all of us have been socialized to talk about and explain our actions and the actions of others.

The payoff for coming to terms with behaviorism and behavioral thinking would likely be improved coherence and clarity, particularly with respect to the connectedness between the basic and applied branches of behavioral science, and ultimately a renewed sense of behavior therapy's unique identity. This is the promise of conceptually driven behavior therapy. Yet, for this promise to be realized again, behavior therapy must first resolve long-standing issues related to misunderstanding and misapplication of behaviorism and behavioral principles in clinical contexts, lack of integration and systematic extension of the concepts and findings from basic behavioral science to applied arenas with humans, including limited training in behavior theory, philosophy of science, and lack of fluency with unique technical jargon emanating from a science of behavior more generally. At present, behavior therapy is at a point of fracture over its psychological roots, its philosophy, its behaviorism, and its relation to basic behavioral science. Without a behavioral core, behavior therapy has no unique identity, and the name behavior therapist might as well be replaced with the generic term scientist-practitioner.

The immediate pragmatic question is why should behavior therapists ground themselves in behaviorism, behavior theory, and behavioral data language? Does such grounding matter in what behavior therapists do? Does behavioral thinking make a behavior therapist more effective in working with clients? Is behaviorism and behavioral thinking outdated and narrow? Such issues cut to the core of a deeper question concerning the very definition of behavior therapy itself: is it defined by its philosophical and theoretical underpinnings?; by the techniques that are typically used?; or by the attention it pays to empirical validation? The history of behavior therapy has been full of diverse opinions regarding where the *heart* of behavior therapy lies. Answers to questions such as these are no doubt complex; however, our view is that consistent and thoroughgoing behavioral thinking is not narrow, certainly not simple or outdated, and would be of value in helping behavior therapy reestablish its identity but also its historic affinity with the basic branches of behavioral science. Ironically, it was the synthesis of such domains that paved the way for behavior therapy's early successes and unique identity.

See Also the Following Articles

Beck Therapy Approach ■ Behavioral Consultation and Therapy ■ Behavioral Group Therapy ■ Behavioral Therapy Instructions ■ Behavior Therapy: Theoretical Bases ■ Cognitive Behavior Therapy ■ Education: Curriculum for Psychotherapy ■ Gestalt Therapy ■ Humanistic Psychotherapy ■ Multimodal Behavior Therapy ■ Psychoanalytic Psychotherapy and Psychoanalysis

Further Reading

- Eysenck, H. J., & Martin, I. (Eds.). (1987). *Theoretical foundations of behavior therapy*. New York: Plenum.
- Hayes, S. C., Hayes, L. J., Reese, H., & Sarbon, T. R. (Eds.). (1993). *Varieties of scientific contextualism*. Reno, NV: Context Press.
- Nelson, R. O., & Hayes, S. C. (Eds.). (1986). *Conceptual foundations of behavioral assessment*. New York: Guilford.
- O'Donohue, W., & Kitchener, R. (Eds.). (1999). *Handbook of behaviorism*. New York: Academic Press.
- Plaud, J. J., & Eifert, G. H. (Eds.). (1998). *From behavior theory to behavior therapy*. Boston, MA: Allyn & Bacon.
- Skinner, B. F. (1957). *Verbal behavior*. New York: Appleton-Century-Crofts.
- Wolpe, J. J. (1958). *Psychotherapy by reciprocal inhibition*. Stanford, CA: Stanford University Press.
- Zuriff, G. E. (1985). *Behaviorism: A conceptual reconstruction*. New York: Columbia University Press.

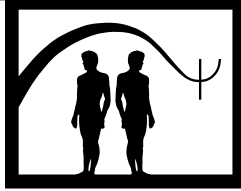

Behavior Therapy: Theoretical Bases

Dean McKay and Warren W. Tryon

Fordham University

- I. Overview
 - II. Theoretical Bases
 - III. Empirically Based Applications
 - IV. Summary
- Further Reading

neural network Any model used to describe the neural connections that give rise to cognitive and behavioral events.

self-efficacy A cognitive structure that is associated with the perception of personal influence on the environment.

treatment manual An algorithm for administering treatment for a specified problem or problems. Usually a collection of therapeutic techniques arranged in a sequence.

GLOSSARY

behavioral assessment A systematic examination of precursors and consequences of behavior, including self-reported cognitions and psychophysiological evaluations.

behavior modification A set of procedures designed to influence behavioral change based on principles from experimental psychology.

behavior therapy The application of behavioral and cognitive interventions to alleviate emotional and behavioral disturbance.

cognitive therapy An eclectic set of approaches aimed at altering patterns of thinking and perceiving environmental and internal events to achieve behavioral and emotional change.

empirically supported treatment Any treatment or collection of techniques that has been shown effective for a specified target behavior or diagnosis. Treatment is deemed empirically supported following a predetermined number of independent investigations that demonstrate clinically significant change.

functional analysis A structured method of determining the maintaining features of any behavior. This approach involves determining antecedent events, target behavior, organismic variables, and consequences of behavior in a causal sequence.

I. OVERVIEW

Behavior therapy has become a well-developed and integrated part of mental health treatment. As a set of procedures, and as a movement within psychology, behavior therapy has undergone significant changes, not only in form but also in how practitioners view it. The purpose of this article is to provide a comprehensive understanding of the field within the limits of space constraints. Behavior therapy can be described in terms of its theoretical underpinnings and their development from inception to the present time. A summary of these events constitutes the first portion of this article. Behavior therapy can also be described in terms of its clinical approach to treating a wide spectrum of behavioral and psychological disorders. A summary of these events constitutes the second portion of this article. We seek to explicitly discuss how behavior therapy has always been defined in the spirit of manual-based treatment in that treatments must be sufficiently well described to be replicated if empirical support is to be obtained. Operationalization of intervention steps is a hallmark of behavior therapy.

II. THEORETICAL BASES

A. Definitions of Behavior Modification and Therapy

Kazdin has written the most comprehensive and authoritative history of behavior modification and behavior therapy currently available. The terms behavior therapy and behavior modification denoted differences that were perhaps once more vigorously defended than they are today. Kazdin's preface states "Behavior modification can be defined as the application of basic research and theory from experimental psychology to influence behavior for purposes of resolving personal and social problems and enhancing human functioning." This definition is theoretically inclusive as it defines behavior modification in terms of applied experimental psychology, which today encompasses cognitive psychology and cognitive neuroscience as well as operant and respondent conditioning. This definition of behavior modification is consistent with the practice of contemporary cognitive behavior therapy and therefore could be used to define both behavior modification and behavior therapy making them one and the same thing. This would erase the historical distinction between them. Behavior modification was predominantly guided by B. F. Skinner's experimental analysis of behavior, which emphasizes environment-behavior relationships. Contingencies are typically imposed on individuals and/or groups. Notable exceptions entail the use of reinforcer surveys—menus to allow individuals to select what they will work for and behavioral contracting that actively engages the client in negotiations with those who control access to reinforcers. Clinical applications tend to be in schools and institutions with children or adolescents who are developmentally delayed, delinquent, or severely mentally ill.

Behavior therapy is currently viewed as the application of cognitive-behavioral techniques to adults and children on a primarily one-to-one basis, though sometimes in groups, in both inpatient and outpatient settings. behavior therapy has been defined in several ways. Eysenck asserted that behavior therapy may be defined as the attempt to alter human behaviour and emotion in a beneficial manner according to the laws of modern learning theory Wolpe and Lazarus similarly defined behavior therapy as the application of experimentally established principles of learning. Wolpe defined behavior therapy as the use of experimentally established principles of learning for the purpose of changing unadaptive behavior. Attempts to define behavior therapy in terms of learning theory failed primarily because no single learning theory commanded

sufficient consensus. Tryon observed that clinical and experimental psychology are predicated on learning. Many facets of normal and abnormal behavioral and psychological development depend on learning. Virtually all psychological interventions by clinical and experimental psychologists, including behavior modification and therapy, presume that some new learning will occur. Developmental theories and schools of psychological interventions differ mainly in how they account for learning. Psychotherapies differ mainly in terms of what they feel clients need to learn and they best learn what they need to know. Therapies by Beck and Ellis discussed later illustrate this point. Hence, learning is at the heart of the "basic research and theory from experimental psychology" that Kazdin used to define behavior modification and that Eysenck, Wolpe, and Lazarus used to define behavior therapy. Therefore, behavior therapy and behavior modification were often used interchangeably in the early history of this approach to treatment. Tryon recommended that we recognize our common dependence on learning, which implies memory, and directly discuss our differences in how learning and memory explains behavioral and psychological disorder as well as how new learning can cause therapeutic change.

Covert conditioning constitutes a hybrid approach. Homme introduced the term *coverant* to mean "operant of the mind." Covert reinforcement, covert extinction, covert modeling, and covert sensitization soon followed. These are operant behavior modification procedures in which the behavior, antecedent stimuli, and consequent reinforcers are all imaginal and therefore purely cognitive. Martin and Peal allocated an entire chapter to this operant interpretation of cognitive behavior modification.

Finally, we note that practitioners who endorse applied behavior analysis (ABA) are primarily persuaded by Skinner's experimental analysis of behavior and therefore focus heavily on behavior-environment relationships. This has recently changed to include private events, such as the treatment protocol developed by Hayes (acceptance and commitment therapy [ACT]). The term behavior modification has primarily been used to refer to their clinical efforts. Because reinforcement contingencies can be imposed on groups of people, behavior modification has also come to connote group interventions in institutions such as hospitals, residential placements, and schools. Because systematic desensitization and related interventions are primarily provided in outpatient settings, behavior therapy has also come to refer to individual treatment. It should be noted that customized contingency management interventions are designed and implemented

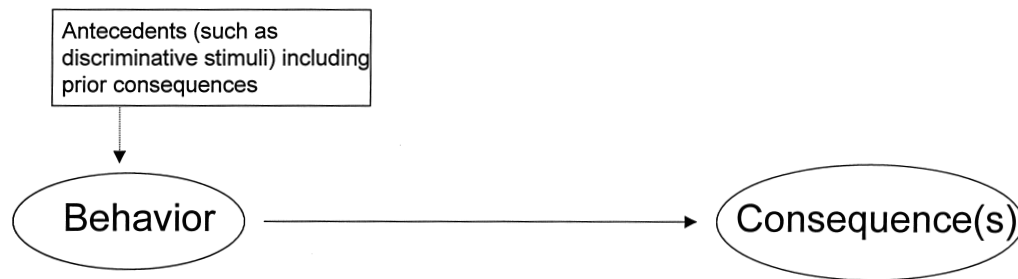

FIGURE 1 Original behavioral links to environment. This figure depicts the original conceptualization of how behavior is driven by environmental consequences.

with regard to individuals in outpatient settings. This frequently entails assisting parents modify behavioral excesses or deficits displayed by their children.

B. History of Behavioral Theory

Kazdin traces the history of the theoretical foundations of behavior modification from Sechenov (1829–1905), through Pavlov (1849–1936), Bechterev (1857–1927), Watson (1878–1958), Thorndike (1874–1949), Guthrie (1886–1959), Tolman (1896–1961), Hull (1884–1952), Mowrer (1907–1982), to Skinner (1904–1990). Kazdin devotes all of Chapter 4 to Skinner, Chapter 7 to the “emergence and evolution of applied behavior analysis,” and Chapter 8 to “contemporary applied behavior analysis.” Kazdin’s Chapter 5 traces the clinical applications of work on experimental neuroses and conditioning to human behavior. Wolpe’s work on systematic desensitization beginning in South Africa and efforts by Eysenck and others in the Maudsley Group in England are chronicled. Work in the United States is also covered. Kazdin’s Chapter 9 reviews “cognitive behavior modification and self-control” before considering “ethical and legal issues” in Chapter 10. The details of these events have been omitted because they are extensive and not easily summarized except to say that the history of behavior modification therapy entails the clinical application of empirically supported methods and principles of behavior change. The primary attraction of operant and respondent conditioning by clinicians has always been that conditioning provided prescriptions for behavior change because clinicians are primarily called on to change behavior. Behavioral therapies differ from psychotherapy in general because they identify specific behaviors for change and use empirically supported treatment principles and packages to obtain these changes.

C. Behavioral Theory

Kazdin defined behavior modification therapy to include the entire theoretical basis of experimental psychology as noted earlier. Learning theories by Thorndike, Skinner, Hull, Guthrie, Estes, Tolman, and Hebb were available. However, conditioning was the primary theoretical basis for studying learning as can be seen by Kimble’s influential revision of Hilgard and Marquis’ *Conditioning and Learning*. In 1970 Kanfer and Phillip’s *Learning Foundations of Behavior Therapy* formulated a behavioral approach to clinical psychology in terms of operant conditioning. Plaud and Eifert’s book, *From Behavior Theory to Behavior Therapy*, maintains this theoretical orientation. Figure 1 presents the theoretical premise of conditioning theory. Pavlovian respondent conditioning, also known as classical conditioning, is a S–R theory in which conditional stimuli come to elicit responses similar to the responses elicited by unconditional stimuli. Skinner carefully distinguished his approach as a R–S theory in which consequent stimuli reinforced preceding behaviors. Skinner explained behavior in terms of variation and selection using the same functional argument Darwin employed to explain the origin and extinction of species. However, for present purposes it is important to emphasize that only stimuli and consequences residing in the external environment were admissible explanatory candidates in all conditioning models.

D. Operant Conditioning to Psychological Behaviorism

Behaviorism was just reviewed as a single theoretical system. Staats identified three generations of behaviorism. He ascribed the first generation of behaviorism to John B. Watson and his studies on conditioned emotional reactions. Staats associates Skinner, Hull Mac-

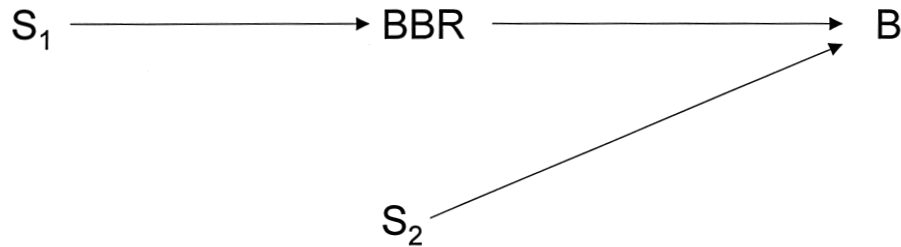

FIGURE 2 Psychological behaviorism. S_1 represents the original learning environment; BBR represents basic behavioral repertoires; S_2 represents the current environmental situation; B represents the behavior (including experience) and resulting learning that takes place. Adapted with permission of A.W. Staats.

Corquodale and Meehl, Spence, and Tolman with behaviorism's second generation. Staats identifies himself with behaviorism's third generation.

Staats has offered a perspective on behavioral assessment and treatment that is based on a unification of basic behavioral principles and general psychology. Unlike his predecessors, his emphasis has been on linking behaviorism with the rest of the field rather than establishing behaviorism as a separate discipline. He has called for "complementarity—not opposition." Staats outlines 11 "levels" of psychological behaviorism, essentially capturing the major experimental and applied areas of psychology. These are biological mechanisms of learning, basic learning theory, human learning principles, personality, child development, social personality, measurement, abnormal psychology, clinical psychology, educational psychology, and organizational psychology. Although not explicitly cited, efforts aimed at incorporating basic psychological science findings into behavior therapy have been undertaken in the same spirit espoused by Staats by Onken and Blaine and by Onken and Bootzin.

In determining how to best analyze human behavior and develop empirically sound interventions, Staats and associates present a diagrammatic approach to developing a functional analysis. A key component of this arrangement is the set of basic behavioral repertoires (BBR) that one develops during a lifetime and brings to treatment. The verbal-motor repertoire entails the ability to understand language and use it to regulate behavior. The verbal-image repertoire entails the ability of language to elicit a conditioned sensory response. The verbal-emotional repertoire entails the ability of language to elicit emotions. The verbal-labeling repertoire entails the person to respond verbally to external stimuli. The verbal-association repertoire entails communication, problem solving, and mathematics. The verbal-imitation repertoire entails language to govern

behavior. The verbal-writing repertoire entails language and written expression. The sensory-motor repertoire entails stimuli with action. The emotional-motivational repertoire entails affect and those factors that drive behavior. Standard psychological tests, such as IQ tests, are viewed as standardized behavioral samples. Performance on these tests quantifies specific BBRs. Hence, Staats has addressed what are usually characterized as cognitive phenomena by extending behavioral theory (see Figure 2).

According to Staats, treatment proceeds best when this illustration of initial learning situation, basic behavioral repertoires (or personality), and current contingencies operate in a continuous feedback loop. That is, intervention alters current contingencies, resulting in environmental changes, which in turn influence the BBR. In this way, assessment and treatment are inexorably linked. This approach is consistent with the original vision of behavior therapists but offers a perspective that embraces the full breadth of psychology.

Although Staats initially termed his approach paradigmatic behaviorism, Tryon maintained that his efforts were more accurately termed psychological behaviorism, and that became the title of subsequent article and the subtitle of his most recent book. Staats uses the term unified positivism to describe this approach. He endorses the general values of science including observation, measurement, and experimentation and endorses general theory construction values of empirical definition, consistency, generalizability, and parsimony but is open to and actively encourages the use of psychological constructs.

E. The Cognitive Revolution

Following a period of extensive research on basic behavioral processes, and how various forms of psychopathology may be acquired through environmental

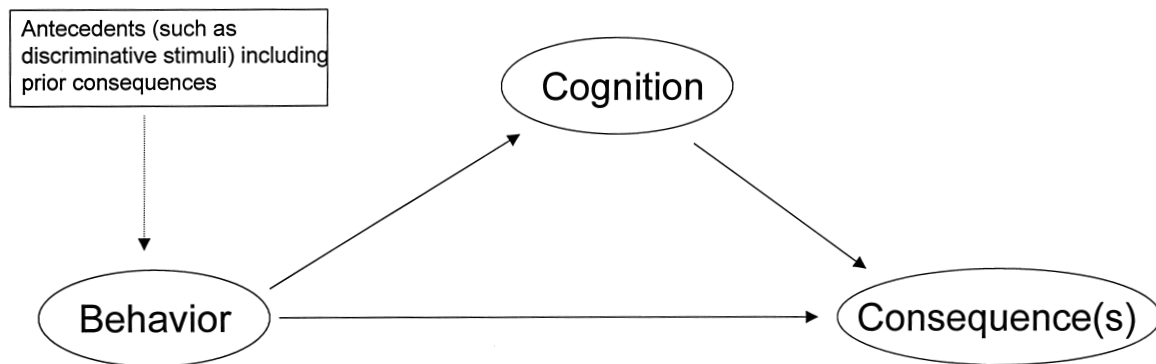

FIGURE 3 Modified behavioral theory. In this revised view of behavior–environment relations, cognitions are considered a mediator between behavior and consequences.

circumstances (learning), many investigators became dissatisfied with conditioning theory. Increasingly, behavior therapists were persuaded that the information proffered from clients' self-report was itself an appropriate area of study and that this information might form the basis of functional assessment and intervention. That is, the way clients *think* was offered as a causative factor in behavioral and emotional problems. Heralded as a more comprehensive view of individual clients, this adjustment was intended to augment current behavioral models by accounting for cognitive styles that are introduced into clinical settings and set the occasion for the development and/or maintenance of most forms of psychopathology. This was the basis for the cognitive revolution that took hold of behavior therapy and continues to exert considerable influence today. Figure 3 depicts this modification of behavioral theory.

Prior to the more formal integration into behavior therapy that cognitive interventions enjoy today, groundwork was laid that would allow for the merging of these approaches. Notable in this regard was the work of Cautela involving coverants and covert conditioning mentioned earlier. Although originally placed in the same company as other traditional behavioral interventions (such as operant and classical conditioning), it should be noted that each element of intervention was a cognitive construction, including reinforcers, consequences, and behavior (i.e., images of behavioral events). Coverant control continues to be viewed as a behavioral rather than a cognitive treatment despite the fact that the events, antecedent stimuli, and reinforcing consequences are entirely imaginal and therefore cognitive.

It is interesting that the mainstream cognitive revolution was initiated by clinicians who were neither behavioral by training, nor experimental psychologists by

trade. Beck's cognitive therapy and Ellis's rational emotive behavior therapy each offered approaches to treatment that were essentially client centered, Socratic in method, and reliant on client self-report augured by client self-observation and verbal challenge of identified dysfunctional beliefs. These clinicians assert that the impetus for developing their approaches to treatment was as a reaction to their more traditional training in psychodynamic approaches, whereby they observed that clients spontaneously report a variety of negative thoughts that give rise to neurotic conditions. In contrast to their traditional training, each felt compelled not only by this observation, but by clinical experience that teaching clients methods for directly addressing these spontaneously reported thoughts resulted in the alleviation of emotional distress and behavior disturbance. Both approaches have been popularized and integrated into contemporary behavior therapy. Indeed, this integration appears so complete that most refer to this treatment approach as cognitive-behavioral therapy (CBT) rather than behavior therapy (BT).

1. Beck's Cognitive Therapy

Beck suggests that emotional distress is predicated upon negative automatic thoughts (NATs), which emerge from schemas. Schemas are defined as structures that organize information in a database-like form that sorts and summons information based on stimuli (either overt events or other verbalizations). In 1978 Beck and colleagues articulated this notion most prominently in the application of cognitive therapy for depression. Specifically, depressed individuals are said to possess a "negative triad" of automatic thoughts that cause negative views of the self, world, and future. Each of these domains has been characterized as a schema that is essentially negative in depressed individ-

TABLE 1
Self-monitoring Form for Client Use in Cognitive Therapy (Sample Form)

Date	Situation	Emotions	Automatic thoughts	Rational response	Outcome

uals. The principle task in cognitive therapy (CT) is to help clients systematically determine ways of challenging these thoughts, usually by evidence gathering and self-monitoring. Since the time that Beck and his colleagues described this method for treating depression, it has been extended to anxiety disorders, substance abuse, personality disorders, obsessive–compulsive disorder, eating disorders, and delusions. Beck’s approach has shown a great deal of promise in alleviating emotional distress, as well as shedding light on the interaction between therapy and medication. Specifically, it has been shown in numerous trials that cognitive therapy alone is at least as effective as antidepressant medication for depression, while also showing greater maintenance of gains following medication discontinuation. This has since become an important experimental design for use in determining the relative contribution of CBT and medication for a number of other psychological conditions such as panic disorder, obsessive–compulsive disorder, alcohol abuse, and eating disorders.

Cognitive therapy, using the approach described by Beck, involves teaching clients to become their own scientist. For example, clients are engaged in a Socratic discussion whereby the negative automatic thoughts are actively challenged. Clients are taught to identify NATs by maintaining a daily log that is structured along dimensions of situation(s), emotional response to that situation, automatic thoughts, rational response, and outcome. A sample form for client use is presented in Table 1.

The components of the strategy of monitoring events and the NATs that give rise to emotional distress are highly structured in CT. Clients are taught to identify specific situations (or imagery that occur in daydreams) that result in distressing emotional reactions. Clients are instructed in the identification of these NATs and then taught how to challenge these ideas using specific questioning of the accuracy of these ideas. They are then asked to write a rational alternative thought and the outcome from applying this alternate thought. Throughout, as a means of examining the effectiveness of the challenge, clients are also instructed to rate the degree to which they experience the emotion, as well as degree they believe both the NAT and rational alternative. Implicit in this approach is the perspective that one will not initially believe the rational alternative, but with repeated practice the underlying philosophy of the rational alternatives will begin to take hold.

In order to be effective, and for the integration of the rational alternatives to replace the NATs, Beck argues that clients must engage in personal experiments that are designed to directly challenge the accuracy of these dysfunctional thoughts. After conducting several of these experiments, practitioners applying CT seek to identify “themes” (schemas) that guide these automatic thoughts. It is at this point that the cognitive therapist begins to actively challenge the underlying theme, instruct clients to seek situations that broadly address these themes, and continue monitoring automatic thoughts as a means of identifying

other possible automatic thoughts that may arise as treatment continues. Broadly speaking, this process has been referred to as cognitive restructuring.

2. Ellis's Rational Emotive Behavior Therapy (REBT)

Ellis has described a variant of CT that is conversant with traditional operant behaviorism in that clients are taught to develop a functional analysis of their own upset emotional experience. Specifically, in the early stages of treatment, clients are instructed to identify (a)ctivating events, (b)eliefs, and (c)onsequences that surround individual events resulting in distress. After repeated practice and feedback from the therapist, clients are expected to articulate these sequences readily. Following this, clients are taught to extend this A-B-C analysis to include (D)isputation and (E)ffects of the outcome. This full sequence is then understood as a method of alleviating distress when applied repeatedly. As a means for galvanizing these effects, a number of behavioral activities are typically arranged that allow for *in vivo* challenge of irrational beliefs. For example, shame attacks are where one seeks out a situation in which the irrational belief may be directly challenged (such as announcing the time in a crowded restaurant to challenge beliefs associated with embarrassment). Another method is referred to as the rational barb, where the therapist states the irrational belief out loud to the client, and the client must rapidly arrive at a disputation (such as comments about physical appearance). Finally, rational role reversal is where the therapist enacts the role of client, and the client must identify irrational beliefs and suggest methods for disputation. These procedures are described in detail in the work of Walen, DiGiuseppe, and Dryden.

3. Distinguishing CT from REBT

It appears from the description offered here that CT and REBT have substantial overlap in conceptualization. Both involve homework designed to identify dysfunctional thinking patterns. Each is highly structured. Each approach emphasizes demonstration of the effects of *in session* disputation by *in vivo* application. However, there are some subtle differences. The first is that REBT is more reliant on specific exercises that have been packaged for challenging irrational ideas as they arise. The second is that, despite the broad similarities, most treatment trials have adhered to the format outlined by Beck, resulting in greater empirical support. Indeed, Beck has placed greater emphasis on empirical research, while frankly acknowledging similarities with

Ellis's approach. Finally, REBT emphasizes identification of particular words and styles of describing the world that may result in emotional distress. For example, Ellis has popularized some catch phrases that are liberally applied to challenge the use of particular words to describe personal emotional functioning. Ellis has suggested that people "awful-ize" to refer to the use of something being awful (rather than merely unfortunate or inconvenient). Other words specifically targeted as part of treatment are "should," "ought," and "must." Further, Ellis has encouraged people to try applying the E-prime philosophy, which specifically suggests that people avoid using the verb "to be" as it contributes to broad labeling that fosters an inability to effectively and flexibly challenge disruptive thinking patterns. In 1973 Ellis emphasizes that REBT arises from the philosophical tenets of Epictetus whereby the labeling of something as "good" or "bad" is what makes it so, and that no event is inherently good or bad.

F. Cognitive Theory Elaborations That Affect Cognitive Therapies

Although CT and REBT may rightly claim a place as mainstream components of behavior therapy, the groundswell that resulted in the widespread acceptance of these approaches had been set in motion earlier, aside from the initial "behavioral" interventions described by Cautela. Notable here is self-efficacy theory by Bandura. Self-efficacy refers to a person's belief in the extent that their actions influence the environment in ways that are advantageous. These beliefs are said to causally contribute to behavior as well as emotional experience. This is also the central position of the cognitive therapies. This assertion has led to considerable debate within the field, and is not yet resolved. The procognitive side of the argument strongly suggests that observational learning rests on an assumption that even without direct contact with contingencies higher-order organisms learn, which implies cognition. Cognitive theorists have also suggested that radical behaviorists discount cognition despite references to "private events" and that cognition represents a plausible area of investigation within the broader domain of CBT. The behavioral position suggests that cognitions (all private events) are epi-phenomena representing a higher-order class of behavior. Further, in response to the concern over mere labeling, behaviorists have argued that cognitions exist as correlates of behavior. It has been said that the move to cognitive analyses has always been part of psychological assessment but it should not occur at the cost of traditional behavioral assessment. Cognitive

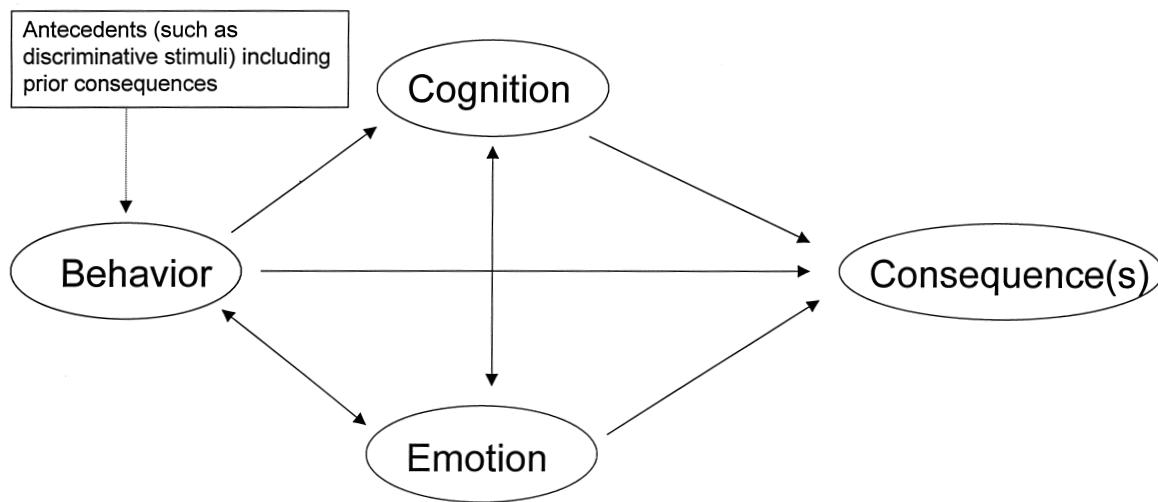

FIGURE 4 Modified behavioral theory.

variables are private events and therefore are essentially unknowable by an observer because of measurement problems. Although the controversy continues regarding whether cognition represents a causal link between behavior and consequences, researchers examining treatment components for specific disorders have embraced self-efficacy. For example, in 1985 Marlatt and Gordon outlined a cognitive-behavioral theory of treatment for substance use that has gained prominence. Since that time, self-efficacy has figured prominently in several variants of cognitive-behavioral therapy for smoking, obesity, depression, anxiety disorders, and marital distress.

G. Impact of Neuroscience

LeDoux summarizes many studies that demonstrate how conditioned emotional responses are formed through activation of subcortical structures. Although he personally rejects behaviorism, his work repeatedly demonstrates the crucial importance of classical conditioning to the etiology of emotional and behavioral disorder. In short, many studies conducted in his lab, and the laboratories of other investigators, clearly demonstrate that emotional responses are formed by subcortical brain structures that respond quicker than our higher cortical centers do. This is what makes negative automatic thoughts rapid and automatic. Emotional reactions derived from traumatic experiences are retained for long periods of time after a single or few learning trials. Fortunately, higher cortical centers enable some cognitive control over these reactions. These and related supportive findings enable us to expand Figure 3

into Figure 4. The line from cognition to emotion represents this influence.

Figure 4 also illustrates that therapeutic experience with the environment, corrective emotional experiences, can modify emotional reactions. Figure 4 indicates that these therapeutic experiences (behavior–environment) relationships have both cognitive and emotional consequences. The path connecting cognition and emotion bidirectional indicating that cognitions influence emotions and emotions influence cognitions. This means that corrective emotional experiences cause people to think and feel differently that also means that cognitive changes accompany behavioral interventions. The crux of cognitive theory is that cognitive processes actively transform experience with the environment.

It can be argued that all of the interconnections in Figure 4 are causally bidirectional. This theoretical extension produces a connectionist network among thoughts, feelings, behaviors, and environmental consequences. We next consider issues related to theoretical integration and how informal and formal network theories have contributed to theoretical unification.

H. Theoretical Integration

In an effort to provide a conciliatory note on this argument, Reitman and Drabman, and Dougher point out the similarities between radical cognitivists and radical behaviorists by indicating both are interested in achieving behavior change, with fundamental differences in method to achieving that change. On the one hand, it appears that the addition of “cognitive” to behavior

therapy has led to improvement in the delivery of treatment and may even enhance treatment adherence in some cases (as in obsessive-compulsive disorder). On the other hand, others have remarked that the retreat to cognitive methods has been either premature or insufficiently informed by theory from experimental cognitive psychology. Indeed, there has been a burgeoning literature in experimental psychopathology that has examined the role of attention and memory in various conditions but has not yet “inspired any treatments”.

McNally characterized this disparity as “potentially incompatible.” On the one hand, the treatment approaches described by Beck and Ellis represent introspective approaches whereby beliefs associated with various environmental events (assumed to be central to emotional distress) are culled from direct questioning. On the other hand, experimental cognitive approaches (hereafter referred to by the more popular term information processing) rely on inferences for cognitive processes based on participants’ performance on a number of laboratory tasks. These tasks do not typically involve direct questioning. McNally indicates that although the arguments levied on both sides of this debate have been intense, there is a common theme that emerges. Specifically, both approaches at some point must rely on client report. Information processing approaches routinely rely on self-report measures for determining placement in groups (i.e., depressed, nondepressed). Likewise, clinical “belief-based” approaches rely on inferences of change based on both client report and performance during specified therapeutic tasks.

If these approaches are to be comprehensive in scope, then each must answer the question of how psychopathology develops. Efforts have been made to articulate etiology so that treatment may be informed with greater clarity. We have identified two different perspectives on this matter. First, a radical cognitive perspective supports the idea that negative (and positive) thoughts arise through discrete learning opportunities. Therefore, one has opportunities to understand emotional reactions through a lens of either rational or irrational beliefs, and these beliefs are shaped by feedback from significant others or information provided by various sources. The second (and more popular) view involves the presence of dispositional traits that set up opportunities for developing these same maladaptive patterns of thinking. There are numerous examples of how preexisting traits may predict later psychopathology such as anxiety sensitivity and panic disorder and other anxiety conditions, sociotropy-autonomy and depression, or restraint eating and eating disorders. This is not a comprehensive list of

dispositional traits that have been tied to cognitive bias or the onset of discrete forms of psychopathology. By adopting the position that one may begin with a set of characteristics that lends itself to developing psychopathology by discrete learning consequences represents an attempt on the part of researchers to be truly integrative in understanding and describing psychopathology. This is a well-established tradition in behavior theory and therapy, as advocated previously by Lazarus and Staats, among others. The presence of dispositional traits may assist in identifying schemas, according to Beck’s CT, but this has rarely been specifically articulated (except in the case of anxiety sensitivity).

The emergence of network models may enable a resolution of these theoretical differences. We first examine the emergence of informal network theories and then consider formal parallel distributed processing connectionist neural network models.

1. Informal Network Models

Lang suggested that fear can be understood as a memory network containing information about stimulus characteristics, verbal and nonverbal response tendencies, mediating visceral and somatic events (feelings), and propositions about what all these events mean under different circumstances. Each source of information can be thought of as a node. The excitatory and inhibitory connections among these nodes constitute the theoretical network that governs behavior and the psychophysiological responses to scripts read by fearful persons in Lang’s research.

Foa and Kozak expanded Lang’s network theory to include the concept of “emotional processing”, which predicts a gradual reduction in emotional responding over time given persistent activation of the fear network. Short-term habituation effects are hypothesized to change the fear network thereby resulting in long-term fear reduction. New therapeutic memories form and interact with incompatible fearful memories. Creamer, Burgess, and Pattison discuss a similar form of “network resolution processing.” Fear networks are hypothesized to vary in size, structure (interconnectedness), and accessibility .

Chemtob, Roiblat, Hamada, Carlson, and Twentyman hypothesized a 4-level cognitive schema network varying from concrete representation at Level 1 to abstract representation at Level 4. One aspect of this network influences another through “spreading activation” thereby interrelating thoughts, feelings, and actions.

The above mentioned network theories are multidimensional and interactive. They are progressive in that

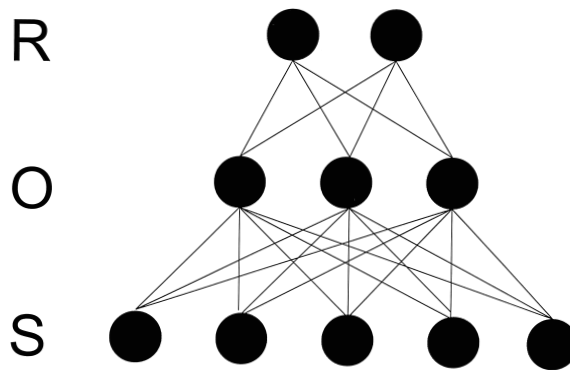

FIGURE 5 S-O-R model.

they provide for flexible and complex interactions among thoughts, feelings, and actions. However, they contain few constraints and cannot be used to deduce (calculate) specific outcomes due to the absence of principles that characterize and limit network dynamics. These systems are black box and arrow models because they indicate relationships among functions and do not provide mechanism information to show why these relationships exist.

2. Formal Connectionist Network Models

Parallel distributed processing (PDP) Connectionist neural network (CNN) models are sophisticated mathematical systems that generate quantitative results when computer simulated. They have all the theoretical applicability and flexibility of the informal network models, but they have the necessary structure and constraints to enable specific theoretical predictions to be made. Specific architectures and formal learning rules systematically modify connection weights between the processing nodes in response to experience.

The common 3 layer CNN has strong similarities to a higher-order factor structural equation model (SEM). Behavior therapists have long subscribed to a 3 layered Stimulus–Organism–Response (S–O–R) model. Figure 5 renders this traditional model in terms of a 3 layered feed-forward CNN model that is equivalent to a 2nd-order factor. The bottom layer of processing nodes, frequently termed neurons, represents stimulus inputs. They are the indicators in a SEM. The second CNN layer, also called the middle or hidden layer, is composed of fewer neurons; one for each latent construct the network will need to learn. These are the latent factors in a SEM. Every input neuron is typically connected to, synapses with, every middle neuron in a CNN whereas indicators are selectively loaded on factors in a SEM. These CNN connection weights are initially set to small random values. The network decides

for itself, as a result of training, which stimuli are relevant to each latent construct by making some synapses more positive and others more negative via a learning function. Connections to irrelevant stimuli decrease toward zero. Transformation is central to the cognitive model as mentioned earlier. The middle layer transforms stimulus inputs into fewer latent constructs. Hence, these network models are cognitive models that are constructed from associative networks. The third or output CNN layer represents behavioral responses. At least one output neuron is needed to represent the presence (on) or absence (off) a target response. Multiple neurons can be used to represent more complex behavioral repertoires. Figure 4 contains two response nodes. Every middle neuron connects with every output neuron. The response layer corresponds to a higher-order factor structure in a SEM where 2nd-order factors load on 1-order factors. The CNN determines for itself which combination of latent constructs, middle neurons, enables which responses by making some synapses between responses and latent constructs more positive (excitatory) and others more negative (inhibitory) via a learning function. Irrelevant connections between 1- and 2nd-order latent constructs, between middle and output (response) neurons, are modified until they approach zero. Behavioral responses are therefore understood in terms of 2nd-order factors. The 2nd-order factors transform the 1-order factors thereby introducing a second level of transformation. More complex PDP CNN models contain additional levels and therefore perform additional transformations on prior transformations. Complex and powerful cognitive models emerge from such architectures.

These connectionist S–O–R models have been characterized as neural network learning theory (NNLT) because these brainlike PDP–CNN structures develop their functionality through learning at every developmental

step; they are trained rather than programmed. Tryon used the bidirectional associative memory model to satisfy all four of Jones and Barlow's and all five of Brewin, Dalgleish, and Joseph's explanatory requirements for a comprehensive understanding of posttraumatic stress disorder. NNLT accounts for the nonassociative as well as associative etiologies of phobias. NNLT provides a comprehensive understanding of how systematic desensitization and exposure therapies work. NNLT provides an integrated theoretical basis for multimodal behavior therapy. NNLT provides the missing theoretical link between genetics and behavior in behavior genetic explanations. NNLT resolves the cognitive-behavioral debate, synthesizes findings from human and animal research and resolves several other long-standing schisms in psychology.

H. Behavioral Assessment and Functional Analyses

Given this discussion, much has changed in behavioral theory and its application over the past 30 years. The field has witnessed growth, delineations of theoretical perspectives, and widespread applications. Indeed, the rate of change within the behavioral perspective has been so rapid that earlier writers such as Mahoney, Kazdin, and Lesswing questioned whether behavior therapy was even behavioral. This argument stemmed from earlier rebellions against the applications of techniques that assume the functional utility of private consciousness. However, as Mahoney, Kazdin, and Lesswing point out, Skinner too considered private mental activity to be of utility in determining functional relations with behavior, although he contended these were beyond our ability to empirically support.

Since the earlier growth period within behavior theory and therapy, it has been generally agreed that behavior therapy encompasses both behavior theory and cognitive theory. Indeed, the masthead of the flagship journal (*Behavior Therapy*) of the Association for Advancement of Behavior Therapy recently included cognitive sciences as part of the description of the area of study appropriate for that particular scientific forum. The masthead of *Behavior Therapy* reads as follows: "*Behavior Therapy* is an international journal devoted to the application of behavioral and cognitive sciences to clinical problems. It primarily publishes original research of an experimental/clinical nature which contributes to the theories, practices, and evaluations of behavior therapy, broadly defines." Although this change in criteria for submissions to this journal is a recent modification, there have been inherent signs that cognition has been part of behavior therapy since its early years.

1. Behavioral Assessment

Behavioral assessment represents a significant aspect of conducting behavior therapy. In the briefest sense, behavioral assessment allows practitioners to identify patterns of responses (both behavioral and emotional) that accompany specific stimulus events. These can be responses that are tied directly to the presenting problem, or may be associated indirectly, plausibly related but unacknowledged by the client, or acknowledged only after treatment has begun.

As is true of other systems of assessment, behavioral assessment encompasses both reliability of measure and validity of the evaluation. Two additional features should be highlighted here. Specifically, reliability of measurement within individuals (e.g., consistency of response) as well as ecological validity (e.g., similarity to experience outside the office) is emphasized in behavioral assessment. Given these two additional features, there have been numerous rigorously tested behavioral assessment methods developed. Notably, many instruments used in behavioral assessment are self-report questionnaires. However, behavioral assessment also includes self-monitoring (for behaviors, as well as thoughts and emotions as described earlier).

A major area of assessment for the purposes of identifying topographic as well as functional aspects of psychopathology includes activity measurement, which can include direct observation or minimally intrusive monitoring by electronic devices. Further, methods of assessment for psychophysiological response (such as heart rate, eyeblink startle, etc.) has formed an important part of assessment in behavior therapy.

Given the emphasis on empirically supported approaches to treatment, these assessment procedures are useful in two major ways. First, in providing a baseline evaluation, clinical interventions can be tailored to both specific areas of response as well as to severity level. Second, because these approaches to assessment are intended to be objective, each assessment represents an opportunity to objectively evaluate treatment progress and outcome at the level of the individual case. This has become increasingly important for practitioners given the rise of managed care and the need to demonstrate treatment efficacy to third-party payers.

2. Functional Analyses

Behavioral assessment provides an important basis for determining response areas to focus on in therapy, as well as both baseline and benchmarks for evaluating treatment progress. However, in conjunction with behavioral assessment, it is important to establish when, and under what conditions, particular problem



FIGURE 6 Classical and operant conditioning.

behaviors arise. This assessment is typically referred to as a functional analysis.

Functional analysis has its roots in earlier experimental traditions in behavior modification (described earlier). Specifically, functional analyses examine stimulus events that give rise to responses, with organismic variables intervening (the S–O–R perspective; see Figure 5). However, many theoreticians have felt that the S–O–R model fails to account for consequences of behavior. Therefore, a more complete accounting of how behavior is reinforced (and maintained) is encompassed by the inclusion of consequences at the end of the sequence (hence, S–O–R–C). Each unit of behavior is then conceptualized in these terms, and chains of these S–O–R–C analyses may be connected to represent behavior.

The goal following a complete functional analysis of any identified problem behavior is determining methods for altering contingencies to allow for the development of alternate behaviors. Further, as a functional analysis is developed, clinical interventions may be tailored that are intended to eliminate identified problem behaviors, either by extinction (nonreward or exposure), or by developing an incompatible alternate response. Therefore, the functional analysis is considered of utmost importance in behavior therapy as it sets the stage for how treatment is likely to proceed, what behaviors will be targeted, and what is likely to be utilized as reinforcement to foster change (see Figure 7).

III. EMPIRICALLY BASED APPLICATIONS

A. General Characteristics

Early in the history of behaviorally based treatment, researchers and clinicians sought interventions that

were based on sound experimental procedures and that produced observable change. Collectively known as behavior therapy, this field flourished under this banner and grew to its current status of cognitive-behavior therapy. It is then a sign of growth that at the present time, many researchers have formulated treatment manuals that are based on a collection of specific interventions, arranged in a meaningful sequence, that address specific behavior problems.

Professional ethics requires psychologists to use empirically supported treatments as well as psychometrically validated tests. The call for restricting clinical practice to empirically supported treatments did not come until after most clinicians abandoned earlier behavior modification practices of performing a functional assessment of the target problem followed by an individually tailored treatment based on extraordinarily well documented conditioning principles. Absent these two practices, cognitive therapists turned to validating multisession treatment packages for various disorders. Although this was and is a constructive practice, the earlier approach of functional assessment followed by intervention based on conditioning principles should not be overlooked as empirically informed practice. The roots of such practice are deeply ingrained in behavioral therapy, beginning with Gordon Paul's famous quote as follows: "What treatment, by whom, is most effective for this individual with that specific problem, and under what set of circumstance, and how does that come about?" Tryon republished a system of behavioral diagnosis that guides behavioral observation and interviewing to identify conditioning principles that maintain behavioral excesses or deficits and leads prescriptively to behavioral treatments based on empirically validated conditioning principles. This is in contrast to the current rush to develop treatment manuals, whereby the credo is what interventions, by

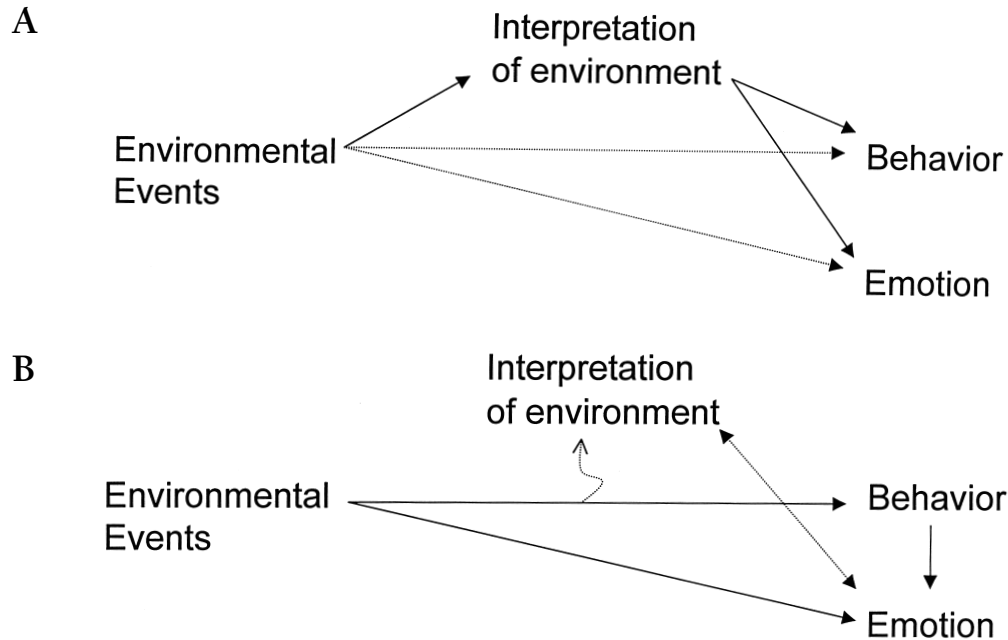

FIGURE 7 Cognitive-behavior therapy vs. Radical-behavior therapy. (A) Cognitive-behavior therapy, solid arrows indicate primary relationship emphasis. (B) Radical behavior therapy, solid arrows indicate primary relationship emphasis; double arrow indicates correlative relationship. Single arrows indicate causative relations.

which therapist, are most effective in which sequence with what diagnoses. The question of how it comes about or under what circumstances have been deemphasized in favor of packaging.

Prescriptive treatment based on known behavioral patterns has not followed such a linear trajectory from functional analysis to empirically sound intervention and back to behavior analysis. The advent of treatment manuals rests on a fundamental assumption: treatment packages have been developed around diagnoses obtained from the *Diagnostic and Statistical Manual of Mental Disorders (DSM-IV)*. This is a surprising development in some ways, because early behavioral interventions (and current approaches based on radical behaviorism) have not endorsed psychiatric nomenclature. Instead, the emphasis has always been on developing a functional analysis of the problem behaviors (including functional assessment of cognition), and developing interventions that address these functional relations.

If this is the fundamental method of assessment and intervention then how did so many cognitive-behaviorally oriented treatment manuals develop that are centered on psychiatric diagnosis? Researchers, like most professionals, are frequently responsive to market demands. There currently exists essentially one widely used

diagnostic nomenclature in mental health settings, the *DSM*. Unlike other nomenclatures, however, the *DSM* is not a guide that allows for one to determine treatment (or a meaningful heuristic for treatment) for a given diagnosis. However, practitioners are beholden to this framework in order to communicate with other mental health practitioners, and for third-party payers. Given this state of affairs, behavior therapy researchers have sought generalities within specific disorders rather than generalities within sets of interventions aimed at typical behavior patterns. To further complicate matters, most practitioners do not readily integrate research findings into their daily practices. Therefore, it is understandable why behaviorally oriented practitioners and researchers would focus on treatment manuals as a means of integrating research findings into their practices, even if these are based upon a diagnostic scheme that runs counter to the philosophy of traditional behavior therapy.

B. Characteristics of Manualized Interventions

A wide range of psychological conditions has come to the attention of researchers wishing to develop empirically supported intervention packages. The range of disorders varies, from depression to simple phobia,

headache to childhood enuresis, sexual dysfunction to sex offenses. A detailed list of empirically supported treatment is provided by Hayes, Barlow, & Nelson-Gray in their 1999 book. Criteria have been developed for three levels of empirically supported interventions: well-established treatments, probably efficacious treatments, and experimental treatments. These criteria were developed by a task force formed by Division 12 of the American Psychological Association whose mandate was to formulate both criteria for determining efficacious treatments and to identify treatments that have been established.

The typical treatment manual that relies on cognitive-behavioral procedures is a loosely associated set of empirically sound procedures, but with little in the way of a conceptual core. Although it is not our intention to single any one manualized approach out of the larger set, one illustration of this state of affairs is dialectic behavior therapy (DBT), which has been developed specifically for borderline personality disorder. An examination of the skills manual shows that there are elements of social skills training (especially interpersonal assertiveness), mindfulness exercises, exposure for fear reduction, and cognitive disputation to name a few. This has all been neatly packaged in a user-friendly format specifically formulated for the practicing clinician. The results of this packaging have indeed been encouraging, and the popularity of this approach has been impressive. On the other hand, there is no conceptual feature that unifies these interventions, and the application for borderline personality disorder may suggest as much about the syndromal validity of the diagnosis as it does for the treatment packaging (i.e. necessary components for effectiveness).

We highlight this particular treatment as it has been shown effective with a notoriously challenging population, was developed around a specific *DSM* diagnosis where the label conveys virtually nothing about how to proceed with treatment, the actual symptoms and typical presentation of the disorder are heterogeneous, and treatment entails a conglomeration of empirically established interventions from disparate branches of behavior therapy. Further, clinicians have embraced this approach and have called for more intensive research and dismantling studies.

Some treatment manuals do follow a conceptual core, although these have been less common. There are some noteworthy examples. One is a recent manual for the cognitive treatment of pure obsessions from Freeston et al. in 1997. In this case, the functional component is that individuals with pure obsessions suffer from problems in

appraising situations for their personal responsibility, which in turn creates difficulties in determining relative risk associated with specific behavioral action. However, even in this case, there is some reliance on unrelated, noncognitive interventions such as exposure-based intervention aimed purely at fear reduction.

Treatment manuals, whether following a specific diagnosis, or designed for a more general user format (such as ACT), do offer a greater value: dissemination of effective interventions. Because most manuals no longer adhere to the "session-by-session" format, the applicability to everyday practice has been greatly increased. Other barriers to dissemination have begun to tumble as the field offers training initiatives and has developed practice guidelines for specific conditions. The necessary future directions for empirically supported treatment manuals include research into the effectiveness of components in sequence for particular conditions and "dismantling" research, where components are evaluated for the specific contribution to treatment outcome. That is, to what extent are specific components of a treatment package necessary.

IV. SUMMARY

It has been our intent to survey the literature that describes the conceptual and empirical foundations that constitute behavior therapy. This broad base of literature has grown rapidly over the past 50 years, with the greatest growth witnessed in particular over the past 20. Although the founders of the behavior therapy movement did not explicitly include cognition, this has become so fundamental to the approach that it is virtually impossible to disentangle cognitive from behavioral when discussing this approach to therapy.

A more recent trend in the empirical status of behavior therapy has been the development of empirically supported treatment manuals. These manuals, although useful for describing a template for developing an intervention for problems presented in clinical practice, may be more useful when examined as part of an empirically supported practice. That is, as clinicians we would expect a scientific process be utilized when developing a treatment plan for clients, and reliance on empirical findings to inform practice. This is consistent with the original plan described in the oft-cited Bolder model in Raimy's work in 1950. The behavioral approach to therapy embraces this position, and by promoting empirically supported practices (and not only manuals) we can come closer to implementing this model.

See Also the Following Articles

Beck Therapy Approach ■ Behavior Therapy: Historical Perspective and Overview ■ Cognitive Behavior Therapy ■ Classical Conditioning ■ Coverant Control ■ Education: Curriculum for Psychotherapy ■ Gestalt Therapy ■ History of Psychotherapy ■ Operant Conditioning ■ Research in Psychotherapy

Further Reading

Barlow, D. H. (2001). *Clinical handbook of psychological disorders* (3rd ed.). New York: Guilford.

Haynes, S. N., & O'Brien, W. H. (2000). *Principles and practice of behavioral assessment*. New York: Kluwer/Plenum.

Hersen, M., & Last, C. G. (1988). *Child behavior therapy casebook*. New York: Plenum.

Kazdin, A. E. (1978). *History of behavior modification: Experimental foundations of contemporary research*. Baltimore: University Park Press.

Last, C. G., & Hersen, M. (1994). *Adult behavior therapy casebook*. New York: Plenum.

O'Donohue, W., & Krasner, L. (1995). *Theories of behavior therapy: Exploring behavior change*. Washington, DC: American Psychological Association.

Salkovskis, P. M. (1996). *Frontiers of cognitive therapy*. New York: Guilford.

Staats, A. W. (1996). *Behavior and personality: Psychological behaviorism*. New York: Springer.

Turner, S. M., Calhoun, K. S., & Adams, H. E. (1992). *Handbook of clinical behavior therapy* (2nd ed.). New York: Wiley.

Walen, S. R., DiGiuseppe, R., & Dryden, W. (1992). *A practitioner's guide of rational-emotive therapy* (2nd ed.). New York: Oxford.



Bell-and-Pad Conditioning

Daniel M. Doleys

Pain and Rehabilitation Institute
Birmingham, Alabama

Brad B. Doleys

Mt. View Hospital, Southeastern Psychiatric Institute
Montgomery, Alabama

- I. Development of Continence
 - II. Treatment of Nocturnal Enuresis
 - III. Urine Alarm
 - IV. Summary and Recommendations
- Further Reading

GLOSSARY

alarm schedule The percentage of enuretic events that trigger the urine alarm; continuous equals 100%.

anti-diuretic hormone A hormone that reduces the production of urine.

arousability The ease with which an individual can be aroused from sleep.

behavioral analysis The application of conditioning and learning principles/theory to the understanding of a behavior or response.

bell-and-pad A mechanical device incorporating a urine-sensitive pad connected to an alarm system designed to awaken the child immediately upon urine contacting the pad. Also referred to as urine alarm.

buzzer ulcers The presence of burn marks created by prolonged contact with an "active" urine alarm pad. Frequent causes include inadequate amount of urine to trigger the alarm, urine alarm apparatus too sensitive to be activated, weak batteries, alarm of insufficient intensity to arouse the child.

continence The demonstration of control over bowel and bladder activity. In the context of nocturnal enuresis generally defined as 14 or 21 consecutive nights without wetting the bed.

depth of sleep The stage of sleep as measured by electroencephalographic activity; generally 1 of 4 stages of sleep, variant stage 1 is lightest sleep and stage 4 is deepest sleep.

dry bed training (DBT) A procedure in which the child is involved in the cleaning and remaking of the bed following an enuretic episode.

desmopressin acetate (DDAVP) An anti-diuretic hormone given nasally in the treatment of nocturnal enuresis.

enuresis Wetting of the bed (nocturnal enuresis) or pants during the day (daytime enuresis) at a frequency sufficient to cause concern on the part of child and/or parents and occurring at an age by which daytime and nighttime continence is normally achieved.

full cleanliness training (FCT) A procedure that requires the child to participate in cleaning himself and his clothing following an enuretic episode. This can include taking a bath and hand washing of wet clothing. Duration of cleaning can range from 5 to 20 minutes or more.

imipramine An antidepressant that has the side effect of reducing bladder activity and therefore frequently used in the treatment of enuresis; trade name Tofranil.

intermittent alarm The programming of the urine alarm to be activated by less than 100% of wetting episodes.

overlearning A procedure frequently used in conjunction with the urine alarm that requires the child to consume enough liquid prior to bedtime to ensure at least one episode of voiding during the night.

oxybutynin An anti-cholinergic preparation that results in the relaxation of smooth muscles therefore reducing bladder contractions and activity; trade name Ditropan.

relapse The reappearance of a behavior previously altered by therapy. In the context of nocturnal enuresis relapse is usually defined as wetting the bed on one or more nights per week for 3 consecutive weeks.

retention control training (RCT) A procedure that requires the child to refrain from urinating in the presence of the

urge to do so for a progressively longer period of time; once voiding is initiated the child practices stopping and starting the stream by use of muscle control.

spontaneous remission The rate at which a behavior or response improves without systematic application of treatment.

twin-signal alarm An alarm device that presents a brief tone immediately following the enuretic event and a second tone approximately 1 minute later.

urine alarm See bell-and-pad.

I. DEVELOPMENT OF CONTINENCE

The ability to go through the night without wetting the bed, whether by postponing voiding until the morning or awakening and voiding during the night, is referred to as nocturnal (nighttime) continence. There are four stages or steps in the acquisition of mature bladder functioning necessary for nocturnal continence. These include (1) demonstrated awareness of bladder fullness (1 to 2 years); (2) ability to retain urine voluntarily (3 years); (3) capacity to start and stop the flow of urine in mid-stream (4.5 years); and (4) the ability to initiate and terminate the flow of urine at any degree of bladder fullness (approximately 5 years).

Most children achieve bladder and bowel control in a fairly systematic and reproducible fashion: (1) nocturnal bowel control; (2) daytime bowel control; (3) daytime voiding control; and (4) nighttime voiding control. In infancy voiding occurs as a result of a spinal reflex arc up to 20 times per day. This continues for the next couple of years with voluntary control of distal sphincter mechanism gradually available by the age of 3.

Enuresis is defined as the involuntary discharge of urine after the age at which bladder control should have been achieved, in most cases 5 years of age. Enuresis can occur at night (nocturnal enuresis [NE]) or daytime (diurnal enuresis), or both. NE can be further subdivided as primary (continuous), and secondary (discontinuous). The term primary NE is applied to children who have never achieved urinary continence for at least 6 continuous months. Secondary NE refers to those children who achieved dryness only to later relapse to wetting. The majority of NE cases, some 90%, are primary enuretics.

Other descriptors of NE behavior include number of wet nights per week, and number of wets per night. Some children will arouse upon wetting and others will not. A minority of children with NE are considered polysymptomatic, that is, they have coexisting urinary tract infections, dysuria (painful urination), frequency

(higher than normal episodes of voiding), and/or urgency (persistent urge to void). Children evidencing nocturnal enuresis in the absence of any other such symptoms are referred to as monosymptomatic. Approximately 10 to 20% of all 5-year-olds wet their bed at a frequency sufficient enough to be considered as NE. In most cases this involves wetting the bed one or more nights per week or at a level sufficient to cause concern on the part of the child and/or parents. Analysis of the "natural history" data suggests that approximately 15% of NE cases resolve each year such that only 2 to 4% of 12- to 14-year-olds are considered to have NE. There does not appear to be any confirmed characteristics that accurately predict which children will become dry and which will not. Some data favor those that wet less than each night, awaken in response to wetting, are motivated but not overly anxious to achieve continence, are free of comorbid psychological/behavioral problems, and live in a supportive community.

Several factors have been deemed potentially causative in NE. Included among these are small functional bladder capacity, "deep sleep," "arousal disorder," genetics, maturational delay, allergic reaction, abnormal anti-diuretic (ADH) activity, and psychological disturbance. However, detailed medical examination in most cases of NE are unrevealing for any medically related pathophysiology. Recent emphasis has been placed on maturational delay, sleep disorder, and ADH abnormality. In some cases environmental/social factors may be involved. A study by J. S. Wekke, for example, noted a higher incidence of nocturnal enuresis in special education children mainstreamed in the Dutch educational system compared to those who were not.

Genetics also play a role in NE. When both parents have had a history of enuresis there is a 77% probability that one or more of their children will be enuretic. When only one parent has a history of enuresis there is a 44% risk compared to a 20% chance of a child being enuretic when neither parent was. This possible genetic abnormality may manifest itself by a developmental delay in central nervous system functioning that could impact on the child's ability to inhibit contractions and/or maintain external sphincter contractions during the night.

It is only natural to believe that NE may be a result of disturbance in sleep. Research in this area, however, has indicated that it is unlikely that there are sleep abnormalities in enuretic patients or that enuresis begins at any particular stage of sleep. In fact, children have been noted to wet their bed in all stages of sleep although it was more likely to occur in the deeper stages. Thirty-six percent of enuretic children were found to be hard to

awaken compared to only 3.6% of nonenuretic children. The ease with which a child can be aroused appears to be a different concept and involve different mechanisms than those related to the "depth of sleep." Although "arousability and depth of sleep would appear to be related they may also exist independent of one another.

II. TREATMENT OF NOCTURNAL ENURESIS

Treatment of NE falls into two major categories, psychological and medical. By far the most common medical treatment involves the use of various medications including desmopressin acetate, imipramine, and oxybutynin. Behavioral/psychological treatments have ranged from traditional psychotherapy to the use of conditioning methodology. Probably the oldest and most researched of these procedures is the urine alarm (also referred to as bell-and-pad or moisture alarm) approach. The chapter will focus on the data related to the urine alarm in the treatment of children with NE found to be free of pathophysiologically relevant abnormalities. The data and information have been gathered from literature review and the authors' previous research and experience.

III. URINE ALARM

The potential effectiveness of an alarm device to awaken the child and prevent nighttime wetting was described by M. Pfaundler in 1904. The device was initially installed in an effort to facilitate nursing care. The concept of a urine alarm or bell-and-pad procedure was, however, popularized by Hobart Mowrer in 1938. The bell-and-pad instrumentation has been modified over the years with advanced electronics in an effort to minimize many of the early hazards such as buzzer ulcers.

The classic urine alarm is composed of a sensing device that can be activated by a small amount of urine leading to the triggering of some type of an alarm, usually auditory. The alarm, of necessity, must be of sufficient intensity to awaken the child. In some cases it may have to exceed 80 to 100 decibels. Traditionally, this device was made of two separate thin and pliable metallic-like sheaths approximately 36 inches square separated by an absorbent cloth of similar dimensions that could be placed on the bed and upon which the child would sleep. As urine was passed it was absorbed into the cloth sheeting completing a circuit and activating a battery-operated alarm.

Subsequent modifications of the urine alarm made use of a single rubber-type pad with embedded "electrodes" wherein the circuit was completed when urine bridged the gap, usually 1 to 2 inches, creating a complete circuit. The use of more sophisticated electronics has eliminated the problem of buzzer ulcers found in earlier devices. These ulcers were created when the child maintained contact with wet spots while electric current was passing through the pad.

In an effort to minimize the likelihood of the child wetting off the pad and therefore not triggering the system, sensors were developed that could be attached to the inside of the child's underwear or nighttime garment. This sensor was connected to a miniature alarm attached to the child's wrist, arm, or garment. In other instances, the sensor was embedded in a "body worn" garment. One of the more recent modifications has made use of an ultrasonic device. This device detects bladder fullness and is thus capable of awakening the child at a point of bladder contractions prior to the act of micturition. The cost and technical aspects of the system, however, may limit its general applicability.

The most common alarm or stimulus used is an auditory one. The intensity should be adjustable and sufficient to arouse the child. "Arousal conditioning" or other adjunctive therapies may be required for the "deep sleeper." A light versus auditory stimulus has been used in treating deaf children. Others have explored the use of telemetric or broadcasting arrangements to eliminate the wire running from the pad to the alarm. In some cases a vibratory or oscillatory stimulus was activated inside the nighttime garment in the hope it would awaken the child.

Other equipment issues that have been investigated included cost, sensitivity of the device, maintenance, false alarms, and durability. A ratio programmer that allows the alarm to be activated at a predetermined percentage of wetting episodes; 50% or 70% has been tried with some children. The continuous alarm, however, seems more preferable. Smaller "miniature alarms" that fit on the child's wrist can also be used. In 1970 there were no fewer than 10 different type of alarm systems available. Many of these could be obtained through commercial entities such as Montgomery Ward, Sears and Roebuck, Enuretone, etc.

A. Behavioral Analysis

A behavioral analysis of nocturnal enuresis focuses on the role of environmental conditions and appropriate learning experiences or conditioning. Treatment

emphasizes the development of bladder fullness as a discriminative cue enabling the child to inhibit voiding until the appropriate stimulus (bathroom) is present. Additionally, bladder fullness would come to be an adequate stimulus for arousal from sleep. This approach highlights the “learned” nature of the desired response (nighttime continence) and attributes the absence of the response to habit deficiencies, poor learning experiences, and lack of appropriate reinforcement contingencies.

A behavioral analysis does not ignore the potential contribution of psychological abnormalities such as childhood depression or anxiety. Rather, the behavioral analysis emphasizes the application of behavioral theory and principles of conditioning/learning to the treatment of nocturnal enuresis in place of more traditional verbal psychotherapy. The latter has not been found to be a very effective approach in treating nocturnal enuresis. In addition, behavioral analysis assumes that there is no underlying medical pathophysiology causing the nocturnal enuresis that would interfere with the use and potential effectiveness of behavioral therapies.

Some theories have been put forth to explain nocturnal enuresis and the outcome of urine alarm or bell-and-pad treatment. One such theory utilizes a classical conditioning paradigm. In this theory an event such as the urine alarm is thought to function as an unconditioned stimulus (UCS) awakening the child and reflexively inhibiting micturition or urination, the unconditioned response (UR). With repeated trials the conditioned stimulus (CS; bladder distention, detrusor muscle contraction, sphincter muscle relaxation), would produce the same inhibiting response and arouse the child (the conditioned response or CR).

Some researchers have felt that the classical conditioning paradigm did not predict the sustained dryness that is observed after treatment. They have proposed an instrumental conditioning model instead. In this model the bell or buzzer is viewed as an aversive or undesirable event that provides the basis for the development of a “conditioned avoidance response” of awakening and contracting the sphincter muscles to prevent voiding. The persistent dryness/continence that is observed following successful treatment is therefore explained in terms of the well-known resistance to extinction that is observed in conditioned avoidance responses. It is further thought that detrusor muscle relaxation and contraction of the sphincter muscles were an important part of this total response and not necessarily just the awakening of the child.

Keith Turner and his colleagues proposed a different theory. They maintained that the enuretic child’s response

during treatment was indeed an “instrumental response” but felt that the process could be more parsimoniously accounted for in terms of a punishment (passive avoidance) paradigm. They reasoned that the bell or auditory stimulus served as a type of punishment suppressing those responses, such as nocturnal voiding, that preceded or caused it.

Another behavioral approach to the problem of nocturnal enuresis has involved the use of a functional analysis. This analysis involves the application of operant conditioning principles. It views toileting and the acquisition of related behaviors such as nighttime dryness as an operant conditioning process in which social and motivational factors play an important role. The use of a functional analysis has prompted the development of therapeutic approaches that emphasize positive reinforcement for appropriate behavior, repeated rehearsal of nighttime toileting, and the application of affective negative reinforcement immediately following the enuretic event. For example, a positive reinforcement, such as a special treat, might be given for a dry night whereas wetting would result in the child having to participate in changing the wet bed.

These behavioral or conditioning approaches to nocturnal enuresis have been criticized on the basis that they overlook enuresis as a symptom of sleep or underlying problems that, even though the child may become dry at night, will probably manifest itself in some other fashion. This has frequently been referred to as a “symptom substitution theory.” Even though this theory seems to make some sense, it has not proven valid. In fact, children have been noted to be happier, less anxious, and more likely to assume responsibility therefore acting in a mature and confident fashion once the bed-wetting has been resolved. A small minority of patients have reported anxiety, bad dreams, and other emotional responses when first exposed to the bell-and-pad. However, these problem responses generally diminish as treatment continues. These emotional responses, in fact, may be likened to conditioned emotional responses or the extinction burst phenomenon frequently observed in the conditioning/learning literature.

B. General Effectiveness

In 1965 Gordon C. Young reported on 18 studies conducted between 1938 and 1964 involving 1635 children treated with the urine alarm. Success rates with the urine alarm ranged from 63 to 100%, averaging 83%. Relapse rates ranged from 9 to 52%, averaging 23%. A separate study in 1971 reported a 67% cure rate

in 83 children within 3 months of the onset of treatment but 92% at the end of 12 months. Other studies have reported up to 85% of children becoming dry in response to the urine alarm within 4 months of starting the therapy, with the majority in the first 2 months.

In a more recent review published in 1977, Daniel M. Doleys systematically evaluated the studies that were reported between 1960 and 1977. The review emphasized studies that provided (1) quantitative data, (2) between-group comparisons, (3) procedural descriptions sufficient to allow replication, and (4) follow-up data. There was total of 628 subjects. Ninety-five percent were between the ages of 4 and 15, nearly 75% were males, and the majority were primary enuretics. By applying the individual researcher's own criteria for successful treatment, which ranged from 7 to 21 consecutive dry nights, 75% of the children treated were considered successful. Treatment duration ranged from 5 weeks to 12 weeks. Forty-one percent of the children on whom follow-up data were available relapsed, the majority occurring within 6 months of treatment. Retreatment data available on 80 relapsed subjects indicated that 54 (68%) were successfully retreated.

The overall 75% success rate noted in this 1977 review was somewhat less than the 80 to 90% reported in some of the individual studies. Similarly, the 41% relapse rate was somewhat higher. Systematic reviews beyond that of 1977 continue to report success rates of approximately 70% with 20 to 30% of children relapsing. These success rates were similar when a large bell-and-pad, mini-alarm, oscillator type alarm, and alarm awakening only the child versus one awakening the child and the parents were compared. Some 60 to 80% of the children that were "cured" learned to sleep through the night while the remaining stayed dry by awakening and going to the bathroom. About 30% of the enuretic children that started treatment with the urine alarm dropped out. The vast majority of these dropouts occurred in the first few weeks of treatment.

The standard urine alarm procedure has been compared to a variety of other types of therapies. These other therapies included the use of a placebo tablet, children that received no treatment, a urine alarm that was disconnected but placed on the bed, supportive psychotherapy, advice and encouragement, and of course, "spontaneous remission." In each of these cases the urine alarm was found to be superior. There was some evidence that giving advice and encouragement helped some but a small number of children. Subjects involved in passive therapies, which were defined as instrumentation, surgery, medication, and bell-and-pad,

versus those actively involved in treatment consisting of reinforcement, reality therapy, response shaping, and sensation awareness/retention control, did not do as well; however, the difference was not statistically significant. Time to criterion and group size were not well controlled and create methodological concerns that make interpretation of the results difficult.

C. Procedure Modifications

A number of variables in the basic urine alarm protocol have been experimentally manipulated to evaluate their impact on outcome. The effect of delaying the onset of the buzzer/alarm for 3 to 5 minutes after the child wet the bed has been examined. This delay alarm group did better than a group that was not treated by the alarm but did not do as well as the no-delay group. In addition, there was a higher relapse rate in the delay group. It is therefore concluded that it is best that the alarm sound as quickly as possible after the child begins wetting the bed. It is interesting, however, to note that there was some improvement in those children when the urine alarm was placed on the bed but never activated. Factors responsible for this are frequently referred to as "nonspecific factors" and help to remind us that we may never be able to totally explain how and why a given treatment works for a specific child.

The "schedule of alarm presentation" refers to the percentage of nighttime wets that will activate the alarm system. In the traditional protocol, referred to as a "continuous" alarm, each bedwetting episode activates the alarm. A 70% variable ratio schedule indicates that "on average" 70% of the wets triggered the alarm. In some cases the percentage of wets triggering an alarm can increase or decrease during the period of treatment. In general the continuous alarm was more effective in terms of the duration of treatment and percentage of children achieving continence. The overall relapse rate, however, seemed to be somewhat less when the alarm was programmed on a more intermittent basis.

A rather unique apparatus is one that is referred to as the twin-signal apparatus. This alarm system presents a brief auditory tone at the onset of wetting and a second tone after 1 minute. The addition of the second tone is thought to help to increase the child's response to the alarm system. Although this protocol is effective there does not appear to be any distinct advantage to the twin signal alarm when compared to the one signal alarm.

Another modification to the standard urine alarm procedure involves the use of what is referred to as overlearning. In the overlearning protocol the child

consumes 32 ounces of liquids 1 hour before bedtime. This increases the likelihood that the child will have one or more wetting episodes during the night. It was believed that this would help to increase the number of “conditioning trials” during the night, which could result in a faster rate of improvement. Furthermore, consuming this amount of liquid may help the child to expand his or her control over higher levels of bladder fullness and detrusor muscular activity. In fact, when overlearning was added to the standard alarm procedure the percentage of children that became dry was comparable but the relapse rate was 13% in the overlearning group compared to 35% in the standard procedure. One research study compared the use of overlearning to a continuous versus intermittent alarm group. The percentage of children achieving continence was comparable; however, the percent of relapse was less in the overlearning group.

From a theoretical perspective these data supported the interpretation of relapse as similar to the extinction of a learned response and the intermittent schedule of alarm as a process resulting in greater resistance to extinction compared to continuous procedures. The overlearning procedure appeared to help to confirm a “generalization” hypothesis in which the conditioned awakening became associated with varying degrees of bladder fullness. The overlearning modification also produced a condition similar to “massed” practice in which trials occur more often and in closer proximity.

D. Urine Alarm Plus Medications

In the 1977 review by Daniel M. Doleys, which was referred to earlier, several medications including dexamphetamine sulfate (Dexadrine), methamphetamine hydrochloride (Methadrine), and imipramine (Tofranil) were used in the treatment of nocturnal enuresis. When dexamphetamine, methamphetamine, or imipramine was combined with the standard urine alarm protocol the duration of treatment was shorter although sometimes by a very small number of nights. However, the relapse rate was higher. In an analysis of the data, Gordon Young and Keith Turner indicated that the shorter duration of treatment was probably not clinically significant and amounted to perhaps one or two “trials.” This fact, combined with the indication of the possibility of misuse of the drugs by children in the absence of proper safeguards, resulted in the conclusion that there was little distinct advantage to adding these preparations to the urine alarm procedure.

Several new medicines have been developed since 1977. Desmopressin acetate (DDAVP) is a synthetic

analogue of arginine vasopressant (an anti-diuretic hormone.) It has very specific anti-diuretic effects with a relatively long half-life and is administered through nasal spray. DDAVP reaches its maximum plasma concentration in about 45 minutes and has a 4 to 6 hour half-life. The use of DDAVP is based on the assumption that there is a deficit in the anti-diuretic hormone in enuretic children. Some believe that there is an inadequate production of this anti-diuretic hormone during the night, thus resulting in nighttime wetting. The introduction of an anti-diuretic hormone such as DDAVP, therefore, allows for a reduction in the amount of urine permitting the child to sleep during the night without wetting.

A second newer medicine is called oxybutynin (Ditropan). Oxybutynin is an anticholinergic preparation that has direct effect on smooth muscle relaxation. This effect reduces the bladder’s ability to contract. If the bladder does not contract as much the child would then be allowed to sleep through the night uninterrupted by bladder activity.

Both DDAVP and Ditropan have been found beneficial in producing a more rapid onset of nocturnal continence. However, there is an almost 100% probability of relapse when these medicines are discontinued. They have found favor in combination with the urine alarm to help to increase motivation and compliance by prompting early success when used in the first few weeks of treatment. When used by itself, DDAVP was associated with success rates of only 42% compared to that of the urine alarm’s 78%. If used, these medicines should be gradually discontinued. Both of these medicines may be used on a periodic basis to minimize the enuretic child’s avoidance of reinforcing social activities such as overnight visits with friends, camping, and so forth.

E. Correlates of Success and Failure

As in any type of therapy it is important to identify those factors that seem to be associated with success and failure. It seems logical to assume that the acquisition of control over pelvic floor musculatures involved in the inhibition of voiding would be associated with successful treatment. Such muscular activity can be evaluated by the use of surface electromyographic studies (sEMG). In fact, children who were successfully treated for nocturnal enuresis were found to have a higher peak voltage when compared to those that failed. Furthermore, when measured prior to treatment, successful children had lower peak voltage (1.9 microvolts versus 2.7 microvolts). This observation encouraged

Arthur Housts to develop what he referred to as the "full spectrum treatment protocol." This type of treatment included a urine alarm that was worn by the child in the underwear, awakening the child during the night, the child remaining in bed until he or she is fully conscious with the alarm ringing, retention control training (Kegel exercises), and the use of overlearning, as described above. Retention control training involved the child withholding voiding during the day for progressively longer periods of time. When voiding does occur, he or she is instructed to periodically interrupt the flow of urine through the exercise of muscle control. Another component of the full spectrum treatment protocol was a parent manual explaining all aspects of treatment and an explicit behavioral contract regarding parent and child compliance. Housts reported a 75% success rate over 12 weeks of treatment with nearly 60% of the children remaining continent at 1 year.

Success rates can sometimes be increased by the use of negative reinforcement. One example is the use of a star chart. In this case a star is provided when the child awakens in response to the urine alarm and goes to the bathroom but one is lost if he or she does not awaken. Having children participate in cleaning themselves and the bed and remaking the bed following each enuretic event is another example. Such mild forms of "punishment" may enhance the child's motivation.

The use of DDAVP in conjunction with the urine alarm may help to reduce the dropout rate and therefore increase the number of children that are successfully treated. The effect of adding DDAVP to the urine alarm tends to occur in the first 3 weeks of treatment. Beyond this there appears to be no advantage over the use of the urine alarm alone. When medications such as DDAVP or imipramine are used to achieve dryness it is recommended that the urine alarm be re-instituted after 6 months while tapering the child from the medications. Success rates can also be enhanced by treating other toileting problems such as diurnal enuresis or encopresis (bowel incontinence) prior to introducing the urine alarm for nocturnal enuresis.

There appear to be a variety of factors that are associated with treatment failures. A high frequency of wetting prior to treatment and a tendency for parents to punish the child for enuretic episodes tend to correlate with failed treatment. Children that tend to display a good deal of deviant behavior and those living in a dysfunctional family environment do not do well. Maternal anxiety, failure of the child to awaken in response to the alarm, the absence of parental concern over nighttime wetting, the absence of any distress on the part of

the child over nighttime wetting, low parental education, and multiple wetting episodes during a given night have also been noted. One of the most commonly found reasons for failure is the lack of parental cooperation. A positive family history for enuresis, lack of treatment progress, and an intolerant parental attitude tended to predict early withdrawal from treatment.

Several other factors appear to have been associated with treatment failure, whether defined as early withdrawal from treatment, noncompliance of treatment procedure, or discontinuation of treatment by the professional because of a disproportionate amount of time without progress. These included elevated scores on behavior checklists indicating an abnormal level of inappropriate behaviors along with indications of general family distress. Noncompliance by parents, which tends to be highest in the first 3 weeks, unsatisfactory housing, poor maternal education, and low socioeconomic class were also noted. Parents viewing the child as withdrawn or socially incompetent and lack of parental concern seemed relevant as well.

A number of maneuvers have been found to increase the chance of success in the application of the urine alarm. These included the use of a "dummy" run with the child; allowing the child to do all the work but the parent to supervise; keeping a daily diary; no restriction of liquids; the wearing of underpants rather than pajamas to bed; the child testing the alarm prior to going to bed and rehearsing covertly or aloud the subsequent steps; overlearning; and parental praise and encouragement. In their 1998 summary of predictors of successful outcome Gretchen Gimple and colleagues noted the following: fewer wet nights pretreatment, older children, absence of daytime enuresis, parental support, and negative child perception in the absence of any significant psychiatric/psychological problem. Children with a "negative self-image" and who were exposed to parental intolerance had poor outcomes.

IV. SUMMARY AND RECOMMENDATIONS

The urine alarm has assumed and maintained a position of prominence in the treatment armamentarium for nocturnal enuresis. The apparatus generally consists of some type of sensing device activated by the presence of urine. The device is placed on the bed. The child is awakened by a bell, buzzer, or some other stimulus designed to initiate involuntary or voluntary suppression of voiding until the child reaches the

bathroom. The child then returns to bed and with parental help prepares the system by resetting the alarm and returns to sleep. In general, 70 to 90% patients become dry with a 15 to 40% relapse. Treatment duration varies from 5 to 40 weeks with a recommended continuation of treatment until 21 consecutive dry nights are accomplished. Two or more wets in 7 consecutive days have been used to determine a relapse. It is recommended that children be followed for at least 24 months following the achieving of continence even though the highest percentage of relapse occurs in the first 6 months.

The use of the urine alarm has demonstrated superiority to placebo, psychotherapy, nighttime awakening, and counseling. Medications including imipramine, amphetamine derivatives, DDAVP, and oxybutynin have contributed to increased frequency of dry nights during the early part of treatment but have not been associated with an overall increase in percentage of children that become continent. A high rate of relapse, approximately 100%, occurs upon discontinuation of the medication. Consideration needs to be given to the risk profile and cost when applying these medications.

Alarm modifications have come in various types. The devices are more sensitive and appear to have resolved concern over buzzer ulcers. Some are body worn with sensors placed in the underwear. In addition to an auditory or visual stimulus there has been the examination of a vibratory stimulus. Experimental procedures involving an ultrasonic device have been explored. The size of the alarms have been reduced because of improved technology. Treatment components for the urine alarm have

remained relatively unchanged. The addition of over-learning, the use of full cleanliness training in which the child assists in cleaning the bed, and arousal conditioning remain standard aspects of the procedure.

See Also the Following Articles

Arousal Training ■ Nocturnal Enuresis: Treatment ■ Retention Control Training

Further Reading

- Alon, U. S. (1995). Nocturnal enuresis. *Practical Pediatric Nephrology*, 9, 94.
- Cendron, M. (1999). Primary nocturnal enuresis: Current. *American Family Physician*, 59, 1205.
- Devlin, J. B., & O'Cathain, C. (1990). Predicting treatment outcome in nocturnal enuresis. *Archives of Diseases in Childhood*, 65, 1158.
- Doleys, D. M. (1977). Behavioral treatments for nocturnal enuresis in children: A review of the recent literature. *Psychological Bulletin*, 84, 30.
- Houts, H. C., Berman, J. S., & Abramson, H. (1994). The effectiveness of psychological and pharmacological treatments for nocturnal enuresis. *Journal of Consulting and Clinical Psychology*, 62, 737.
- Husmann, D. A. (1996). Enuresis. *Urology*, 48, 184.
- Mark, S. D., & Frank, J. D. (1995). Nocturnal enuresis. *British Journal of Neurology*, 75, 427.
- Rappaport, L. (1996). Prognostic factors for urine alarm. *Scandinavian Journal of Neurology and Nephrology*, 55.
- Schmitt, B. D. (1982). Nocturnal enuresis: An update on treatment. *Pediatric Clinics of North America*, 29, 21.

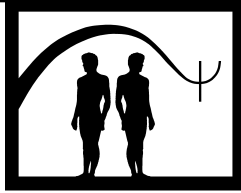

Biblical Behavior Modification

Linda Wasserman

University of West Florida

- I. Description of Treatment
 - II. Theoretical Bases
 - III. Empirical Studies
 - IV. Summary
- Further Reading

GLOSSARY

aversive counterconditioning A specific application of respondent conditioning that causes behavior change when a stimulus that elicits an undesired response, is consistently paired with an aversive stimulus that elicits an incompatible response. The result is that, due to such pairing, the undesired response is eventually reduced or eliminated.

cognitions A person's thoughts, beliefs, perceptions, and images.

contingency contracts Behavioral contracts between individuals who wish behavior to change (e.g., parents or teachers) and those whose behavior is to be changed (e.g., children or students).

covert assertion A behavior modification technique that causes behavior change when a person says forceful or assertive things to himself or herself (e.g., "I am brave. I am strong."), statements that often contradict the actual situation or problem.

desensitization The gradual counterconditioning of anxiety with an incompatible response such as relaxation.

modeling A behavior modification technique that causes behavior change when a person observes a behavior in one or more others and then imitates or learns that same behavior or behavior strategy.

operant conditioning A behavior modification technique that causes behavior change by building associations between certain behaviors and the consequences of those behaviors (e.g., a particular behavior is either rewarded or punished and thus increases or decreases in probability).

respondent (classical) conditioning A behavior modification technique that causes behavior change when a particular stimulus is paired or associated with a second stimulus (the unconditioned stimulus). As a result of the association, the first stimulus (the conditioned stimulus), then comes to elicit a response (the conditioned response) it did not previously elicit. Eventually, the conditioned stimulus elicits the conditioned response without the presence of the unconditioned stimulus.

semantic desensitization The process of counterconditioning the negative aspects of certain words related to unpleasant situations or a person's phobias with more pleasant images or thoughts.

Therapists and their clients alike want effective means to promote desired changes in behaviors, attitudes, and coping skills. Biblical behavior modification offers a unique way for therapists to help their Christian clients do just that. By matching behavior modification techniques to the clients' beliefs or to Biblical principles (the usual foundation for those beliefs), the therapist not only helps produce the desired changes in behavior, but also builds a relationship of trust and respect between the therapist and client. This is especially important considering the fact that many Christians avoid

seeking professional secular help because they believe, even fear, that therapists may attempt to use therapies or behavior change techniques that either ridicule and/or fail to support their religious beliefs.

I. DESCRIPTION OF TREATMENT

Biblical behavior modification, composed as it is of both theoretical and practical components from behaviorism, social learning, and cognitive science, offers a wide variety of treatments that can be especially appealing to Christians. Christians might desire, for example, to show less anger in their reactions to certain events, get rid of a slight agoraphobia in order to spend more time with fellow Christians, control a problem with alcoholism, or learn to think of others in a less critical way. In this desire to live a more Christian life (i.e., “live up to their beliefs”), Christians seek help in a variety of ways in order to change or control certain behaviors. They pray or study their Bible, talk to friends or family members, or seek counseling from a minister or a counselor/therapist (who may or may not be a Christian).

Sometimes these choices are effective and sometimes they are not, with success usually depending both on individual motivation and dedication to change and on whether or not the advice given or the action taken follows the course of proven behavior change methods. The methods and techniques of behavior therapy, especially with the Biblical applications, are designed to offer what Christians need: the ability to develop desired behaviors, discourage undesired behaviors, eliminate phobias, control addictions, and monitor thoughts and attitudes.

Therefore, with Christian clients, Biblical behavior modification can be quite effective because it is not only based on sound behavioral theory, but it also acknowledges the spiritual motivation Christians have for the behavior change. Part of its effectiveness, then, comes as a result of universal principles that cut across disciplines such as psychology and theology. However, because many think such disciplines as psychology and theology are incompatible, it is necessary to take a closer look at some philosophical controversies that are basic to the whole concept of Biblical behavior modification.

A. The Controversies: An Introduction

Those who seek good mental health, and counselors who assist those who need help in the search, are faced

with a monumental question. How do human beings learn to control their circumstances and/or behaviors—that is, promote desirable ones and eliminate undesirable ones—in order to reach life goals and live a good and happy life?

Humankind’s attempt to answer that question over the ages has given rise to major philosophical controversies over what we can and cannot control or change. In fact, these controversies have transformed themselves into many complex and interrelated questions, so many and so complex, in fact, they cannot all be discussed thoroughly here. However, to give some flavor to the overall reason for the controversies, we must take a cursory look at two of the many layers: the mind/body dilemma and the science/religion controversy.

The mind/body dilemma poses many of the questions most commonly cited, and most wrestled with, by the world’s greatest philosophers. What are we as human beings? Are we bodies with strange ethereal appendages called minds? Or are we minds (spirits) who inhabit troublesome bodies? In other words, does the body control the mind, or does the mind control the body? Do Descartes’ famous words, “I think, therefore I am,” exude truth or hide it?

Conclusions to these questions have come in all forms throughout the ages, but the latest research seems to indicate that there is no true line of demarcation. The mind and body seem so interrelated that most researchers and philosophers today acknowledge their mutual control and influence over each other. At the same time, however, scientists today are more ready to accept as true the idea that the mind (spirit) within each person represents something that is distinct from the material body. They also seem to accept that this mind, despite its unwillingness to be measured, exists as a separate entity of the person with a separate purpose: mainly, control of the body. So, the controversy continues to exist, but Christian beliefs about individual spirits seem to be more acceptable to science in today’s world than in times past.

This brings us to the science/religion controversy. Scientists have for centuries scoffed at religious beliefs, calling them subjective, superstitious, and emotion-driven. This is true, of course, in many cases, but religious people have also scoffed at science, calling it materialistic and godless, also true in many cases. Indeed, many consider science and religion mutually exclusive realms, realms that will never meet. Biblical behavior modification, however, proves that conclusion to be incorrect.

B. One Answer: Biblical Behavior Modification

During the course of these philosophical arguments over mind and body and science and religion, science developed the field of psychology to study the brains and behaviors of both animals and humans. One of the major results was the discovery of numerous facts regarding human behavior, facts that in essence became principles or tools for behavior change. For example, in the area of behaviorism, science discovered that animals and people both respond positively to rewards: Animals will push a lever for food; young students will do their homework for a star. Social learning theorists discovered we can and do learn many (maybe most) of our behaviors by imitating others. This principle is used by therapists in any number of clinical settings (e.g., teaching appropriate social skills or helping people rid themselves of phobias).

Therefore, when therapists adopt these principles to help their clients, they do not develop them “from scratch.” They, instead, adopt, adapt, and apply valid principles of human behavior to whatever setting or need they or their clients may have. As will be seen from the examples that follow, advocates of Biblical behavior modification do the same. In other words, the same principles of human behavior are inherent in Biblical teachings, and the fact that science (i.e., psychology) has now “discovered” them, helps to prove their universal and enduring nature.

II. THEORETICAL BASES

A. The Psychology: Behavior Therapy

Many people are skeptical of behavior therapies of all types because they equate them with B.F. Skinner’s behaviorism. Those who are concerned about the fact that behavior can be conditioned often consider behaviorism a type of mind control, rather than a tool to promote positive behavior change.

In part, because of such fears, modern behavior therapy tends to focus more on social learning and cognitive techniques than on conditioning behavior. However, the basic foundation of behavior therapy is still behavioristic. Therefore, in order to understand Biblical behavior modification and the examples of it that will follow, it is important to understand the concepts of behaviorism, as well as numerous other foundational principles and techniques of clinical behavior modification. Unfortunately, they cannot all be dis-

cussed, so, for the sake of clarification and brevity, they are separated below into the following broad categories: behavioral techniques, social learning techniques, and cognitive techniques.

It must be noted, however, that one of the “special” underlying premises of Biblical behavior modification is that such separation is not truly possible. In other words, just as the mind and the body are distinct, but always influence each other, so does conditioning influence social learning, which in turn, influences thoughts. Behavior modification, therefore, is a continuing interrelated circle of behaviors influencing behaviors.

1. Behavioral Techniques

a) *Respondent Conditioning* Most people know about respondent conditioning because they know about Pavlov’s dogs. That classic example shows that behavior change can occur when a particular stimulus (ringing a bell) is either coincidentally or purposely paired or associated with a second stimulus (feeding the dogs—the unconditioned stimulus). As a result of the association, the first stimulus (the bell—the conditioned stimulus), then comes to elicit a response (the salivating of the dogs—the conditioned response) it did not previously elicit. Eventually, the conditioned stimulus (the bell) elicits the conditioned response (salivation) without the presence of the unconditioned stimulus (in other words, even without the food, even when it is not time to feed the dogs). This type of conditioning is the one most often responsible for the phobias that plague so many: unreasonable fear becomes associated with an animal, place, or experience that normally would not cause that degree of fear.

Although therapists use numerous variations of respondent conditioning to effect behavior change, two forms are especially interesting. Aversive counterconditioning produces behavior change when a stimulus which elicits an undesired response is consistently paired with an aversive stimulus which elicits an incompatible response. The result is that, due to such pairing, the undesired response is eventually reduced or eliminated.

This technique is used quite often, for example, with smokers or obese clients. Smokers want to keep cigarettes from tempting them to smoke and the obese want to overcome their desire to eat too much; therefore, cigarettes and food are the stimuli that elicit the undesired response. Using aversive counterconditioning to control their behaviors, smokers might imagine cigarette smoke as fingers reaching to choke the air out of their lungs and the obese might imagine their most

tempting foods as spoiled or rotten. In other words, aversive stimuli are paired with the regular stimuli to rid them (the cigarettes, the food) of their normal “power” to influence behavior.

Desensitization is another variation of respondent conditioning often used to help clients overcome such things as the fear of public speaking or the fear of flying. After creating a hierarchy of behaviors that begins with those that cause no anxiety and ends with those that cause the most anxiety, the therapist gradually leads the client (visually and, finally, *in vivo*) through each behavior in the hierarchy. At each step the anxiety is counterconditioned with an incompatible response, such as relaxation, until the client can reach the top of the hierarchy (i.e., until the client can comfortably make a public speech or fly in an airplane). The amount of time it takes to “climb” the hierarchy varies with the person and with the situation causing the anxiety, but it usually ranges anywhere from a few hours to several months.

b) Operant Conditioning Operant conditioning, which occurs all day every day in all types of situations, causes behavior change by building in consequences to behaviors. In other words, everyone from parents and teachers to employers and spouses use it to either reward or punish particular behaviors of others and thus increase or decrease the probability of those behaviors being repeated. Operant conditioning takes many forms but the reward and/or punishment theme is common to all of them.

A specialized form of operant conditioning is contingency contracting. Contingency contracts are behavioral contracts between individuals (often parents or teachers) who wish to see changes in behavior and those (children or students) whose behavior is to be changed. The contracts, usually written out and signed by those involved, allow the rewards and punishments of various behaviors to be negotiated by both parties.

2. Social Learning Techniques

Although there are many social learning techniques and theories, the foundation principle of them all is modeling. Modeling causes behavior change when a person observes a behavior in one or more others and then imitates or learns that same behavior or behavior strategy. Parents use this technique every day as they teach their children to talk, ride a bicycle, make their beds, and use good table manners. Often, to their consternation, parents learn the true power of modeling when they see their children model their own behaviors (e.g., Mom’s disorganization or Dad’s shyness).

3. Cognitive Techniques

Cognitions are a person’s thoughts, beliefs, perceptions, and images, and many would argue that these are not behaviors because they cannot be seen or measured accurately by others. The tendency in modern behavior therapy, though, is to accept all cognitions as covert behaviors, and if accepted as such, to also consider them candidates for change through the use of behavior modification techniques. It is also important to understand that, although cognitive therapy is often classified as a separate type of approach, cognitive elements are inherent to all therapies, and, as part of the mind/body conundrum, covert behaviors (those of the mind) and overt behaviors (those of the body) have a mutual influence on each other.

Semantic desensitization, a variation of respondent conditioning, is an example of a technique with a definite cognitive component. Unlike regular desensitization, which usually counterconditions feelings of anxiety, this process counterconditions the negative aspects of certain words, words related to unpleasant situations or a person’s phobias, with more pleasant images or thoughts.

Covert assertion is a behavior modification technique that causes behavior change when a person says forceful or assertive things to himself or herself, things that often contradict the actual situation or problem. For example, a man avoiding a doctor’s appointment because of a potential health problem might repeat to himself such statements as, “I am brave. I am strong.”

B. The Theology: Judeo-Christian Teachings

Although hundreds of Judeo-Christian beliefs and teachings could be discussed to illustrate the theology of Biblical behavior modification, three major principles of Christian belief will suffice. Indeed, these three help define the interplay between behaviors (body) and belief (mind) that are so much a part of Biblical behavior modification.

1. Love

Love, one of the constants found in Christian teachings, begins with the love God has toward humankind. Christians then return that love and extend it toward others. Indeed, one of the requirements of Christian love is to reach out to others in order to show compassion and care. Therefore, Christians are expected to express love by engaging in certain types of behaviors: for example, participating in worship services, helping a friend or

neighbor in need, providing food and shelter for one's family, and so forth. In other words, one of the duties of Christians is to initiate such positive behaviors.

2. *Self-control*

The fact that God instituted laws and commands to be obeyed implies that there are both acceptable and unacceptable behaviors. Therefore, in the Judeo-Christian religions, the concept of self-control becomes an important issue. Therefore, the control of negative behaviors (usually called sins), which are in contradiction to the laws of God, becomes another important duty of Christians.

3. *Inner Peace*

Christianity, like many other religions, places a high value on a sense of inner tranquility and peace. The Christian believes there is no better way to gain that inner peace than by leading a life highlighted by two factors: love for God and others expressed by many positive behaviors and a sense of self-control that has helped eliminate undesired and negative behaviors.

C. The Focus: The Bible

When Christians have a question about what their behavior should be, they go to the Bible, which they consider the word of God, for guidance. They may go to other sources as well (e.g., ministers and counselors), but the "Good Book" is their primary source for answers. That is now the place to go for examples of Biblical behavior modification.

Although they are not always immediately evident, the Bible is replete with examples of respondent conditioning. In fact, Christians are to associate all kinds of good feelings, not only to the book itself, "his delight is in the law of the Lord..." (Psalm 1:2), but also to all the symbols and images of Christianity:

May I never boast except in the cross... (Galatians 6:14)

... for all of you who were baptized into Christ have clothed yourselves with Christ. (Galatians 3:27)

...we, who are many, are one body, for we all partake of the one loaf [communion]. (I Corinthians 10:16, 17)

Christians are also taught to associate negative feelings with certain situations, in order that the negative becomes conditioned:

Your enemy the devil prowls around like a roaring lion looking for someone to devour. (I Peter 5:8)

Watch out for false teachers. They come to you in sheep's clothing, but inwardly they are ferocious wolves. (Matthew 7:15)

With aversive counterconditioning, Biblical behavior modification offers a more specific application of respondent conditioning, one that helps Christians avoid undesired behaviors by making the association with them very aversive:

Do not join those who drink too much wine or gorge themselves on meat, for drunkards and gluttons become poor, and drowsiness clothes them in rags. (Proverbs 23:20, 21)

For the lips of an adulteress drip honey, and her speech is smoother than oil; but in the end she is bitter as gall, sharp as a double-edged sword.... (Proverbs 6:24-35)

Desensitization for the Christian is not developed in specific hierarchy form in the Bible as it is with a therapist. However, the major component of desensitization, the training in relaxation under stressful situations, is evident in many passages: "So do not fear, for I am with you..." (Isaiah 41:10); "Do not be anxious about anything." (Philippians 4:6, 7); "Let not your heart be troubled, neither let it be afraid." (John 14:27).

Operant conditioning, like respondent conditioning, is found throughout the Bible. Unlike respondent conditioning, however, examples of operant conditioning are very obvious. The following passages indicate the prevalence in scripture of the concepts of rewards and punishment for behaviors:

I praise you for remembering me... (I Corinthians 11:2)

They sow the wind and reap the whirlwind. (Hosea 8:7)

Now there is in store for me the crown of righteousness, which the Lord ... will award to me on that day... (II Timothy 4:8)

God is just: He will pay back trouble to those who trouble you and give relief to you who are troubled... (II Thessalonians 1:6-10)

In essence, the Bible exists as two major contingency contracts. The Old Testament is a contingency contract for the Jews and the New Testament is a contingency contract for Christians. In other words, the two major divisions of the Bible, contracted with two groups of people, offer a written behavior guide, complete with rewards and punishments, for each group.

Deuteronomy 28:1–64 is a lengthy, but excellent, example from the Old Testament. Examples for Christians from the New Testament, although not so lengthy, still show the contingencies of the behaviors: “If you want to enter life, obey the commandments.” (Matthew 19:17); “To those who by persistence in doing good seek glory, honor and immortality, he will give eternal life. But for those who are self-seeking and who reject the truth and follow evil, there will be wrath and anger.” (Romans 2:6–8).

The Biblical behavior modification version of modeling is also common in numerous Bible passages. The value and effectiveness of modeling is also illustrated in quite straightforward language:

These commandments that I give you today are to be upon your hearts. Impress them on your children. Talk about them when you sit at home and when you walk along the road, when you lie down and when you get up. (Deuteronomy 6:4–7)

... you shall read this law before them in their hearing so they can listen and learn... (Deuteronomy 31:10–13)

... set an example for the believers... (I Timothy 4:12)

You became imitators of us and of the Lord... And so you became a model to all the believers... (I Thessalonians 1:6–8)

Christians are taught from the time they become Christians that their thoughts, and the control of those thoughts, are important parts of their Christian life. Therefore, the cognitive portion of Biblical behavior modification has great value to them, especially if they can find ways to control the mind when it becomes unruly. Covert assertion is one method that helps in difficult emotional or physical circumstances:

I have learned to be content whatever the circumstances. (Phillippians 4:11)

I can do everything through him who gives me strength. (Phillippians 4:13)

When I am afraid, I will trust in you. In God, whose word I praise, in God I trust; I will not be afraid. What can mortal man do to me? (Psalm 56:3, 4)

Although there are many others, one last cognitive therapy to examine here is semantic desensitization, the purposeful conditioning of pleasant thoughts or images to something that is not so pleasant. Christians make use of this technique to help keep the inner peace they desire, despite what is going on in their lives.

For our light and momentary troubles are achieving for us an eternal glory... (II Corinthians 4:16–18)

For my yoke is easy and my burden is light. (Matthew 11:30)

... but we rejoice in our sufferings... (Romans 5:2, 3)

Consider it pure joy, my brothers, whenever you face trials of many kinds... (James 1:2, 3, & 12)

III. EMPIRICAL STUDIES

Many questions remain. Does Biblical behavior therapy work? And if it works, is it effective enough? Does it serve its purpose? Should a counselor consider its use with his or her Christian clients? Because there are few empirical studies on the actual application of behavior modification techniques for spiritual purposes, the answers to the above questions have to be as integrated as the approach itself.

Years of research and study have shown the practical and valuable use of respondent and operant conditioning, modeling, and cognitive therapy to effect desired behavior change. For example, counselors have gradually helped their clients rid themselves of the fear of flying; teachers have shaped their students' behaviors by rewarding those students who listen in class; advisors have modeled the proper ways to initiate a conversation; and therapists have helped clients develop cognitive techniques to gain control over irrational thoughts and feelings. Medical journals, as well as psychology journals, have examples of these same behavioral techniques being used to do such things as reduce blood pressure, overcome obesity, and control obsessive–compulsive behaviors. In other words, behavior modification therapy and its varied techniques have proven successful across the years in a wide variety of applications with a wide variety of behaviors.

Relatively recent research has also shown as fact that a person's religious/spiritual beliefs can have a profound effect on their abilities to do all the above. In fact, studies have shown that the religious person often suffers less from stress, heals faster, is less susceptible to infection, and has fewer problems with mental disorders and social maladies (such as alcoholism). The reasons are not fully apparent at this time, although some have hypothesized that the social structure and support offered by a spiritual life is beneficial. This article, of course, has argued that Biblical guides for attitudes and behaviors, used consciously or unconsciously, are based on effective universal principles. At any rate, the

field for further applied research in Biblical behavior modification is certainly ripe.

IV. SUMMARY

A. The Synthesis: Biblical Behavior Modification

In essence, Biblical behavior modification is indeed a pathway to wholeness. While respecting all the individual parts, it makes a whole out of the mind and the body, out of thoughts and behaviors. It brings together science and religion. It blends the behavior therapies into effective means and strategies to address almost any behavior problem or need. Indeed, Biblical behavior modification values and treats the whole person.

B. Conclusions

Counselors and therapists need to acknowledge the religious/spiritual beliefs of their clients, as well as become knowledgeable enough about those beliefs to match them to effective behavior change techniques. They also need to followup with further research to see how these applications can become more effective and be expanded in use for other behavior problems.

See Also the Following Articles

Anxiety Management Training ■ Behavior Therapy: Theoretical Bases ■ Bibliotherapy ■ Classical

Conditioning ■ Covert Positive Reinforcement ■ Covert Rehearsal ■ Operant Conditioning ■ Self-Control Desensitization

Further Reading

- Bolin, E. P., & Goldberg, G. M. (1979). Behavioral psychology and the Bible: General and specific considerations. *Journal of Psychology and Theology*, 7, 167.
- Bufford, R. K. (1977). God and behavior mod: Some thoughts concerning relationships between biblical principles and behavior modification. *Journal of Psychology and Theology*, 13.
- Genia, V. (2000). Religious issues in secularly based psychotherapy. *Counseling Values*, 44, 213.
- Hawkins, R. S., Tan, S., & Turk, A. A. (1999). Secular versus Christian inpatient cognitive-behavioral therapy programs: Impact on depression and spiritual well-being. *Journal of Psychology and Theology*, 27, 309.
- Lasure, L. C., & Mikulas, W. L. (1996). Biblical behavior modification. *Behavior Research and Therapy*, 34, 563.
- Rollins, W. G. (1997). The Bible and psychology: New directions in biblical scholarship. *Pastoral Psychology*, 45, 163.
- Worthington, E. L., Jr. (1994). A blueprint for intradisciplinary integration. *Journal of Psychology and Theology*, 22, 79.
- Worthington, E. L., Jr., McCullough, M. E., & Sandage, S. J. (1996). Empirical research on religion and psychotherapeutic processes and outcomes A 10-year review and research prospectus. *Psychological Bulletin*, 119, 448.

Biblical quotations taken from:

New International Version Pictorial Bible. (1981). Grand Rapids, Michigan: Zondervan Bible Publishers.

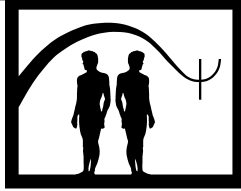

Bibliotherapy

Eileen Gambrill

University of California at Berkeley

- I. Introduction
 - II. Description of Treatment
 - III. Theoretical Bases
 - IV. Applications and Exclusions
 - V. Empirical Questions and Studies
 - VI. Case Illustrations
 - VII. Summary
- Further Reading

GLOSSARY

attributions Causal factors assumed to be responsible for given events-perceived causality.

bibliotherapy Requesting or advising an individual to read written material to attain hoped-for outcomes.

contingencies Associations between behavior and related cues and consequences.

dispositional attributions Characteristics of the individual.

effect size A number that summarizes the strength of effect of a given intervention.

functional analysis A demonstration of the influence of certain cues and consequences on behaviors of interest. This is sometimes confused with a “descriptive analysis” that refers to a description of assumed cues and consequences related to behaviors of interest (rather than a demonstration of their effects as in a functional analysis).

fundamental attribution error Focusing on personality attributes and overlooking environmental causes.

generalization Occurrence of behavior in situations other than those in which it was established.

imaginal therapy The client is guided through imagery regarding feared situations, thoughts, and physical reactions.

maintenance Continuation of behavior changes over time.

meta-analysis Critical review of all experimental studies regarding the effectiveness of a specific intervention in achieving hoped-for outcomes.

randomized controlled trial Random distribution of participants to an experimental group and a control group to investigate the effectiveness of an intervention.

relapse prevention Interventions designed to maintain gains in spite of lapses.

self-efficacy Expectations regarding whether we can perform given behaviors and whether these will result in given consequences.

self-management Pursuit of hoped-for goals by rearranging related cues and consequences oneself.

self-monitoring Keeping track of some behaviors, thoughts, or feelings in real-life situations.

stimulus control Influencing behavior by rearranging antecedents of behaviors.

I. INTRODUCTION

The term bibliotherapy refers to reading written material to pursue valued goals. Surveys of counselors in a variety of professions indicate that they often assign (prescribe) specific readings to clients. Self-help material is available for a wide range of aims including enhancing parenting skills, sexual pleasure, social and study skills, and decreasing substance abuse, anxiety, depression, smoking, and excess weight. Aims include providing information about a concern including its prevalence, motivating readers to address it, describing

a variety of change options, and helping readers select promising ones. The variety of aims addressed can be seen in guides to self-help resources such as those prepared by John Norcross and his colleagues. Reading has been used throughout the ages to pursue valued goals. Consider the Bible. This ancient manuscript was and is used as a guide to living and wrestling with life's problems and concerns. Steven Starker views self-help books as a modern-day oracle replacing older sources of guidance and advice. The United States has been particularly enthusiastic about the use of reading as a route to self-help; consider the attention given to the "self-made man" and, more recently, "woman." Possible benefits of bibliotherapy include attaining desired outcomes with little expenditure of time, money, and effort, and accessing accurate information about topics of interest (e.g., social anxiety, depression) and how to achieve valued outcomes (e.g., enhancing self-change skills and decreasing beliefs that hinder self-change). Another potential benefit is that we learn to rely on ourselves rather than on a therapist.

II. DESCRIPTION OF TREATMENT

Characteristics common to use of bibliotherapy in clinical practice include a request to read certain written material and instructions guiding the reader in the application of procedures described in real-life contexts. This may include self-monitoring (keeping track of particular behaviors, thoughts, or feelings in real-life situations) for assessment or to evaluate progress, as well as instructions on what to do given certain degrees of progress. Underlying assumptions on which recommendations are based are usually described and examples of applying methods given. Clinical use differs along the following dimensions: (1) extent of helper–client contact ranging from none to extensive; (2) use of individual or group format; (3) development of general versus specific skills; (4) the extent to which readers are requested to "interact" with the written material in terms of completing exercises to test their understanding of content; (5) whether bibliotherapy is used together with other methods; (6) whether access to additional written material is made contingent on reading and understanding more elementary portions; and (7) attention devoted to generalization and maintenance of positive effects. Inclusion of relapse prevention guidelines offers readers information they can review on an as-needed basis. Most programs using bibliotherapy are brief, for example 8 to 12 weeks.

Bibliotherapy materials differ in degree of attention given to helping readers to carry out an individualized assessment on which they would base selection of change methods. Some written material encourages readers to gather data (e.g., to observe and record the frequency of behaviors of interest and related circumstances). Data gathered during assessment or "self-diagnosis" are used to plan change programs. Let's say that a woman reads a self-help book in order to increase enjoyable social contacts. Possible reasons for unsatisfactory social contacts (either in frequency and/or kind) include a lack of social skills (e.g., initiating conversations), anxiety (perhaps due to fear of negative evaluation), unrealistic expectations (e.g., "I must always succeed."), poor self-management skills (e.g., in controlling anger following a rejection), and environmental obstacles (e.g., few places to meet people). Written materials differ in the extent to which guidelines help readers to identify how they can profitably change their behavior to achieve hoped-for outcomes. Common errors in searching for the causes of behavior include mistaking correlation for causation and overlooking environmental causes. To the extent to which data are informative (reduce uncertainty about how to attain valued outcomes) and assumptions about how valued outcomes can best be pursued are accurate, readers are more likely to make sound decisions regarding selection of self-change methods. Inaccurate data and assumptions may result in incorrect choices of self-change programs.

In totally self-administered bibliotherapy, the client receives or is asked to purchase material from a helper with no additional contact beyond an initial meeting. In minimal contact formats, the counselor may provide reading materials but takes a somewhat more active role such as arranging phone calls and infrequent meetings. Yet a third format consists of counselor-directed reading in a self-help book that the client obtains at the beginning of assessment followed by meetings with the helper on a regular basis. Here, written material provides a focus of discussion in relation to how this applies to the client. Last, in a counselor-directed approach, self-help books are used as a part of the counseling. In addition to reading, other formats include listening to tapes and computer-presented information. It is suggested that practitioners use books with which they are familiar, consider the length of the book as well as degree of extraneous material, and select books that are applicable to readers' concerns and reading ability. Requisites for successful use of bibliotherapy include reading skills that match the required reading level of the text.

III. THEORETICAL BASES

A basic premise is that readers can attain certain hoped-for goals by implementing material read (although, in some cases this may only be possible through relinquishing control over uncontrollable events). There is a built-in self-efficacy message, an expectation that readers can attain certain outcomes through reading and acting on what they read. The expectation is that readers will be able to successfully apply the instructions given in real life. For example, it is expected that parents who read a manual describing how to toilet train their child will be able to use the information to achieve this outcome or that readers of a self-help manual designed to decrease alcohol consumption will be able to use the information to decrease their drinking. That is, it is assumed that people can be their own agents of change with minimal or no counselor contact. A key step in behavior change is identifying and altering factors related to desired outcomes. Self-control or self-management involves a process in which we are the main agent in guiding and altering our behavior to achieved self-selected goals.

Bibliotherapy materials differ in views presented about how valued outcomes can be attained. Thus, self-help material not only implies a self-efficacy message but also describes a particular viewpoint as to how goals can be achieved. Different models of self-management include B. F. Skinner's operant model in which it is assumed that self-change behaviors consist of a repertoire of behaviors that are influenced by environmental contingencies (i.e., by the same behavioral principles that influence any behavior). If we ourselves use such methods to attain goals we have set for ourselves, we are engaged in self-management. One kind of self-management involves the rearrangement of antecedents related to behaviors of interest. This is known as stimulus control. For example, cues that encourage unwanted behavior can be removed or reduced, and those that encourage desired behaviors can be increased. We could for example use physical aids (written reminders) to encourage desired behaviors. A second involves rearrangement of consequences; positive consequences are provided for behaviors we would like to encourage, and negative consequences are removed. Negative consequences may be provided for unwanted behaviors, and positive consequences that usually follow such behaviors may be withheld. Reading about presumed sources of influence on behaviors of interest may help readers to alter behavior in valued directions by rearranging related cues and consequences (e.g, reminding

ourselves to focus on positive thoughts in stressful situations to keep anxiety in check).

Some authors emphasize the role of self-monitoring of behavior and our awareness of choice points (e.g., what to do next), which they argue also involves self-evaluation of behavior. Research suggests that self-observation may alter behavior. When we observe our behavior, we attend to it more carefully and may identify and change cues and consequences that influence its frequency. Other writers emphasize the role of attributions (assumed causes for behavior) noting that research suggests that we can enhance maintenance of positive changes by emphasizing the control we have over our behavior (e.g., attributing self-change to our own efforts in contrast to viewing our behavior as under the control of environmental consequences over which we have little influence). Self-management skills that may be involved in self-change include the following:

- Self-assessment skills in using written material to clearly define desired outcomes and to plan how to achieve them
- Self-monitoring skills to gather helpful assessment information and to evaluate progress
- Skills in arranging cues and incentives so hoped-for reactions will increase and unwanted reactions will decrease
- Skills in choosing next steps when positive gains are made
- Troubleshooting skills to overcome obstacles when change methods do not work
- Skills in generalizing and maintaining positive changes

IV. APPLICATIONS AND EXCLUSIONS

Certain kinds of individuals are more likely than others to profit from self-help formats. Attributions may influence the extent to which different people make effective use of bibliotherapy methods. Research suggests that those who score higher on internal locus of control (they believe that they have a great deal of control over what happens to them) are more successful in altering their behavior compared to people who are more externally controlled (they attribute what happens to them largely to external events). People differ in their repertoire of self-change skills and in their history of using them to attain valued outcomes. For example, some readers may not know how to set

clear goals. Some may not know how to rearrange cues and consequences related to outcomes of interest. Contraindications to use of bibliotherapy include limited reading ability and small probability that the client will follow instructions, perhaps because of personal or environmental obstacles. Countervailing personal characteristics include high anxiety that may interfere with successful use of material. Written material may not address key related factors, for example, excessive alcohol drinking may be maintained by peer support and written material may not address this. Literature on behavior change suggests that practice is related to acquiring new skills. Thus, arranging such practice will be needed, and this will require related self-management skills. Effective use of bibliographic methods requires generalization and maintenance of valued behaviors. This also requires self-management skills. Many clients do not have the self-management skills required to make effective use of written material to change their behavior. Counselor guidance and support may be necessary. Support also could be provided by group members or "buddies" who are involved in group programs. Research suggests that acquiring different kinds of skills requires different kinds of learning programs. Consider learning to play golf. Will reading books about how to play golf produce skilled golfers? Probably not, as many disappointed readers have found. Learning such a skill involves a complex sequence of behaviors that may only be acquired through on-the-spot coaching and practice.

V. EMPIRICAL QUESTIONS AND STUDIES

Compared to the abundance of self-help books and manuals available, the evaluation of these materials is skimpy in terms of whether they do more good than harm. For example, do they really help people achieve what they promise? Self-help books differ in the clarity with which hoped-for outcomes are described. Promising self-fulfillment is vague compared to helping readers lose weight, get better grades, or make friends. Self-help books differ in the evidentiary base of their views about how self-change can be achieved ranging from material that appeals to will power in motivating change (notoriously ineffective), to those that rely on empirical findings regarding what has been found to contribute to self-change. Research on self-management and self-instruction suggests that some methods and formats are more likely than others to facilitate self-help efforts. Key

to self-management is effectively dealing with the weak effects of delayed consequences (e.g., studying more today to avoid a bad grade on a test in 4 weeks). To what extent do self-help books build on knowledge about self-management? To what extent does a book help readers to take advantage of skills they already have? As with many other areas of psychotherapy, claims are often inflated. Gerald Rosen raised concerns regarding use of self-help materials and suggested guidelines for screening do-it-yourself-treatment books:

1. What claims are made in the book? What does it promise readers?

2. Is accurate information provided concerning the extent to which claims of effectiveness have been critically tested? Have the techniques described in the book been critically appraised in relation to claims of effectiveness and have the results been positive?

3. Can readers check whether they develop appropriate expectations as to what they can (and cannot) gain from reading the material?

4. Does the book describe methods readers can use for self-assessment to determine whether this book will be of benefit to them, and if so, in what way? Have these procedures been critically tested? A key question is the following: "Can the reader make an accurate assessment of what may be helpful in attaining desired outcomes?"

5. Has the book been evaluated in terms of clinical efficacy? If so, under what conditions, with what population, with what results? Some self-help books describe procedures that have empirical support but these procedures may not have been evaluated in a bibliotherapy format.

6. How does the effectiveness of one source of bibliotherapy compare to that of other manuals or formats? Have comparisons been made between the effects of reading a book with the effects of other self-help books on similar topics or use of other formats such as audiovisual material, and, if so, what are the results? (I am not aware of any study that compares client free choice of reading material with counselor-selected material in terms of effectiveness. This would be an interesting study.)

7. Is there any evidence that positive changes last? If so, over what period?

8. Has the possibility of negative effects been explored (e.g., a decrease in hoped-for outcomes and/or a worsening of disliked outcomes)?

9. Does contact with a therapist enhance effects?

10. Is bibliotherapy more effective for certain kinds of problems/people than with others?

As with any claim, we should carefully examine the extent to which it has been critically tested. For example, is there any evidence that reading a book about how to make and keep friends or how to improve your grades yields hoped-for outcomes? Many manuals have not been examined under conditions of intended use. In addition, subjects used in studies may differ from target populations, thus altering potential effectiveness. Follow-up studies are also vital—how long do positive effects last if they occur? In 1997 Cuijpers reviewed six small, short-term randomized controlled trials of bibliotherapy involving 273 participants recruited by ads who had mild depression. He reported a mean effect size of bibliotherapy of .82; 79% of participants in the control group had a poorer outcome compared to the average participant in the bibliotherapy group.

A meta-analysis of 70 bibliotherapy studies by Rick Marrs indicated a positive effect for bibliotherapy. This meta-analysis involved a total of 4,677 participants. Bibliotherapy was defined as “The use of written materials or computer programs, or the listening/viewing of audio/videotapes for the purpose of gaining understanding or solving problems relevant to a person’s developmental or therapeutic needs.” Only those studies were included that had a comparison group drawn from the same population as participants receiving bibliotherapy. The 79 studies included 2,315 subjects who participated in bibliotherapy, 455 who received a therapist-directed therapy (without bibliotherapy), and 1,907 who were in control groups. The studies averaged about 57 subjects each and retained 88% of participants through the posttreatment measurement. The average age of people involved in these studies was the mid-30s, and participants tended to be well educated. Problems addressed included anxiety (e.g., test anxiety), assertiveness, indecision about career, depression, impulse control (e.g., alcohol use, smoking), self-esteem–self-concept concerns, sexual dysfunction, study problems, and weight loss. The individuals in the bibliotherapy groups met with a therapist for an average of about 36 min per week, length of bibliotherapy averaged about 212 pages, and time spent in treatment averaged 6 weeks. Most studies (84%) used random assignment to a comparison group, and 80% used a book for the written material. Forty-eight percent of the studies used samples from a college population, and 39% used participants solicited from general adult populations. Thus, most of these studies did not involve clinical populations. The mean estimated effect size of the 70 samples analyzed was +0.565 indicating moderate effectiveness. The authors reported no signif-

icant differences between the effects of bibliotherapy and therapist-administered treatments and no significant erosion of effect size at follow-up. Bibliotherapy methods appeared to be more effective for certain kinds of problems such as assertion training, anxiety, and sexual dysfunction than for concerns such as weight loss, impulse control, and studying problems. The amount of therapist contact during bibliotherapy did not seem to be associated with effectiveness. However there was an indication that increased counselor contact resulted in better effects for some problem types such as weight loss and anxiety reduction.

Other follow-up studies of the effects of bibliotherapy have also yielded positive effects. For example Nancy Smith and her colleagues examined the effects of cognitive bibliotherapy for depression and found that treatment gains had been maintained at 3-year follow-up. Positive effects were also found by Jim White in his 3-year follow-up of the effectiveness of STRESSPAC. STRESSPAC is designed as a self-help package for people with anxiety. It is a 79-page booklet that includes a four-page introduction, handout, and a two-sided relaxation tape—one for rapid relaxation and the other for deep relaxation. The booklet is divided into information and treatment sections. The former section contains information on the nature of anxiety, describes different kinds of anxiety disorders, gives case histories, as well as information related to the causes and maintenance of anxiety. The intervention section is divided into four sections including controlling your body (progressive relaxation), controlling your thoughts (cognitive therapy based on the work of Beck and Meichenbaum), controlling your actions (emphasizing the importance of exposure to anxiety-producing cues and other behavioral advice) and, last, controlling your future (a relapse prevention information section).

VI. CASE ILLUSTRATIONS

Robert Gould and his colleagues compared the use of bibliotherapy involving minimal counselor contact in the treatment of panic with guided imaginal coping and a wait-list group. Changes assessed included frequency and severity of panic attacks, perception of ability to deal with panic attacks, and level of depression and avoidance. Participants in the bibliotherapy group ($n = 12$) were requested to read *Coping with Panic: A Drug-Free Approach to Dealing with Anxiety Attacks* over a 4-week period at their own pace. This book includes information on educating readers about the causes and

nature of panic disorder; describes a variety of cognitive and behavioral strategies including relaxation, cognitive restructuring, breathing retraining, and exposure; and advises readers how to use these strategies. It describes cognitive strategies such as exploring faulty logic, reconsidering attributions, exploring alternatives, decatastrophizing, and hypothesis testing. Participants were informed that reading the book was designed to help them deal better with their panic attacks and that they would be contacted at weeks 2 and 4 by the researcher to assess their progress in reading the book. Calls lasted about 10 min; a written protocol was followed, and callers were coached not to answer questions about any particular reader's program. Rather, participants were questioned to see if they were reading the book and to check their progress. The authors reported that, overall, participants in the bibliotherapy group were more improved than were participants in the wait-list group and were not significantly different from those in the individual therapy group. Participants in the bibliotherapy group and the individual therapy group had greater self-efficacy ratings and improvements in confidence in coping at posttest than participants in the wait-list group and did not differ from each other. Seventy-three percent of the participants in the bibliotherapy group showed clinical improvement compared to 67% of those in individual therapy and 36% in the wait-list group. Clinical improvement was defined as at least a 50% decrease in all symptoms of panic attacks. However, the authors reported that anxiety sensitivity was still high on posttest and there were no statistically significant differences between participants in the wait-list group and participants in the other two groups in the frequency and average severity of panic attacks. The authors noted that participants in this study were well educated and highly motivated. Thus, similar effects may not be found with poorly motivated clients.

George Allen compared group and self-administered relaxation training and study counseling. Twelve participants used a programmed text designed to enhance relaxation and effective study skills. The text described the same content as that discussed during the group meetings. In addition, readers of the text were asked to complete a check list of methods used during the week. One other contact was held with each individual in the self-help group. In this session participants were asked to discuss future applications of the material. In another self-administered condition, the same rationale was offered, however participants received a programmed study counseling text. Participants in both

self-administered groups received instructions in carrying out a functional analyses of their study behavior and were given forms to carry this out on a daily basis. Results suggested that both self-administered programs were as effective as counselor-provided help. Both programs were equally effective in reducing anxiety and improving grades, and both were significantly better than no treatment.

VII. SUMMARY

Bibliotherapy has been used to pursue a wide range of goals including educating clients, decreasing anxiety and depression, enhancing social contacts, and developing study skills. There are different kinds of bibliotherapy. One utilizes self-help materials designed to guide the client through assessment and/or intervention in relation to hoped-for outcomes such as losing weight or developing more effective study behaviors. Another kind requests clients to read fictional materials or poetry to attain certain outcomes. Yet another encourages readers to read spiritual literature. Many different formats are used and Internet-based material is likely to increase in use. An advantage of bibliotherapy is allowing people to achieve desired changes on their own, although some writers point out that use of self-help manuals still ties consumers to therapists because therapy "experts" are often the authors. Potential positive effects of bibliotherapy include acquiring skills that can be applied to other areas. For example, if a parent learns to use positive reinforcement with one child, she may use this with her other children as well. In addition, positive effects found at follow-up (e.g., White's finding of the maintenance of effects over a 3-year period), suggest that clients who cannot obtain access to services right away can benefit from bibliotherapy material that can be provided immediately, and this may provide as much help as seeing a counselor.

Dangers of ineffective self-help materials suggested by Gerald Rosen include an increase in hopelessness and helplessness when desired outcomes do not occur, neglect of other methods that might be successful—such as consulting a clinician—and a worsening of problems. One potential negative effect of bibliography is encouraging the belief on the part of clients that change is impossible because bibliotherapy did not work, when, in fact, change would occur within another format, perhaps including more contact with a counselor. Programs that are successful when presented

by a counselor may not be effective when self-administered. Review of self-exposure treatment for anxiety indicates that brief initial contact with a counselor is an important motivator for some individuals. Another possible negative side effect is excessive discomfort in the process of change due to lack of expert guidance. Although prescriptive advice offers guidelines (which may be more or less clear) about what to do, it may not provide the motivation to act on this advice. For example, knowledge about helpful rules does not provide the motivation to act on these rules. Not carrying out instructions is a common problem in self-change programs.

Self-help books may foster incorrect views about self-change and how it can be accomplished. They may obscure sources of influence over valued outcomes which decreases the likelihood of attaining desired goals. Self-help books may encourage unhelpful views of “the self” (e.g., as the seat of all change). They may encourage a dysfunctional focus on the self and on one’s problems or encourage the unrealistic view that life should be without problems. Encouraging a focus on the self may increase depression in people who already focus too much on themselves. Self-help focuses on the individual who is attempting to alter personal behavior, thoughts, or feelings to attain specific goals. Individual change, however, is but one level of intervention. Many other levels may be required to attain valued outcomes such as losing weight or decreasing anxiety or depression. The focus on self-help may obscure the role of political, social, and economic factors that influence many of our behaviors that we try to alter through self-change and thus exaggerate the potential we have to alter our behavior and related environmental influences on our own. Consider stress for example. Many stress-related factors are environmental such as a decrease in civility, high noise levels, and hours spent on crowded, smoggy freeways. The fundamental attribution error (overlooking environmental causes of problems and focusing on dispositional causes) is common and is encouraged by a focus on the self.

A key concern for future research is the rigorous testing of claims regarding the effectiveness of bibliotherapy in relation to particular outcomes. Given the possible rationing of counselor availability and indications that bibliotherapy can be effective and/or contribute to positive effects at low cost, it is certainly worthwhile to pursue research in this area. The effectiveness of bibliotherapy methods should be enhanced

by taking full advantage of empirical literature describing components of effective self-change efforts and making sure other information provided is accurate.

See Also the Following Articles

Art Therapy ■ Assertion Training ■ Biblical Behavior Modification ■ Education: Curriculum for Psychotherapy ■ Functional Analytic Psychotherapy ■ Minimal Therapist Contact Treatments ■ Self-Help Treatment for Insomnia

Further Reading

- Allen, G. (1973). Treatment of test anxiety by group administered and self-administered relaxation and study counseling. *Behavior Therapist*, 4, 349–360.
- Cuijpers, P. (1997). Bibliotherapy in unipolar depression: A meta-analysis. *Journal of Behavior Therapy and Experimental Psychiatry*, 28, 139–147.
- Gambrill, E. (1992). Self-help books: Pseudoscience in the guise of science? *The Skeptical Inquirer*, 16, 389–399.
- Gould, R. A., Clum, G. A., & Shapiro, D. (1993). The use of bibliotherapy in the treatment of panic: A preliminary investigation. *Behavior Therapy*, 24, 241, 252.
- Marrs, R. W. (1995). A meta-analysis of bibliotherapy studies. *American Journal of Community Psychology*, 23, 843–870.
- Montgomery, P. (2001). Media-based behavioural treatments for behavioural disorders in children. *Cochrane Database Systematic Review*, (2):CD002206. (Latest version 16 February 2001).
- Norcross, J. C., Santrock, J. W., Campbell, L. F., Smith, T. P., Sommer, R., & Zuckerman, E. L. (2000). *Authoritative guide to self-help resources in mental health*. New York: Guilford.
- Pardeck, J. T. (1998). *Using books in clinical social work practice: A guide to bibliotherapy*. New York: Hawthorne.
- Rosen, G. M. (1981). Guidelines for the review of do-it-yourself treatment books. *Contemporary Psychology*, 126, 189–191.
- Smith, N. M., Flourney, M. R., Jamison, C. S. & Scogin, F. (1997). Three-year follow-up of bibliotherapy for depression. *Journal of Consulting and Clinical Psychology*, 65, 324–327.
- Starker, S. (1989). *Oracle at the supermarket: The American preoccupation with self-help books*. New Brunswick, NJ: Transaction.
- Watson, D. L., & Tharp, R. G. (1997). *Self-directed behavior: Self-modification for personal adjustment* (7th ed.). Pacific Grove, CA: Brooks/Cole.
- White, J. (1998). “STRESSPAC”: Three-year follow-up of a controlled trial of a self-help package for the anxiety disorders. *Behavioral and Cognitive Psychotherapy*, 26, 133–144.

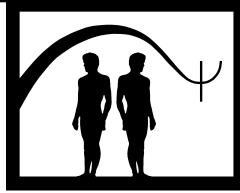

Bioethics

Everett K. Spees

Devereux Cleo Wallace

- I. Background
 - II. Scope of the Article
 - III. Concepts of Ethics and Morality
 - IV. Case Analysis
 - V. Conclusion
- Further Reading

GLOSSARY

agent A human subject capable of making and acting on a moral choice. Synonymous with “moral agent.”

autonomy A question central to the work of Immanuel Kant. An independent and self-legislative stance taken in making moral judgments in the domain of justice. Emile Durkheim stated that autonomy requires the willingness to do one’s moral duty because reason commands it, and not from any external constraint. The demands and ideals of morality are willingly complied with as necessary for participating in a desirable and fulfilling collective life. Teaching children rational autonomy by explaining the reasons behind social rules and obligations is more effective than educating through indoctrination or preaching. He considered it to be the third goal of moral education after discipline and attachment to the group. Heteronomy is the antonym of autonomy.

bioethics A formidable expansion of medical ethics dating to the 1960s when the introduction of new medical technologies such as hemodialysis, kidney transplantation, reproductive control techniques, life support equipment, and the definition of brain death, introduced new and difficult ethical choices for medical personnel, patients, institutions, managed care organizations, and at the level of social

policy. The evolving role of bioethics has been to examine critically the moral ramifications of contemporary medical and scientific procedures, the criteria and responsibilities for decision-making responsibilities, and their implications on societal expectations and social policy. Since these contemporary medical and scientific procedures are widely publicized in the mass media, and may become generally available, the ethical discussions have involved a cross-section of the general public as well as physicians, scientists, journalists, philosophers, theologians, and sociologists.

collective norm Defines what is expected from group members qua group members in their attitudes and in their actions. For example, community group members care about each other and do not steal from each other. For a collective norm, the group members constitute its affiliative constituency. A universal affiliative constituency would include all of mankind. The typical collective norms of a community uphold the intrinsic value of community, and include caring, trust integration, participation, publicity, attachment to community, and collective responsibility.

ethics (Greek *ethos*—character) Often used interchangeably with morality, for example, professional ethics and personal morality. Ethics is generally accepted as being broader than morality, and includes some areas outside morality. Aristotle wrote that Ethics was a branch of politics because it was the duty of the statesman to create the best possible opportunity for the citizen (of a Greek *polis*) to live a good life. Ancient ethical theories all contained the understanding of obligation or moral duty, and this fundamental notion was reaffirmed in modern times by Kant (1724–1804), who held that virtue was secondary. He wrote, “By mere analysis of the concepts of morality we can quite well show that the principle of autonomy is the sole principle of ethics. For analysis

finds that the principle of morality must be a categorical imperative, and that this in turn commands nothing more or less than precisely this autonomy.”

moral reflection Re-visioning the environment or world as responded to by an ideal social system. When humans change their perception of the world or of moral quandaries through moral reflection, the process promotes favorable changing of their behavior. Assessment of moral reflection provides guidelines to classifying the level of moral sophistication of individuals and societies.

morality (*Latin mores—character, custom, and habit*) Morality concerns a narrower range of issues than ethics, focused on what we should do, and how we should live. A fundamental characteristic of morality is respect for oneself and others. Becker and Becker identify four specific characteristics that differentiate morality from the broader ethics term: First, morality makes a distinction of kind between moral and nonmoral reasoning. Second, morality makes a strict demand of responsibility, viz.; “ought” implies “can.” Third, duty or obligation represents a major moral precept. Fourth, morality assumes an essential concept of the noninstrumental good of others.

rationalization The process of thinking by which something immoral becomes transformed into something plausible.

social conventions Arbitrary norms that coordinate the activities of individuals in a social system, thereby serving the organizational goals of the system.

virtue The Latin term *virtus* and the corresponding Greek *arête* referred to all kinds of excellence. In contrast under ethical theory the moral virtues are generally narrowed to include courage, justice, wisdom, and self-discipline. More recently Michele Borba, in discussing how to build moral intelligence in children, added to this list the basic virtues of empathy, conscience, respect, kindness, and tolerance, to make a total of seven. More than 200 other virtues have been described in the literature.

*The life is short,
The art long
The right time but an instant,
The trial (of therapy) precarious,
The crisis grievous.*

*It is necessary for the physician to provide not only the
Needed treatment, but to provide the patient himself,
And those beside him, and for his outside affairs.*

Hippocrates
Aphorisms I

I. BACKGROUND

Psychotherapists need bioethics on a number of levels in the pursuit of their healing professions. Like our

North American society the psychotherapy disciplines are experiencing accelerated change unparalleled in human history. The last quarter century recorded vast changes in almost every area of life (communication, lifestyle, technology, social organization, physical and mental health, and religion) that have altered the perception of collective societal norms.

Behavioral health professionals and institutions have absorbed many seismic shocks as the tectonic plates of their paradigms have shifted. Shudders have been felt when the state mental hospitals were virtually emptied. This occurred as a result of national ethics debates about the rights of mental patients to autonomy and self-determination regarding hospitalization. The societal perception of mentally ill patients has radically changed. At the same time this movement overlapped the introduction of the first-generation tranquilizer drugs that largely replaced sedatives, hypnotics, and electroshock therapy. A new generation of psychoactive drugs was fully expected to one day permanently cure mental diseases. As a consequence of new drugs renunciation of paternalism toward the mentally ill occurred followed by the flight of the discharged state hospital patients to the streets, where they continue to form the core of the homeless. Few at that time grasped the notion that by rejecting paternalism this new social policy had actually caused harm (maleficence) while trying to effect social good (beneficence).

After this megashift in public policy the Darwinian economic rise and fall of private behavioral health facilities and private practices appeared, closely connected with the rise of bureaucratic restriction of behavioral health services and medications by managed care organizations (MCOs) that followed the Bentham-Mill utilitarian or consequential ethic. Psychotherapists had to rethink their accustomed psychotherapy practices under the harsh new scrutiny of MCOs' cost-conscious business rules. Meanwhile, second- and third-generation psychopharmacology agents appealed to the MCO utilitarian ethic as more economical than extended talking therapy.

As a result psychotherapists found themselves in an uncomfortable area between the conflicting imperatives of the patient and the MCO. Regardless of the therapist's theories and personal convictions about the care that was indicated for each patient, his or her treatment plans for patients could only be reimbursed if they were approved by the MCO. The developing theories of bioethics changed the perspective on the priorities of classical medical ethics and professional codes of conduct, giving the scientific and quantitative rational approach ascendancy over the prior humanistic and art-of-medicine approach. Subsequently the roles of the

psychotherapist have been forced to evolve to keep up with these new situations.

Changes in the practice of medicine and bioethics have also thrust the psychotherapist into newly reframed clinical ethics situations. During the 1960s many previously resolved issues were brought up for new public debate, including confidentiality, informed consent, truth telling, patient access to medical records, patient refusal of treatment, and end of life considerations. At the same time public debate engaged new technologies such as mechanical support of respiration, brain death, new reproductive technology, and organ transplantation. Psychotherapists regularly become involved in these bioethical issues in their practices. The dilemma in the field of psychotherapy involves the difficulty of defining and taking action on moral and bioethical issues that involve deciding between seemingly equally worthy conflicting values in mental health. But lest we feel overwhelmed, we might remember that the imposing twentieth-century ethicist W. D. Ross in 1939 cautioned against underestimating the natural value of our own moral character when he said, "The moral convictions of thoughtful persons are the data of ethics just as the sense-perceptions are the data of natural science. Moreover acts are either right or wrong, whereas motivation and character are either good or bad."

Former United States President Lyndon B. Johnson captured the contemporary ethical challenge in a nutshell. According to White House advisor Joseph Califano, one of Lyndon Johnson's favorite sayings was, "It is not doing what is right that is hard for a President, it is knowing what is right."

II. SCOPE OF THE ARTICLE

This article will briefly address the development and ramifications of bioethics in the health sciences, with particular emphasis on the profession of psychotherapy. Brevity requires the perspective be restricted to that of the Western industrialized societies. A case example will illustrate some commonly encountered mental health bioethical problems. The glossary complements the text with definitions of terms and concepts that could not be fully developed in this brief article.

III. CONCEPTS OF ETHICS AND MORALITY

Ethics may be broadly defined as the principles of moral behavior by individuals and by society. What are

one's duty to others and the duties of others to oneself? Many philosophers consider ethics to be a broader philosophical term than morality, to include political philosophy such as national and international policy making. Nevertheless some ambiguity exists in the current use of these terms.

Professional bioethical principles emphasize truth telling, client self-determination, and informed consent (autonomy), doing good for the patient (beneficence), avoiding harm (maleficence), and acting with justice (fairness). It is, however, deceptive to believe that every complex clinical ethical concern should be reduced to fit a narrow principled classification without sacrificing significant clinical issues of each case.

In 1996 a major conceptual breakthrough in the role of morality in bioethics was contributed by James Rest, who, after reviewing hundreds of contemporary professional publications on morality, concluded that all future discussions of morality should center around four intrinsic measurable components: moral sensitivity, moral motivation, moral judgment, and moral character. By separately weighing these four components it becomes possible to identify distinctive patterns of morality in and during the course of individual human development. Moral philosophy research allows these components to be accurately described at a certain point or even objectively scored, over a person's lifetime. Moreover, by using this method of assessment previously problematic historical personalities could be profiled in a more precise common language.

For example, one could assess the level of each of the four moral components of, let us say, Adolph Hitler, Lieutenant Calley of My Lai, or Mother Teresa. We might conclude that Mother Teresa possessed all four components at high levels, while Adolph Hitler and Lt. Calley possessed adequate potential capacity for moral judgment but were deficient in the necessary moral sensitivity, moral motivation, and moral character, to behave morally. In addition these four moral components could be used to reclassify the moral themes in Homer's epics and Aristotle's *Nicomachian Ethics* that have so profoundly affected Western civilization.

At a more contemporary pragmatic level, using James Rest's components can aid us in bioethical areas by making meaning of the diversity of moral visions, accounts of moral obligations, rights, and values that confront us in our increasingly pluralistic society. Different ethnicities, but also religion, class, socioeconomic status, education, gender assumptions, and language, affect the context and perspective of all four moral components defined by Rest.

In 1996 Marvin Berkowitz amended classical Aristotelian ethics by giving a new definition of “the complete moral person.” His proposal is complementary to Rest’s four-component model. Berkowitz’s vision of “moral anatomy” included six elements or “objects”:

1. Moral behavior
2. Moral character
3. Moral values
4. Moral reason
5. Moral emotion
6. Moral identity

In addition Berkowitz clarified the roles of self-discipline and empathy as metamoral characteristics that serve to support the moral life models that operate in the field of moral psychology. He wondered how we might best educate the moral person in our society. He asked the related question of how contemporary parents and teachers might best model for their children, and suggested they use well-known components of (1) the just community, (2) character education, (3) dilemma discussions, and (4) love of the good.

Despite the established principles of bioethics and the helpful recent moral clarifications of Rest and Berkowitz, there is no general universal theory of secular bioethics agreed to by all, although more consensus exists within religious and cultural subpopulations (“moral communities”) that share values and moral assumptions. This diversity has been highlighted by the increasing internationalization of North American communities by the flood of new immigrants who share different ethnic and religious concepts of morality. As H. Tristram Englehardt states in *The Foundations of Bioethics, Second Edition*, “Bioethics is a plural noun ... there is a swarm of alternative ethics ready to give rise to a babble of conflicting bioethics.”

Nevertheless in the health sciences professions the four moral components of Rest, combined with bioethical principles, precedence, and careful case analysis, help facilitate our recognition, motivation, judgment, discussion, and action on moral and ethical issues we may personally encounter on a daily basis with patients, families, other professionals, and medical care policies, however different the moral backgrounds, assumptions, and communities may be.

Medical ethics relates to the classical fixed philosophical themes of the responsibilities of doctor and patient as generally perceived up until the 1960s, when a new cycle of technological advances such as dialysis, organ transplantation, and mechanical respirators gave

medical professionals unprecedented control over extending life. Advances in reproductive technology such as contraception, *in vitro* fertilization, stem cell research, and surrogate motherhood created frightening new moral dilemmas, and brought to attention the value-laden nature of medical decision making.

Advances in medical diagnostic technology simultaneously made laboratory data more reliable and quantitative, and refocused medical diagnosis away from the bedside and toward the seductive computer video-display terminal. After all, was not high technology a way of providing the greatest good (beneficence) to the greatest number of patients at the lowest possible cost (utilitarianism)?

Health scientists found that new philosophical and ethical concepts were needed to deal with advances that put the tools and decisions affecting life and death into the hands of both patients and professionals in radically different ways. In 1970 the emerging new medical ethical philosophy that dealt with the dramatic technical advances acquired the name bioethics, borrowing a term that originally referred to the philosophy of social responsibility to preserve the biosphere. Bioethics concerns itself with much broader philosophical and public policy questions than traditional medical ethics, such as “What are the limits of science,” or “What does it mean to be a human being.” Bioethics stresses not a set of rules, like the Hippocratic Oath, but a better understanding of new and changing issues.

A. Uniform Ethical Standards

Despite the lack of a universal secular ethical theory, as the need for uniform ethical standards for government-funded medical research emerged, health department officials contracted with private groups such as the Hastings Center to develop a national consensus for bioethical principles and a National Bioethics Advisory Commission. These advisory groups helped set standards for the National Institutes of Health grant review process as well as for local institutional review boards in medical centers. The post–World War II Nuremberg trials documents provided important precedents for these bioethical deliberations.

B. The Dawn of Professional Ethics

Philosophers from Homeric times (about 700–800 BC) and from subsequent Socratic and Hebrew periods (after 500 BC) to the present have wondered how to define what is good and what is bad, striving to identify some

first principle and define universal rules that describe morality and virtue.

Homer's epic *The Odyssey* and *The Iliad* comprise the first widely adopted treatises on ethics. They contained an encyclopedic account of ethics, morals, politics, virtues, and vices of ancient Greek society encountered in daily life, medicine, commerce, politics, religion, and war. The epics provide numerous positive and negative examples of every important area of individual and group human behavior. These epics as well as subsequent classics such as *Aeneid*, *Beowulf*, and *Canterbury Tales*, became the standard tutoring literature for Western ethical and moral teaching for many centuries afterward and continue to enrich our culture even up to the present day. The Judeo-Christian and Islamic Scriptures and commentaries record the long enterprise of faith communities' attempts to understand and codify the moral life, the meaning of illness and insanity, and their relationship with God.

During the classical period (fifth century BC) while early Athenian philosophers were inquiring and teaching by dialectic, the early ethical commitments of the healing professions were formulated in the writings of Hippocrates, a revered physician who practiced and taught medicine on the Greek island of Cos. We have the solemn Oath of Hippocrates to attest to that. In fact, the etymology of the term "profession" derives from such oaths, which were required of physicians, priests, soldiers, temple virgins, and political leaders. Hippocrates asserted that the medical professional must be a model of unimpeachable ethical behavior. Physicians should honor and sustain their teachers, and should model honesty, morality, and integrity in dealings with patients, their families, and other health practitioners. The physician should avoid intentional harm, and act to benefit patients. The value accorded to life was exemplified by bans on euthanasia and abortion. The three basic principles of Hippocrates could be summarized as competence, caring, and commitment.

Hippocrates extracted the oath, sworn by Apollo, from each of his medical students that they would never abuse their trust by criminal practice, sexual immorality, or disclosure of medical secrets. The act of taking an oath was a solemn commitment.

Unaccountably the Hippocratic Oath, while clarifying the expected relationship between physician, teacher, and patient, fails to provide for the moral reasoning behind any of the elements of the Oath. Very likely the moral rationale was taken to be obvious, or else the documents were lost. Curiously, the commitment to teachers is listed before the commitment to pa-

tients. The Hippocratic Oath shows an unconscious paternalistic prejudice by failing to mention today's favored priorities of patient autonomy and justice. Nevertheless, the Hippocratic moral and technical prescription for physicians was unprecedented in Greek medicine, and it heralded a new course for the practice of medicine.

Subsequent medical professional codes have included at least six key concrete elements or rules of the Hippocratic Oath, including

1. Respect for the dignity of persons and life itself
2. Avoiding willful harm (maleficence)
3. Doing good (beneficence) to clients
4. Maintaining integrity in relationships (honesty)
5. Responsible caring (empathy)
6. Responsibility to society (good citizen, husband, parent)

Two additional elements appeared in modern times, including

7. Respect for patient self-determination (autonomy)
8. Respect for justice (fairness)

The modern Western terms "medical ethics" and "professional ethics," as well as "attending physician," were coined by the eighteenth-century Thomas Percival, an English physician trained in philosophy. Percival founded one of the first departments of public health, advocated the abolition of slavery, and near the end of his life wrote the first such book in English, *Medical Ethics: A Code of Ethics and Institutes Adopted to the Professions of Physic and Surgery*, based on his experiences heading a committee assigned to write rules of conduct for an infirmary where a medical scandal had occurred.

Each human society generates a different ethical structure. The Chinese have quite a different ethical vision, based to a great extent on Confucian thought. Similarly Buddhist, Hindu, African American, Native American, and other communities have distinctive philosophical and ethical traditions.

C. Meaning of Profession

Although the classical understanding of profession was associated with schooling and training that lead to taking a binding oath dedicating one's life and honor to a socially important vocation, in modern language the term "learned profession" preserves more accurately the classical concept of medicine, psychiatry, nursing,

law, and other vocations that assume rigorous selection of candidates, extensive formal education and training, difficult qualifying examinations, generous rewards, and a high degree of self-control through codes of ethics. Furthermore learned professionals are expected to work tirelessly for the good of society.

D. Ethical Standards after Completion of Professional Training

The new professional psychotherapist becomes aware that ethical concepts are embodied in the laws pertaining to many mental health professional and client matters. Bioethics often resides in an enigmatic extralegal gray area.

Ethical questions shadow almost every activity in psychotherapy. The psychotherapy disciplines including individuals practicing psychiatry, psychology, social work, nursing, and pastoral care subscribe to a body of ethical traditions making the benefit of the patient the top priority. As a member of one of the psychotherapy disciplines, each member must also recognize responsibility to society, to other health professionals, and to family and self. Each modern profession's membership is expected to adhere to a set of principles, called a "Code of Ethics."

As an example the following principles, adopted by the American Psychotherapy Association, are not laws but standards of conduct that define the essentials of honorable professional behavior of the therapist who has completed the journey of professional training. The American Psychotherapy Association's "The Psychotherapist's Oath":

As a psychotherapist:

I must first do no harm.

I will promote healing and well-being in my clients and place the client's and public's interest above my own at all times.

I will respect the dignity of persons with whom I am working and I will remain objective in all relationships with clients and act with integrity when working with other professionals.

I will provide only those services for which I have had the appropriate training and experience and will keep my technical competency at the highest level in order to uphold professional standards of practice.

I will not violate the physical boundaries of the client and will always provide a safe and trusting haven for healing.

I will defend the profession against unjust criticism and defend colleagues against unjust actions.

I will seek to improve and expand my knowledge through continuing education and training.

I will refrain from any conduct that would reflect adversely upon the best interest of the American Psychotherapy Association and its ethical standards of practice.

This oath is a good starting point for the study of contemporary codes since it is the briefest of all the current psychotherapy codes. In comparison, the 1992 Ethical Principles of the American Psychological Association is more extensive, running to 32 pages.

For an even more comprehensive resource, the reader is directed to the American Medical Association's 1998 publication, *The Principles of Medical Ethics with Annotations Especially Applicable to Psychiatry*. This reference includes an appendix on "Guidelines for Ethical Practice in Organized Settings" and "Questions and Answers about Procedures for Handling Complaints of Unethical Conduct." This document includes a statement of the skeletal AMA ethical code that is then fleshed out with explicit discussions of each point in the code as it relates to contemporary issues in psychotherapy. The appendices include ethical standards and problems in health care organizations, as well as a detailed guide to the making and answering of allegations of unethical professional behavior. The full text of these and other codes for psychiatrists, psychologists, social workers, family counselors, school counselors, and social workers may be found through Internet links at the Canadian Counseling Association web site (<http://www.ccacc.ca/coe.htm>).

Although a code of ethics cannot guarantee ethical behavior, resolve all ethical issues or disputes, or fully develop the richness and complexity involved in working to make responsible choices within a moral community, it does set forth normative values, ethical principles, and ethical standards to which professionals aspire and by which their actions can be judged. The Hasting Center Reports, found in most medical libraries, are an excellent reading source for ongoing debates in bioethics.

IV. CASE ANALYSIS

The following case abstract and bioethical analysis illustrates considerations in working with an actual clinical bioethical scenario.

Crystal (a pseudonym) is a 14-year-old white female only child who suffers from depression and oppositional defiant disorder. She is from a financially stable

middle-class family. She was admitted to an acute inpatient adolescent psychiatric unit for the second time in one month after making her fourth suicide attempt in 2 years. Crystal's mother is self-described as strict and controlling, and admits that consequences for Crystal's rule infractions at home may be excessive. Crystal's stepfather sides with her mother. There is gloom in the household about unusual multiple recent suicides by aunts and uncles. After 10 days, the maximum allowable inpatient time under her health care plan, Crystal voluntarily signs a discharge safety plan, and the unit staff team determines that she is ready to transition to an intensive step-down day hospital program, which she will attend from home. Unfortunately, the parents do not wish to have Crystal back home yet, and they angrily object to her discharge.

Shortly after Crystal arrives home she gets into an altercation with her parents. They call 911, the police arrive, and she is arrested and taken in handcuffs to jail. The mother then calls the attending psychiatrist, Dr. Barnes (a pseudonym), and asks whether Crystal can be readmitted as an inpatient. Crystal, her parents, and Dr. Barnes are suddenly faced with a number of uncomfortable bioethical issues.

A. Choosing a Case Analysis Method

Case analysis is a practical or "applied clinical ethics" method of identifying, analyzing, and resolving (if possible) the ethical values and issues in a clinical bioethics case. Bioethical problems arise when health care professionals, patients, and health care providers do not agree on values or actions, or when they confront dilemmas about the bioethically conflicting clinical choices available. Mental health care may present extremely difficult choices, as illustrated in this case history of an all-too-common scenario with adolescent clients. Each individual agent involved in the ethical encounter may be calling on the same or on different ethical principles, or on multiple conflicting principles.

The two case analysis approaches most often used in the United States are the principled ethics approach, also called the top-down or deductive; and the clinical ethics approach, also called the inductive, practical, or bottom-up approach.

B. Principled Ethics

The principled ethics analysis begins with an ethical principle such as autonomy or beneficence and then applies it to the case. This principleism is theoretical and can be rather abstract. For example, Tom Beauchamp and James Childress, in their *Bioethics* in 2001 empha-

size the essential middle level ethical principles of (1) autonomy, the patient's independence in deciding what is best; (2) nonmaleficence, avoiding harm to the patient; (3) beneficence, doing good for the patient; (4) justice, fairness to the patient; and (5) professional-patient relationship.

Engelhardt in 1996 points out some limitations of the principled approach: "It is not possible to justify a canonical content-full morality, right-conduct, or bioethics, in general secular terms. . . . The appeal to middle-level principles may succeed in bridging the gulf between those who share a moral vision, but are separated by their theoretical reconstruction of that vision. But it will not bridge the substantive gulf between those separated by different moral visions or different moral senses."

C. Clinical Ethics

In contrast, the clinical ethics approach to applied ethics is a bottom-up or inductive approach. It provides a structured method to help psychotherapists identify, analyze, and resolve clinical issues in psychotherapy. This alternative approach facilitates thinking about the complexities of the data in actual cases in a clinical setting that therapists face, rather than looking up answers in a resource book and trying to match patients to standard models. A patient care situation is considered comprehensively in detail first, and then the ethical principles that best relate to the case are identified and discussed. Albert Jonsen, Mark Siegler, and William Winslade in 1998 use this approach in their *Clinical Ethics*, as do Mark Kuczewski and Rosa Pinkus in 1999 in their *An Ethics Casebook for Hospitals*. Rather than beginning with ethical principles, these authors sort the facts and values of each case into an orderly pattern and then call on principles in order to facilitate the resolution of each bioethical problem. Their basic pattern includes four clinical topics and six or more conceptual subtopics that define the major elements from which the case ethics can be identified: (1) medical indications, (2) patient preferences, (3) quality of life, and (4) contextual features. They consider that these four topics provide adequate information to guide the clinician through the problem and that no case can be adequately discussed unless these topics guide the analysis. Jonsen and colleagues comment that this method helps clinicians understand where the moral concerns meet the clinical circumstances of the case.

The Beauchamp and Jonsen approaches are not incompatible, since each is an organizing device to ensure that the basic topics necessary for analysis are

fully considered in the process of pursuing a bioethically acceptable course of action. In fact, in the latest edition of their textbook, Beauchamp and Childress have come so far from principleism toward clinical ethics that one reviewer described it as “the beginning of the end of principleism.”

While the previously espoused principled ethics approach of Beauchamp and Childress is traditionally used for funded research protocols and medical casework, the clinical ethics approach of Jonsen and colleagues may be more intuitive for mental health casework and professional training.

The reader should be aware of caveats that apply to theoretical approaches such as those discussed above. The theories are not able to provide full moral guidance unless one supplies them in advance with a particular moral content. In other words, although we may accurately portray the clinical case history, preferences, outcome, and context, and identify middle level principles, as we attempt to do in the following case, we may find ourselves divided about the case analysis conclusions because of conflicting moral visions of the participants in the discussion.

If we hypothetically assigned different moral vision and ethnicity labels to the participants, this inconclusivity might be even more inevitable. When that occurs, resolving concrete moral bioethics controversies must rely on peaceable negotiation and agreement among parties in order to reach a resolution.

On this issue Engelhardt in 1996 commented that

Each theoretical approach recapitulates the challenge of post-modernity: a moral theoretical account must either beg the question with regard to moral content (i.e., incorporate particular moral content without justification) or give no substantive guidance. Each attempt to justify a particular moral vision presupposes exactly what it seeks to establish so that moral theoretical arguments are at best expository, not justificatory. Even if one attempts a defense of secular ethics or bioethics on the basis of arguments that are not reducible to intuitionist, consequentialist, hypothetical-choice, or hypothetical-contractor arguments, or analyses of the nature of rational choices or game theoretic rationality or natural law arguments or middle-level principles analyses, the arguments will fail as well. All concrete moral choices presuppose particular moral guidance.

D. Clinical Ethics Analysis of Case

1. Medical Indications

a. Medical and Psychiatric History. The developmental history given by Crystal's mother revealed that

from about age 1 Crystal would behave normally and then have apparently unprovoked several-week-long periods of depression, oppositional behavior, irritability, and difficulty with relationships. These episodes occurred about every 2 months. Whether other family problems might have been occurring at that time was not yet fully explored.

When not in the abnormal moods, Crystal seemed to be a bright and happy child. She enjoyed playing the piano, singing, and dancing, and made friends easily. She was a straight-A 10th-grade student, described by her parents as artistic, outgoing, and active in her church youth group. During the prior 2 years she had twice secretly taken large doses of analgesic tablets from the family bathroom medicine cabinet and ingested them without telling anyone, and without apparent physical harm. These incidents occurred at a time when several relatives and a friend of the family were creating a climate of grief in her family by unexpectedly committing suicide, so that a posttraumatic stress phenomenon or grief and confusion might have been factors.

Crystal occasionally experimented with alcohol or marijuana. One month before the present admission Crystal got high on marijuana with a boyfriend, and according to her, he succeeded in sexual intercourse over her protestations (her first sexual encounter). That night she went home and ingested a large number of analgesic pills from the medicine cabinet and superficially cut her wrists. Then she told her mother what had happened, and her parents took her to an emergency room where she required a number of sutures to close the wounds. Her mother reported the alleged date rape to the police, and an investigation is ongoing.

Crystal was referred from the emergency room for admission to the same mental health unit as for the current hospitalization. Her admission evaluation led to the diagnosis of two Axis One disorders, depression and oppositional defiant disorder, that were confirmed by history, observation, and psychological testing. She was started on the antidepressant Paxil, and participated in multiple individual and group therapy sessions that were part of the inpatient program. She seemed to the staff to be intelligent and mature. Her assigned writing assignments about her family and personal behavioral issues seemed thoughtful and appropriate. She gave correct answers about the measures she needed to take to be safe and to reduce disputes and disrespectful conduct at home. She was discharged after her encouraging progress and after signing a safety contract. Her parents made arrangements for continued psychiatric treatment as well as outpatient rape counseling.

Because of the worrisome sexual incident her mother set strict new limits on her activities after she returned from the hospital, including restricting her dating or driving in a car alone with males, and severely restricting her socialization with her friends. The restriction on peer socialization was particularly disheartening to Crystal, since one of her most valued privileges in life was “hanging out with my friends and just laughing and playing music and being myself.”

On the other hand, her mother perceived Crystal to be at risk because of “poor social skills,” especially in setting safe personal boundaries. Her mother stated that Crystal was “not safe at home.” These strictures and assumptions led to increasingly angry confrontations and more oppositional behavior on Crystal’s part, more tension at home, and eventually to Crystal defying her parents and making threats to kill her mother. Her coping skills so much in evidence in the hospital had diminished as her despair increased. On the evening of the most recent admission she became angry when her stepfather would not permit her to invite her friends over to visit. After an angry confrontation Crystal went into the kitchen where she deliberately cut her wrists with a paring knife, and thereafter was brought by her parents to an emergency room, where she was transferred again to the adolescent psychiatric unit.

As on her prior admission Crystal was a model patient from the moment she stepped inside the unit. She took responsibility for her actions, but explained that she was hurting herself superficially so that “my parents will hurt,” and not to kill herself. She knew that by cutting herself she would regain, from her viewpoint, the more tolerable and tolerant hospital environment.

Dr. Barnes, the attending child psychiatrist continued Crystal’s Paxil medication for depression, and added Depakote for mood stabilization. He met individually with Crystal daily, and held one family conference. Crystal also participated daily in unit activities and group therapy. Once admitted Crystal was able to make a contract for safety and was a model patient. During the one family session there was much conflict and mutual blaming between Crystal and her parents.

Dr. Barnes expressed pleasure with the progress Crystal was making in treatment, and arranged a plan for her follow-up treatment in day hospital after discharge. He received a call from the MCO that she had used the maximum 10 days allowed under her insurance plan. Against the objections of her parents, who felt that she was not ready to return home, Dr. Barnes discharged Crystal. Her parents drove her home.

At home, her mother, who was still incensed about her “premature” discharge, icily informed Crystal of

the strict new house rules including confinement to the house and no telephone or television privileges. Her mother hid all the telephones in the house, and disconnected the televisions.

When Crystal found there was no way to call her friends, shouts rang out. Fear and anger escalated. The parents phoned Dr. Barnes and blamed him for the altercation because he discharged Crystal against their objection. The mother threatened Dr. Barnes with a lawsuit.

While this phone conversation was going on Crystal became furious, grabbed a kitchen knife, and brandished it at her mother, who was talking to Dr. Barnes about Crystal on the phone. Crystal then put down the knife and began choking her mother. At Dr. Barnes’ recommendation the stepfather called the police; they arrived in a patrol car and handcuffed Crystal, drove her to the police station, booked her, and placed her behind bars for the night.

b. The Goals of Treatment. In this potentially suicidal and homicidal scenario the first goal is physical safety for the patient and her parents (nonmaleficence, avoiding harm to Crystal or her parents), initially by placing Crystal in jail. Additional important goals of treatment are for beneficence, helping Crystal and her parents by referral to a structured treatment program to improve Crystal’s anger management, and upgrade her coping, negotiating, and prosocial interactions with family members. The program should incorporate active family therapy work. Before returning home she needs to make a contract for safety and other mutual behavior with her parents (nonmaleficence, prevention of harm). She and her parents will need to arrange for an intensive treatment program to gain insight into and find a way to change the dysfunctional family culture (beneficence), seeing to the good of the family unit. The three family members need to restore mutual respect and find a degree of protection and personal boundaries for Crystal that do not unfairly restrict her freedom of self-determination, or autonomy, as she works to earn their trust. The parents need to recognize Crystal’s good behavior with earned privileges, an exercise of parental justice.

c. Probabilities of Success. The probabilities of success with a course of treatment for Crystal depend on how well the goals can be realized. Because each case of this type is unique, and the endpoint for “cure” so vague, statistical data are not available to estimate the prognosis. At this point in the crisis, Crystal and her family have not yet had a comprehensive biopsychosocial evaluation by a multidisciplinary team including a social worker,

pediatrician, psychologist, chaplain, education specialist, psychiatrist, and occupational therapist.

Critical unknown areas in our information about Crystal may affect the possibilities of success, including psychosocial development history, family relations, history of neglect or abuse, peer support system, school history, preferred recreation, sexual orientation, sexual experience and practices, experience with drugs, and career aspirations. Without a thorough evaluation it will not be possible to develop an optimal treatment plan. The treatment team owes an ethical responsibility to evaluate comprehensively and accurately.

The best prognosis in cases like Crystal's is realized with clients who have adequate health insurance, are capable of making a therapeutic alliance with the psychotherapist and the mental health staff, are willing to participate in family therapy, are faithful in keeping mental health appointments, and are compliant with prescribed medications. The parental participation and sometimes individual or group parental psychotherapy may be necessary to work toward a more optimal home situation.

Treatment failure occurs when irreparable damage to the treatment program occurs, for example, by the client attacking treatment staff, family members, or peers; running away; or being incarcerated, which would undoubtedly increase the chance of maleficence or harm to her personal safety and possibility of recovery. Conditions like Crystal's are often chronic and can be self-perpetuating when the young person's potential is jeopardized through alienation from family, friends, and community. Treatment failure also occurs when financial arrangements break down or when custodians remove the minor child from treatment against medical advice, resulting in maleficence. In case of therapeutic failure clinical circumstances might indicate termination of parental rights. The new guardian could then arrange placement in a relative's home, a foster home, or a residential treatment center. Treatment failure in some cases would lead to court-ordered incarceration because of parole violation or a new offense.

In pediatric cases like Crystal's the psychotherapist's responsibilities are the same as with an adult, to save life, relieve symptoms, and restore health. However, since a minor child is under the supervision of parents or guardians, they, not the patient or psychotherapist, have the moral and legal responsibility and autonomy of acting in the child's best interests, termed paternal beneficence. Their decisions must take into account the family values and the needs of other members of the family, the family budget, and other paternalistic considerations. These may override some of the minor

patient's preferences. Where the parent's or guardians' conduct or choices are apparently not in the best interest of the child, the courts, acting with paternalism, *in loco parentis*, may alter the extent of parental or guardian authority in order to provide remedial justice on the minor child's behalf. For the past few decades, the wishes and opinions of adolescents have been increasingly sought and taken into account for treatment decisions, since it is difficult to carry out a successful treatment plan without some cooperation and participation by the adolescent. A disgruntled adolescent might also bring a lawsuit after reaching majority in cases of disagreement about treatments and alleged harmful outcomes while a minor.

2. Patient Preferences

a. Crystal. Crystal is an intelligent and sensitive adolescent, a talented musician, and an outgoing, fun-loving social person. She says she would prefer to live at home, to keep her anger under control, and learn how to avoid escalation, thus ensuring nonmaleficence. She wants to continue to do well in high school and go on to college and a good career, eventually achieving autonomy. She would like to be able to recognize her dark moods and be better able to manage them. She would like to be able to negotiate with her parents, especially her mother, so that she could have a "win-win" home life and have plenty of socialization with her friends, which she sees as justice.

She realizes that she made a mistake in judgment with the boy who assaulted her, and she wants to keep wiser boundaries with boys and drugs in the future, ensuring nonmaleficence. Without question, the boy is accountable for his sexual misbehavior. The family has made a police report of the incident with no outcome as yet, practicing responsible paternalism, and seeking justice for their daughter.

Crystal is fully aware that if she fails to fully cooperate with a mental health program, receiving beneficence, she may end up a suicide, a murderer, or an inmate, thus experiencing unwanted maleficence and criminal justice. She appreciated what she learned about herself and others while hospitalized, and feels she could form a positive alliance and transference with Dr. Barnes if he is to treat her in the future, and help her realize autonomy. Crystal also knows that after her assault on her mother, her parents could press charges against her and have her put away for a considerable period of time, an unwanted criminal justice outcome.

b. Her Parents. Crystal's mother on behalf of both parents expresses the parents' preferences. The father

remains silent. They want Crystal to be respectful, to learn how to curb her anger and to obey the rules necessary for her safety and for their peace of mind, providing justice to each family member. They admit in retrospect that they may have erred by instituting rules the severity of which was excessive, and by doing so they vindictively conspired to make Crystal's misbehavior at home a self-fulfilling prophecy, resulting in maleficence, so that she had to be rehospitalized.

c. Dr. Barnes. Dr. Barnes preference is to play the Hippocratic deontological, or duty-based role. He wants to behave as the tactful, truth-telling, and competent child psychiatrist who skillfully helps his client and her parents gain insight and clarity about the psychodynamic and family issues, while respecting the dignity, worth, and ethnic and cultural values of each individual in the family. He wants to guide them into committing to an intensive and effective long-term treatment plan for Crystal that will make the most of her positive potentials, build her responsible autonomy, and make treatment failure as unlikely as possible, thus achieving clinical beneficence and nonmaleficence. Acting as an agent of change, he wants to help the family understand and take ownership in the big picture of what the benefits of a good outcome and the downside of a bad treatment outcome would mean for Crystal and for them, resulting in socially responsible self-determination, a well-informed family autonomy. He wants Crystal to share actively in the decision making about her therapy program and be accountable by taking her medications faithfully and for all the other intelligent cooperation of which he believes her capable.

d. Police. The police want to keep Crystal safe toward herself through paternalism and beneficence, and keep her from harming her mother or others (non-maleficence), until it is safe to reduce the level of restriction when she demonstrates responsible autonomy.

e. Managed Care Organization. The MCO prefers to keep Crystal safe and optimize her psychiatric treatment (paternalism, beneficence) but wishes to obtain the best care for her at a cost-effective rate, preferably in outpatient or day hospital in a facility with which they have a discounted contract. They will remind the psychotherapist of the limitations of treatment under the parents' health plan under motives of paternalism and contract justice, but their in-house medical gatekeeper and appeal committee do have a process under which legitimate exceptions may be awarded if more expensive care is justified by submitted evidence (distributive justice).

The MCO has to be financially prudent and accountable in order to stay in business, remain within budget, and make profits for the shareholders, exercising both autonomy and beneficence.

3. *Quality of Life*

a. Crystal and Her Parents. The quality of life for Crystal and her parents is poor at present, and will be until some resolution can be worked out to bring the family function and feelings under control. There may be biases that would prejudice the psychotherapist's evaluation of the patient's quality of life. This could relate to information not yet brought to light that may be necessary to fully understand Crystal's present and past behavior, and that of her parents. For example, what was the situation leading to her mother's divorce from Crystal's biological father, and how is that affecting all parties now? Have events or relationships at school or with friends added to her present difficulties? Might any of these factors jeopardize her recovery "from out of the blue?" Where is she to live, where will she go to school, and what will she do with her life? Both Crystal and her parents currently do not feel safe or peaceful.

If treatment succeeds, Crystal may still experience cyclic periods of depression and interpersonal conflict, unless a cause can be discovered and remedied. It is possible that adjustment of her medications could ease those problems, but there is no guarantee that she will not have to endure this instability the rest of her life, thus avoiding maleficence. There is also a high likelihood that she will continue to have conflicts with her mother in the future over control issues such as paternalism and autonomy.

Crystal's parents want to improve their quality of life by having a tolerable family interaction, and by seeing Crystal keep her personal boundaries with them, with her friends, and especially with boys. They know she is intelligent and talented, and their quality of life and peace of mind will be enhanced by her success in school and in society, realizing autonomy and beneficence. They would like her to eventually gain her independence and use it wisely so that they would no longer have to feel responsible for her daily welfare and future, once they have resolved issues of paternalism and autonomy. Overall they want to act responsibly in the best interest of their child to achieve beneficence.

b. Dr. Barnes. Dr. Barnes would like the family to start working more effectively to bring peace (beneficence) and so that he would not have to deal with these recurring crises on the telephone when he is at home with his family (nonmaleficence, autonomy, justice).

4. Contextual Features

a. Family Issues. Family issues may affect Crystal's treatment decisions, such as the parents' anger, resentment, assumptions, and fear about Crystal, and the obligatory paternalism. Their family finances are sufficient currently; however if her stepfather lost his job, his insurance might be lost at some point, and Crystal could lack funding for her treatment program and prescription drugs, which would be a serious maleficence for her. The present psychotherapist and adolescent psychiatric program might be unable to treat Crystal if her health insurance were to change or her stepfather were transferred out of state, or if she were to have a court-ordered incarceration.

There are no apparent religious or cultural factors with the family or treatment personnel that currently affect care, and in fact, Crystal's religious participation is a positive factor if it can be maintained and reinforced, providing beneficence. There is no compelling reason to breach confidentiality in Crystal's case, or refrain from truth telling, thus promoting beneficence and autonomy.

There are no current legal charges since Crystal voluntarily cooperates with treatment, and has apparently not yet been charged with violating any laws, aiding nonmaleficence for Crystal. This could change if her parents press charges for the assault incident, which would not be possible to rebut; however, they appear to want to put this incident behind them. No clinical research or teaching is involved at this point (autonomy).

There is no provider or institutional conflict of interest at this point in the case. Dr. Barnes is pleased with the cooperation he has received from the MCO on behalf of his patient, Crystal, resulting in beneficence and justice for her.

Because of limitations of space the role and perspectives of the social worker, chaplain, teachers, and unit mental health staff are not given separately in the brief case account; however, their professional participation has been essential in the management of these bioethical issues.

While winding up our thoughts about context in clinical ethics we might profit from reflecting on the larger philosophical societal questions. How would the contextual nature and ethical issues of this case be different if the child psychiatrist were a Palestinian or Afro-American Muslim or an Orthodox Jew? What if the client and her parents had been newly arrived Hindu or Ethiopian Coptic immigrants? What is the goal of mental health treatment in our society? What are the ends of technology and pharmacology, and where will they take us in

the next decade? What is the future of bioethics? How much mental and behavioral pathology could we prevent by improving healthy attachment, security, and character building within the family, school, and peer social environment? (See Borba's work in 2001 and Lickona's research in 1983 on this important issue.) What are our special duties to adolescent sexual assault victims? (see American Academy of Pediatrics, Committee on Adolescence, 2001, and Care of the adolescent sexual assault victim, <http://www.aap.org/advocacy/releases/juneassault.htm>).

E. Case Analysis Summary

In the foregoing clinical case analysis procedure, although too condensed to include all the professionals involved, most of the known clinical details have been identified and discussed, and bioethical issues and principles have been identified. Areas of incomplete clinical information have been noted. In this complex polyethical problem-solving process the Solomonic challenge is to understand the interests, moral assumptions, and intensity of each party's issues, estimate the competency of each party, and keep focused on the optimal outcome for the client. The clinical ethics process attempts to resolve moral dilemmas without the use of force by seeking agreement among parties or peaceable negotiation.

The data can now be used for a variety of clinical needs. In any case the analysis is saved as a record in case of future need, discussed within the institutional professional staff's regular staff meetings, placed on the schedule for discussion in a periodic institutional ethics committee meeting, or submitted to the institutional risk committee or malpractice insurance carrier. An addendum should be added to the analysis to record the further use made of the analysis.

The case analysis may also be used as the agenda for an interdisciplinary meeting of all responsible parties. For example, if the client struggles with bioethical issues in the care given or the choices for future care, the clinical case analysis gives a framework for consideration and discussion, especially to help the client or other responsible parties to understand the ethical choices as well as the treatment choices, and who has the authority to make the choices of autonomy, beneficence, nonmaleficence, and justice. In the case of this adolescent the watchword of prudence is always to ask, "Who speaks for the best interests of the child?"

Three additional professional integrity issues not discussed in the text or case analysis should be mentioned. The first concerns ethics regarding colleagues such as co-workers, supervisors, and supervisees. In these relationships therapists should always be expected to keep the best interest of the client in mind, avoid boundary infringements, avoid personal conflicts of interest, and meticulously respect confidentiality. Such considerations are especially relevant to team relationships. This means keeping team roles clear, being mindful that a healthy milieu is the best treatment vehicle, being aware of transference, not acting out in colleague relationships in a way detrimental to clients, not exploiting supervisees, not “dumping” cases, keeping educational objectives in mind, keeping track of what may come up about being responsible for the training of students, and keeping track of the potentially unhealthy side of mentoring.

The second issue concerns the ethical use of the “special knowledge” of psychotherapy and the rhetorical power of expert language. The theoretical frameworks and special vocabulary of psychotherapy can be used to elucidate issues, and to teach important ideas and skills that are helpful to clients. Unfortunately they can also be used to enforce a power differential for the power/control/expertise/status needs of the therapist, which can be damaging and disabling for clients. The latter is a problematic, unethical use of our professional skills and status.

The third issue concerns the ethics of using the special intimacy of psychotherapy for personal gratification. It is safe to say that what makes a therapeutic relationship therapeutic is that it exists for the benefit of the clients, and for their growth and achievement of confident autonomy. The therapeutic relationship is not for meeting the personal needs of the therapist. The therapist uses aspects of herself or himself in service of the professional work, and that needs to be the priority. This is an area in which damage and retraumatization of clients can easily occur, and as professionals, psychotherapists need to set clear standards and hold one another accountable.

V. CONCLUSION

Bioethics and the clinical ethics case analysis approach presented here may help the psychotherapist to formulate and achieve the goal of every professional. That goal is to know what is right and to do

what is right for the patient, even in complex and ethically conflicted cases. In order to know and do the right thing as often as possible, the professional not only needs to pursue competence in ethical philosophy and clinical bioethics, but the professional needs to be as complete a moral person as possible. The professional's personal moral anatomy needs to be intact so that ethical issues are seen with sensitivity and handled with beneficent motivation. This moral sensitivity and motivation focus keen moral judgment and reflection on the problem. In the final step the necessary moral action can be carried to its completion through the agency of virtuous character effecting agreement among members of controversies or peaceable negotiations as the way to resolve concrete moral controversies.

Acknowledgments

This article could not have been completed without the impeccable assistance of Ms. Pam Roth, research librarian at Presbyterian/St. Luke's Medical Center in Denver, Colorado, and the assistance of my family.

See Also the Following Articles

Alternatives to Psychotherapy ■ Biblical Behavior Modification ■ Collaborative Care ■ Confidentiality ■ Cultural Issues ■ Documentation ■ Economic and Policy Issues ■ History of Psychotherapy ■ Informed Consent ■ Legal Dimensions of Psychiatry ■ Supervision in Psychotherapy ■ Working Alliance

Further Reading

- Aly, G., Chroust, P., & Pross, C. (1994). *Cleansing the fatherland. Nazi medicine and racial hygiene*. Baltimore: Johns Hopkins University Press.
- Aristotle. (1956). *The ethics of Aristotle. The Nicomedian ethics*. Translated. London: Penguin Classics.
- Beauchamp, T. L., & Childress, J. F. (2001). *Principles of biomedical ethics, Fifth edition*. New York: Oxford University Press.
- Berkowitz, M. W. (1996). The complete moral person. In J. M. DuBois (Ed.), *Moral issues in psychology. Personalist contributions to selected problems* (pp. 11–41). St. Louis: University Press of America.
- Borba, M. (2001). *Building moral intelligence. The seven essential virtues that teach kids to do the right thing*. San Francisco: Jossey-Bass.

- Dalai Lama. (1999). *Ethics for the new millennium*. New York: Riverhead Book.
- Engelhardt, T. H., Jr. (1996). *The foundations of bioethics. Second edition*. New York: Oxford University Press.
- Fromm, E. (1947). *Man for himself. An inquiry into the psychology of ethics*. New York: Henry Holt.
- Jonsen, A. R. (1990). *The new medicine and the old ethics*. Cambridge, MA: Harvard University Press.
- Jonsen, A. R., Siegler, M., & Winslade, W. J. (1998). *Clinical ethics. Fourth edition*. New York: McGraw-Hill Health Professions Division.
- Kuczewski, M. L., & Pinkus, R. L. B. (1999). *An ethics casebook for hospitals. Practical approaches to everyday cases* (pp. 197–202). Washington DC: Georgetown University Press.
- Kuhse H., & Singer, P. (1998). *A companion to bioethics*. Blackwell Companions to Philosophy. Malden, MA: Blackwell Publishers.
- Lickona, T. (1983). *Raising good children. From birth to the teenage years*. New York: Bantam Books.
- May, W. F. (2000). *The physician's covenant. Images of the healer in medical ethics. Second edition*. Philadelphia: The Westminster Press.
- Rest, J. R., & Narvaez, D. (Eds.). (1994). *Moral development in the professions. Psychology and applied ethics*. Hillsdale, NJ: Erlbaum.

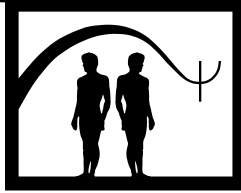

Biofeedback

Doil D. Montgomery

Nova Southeastern University

- I. Description of Treatment
 - II. Theoretical Basis
 - III. Applications and Exclusions
 - IV. Case Illustrations
 - V. Summary
- Further Reading

GLOSSARY

alpha wave activity EEG activity generally associated with an alert but relaxed state, usually defined as 8 to 12 Hz.

anal sphincters The anal canal is surrounded by a voluntary or external (EAS) and an involuntary or internal (IAS) anal sphincter.

autogenic phrases A series of phrases developed by Shultz and Luthe to induce a relaxed state. The phrases are directed toward three domains: relaxing the major muscles in the body, warmth and heaviness in the limbs, and quieting the mind.

autogenic training The application of a list of phrases to induce a self-generated state of relaxation. Typically lasts 10 to 20 minutes and used by the individual once or twice daily.

beta wave activity EEG activity associated with an alert state, often defined within the range of 16 to 20 Hz.

biofeedback A technique in which a biological process is measured and information about that process is provided to the person being measured. The information must be contiguous with the biological event.

biofeedback facilitated relaxation training (BFRT) A biofeedback technique where any of several physiological events are being fed back to the individual to help the person to

learn deep levels of relaxation. The physiological events are usually one or more of the following: EMG, SCA, finger temperature, heart rate, or respiration rate.

bladder training A strategy used for urge incontinence whereby clients increase the intervoiding interval to normalize voiding frequency and increase functional bladder capacity.

diastolic blood pressure (DBP) Minimum blood pressure during relaxation of heart or during cardiac cycle.

dynamic EMG feedback Multichannel EMG feedback during different body postures and simulated tasks.

EEG biofeedback A type of biofeedback that measures the brain waves. Both the frequency and amplitude of the waves are of interest. There is also some interest in measuring the phase relationship between different sites. Most applications used for biofeedback are based on a quantitative analysis of the brain waves called QEEG. The most frequent used technique is the fast Fourier analysis.

electrodermal A general term for the electrical activity or potential of the skin. Includes skin conductance, skin resistance, and skin potential.

electroencephalography (EEG) The measurement of the electrical activity of the brain.

electromyography (EMG) The use of instruments to measure the electrical activity of skeletal muscles.

EMG biofeedback A type of biofeedback that measures the electrical activity of the muscles. The strength or amplitude of the signal is directly proportional to the degree of contraction of the muscles being monitored.

finger photoplethysmograph Instrument that measures the amount of blood flow passing through a finger.

finger temperature biofeedback This type of biofeedback measures the temperature of the fingers. Although finger temperature varies with many factors including air temperature, it

has been shown that at typical room temperature finger temperature covaries with general arousal. The fingers are warmer when a person is relaxed and cooler when stressed. Finger temperature is a relatively slow changing event with typical changes being less than 2 degrees per minute.

frontal EMG A general and common term referring to EMG of the forehead and adjacent areas. Commonly used in biofeedback facilitated relaxation training (BFRT).

galvanic skin response (GSR) A form of electrodermal activity. Older term but still accepted.

GSR/EDA biofeedback A type of biofeedback that provides information about the activity of the sweat glands. Several different terms are used in the literature to describe this type of feedback. The most frequent are galvanic skin response (GSR) and electrodermal activity (EDA).

heart rate Number of heart contractions per minute.

heart rate biofeedback A type of biofeedback that measures the interval between heart beats and converts that time to a number representing the number of beats per minute if that time interval was maintained for a minute.

hertz (Hz) Unit of frequency equal to cycles per second (cps).

paretic muscles Slight or incomplete paralysis of a muscle.

power spectrum Advanced method of analyzing electrical signals, especially the complex waveforms of the EEG. Provides frequency and amplitude components.

progressive muscle relaxation (PMR) A common type of muscle and general relaxation developed by Edmund Jacobson. Starts with tensing and releasing specific muscle groups and progresses to discriminating between tension in selected areas and relaxation in others, and eventually to releasing muscle tension without tensing.

respiration biofeedback A type of biofeedback that measures the number of breaths taken per minute. Various instruments and sensors are used to determine the interval between each inhalation and/or exhalation to determine breaths per minute.

respiration rate Number of breaths per minute. Normal range is between 8 and 15. Slower rates (6 to 8) are associated with relaxation.

relaxation-induced anxiety (RIA) A state of apprehension, discomfort, or unease experienced by some who are trying to achieve a state of general relaxation.

sensorimotor rhythm (SMR) An EEG rhythm recorded from the central scalp, usually defined as 12 to 15 Hz.

systolic blood pressure (SBP) Maximum arterial blood pressure during cardiac cycle.

theta wave activity EEG activity generally associated with a drowsy, nonattentive state, usually defined as 4 to 8 Hz.

volar surface Palm side of fingers.

while providing the client with feedback that is sensitive to small changes in physiology. The feedback signal needs to be informative to the client. It is also important to provide instructions to the client about proper interpretation of the feedback signal. The clinician should emphasize the role that learning to change the physiology plays in the client's condition. There also needs to be generalization of the learning to the client's home, work, and social environments. In some instances, the feedback may even be entertaining. The entertaining type of feedback is often used when providing feedback, especially QEEG biofeedback, to children. In these instances, the feedback is not only informative but provides an incentive to the client to change physiology in order to "play" such games as putting puzzles together.

The utilization of biofeedback techniques is somewhat unique in psychology and psychotherapy as the techniques have applications that are used by several other health care specialties. The techniques are also used to treat conditions beyond those traditionally considered the domain of psychology. These conditions have been primarily the domain of medicine and rehabilitation. Some examples of these conditions are tension and migraine headaches, hypertension, urinary and fecal incontinence, muscle paralysis, and Raynaud's disorder.

A brief history of the development of biofeedback is warranted in order to appreciate the diversity of applications it presently enjoys. The early work in biofeedback stems from a controversy in learning theory. This difference is between instrumental, or operant, and classical conditioning, with classical conditioning occurring in the autonomic nervous system and instrumental conditioning in the skeletal muscle system. A student of Neal Miller's, Leo Di Cara, was in 1967 one of the first to publish research on the laboratory demonstration using an operant paradigm to alter heart rate. Miller and Di Cara used an elaborate procedure of injecting curare, to block skeletal muscular involvement of heart rate changes, and then rewarded the rat with electrical stimulation in the pleasure center of the brain when the heart rate reached a predetermined threshold, for either raising or lowering the heart rate. With this procedure, they were able to demonstrate shaping of the heart rate based on the change that was being reinforced. They also measured other autonomic responses, such as intestinal motility, to demonstrate that the changes were specific to the system being shaped, not general autonomic changes.

The other significant research effort that initiated the early systematic study of physiological self-regulation

I. DESCRIPTION OF TREATMENT

The clinical application of biofeedback requires the accurate measurement of various physiological processes

(biofeedback) was the conditioning of the brain waves known as alpha and theta. These brain waves have been associated with low levels of arousal and it was thought that if individuals could be trained to increase the amount of these brain waves they would increase the feelings of relaxation.

This early research prompted the development of the professional group known as the Biofeedback Research Society (BRS). This organization's goal was to promote research in basic processes of physiological self-regulation and its possible applications. As the clinical applications of biofeedback became available, the organization changed its name to the Biofeedback Society of America (BSA). Then later, as general assessment of physiological processes became useful in various areas such as sports, the organization again changed its name and is now known as, the Association of Applied Psychophysiology and Biofeedback (AAPB).

In 1980, AAPB funded the development of the certification organization the Biofeedback Certification Institute of America (BCIA). BCIA initiated the establishment of the minimal requirements for certification in biofeedback. These requirements included a degree in a health care field, minimal didactic training in biofeedback, supervised self-regulation training, supervised clinical experience, and the passing of their written and practical examination. In addition to the general certification, in 1997, the organization started certification in the specialty of EEG biofeedback. The requirements for the specialty certification in EEG biofeedback differ from those of the general certification.

The fact that biofeedback fits into the general orientation of behavioral therapy and the field now known as behavioral medicine has allowed therapists who offer biofeedback training to take an increasing role in the treatment of what has traditionally been conceptualized as medical conditions. It is now common to find medical clinics and hospitals with a biofeedback clinic as part of their operation.

Another area of interest in the development of biofeedback is the concept of stress and the discovery that stress plays a major role in medical disorders as well as psychological disorders. This knowledge has initiated the search for techniques that manage stress. One of the major techniques currently used to manage stress is relaxation therapy. Relaxation techniques are usually based on muscle relaxation, autogenic training, or breathing techniques. For many applications, the relaxation strategy alone is sufficient, but some individu-

als have difficulty with the technique and therefore biofeedback plays a role in making relaxation a concrete, observable process. In this application, biofeedback is used to facilitate the relaxation response. The biofeedback training allows clients to observe objectively their physiological changes as they try to relax. Their physiological changes provide immediate information informing them when their strategies are inducing a relaxation response or an arousal response. Biofeedback is also often helpful because many people mislabel their physiological states. For instance, they may think they are relaxed when they are not or when they become relaxed, it feels strange and uncomfortable, so they tense up again until it feels normal and comfortable. As an example, the muscles in the neck might be held in sustained contraction while the individual thinks that the muscles are relaxed. This sustained contraction will often lead to a tension headache. For these situations the biofeedback provides concrete, observable information that can help therapists educate clients about their misinterpretation.

The other major development that moved biofeedback forward was advances in biomedical engineering, with the major contributor to the miniaturization of the equipment being the National Aeronautics and Space Administration (NASA). The physicians working for NASA wanted to measure astronauts' physiology in space. In order to do so, they needed reliable and stable pieces of equipment that required minimal electrical energy to operate; therefore, they developed low power requirement equipment that is durable, reliable, small, and light in weight.

NASA has also benefited from biofeedback as one of the successful applications of biofeedback has been the prevention of "space motion sickness." Space motion sickness is similar to motion sickness here on earth. As the vestibular system becomes adjusted to the sensation changes from near zero gravity, most of the astronauts have feelings of nausea, light-headedness, and often vomiting. Medications are available to reduce the symptoms of motion sickness but there are side effects such as drowsiness and slowed reaction times. These side effects cannot be allowed since astronauts can take 2 to 3 days, or longer, to adjust. In the early 1970s Patricia Cowings, as reported by Cowings, Billingham, and Toscano in 1979, started working on a series of studies to determine if she could raise the motion sickness threshold. She used a chair, which could be rotated at controlled rates with varying degrees of tilt. With this chair, she could take anyone, spin him or her, tilt the chair back, and demonstrate the symptoms of motion

sickness. Although the speed and degree of tilt necessary to induce motion sickness will vary, everyone will become symptomatic. She carefully assessed motion sickness thresholds and then began using biofeedback combined with autogenics phrases to train subjects to raise their threshold for motion sickness. Her research demonstrated successful raising of the threshold and she was allowed to train some astronauts. The results of her training with astronauts were successful and the individuals she trained were able to control their symptoms without medication.

Biofeedback is unique among types of psychotherapy in that it requires the use of instrumentation and knowledge of anatomy and physiology; therefore, it is necessary to briefly present the basic aspects of the types of instruments used and the physiological processes measured by these instruments. This article is organized by a presentation of the instrumentation often utilized along with the basic physiology, followed by a presentation of the diagnostic categories treated by biofeedback. The major instruments to be discussed will be the electromyography (EMG), finger temperature, sweat gland activity (GSR/EDA), electroencephalograph (EEG), and pelvic floor disorder sensors.

A. Electromyography

The EMG is the electrical energy generated by the muscles when they contract. The EMG utilized in most biofeedback applications is not the same as the traditional medical EMG used to determine damage to the nerves of the skeletal muscles. The medical EMG typically uses indwelling electrodes and measures latency and amplitude of muscle activity following nerve stimulation, whereas the EMG used in biofeedback applications is usually measured by using electrodes placed on the surface of the skin over the muscles of interest. When specific muscle activity is of interest, concern must be given to placement of the electrodes because research by Lawrence and De Luca in 1983 has shown that the amplitude of the surface EMG is highly correlated with the level of contraction of the muscles when the electrodes are appropriately placed. The EMG is measured with three electrodes by a differential amplifier, which is designed to reduce unwanted electrical signals. With this type of amplifier, one electrode is a reference and the other two are active electrodes. The strength or amplitude is measured in microvolts and is averaged over some time period to provide a running average of the amount of muscle tension detected. This running average is then provided to the individual

being monitored as information about the amount of tension of a muscle system from moment to moment. (See Peek's 1995 research for further details). In many, but certainly not all biofeedback applications, the focus of the therapy is not specific muscles but muscle activity in a specified area such as the face.

When EMG biofeedback is used for general relaxation therapy, most therapists use the frontal placement. In this placement, the electrodes are placed parallel to the eyes, above the eyebrows, with the reference electrode in the center and an active electrode over each eye. The electrodes detect the activity of the muscles from all of the face when in this placement, according to Basmajian in 1976. When specific facial muscle activity is of interest, the use of small electrodes with proper placement will allow specific muscle activity to be measured. However, in the frontal placement, the interest is in general facial muscle activity because in order to facilitate general body relaxation, most people relax all of the muscles in their face. The rationale for this placement is based, in part, on the hypothesis that we tend to express our emotions in our facial musculature. Darwin provides us with some of this rationale in the 1965 version of his book *The Expressions of the Emotions in Man and Animals*.

Other applications of EMG biofeedback are to reduce specific muscle activity in the treatment of tension headaches, back pain associated with skeletal muscle hyperactivity, and other conditions of inappropriate muscle activity such as writer's cramps. EMG biofeedback is also used to recruit muscle activity, to aid in the rehabilitation of muscle paresis resulting from injuries such as strokes.

Because EMG biofeedback is frequently used to facilitate general relaxation, this procedure is presented as an application. The client is selected for this procedure based on a clinical interview. When the clinical interview indicates that the client would benefit from general relaxation, the rationale for frontal EMG biofeedback is provided to the client and permission to place the electrodes is obtained. The skin is properly prepared, the electrodes are attached, and the nature of the feedback is explained. It is proper procedure to then conduct what is referred to as a "behavioral test." The client is asked to tense a facial muscle such as the frontalis, by raising the eyebrows, or by gently biting down on their teeth. If the system is working properly, it will respond. For instance, when you say, "lift your eyebrows" and the client does so, the signal should increase in level, indicating that the person is properly attached and the system is working.

During the first session and if necessary in later sessions, it is good practice to conduct what this author calls facial muscle discrimination training (FMDT). This is a behavioral test in which the client is asked to tighten and relax the major muscles in the face. This is an effective training strategy as the client can see the EMG increase as the muscles are tensed and then decrease when relaxed. The clinician should then sequentially instruct the client in the following activities: frown and then relax, squint the eyes then relax, bite down just hard enough to feel tension in the jaw and relax. With each of these maneuvers, the client will see the EMG feedback signal increase and then decrease as he or she tenses and then relaxes the specific muscles. Having the client press the tongue against the teeth can also show the muscles of the tongue. The client is then asked to take one hand and make a fist. There should not be any increase in the EMG levels in the face and if an increase is observed, then displaced effort or dyspnoia is occurring. This means muscles that are not involved in performing the task are being contracted. If an increase in activity is noted, it is a good opportunity to educate the client about the displaced effort. The clinician can explain to the client that the electrodes on the forehead do not detect muscle activity in the arm, and therefore activity should not be noted when clenching the fist. Then, instruct the client to concentrate and relax the facial muscles while at the same time clenching the hand. If any activity is detected, have the client repeat this procedure. FMDT allows the therapist to teach the client about muscle activity and helps the client recognize that he or she may be using muscles that do not need to be used. This exercise also allows the client to feel a sense of control, that he or she can “do” biofeedback and change physiology. It is also good to point out to the client that the instrumentation detects muscle activity from all the muscles in the face but is unable to discriminate which muscle or group of muscles is causing the increase. Therefore, it is the client’s role to become aware of the muscles he or she tends to tense and to learn how to relax all the facial muscles when trying to achieve a state of general relaxation.

B. Finger Temperature

Finger temperature is measured by using an electrical device called a thermister. The thermister is an electrical component, selected because it changes its resistance to an electrical current proportionally over the range of temperatures of interest. Therefore, the temperature-monitoring equipment is designed to

generate a small electrical potential that is passed through the cables, leading to and from the thermister. The device measures the change in current flow as the thermister changes its resistance due to temperature changes. The amount of current is calibrated in degrees and most systems label the degrees in Fahrenheit. It is to be noted that unlike skin conductance systems, which pass a small electrical current through the skin between the electrodes, this system only passes electrical current through the thermister. The thermister is then placed on the surface of the area with the temperature of interest.

Because the thermister measures the temperature present at its surface, care must be exercised in its proper placement on the area of interest. For most biofeedback relaxation training applications, the thermister is placed on the surface of the hand, specifically the fingers. Although there is no research indicating a particular finger or place on the hand as a superior location for the thermister, most clinicians have a preference. The location of choice for this author is the volar tip of the little finger. The rationale that it is the smallest finger and therefore can gain and lose temperature faster than other fingers or areas of the hand. Because skin temperature is determined by blood flow and heat lost to the environment, the smaller the area, the quicker changes in blood flow will be reflected in temperature changes. The thermister has its own mass, so it too must be cooled and heated. Thermisters are available in various grades and sizes. The most desirable thermister is one small in size, so it can readily lose and gain temperature as the skin cools and heats. Most biofeedback equipment manufacturers will offer a choice in the quality of the thermister. Although there is no research available on the value of the quality of the thermister, there is research indicating that the more accurate the measurement and feedback, the better the learning of finger temperature regulation. Therefore, it seems prudent to use the best thermister available.

A consideration regarding the placement of the thermister is that it needs to make contact with the skin, without the holding device cutting off the blood circulation. The method of choice is to use paper tape. Tape the thermister to the skin by pressing down on the tape around the thermister. If using the finger tip, gently wrap the tape around the finger to keep the thermister in contact with the skin, without forming a tourniquet on the finger. The wire leading to the thermister needs to be taped along the finger, keeping the wire the same temperature as the skin. Otherwise, what is referred to as the stem effect will allow temperature changes of the

thermister to be determined by changes in the wire leading to the thermister. Once the thermister is in place, care must be used to make certain that the hand is not moved to a position where the thermister comes in contact with furniture, such as the arm of the chair or a desktop, as the temperature will then be altered by the temperature of the object that comes in contact with the thermister.

Finger temperature is thought to reflect general stress levels or relaxation levels. The stress response of the cardiovascular system is to reduce blood flow to our organs, so blood will be available to our striated muscles. Because the skin is an organ, when we are stressed, finger temperature will decrease and when we relax, finger temperature will increase. Finger temperature can vary in individuals in a normal room environment, usually around 70°F, from the high 60s to the middle 90s. Finger temperature is not the same as core body temperature. Very seldom will finger temperature be above 96° or 97°F because as the blood leaves the core of the body and goes out to the skin, it will cool from the core body temperature. The physics of heat is such that when blood is flowing into the skin, it takes time for that heat to permeate through the skin tissue and warm it and if you have reduced blood flow in the skin, then it takes time for the skin to lose the heat to the environment. There is usually a delay, 5 to 15 seconds, between blood flow changes, as measured by a finger photoplethysmograph, and the temperature changes detected by the thermister. Thus, finger temperature is a relatively slow-changing phenomenon.

Because finger temperature is a slow-changing event, its interpretation is best used as an indicator of general relaxation level, not as a measure of instantaneous physiological events. Finger temperature monitoring has been used as a treatment modality in several autonomic nervous system related disorders, such as Raynaud's, hypertension, and migraine headaches, because warming the hands through relaxation strategies has a powerful effect on the cardiovascular system.

C. Sweat Gland Activity

There are two types of sweat glands located in the human skin, the apocrine and eccrine glands. The apocrine sweat glands primarily respond to thermal regulation and the eccrine sweat glands tend to respond to emotionality or arousal level. Therefore, the eccrine glands are of interest in most psychophysiology and biofeedback applications. Eccrine glands have the greatest density in the palm of the hands, the volar sur-

face of the fingers, the bottoms of the feet and toes, under the arms, the groin area, and between the lip and the nose. The skin on the palms of the hands contains as many as 2000 eccrine sweat glands per square centimeter. This physiological response has one of the longest and largest research histories in psychophysiology. It is of interest because it is a measure of the activity of the sympathetic nervous system uncontaminated by the parasympathetic nervous system. With only a few exceptions, dual intervention of the sympathetic and parasympathetic nervous systems provides control over body organs, such as the heart, stomach, and salivary glands. One system increases activity while the other decreases activity, and thus the level of functioning is the difference in balance between the two systems. Through stimulation and lesion studies, the areas of central activation of sweat gland activity have been shown to be the brain stem, limbic system (involved in emotional regulation), basal ganglia, and Brodmann area 6 of the temporal lobe, according to Boucsein in 1992. The involvement of these neural anatomical sites provides users of electrodermal activity (EDA) with confidence of the basis of cortical and emotional influence on the eccrine sweat glands.

The eccrine sweat glands have a tubular that travels upward from the gland, through the tissue to the surface of the skin. This tubular has smooth muscle surrounding it and the sweat glands are activated when the smooth muscle opens this tube. Most biofeedback systems measure sweat gland activity by passing a very small electrical signal through electrodes placed on the skin. The opening and closing of the sweat gland causes changes in the resistance of the skin to the electrical current passing through the tissue. The strength of this electrical source is far below that which would cause tissue damage or be felt by the participant. Opening the sweat gland tubulars, which are filled with sweat (primarily a saline solution and good conductor of electrical current) causes a reduction in the resistance to the electrical current, so an increase in the amount of current will be observed. The amount of current flowing is normally measured in micromhos. The number of micromhos increases as emotionally or arousal increases. This technique is called skin conductance activity (SCA). Therefore, the measurement of SCA is actually the measurement of the opening and closing of the sweat glands.

The sympathetic nervous system controls the number of sweat glands opened. During low arousal levels a few sweat glands are open, whereas many sweat glands are opened at high arousal levels. It is speculated that this is an adaptive response as it allows better gripping

and reduces tearing of the skin under moderate to high arousal conditions. The relationship between the skin conductance level and the number of sweat glands activated is linear. For a more detailed presentation on the technique of sweat gland activity see Montgomery's 1998 work or Boucsein's 1992 research.

There are two methods used to measure sweat glands; both were discovered in the late 1800s. One method involves measuring the electrical potential generated by the smooth muscles that surround the tubulars when they depolarize, thereby opening the tubulars. This technique is called skin potential activity (SPA). Most biofeedback systems do not use this technique, so it will not be discussed further. The other method used to measure sweat gland activity is to pass an electrical current through the skin. This is called skin conductance activity. SCA used to be called the galvanic skin response or GSR. The term GSR is still found in current literature, but most use the term skin conductance activity. Skin conductance activity has two terms associated with it, skin conductance level (SCL) and skin conductance response (SCR). SCL is the average ongoing level or tonic level of sweat gland activity that decreases as you relax. If an arousing stimulus is perceived, it will cause a shift in arousal and a skin conductance response. The SCR is a momentary increase in conductance usually lasting a few seconds to a minute.

The sweat glands can change their activity based on a multitude of factors, but there are some interpretable ranges. The range of SCL readings for most biofeedback systems is from 0 to 100 micromhos, with the typical level being observed between 1 and 20. Although there is no conclusive data indicating an optimal level, the usual range for most "normals" is between 1 and 10 micromhos when the individual is relaxed and resting, or involved in a nonstressful conversation. Although the above ranges are helpful for interpretation, there are many factors that determine the SCA. Therefore, the clinician needs to know the individual being recorded and what is "normal" for that person. It is important to be aware that at the extremes of sweat gland activity, the SCA may be attenuated. If the skin is very dry, SCRs may be difficult to monitor and if the skin is very moist, SCRs may be reduced. In the clinical setting if dry electrodes are being used, and if the skin is very dry or callused then it is usually helpful to add a small amount of electrode gel to the electrodes. It is important to remember that the greatest clinical value of SCA during clinical biofeedback is not in comparing individuals, but in observing an individual's changes during sessions.

In summary, the manner in which the sweat gland activity can be conceptualized is that a gradual decline in skin conductance level will be observed as the person relaxes, until an asymptote is reached. The rate of decline varies from person to person and from time to time, but is generally related to how quickly the person is recovering from an arousing event. The decline in level is interrupted by curvilinear increases in conductance, which usually last a few seconds and are called skin conductance responses. These increases in conductance are associated with evoking stimuli, whether external or internal. External stimuli are stimuli that have arousing properties or are novel to the individual, whereas internal stimuli are thoughts that have arousing aspects associated with them. Although the amplitude of the SCRs is not typically measured in biofeedback applications, psychophysicologists measure them and there is an abundance of literature on the interpretation of them. A large body of literature clearly demonstrates that the response amplitude is proportional to the intensity of the stimulus that evokes the response, and this is important in biofeedback applications. For example, if a small electric shock is presented, a small response will follow. If a moderate electric shock is presented, a moderate response will be observed, and so forth. This relationship is very clear across various stimuli and under most conditions. This is important in biofeedback applications because if a SCR is observed, it can be inferred that something happened to change the individual's arousal level. If this change is not related to an external stimulus, such as talking, then the change in arousal level was likely the result of the individual's thoughts. When several SCRs are observed, it can be inferred that the individual is having trouble with intrusive internal dialogue. The idea that skin conductance responds to thoughts or internal dialogue, and not just to the presentation of external stimuli, allows the therapist and the client to observe the impact that internal dialogue has on physiological processes. However, it is necessary to emphasize that the skin conductance level cannot be overly interpreted because many factors influence the observed level. For example, food and medications that are sympathetic agents or central nervous system agents can change skin conductance levels.

D. Electroencephalogram

EEG biofeedback is the fastest growing area in biofeedback today. Part of this interest is due to the fact that changes in instrumentation hardware and software have provided the means to quickly perform mathematical

analysis of brain waves so that feedback about the EEG characteristics can be provided within fractions of a second after they are detected. However, recording the EEG is of great technical difficulty because the electrodes must be placed in the correct location while maintaining acceptable levels of impedance. Impedance is the electrical resistance between the electrodes and the skin and must be kept to a minimum in order to reduce unwanted electrical activity. The electrode placements are based on what is called the 10–20 international system, as described by Jasper in 1958. The 10–20 international system identifies positions on the scalp, which are directly over structures of the cortex. The details of electrode placement are beyond the scope of this article, but must be learned before attempting this biofeedback.

Neurologists interpret the EEG to determine abnormal brain function, as certain wave patterns are associated with brain disorders such as seizures. The EEG is also used to determine sleep stages. In most biofeedback applications, the use of the EEG is based not on the interpretation of the raw or unaltered EEG, but on the quantitative analysis of the EEG, called the QEEG. Mathematical analysis of the frequencies of brain waves determines the amount of each frequency occurring within a period of time or epoch. The mathematical analysis used in most applications is the technique based on the theorem developed by Joseph Fourier in 1822, called the fast Fourier transform (FFT). This is a mathematical routine or algorithm that takes each wave, determines its length in time as well as its amplitude, and then determines the average amount of energy in all the frequencies of interest. Computer systems today are capable of providing feedback about the QEEG characteristics within about 3/10 of a second after it is monitored. The results of this analysis can then be displayed on a computer monitor, allowing the individual to become aware of the nature of his or her brain waves. This occurs fast enough for the brain to alter its activity, according to its ability and the instructions provided the person.

The brain waves have information of interest in their amplitudes and frequencies. The frequencies were categorized into different bandwidths in the 1920s by Berger, and reported in 1929. He recorded the EEG activity from his children and labeled the EEG frequencies that he observed. These labels are still being used today although many are starting to abandon them, as they may be too restrictive. Four bandwidths (theta, alpha, sensory motor rhythm [SMR], and beta) are used extensively in clinical applications. Thus, they will be briefly described. Researchers are inconsistent in the frequency definitions of these bandwidths, so the reader must determine how

each author defines them in an article. However, they are usually defined as follows: Theta is 4 to 8 Hz, alpha is 8 to 12 Hz, SMR is 12 to 15 Hz, and beta is 16 to 30 Hz. Beta has been used to define a wide range of frequencies, so it is extremely important for the reader to determine the definition of this bandwidth in an article. The reason these bandwidths have been identified is that they are loosely associated with psychological states: Theta with drowsiness, alpha with nonfocused attention, SMR with muscle activity inhibition, and beta with focused attention. Although these associated states have some heuristic value for adults, they are not consistent across individuals or age ranges. The other important characteristic of the QEEG is its amplitude, measured in microvolts or picawatts. This is a measure of the amount of energy within each frequency or bandwidth. Presently, there are a few databanks available for normative and abnormal values of the QEEG.

The methods presently used in most clinical QEEG biofeedback applications are based on determining which frequency or bandwidth is of interest and then providing the individual with information about its activity either via a shift in frequency or amplitude. There are other techniques used to provide information about the EEG, such as hemisphere asymmetries and average evoked potentials, but their use, at this time, is not as widespread as amplitude or frequency-based applications. The clinical protocol for QEEG feedback for the treatment of attention deficit disorder/attention deficit – hyperactivity disorder (ADD/ADHD) will be presented later in the section Case Illustrations.

E. Pelvic Floor Disorders

The primary biofeedback applications in pelvic floor disorders are the treatment of urinary and fecal incontinence through the use of EMG biofeedback and specially designed sensors. This section will briefly cover biofeedback for urinary and then fecal incontinence.

Urinary incontinence is the inability to maintain control over urinary functions. The goal of biofeedback treatment is to alter both smooth and striated muscle activities related to bladder control. The following methods are employed: reinforcement of bladder inhibition, pelvic muscle recruitment, and stabilization of intra-abdominal and bladder pressures during the recruitment of pelvic floor muscles. In order to accomplish these goals, bladder pressure is manipulated and measured while simultaneously measuring pelvic floor muscle activity with EMG sensors. The EMG sensors are specially designed vaginal and anal probes.

Fecal incontinence biofeedback is similar, yet different from urinary incontinence biofeedback. Fecal incontinence is the inability to maintain control over bowel movements. During normal anal functioning, when a bolus of feces moves into the rectum, two sphincters are involved in keeping the feces internal. The internal sphincter, which is smooth muscle and controlled by the autonomic nervous system, relaxes. The external sphincter, which is striated muscle and controlled by the somatic nervous system, constricts. The constriction of the second sphincter is a conditioned response and prevents the feces from being eliminated. The internal sphincter along with the puborectalis muscle normally maintain the stored feces by staying contracted. During elimination, both sphincters and the puborectalis muscle are relaxed and the contraction of the smooth muscles around the large colon and rectum provides the force to move the stool through the anal canal. Muscle weakness, injury to muscles in this area, or loss of temporal conditioning can cause fecal incontinence.

A medical examination is necessary to determine if biofeedback treatment is appropriate. If the results of the examination indicate that biofeedback is appropriate, then a probe that uses balloons is used in the biofeedback treatment.

The commercially available probe has three balloons attached to it. The pressure in the balloons is displayed on a monitor or polygraph record so the individual can observe changes in the pressure, as the manipulation of the walls of the rectum is accomplished by inflating the most internal balloon with air, causing a pressure wave that simulates feces moving into the rectum. The two other balloons are positioned on the probe to measure the contraction and relaxation of the internal and external sphincters. When proper sequencing of the internal and external sphincters occurs, the internal sphincter will relax, causing a decrease of pressure in the middle balloon, and the external sphincter will contract, causing an increase in pressure in the external sphincter balloon. When an inappropriate sequence is observed on the display, this is pointed out to the individual and instructions on what the display should look like is explained so the individual can then try to exert deliberate control of the sphincters. This feedback combined with instructions has proven effective in changing the patterns of sphincter contraction, allowing the individual to regain control over elimination. This technique usually requires only a few sessions for the individual to recondition a natural sequence so that no further symptoms are manifested.

II. THEORETICAL BASIS

Although some have conceptualized biofeedback as a technique without a theoretical basis, it is plausible to conceptualize the biofeedback process within a learning model of classical and operant conditioning. As mentioned earlier, one early development of biofeedback was based on a controversy between classical and operant conditioning. A parsimonious way of explaining clinical biofeedback is to postulate that both classical and operant processes are evoked in most clinical applications.

The operant portion of clinical biofeedback is that the information provided by the system is a consequence of the behavior. With proper instructions, individuals will perceive the feedback signal that changes with the physiology as reinforcement and will perform to bring the reinforcing stimulus into their environment. This is especially clear when a signal is contingent on the individual obtaining a predetermined level of the physiology. An example is when temperature feedback is being provided and a tone is turned on when the finger temperature reaches a defined temperature. The operant model is also obvious in QEEG feedback applications with children, where it is common for the biofeedback system to accumulate points when specific criteria are met. These points may be converted into reinforcements such as money or the opportunity to participate in a desired event.

The classical model is being utilized when clients are asked to imagine previous events that have a relaxing emotional memory associated with them. In this case, the relaxing imagery is the unconditioned stimulus (UCS) and the present situation is the conditioned stimulus (CS). This may seem like backward conditioning, but it is not in that the present situation is ongoing and the imagery is then placed temporally into the ongoing event, which places it, in time, after the ongoing event.

III. APPLICATIONS AND EXCLUSIONS

In order to present the disorders treated with biofeedback techniques, Table I was developed. Any listing of disorders must be taken as only a guideline as it is always biased by the interpretation and experiences of the author. The presentation should not be taken as all-inclusive or exclusive of any particular application. Although some applications appear well established by controlled outcome studies of clinical effectiveness and

cost-effectiveness, others are based on repeated single-case studies or multiple studies with relatively small sample sizes. Additionally, some applications are based on the clinical literature and the clinical experience of the author. For ease of interpretation, in Table I the listing of disorders treated with biofeedback is divided into three categories. The categories are A = well established; B = multiple research support, but not enough to firmly substantiate the application; and C = promising but not established at this time.

This section will present the biofeedback techniques used to treat the disorders listed in the category of well-established treatments. For information on the disorders in the other categories, except seizure disorders, see Schwartz's 1995 work.

A. Attention Deficit Disorders (All Types)

There are multiple studies that have shown QEEG biofeedback to be a successful treatment for attentional problems. These studies are based on the rationale that individuals with attentional problems generally have more slow waves in their EEG than individuals who do not have attentional problems. Therefore, the protocol requires the reduction of slow waves, either theta or alpha, while increasing faster waves, such as SMR or beta. The protocol for EEG biofeedback treatment of ADD/ADHD will be presented in the section Case Illustrations.

B. Anxiety Disorders

The biofeedback techniques primarily used in the treatment of anxiety disorders are frontal EMG, finger temperature, SCA, and heart rate feedback. These modalities are used to train a deep state of relaxation. The clinician can then use the deep state of relaxation as an incompatible response to the anxiety state. Although specific biofeedback such as heart rate might be used for a cardiac phobic, the most widely used technique is to train on the most active modality, based on the individual's ability and the clinician's experience.

C. Asthma

The asthmatic attack is caused by the constriction of the upper bronchial tubes, which restrict the passage of air in and out of the lungs. These tubes are dilated by the sympathetic nervous system and constricted by the parasympathetic nervous system. The link between

TABLE I
Selected Disorders Treated with Biofeedback Techniques

A	B	C
ADD/ADHD	Dyschezia (anismus)	Dysmenorhea
Anxiety disorders	Esophageal spasm	Hyperfunctional dysphonia
Asthma	Forearm and hand pain from repeated motion syndrome	Mild to moderate depression
Chronic back pain	Hyperhidrosis	Phantom limb pain
Diabetes mellitus	Insomnia	Tinnitus (associated symptoms)
Essential hypertension	Nocturnal enuresis	
Fecal and urinary incontinence	Specific seizure disorders	
Fibromyalgia	TMJ or MFP	
Irritable bowel Syndrome	Writer's cramp	
Motion sickness		
Muscle rehabilitation		
Raynaud's disorder		
Tension and migraine headaches		

Note. A: well-established; B: multiple research support, but not enough to firmly substantiate the application; C: promising but not established at this time.

biofeedback and this disorder is through facial muscle relaxation and correct diaphragmatic breathing. Facial muscle relaxation has been shown to reduce resistance of airflow in both asthmatic children and healthy adults. The rationale is through a demonstrated link between facial muscle relaxation and the trigeminal-vagal nerve. Following facial muscle relaxation training, reduced resistance to airflow has been observed for several hours. It is believed that this effect can be generalized and sustained over days.

D. Chronic Back Pain

The use of biofeedback facilitated relaxation training (BFRT) and specific muscle retraining have been shown to be successful in treating chronic back pain. When BFRT is used, it is often combined with specific

muscle feedback. The specific muscle feedback therapy is based on the finding that some chronic back pain is caused by hyperactivity in specific muscles of the back and neck. This pain may be the result of a unique learning history, in which hyperactivity was inadvertently reinforced, or after an injury in which protective muscle activity becomes maladaptive and the hyperactivity results in pain.

E. Diabetes Mellitus

Diabetes mellitus is caused by the dysregulation of insulin produced by a malfunctioning of the pancreas. Because insulin regulates the amount of glucose available to cells, this disorder has serious consequences for life expectancy. The traditional management of diabetes is lifestyle changes through education, diet, and physical exercise along with hypoglycemic medication. The role biofeedback plays in the management of diabetes is through stress reduction techniques with biofeedback-facilitated relaxation training. The BFRT techniques reported in the literature have been frontal EMG training and finger temperature training, usually combined with some form of general relaxation training such as PMR or autogenic phrases. This application helps to stabilize and reduce insulin demands.

F. Essential Hypertension

There is substantial research on the treatment of essential hypertension with biofeedback. Studies show that frontal EMG, finger temperature, SCA, and direct blood pressure feedback have all been used successfully. Most of the research supports combining the biofeedback with some relaxation strategy such as progressive muscle relaxation, or autogenic training. Although direct blood pressure feedback might seem superior because it is straightforward, the research does not support it as a treatment of choice, as the other techniques generally reduce blood pressure more than direct blood pressure feedback.

G. Fecal and Urinary Incontinence

Biofeedback treatment of this disorder is presented in the section Case Illustrations.

H. Fibromyalgia

Fibromyalgia is characterized by generalized muscle pain, fatigue, headaches, and insomnia. Although

there is debate about the nature and diagnosis of this condition, it will be assumed it is a unique disorder and that after its diagnosis there are treatments that have been helpful. The biofeedback techniques used to reduce the symptoms of this disorder have been frontal EMG biofeedback and in some instances, specific muscle biofeedback training.

I. Irritable Bowel Syndrome (IBS)

IBS is manifested in about 8 to 19% of the population and is associated with symptoms of abdominal pain, constipation and/or diarrhea, and gas. About 85% of those with IBS have an increase in symptoms when experiencing stress. Therefore, the treatment of choice is relaxation therapy and research has shown that relaxation therapy combined with finger temperature biofeedback is the most effective. Although more direct forms of feedback have been tried, such as colonic motility sounds, rectal feedback using rectal balloons, and feedback of the electrical activity of the lower gut, these techniques have not proven effective and at this time are not used in general practice. The biofeedback is usually combined with client education about the relationship between stress and symptoms.

J. Motion Sickness

Motion sickness was discussed earlier, but will be briefly presented here as well. Cowings and her colleagues, starting in the 1970s, conducted the early work in this area. They used physiological feedback of SCA, finger temperature, and heart rate along with autogenic training to train individuals to increase their threshold for motion sickness. She published many controlled outcome studies and was finally given permission to train some astronauts. The individuals she trained were capable of preventing space motion sickness during their space flights without medication. She successfully extended this work to high-performance jet pilots.

K. Muscle Rehabilitation

EMG biofeedback is used to monitor specific muscle activity in order to facilitate recruitment of muscle activity in hypoactive muscles and to reduce muscle activity in hyperactive muscles. The primary role of EMG biofeedback in paretic muscles is to allow the individual to know that some recruitment of muscle activity is being generated even though it may not be

enough to cause movement. EMG biofeedback therapy allows the individual to know he or she is correctly activating the muscle but not enough to cause movement, as then the slightest increase in effort is detected by the instrumentation. Any minor successes can be used to build further recruitment until enough activity is generated to cause observable changes, which can then be built into functional movements. For hyperactive muscles, the technique uses specific muscle feedback to reduce inappropriate and sustained muscle contractions.

L. Raynaud's Disorder

There are several outcome studies that demonstrate that the biofeedback treatment of choice for this disorder is finger temperature combined with autogenic training. Along with biofeedback, lifestyle changes are also recommended. These changes include avoidance of sympathetic nervous system stimulants, such as caffeine and nicotine; stress management techniques; and the avoidance of low-temperature experiences, such as holding ice drinks and picking up frozen objects.

M. Tension and Migraine Headaches

There is a wealth of outcome research demonstrating that these two disorders can be effectively treated with biofeedback techniques. For tension headaches, BFRT, with placements of the EMG sensors in the frontal location, combined with general relaxation techniques, such as PMR has been shown to be effective. Utilization of specific muscle feedback of the muscles of the face, neck, and cervical area has also proven effective. This author recommends the combination of frontal EMG feedback, PMR, and specific muscle feedback of the face, neck, and cervical area. The muscles selected for the feedback are determined by a dynamic EMG assessment.

For biofeedback treatment of migraines the treatment of choice is finger temperature feedback combined with a relaxation technique, such as autogenic training. For those clients unresponsive to the finger temperature feedback, usually frontal EMG feedback will be effective. Based on the outcome research, biofeedback should be the treatment of choice for children who suffer from migraines.

N. Exclusions

When considering clinical biofeedback for an individual, the following basic requirements must be met: The individual must be able to tolerate the application of the sensors; the individual must be able to under-

stand the instructions regarding the relationship between his or her physiology and the feedback signal; the individual must be motivated to change physiology, using the feedback signal to facilitate this process; and finally, the individual must be motivated to practice what he or she has learned in the clinic in his or her everyday world.

There are also cautions and contraindications for the use of clinical biofeedback. First, a determination must be made that a more appropriate intervention, such as an immediate medical treatment rather than biofeedback therapy, is not warranted. An example of this is that an individual may be suffering from the recent onset of headaches caused by an aneurysm. In this situation, providing biofeedback as the only treatment would not be sensible, as a surgical intervention may be needed. Although there is little literature on contraindications for psychological states, logic indicates that in certain psychological conditions, biofeedback should not be considered the treatment of choice. These conditions include psychological states such as severe depression, uncontrolled schizophrenia, delirium, and depersonalization. Caution or special considerations should be employed when the client has the following conditions: impaired attention, dementia, mental retardation, or if the client is taking medications, as the medications may need to be adjusted as therapy progresses.

Therapists should also be aware that some individuals might experience what is being referred to as relaxation induced anxiety (RIA). Although little systematic information is available on the incidence of this in clinical practice, it is of concern as some individuals feel a strong sense of apprehension when a deep state of relaxation is induced. These individuals often report disturbing cognitions, feelings of loss of control, depersonalization, and strange body sensations. For these individuals, it is necessary to gradually train them in moderate levels of relaxation until they can tolerate and enjoy the benefits from deep states of relaxation. For further information on cautions and contraindications see *Standards and Guidelines for Biofeedback Applications* published by AAPB in 1992, and Schwartz's 1995 work.

IV. CASE ILLUSTRATIONS

Because of the diverse areas of applications of clinical biofeedback, instead of case examples, two general clinical protocols will be presented. The two clinical protocols selected for presentation will be the protocol for biofeedback facilitated relaxation training (BFRT) and for QEEG feedback for ADD/ADHD. These protocols reflect the two

major strategies of clinical biofeedback applications: biofeedback for relaxation purposes and a specific biofeedback training technique based on specific physiological levels that are related to the diagnostic category.

A. Example of a BFRT Protocol

When using BFRT, it is first necessary to determine if the client would benefit from such therapy. General relaxation may be helpful in a variety of conditions and it may also be useful as an incompatible response during such procedures as systematic desensitization. BFRT normally takes between 8 and 20 sessions, depending on the acquisition skills and the distress level of the client before and during therapy. After determination of the need for BFRT, the therapist must explain the rationale for biofeedback therapy, outline the basic aspects of the physiological processes that will be trained, and discuss the potential benefits and risks of the training. This author recommends conducting the first BFRT session with frontal EMG feedback, while monitoring other modalities such as finger temperature, SCA, and/or heart rate. The therapist may also find it beneficial to monitor additional physiological events that are connected to the specific conditions being treated. During the first biofeedback session, facial muscle discrimination training should be demonstrated and the client should be provided time to use his or her relaxation techniques to reduce frontal EMG levels. The therapist should monitor the other modalities during the session to observe the changes that occur as the client tries to reduce frontal EMG levels. An example of the value of monitoring other modalities is that by observing SCA, it can be determined if the client is engaging in arousing internal dialogue by noting if several SCRs are observed. If so, the therapist can interrupt the session and suggest a change in strategy by the client. During the interruption, the therapist should ask the client what strategy he or she is using and then encourage him or her to select a different strategy, such as diaphragmatic breathing or changes in imagery. The most responsive modality is usually selected as the target of therapy after frontal EMG levels are acceptable.

B. Example of a QEEG Feedback Protocol for Treatment of ADD/ADHD

One of the applications of QEEG biofeedback is with children who are diagnosed with ADD/ADHD. These children have been shown to have more slow waves, such as theta and alpha, and fewer fast waves, such as SMR and beta, in their EEGs than non-ADD/ADHD

children of comparable age, according to Monastra and colleagues in 1999. The biofeedback technique provides QEEG therapy for ADD/ADHD children and trains for a decrease in theta or alpha and an increase in beta or SMR, while simultaneously keeping facial EMG levels at an acceptable level. The specific protocol requires a QEEG assessment to determine which specific bandwidth and microvolt levels will be trained. Several studies have been published that clearly demonstrate that the EEG patterns change according to the direction of training and that clinical improvements are observed with successful training. The number of sessions necessary is usually 40 to 60, depending on how quickly the EEG changes and the amount of behavioral improvements observed. It takes the brain longer to learn to control its own processes than body organ systems; therefore, the number of sessions needed for this protocol is greater than that typically required in most biofeedback applications. An additional reason for the greater number of sessions needed in QEEG biofeedback may be that we do not know how to best train the brain to change its functioning.

V. SUMMARY

In order to be effective in the clinical application of biofeedback, there must be a measurable physiological process that can be monitored with existing technology and feedback about the process must be provided with enough resolution and speed to allow the individual to obtain volitional change of the physiological event. Then, this change in physiology must alter the physiological processes causing the targeted disorder. In some instances the relationship between the monitored physiological event and the disorder is obvious, such as finger temperature for Raynaud's disorder; for others, such as BFRT for asthma and IBS, the relationship is less obvious. In some instances, training a physiological event indirectly related to the physiology of interest has proven superior to treating the event itself. An example of this is frontal EMG for the treatment of essential hypertension. Therefore, the clinician must be aware of the physiology underlying the disorder and of the literature that relates to the different biofeedback treatments used to treat that disorder. This information must then be combined with the individual's characteristics such as his or her unique physiological levels and the ability to benefit from the various types of biofeedback techniques available. The clinician must also be skilled in helping the client generalize the control acquired in the clinic to the individual's life situations.

Constant advances in computer technology and developments in bioengineering, which provide new sensor technology and signal processing, make the future of clinical biofeedback look very promising.

Acknowledgment

The author wishes to thank Melissa Combs, M.S. for her assistance in the preparation of this article.

See Also the Following Articles

Alternatives to Psychotherapy ■ Multimodal Behavior Therapy ■ Neurobiology ■ Post-Traumatic Stress Disorder ■ Retention Control Training ■ Relaxation Training

Further Reading

- Applications Standards Committee of the Association for Applied Psychophysiology and Biofeedback. (1992). *Standards and guidelines for biofeedback applications in psychological self-regulation*. Wheatridge, CO: Association for Applied Psychophysiology and Biofeedback.
- Boucsein, W. (1992). *Electrodermal activity* (pp. 5–36). New York: Plenum Press.
- Evans, J. R., & Abarbanel, A. (Eds.). (1999). *Introduction to quantitative EEG and biofeedback*. New York: Academic Press.
- Kasman, G. S., Cram, J. R., Wolf, S. L., & Barton, L. (1998). *Clinical applications in surface electromyography: Chronic musculoskeletal pain*. Gaithersburg, MD: Aspen.
- Lantz, D., & Sterman, M. B. (1992). In T. L. Bennett (Ed.), *The neuropsychology of epilepsy* (pp. 213–231). New York: Plenum Press.
- Middaugh, S. J., Kee, W. G., & Nicholson, J. A. (1994). Muscle overuse and posture as factors in the development and maintenance of chronic musculoskeletal pain. In R. C. Grzesiak, D. S. Ciccone, et al. (Eds.), *Psychological vulnerability to chronic pain* (pp. 55–89). New York: Springer.
- Miller, N. E., & DiCara, L. V. (1967). Instrumental learning of heart rate changes in curarized rats: Shaping and specificity to discriminative stimuli. *Journal of Comparative and Physiological Psychology*, *63*, 12–19.
- Monasta, V. J., et al. (1999). Assessing attention deficit hyperactivity disorder via quantitative electroencephalography: An initial validation study. *Neuropsychology*, *13*, 424–433.
- Montgomery, D. D. (1998). Understanding electrodermal activity: The clinically neglected modality. *Biofeedback*, *26*, 15–32.
- Schwartz, M., & Associates (Eds.). (1995). *Biofeedback: A practitioners guide*. New York: Guilford Press.
- Schultz, J. H., & Luthe, W. (1969). *Autogenic therapy (Vol. 1, Autogenic methods)*. New York: Grune and Stratton.
- Wenck, L. S., Leu, P. W., & D'Amato, R. C. (1996). Evaluating the efficacy of a biofeedback intervention to reduce children's anxiety. *Journal of Clinical Psychology*, *52*, 469–473.

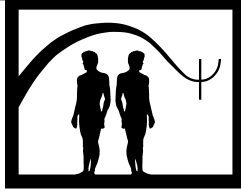

Breathing Retraining

Ronald Ley

University at Albany, State University of New York

- I. Description of Treatment
- II. Theoretical Bases
- III. Summary
- Further Reading

GLOSSARY

breathing retraining A self-control strategy used to regulate breathing behavior.

gas transference Delivery of oxygen to support metabolism and removal of carbon dioxide as a byproduct and maintenance of systemic acid-base balance.

I. DESCRIPTION OF TREATMENT

Breathing retraining refers to methods used to modify breathing behavior. Because breathing is essentially a self-regulatory process that marks the beginning of life with its initiation and the end of life with its termination, it is clear that one does not have to learn how to breathe. Thus, the word retraining is not entirely appropriate and may cause confusion because it implies that training has occurred prior to “retraining.” Although the term breathing training is coming into more popular usage, the bulk of the literature on the topic refers to “breathing retraining.”

Preliminary to a discussion of breathing and its modification the reader should also keep in mind that while the words breathing and respiration are often used syn-

onymously, “breathing” refers primarily to the mechanical process of moving air in and out of the lungs whereas “respiration” would include the exchange of blood gases at the cellular level. Thus, by holding one’s breath, breathing (the mechanical means of moving air in and out of the lungs) is temporarily inhibited voluntarily but respiration (the exchange of blood gases in cells) continues involuntarily.

Although the techniques of breathing retraining are essentially an art that depends on the therapist, patient, and other factors, there are in general two approaches. In one approach the therapist addresses the disordered breathing directly by explaining to patients some rudiments of basic respiratory physiology so that they can understand the relationship between their disordered breathing and the symptoms they present. The therapist then proceeds to teach patients how to control breathing (and thus reduce excessive ventilation) by means of relaxation of the abdominal muscles, contraction of the diaphragm, and relaxation of the intercostal muscles. The goal here is to teach the patient how to suppress thoracic breathing and thus restore slow rhythmic diaphragmatic breathing, that is, how to breathe in a manner that eliminates complaints or reduces their intensity.

In the other approach the therapist addresses the disordered breathing indirectly by deemphasizing breathing performance and instead emphasizing relaxation and encouraging self-awareness of interoceptive cues from all muscles involved in breathing. Whichever approach followed, the purpose of breathing retraining is to help the

client learn how to gain voluntary control of breathing in the short run and to establish habitual patterns of salutary breathing in the long run. In psychotherapy the specific goal of the adjunctive procedure of breathing retraining is to help the patient learn to reduce ventilation so that it is consonant with metabolic demand for oxygen, thus facilitating relaxation and clear receptive thinking while reducing anxieties.

II. THEORETICAL BASES

The principles of learning that underlie the methods of modifying breathing are essentially those that underlie behavior therapy. The specific breathing behaviors that are the targets of programs of breathing retraining include (a) frequency, (b) volume, and (c) patterns. Breathing frequency (respiration rate) refers to the number of breaths per minute or the number of respiratory cycles completed in 1 min, where a respiratory cycle consists of one inhalation followed by one exhalation. Breathing volume is measured in terms of either volume of air breathed in one respiratory cycle (tidal volume) or the sum total of air breathed per minute (minute volume); volume is expressed by expansion of the thoracic cavity caused primarily by contractions of the diaphragm, intercostal, and clavicle muscles. Pattern refers to combinations of respiratory frequency and contractions of particular muscles or groups of muscles, for example, fast contractions of intercostals and clavicles with little or no discernible contraction of diaphragm versus slow contraction of diaphragm with little or no discernible contraction of intercostals and clavicles.

Although breathing is the only vital function under direct and immediate voluntary as well as involuntary control, the limits of voluntary control, the limits to which breathing can be modified, are fairly narrow. The breaking point of breath holding marks one extreme; loss of consciousness by means of overbreathing marks the other. Involuntary control of breathing, especially during sleep, is maintained by a self-regulatory system governed primarily by neural pathways with origins in the medulla and pons. This self-regulatory system has been studied extensively.

While the physiological-vegetative role of respiration in gas transference, namely, the delivery of oxygen (O_2) to support metabolism and removal of carbon dioxide (CO_2) as a byproduct and maintenance of systemic acid-base balance (pH), is fairly well understood, the psychological effects of breathing on emotion and cognition has received relatively little scientific attention until about the middle of the 20th century. Al-

though programs of breathing retraining have been applied only recently in the treatment of psychological-psychiatric complaints and breathing-related somatic complaints, it should be noted that breathing retraining has been used through the years to modify breathing and thus facilitate speech, singing, playing wind instruments, swimming, running, as well as relaxing and reducing emotional reactivity in general. Breath control is at the heart of yogic exercises.

The relationship between disordered breathing and psychological-psychiatric disorders is not broadly understood. Part of the reason for this probably harks back to the separation of body and mind or corpse and spirit: life begins with inspiration (the body incorporating the spirit) and ends with expiration (the body giving up the spirit). Although few scientists would openly support the Cartesian notion of body-mind dualism, some would argue that there is a clear distinction between psychology and physiology beyond that of a convenient dialectic convention within biology. A simple example from respiratory psychophysiology that demonstrates how breathing provides a bridge between psychology and physiology is volitional overbreathing. Self-initiation of rapid and strong contractions of the diaphragm and intercostal muscles while resting (i.e., low metabolic demand for oxygen) will lead quickly to hyperventilatory hypocapnia (diminished arterial CO_2 and consequent rise in pH) and produce an almost immediate increase in heart rate, decrease in parasympathetic activation (i.e., sympathetic dominance), decrease in respiratory sinus arrhythmia, increase in electrodermal conductivity, and decrease in blood flow to the brain combined with a rise in pH and consequent decrease in dissociation of oxygen from hemoglobin to brain cell tissue. The immediate consequence of these reactions are acute cerebral hypoxia and a host of psychological, somatic, visceral, and neuropathic complaints. If some psychiatric disorders are a manifestation of faulty cognition that results from an inadequate supply of oxygen to the brain (cerebral hypoxia) then disordered breathing (viz., hyperventilation) can be a significant factor that contributes to the production or exacerbation of psychological-psychiatric and/or behavioral disorders.

Another part of the reason for the narrowly understood relationship between disordered breathing and psychiatric disorders may lie in problems of measurement. Although hyperventilation is correlated with both respiration frequency and tidal/minute volume, variables that are relatively easy to measure reliably, respiration frequency and/or volume can only be used as rough estimates of hyperventilation. The problem lies in fluctuations in metabolic demand for

oxygen. Changes in skeletal muscle tension or autonomic nervous system arousal (e.g., changes in mentation/emotion) will alter metabolic demand that in turn will effect changes in breathing. There are direct and indirect means for measuring hyperventilation (a reduction in partial pressure of arterial CO₂ and consequent rise in pH), independent of metabolic demand for O₂.

The direct means of determining hyperventilation is to assay samples of arterial blood for CO₂, an invasive and hazardous technique. The indirect means for estimating arterial CO₂ is the capnometer, an infra-red gas analyzer that samples expired air for its content of CO₂. This technique, which is neither invasive nor hazardous, uses a small tube attached just inside a nostril through which a vacuum pump relays air to the gas analyzer. The capnometer can provide both a continuous analogue readout of the percentage of CO₂ or a digital display of momentary readings of percentage CO₂ in expired air. The percentage of CO₂ at the end of a respiratory cycle (end-tidal CO₂) is richest in CO₂ because it contains a proportion of CO₂ that best represents the level of CO₂ at the point of diffusion of CO₂ from the arterioles to the lungs.

Although the determination of the proportion of CO₂ in the end-tidal peak of expired air by means of a gas analyzer (capnometer or capnograph) provides an accurate and reliable noninvasive estimate of partial pressure of arterial CO₂, this method seems to have escaped the attention of many psychotherapists. The reason for this may lie, in part, in tradition: psychotherapists study the mind, and physiologists study the body. Perhaps the time has arrived for a rapprochement; perhaps respiratory psychophysiology provides a bridge.

Recently, however, reports from patients suffering panic attacks and reports of laboratory findings, especially the occurrence of adventitious panic attacks during physiological assessments, have shown (1) the occurrence of hyperventilation in panic attacks, (2) the relatively low resting level of CO₂ in the arterial blood of patients who suffer panic disorder, and (3) the high incidence of complaints of severe dyspnea reported to occur in panic attacks. As a consequence of this connection between aberrant breathing and panic, programs for the treatment of panic disorder include breathing retraining in an attempt to reduce ventilation. Programs of treatment that do not directly address breathing either prescribe a drug, unwittingly or by intention, that reduces ventilation (e.g., benzodiazepines) or a method (e.g., relaxation) that indirectly reduces ventilation thus preventing hyperventilation and concomitant panic or terminating an attack soon

after its onset. Recognition of the role of breathing in panic places panic disorder in the realm of clinical respiratory psychophysiology.

The study of panic attacks in the laboratory has been confounded by four major factors: (1) inadequate criteria for the selection of subjects, (2) absence of a reliable panic challenge, (3) inadequate measures of psychophysiological functions, and (4) inadequate criteria for the determination of the occurrence or nonoccurrence of a panic attack. The criteria for the selection of subjects for experiments have typically been those of the *Diagnostic and Statistical Manual of Mental Disorders* of the American Psychiatric Association. Although these criteria may be adequate for clinical diagnosis, they are not sufficiently specific for the purposes of scientific experimentation because they allow for the inclusion of several distinctively different categories or types of panic attacks. Challenges used in attempts to elicit panic attacks cover a wide range (e.g., lactic acid, caffeine, yohimbine, CO₂, false heart-rate feedback, forced voluntary hyperventilation, false information on effects of breathing compressed air). All studies on the effects of challenges report some success in eliciting panic attacks, but none have demonstrated high reliability. Inadequate measurement of psychophysiological factors (especially end-tidal CO₂) prevents an adequate evaluation of the effects of challenges and the detection of changes that occur concurrently with panic attacks. Criteria for the determination of the occurrence of panic attacks typically rely on self reports by the patients or judgments by experimenters; objective physiological criteria are usually not used. To date, the most valuable information on psychophysiological processes in panic attacks in the laboratory have been adventitious panic attacks that occurred in the absence of any intended challenge.

Because breathing retraining in the treatment of panic disorder and other psychophysiological complaints aims "to prevent" hyperventilation by training patients to reduce their ventilation, it is essential for both the patient and the reader to have a clear understanding of the meaning of "hyperventilation." Hyperventilation is often confused with tachypnea (fast breathing—rapid cycles of inspiration and expiration) or with hyperpnea (voluminous ventilation—large volumes of air inhaled and exhaled per breathing cycle). While tachypnea and hyperpnea are types of breathing that can produce hyperventilation, they are not hyperventilation. Hyperventilation can only be understood in terms of the magnitude of ventilation with respect to the metabolic need for oxygen. Thus, while climbing stairs or running one might be engaged in tachypneic and/or hyperpneic breathing but not be hyperventilating if breathing does

not exceed the amount of oxygen required by the muscles for the task. Alternatively, a sedentary person watching an emotionally arousing television drama or sports event (or the evening news) might be hyperventilating (breathing an amount of air that exceeds metabolic demand for a recumbent musculature) even though there are no apparent signs of either tachypnea or hyperpnea.

Given that hyperventilation is any breathing beyond metabolic demand for oxygen, the issue of the deleterious effects of hyperventilation is not simply a matter of its occurrence or nonoccurrence. Everyone hyperventilates throughout the routines of everyday life. Deleterious effects of hyperventilation depend on the degree of overbreathing in conjunction with a number of other variables: intensity, duration, speed of onset, frequency of occurrence (acute or chronic), the internal and external conditions under which it occurs (e.g., intense emotion in an unfamiliar or threatening environment), and the extent to which one experiences a sense of control over the hypocapnic effects produced (e.g., dyspnea/breathlessness, tachycardia). Hyperventilation is complicated because the consequences of its occurrence depend on such a complex interaction of so many physiological and psychological factors.

III. SUMMARY

Although breathing retraining (the modification of breathing behavior) has been briefly discussed in the context of panic and related anxiety disorders, mention should be made that breathing retraining is applied in

the treatment of a broad range of complaints. The salutary effects of breathing retraining can be found in the treatment of noncardiac chest pain, as an adjunctive procedure in stress management programs and cardiac rehabilitation programs, and in the reduction of intensity of symptoms of chronic lung disease (asthma, bronchitis, and emphysema).

See Also the Following Articles

Anxiety Disorders ■ Panic Disorder and Agoraphobia

Further Reading

- Comroe, J. H. (1974). *Physiology of respiration* (2nd ed.). Chicago: Yearbook Medical Publishers.
- Ley, R. (1999). The modification of breathing behavior: Pavlovian and operant control in emotion and cognition. *Behavior Modification*, 23, 441–479.
- Lum, L. C. (1976). The syndrome of habitual chronic hyperventilation. In O. W. Hill (Ed.), *Modern trends in psychosomatic medicine*, Vol. 3 (pp. 196–230). London: Butterworth.
- Timmons, B., & Ley, R. (Eds.) (1994). *Behavioral and psychological approaches to breathing disorders*. New York: Plenum.
- van Dixhoorn, J. J. (1990). *Relaxation therapy in cardiac rehabilitation*. Doctoral dissertation, Erasmus University, Rotterdam, The Netherlands.
- von Euler, C., & Katz-Salamon, M. (Eds.), (1988). *Respiratory psychophysiology Wenner-Gren International Symposium Series No. 50*. Proceedings of an International Symposium, Wenner-Gren Center, Nobel Institute, Stockholm. London: The Macmillan Press Ltd.

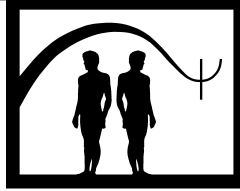

Brief Therapy

Brett N. Steenbarger

SUNY Upstate Medical University

- I. Overview of Brief Therapy
 - II. Theoretical Underpinnings of Brief Therapy
 - III. Research Findings
 - IV. Summary
- Further Reading

GLOSSARY

brief therapy Psychotherapy, typically of short duration, where efficiency in achieving change is an explicit aim. Sometimes referred to as time-effective or short-term therapy.

common factors Treatment ingredients shared by the different models of therapy that can account for the similar outcomes achieved by those models.

contextual models Approaches to therapy that seek change by shifting the situational contexts that are associated with the enactment of problem patterns. Examples include strategic-systems and solution-focused therapies.

learning models Approaches to therapy that seek change by teaching coping skills and rehearsing these in situations that have been problematic. Examples include cognitive-behavioral and cognitive-restructuring therapies.

relationship models Approaches to therapy that seek change by introducing powerful emotional experiences within the helping relationship that challenge maladaptive interpersonal patterns. Examples include interpersonal and brief psychodynamic therapies.

time-limited therapy Brief therapy in which duration is capped at the outset of treatment.

I. OVERVIEW OF BRIEF THERAPY

Brief therapy, sometimes also referred to as short-term therapy, is a generic label for any form of therapy in which time is an explicit element in treatment planning. There is no uniform dividing line between brief and nonbrief therapies. Rather, the range of interventions described as brief range from single session therapies in the strategic and solution-focused literature to episodes of 20 or more sessions in the short-term psychodynamic tradition. It is not at all unusual, for example, to find models of cognitive restructuring therapy that last for 12–15 sessions. This might be viewed as very brief treatment for a client with a personality disorder, but not one with an adjustment problem. Clearly brevity is relative to the accustomed duration of treatment and the objectives undertaken by the therapist.

Defining brief therapy becomes even more difficult when considering the range of extant models. Some brief therapies, for example, are “time limited,” allocating a fixed number of sessions for clients. Such limits often are dictated by administrative policies, such as benefit limits among insurance plans or service restrictions within clinics or counseling centers that have limited professional resources. Other approaches seek to be “time effective,” maximizing efficiency in change processes, but not laboring under a fixed duration of care. “Intermittent” models are especially difficult to categorize, as in the case of monthly therapy sessions that continue for a full year. Such interventions may be

long term, yet still “brief” in their consumption of therapeutic resources.

Finally, there is Simon Budman and Alan Gurman’s important distinction between therapies that are brief by design and those that are brief by default. A hallmark of all brief treatments is their planned nature. Many clients drop out of therapy for a variety of reasons, including a lack of resources, low motivation, disenchantment with the therapist, or satisfaction with a small number of visits. Indeed, approximately one-half of all terminations appear to be unilateral, initiated by the client. Although such cases turn out to be of short duration, they are not brief in the planned sense. True brief therapy makes an active effort from the outset to streamline change processes. Defined in this manner, brief therapy is not a separate school of treatment, but an approach that is applicable to any school.

There are several elements common to brief therapies that distinguish them from treatments that do not explicitly address the component of time. These include the following:

- *Focus:* Brief therapies typically target specific patterns rather than attempt broader personality changes. Such a focus is explicitly addressed in treatment planning and generally is part of a mutual understanding between therapist and client.

- *Activity level of the therapist:* Brief therapists characteristically adopt active methods to maintain the focus of treatment and promote self-understanding and change. The role of the brief therapist is more akin to a catalyst than to the blank screen described by Freud.

- *Activity level of the client:* The efficient utilization of time requires that clients be absorbed in change efforts between sessions, as well as during them. Brief therapies, therefore, generally make use of explicit tasks, homework exercises, and between-session efforts to apply skills and insights obtained during meetings.

- *Client selection:* The great majority of brief therapists recognize that brief therapies are not appropriate for chronic and severe mental illnesses, although techniques borrowed from brief approaches may be of value. Accordingly, therapy typically begins with an assessment to determine the appropriateness of brief treatment for a particular client.

- *Enhanced experiencing:* People appear to be more receptive to change when they are in altered and enhanced states of experiencing. Many methods utilized by brief therapists, including hypnosis, relaxation techniques, introspection, confrontation, exposure, and role playing, enable individuals to experience themselves and their problems in new ways.

- *Emphasis upon readiness for change:* Following the work of James Prochaska and Carlo DiClemente, brief therapists typically target changes for which clients are ready. When clients are not aware of changes that need to be made or committed to making these, brief therapy goals will typically focus on advancing readiness for change rather than working through long-term resistance.

- *Emphasis on impact of intervention:* Brief therapists typically regard the emotional power of interventions, rather than their absolute duration, as critical to change. Accordingly, they tend to emphasize the promotion of corrective emotional experiences rather than exhaustive insight into past conflicts.

By actively maintaining focused efforts at change and maximizing the involvement of both parties within and between sessions, brief therapists attempt to make optimal use of time in treatment. There are, however, a range of persons and problems for which brevity is not feasible and, indeed, can even exacerbate problems. Among the dimensions that are important in determining whether or not treatment can be brief are:

1. *Duration:* Although there is no one-to-one correspondence between the duration of a presenting problem and treatment length, it is fair to assume that chronic, long-standing patterns have been overlearned and may require more intensive and extensive work on discrepancy and consolidation than recent, situational adjustment problems. Chronic problems pose a particularly significant risk of relapse, significantly extending the time that must be spent in consolidation work. Indeed, therapists specializing in substance abuse work and the treatment of the severely and persistently mentally ill view relapse as an integral part of change, not as a treatment failure. To the extent that clients must pass through iterations of change, relapse, and renewed change, treatment cannot be highly abbreviated.

2. *Interpersonal history:* A precondition of brevity is the formation of a quick, positive, and durable therapeutic alliance. This is most likely to be possible among clients who have not experienced significant interpersonal traumas. When clients have grown up within abusive, neglectful, or highly inconsistent homes, the capacity for trust and bonding may be impaired. Such individuals may need many months of meeting before they can feel sufficiently comfortable to open up about their true concerns. This greatly extends the time needed to effect change. In such cases, the formation of a positive alliance may itself comprise the bulk of the therapy, allowing clients to modulate their needs for closeness

and distance and establish consistent and caring relationships with others.

3. *Severity*: When presenting problems are so severe and complex that they greatly impair emotional, vocational, and interpersonal functioning, it may be difficult to maintain the singular focus that is the hallmark of brief treatments. Indeed, highly depressed, psychotic, and anxious clients—as well as those in the throes of drug or alcohol dependence—may require medical attention before being able to focus on targeted therapy. It is not unusual in such circumstances for therapists to conceptualize what would otherwise be a lengthy course of treatment as a modular series of brief therapies, each addressing a particular facet of the client's concerns.

4. *Understanding*: As suggested earlier, clients are most appropriate for brief work when they are aware of a problem in their life and committed to doing something about it. Many clients, however, are at a lower level of change readiness. Some realize that their lives are not going well but possess little or no insight into their patterns. Others may be aware of their shortcomings, but ambivalent about changing them, as in the case of someone who remains in a familiar but unsatisfying romantic relationship. In the absence of insight and commitment, therapy is apt to become elongated, helping clients explore problems and their costs prior to taking remedial action.

5. *Capacity to tolerate discomfort*: Much of the brevity of therapy is accomplished by provoking client patterns within sessions and creating active opportunities for new learning. Such corrective experiences may be highly threatening to a client with poor coping ability and/or one who is in a state of crisis. Habib Davanloo's notion of a "trial therapy," in which highly emotional techniques are attempted on a limited scale during an initial session, is quite useful in assessing the degree to which a vulnerable person can benefit from accelerated efforts at change. Indeed, the entire notion of brevity may be overly anxiety provoking—and hence inappropriate—for clients who are struggling with long-standing issues of attachment and rejection.

II. THEORETICAL UNDERPINNINGS OF BRIEF THERAPY

There are many specific schools of brief therapy and numerous variations within each school. It has been suggested that all these approaches may serve a common function: helping therapists and clients achieve a common understanding of patterns and the means by which patterns can be altered. Each approach, from this per-

spective, may be seen as a distinctive translation system that transforms a bewildering array of presenting problems into a meaningful set of patterns. To the extent that this is so, it may be less important to ask which approach to brief therapy is more effective than its alternatives than to find approaches that can serve as useful translation frameworks for particular therapeutic dyads.

In the broadest sense, there are three overarching models of brief therapy: contextual, learning, and relationship. These make different assumptions regarding the scope and genesis of problem patterns, the role of the therapist in addressing these patterns, and the techniques to be utilized in effecting change. As we see, these assumptions play a crucial role in determining the ultimate brevity of treatment.

A. Contextual Therapies

The contextual therapies owe their genesis to the pioneering work of Milton Erickson and the subsequent elaboration of his therapy in strategic-systems and solution-focused therapies. These are among the briefest of the brief therapies, sometimes addressing change in a single session.

Common to the contextual brief therapies is the notion that problems are constructed and not intrinsic to the individual. Once people construe a set of life outcomes as problems, they typically attempt solutions to these problems, sometimes making the initial difficulties worse in the process. The result is a circular difficulty in which problems and solutions become self-reinforcing and amplifying. A common and simple example of this is the insomniac client who tries as hard as he can to fall asleep, only to find that repeated trying keeps him awake.

Contextual brief therapy proceeds from the recognition that relatively small shifts in the context of the client's problem can be sufficient to interrupt these self-reinforcing cycles and set the client along a new trajectory. The emphasis is thus not on analyzing problems or their historical roots, but in finding contextual parameters that no longer sustain the unwanted behavior patterns. The insomniac client who is instructed to laboriously clean his floors whenever he cannot sleep is thus prevented from enacting his prior efforts at solution. The prescribed task becomes so monotonous that anything—including sleep—becomes an easier course of action.

In the solution-focused variant of contextual brief therapy, efforts are made early in the treatment process to discover exceptions to the problem patterns associated with presenting complaints. Problems rarely occur all the

time, and even troubled individuals possess significant coping resources. This allows the solution-focused therapist to help clients identify patterns of solution—that is, regularities in their ability to *not* experience problematic responses. Once people are able to identify what they are already naturally doing when they avoid falling into old patterns, they are encouraged to rehearse these “solutions” both within and between sessions.

An essential assumption behind the strategic and solution-focused approaches is that clients already possess the resources needed to shift their patterns. Indeed, contexts that can disrupt problem patterns and foster new, more desirable actions are generally available to clients. Because clients are so locked into their constructions of problems and solutions, however, they are unable to escape from their difficulties. From this perspective, spending significant time delving into client recitations of problems is counterproductive, as it reinforces the notion that these problems possess an existence apart from the client’s system of construals. The goal of therapy is less to solve a problem than to help clients see that there wasn’t really a problem at all; that the presenting complaints were artifacts of their particular context.

Accordingly, the contextual brief therapies are among the briefest of the short-term therapies. They do not actively discuss the relationship between client and therapist, and they move quickly from the initial presentation of problems to an action-oriented exploration of solutions. Indeed, an explicit goal of the solution-focused modalities is to construct solutions that can be self-amplifying, creating large developmental impacts from relatively modest interventions.

In terms of technique, several elements distinguish the contextual brief therapies. These include the following:

1. *An avoidance of resistance:* Resistances to interventions are viewed as signs that a particular construction offered by the therapist is not user friendly for a client. Accordingly, the therapist is apt to shift to a different construction rather than delve into the resistance. An underpinning of the literature in strategic therapy is the role of interpersonal influence in change processes. Efforts are made to maximize this influence by maintaining a positive, nonthreatening relationship between therapist and client. Indeed, strategic therapists sometimes adopt a “one-down” stance, disavowing their status as experts, as a way of minimizing distance between themselves and those seeking their assistance.

2. *The creative use of language:* Many of the interventions used by contextual brief therapists help clients reframe patterns in ways that create cognitive flexibility

and open new behavioral alternatives. Such strategies include the use of metaphors and stories that can stick in clients’ minds and help them see their problems in a different light. Many times, clients will provide their own language to describe incidents in which problems were not sustained. This language may be adopted by the therapist to anchor future discussions of solution patterns.

3. *The use of prescribed tasks:* The goal of many of the contextual brief therapies is to provide clients with a first-hand experience in which the constructed problem does not occur. Prescribed tasks are an effort to create such experiences in a vivid manner that can serve as the basis for new construals. For example, a therapist may prescribe a paradoxical task in which couples are instructed to hold their arguments at a given hour in the evening while standing in a ludicrous and unaccustomed setting, such as a walk-in clothes closet. The absurdity of standing in the closet—and the cooperation needed to make the argument occur at the appointed time and place—make it impossible for the couple to summon their normal rancor. With the anger defused, the couple can engage in a different mode of communication, more likely to constructively address their concerns.

4. *Shifts in states of consciousness:* Milton Erickson’s realization that much of therapy involves a process of interpersonal influence led him to work with trance induction as a strategy for accelerating change. Many of the prescribed tasks offered by strategic therapists have a novelty or shock value that maximizes their emotional impact. The goal is to facilitate the deep processing of new information, bypassing the normal critical awareness that helps to sustain problem constructions.

B. Learning Therapies

The learning models begin with a different set of assumptions, defining problem patterns as learned, maladaptive responses to situations. The goal of therapy from this perspective is to unlearn these self-defeating responses and replace them with more constructive alternatives. This places the client in the role of student and the therapist in the role of teacher. Instead of affecting client constructions with novel framings and experiences, the therapist engages in active instruction. These nascent skills can then be rehearsed in situations that have led to problems in the past, eventually becoming part of an established repertoire.

In the approaches derived from operant and classical conditioning—often designated as cognitive-behavioral therapies—treatment begins with an extensive behavioral analysis of the situational determinants of problem

patterns. Such an analysis can be undertaken through direct observation in school, hospital, or other structured settings or might be conducted through homework exercises involving self-monitoring. The key idea is that problem patterns are elicited by a limited set of internal and environmental cues. Once these triggers are identified, they can be targeted as opportunities for introducing, rehearsing, and reinforcing skills. The goal is to introduce an element of self-observation into behavior patterns that have been automatic, creating flexibility in response. In behavioral modification, for example, when trigger situations are encountered, efforts are made to withhold any reinforcement of problematic behaviors and systematically reward approximations to new, desired actions—including those that have been modeled for the client. The creation of incentives, such as those found in a token economy, can be especially effective in sustaining awareness of skill-based responses in problem situations. This is often undertaken in structured environments, such as school classrooms, where professionals possess a high degree of control over environmental and interpersonal variables and can observe clients on an extended basis.

The idea of enacting new patterns in contexts that have generally fostered problematic behaviors is a hallmark of brief therapies that derive inspiration from classical conditioning. These exposure-based methods, well exemplified in the work of Edna Foa and David Barlow, actively provoke problem patterns, such as anxiety episodes, while the client engages in cognitive and behavioral coping efforts. Through repetition, clients learn to control responses previously viewed as out of control, gaining a sense of mastery. Such exposure can be gradual, as in systematic desensitization, or it can be undertaken all at once, as in flooding methods. Many times, the exposure is first tackled through the use of vivid imagery (imaginal exposure), in which clients invoke anxiety by imagining themselves in stressful situations. Later, the work can proceed to *in vivo* exposure, as clients tackle actual situations within and between sessions.

The exposure-based therapies generally follow a sequence of steps that are common to the learning modalities. These steps include the following:

1. *Monitoring*: Clients are encouraged to become aware of situational precursors of problematic responses and internal cues that precede these responses. Many times these cues are fairly subtle, as in the case of bulimic clients who may become overly sensitive to interoceptive stimuli of bloating or fullness during menstrual cycles or

following meals. The use of journals or self-rating forms can be especially helpful in these efforts, requiring clients to exercise self-awareness between sessions.

2. *Skill introduction and modeling*: Before a skill, such as a relaxation technique, is actually taught to a client, it is first introduced and explained in detail. Its rationale is described, and client questions are addressed to facilitate compliance. The skill is also modeled by the therapist for the client, with a step-by-step explanation of how it is performed. The goal is to help a client understand and feel comfortable with a skill before attempting it directly.

3. *Skill rehearsal*: Learning models emphasize the role of rehearsal in generating new and lasting behavior patterns. Rehearsal is first undertaken within the session, with copious feedback offered by the therapist. Only when the skill is mastered within the session is it assigned as between-session homework. Often such homework encourages repetition of the skill in nonthreatening situations to maximize the probability of early success.

4. *Pairing of skill enactment with problem cues*: Once a person has mastered a coping skill, therapy attempts to actively invoke cues that provoke problem patterns. These challenges are utilized as opportunities to rehearse and apply the coping skills, with the idea of extinguishing anxiety and preventing unwanted behavioral responses. By invoking stresses on a graduated basis, therapists can help to ensure client successes, building the sense of mastery. The intensity of repetition with which the pairing is undertaken is adjusted to the client's tolerance level, with special care taken to avoid traumatizing vulnerable individuals.

5. *Generalization*: Once a person can successfully invoke coping in a former problematic situation, the situation may be rehearsed many times—in and out of session—to promote the internalization of the skill and its application to new situations. Daily homework makes maximum use of time between sessions, allowing clients to benefit from regular experiences of self control.

The classical conditioning paradigm has been extended to the treatment of trauma by Francine Shapiro in her work on eye movement desensitization and reprocessing (EMDR). In this approach, clients are asked to relive emotionally upsetting episodes in their lives while rehearsing repetitive patterns of eye movement or other bodily action. Shapiro postulates that change is accelerated when clients can actively reprocess painful emotional experiences that have not been properly assimilated. EMDR appears to benefit individuals by eliciting their emotional memories in a relatively

nonemotional context. Most of the EMDR tasks are routine and even somewhat boring. By pairing traumatic memories and fears with the performance of emotionally neutral tasks, EMDR may extinguish anxiety in much the same way as exposure-based behavioral therapies, allowing clients to experience stressors in a less aroused state and build a sense of mastery.

Cognitive restructuring approaches, popularized by the work of Aaron and Judith Beck, apply principles of learning to the modification of problematic thought patterns. The key idea behind this work is that patterns of construal underlie emotional responses. If these schemas are altered, individuals can respond to situations in new, healthy ways.

Many of the schemas that individuals draw on to make sense of the world embed information processing distortions. For example, people may engage in a process of selective abstraction, focusing on the most negative aspects of a life event and generalizing these to themselves. These distortions have become overlearned to the point where they now are automatic. In essence, the client mistakes his or her faulty processing of the world for reality. The automatic thoughts thus affect both feeling and behavior, creating problem patterns as distorted as their underlying schemas.

Brief therapy with a cognitive-restructuring model tends to be somewhat longer term than the exposure-based therapies largely because of the time devoted to identifying and understanding these information processing distortions. Exposure-based work often targets a very narrow behavioral pattern for change—phobic responses being a common example—while cognitive-restructuring methods are frequently employed to deal with broader problems of depression and personality disorders. Because the underlying distortions of thinking manifest themselves in multiple arenas for clients—emotional, interpersonal, vocational, etc.—the generalization process often takes more time. As a result, cognitive restructuring therapy can be expected to last 10–20 sessions, instead of the 5–10 sessions often associated with other cognitive-behavioral work.

The first step in cognitive-restructuring work involves psychoeducation. Clients are introduced to the cognitive model, drawing on examples from everyday life and specifics from the client's past. A particular point of emphasis is the linkage between thoughts, feelings, and behaviors and the ways in which our construals of events mediate responses. Individuals are much more likely to undertake the in-session and homework demands of therapy if the rationale of the treatment makes sense.

As with the aforementioned exposure-based modalities, self-monitoring is also a key initial phase of short-term cognitive work. Clients are encouraged to think about their thinking, often by keeping a written record of emotional events in their lives and the thoughts surrounding these events. A review of these journals within the initial therapy sessions helps clients identify distortions and appreciate the emotional and behavioral consequences. Once participants become adept at identifying their distortions in the sessions, they are encouraged to use their journals to become aware of their problematic thoughts between meetings, as they are occurring. With consistent practice and feedback, clients can build their self-observation skills and increasingly catch themselves in the act of engaging in problematic interpretations of events.

The core of cognitive-restructuring work occurs when clients learn to dispute their automatic thoughts with more rational, constructive ways of construing their lives. Once again this is first modeled within sessions by the therapist, using examples elicited from clients wherever possible. It may be possible, for instance, for individuals to reflect on how other people might interpret similar situations, or they might be aware of situations in which they would make very different interpretations. It is often helpful to encourage people to identify how they would respond to a best friend or significant other who was facing a similar situation. Interestingly, given such a scenario, many clients will spontaneously generate constructive construals that completely bypass their automatic, self-relevant schemas.

When these alternative interpretations are generated, they are rehearsed in a Socratic fashion within sessions, first with the therapist challenging the client and then with clients challenging themselves. The objective is to interrupt the automatic thoughts by initiating an internal dialogue in which one distances from one's schemas and evaluates them for accuracy. It is not unusual for therapists to suggest small experiments to be conducted between sessions in which clients test their automatic thoughts as if they were hypotheses in a scientific study. Such experiments can provide a powerful firsthand confirmation that the negative schemas are not accurate depictions of the world.

The extension of written journals to embrace efforts at disputing troublesome automatic thought patterns is another common technique employed in cognitive-restructuring therapies. The process of writing down negative thoughts and generating more constructive alternatives helps clients rehearse their thinking skills in

real time under controlled conditions. At first, such written work may require considerable time and effort. With practice, however, the skills themselves become automatic, and clients find themselves naturally questioning their old thought patterns as they are occurring. This generalization is aided by targeting challenging events between sessions and rehearsing ways of using the journal to respond to the challenges.

C. Relationship Therapies

Whereas the learning-based brief therapies rely heavily on skills-teaching and homework-based rehearsal, the relationship brief therapies emphasize interpersonal experience as a change vehicle. Central to these approaches is the idea that individuals internalize their interpersonal experiences, cementing their identity in the process. When these experiences have been conflicted, the person internalizes a fragmented, negative, and/or inconsistent sense of self. This disrupts mood and action and potentially impairs future relationships. Unlike the contextual therapist, the relationship therapist emphasizes the internal experience of clients and its social origins. Unlike the learning therapist, the relationship therapist stresses the curative impact of the helping relationship, rather than didactic instruction.

The brief relationship therapies differ from their longer-term siblings—client-centered and psychoanalytic treatment—in their focus on specific relationship patterns and relative emphasis upon the present. The Interpersonal Therapy for Depression (IPT) introduced by Gerald Klerman and colleagues links the depressive syndrome to several core issues, including delayed grief reactions, interpersonal role disputes, role transitions, and interpersonal deficits. Clients are helped to appreciate the interpersonal sources of their feelings, making their depression more understandable and less threatening. Sessions then focus on addressing the interpersonal challenges, interrupting the client's negative focus on self and promoting constructive action.

The psychodynamic brief therapies make particular use of in-session events between therapist and client to facilitate change. Like their longer-term counterparts, the brief dynamic therapies emphasize that problem patterns in the client's life will be replayed within the therapeutic relationship. This transference offers an opportunity for clients to see their patterns as they are occurring, to appreciate the costs of these patterns, and to initiate efforts to engage the therapist in a more constructive mode. Once clients are able to become better observers of their patterns within the sessions and initi-

ate efforts at change, their successes can serve as templates for shifting those patterns in other, extratherapeutic relationships.

The underlying model of problem creation and maintenance is also shared between the brief and longer-term analytic approaches. Early childhood conflicts are defended against through a variety of mechanisms. If these conflicts are repressed or otherwise left unresolved, they tend to resurface whenever the individual faces similar challenges in later life. At such times, people are apt to regress to their prior, less mature modes of coping. Whereas these defensive modes may have worked in the past, they are no longer adaptive for the current, adult context and yield new, painful consequences. For instance, a child who was abused may have warded off her anxiety by learning to dissociate. This no longer proves adaptive, however, in coping with conflict in mature working and loving relationships.

The brief and longer-term dynamic therapies differ in three crucial respects:

1. *Therapist activity*: In longer-term analysis, interpretation is a gradual process that is only undertaken after considerable work has been done to resolve resistances (defensive patterns that interfere with the therapy). The interpretive stance of the brief dynamic therapist is much more active, emphasizing present-day manifestations of patterns rather than their historical roots. Such practitioners as Lester Luborsky, Hans Strupp, and Hanna Levenson narrow their focus to specific cyclical interpersonal patterns that lead to maladaptive outcomes. Instead of waiting for clients to recognize these patterns on their own, brief dynamic therapists are much more likely to actively interpret their presence and associated consequences.

2. *Use of confrontation*: Longer-term analytic therapies emphasize interpretation as a primary intervention mode in dealing with resistances. Such brief dynamic therapists as Peter Sifneos and Habib Davanloo replace this interpretive work with a more direct confrontation of defenses, vigorously pointing out their maladaptive nature. This tends to heighten clients' anxiety level, placing them in greater touch with the thoughts, feelings, and impulses being defended. The brief analytic therapist largely abandons the analytic blank screen and instead acts as a catalyst for change by strategically heightening anxiety and bringing conflicts to life within sessions.

3. *Corrective emotional experiences*: The goal of traditional analysis is to foster insight into unconscious interpersonal conflicts and their consequences and support novel, adaptive efforts to deal with these. The

brief dynamic therapist, building on the framework first offered by Franz Alexander and Thomas French, attempts to speed this process by offering immediate relationship experiences that challenge the client's repetitive patterns. Davanloo's work, for instance, derives much of its power by goading repressed patients into expressions of anger against the therapist. By responding to this anger constructively, the therapist actively disconfirms the client's expectations of rejection and abandonment, making it easier to deal with conflict openly. This strategic use of the therapeutic relationship in brief dynamic therapy draws significant inspiration from interpersonal therapies, including the work of Sullivan. Providing powerful emotional experiences that challenge client patterns is more important than offering verbal insight into these patterns.

Although briefer than traditional psychoanalysis, many short-term dynamic therapies are longer term than other brief modalities. Indeed, it is not unusual for a brief dynamic therapy to extend for 20 sessions or longer, falling well outside the utilization guidelines and benefit limits of many managed healthcare plans. Once again, this is typically a function of the breadth of change being sought. The brief dynamic therapies generally target long-standing conflicts that have interfered significantly with emotional functioning. Because of the time required for these conflicts to play themselves out in the transference, for the therapist to earn the trust of an interpersonally troubled individual, and for adaptive efforts to take root, it is difficult to imagine brief dynamic work of only a few sessions. In summary, it appears that the term brief therapy actually masks a variety of interventions of differing scope and duration, with highly directive and focused modes at the shortest end of the continuum and more exploratory and broad treatments at the opposite end.

III. RESEARCH FINDINGS

A great deal of what we know about the effectiveness of therapy and the processes that contribute to favorable outcomes is derived from investigations of treatments that are brief. For this reason, researchers have noted that the outcome literature in therapy actually is a literature on brief therapy outcome.

Reviewers of the literature on brief therapy outcome have generally concluded that short-term treatments are effective in helping people who are suffering from situational and less severe disorders, such as anxiety

and grief. There is also ample evidence that brief therapy is helpful in the treatment of trauma and stress-related disorders. More chronic disorders, such as major depressive and psychotic conditions, appear to be more refractory to brief intervention.

A number of methodological factors appear to mediate brief therapy outcomes, generating several important conclusions:

- *Outcomes are a function of the time of assessment:* As the large National Institute of Mental Health (NIMH) study of depression found, outcomes tend to be more favorable at the end of treatment than at longer-term follow-up periods. The phenomenon of relapse is especially acute for disorders with long-term, chronic courses, such as major depressive disorder, compared with more situational anxiety problems.

- *Outcomes are a function of the criterion being measured:* Change in therapy appears to not occur all at once, but in phases. Symptom relief—reduced depression, anxiety, anger—tends to precede functional improvements in work, home, and interpersonal spheres. A brief therapy is most likely to look successful if symptom relief is the criterion. More interesting, clients appear to draw on different criteria in assessing change than their therapists, stressing symptom relief measures. They thus rate brief therapy outcomes more highly than their therapists, who place greater emphasis on measures of functioning.

- *Outcomes are a function of the client population:* Research by Kenneth Howard and colleagues found that, overall, change occurs relatively quickly—within the first few sessions—for the majority of neurotic clients. Adding sessions beyond the first 10 brings sharply diminished returns. Clients with personality disorders and severe psychopathology, however, continue to benefit from sessions beyond brief parameters and display only modest change within the first 10 visits.

- *The achievement of a rapid alliance is crucial to brief therapy outcome:* Howard's work also suggests that successful clients tend to experience a rise in well-being early in treatment, as they bond with their therapists and perceive the possibility of change. The failure to reach a working alliance early in therapy is a poor prognostic indicator of brief therapeutic outcome.

An important finding of the aforementioned NIMH study is that different forms of therapy conducted within brief parameters, including cognitive and interpersonal, did not produce unique changes among clients. That is, therapies with different explanatory models and intervention techniques may produce very

similar types of outcome, as well as similar magnitudes of change. This supports the notion that common factors may be the most important effective ingredients in short-term work. Indeed, therapy may be brief to the extent that it can harness these common ingredients and apply them intentionally and systematically to targeted problem patterns.

Studies of change processes in brief therapies tend to support this common factors hypothesis. It appears that brief therapy is not so much different from time-unlimited treatment as an intensification of longer-term modalities. The brief therapist emphasizes the effective ingredients in all therapies and attempts to maximize these in a planned, deliberate manner so as to catalyze desired changes. This can be described as a several-step process, an overarching, integrative model of brief therapy that can account for the shared elements among the contextual, learning, and relationship approaches:

1. *Engagement*: The earliest phase of therapy features a vigorous encounter between therapist and client in which the dimensions of the presenting problems are explored. Very often, this features a ventilation of the emotional upset that has brought the individual for help. By listening attentively, inquiring actively, and responding sensitively, the therapist facilitates a building of rapport and trust.

2. *Pattern search*: Bernard Beitman has emphasized the importance of pattern searching in the earliest phases of treatment. Presenting problems such as depression, anxiety, and relationship conflicts frequently arise under specific conditions. By asking for many examples of presenting problems, it is possible for therapist and client to identify the similarities among these instances and the conditions that serve as contexts for the generation of distress.

3. *Translation*: Clients typically enter therapy only after they have unsuccessfully attempted other means for solving their problems. As a result, by the time they sit for their first session, they are typically somewhat frustrated and discouraged. Not infrequently, the ways in which they have defined their problems—and hence the possible solutions to these—have led them to a dead end. When a brief therapist translates presenting problems into the new terms of a pattern—helping clients see this pattern for themselves—the result is often a sense of relief and hope. If the brief therapist has been effective in building trust and rapport and successfully identified outstanding patterns, the translation can serve as a mutual focus for therapy, engaging the client's readiness for change.

4. *Discrepancy*: A key process feature across the brief therapies is the attempt to elicit problem patterns within therapy sessions. This helps to heighten emotional experiencing and more deeply process efforts at change. It also speeds the change process by allowing clients to work directly on targeted patterns. Because the brief therapist takes an active role in eliciting problem patterns, brief therapies can be anxiety provoking for clients. Indeed, the heightened anxiety may serve as a spur for change. Many of the techniques specific to the brief therapies—exposure methods in behavioral desensitization, journal keeping in cognitive restructuring approaches, confrontation in the short-term dynamic methods, directed tasks in strategic work—allow clients to experience their problem patterns in a controlled and safe context. This allows for the possibility of responding to these patterns in a discrepant and adaptive manner, generating true corrective emotional experiences.

5. *Consolidation*: Once new, constructive patterns have appeared, the task of the brief therapist is to aid in their internalization. Although initial change can bring meaningful symptom relief, clients remain at significant risk of relapse if they have not truly made a new pattern part of their cognitive, behavioral, and emotional repertoire. Accordingly, the latter phases of brief therapy feature significant efforts at rehearsal and generalization, encouraging clients to extend their in-session changes to out-of-session contexts. Frequent feedback from therapists and rehearsal of anticipated future challenges facilitate generalization, as the focus comes full circle, from the identification of problem patterns to the facilitation of adaptive responses. Not infrequently, therapy moves to an intermittent basis of meeting as clients develop the capacity to sustain this consolidation on their own.

IV. SUMMARY

The term brief therapy subsumes a variety of treatment approaches derived from different models of change and spanning a range of treatment durations. Brief therapies share a number of procedural elements, including criteria for inclusion and exclusion, the maintenance of a sharp treatment focus, a high degree of therapist activity and client involvement, and concerted efforts to elicit and rework client patterns within and between sessions. Brief therapies range from very short-term strategic and solution-focused modalities to cognitive-behavioral and cognitive-restructuring models and more extended short-term dynamic approaches. All appear to be effective in helping people deal with situational problems and less severe anxiety and stress

concerns but may be limited in sustaining change among clients with chronic and severe disorders.

See Also the Following Articles

Economic and Policy Issues ■ Relapse Prevention ■ Single Session Therapy ■ Termination ■ Time-Limited Dynamic Psychotherapy

Further Reading

- Barlow, D. H. (Ed.) (1993). *Clinical handbook of psychological disorders* (2nd ed.). New York: Guilford.
- Beck, J. S. (1995). *Cognitive therapy: Basics and beyond*. New York: Guilford.
- Budman, S. H., & Gurman, A. S. (1988). *Theory and practice of brief therapy*. New York: Guilford.
- Koss, M. P., & Shiang, J. (1994). Research on brief psychotherapy. In A. E. Bergin & S. L. Garfield (Eds.), *Handbook of psychotherapy and behavior change* (4th ed.), pp. 664–700. New York: Wiley.
- Levenson, H. (1995). *Time-limited dynamic psychotherapy: A guide to clinical practice*. New York: Basic Books.
- Miller, S. D., Hubble, M. A., & Duncan, B. L. (Eds.), (1996). *Handbook of solution-focused brief therapy*. San Francisco: Jossey-Bass.
- Steenbarger, B. N. (1994). Duration and outcome in psychotherapy: An integrative review. *Professional Psychology: Research and Practice*, 25, 111–119.
- Van Hasselt, V. B., & Hersen, M. (Eds.). (1996). *Sourcebook of psychological treatment manuals for adult disorders*. New York: Plenum.
- Wells, R. A., & Giannetti, V. J. (Eds.), (1990). *Handbook of the brief psychotherapies*. New York: Plenum.



Cancer Patients: Psychotherapy

David Spiegel

Stanford University School of Medicine

- I. Description of Treatment
- II. Theoretical Bases
- III. Outcome
- IV. Summary
- Further Reading

less attention to “care,” the process of helping ill people live with cancer as well and as long as possible. That latter perspective is the focus of this article.

GLOSSARY

- active coping** Finding some aspect of a stressor that one can do something about and formulating a plan of action to respond to it.
- affective expression** The direct ventilation of emotion.
- hypnosis** A state of relaxed, attentive, focused concentration with a reduction in peripheral awareness.
- personalization** Bringing discussion of problems into the “here and now” by discussing problems as reflected by issues among group members rather than involving others outside the group.
- social constraints** Aspects of a social network that discourage open expression of feelings and thoughts.

As treatment for cancer has become more effective, it is better thought of as a chronic rather than a terminal illness. However, given the progressive nature of the disease, and the fact that approximately half of all people diagnosed with cancer will eventually die of it, a readjustment in the medical approach to cancer is needed. Currently, we focus almost exclusively on cure, despite the fact that cure is often impossible. We pay far

I. DESCRIPTION OF TREATMENT

A. Content

1. Social Support

Psychotherapy, especially in groups, can provide a new social network with the common bond of facing similar problems. Just at a time when the illness make a person feel removed from the flow of life, when many others withdraw out of awkwardness or fear, psychotherapeutic support provides a new and important social connection. Indeed, the very thing that damages other social relationships is the ticket of admission to such groups, providing a surprising intensity of caring among members from the very beginning. Furthermore, members find that the process of giving help to others enhances their own sense of mastery of the role of cancer patient and their self-esteem, giving meaning to an otherwise meaningless tragedy.

2. Emotional Expression

The expression of emotion is important in reducing social isolation and improving coping. Yet it is often an aspect of cancer patient adjustment that is overlooked or suppressed. Emotional suppression and avoidance are associated with poorer coping. At the same time,

there is much that can be done in both group and individual psychotherapies to facilitate the expression of emotion appropriate to the disease. Doing so seems to reduce the repressive coping strategy that reduces expression of positive as well as negative emotion. Emotional suppression also reduces intimacy in families, limiting opportunities for direct expression of affection and concern. Indeed, there is evidence that those who are able to ventilate strong feelings directly cope better with cancer.

The use of the psychotherapeutic setting to deal with painful affect also provides an organizing context for handling its intrusion. When unbidden thoughts involving fears of dying and death intrude, they can be better managed by patients who know that there is a time and a place during which such feelings will be expressed, acknowledged, and dealt with. Furthermore, disease-related dysphoria is more intense when amplified by isolation, leaving the patient to feel that he or she is deservedly alone with the sense of anxiety, loss, and fear that he or she experiences. Being in a group where many others express similar distress normalizes their reactions, making them less alien and overwhelming.

3. Detoxifying Dying: Processing Existential Concerns

Death anxiety in particular is intensified by isolation, in part because we often conceptualize death in terms of separation from loved ones. Feeling alone, especially at a time of strong emotion, makes one feel already a little bit dead, setting off a cycle of further anxiety. This can be powerfully addressed by psychotherapeutic techniques that directly address such concerns.

Exploring and processing existential concerns is a primary focus of supportive-expressive therapy. Irvin Yalom has described the ultimate existential concerns as death, freedom, isolation, and meaninglessness. Rather than avoiding painful or anxiety-provoking topics in attempts to “stay positive,” this form of group therapy addresses these concerns head-on with the intent of helping group members better use the time they have left. This component of the therapy involves looking the threat of death right in the eye rather than avoiding it. The goal is to help those facing the threat of death see it from a new point of view. When worked through, life-threatening problems can come to seem real but not overwhelming. Following a diagnosis of cancer, a variety of coping strategies come into play, including positive reappraisal and cognitive avoidance. However, denial and avoidance have their costs, including an increase in anxiety and isolation. Facing

even life-threatening issues directly can help patients shift from emotion-focused to problem-focused coping. The process of dying is often more threatening than death itself. Direct discussion of death anxiety can help to divide the fear of death into a series of problems: loss of control over treatment decisions, fear of separation from loved ones, anxiety about pain. Discussion of these concerns can lead to means of addressing if not completely resolving each of these issues. Thus even facing death can result in positive life changes. One woman with metastatic breast cancer described her experience in this way:

What I found is that talking about death is like looking down into the Grand Canyon (I don't like heights). You know that if you fell down, it would be a disaster, but you feel better about yourself because you're able to look. I can't say I feel serene, but I can look at it now.

Even the process of grieving can be reassuring at the same time that it is threatening. The experience of grieving others who have died of the same condition constitutes a deeply personal experience of the depth of loss that will be experienced by others after one's own death.

4. Reorganizing Life Priorities and Living in the Present

The acceptance of the possibility of illness shortening life carries with it an opportunity for reevaluating life priorities. When cure is not possible, a realistic evaluation of the future can help those with life-threatening illness make the best use of remaining time. One of the costs of unrealistic optimism is the loss of time for accomplishing life projects, communicating openly with family and friends, and setting affairs in order. Facing the threat of death can aid in making the most of life. This can help patients take control of those aspects of their lives they can influence, while grieving and relinquishing those they cannot. Having a domain of control can be quite reassuring. Previous studies by Roxanne Silver, Phillip Zimbardo, and colleagues of the sequelae of past traumatic events indicate that long-term psychological distress is associated with a temporal orientation that is focused on the past rather than on the present or future. For cancer patients who are experiencing the traumatic stressor of anticipating their imminent death and its impact on their loved ones, adjustment may be mediated by changes from past- or future-focused orientation to a present-focused orientation that is more congruent with the reality of

their foreshortened future. In addition, progress in life goal reappraisal, reorganization of priorities, and perception of benefits of cancer may also mediate improvement in symptoms and enhance quality of life.

5. Enhancing Family Support

Psychotherapeutic interventions can also be quite helpful in improving communication, identifying needs, increasing role flexibility, and adjusting to new medical, social, vocational, and financial realities. There is evidence that an atmosphere of open and shared problem-solving in families results in reduced anxiety and depression among cancer patients. Thus facilitating the development of such open addressing of common problems is a useful therapeutic goal. The group format is especially helpful for such a task, in that problems expressing needs and wishes can be examined among group members as a model for clarifying communication in the family.

In addition to enhancing communication, group participants are encouraged to develop role flexibility, a capacity to exchange roles or develop new ones as the pressures of the illness demand. One woman, for example, who became unable to carry out her usual household chores, wrote an “owner’s manual” to the care of the house so that her husband could better help her and carry on after her death. Others wrote letters to friends asking them to cook an extra bit of dinner one evening a month to share with them to relieve them of the pressure of cooking.

6. Improving Communication with Physicians

Support groups can be quite useful in facilitating better communication with physicians and other health care professionals. Groups provide mutual encouragement to get questions answered, to participate actively in treatment decisions, and to consider alternatives carefully. Research by Lesley Fallowfield has shown that cancer patients are more satisfied with the results of intervention, such as lumpectomy versus modified radical mastectomy, to the extent that they have been involved in making the decision about which type of treatment to have. Such groups must be careful not to interfere with medical treatment and decisions, but rather to encourage clarification and the development of a cooperative relationship between doctor and patient. The three crucial elements are communication, control, and caring: improving communication, enhancing patients’ sense of control over treatment decisions, and finding caring physicians and other health care professionals who are interested in the patient as a person.

7. Symptom Control

Many treatment approaches involve teaching cognitive techniques to manage anxiety. These include learning to identify emotions as they develop, analyze sources of emotional response, and move from emotion-focused to problem-focused coping. These approaches help the patient take a more active stance toward the illness. Rather than feeling overwhelmed by an insoluble problem, they learn to divide problems into smaller and more manageable ones. If I don’t have much time left, how do I want to spend it? What effect will further chemotherapy have on my quality of life?

Many group and individual psychotherapy programs teach specific coping skills designed to help patients reduce cancer-related symptoms such as anxiety, anticipatory nausea and vomiting, and pain. Techniques used include specific self-regulation skills such as self-hypnosis, meditation, biofeedback, and progressive muscle relaxation. Hypnosis is widely used for pain and anxiety control in cancer to attenuate the experience of pain and suffering, and to allow painful emotional material to be examined. Group sessions involving instruction in self-hypnosis provide an effective means of reducing pain and anxiety, and consolidating the major themes of discussion in the group.

B. Treatment Process (see Table I)

1. Personalization

Leaders are taught to bring group discussions “into the room” by keeping the focus on interactions occurring among group members, rather than directing discussion toward people and events outside the group. Although some discussion of family, friends, and outside events is inevitable, the processing of issues raised on the “outside” is best done on the “inside.” Thus when one patient discusses how she feels that she is a burden to her husband, the discussion is better directed toward the question, “Do you feel like a burden to the group?” or “Do other group members feel you are a burden?”

2. Affective Expression

Leaders should “follow the affect” in the room rather than the content. If a silent group member shows signs of emotion, the leader should respectfully direct attention toward her: “You seem upset now—what are you feeling?” Expression of emotion produces vulnerability, and it is important to make sure that those who express feelings are heard and acknowledged.

TABLE I
Group Process Goals for Leaders

Personalization
Facilitating an examination of personal and specific cancer-related issues.
Affective expression
Facilitating the expression of here-and-now feelings
Supportive group interaction
Facilitating supportive interactions among group members
Sharing group time and access to group attention
Avoiding scapegoating
Maintaining boundaries
Active coping
Facilitating the use of active coping strategies

3. Supportive Group Interactions

The leader is responsible for starting and ending the group on time, and seeing that there are few interruptions of the group time. Each member should be made to feel that her problems are as important as anyone else's. It is necessary to inquire about missing members, and to make sure that very silent members have a chance to talk. Also, avoiding scapegoating—the group's "fixing" one patient as a displacement of dealing with their own problems—is critical. Leaders must remember that their "patient" is the group, not just a series of individuals.

4. Active Coping

As problems are discussed, it is helpful for the leader to direct the group toward means of responding to them, rather than merely accumulating a series of unresolved difficulties, or avoiding discussing them. Finding a means of addressing problems reduces the helplessness engendered by them.

II. THEORETICAL BASES

No one is well prepared by life to deal with a life-threatening diagnosis and the rigors of treatment, and yet medical treatment has focused almost exclusively on the necessary problems of undergoing diagnostic tests, surgery, radiotherapy, chemotherapy, hormonal treatments, and other biomedical interventions. Far less attention has been paid to educating patients about their illness and its effects on their lives, processing emotions inextricably intertwined with the disease, and enhancing social support, which is often damaged by the presence of the disease.

There is strong evidence that social contact has not only positive emotional effects, but that it reduces overall mortality risk as well as that from cancer. In a major review James House showed that social isolation is as strongly related to age-adjusted mortality as serum cholesterol levels or smoking. Indeed, being married predicts better medical outcome with cancer, while social stress such as divorce, loss of a job, or bereavement is associated in some studies with a greater likelihood of a relapse of cancer. Thus, constructing new social networks for cancer patients via support groups and other means is doubly important: It comes at a time in life when natural social support may erode, and when more is needed.

A. Social Constraints

The social-cognitive processing model of adjustment to trauma developed by Stephen Lepore contends that it is not merely the act of thinking about trauma-related information that facilitates processing, but it is disclosure and active contemplation of meanings, feelings, and thoughts with supportive others that is pivotal. A social environment that inhibits such disclosure may cause patients to avoid thinking and talking about the stressful experience and interfere with cognitive processing, resulting in prolonged distress and a failure to come to terms with the cognitive and emotional information in question. These social constraints cause cancer patients to feel unsupported, misunderstood, or otherwise alienated from their social network and have been associated with greater cancer-related intrusive ideation and avoidance. A similar construct, aversive emotional support put forward by Lisa Butler, has been found to amplify the impact of past stressful life events on current traumatic stress symptoms in cancer patients. Treatment-related changes in patients' perception or elicitation of social constraints should therefore result in greater processing of the cancer experience.

Living with the traumatic stressor of cancer creates an unending series of existential challenges. The threat to life is continuous, and reminders are constant, through symptoms such as pain, treatments and their side effects, loss of social roles, and the response of others to the condition. Thus the successful treatment of symptoms and the enhancement of quality of life for cancer patients requires interventions that focus on emotional and cognitive processing of the cancer experience and addresses the themes and issues that are specific to living with cancer. Successful treatment of cancer-related symptoms and improvements in quality

of life are mediated by engagement of cancer-related fears and other aversive emotions, increases in patient emotional self-efficacy for coping with the challenges of living with the illness, the degree of processing of existential cancer-related concerns and stressful cancer-related events, reduced social constraints that inhibit processing, the degree to which patients can reorganize their life priorities and live more fully in the present, and utilization of techniques such as self-hypnosis for pain and anxiety control.

Many of the psychotherapies that have shown promise in improving emotional adjustment and influencing survival time involve encouraging open expression of emotion and assertiveness in assuming control over the course of treatment, life decisions, and relationships.

III. OUTCOME

Psychotherapeutic treatments for cancer patients, both group and individual, have been shown to have a variety of positive effects, ranging from reduction in anxiety and depression to several recent studies suggesting increases in survival time.

A. Beneficial Effects of Group Interventions on Psychiatric Symptoms and Mood

Group interventions are of proven benefit in improving quality of life for cancer patients. For example, research on university- and hospital-based group interventions by Catherine Classen, David Spiegel, Fawzy Fawzy, and others has shown that they reduce traumatic stress symptoms and other psychological distress, improve coping skills, enhance disease knowledge, improve quality of life, and reduce pain.

B. Effects of Social Support Interventions on Health Status

Recently, a provocative literature has emerged indicating that group psychotherapy may affect the quantity as well as the quality of life. Our research group found that the metastatic breast cancer patients in our original randomized trial who had undergone supportive/expressive group therapy lived, on average, 18 months longer than did the randomly assigned control sample. By 48 months after the study had begun, all of the control patients had died, but a third of the treatment sample were still alive. There is now a larger and

divided literature on this survival effect. Four other studies have shown an effect of psychotherapy on cancer survival time of cancer patients: two involving lymphoma, one with melanoma, and one with gastrointestinal cancers. All of the psychosocial interventions were effective in reducing distress. Some involved supportive-expressive interventions, while others emphasized more cognitive-behavioral approaches and training in active coping. However, five others studies show no effect of psychotherapy on survival time. All but one involve breast cancer patients; the other lung and gastrointestinal cancers. Only two of these five studies were able to demonstrate psychological effectiveness in reducing distress. One study conducted by Pamela Goodwin was a major multicenter trial using the supportive-expressive model. This program was quite effective in reducing distress, but there was no treatment effect on survival time. Clearly further evidence is needed to resolve the provocative question of whether or not group psychotherapy affects cancer survival time. The mechanisms underlying such an effect may involve influence on daily activities such as diet, exercise, and sleep, or on adherence to medical treatment, or may involve changes in endocrine and immune function as well. Thus there is growing evidence that psychotherapy for the medically ill is a powerful and important treatment, with marked psychological and possible physical effects. The medicine of the future would do well to take these psychosocial effects into account. When we rediscover the role of care as well as cure in medicine, we will help patients and their families better cope with disease, and may also better mobilize the mind and body's resources to fight illness.

IV. SUMMARY

Group therapy for cancer patients involves attention to enhancing social support; encouraging emotional expression and processing; confronting existential concerns; improving relationships with family, friends, and physicians; and enhancing coping skills. These include taking a more active stance toward disease-related problems, and learning techniques such as self-hypnosis for pain control. Group leaders emphasize the here-and-now, personalizing discussion by making the group interaction itself the focus of discussion. Thus group relationships, feelings, and coping experience intensify learning and solidarity. Such group therapy approaches have been shown to reduce distress, enhance

coping, and ameliorate symptoms. There is some evidence that they may even enhance the quantity as well as the quality of life.

See Also the Following Articles

Collaborative Care ■ Comorbidity ■ Informed Consent ■ Integrative Approaches to Psychotherapy ■ Medically Ill Patients: Psychotherapy ■ Neurobiology ■ Self-Help Groups

Further Reading

- Andersen, B. (1992). Psychological interventions for cancer patients to enhance the quality of life. *Journal of Consulting and Clinical Psychology, 60*, 552–568.
- Blake-Mortimer, J., Gore-Felton, C., Kimerling, R., Turner-Cobb, J. M., & Spiegel, D. (1999). Improving the quality and quantity of life among patients with cancer: A review of the effectiveness of group psychotherapy. *European Journal of Cancer, 35*, 1581–1586.
- Compas, B. E., Haaga, D. A., Keefe, F. J., Leitenberg, H., & Williams, D. A. (1998). Sampling of empirically supported psychological treatments from health psychology: Smoking, chronic pain, cancer, and bulimia nervosa. *Journal of Consulting and Clinical Psychology, 66*, 89–112.
- Fawzy, F. I., Fawzy, N. W., Arndt, L. A., & Pasnau, R. O. (1995). Critical review of psychosocial interventions in cancer care. *Archives of General Psychiatry, 52*, 100–113.
- Leszcz, M., & Goodwin, P. J. (1998). The rationale and foundations of group psychotherapy for women with metastatic breast cancer. *International Journal of Group Psychotherapy, 48*, 245–273.
- Spiegel, D. (1999). A 43-year-old woman coping with cancer. *Journal of the American Medical Association, 282*, 371–378.
- Spiegel, D. (1999). Psychotherapy for cancer patients. In D. Spiegel (Ed.), *Efficacy and cost-effectiveness of psychotherapy*. Washington, DC: American Psychiatric Press.
- Spiegel, D., & Classen, C. (2000). *Group therapy for cancer patients: A research-based handbook of psychosocial care*. New York: Basic Books.
- Trijsburg, R. W., van Knippenberg, F. C., & Rijpma, S. E. (1992). Effects of psychological treatment on cancer patients: A critical review. *Psychosomatic Medicine, 54*, 489–517.

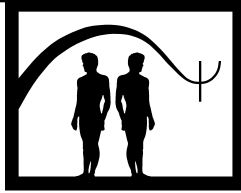

Chaining

Ruth Anne Rehfeldt

Southern Illinois University

- I. Description of Treatment
 - II. Theoretical Bases
 - III. Procedures for Establishing Chains
 - IV. Empirical Studies
 - V. Summary
- Further Reading

GLOSSARY

conditioned reinforcer A previously neutral stimulus that acquires its reinforcing properties through its pairing with an unconditioned reinforcer or another conditioned reinforcer.

discriminative stimulus Stimulus in the presence of which a response is reliably reinforced.

fading The systematic removal of prompts or other supplementary discriminative stimuli so as to facilitate independent responding.

prompt A supplemental discriminative stimulus that is presented to facilitate the emission of a correct response, but is gradually removed so as to encourage independent responding.

reinforcement A contingent relationship between a behavior and a behavioral consequence, in which that consequence causes the behavior to increase in frequency.

stimulus generalization The spread of the effects of reinforcement to stimuli not correlated with reinforcement, but that are similar along some dimension to a stimulus or stimuli that are correlated with reinforcement.

task analysis Breaking a complex task or skill down into its correct sequence of components.

I. DESCRIPTION OF TREATMENT

Chaining is an instructional procedure used to teach complex skills or tasks that are made up of several individual discrete components, which must occur in a specific sequence in order for the skill to be correctly performed. Such a sequence of responses is defined as a chain. Many daily living skills can be conceptualized as chains of responses. Preparing a bath, for example, is a task that requires the emission of several responses in a specific sequence in order to be performed correctly. In order to identify the individual responses comprising a chain, a task analysis must be conducted, in which the skill or task is broken down into a detailed listing of its component subtasks or subskills. For preparing a bath, a task analysis may include securing the plug in the drain, turning on the faucet, testing the water temperature, adjusting the water temperature, and stepping into the tub. When performed correctly, there is no break from the completion of one response of the chain to the next, and the final reinforcer of a warm bath becomes available only after the completion of the entire chain. Cooking a meal, getting dressed, and setting a place-setting are similar examples of chains.

In order to establish new behaviors via chaining, several variables will enhance the likelihood that a procedure is successful. First, it is imperative that an accurate task analysis be completed before instruction begins. Each response in the chain must not only be identified, but the correct order in which each response

occurs must also be specified. Observing the demonstration of a skill by a person who has mastered that skill will help ensure the accuracy of a task analysis. Second, only complex skills that include responses that are already in the individual's repertoire should be taught; this will be much easier than attempting to establish a complex skill that includes responses that are difficult for the individual to perform. Third, over the course of instruction, it may be necessary to prompt the individual to respond correctly. Prompts can be modeled, verbal, gestural, or physical, and will facilitate acquisition by ensuring that the individual is successful. Prompts will be particularly beneficial in helping the individual transition between each response of the chain. However, because the ultimate goal of chaining is for the individual to perform the task independently, it is important that the degree of assistance with which an individual is provided is gradually faded or reduced over the course of teaching. Fourth, reinforcing or providing verbal feedback for the correct emission of each response in the chain will also facilitate acquisition. But because outside of the context of instruction reinforcement is not made available until the entire chain has been completed, it will be necessary to gradually fade or reduce feedback that is provided during the chain.

II. THEORETICAL BASES

Chains that an individual has mastered are performed fluently; each individual response is performed with ease and the individual demonstrates a smooth transition from one response to the next. Because reinforcement does not occur until the end of the chain, it may be difficult to understand how responding during the chain, particularly one that is made up of many individual responses, can be maintained. Delayed reinforcement is seldom as effective as reinforcement that is delivered immediately following a response. We can understand how delayed reinforcement maintains responding during the chain if we acknowledge that with the emission of each response of the chain, new stimuli are introduced into the environment that may come to have both discriminative and conditioned reinforcing properties. For example, turning on the faucet introduces a new stimulus into the environment, the sight of running water. This stimulus may now occasion the next response of the chain, the response of testing the temperature of the water. This response also introduces a new stimulus into the environment, the feeling of

water of a certain temperature on the finger. This stimulus may now occasion the next response of the chain, the response of adjusting the temperature of the water, and so forth. Thus, response-produced stimuli may be established as discriminative for the next responses in the sequence of responses making up a chain. In addition, because those stimuli are temporally paired with the delayed reinforcer that becomes available at the end of the chain, they may be established as conditioned reinforcers, which maintain the responses that produce them. For example, the sight of running water may come to reinforce the response of turning on the water, and the feel of water on the finger may come to reinforce the response of touching the running water to test its temperature. It seems, then, that chains need not only be regarded as complex tasks made up of a series of individual responses, but as sequences of response-produced discriminative stimuli and conditioned reinforcers. Very lengthy chains can thus be easily executed and maintained by the stimuli that are produced as the chain is completed, despite the fact that the final reinforcer is delayed.

III. PROCEDURES FOR ESTABLISHING CHAINS

Chains that are frequently performed or for which individuals have had a great deal of practice are often performed with ease. Although persons with developmental disabilities may prove capable of demonstrating the individual components of a skill or task, they may experience considerable difficulty executing the entire sequence of responses consistently and accurately. Special instructional methods must be employed in order to ensure an individual's acquisition of a response chain, as well as his or her completion of a chain in the absence of adult instruction or intervention. There are three methods that are typically used to establish new behaviors via chaining. These include forward chaining, backward chaining, and total task presentation (also sometimes referred to as whole, concurrent, and simultaneous task presentation).

A. Forward Chaining

The first procedure for establishing new behaviors by chaining is forward chaining. In this procedure, the first response of the sequence is taught to an individual. When he or she has mastered that first response, the first and second responses of the chain are linked together,

and are then taught until the link has been mastered. Next, the first three responses of the chain are linked together, and are then taught until that link has been mastered, and so forth, until the individual eventually masters the entire chain. Thus, forward chaining is used to teach chains by constructing longer and longer links and adding one response at a time, starting at the beginning of the chain and working forward. The individual's success determines when each next response is added to the most recently taught link. An advantage of forward chaining is that it is conducted according to the natural order in which the individual responses comprising skills or tasks occur in everyday situations.

B. Backward Chaining

A second procedure for establishing behavior by chaining is backward chaining. As the name suggests, in this case the chain is constructed by teaching response links in the opposite order from which the skill will eventually be performed. In other words, the last response to be emitted before the chain is completed is taught first, then the second-to-the-last response and the last response are linked together and taught next. The third-from-the-last response is then linked to the second-to-the-last and the last responses, and that link is taught next, and so on, until the first response of the chain has been linked. Thus, like forward chaining, new behaviors are established by constructing longer and longer links and adding one response at a time, contingent on the individual's success. In this case, however, instruction starts at the end and proceeds backward through the chain. Backward chaining may seem to be counterintuitive, for in no situation would we wish for an individual to actually perform a skill backward. However, backward chaining is a very effective procedure for establishing new behaviors in the repertoires of persons with developmental disabilities. By beginning at the end of the chain, the stimuli that are produced by each response of the chain are more proximal with reinforcement than is the case for the stimuli that are produced by responses at the beginning of the chain. For a neutral stimulus to be established as a conditioned reinforcer, it must be highly correlated, or closely paired temporally, with another conditioned reinforcer or an unconditioned reinforcer. When a new behavior is taught via backward chaining, the discriminative stimuli that are produced by responses near the end of the chain are thus established as highly effective conditioned reinforcers, which maintain the responses emitted earlier in the chain as instruction proceeds

backward. Likewise, as training continues, the discriminative stimuli produced by each preceding response in the chain is then temporally paired with already established conditioned reinforcers, thus establishing new conditioned reinforcers that maintain the beginning responses of the chain. Hence, backward chaining may be desirable when one wishes to establish lengthy response chains, and for individuals who have trouble tolerating delay-to-reinforcement intervals.

C. Total Task Presentation

The third procedure for establishing a new behavior by chaining is total task (also known as concurrent, simultaneous, or whole task) presentation. This procedure requires that the individual attempt to correctly emit all of the responses from the beginning to the end of the chain on one training trial, and the trial is not considered complete until the individual has worked through the entire chain. In other words, unlike forward and backward chaining in which single response units are gradually linked together until the entire chain is mastered, total task presentation requires that the individual attempt the entire chain from its onset. As was the case with forward chaining, an advantage of using total task presentation is that the skill is taught in the natural sequence in which it occurs outside of the context of instruction. For very lengthy chains, however, it may prove challenging for an individual with a developmental disability to work through the entire chain on one trial.

IV. EMPIRICAL STUDIES

A. Forward Chaining

In 1987, John LaCampagne and Ennio Cipani used forward chaining to teach four adults with developmental disabilities the complex task of paying bills. Specifically, check-writing was defined as the occurrence of a sequence of six discrete responses: (1) Payee recorded on check, (2) date entered on check, (3) amount of payment entered in numerical form, (4) amount of payment entered in written form, (5) check signed, and (6) account number from bill entered on check. The first response of this chain was taught until the individual demonstrated the response correctly and independently five to eight times consecutively, after which the second response was added. The first two responses were then taught until the individual demonstrated this

link correctly and independently on five to eight consecutive trials, and so forth. Verbal instructions, modeling, and rehearsal were used to prompt correct responses as the links of the chain were mastered, and verbal feedback was provided for correct and incorrect completion of each response link. Prompts were gradually faded until the particular links of the chain could be successfully performed independently, and feedback was gradually faded until it was eventually only presented following the correct execution of the entire chain. This procedure was effective in establishing check-writing skills for all four participants; moreover, these skills were maintained over a 2-month period during which instruction was not provided. The established chain of responses was also shown to generalize to bills that were unfamiliar to the individuals or had not been used during the original training.

B. Backward Chaining

In 1996, Louis Hagopian, Debra Farrell, and Adriana Amari used backward chaining as a treatment for liquid refusal that was demonstrated by a developmentally disabled child with severe gastrointestinal problems. The authors hoped to teach the individual to independently drink water from a cup, using a preferred activity as a reinforcer. The task analysis consisted of the following: (1) Bringing a cup of water to the mouth, (2) accepting water into the mouth, and (3) swallowing the water. On each trial that the child responding correctly, he was reinforced with the opportunity to cut paper with scissors for 90 seconds. Each teaching session consisted of five trials, and the child was required to perform with 100% accuracy on two consecutive sessions before a new response was added to the link. First, reinforcement was delivered contingent on the child's swallowing, in the absence of water in the mouth, after being prompted. When the child demonstrated this response to criterion, reinforcement was provided contingent on swallowing after a syringe of water was depressed into his mouth. When this response link was demonstrated to criterion, reinforcement was then delivered contingent on accepting and swallowing water placed into his mouth from the syringe. When this response link was demonstrated to criterion, the amount of water that the child was required to accept and swallow from the syringe was gradually increased. Next, reinforcement was provided contingent on the child's bringing a cup of water to his mouth, accepting it, and swallowing the water. This chaining procedure was thus successful in establishing water consumption, and the child's drinking of water

was shown to generalize to settings different from that in which the original training had been conducted.

C. Total Task Presentation

In 1988, John McDonnell and Susan McFarland used total task presentation to establish laundromat skills in the repertoires of four high school students with severe developmental disabilities. The task analysis for the operation of the washing machine consisted of the following six steps: (1) locating an empty washing machine, (2) adding soap, (3) loading the clothes, (4) setting the wash cycle, (5) inserting the four quarters into the coin slide, and (6) activating the machine. The students were required to complete all of the responses in the chain in order on a given trial, and were provided with verbal feedback for the correct, independent emission of each of the six individual responses. Students received three training trials on the entire chain during a given session. A response was considered correct if the student completed the response accurately and independently. A response was considered incorrect if the student did not initiate the response within 5 seconds from the time the last response was completed, performed the response incorrectly, or was physically or verbally prompted to complete the response. Probe trials were inserted into the sessions of training trials, in which the students' ability to complete the entire task without assistance or feedback from teachers was assessed. The procedure was successful in establishing laundromat skills for all four participants.

D. Effectiveness of Each Procedure

It may not always be easy to discern under what conditions each of the three chaining procedures may be the most effective. The nature of the task at hand, the individual, and the amount of instruction time available are all variables that must be taken into consideration when deciding which procedure to use. As mentioned previously, an advantage of forward chaining and total task presentation is that the instruction occurs in the natural sequence in which the skill will be performed in everyday situations. However, some individuals may have difficulties tolerating the delay interval before which the reinforcer at the end of the chain is made available. This may be particularly problematic when establishing very lengthy chains, and when using total task presentation. When establishing a new behavior that consists of a number of individual responses via total task presentation, it may be wise to divide the chain into smaller segments, and teach one smaller segment at a time.

The challenges posed by the length of the delay-to-reinforcement interval in forward chaining and total task presentation make backward chaining seem like a desirable option to use in teaching persons with developmental disabilities. As was stated previously, the response-produced stimuli may serve as more effective conditioned reinforcers with this approach. In 1981, Thomas Zane, Richard Walls, and John Thvedt compared the amount of instruction time that was required to teach adults with developmental disabilities to assemble nine-part assemblies, using both backward chaining and total task presentation. Interestingly, total task presentation resulted in substantially less instruction time than did backward chaining. Similarly, in 1984 Fred Spooner demonstrated a higher acquisition rate for vocational tasks established via total task presentation than for backward chaining for persons with developmental disabilities. However, in 1989, John McDonnell and Brent Laughlin discovered no differences in the acquisition and maintenance of skills established by total task presentation or backward chaining. Moreover, in 1981 Richard Walls, Thomas Zane, and William Ellis showed that forward and backward chaining resulted in substantially fewer errors than did total task presentation when teaching vocational assembly tasks to persons with developmental disabilities. Thus, there is no unequivocal answer as to which is the best chaining procedure to use; the decision must depend on the specifics of the situation at hand. An appropriate resolution would be to base one's decision on data, and attempt all three procedures and select that which suggests the most success.

V. SUMMARY

Chaining is a procedure used to establish complex skills that are made up of several responses, which must

be performed in a particular sequence for the skill to be executed correctly. Reinforcement does not become available until the end of the chain. The responses constituting a chain may be maintained by response-produced stimuli, which function as conditioned reinforcers. Such stimuli may also have discriminative properties. Forward chaining, backward chaining, and total task presentation are all procedures for establishing new behaviors by chaining. There are different advantages associated with each of the three types of chaining, and research has provided different answers. Which procedure to use depends on the particular situation. Chaining will be most effective if a thorough and accurate task analysis of the skill is completed, if the chain includes responses already in the individual's repertoire, and if prompts and reinforcers are provided for individual responses within the chain, but are gradually faded.

See Also the Following Articles

Backward Chaining ■ Competing Response Training ■ Fading ■ Forward Chaining ■ Habit Reversal ■ Home-Based Reinforcement ■ Omission Training

Further Reading

- Catania, A. C. (1997). *Learning*. Englewood Cliffs, NJ: Prentice-Hall.
- Cooper, J. O., Heron, T. E., & Heward, W. L. (1990). *Applied behavior analysis*. Upper Saddle River, NJ: Prentice Hall.
- Kazdin, A. E. (2000). *Behavior modification in applied settings*. Belmont, CA: Wadsworth Publishing Co.
- Martin, G., & Pear, J. (1999). *Behavior modification: What it is and how to do it* (6th ed.). Upper Saddle River, NJ: Prentice Hall.
- Sulzer-Azaroff, B., & Mayer, G. R. (Eds.). (1991). *Behavior analysis for lasting change*. Orlando, FL: Holt, Rinehart, & Winston.

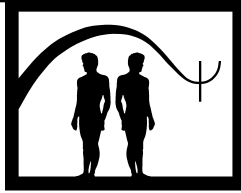

Character Pathology

Donna S. Bender and Andrew E. Skodol

New York State Psychiatric Institute/Columbia University

- I. Introduction to the Concept of Character
 - II. General Issues in the Treatment of Character Pathology
 - III. Psychodynamic Psychotherapy and Psychoanalysis
 - IV. Cognitive-Behavioral Therapies
 - V. Empirical Studies
 - VI. Summary
- Further Reading

difficulty with mental tasks, feelings of worthlessness or guilt, or possible thoughts or plans of suicide.

psychosocial functioning Ability to perform in psychological, social, and occupational realms.

psychotic Psychosis is characterized by significant disruptions in thought patterns due to intrusions by hallucinations, delusions, or gross disorganization of speech or behavior.

transference Childhood prototypes for interacting with significant others are unconsciously applied to figures in one's adult life; that is, old wishes, expectations, and conflicts may unwittingly shape current relationships.

GLOSSARY

conflict (intrapsychic) When requirements or elements are opposed to each other within a person's mind, such as a wish being judged internally as wrong or unacceptable, or two contradictory emotions.

countertransference Defined most broadly, the therapist's internal reactions—thoughts and feelings—both conscious and unconscious, to the individual patient.

defense mechanisms Mental operations unconsciously directed toward internal states of mind that a person desires to keep out of awareness because of threatened distress. For example, if someone is very angry with another but unintentionally behaves in an overly friendly or solicitous manner because experiencing the anger would be too threatening, it might be said that the defense mechanism of reaction formation is being used.

drives Internal pressure arising from innate patterns of experience such as aggression or sexual attraction.

major depression A sustained period of at least 2 weeks during which a person has a substantial lowering of mood or loss of interest or pleasure in normal activities, accompanied by changes in appetite or weight, sleep disturbances,

I. INTRODUCTION TO THE CONCEPT OF CHARACTER

The construct of character is a complex one, with a long and illustrious history. Robert Liebert has aptly articulated the conundrum we face when considering the meaning and significance of character:

It has become customary that any paper on character begin by emphasizing the confused conceptual status of the term—a term that comes down to us from ancient Greece. Its etymological roots, significantly, refer to that which is carved or engraved. Character has been a subject of concern for Aristotle, the Stoics, and every theologian, dramatist, gossip, Boy Scout leader, and psychoanalyst ever since. Our exploration of character is further complicated by the fact that the term has technical meaning in our discipline and also has varied connotations that are established in common parlance.

We must, then, at the outset define what we mean when we talk about character—a person's typical ways of perceiving and thinking, forms of emotional experience, and behavioral and activity patterns—what we generally think of as personality. Although specific proclivities may wax and wane, most individuals are recognized by others as having a style of approaching the world, even if that might be predictably unpredictable. For instance, we might use more commonplace terms such as easygoing, odd, or high-strung to describe various types of people. However, because we are considering character within the context of treatment, our discussion is focused more on trait clusters, enduring conflicts, and pervasive coping deficits that cause significant impairment and distress. The general term we use is character pathology, but specific "personality disorders" are mentioned, as well. Finally, it is important to note that the phenomena described exist on a continuum, with most of the pathological traits representing exaggerated versions of traits seen in normal personality.

Nearly four decades ago, David Shapiro proposed a collection of "neurotic styles" to capture a range of character pathology: obsessive-compulsive, paranoid, hysterical, and impulsive. The obsessive-compulsive character is associated with more stable interpersonal relationships than some other styles, but typical defenses are centered on the repression of instinctual sexual and aggressive drives, with patterns of highly regulated gratification and ongoing denial of interpersonal and intrapsychic conflicts. Self-willed and obstinate, with a constant eye toward rules and regulations, and a never-ending list of "shoulds," people with obsessive-compulsive attributes guard against any meaningful consideration of their impulses toward others. Maintaining control over internal experience and the external world is a top priority, so rigidity is often a hallmark of this character type. Except in its most severe manifestations, obsessive-compulsive character pathology is less impairing than some of the others and more readily ameliorated by treatment.

First written about at length by Sigmund Freud, the hysterical style conjures up images of dramatic scenes staged by people who are impressionable and highly distractible. When asked to describe themselves, others, or daily situations, people with this style will produce global and diffuse portraits. Because of associated inhibition in cognitive functioning and memory due to internal conflict, individuals with the so-called hysterical character may appear to be deficient in intellectual knowledge and shallow in emo-

tional experience. It has been traditionally more associated with women.

Considered to be more severely pathological than the others discussed, the paranoid style is associated with pervasive suspiciousness. Others' motivations are constantly called into question, with diligent surveillance for evidence to confirm these assumptions, making the individual guarded and tense. Although this type of personality must be distinguished from schizophrenia and other primarily psychotic disorders, the paranoid dynamic may, at times, become severe enough to cause lapses in the ability to grasp reality. The potential for difficulty in treating people with such traits should be readily apparent.

The impulsive label relates to a group of styles sharing the common characteristics of lack of control and impairment in deliberateness, leading the individual to act on a whim, being unable to delay gratification or tolerate frustration. There is a disjunction between taking action and any understanding of the motivation behind it. Shapiro attributed impulsive character pathology to a diverse range of problems and behaviors ranging from those of psychopaths, to alcoholics and drug addicts, to people with narcissistic issues.

Narcissistic character traits have received considerable attention in the clinical literature. Andrew Druck has described individuals for whom there is a fundamental deficit in the ability to regulate self-esteem without resorting to omnipotent strategies of overcompensation or overreliance on admiration by others. Some people who are narcissistically vulnerable have difficulty in maintaining a cohesive sense of self because of ubiquitous shame, resulting from a notion that they fundamentally fall short of some internal ideal. They look for constant reinforcement from others to bolster their fragile self-images. On the other side of the narcissistic "coin" are people who are intensely grandiose, seeking to maintain self-esteem through omnipotent fantasies and defeating others. They defend against needing others by maintaining fusions of ideal self, ideal other, and actual self-images. Thus, there is an illusion maintained whereby this type of narcissistic person has a sense that, because he or she is perfect, love and admiration will be received from other "ideal people," and so there is no need to associate with inferiors. This character type has been called the malignant narcissist by Otto Kernberg and is one of the most daunting treatment challenges because the patient's psyche is both disorganized and potentially disorganizing to the analyst.

Kernberg has also written extensively on the borderline character, which is characterized by instability in the areas of mood, interpersonal relationships, self-image,

and impulse control. John Gunderson and Mary Zanarini have done extensive work with such patients and have identified central characteristics of what has come to be specifically called "borderline personality disorder": quasi-psychotic thought, self-mutilation, suicide gestures and attempts, abandonment and engulfment fears, a sense of entitlement, and unstable identity. Patients with more severe forms of this disorder may be frequently hospitalized because of life-threatening behaviors. Kernberg's concept of borderline personality organization emphasizes a fragile and shifting sense of self, use of primitive defense mechanisms, and temporary lapses in awareness of reality. This is a broader formulation than that of borderline personality disorder and subsumes other personality traits such as narcissistic, antisocial, and schizoid.

The antisocial personality is associated with ongoing violation of society's norms, manifested in such behaviors as theft, intimidation, and violence to people and animals, or making a living in an illegal fashion such as by fraud, selling drugs, or stealing, for example. Clearly, this style would be found extensively within the prison system. Michael Stone has suggested that there are gradations of the antisocial style, with the milder forms being more amenable to treatment. However, within the broader label of antisocial is a subset of individuals who are considered to be psychopathic. These people, sadistic and manipulative, are pathological liars, show no empathy or compassion, no remorse for hurting others, and take no responsibility for their actions. The most extreme form is manifest by individuals who torture or murder their victims. This represents the extreme end of the spectrum of antisocial behavior and would be the most difficult to treat.

One system for more specifically describing different character pathology is the *Diagnostic and Statistical Manual for Mental Disorders, Fourth Edition* (DSM-IV). Specific diagnostic criteria have been established for ten personality disorders, characterized within three broader clusters. The Cluster A disorders are associated with odd or eccentric presentations and include schizoid, paranoid, and schizotypal disorders. Cluster B disorders are of an erratic or dramatic nature and include borderline, antisocial, narcissistic, and histrionic disorders. The Cluster C group, characterized as anxious or fearful, includes obsessive-compulsive, avoidant, and dependent personality disorders. This is a categorical approach to the classification of character pathology, and it has been widely noted that many people meet criteria for

several of these personality disorders, either within the same cluster or across clusters.

II. GENERAL ISSUES IN THE TREATMENT OF CHARACTER PATHOLOGY

Regardless of the system used to describe the phenomenology of character pathology or personality disorder, it is clear that these are long-standing, problematic and rigidly held patterns of organization. As such, patients with character pathology are likely to present for treatment with impaired coping strategies, troubled or nonexistent relationships, and related difficulties, such as anxiety, substance abuse, and depression. Thus, transcending diagnosis and treatment approach, the fundamental goal is to assist patients with character pathology to develop more flexible thought and behavior patterns to replace their maladaptive ways.

To accomplish this broad goal, the clinician must be able to engage the patient in a constructive therapeutic endeavor. Although establishing an alliance is important in all types of treatments for patients with all types of presenting problems, it is of fundamental importance in working with individuals with character issues. Forming an alliance is often extremely difficult, particularly in work with patients with severely narcissistic, borderline, or paranoid proclivities, as troubled interpersonal attitudes and behaviors will also infuse the patient's engagement with the therapist. Narcissistic patients may not be able to allow the therapist to be a separate, thinking person for quite a long time, whereas someone with borderline issues may exhibit wildly fluctuating emotions, attitudes, and behaviors, thwarting the potential helpfulness of the treater.

Countertransference on the part of the therapist must be monitored closely, as interactions with difficult patients may often be provocative, inducing reactions that must be carefully managed. Treatment approach and technique must also be flexible, so that interventions can be made appropriate to the individual patient's style. One-size-fits-all treatment is inappropriate and ill advised. Otherwise, the alliance may be jeopardized, the patient will not benefit or may leave treatment altogether. Furthermore, it can be expected that noticeable improvements in symptoms and functioning will likely require a significantly longer period of treatment when compared to patients with no character pathology.

III. PSYCHODYNAMIC PSYCHOTHERAPY AND PSYCHOANALYSIS

A. Description

The practice of psychodynamic psychotherapy and psychoanalysis is based on a collection of perspectives that have evolved since Freud's original work began over a century ago, and the basic concepts and techniques are explicated elsewhere in this volume. However, it is important in setting a context for the discussion of the treatment of character pathology to reiterate that the psychodynamic/psychoanalytic approach, most generally speaking, utilizes the relationship between patient and therapist as a primary vehicle for change and focuses on enduring patterns of thoughts, emotions, and behaviors that may or may not be in conscious awareness. Psychodynamic psychotherapy is informed by psychoanalytic theory, and psychoanalysis is considered to be a more intensive form of treatment compared to psychotherapy, because it most often entails four or more sessions per week.

The therapist's stance toward the patient and the kinds of interventions chosen should be based on the particular types of character issues most salient for the individual patient, and the approach may vary according to the patient's needs in any given session or during different phases of the treatment. Glen Gabbard has stressed the importance of understanding that there is usually a mixture of expressive and supportive elements in every analysis or psychodynamic psychotherapy. That is, the expressive, insight-oriented mode of assisting patients in uncovering unconscious conflicts, thoughts, or affects through interpretation or confrontation may be appropriate at times, while a more supportive approach of bolstering the patient's defenses and coping abilities is preferable in other circumstances.

For instance, the severely narcissistically impaired patient may not be able to tolerate the analyst's interpretations of his or her unconscious motivations for quite a long time, so that supportive, empathic communications may be more effective interventions in building an alliance by helping the patient feel heard and understood. Similarly, it may be difficult to focus on more insight-oriented interventions with a patient with borderline impairments until that patient is assisted in achieving a safe, more stable working relationship in treatment. Conversely, a patient who is characterized by obsessional difficulties may benefit earlier in treatment by interpretations of the repressed conflicts that may underlie the symptoms.

B. Theoretical Bases

Therapeutic work is also guided by the clinician's utilization of various theoretical models about the nature of the etiology of character pathology. Although psychoanalytic theories abound about the nature of psychopathology and its treatment, we focus on several main schools of thought that relate directly to character: object-relations theory, self psychology, and ego psychology.

1. Object Relations

The object-relations (the term "object" refers to person) perspective views the individual's earliest relationships with primary caregiving figures as focal points for understanding the salient features of how he or she relates to others as an adult. Explaining this phenomenon from the perspective of internalized object relations, Fred Pine described the psychology of the individual as "coming about through the laying down as memories and fantasies of early interactions (or imagined interactions) between the person and significant caretakers, so that behavioral expectancies, longings for particular gratifications, knowings of behaviors that will produce expectable responses are recorded and can be repeated." Clearly, central to this way of thinking is that all people construct mental representations of self in relation to others that become influential entities in both the conscious and unconscious mind.

Character pathology, within this framework, may result from disruptions at various points of development causing the child to internalize relationships as "bad," leading to maladaptive psychic constructions. The more primitive the level at which the early representations remain, the more distorted later representations are likely to be. Object-relations theory posits a model of treatment, then, that is based on modifying pathological images of self and others.

2. Self Psychology

Originally formulated by Heinz Kohut, and elaborated on by others, the self psychology paradigm focuses on the role of external relationships in the shaping and maintenance of self-concept and self-esteem. Kohut developed this approach while treating severely narcissistically disturbed patients who appeared to require certain kinds of responses from others in order to be able to function. Although everyone has the need throughout life for a certain amount of affirmation from others, people with narcissistic problems require excessive ongoing validation and confirmation to maintain any equilibrium. Kohut suggested that there may not have been appropriate "mirroring" of self by

caretakers who could not empathize with the child's experience when exhibitionistic behavior was a phase-appropriate part of development, consequently impeding the child's formation of a stable identity. As a result, an adult person with narcissistic difficulty cannot internally regulate his or her sense of self and so may feel required to be perfect, or to perform for others to gain adequate attention, constructing a grandiose self. Others do not exist as separate individuals, but merely as objects for gratifying needs.

This dynamic for need gratification might be manifest in treatment in the form of a "mirroring transference," whereby the patient is compelled to act in various ways to try to gain the therapist's admiration and approval. At the same time, Kohut also described an "idealizing transference" in which the therapist is seen as the powerful and perfect figure who can protect and heal, and the patient's status is boosted merely by association. The self psychology approach has been influential in informing therapists about the nature of narcissistic issues, and the important role of empathy in helping patients with character pathology to develop more cohesive and stable self-identities.

3. Ego Psychology

Freud, in *The Ego and the Id*, proposed the structural model of the mind with its three components: the id, ego, and superego. In his earlier work, he described a conscious aspect of the mind, responsive both to external stimuli as well as to intrapsychic events relating both to the natural impulses and wishes residing with the id, and to the directives and prohibitions issued by the superego, the residence of societal and parental values. This mediator between internal and external was designated as the ego, and from here ego psychology arose. The concept has been studied and greatly elaborated on as psychoanalytic thinkers realized the complexity of the ego's functions.

As the discussion continued, two branches of ego psychology and structural theory eventually arose. The first, which emerged in the 1930s and was most closely associated with Anna Freud, was oriented toward the defensive functions associated with the ego—those unconscious operations that occur in response to instinctual drives and fantasies that must be tempered to accommodate social demands in the real world. Pathology arises from conflicts among structures, id versus superego, ego versus superego, id versus ego. Therefore, the role of the analyst is to address the patient's unconscious conflicts by making these dynamics conscious.

However, as psychoanalytic discourse continued to evolve during the 1940s, there were others such as

Heinz Hartmann who shifted the emphasis to the ego as an entity primarily concerned with adaptation. That is, the importance of understanding patients' ways of dealing with reality became the emphasis, which helped to expand psychoanalytic theory's explanation of normal as well as pathological psychology. While Anna Freud's approach focuses on conflict (although she recognizes adaptive functions as well), Hartmann underscored the ego's functioning in nonconflictual spheres as well.

Within the ego psychology model, a system of unconscious defenses was elaborated. When there is conflict among structures, id versus superego, for example, painful anxiety may arise that the person may not want to experience. Therefore, various kinds of compromise formations occur as the result of defenses such as repression, projection, reaction formation, and splitting. Defenses are pertinent for understanding character pathology, as different styles are associated with different emphasis on the types of defenses typically employed.

To illustrate, as described earlier, a person with an obsessional style may be prohibited in some ways by his or her superego from expressing anger and aggression, leading to the repression of these emotions to keep them from conscious awareness. The price of repression, however, from a character standpoint, may be ongoing unemotionality, rigidity, and anxiety. The person who is predominantly paranoid uses projection as a defense, that is, he or she ascribes his or her own aggressive impulses to someone else. One of the key features of borderline personality is the use of the splitting defense, whereby ambiguity that cannot be tolerated because of the emotional turmoil it creates leads the person to see the world in black-and-white terms, vacillating between all good or all bad. This picture can be very disruptive to treatment, as there is often a pattern of alternative idealization and denigration of the therapist.

C. Case Example

Consider a vignette from the treatment of a 26-year-old female patient, whom we will call T. T. is a graduate student, recognized as quite promising in her field. She came to session wanting to talk through a recent incident occurring at a conference where she presented a paper. She was the only member of the panel who had not yet obtained a Ph.D., and the others, and many in the audience, were already professors. T. described how she had taken a stand in her paper that sounded reasonable but was apparently considered iconoclastic. Thus, although she took a risk in asserting herself in this way in this forum, she did so knowing she usually had no problem discussing her intellectual ideas. T.

was upset, partially because she was attacked by the discussant and various audience members for her position, but mostly because she found herself capitulating and not making much of an attempt to defend her argument, cheerfully accepting their comments. (T. often finds herself avoiding conflict.) Furthermore, as is typical for her, she had subsequently become depressed because her talk was not uniformly praised and lauded by all present. She wanted assistance in understanding her behavior and ensuing reaction.

There are various ways to conceptualize T.'s dynamics, but we suggest one possibility using the three approaches of object relations, and self and ego psychology. First, from the perspective of ego psychology, we might view T.'s capitulation and putting on a positive face, frequent behavior that could be considered characterological, as stemming from the id-generated aggressive and competitive strivings that were met, not only with external opposition, but also with superego prohibitions against challenging her elders. Her solution was a passive surrender to the authority figures as a defense against her unconscious wishes. The defense mechanism used in this case would be considered a reaction formation, meaning she responded in the opposite manner to the way she really felt. She wished to attack back, but instead, was cordial and friendly. This would be a more traditional conflict–defense way of understanding her behavior, and the therapist would most likely interpret this dynamic by drawing the patient's attention to how she staved off undesirable impulses.

The fact that she became depressed because she was not responded to as a superstar reflects ongoing narcissistic issues. From a self psychology standpoint, it is apparent that T. needs a great deal of validation and admiration from others or her self-esteem collapses into depression. The object-relations piece might be that she has an internal model of herself needing to be perfect or she will be rejected as bad by others. The interventions that would follow from formulating this aspect of the case in this manner might be to empathize with how difficult it must have been for her to get the reaction she did, and to try to help her reflect on her tendency to condemn herself for not being perfect, ending up becoming depressed.

IV. COGNITIVE-BEHAVIORAL THERAPIES

The cognitive-behavioral tradition, generally speaking, focuses predominantly on consciously available

thoughts and observable behaviors. Compared with psychoanalysis and psychodynamic psychotherapy, cognitive-behavioral treatments tend to be shorter in duration, more specifically goal oriented and skills focused, with more directive interventions by the therapist. There are several treatment variations from within this paradigm that have been developed specifically for character pathology.

A. Cognitive Therapy for Personality Disorders

1. Description

Aaron Beck and his colleagues originally developed a cognitive approach for treating depression and subsequently extended its application to problems associated with personality disorders. Fundamental to this approach is assuming a stance of “collaborative empiricism,” that is, the therapist and patient together collect information about the patient's typical and troubled ways of thinking, feeling, and behaving, particularly in the context of problematic situations. An explicit profile of the patient's problems is proposed, goals for the treatment are agreed on, and treatment is focused on modifying maladaptive thoughts and behavior patterns. Because of the nature of character pathology, particularly those with more severe problems such as borderline personality, certain modifications were made to the cognitive approach. First, it is assumed that treatment will take longer, that the collaborative approach between patient and therapist must occur within clearly established boundaries, and that more pervasive and entrenched patterns of thinking and activity will be the focus of therapeutic work. In addition, the therapy relationship in and of itself may be the focus of attention at times because character pathology often serves to make an ongoing collaboration difficult to sustain.

2. Theoretical Bases

Cognitive therapy rests on the assumption that people are information-processing beings who develop characteristic ways of thinking about and interacting with the environment. Psychopathology arises when maladaptive responses are developed stemming from perceptions and beliefs that became distorted because of innate sensitivity, early social learning, and, in certain cases, traumatic events. People are thought to respond to the environment based on their established “schemas,” which include intrinsic assumptions about how the world works and how one should respond. Behaviors become programmed based on the individual's

particular collection of schemas. In most cases, patterns have become automatic and so are outside of the person's immediate awareness.

When cognitive therapy is applied to character pathology, it is assumed that broader core beliefs, rather than merely selected processing errors, are at the root. Character pathology is seen as resulting from dysfunctional "pervasive, self-perpetuating cognitive-interpersonal cycles" in which experiences often end up confirming long-standing maladaptive schemas. Beck believes that personality traits evolved originally as a set of stereotyped, but adaptive, strategies for responding to the environment. Personality disorders arise when traits are no longer appropriate to environmental circumstances.

B. Schema-Focused Cognitive Therapy

1. Description

As an extension of Beck's cognitive therapy for personality disorders, Jeffrey Young and his colleagues formulated the concept of an "early maladaptive schema," defined as "a long-standing and pervasive theme that originates in childhood; defines the individual's behaviors, thoughts, feelings, and relationships with other people; and leads to maladaptive consequences." Applied specifically to characterological issues, the goal of schema-focused therapy is to help patients to identify cognitive distortions and challenge underlying beliefs that routinely result in impaired psychosocial functioning. For example, one might hold to a maladaptive schema centered on the fear of being abandoned, which results in excessive jealousy and clinging in relationships. The therapeutic approach would be to assist the patient in uncovering his or her assumption that significant others will inevitably leave and the connection of that assumption to particular behavioral and emotional responses. Over time, the patient is encouraged to develop other ways of relating to replace the counterproductive modes, accompanied by shifts in thinking and affective reactions.

2. Theoretical Bases

Maladaptive schemas arise as deeply entrenched patterns of response that developed as the child tried to organize personal experience of himself or herself and others in a world that may have been filled with abuse, instability, or neglect. Although they may have served as logical solutions in childhood, they remain in play in adulthood as ineffective means for meeting basic security and intimacy needs, and, thus, are asso-

ciated with negative emotions and impaired functioning. David Bricker, Jeffery Young, and Catherine Flanagan have proposed three domains, or groupings, of schemas: instability and disconnection, impaired autonomy, and undesirability.

C. Dialectical Behavior Therapy

1. Description

Dialectical Behavior Therapy (DBT), developed by Marsha Linehan, is a method developed specifically for the treatment of borderline personality disorder, particularly for those patients with chronic problems with suicide gestures and attempts. Combining techniques from cognitive, behavioral, and supportive approaches, the goals of the therapy are to reduce life-threatening behaviors, behaviors that interfere with the treatment process itself, and behaviors that significantly impair quality of life. DBT is based on a manual, and patients participate in both weekly individual and group therapies for 1 year. During this time, individual therapists are accessible by telephone between sessions, and the groups focus on skills training targeting interpersonal, distress tolerance, and emotional regulation issues.

2. Theoretical Bases

Within the DBT paradigm, the nature of borderline disturbance is thought to revolve around impaired regulation of emotions, stemming from biological sensitivity interacting with an early environment lacking in emotional validation. Linehan has defined the term dialectics as "the reconciliation of opposites in a continual process of synthesis." This applies most broadly to the notion that treatment must provide an environment of acceptance of the ways patients currently are while also trying to help them change. That is, because of the presumed roots of borderline issues, the patient's current experiences are validated by the therapist, while at the same time, problem-solving efforts are aimed at modifying maladaptive thinking patterns and information processing, and teaching new ways of coping. The therapy relationship is considered central as the laboratory for change, but also because, at times, it is the only thing that is keeping seriously suicidal patients alive.

D. Case Example

The following is an application of various aspects of the cognitive-behavioral models presented to a particular case. K. is a 30-year-old unemployed woman who sought treatment because of difficulties holding down a

job, problems getting along with people in general, frequent outbursts of temper, and intermittent suicide gestures. Initial evaluation confirmed that K., along with symptoms of major depression, suffered from borderline personality pathology. Although highly intelligent, with an advanced degree, K. described how she would always get into struggles with her supervisors because they were envious of her ability and highly critical of her. Both in professional and personal relationships, she would become enraged over perceived minor slights, either blowing up at the other person, or injuring herself with a knife or a razor blade.

If K. found her way to DBT, she would be assigned an individual therapist and join a group. The individual therapist would help her learn how to manage emotional trauma through establishing a hierarchy of issues. Problem-solving techniques would first target those issues at the top of the hierarchy, such as her self-harm behaviors and emotional reactions that may jeopardize the treatment. K. would be assisted in reconstructing in detail the series of events that led to a self-harm incident, so that alternative solutions may be explored. From week to week, her hierarchy would be revisited to determine what issue was of highest priority for intervention. Once safety issues were adequately addressed, the treatment would be able to focus more directly on the nature of K.'s troubled interactions with others. The therapist would be diligent in attempting to avoid reinforcing any of K.'s maladaptive patterns. At the same time, in group treatment, K. would receive skills training, such as improving social tactfulness, which helps to enhance and reinforce the work in individual treatment.

In cognitive therapy, K. would collaborate with her therapist in developing a list of goals, with changing self-harm behaviors as top priority. In general, the focus would be on identifying maladaptive thoughts and behaviors so that alternative approaches could be developed. Given K.'s interpersonal sensitivity, the therapist would also be attentive to her engagement or resistance to cooperating in the therapeutic endeavor. If Young's specific schema-focused view were applied, K. would be assisted in identifying specific internal scripts that were not serving her well. For example, K. most likely has some form of an "abuse/mistrust" schema whereby she expects that others will hurt her or react negatively to her in some way. Using the therapy relationship as a model of safety and trust, K. could begin to examine and challenge her assumptions that others always approach her with ill intent.

V. EMPIRICAL STUDIES

In 1999, J. Christopher Perry published an analysis of 15 studies of the effectiveness of psychotherapy for patients with personality disorders. The studies reviewed were the most rigorous of their kind in that the investigators used systematic methods to diagnose the disorders, along with validated outcome measures. 4 of the studies focused on borderline personality disorder: there was one on borderline and schizotypal disorders, one each on avoidant and antisocial personality disorders; and 8 examining mixed types of personality disorders. 6 studies evaluated psychodynamic psychotherapy: three evaluated cognitive-behavioral psychotherapy, and three compared the psychodynamic and cognitive-behavioral treatments. Treatment duration varied, with a median of 28 to 40 sessions. The frequency of sessions ranged from daily in an inpatient study to once or twice weekly for outpatient therapy.

Despite wide variation in patient type, treatment type, and duration and frequency of sessions, an overall pattern emerged indicating significant improvement in psychopathology for patients with personality disorders receiving psychotherapy. In studies reporting the proportion of patients no longer meeting criteria for a personality disorder at follow-up, 52% had "recovered" after a mean of 78 sessions over a mean of 67 weeks. This corresponded to a recovery rate of 26% per year of treatment, seven times greater than the rate observed when the course of these disorders is followed when no treatment is received.

There have also been a number of other research endeavors, such as the Menninger Psychotherapy Research Project, that have employed a variety of methodologies targeting different aspects of psychotherapy treatments of character pathology. Separate review articles highlighting many of these other studies have been written by Mary Target and Glen Gabbard. In addition, a very recent study by Anthony Bateman and Peter Fonagy demonstrated significant reductions in symptoms, including self-mutilation and suicide attempts, and notable improvements in functioning for patients with borderline personality disorder who received intensive psychodynamic psychotherapy over 18 months in a partial hospitalization program. Benefits increased or were sustained at a follow-up evaluation 18 months after discharge. Thus, although some would hold that those with more severe character pathology may not be treatable, empirical work has shown that psychotherapy can be quite effective.

VI. SUMMARY

Character pathology is associated with a long-standing and rigid set of personality traits that cause impairments in a person's ability to adaptively function in interpersonal and occupational realms. Because there are many types of character pathology, or personality disorders, any psychotherapy addressing such problems must take into consideration the salient features of the particular patient's personality so that an effective therapeutic partnership can be formed and appropriate interventions can be applied. There is a range of therapies available from psychodynamic/psychoanalytic treatment that utilizes insight-oriented and supportive elements and the therapeutic relationship as vehicles for change, to cognitive-behavioral strategies that focus on consciously available thoughts and observable behaviors. Regardless of the type of psychotherapy chosen, it should be expected that enduring changes in personality pathology will require an extended period of treatment.

See Also the Following Articles

Beck Therapy Approach ■ Cognitive Behavior Therapy ■
Control-Mastery Theory ■ Countertransference ■

Dialectical Behavior Therapy ■ Object Relations
Psychotherapy ■ Psychodynamic Group Psychotherapy ■
Self Psychology ■ Transference

Further Reading

- Clarkin, J. F., & Lenzenweger, M. F. (1996). *Major theories of personality disorder*. New York: Guilford Press.
- Gabbard, G. O. (2000). *Psychodynamic psychiatry in clinical practice*. Washington, DC: American Psychiatric Press.
- Gunderson, J. G., & Gabbard, G. O. (2000). *Psychotherapy for personality disorders*. Washington, DC: American Psychiatric Press.
- Kernberg, O. F. (1984). *Severe personality disorders: Psychotherapeutic strategies*. New Haven, CT: Yale University Press.
- Kuehlwein, K. T., & Rosen, H. (1993). *Cognitive therapies in action*. San Francisco: Jossey-Bass.
- Lax, R. F. (1989). *Essential papers on character neurosis and treatment*. New York: New York University Press.
- Linehan, M. M. (1993). *Cognitive-behavioral treatment of borderline personality disorder*. New York: Guilford Press.
- Masterson, J. F. (1988). *The search for the real self: Unmasking the personality disorders of our age*. New York: Free Press.
- Millon, T., & Davis, R. D. (1996). *Disorders of personality: DSM-IV and beyond*. New York: John Wiley & Sons.
- Shapiro, D. (1965). *Neurotic styles*. New York: Basic Books.

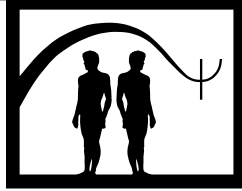

Child and Adolescent Psychotherapy: Psychoanalytic Principles

Steven Marans, Kirsten Dahl, and John Schowalter

Yale Child Study Center

- I. Developmental Frames of Reference
 - II. Aims of Dynamic Psychotherapy
 - III. Therapeutic Tasks
 - IV. Transference
 - V. The Therapist–Child Interaction
 - VI. The Interview Setting
 - VII. Developing the Therapeutic Process
 - VIII. Working with Parents as an Adjunct to Treatment
 - IX. Child Psychoanalysis
 - X. Conclusion
- Further Reading

GLOSSARY

conflict Refers either to psychic conflict, which is a struggle between incompatible or opposing forces within the mind or external conflict. Psychic conflict may be between incompatible wishes (e.g., the child's wish to please a parent and his wish to be in control) or between different psychic structures or aspects of the mind (e.g., a wish to make a mess might be opposed by the individual's conscience that upholds values of cleanliness and order). Sometimes psychic conflict may become externalized in the individual's effort to avoid anxiety or other uncomfortable feelings. In this situation a conflict that originates within the individual is experienced as originating from outside forces (e.g., the adolescent who is ambivalent about his sexual wishes may experience himself as unconflicted by imagining that his parent is opposed to his developing sexuality). External conflict describes essential conflicts that arise between the individual and aspects of the outer world, when there are incapacities in either the individual or the environment to meet the other's needs and expectations.

countertransference A complementary term to transference and refers to the therapist's experiencing thoughts and feelings toward the patient that are derived from an earlier period and earlier relationships in the therapist's life. Countertransference is usually mobilized in response to a particular transference of the patient and reflects the therapist's unconscious reaction to aspects of the patient. It may be manifested in the therapist's identification with the patient, by intense emotional reactions both positive and negative to the patient or particular material. When countertransference is unrecognized it can create significant blind spots for the therapist compromising, his or her ability to work clinically by impairing objectivity and empathy. In contrast, when the therapist is able to recognize and analyze his or her own countertransference, he or she may gain significant clues to the patient's thoughts and feelings.

representation Usually refers to a psychic representation, which is an image or configuration of images within the mind. This may be an image that roughly corresponds to a figure or experiences that an individual has had in real life. Representations are very often based on a composite of memories, affects, impulses, and wishes associated with important figures and interactions with those figures that have been experienced in an individual's life. Representations also refer to the images of oneself that are also based on a range of experiences, especially those involving the earliest and most significant relationships.

transference Refers to the displacement of feelings, thoughts, and behavior about significant childhood figures (usually the parents) onto another person. Transferences are thought to be ubiquitous, occurring in and coloring any individual's important current relationships. When the term is used in the context of psychotherapy transference refers to the displacement of thoughts, feelings, and behavior originating

in relation to the individual's parents (or other emotionally significant figures) at an earlier point in time (usually childhood) onto the therapist. Transference is unconscious and involuntary, the sources being unrecognized, and may be experienced by the individual as rational or may feel inappropriate and be a source of internal distress. There is disagreement within child psychoanalysis whether young children are capable of transference since the young child is actively involved with his or her parents in reality. A young child may behave toward his therapist in much the same way he behaves with his parents but this may be less an issue of transference and more the result of habitual ways of interacting with others. For example, a 3-year-old who is imperious and demanding with his parents may be equally so with his therapist, but this is less likely to be transference and much more likely to be the way this child treats any important adult. Latency-age children in the course of psychotherapy may exhibit behavior or feelings that more closely fit the definition of transference in that the behavior can be understood as referring back to an earlier time and relationship with the parent. Adolescents readily exhibit transference and indeed this may form a significant resistance to psychotherapy as the adolescent experiences the therapist as the all-powerful, controlling parent from very early childhood. When transference is understood it can provide clinically useful material that can be used to help the patient better understand himself.

unconscious Used both as a noun to describe hidden aspects of the mind and as an adjective to describe mental content that is not available to conscious awareness. Freud originally believed that the unconscious was a dynamic system within the mind that contained contents and activities representative of the drives that had never been conscious. Characteristics of the unconscious are that there is no negation, contradiction, or ambivalence and that unconscious thought follows idiosyncratic associative paths rather than logical connections. Although the unconscious is not available to direct inspection, derivatives can be seen in dreams, in slips of the tongue, and disconnected thoughts. Current psychoanalytic theory argues that aspects of psychic structure involving adaptation to reality, defenses, and moral judgement are unconscious. Mental content may also become unconscious through the operation of defenses against the experience of intrapsychic conflict.

Psychoanalytic theories of human functioning begin with a focus on the interplay between the child's fantasy world, the organization of mental life and functions, and the experience of the real world. How these domains are elaborated and interact over the course of development is central to psychoanalytic inquiry. Psychoanalysts and psychoanalytically oriented psychotherapists are especially interested in the most

personal of emotions and thoughts and the ways in which individuals reveal or conceal their longings, wishes, fears, pleasures, and dreams to and from themselves and others. Psychoanalytic clinicians are interested in the way children behave and in the interaction between children's inner experiences and their actions in daily life. Of particular concern for analysts and analytic therapists are the ways in which the child comes to understand and represent his or her own inner life and the minds and behavior of others. As such, psychoanalytic theory is primarily concerned with the dynamics of mental processes and individual experience that are influenced by biological, social, and environmental contributions. With psychoanalytic theories as a conceptual frame of reference, psychodynamic psychotherapy attempts to observe the rich details of children's individual experiences as a way into understanding the origins and functions of symptomatic behavior that brings them into treatment.

Psychodynamic interventions are based on the notion that symptoms and problematic behavior that have not yielded to time or changes in the external world derive from a complex matrix of constitutional, developmental, and environmental factors that find representation in children's fantasies and theories about themselves, their expectations of the world, and their adaptation to it. In this context, symptoms are seen as a result of children's best efforts both to resolve and to express in disguised form solutions to conflicts among their wishes, the demands of external reality, and developmental capacities. What distinguishes a psychodynamically oriented intervention from other types of clinical intervention is the therapist's conviction that children's behavioral difficulties have as their source the complex interplay between the wishes and fears inherent to children's inner world; the status of biologically driven, maturational capacities; the pressures of progressive development; and the demands of external reality. Psychodynamic interventions may be employed in varying forms, including psychoanalysis, intensive psychotherapy with several sessions per week over a long period of time, weekly psychotherapy, brief psychotherapy, structured sessions, and parent-child guidance. The guiding principle of psychodynamic intervention is that throughout development, there is a complex interaction between internal and external demands and children's unfolding capacities to meet these demands. The goal of psychodynamic psychotherapy is to help children find alternative solutions to conflicts that have given rise to symptoms that interfere with current functioning and progressive development.

Essential to psychodynamic interventions is the recognition that defenses against danger—whether experienced as emanating from the inner or external world—are felt by the child to be necessary, regardless of how disruptive these defensive maneuvers may be. On that basis, the central task of intervention is to learn in what way symptoms serve to protect children from and help them adapt to unconscious conflict aroused by the demands of development and of everyday life. The therapist's capacity to understand meaning in the child's presentation in play, activity, and discussion occurs in the context of a relationship that provides a safe forum for the communication of feelings, impulses, and ideas that children have about their life, self, and others. As the relationship between a child and therapist deepens, the child becomes better able to tolerate and be curious about his or her inner life and the multiple ways internal conflicts may compromise development and daily functioning.

The clinician's choice of dynamic psychotherapy may be made when considering a range of presenting clinical situations. In addition to being the treatment of choice for children suffering internal conflict, a dynamic perspective also informs treatment considerations for a diverse range of clinical presentations in which internal conflict appears to be absent, such as conduct disorders. In conjunction with pharmacological, educational, and behavioral management interventions, psychodynamic psychotherapy may be the treatment of choice in working with a child who is coping with chronic illness or a matrix of constitutional, cognitive, and developmental deficits or with a child who has experienced acute or cumulative trauma. In each of these clinical situations, the dynamic psychotherapist's primary tasks are to learn the language of the child and to develop a relationship that provides a forum in which the child can explore his or her experience of self and others while trying on new solutions to difficulties that have blocked the path to optimal development.

I. DEVELOPMENTAL FRAMES OF REFERENCE

Conceptualizations about unconscious conflicts are central to any psychodynamic approach to intervention. Here, "unconscious" refers to the dynamic interaction of thoughts, feelings, memories, bodily experiences, and thought processes that operate outside of an individual's conscious awareness. These unconscious configurations of experience exert influence on patterns of

behavior, interactions with others, perceptions of the world, and feelings about the self. Many behavioral symptoms of childhood reflect children's defensive efforts to ward off dangers that they experience as originating in the intensity of their urges and wishes; in the severity of internal, superego judgment of those wishes and feelings; or in the limitations and demands imposed by the environment.

A. Case Example

Five-year-old Jerry was referred by his kindergarten teacher because of his aggressive attacks on the other boys in his class. Jerry's attacks appeared to be unprovoked: He might be playing in an apparently cooperative way with another boy and suddenly become quite angry, accusing the other boy of having tried to grab something from Jerry or of having somehow insulted him. Following these outbursts, Jerry appeared unremorseful, adopting a swaggering, somewhat threatening stance. At times Jerry could be heard bragging loudly to the other boys about his athletic accomplishments as well as his many possessions; some of these tales seemed to reflect reality, albeit with a bit of exaggeration, but others were quite clearly false. Jerry got along very well with his female teacher toward whom he was quite affectionate and whom he sought out frequently for special attention. On the playground Jerry often raced around wildly, drawing attention to himself, declaring dramatically that he was Batman or the fire chief or some other heroic figure. After a careful evaluation, Jerry was referred for once a week psychodynamic psychotherapy. Gradually, in talking and playing with Jerry, his therapist began to understand that Jerry's braggadocio and swagger masked an intense underlying anxiety that he was not big enough or adequate enough in comparison with his classmates. Jerry had anticipated starting kindergarten with some trepidation, worried that he did not know enough academically. His dreams of being a big successful grade school boy were accompanied by fears that he would instead be humiliated by not knowing enough. His attacks against the other boys were Jerry's attempt to restore his precarious self-esteem by appearing aggressively manly at those moments when he felt most threatened by another child's accomplishments, whether real or imagined. Jerry was still quite dependent on his teacher's affection and interest to sustain feelings of self-worth. When he was in situations with his classmates that were more competitive and in which he could not count on his teacher's ready attention, Jerry's self-esteem was

more fragile and more easily threatened by perceived slights. At those moments, Jerry felt in danger of being overwhelmed by feelings of humiliation brought on by his own age-appropriate but quite intense wishes for success that he felt were eluding him. His hitting out and swaggering involved an underlying compensatory fantasy that he was not a little boy who did not know enough but that he was a big, powerful man who would win the admiration of others, especially his teacher, through force.

Children's struggles with basic conflicts between their desires and the limitations imposed by reality and internal moral prohibitions motivate their exploration of alternative forms of expression that both satisfy strong urges and meet acceptable internal and external standards. This compromise solution is shaped by the specific age-typical wishes in conjunction with the child's capacities as set by endowment as well as by opportunities available in the environment. Children's unfolding intellectual and physical resources; opportunities afforded in the social realms of home, school, and the community; and ability to tolerate delay and accept substitute gratification all contribute to their ability to create compromise between competing demands of their inner worlds and external reality. As such, symptoms may also reflect children's efforts to negotiate developmental conflicts as they seek mastery, independence, and pride in midst of increasing demands and dangers.

At each phase of development there tend to be nodal conflicts that inevitably give rise to crises and symptoms of childhood that evoke concern in the adults who are most involved with children. Although the disruption of sleeping and eating behavior and separation anxiety typical in toddlerhood are troublesome to caregivers, they do not necessarily indicate deviation from normal trends in development. These developmentally expectable symptoms are especially salient during the time of children's emerging recognition that they are individuals, separate and different from their parents, whom the children wish to please. Similarly, the nighttime fears, transient phobias, and defiance of 4- to 6-year-old children do not automatically represent psychopathology but, rather, reflect their active attempts to negotiate conflicts between normal feelings of love, hate, jealousy, and competition. Older preschoolers or early grade school children have ambivalent feelings about establishing a greater sense of autonomy. These mixed feelings may be expressed in testing rules, tattling on others, social difficulties, rapid shifts in mood, or heightened concerns about bodily changes; they do not automatically signal the need for clinical intervention.

Additionally, above and beyond the symptomatology of normal development, children's behavior or mood may change in direct response to clear external precipitants, such as moving to a new house, changing schools, parental discord and divorce, acute illness, or exposure to exceptional, traumatic incidents, or it may reflect the stress of coping with cognitively based learning difficulties. Children undergoing such external stressors may require supports or interventions that are informed by an appreciation of the dynamic interaction of multiple contributions, but they do not necessarily warrant extensive individual psychotherapy. When conflicts and attendant symptoms are primarily reactive in nature, work with parents and teachers to alter a child's environment or to increase adult appreciation for the nature of developmental struggles may be sufficient. Such intervention, when based on psychodynamic principles, can help a child mobilize adequate resources to achieve a more adaptive set of responses and so resolve the immediate crisis. Alternatively, at times, a careful evaluation reveals a history of a child's failure to successfully negotiate previous developmental tasks.

When presenting difficulties have not yielded to environmental manipulation, the severity and persistence of symptoms may reflect a relatively intransigent adaptation to internalized conflict that the child experiences as protective but that actually exacts a high price for both the child and those around him or her. In this situation, the adult's logic, suggestions, and admonitions are at exasperating odds to the child's counterproductive, albeit best attempts to resolve the internal conflicts that seem to elude conscious recognition and rational response. In such a case, the psychotherapeutic task with the child is to provide a new, different setting in which the therapist and patient can develop a language for exploring what has heretofore been unknown to both. A therapist should decide to engage a child of any age in dynamic psychotherapy based on a careful evaluation of the patient's presenting difficulties, developmental history, and family and environmental circumstances. Dynamic psychotherapy is called for when the child's difficulties reflect a failure to negotiate conflicts that are at once an essential part of every phase of development and at the same time have become elaborated, and fixed, requiring an expenditure of psychic energy that impedes rather than promotes developmental progression. As such, children may adopt and rigidly adhere to defenses that help them to ward off the danger while constricting the development of new defensive strategies that might provide more flexible adaptation to both internal and external demands.

The adolescent's tasks are negotiating parental emancipation and the sexual and aggressive drives. It has also

been noted that adolescents in some ways recapitulate tasks faced in the first few years of life. During that early age, children must learn to control their volitional outflow. The preschooler, for example, becomes aware that his or her sexual attributes are not sufficient “in that way” to attract the parent of the other gender and that his or her fortitude is not sufficient to fend off the jealousy of the same gender parent. With puberty the adolescent now feels sexually ready and available. A true oedipal victory becomes actually possible. At this time the universal incest taboo comes into play and the adolescent must learn to control the associated emotional outflow. Although adolescents possess the strengths of greater experience and the cognitive ability to think abstractly, their task of becoming an adult is hampered by both the upsurge of their drives and the developmental need to individuate from parents. This latter change partly removes the primary sources of stability and support counted on during childhood. Oedipal feelings suppressed with the advent of the superego often reemerge. The adolescent feels the need to increase the emotional distance from both parents. Not only are parents avoided as people, but also their parental prohibitions internalized within the superego may be distanced. Although unacceptable aggressive or sexual behavior often brings an adolescent into treatment, inner conflicts between progressive and regressive urges are the chief foci of psychodynamic psychotherapy.

II. AIMS OF DYNAMIC PSYCHOTHERAPY

As trial action in thought, fantasy is a testing ground that serves as a refuge from the disappointment of wishes that cannot be fulfilled by reality. When the child is not yet able to give up certain wishes and has been unable to find acceptable alternatives for satisfying the underlying urges, fantasy may serve as both a retreat and as a means of titrating their intensity as new solutions are sought. Thus, fantasy can serve as a respite and as a staging ground on which new responses to internal and external demands and new solutions to conflicts can be practiced. Fantasy solutions themselves may prove to be enormous sources of anxiety and guilt. While serving as a retreat from conflicts aroused by disappointment and/or by frightening reality, fantasy solutions for conflict can also become a distorting lens through which the child now perceives his or her world. These phenomena may best be demonstrated in the case of a child whose experience of real danger invokes fantasy solutions that also contribute to the patient's difficulties.

A. Case Example

Annie was 6 years old when she was involved in a traffic accident while riding on her school bus. She was unhurt, but a classmate suffered serious head injuries after he was slammed against a bus window. Annie entered two times a week psychotherapy when, 6 weeks following the accident, she continued to be symptomatic. She had difficulty sleeping and eating, had multiple new fears, and needed to remain close to her mother at all times. Annie's previous school functioning was good, as was her adaptation in an intact family that included mother, father, and a 10-month-old brother. Her developmental history was unremarkable.

In her individual sessions, Annie repeatedly returned to the scene of the accident, reviewing an increasing array of details in both play with toy figures and in her drawings. Each narrative was ended with Annie looking and stating that she felt scared or “bad.” Over time, the therapist probed these feelings further—either within the action of the play or the narrative that accompanied the pictures. Annie would elaborate that she felt scared she might have been injured in the accident and very bad because her friend had been hurt. In one session, she drew a picture of herself and her friend on the bus. Although the two children had in fact been sitting in different sections of the bus, in her drawing, they both sat on the same seat. She pointed out that even though they were together only one of them was hurt. She then grew quiet and looked forlorn. With the suggestion that there was a connection between her feelings and the story that lay behind the picture, Annie revealed a secret whose telling spanned many sessions and was accompanied by a dramatic reduction and final resolution of her presenting symptoms.

The first part of the secret was that for several days before the accident, Annie had been reprimanded by the driver for bad behavior on the bus. She thought that perhaps she should have been the one injured, as a punishment. Later, she told the therapist that her “bad” behavior had really been about her teasing and poking at the very classmate who was hurt in the accident. The third part of the secret was about her baby brother. With great anxiety, Annie reported that she teased the baby on numerous occasions and that, in fact, she often wished the brother was no longer around. With this, the pieces of her worry and guilt became clearer. She was able to articulate her fear that somehow her bad wishes about pesty brothers had come true in the injuries sustained by her schoolmate in the accident. Annie was terrified that her wishes would be discovered and severely punished. The therapist was able to

point out that Annie was punishing herself as if the reality of the scary events had somehow been under her magical control.

Annie's hostile wishes toward a rival baby brother and their displacement onto a schoolmate was not at all unusual. However, for Annie, the realization of these wishes—if only in the displacement—constituted the central source of her overwhelming anxiety and traumatization. In addition, her sense of magical control reflected age-expectable phenomena but was relied upon for the purposes of restitution and recovery. That is, a belief in magical control would revise the original experience of traumatization or “absence of control” in the accident, even if the belief in magic might also lead to a tremendous sense of responsibility for and guilt about the real and imagined events. Annie's presenting symptoms resolved as play and discussion with the therapist revealed the connection between the traffic accident and her age-expectable wishes and conflicts. When no longer unconscious, the distorting and anxiety-laden solutions to Annie's conflicts became clear to her. Symptoms were no longer necessary as Annie's fear and guilt were replaced by her tolerance of her own feelings. She could recognize that being frightened in the face of an external danger was not a permanent state of infantile helplessness, that hostile feelings about family members did not obliterate loving ones, and that whatever the benefits, a belief in magic does not make wishes come true.

As suggested in the case of Annie, the use of fantasy as refuge from conflict and anxiety may not always be successful or may evoke its own set of problems for the child. While unable to give up the original aims, fantasy configurations may themselves become a source of internalized conflict. Clinging to the solutions found in these fantasies may block more reality-based compromises between wishes and consequences that might be developed. In the face of challenges the child faces in the present, he or she may return to earlier configurations of wishes, unable to utilize new developmental competencies to mediate as well as express current feelings. Retaining their original force, these developmentally regressive fantasies are also experienced as unacceptable; the conflicts that ensue may only find expression in disguised form in symptoms and age-inappropriate behavior. For all of these reasons, Freud's guiding principle of “making the unconscious conscious” remains central to the psychotherapeutic task of alleviating symptomatic presentation and helping children return to the path of optimal development. Psychodynamic treatment attempts to provide a setting in which the child and thera-

pist can observe the different manifestation of their feelings and fantasies and their representation in symptoms and behavior. With the therapist's help, the child achieves a greater appreciation of the conflict between wishes and the demands of external reality and internal moral judgments. Through play, discussion, and interactions in the consulting room, children have the opportunity to try out new solutions in an effort to find a compromise that permits some realization of their wishes while simultaneously adapting to the limitations imposed by reality and by internalized moral values.

Regardless of the unconscious, conflictual sources, academic difficulties; constant fights with peers, siblings, and parents; soiling; enuresis; disturbed sleep and eating; social isolation; drug and alcohol abuse; avoidant behavior and phobias; and depressive withdrawal may cause a great deal of discomfort to patients themselves and to their families. However, from a psychodynamic perspective, these symptoms represent the individual's best attempts to simultaneously defend against conflictual wishes and to give expression to them in a disguised form. While attempting to avoid or modulate threats to well-being, symptoms are highly condensed modes of communication that parents, teachers, or patients themselves have been unable to translate fully and understand. In making the unconscious conscious, dynamic psychotherapy aims to provide a setting in which the patient can safely explore previously “unknowable” aspects of their inner world that give rise to conflict, defense, and maladaptive ways in which they negotiate daily life.

Threats to self-esteem arise from internalized conflicts involving the guilt and shame associated with internal moral judgment as well as with failures of achievement in the external world. For example, by the late preschool years, children recognize that their destructive wishes toward parents or siblings are incompatible with their intense loving feelings and need for these same people. The little boy who wants to destroy all of his competition from the field, particularly his father or older brother, also loves his father, wants to be like him, and needs to feel that his father loves and approves of him. The child may experience so much pain about this struggle between his loving and hating feelings for the father, or other loved figure, that they are pushed out of consciousness, only emerging now in highly disguised or displaced forms. Such conflicts between intense feelings, wishes, and aims occur naturally in development. However, they may be complicated by multiple and interweaving contributions from children's lives, such as (1) a history of risk, or realization

of attack, either emotional or physical, by parents or other caregivers in response to the child's expression of developmentally appropriate needs; and (2) the failure of age-expectable capacities to regulate impulses and needs that lead to feeling flooded and overwhelmed. Children may also fear being overwhelmed by impulses and needs when (1) their capacities for self-regulation are compromised by constitutional hypersensitivities, inadequate visual-motor apparatus, chronic illness, disordered language and cognitive development, skeletal or neuromusculature abnormalities; (2) the mental capacities that are in place are not able to reduce the level of environmental overstimulation—for example, interpersonal violence in the home and in the neighborhood; the absence of external order as represented by consistent parental rules and expectations; exciting exposure to parental nudity or sexual activity; or (3) a history of repeated failure of satisfaction of children's basic needs—such as poor bodily and physical care—with the associated somatic distress, discontinuous and unreliable presence of the caregiver, or inconsistent and unpredictable communication of affection. However powerful the specific stressors or risks might be in the child's life, his or her capacity to mediate their impact is determined by a combination of endowment, available defenses, and countervailing external supports. Optimally, an increasingly broad and sophisticated array of mediating activities, and the background of experience that needs will be met in a timely fashion, allow children to achieve satisfaction, pleasure, and mastery.

Seeking safety and securing pleasure are the most central of human endeavors that guide children's attempts to guard against danger and helplessness. When the dangers and threats are based in current experiences, interventions first must focus on remedying or alleviating the most immediate and persisting risks to the child's development (e.g., mandated referrals to protective services when a child is neglected, abused, or sexually exploited; intensive work with parents, educators, and social services in altering the child's milieu). Similarly, when neuropsychological and other impairments of the physical and cognitive apparatus can respond to pharmacological interventions or remedial assistance, these approaches need to be considered as central to the overall treatment plan. Often, the history of environmental failures or inherent problems of affect regulation or cognitive processing will have had an impact that changes in the environment, educational and pharmacological interventions alone will not ameliorate maladaptive attempts at conflict resolution. At the point that children need to enter psychotherapy,

their attempts to defend against internal pain and discomfort are at too high a price. Their symptoms, effects, and behaviors reflect both the child's best efforts, and failure to negotiate the challenges, demands, and conflicts that are essential components of progressive development.

Unlike adults, children and adolescents rarely are the ones who request or make decisions about entering into psychotherapy. Children are often told that they are going to see a special kind of doctor who helps get rid of worries and difficulties in order that the child is able to feel happier and more successful in life. It is essential that therapists remember that seeing a therapist does not magically or immediately relieve children of their suffering or decrease the need for the defenses and symptoms that have brought them to the consulting room. In fact, many children feel particularly guarded in the treatment situation, believing that their inner thoughts and feelings will leak out or be readily discernible to the therapist who is invested with intrusive and dangerous "mind-reading" powers. Engaging in an evaluation or entering into psychotherapy is especially difficult for most adolescents. Referral usually stems from the desire of a parent or other authority figure whom the adolescent does not fully trust, and may be in outright conflict with. The aim of the therapy to make the unconscious conscious does not vary from the aim with younger children or with adults, but patient-clinician trust is often more difficult to establish with adolescents than at any other developmental phase.

If the patient is to give up current, maladaptive attempts at resolving conflicts, a new setting, a new relationship, and a new language will be required. It is in this new situation that the patient and therapist have an opportunity to explore—through themes and consistent patterns of play, discussion, modes of expression, and ways of engaging—the dynamic interaction between what is internal and what is experienced in daily life. The psychotherapeutic intervention provides a stage on which, over time, the language of the unconscious fantasies, conflicts, defenses, and symptoms can become observable, translatable, and gradually understood. To this end, the psychotherapist engages in the process as an observer, a participant, and an anchor in reality, helping children clarify what they are thinking and feeling as well as noticing repetitive themes and patterns, making connections between themes and feelings for children. Interpretations assist children in understanding and mastering thoughts, feelings, and behaviors of which they previously had been unaware and that have given rise to the current difficulties. The

therapist uses verbalization, clarification, and interpretation in the context of a relationship that includes elements of transference, displacement, and therapeutic alliance.

III. THERAPEUTIC TASKS

For psychodynamic psychotherapists, children's play in the context of the clinical setting provides an important window into the inner life. The play themes, materials chosen, and the child's affects and verbalizations are viewed by the clinician as revealing complex aspects of the child's internal life of which he or she may be unaware and unable to verbalize directly. In the course of treatment and in the context of a developing therapeutic relationship, the clinician makes observations about the unfolding narratives that emerge in the play activities and what they reveal about children's conflicts, defenses, and consequent behaviors and modes of relating. The clinician does not comment on everything that is observed. The therapist chooses the material to be interpreted based on his clinical judgment about what is uppermost or closest to consciousness in the child's mind at that particular point in time. The clinician's goal in interpreting this material is to increase the child's conscious awareness of and insight into the relationship between unconscious conflicts, defenses, and manifest behavior and symptoms. For other clinicians the child's capacity to play and talk freely in the presence of another and to develop multiple narratives that give expression to underlying conflicts, interests, and concerns is therapeutic in and of itself. Particularly with regard to young children, this latter conceptualization emphasizes the action of play as serving the function of mastery through repetition and elaboration of central themes in their lives, trying on new solutions to problems as well as practicing and expanding the modes of representing them. In this model, the goal of interpretive work is not to create or enhance children's insight *per se* but rather to decrease the anxiety and defensive operations that disrupt or interfere with the expansion and unfolding of the play and/or discussion itself.

IV. TRANSFERENCE

Transference is the term used to describe or characterize the patient's attitude toward the therapist. The term derives from psychoanalytic treatment with adults

and refers to the ways in which a patient's perceptions of and relationships with significant figures from childhood are expressed in current perceptions, thoughts, fantasies, feelings, attitudes, and behavior in current relationships. In the clinical situation, transference refers specifically to the ways in which these experiences from the past are organized around and expressed within the relationship with the therapist. A major difference in considering this phenomenon in work with children lies in the fact that, unlike adults, children continue to live with and rely on parents. Much of what children bring to the treatment situation reflects not only a transference of aspects of relationships from the past but significant aspects of current experiences, fantasies, perceptions, feelings, and attitudes from current relationships, particularly those with parents and other family members.

The attitudes that children direct toward the therapist are one of the central markers of the transference relationship. These attitudes are also an essential ingredient in considering the child's ability or inability to play or engage in discussion with the therapist. This is especially the case at the beginning of a treatment, when children's expectations of what will occur in the sessions are not determined by specific past experiences with the therapist, but rather by expectations that derive from habitual modes of relating, current relationships, and past experiences with others.

In an attempt to clarify the phenomena of transference, particularly as it is observed in the treatment of children, Anna Freud and her colleagues developed a topology of transference of (1) habitual modes of relating (2) current relationships, (3) past experiences, and (4) transference neurosis. The first type refers to fixed ways of relating to others that, while deriving from earlier relationships, have now been applied to the world at large or to whole categories of people with whom children have contact. The second category refers to the transfer or displacement of current preoccupations with real situations in children's lives or with aspects of current developmental challenges. The emphasis here is on the distinction between a revival of past experiences versus the displacement of current ones that can be observed in children's relationships with the analyst. The third category involves children's attitudes, fantasies, and memories from the past that were previously repressed and that are now manifested in the current relationship with the therapist as it develops during regular contact over a sustained period of time. In the last category, there is a "very special intensification of the transference involving an externalization of a major pathogenic internal conflict

onto the therapist, so the conflict is felt by the patient to be between himself and the therapist, according to Sandler and colleagues in 1980 (p. 92). In child psychotherapy, it is much less common to see as much evidence of the transference neurosis as occurs in the analysis and psychotherapy of adults. When this form of the transference does emerge, the child's attention, interests, and preoccupations shift toward his or her interactions and relationship with the therapist.

Narrowly defined, the child's attitudes to the therapist are based solely on the internal configurations of experience, urges, feelings, and fantasies that are, in the main, a reflection of life outside of the consulting room. This notion assumes that the therapist's presentation and modes of relating to children have no or only minimal bearing on the ways in which the children present themselves in this particular setting. The opposite view suggests that the therapist's demeanor is always determining the child's attitude to the clinical encounter. Therefore, the child's attitude to the therapist cannot be used as a prominent source of data or window into the inner world. These two views reflect the extremes in considering the extent to which children's manifest attitudes toward the therapist are a pure reflection of their inner life or of their day-to-day experiences outside of the consulting room. That is, children's attitudes in isolation from other aspects of the fuller presentation of themes and emotional presentation may, in fact, tell the therapist very little about the children's central interests, fantasies, concerns, and modes of regulating and communicating them. In addition, even when considering children's attitudes in the broader context, initial impressions may not be borne out as the fuller picture of the children emerges over the course of the psychotherapy treatment. Rapid shifts in children's presentation may occur, from friendly, positive engagement to attitudes of hostility, disappointment, and fear. It is important to remember that children's attitudes to the therapist develop in the context of a unique setting and special relationship. As such, the clinical data emerge from observations of two people in the consulting room who set the stage for understanding the patient's experiences of themselves in relations to the many others who have and have had significance in both inner and daily life.

Transference issues with adolescents in psychodynamic psychotherapy are often very intense and threaten the formation or continuation of a therapeutic alliance. The aims of adolescence and psychodynamic psychotherapy are, at times, essentially hostile to one another. In structural terms, the ego's defenses are already tenuous because of the pubertal upsurge of drives.

Probing by a clinician of resistance and transference may seem to the patient too threatening to endure. This is particularly the case during early adolescence from approximately age 12 to 14 or 15. The transference reaction is often negative and that of a parent with whom the patient is having conflicts. The therapist can also represent an other-than-parent-adult transference that is positive in the way of a cult leader. This presents the difficulty of the patient's expectation of "cure" coming almost magically from the guru rather than from the patient's therapeutic work. Adulation of the therapist can also raise hostility on the part of the parents who must support and pay for the treatment.

A. Case Example

Mark was a 14-year-old who entered twice-weekly psychodynamic psychotherapy because of a drop in his grades in school and arguments with his father, which had transcended from only verbal interchanges to physical pushing and shaking. Both males were worried about this escalation. The referral was made by the boy's pediatrician. Mark did not want his parents involved with his therapist, and they as a couple began seeing another clinician. Mark was immediately impressed with the therapist, based on what his pediatrician had told him and because of various certificates and plaques on the office walls. Mark's father was an extremely successful attorney, not only locally but also nationally. In the almost instant transference, the therapist became the "good" father who was even more powerful than the biologic "bad" father. It was very difficult for the boy to acknowledge any good in his father or bad in the therapist until the transference took on an erotic component. As the homosexual urges became apparent to him, the patient struggled with whether to stay in treatment or flee. Remnants of the nonerotic positive transference allowed him to continue therapy. Now fearful of submitting to the clinician's control, Mark began working in therapy. He challenged the therapist's power, declaring it was not so much due to the therapist's excellence, but because he was part of an excellent university. Mark became more interested in flirting with girls in school and in improving his grades. He also came to appreciate his father's accomplishments, and the love the father must have for him in order to support and pay for the psychotherapy. The tussling between father and son undoubtedly also had a drive-defense sexual component for the boy, but after working through erotic feelings for the therapist, the son-father love also lost its overt sexuality.

Countertransference is an entity that all therapists must keep in mind. Countertransference is the unconscious influence that a therapist's past needs and conflicts have on his or her understanding, actions, or reactions within the treatment situation. James Anthony was the first writer to assert that because of the regressive pull inherent in working with children and the fact that child therapy is more primary process activity than secondary process talk, that countertransference is more commonly experienced in therapy with children than with adults. Burlingham in 1935 noted that in work with younger children, therapists may drift into a wishful role of being a superior parent. With the sexual and hostile proclivities of adolescents, therapists have a particular challenge not to be seductive or counteraggressive. The therapist's narcissistic concerns may also cloud his or her listening carefully, regardless of the patient's age.

V. THE THERAPIST-CHILD INTERACTION

A central focus of the clinician's observations is the way in which children relate to him or her, from the first introduction in the waiting area to the myriad shifts in attitude presented in the consulting room throughout the course of psychotherapy. From a psychodynamic perspective, ways of relating to the therapist reveal a great deal about children's attitudes to the most important people in their daily lives and suggest observable surface markers for a range of internal configurations involving their fantasies about those people. Children's attitudes toward the therapist suggest their feelings about being with an adult other than the parent. At most, the attitude children present in this particular setting may reflect a generalized set of expectations and modes of relating that have referents outside the consulting room, in the children's daily lives—from the present or the past. At the very least, the attitude presented may reflect aspects of children's expectations of the current situation in the consulting room itself.

Children's comfort in the room and their experience of their interaction with the therapist will be a key determinant of the play, discussion, and activities that occur in a given hour. Representations of self and others as reflected in play and discussion reveal the organization of the variety of composite images of self and others that children have constructed on the basis of experiences, urges, and feelings. These representations of the self and others, although never fully conscious, are reflected in children's ever-changing conscious fan-

tasies, attitudes, and behavior. In other words, the children's attitudes, suggested by the way they relate to others, reveal an internal frame of reference that draws on (1) their experience of interacting with similar figures and their awareness of an expectable set of social conventions; (2) the status of specific urges and the relative balance between the pleasure gained from their expression versus fear of potentially negative consequences in the form of shame, guilt, anxiety, or actual danger that might result from a clash with either internal or external expectations; and (3) the developmental status of a sense of self, that is, an appreciation for personal abilities that are now experienced as autonomous in relation to the parents.

Unlike other approaches to clinical interviews with children, psychodynamic technique eschews structured questions that aim at eliciting "mental status" on the basis of verbal responses and verbal information regarding attitudes and interests. It is assumed that children are most likely to reveal their interests, attitudes, and capacities in a situation that can become familiar and comfortable. This sense of familiarity and comfort can best be established by children themselves as they become acclimated to the therapeutic setting. The therapist is in the best position to observe what children bring to the sessions if the therapist's questions, suggested activities, direction of play narratives, and the like are kept to a bare minimum. When the session is not directly shaped by themes that the therapist introduces, children will bring to therapy their own versions of personal experiences that are configured and represented in play, activities, and discussion. This does not mean that the therapist must remain inactive, silent, or vacant in his or her presentation, but rather that he or she should convey a friendly interest and respect for children by attending to what children themselves introduce in the session.

VI. THE INTERVIEW SETTING

At the beginning of any treatment, the therapist's knowledge of children's phase-specific concerns contributes to his or her ability to set the stage for a therapeutic atmosphere in which therapist and child can learn about and work on the dynamic intersection between inner life and the external world of the child.

In the clinical situation, the child psychotherapist has the task of introducing the consulting room and the psychotherapy as a safe situation in which the therapist and child together have an opportunity to explore and

work through the difficulties that have been brought into the treatment. Children's sense of safety is influenced by the ways in which the therapist conveys appreciation for the dangers children confront throughout the process. The child's comfort level during the session will also vary according to what is uppermost in the patient's mind at any given time.

Preschool children experience the sense of safety in the familiarity and pleasure of the imaginative play with a friendly adult who can follow their lead while maintaining effective limits on potentially dangerous or overly exciting behavior. Safety also will be experienced in the comfort or confidence the parents convey in their attitude toward the therapist and by their availability before, after, and at times during the session. Children will begin to develop a sense of safety as they discover that the therapist will do no harm—whether in response to provocative behavior or to any thoughts, fantasies, or feelings that may emerge.

These same issues may be equally prominent for school-age children. However, there is now an additional burden for these children. They are invited to reveal aspects of their inner life at a time in development when the need to renounce the open expression of infantile longings is paramount. School-age children's increased interest in privacy and secrets, games with rules, cause-and-effect thinking, engagement with peers and activities outside the home, curiosity and learning, and bodily self-care are products of newly emerging mental structures made possible by advances in both cognitive and physical capacities. These interests reflect children's ability and need to move away from their earlier dependence on parents as well as from a fantasy life in which the parents figured prominently as direct objects of sexual and aggressive impulse. In many ways these new developmental acquisitions add additional challenges to the usual ones of establishing a psychotherapeutic relationship. For school-age children, anxiety is aroused from the intimacy of the relationship with the therapist to reawaken old, now-unacceptable dependent longings as well as stimulate the emergence of wishes and fantasies experienced as dangerously regressive.

For adolescents, the dangers of yielding to a resurgence of longings and interactions that resonate with earlier phases of development are now intensified by biological maturation. Asking for or being sent for psychotherapy may confirm the adolescent's worst fear that his fluctuations in mood, preoccupations with sexual and aggressive fantasies and feelings, and anxiety about negotiating aspects of daily life are indications that he is crazy, infantile, and incompetent.

In therapeutic work with each of these age groups, the child's sense of safety will, in large part, derive from the therapist's appreciation of the specific dangers that are evoked for this particular child by the introduction of the psychotherapeutic situation as well as from an understanding of the developmental importance of the defenses that are called into play.

VII. DEVELOPING THE THERAPEUTIC PROCESS

The first meeting with children usually is preceded by meetings with the parents in which the presenting difficulties and developmental and family history are discussed. These meetings with the parents are conducted either by the child therapist or by a colleague. This background information will provide a context for direct observations made by the therapist over the course of two or three evaluative sessions. In the context of these meetings, it is suggested to parents of young children that the child be told in simple terms that they will be meeting with someone who helps children who are having worries. The parents can introduce their child to the idea of meeting with the therapist by saying that they know that the child has been having troubles and that they would like to help so the child will feel happier and free of the worries that are making life so difficult. Additionally, parents may briefly describe the nature of the contact with the therapist by telling the child that they will have a chance to play and talk, get to know the therapist over time, and slowly figure out worries with the help of the therapist. Although the details of what parents tell their child may vary, parents of children younger than 5 years of age are counseled to keep the explanation brief. Parents should be helped to understand the importance of following the child's lead regarding how elaborate the explanation about the consultation should be. For example, in response to the child's questions, parents may distinguish the difference between the kind of doctor who does examinations and gives shots and the doctor who helps children through play activities and/or words.

Children under 6 may feel most comfortable if a parent accompanies them and the therapist into the consulting room for the initial meeting. Young children frequently make verbal and nonverbal requests—by holding onto a parent's hand, climbing onto the parent's lap, or leaning up against the parent's body—that the familiar adult remain in the consulting room for some

time. The therapist's initial communications are meant to demonstrate that the setting and the therapist are free of external demands or threats that might prove overwhelming. These opening communications should be kept simple but should include a verbal introduction of herself and her intentions (i.e., "We are going to a room where we can play and talk"); an awareness of the child's wishes about the timing of separating from the parent; and a friendly but low-key invitation to the child to explore the contents of the playroom and to use the toys and drawing materials. Just as the parents have introduced their child to the idea of seeing the therapist, the clinician also may tell the child that he or she is there to help them with their worries. Some psychotherapists prefer to say more, describing in greater detail the schedule as well as the nature of their work; others say very little, preferring initially to learn from the child his or her initial ideas about treatment.

The choice of play materials should invite the child's imaginative use of them as well as be appropriate to the child's level of developmental functioning. For younger children, the use of small animal and human figures, puppets, a doll house, toy cars, and paper and markers all serve as relatively neutral objects that they can use in developing play themes and narratives. In contrast, using toys that derive from television shows may evoke scripts that even when personally elaborated by children were originated in the imagination of someone else and therefore confuse and diminish their projective and communicative value in the therapeutic process. Similarly, too many toys or activities that increase the potential for regression and direct enactment of impulses—play with water, paints, swords, and guns with projectiles—may succeed in engaging children in the room but may be overstimulating for many children who come to experience the consulting room and the therapist as dangerous.

A. Case Example 1

A psychotherapist just beginning her work with a 5-year-old girl expressed surprise and some anxiety as she reported in supervision on the first 3 psychotherapy hours with the girl. The therapist reported that the girl, Yvonne, had been referred because of chronic battles with her mother, frequent nightmares, fights with kindergarten classmates, and obstinate refusal of her teacher's requests to join in-group activities. There were no immediate external precipitants to these difficulties, which had been apparent in varying degrees for the previous 18 months. Her history was unremarkable

except for her mother's acknowledgment that both she and her husband were perhaps overly strict, demanding compliance to their expectations that, from age 2, Yvonne should behave like a "little grown-up." Mother reported that prior to the current difficulties, both she and her husband as well as other adults frequently had commented on how well-behaved and mature their daughter seemed—"she was such a sweet, good little girl . . . maybe too good."

The therapist went into some detail in describing the first three sessions and her consternation about the dramatic fluctuations in Yvonne's presentation. In the first hour, the girl had separated easily from her mother, was friendly, and seemed comfortable accompanying the therapist into the consulting room. However, once in the room, Yvonne stood in one corner, finger in her mouth, eyeing the therapist and the contents of the room quietly. After several minutes the therapist invited her to explore in sequence, the dollhouse, human figures, and finally the crayons and paper. Yvonne stood her ground and quietly shook her head. The therapist posed several questions about favorite toys and activities, to which Yvonne gave brief responses. After 30 minutes in the room, Yvonne walked over to the dollhouse and explored it for the next several minutes. She ignored or did not respond to any of the therapist's attempts to engage her but remained seated in front of the dollhouse fingering the figures and furniture inside. Suddenly, 40 minutes into the session, Yvonne looked up at the therapist and announced, "I'm done," and walked out of the room with the therapist trailing behind her. She was not interested in the suggestion that perhaps it might feel more comfortable to have Mom in the room with them and instead informed both therapist and mother that it was time to go home.

The second session began in a similarly quiet fashion. However, the therapist had decided to become more active in this meeting and to bring more play materials that might be of more interest to the girl. She equipped the room with an easel, paints and brushes as well as several cans of Play-Doh, and several different size dolls. The therapist described her demeanor as more upbeat, for example, greeting Yvonne with a buoyant announcement that she had a number of surprises waiting for her in the room. Yvonne declined the offer to have her mother in the room. Again she stood for several moments surveying the room as the therapist began unpacking Play-Doh, mixing paints, and describing what fun they might have playing with these items. After several moments, Yvonne did engage in painting, at first slowly and carefully on the paper and then with

less care, which then culminated in a frenzy accompanied by wild giggles as she flung paint onto the paper, the walls, and the floor. Before the therapist had any time to comment, Yvonne went to the Play-Doh, which she rolled in balls and excitedly threw against the wall while darting about the room, glancing in a challenging way at the therapist. And so the session continued as the therapist spoke of the need to keep her patient safe, the rules for being able to continue to use the materials, and so on—all accompanied by the therapist's frozen smile and strained attempts to retain her composure. The session ended abruptly when Yvonne gleefully ran out of the room screeching her way down the hall until she reached her mother and again grew quiet as she looked out from behind her mother's dress, gazing at the therapist who had finally caught up with her.

The third hour presented yet another picture of Yvonne and a new set of challenges for the therapist as her young patient was now terrified of entering and then remaining in the consulting room. Yvonne insisted on having her mother in the room and sat quietly on her lap for the entire session. The therapist hypothesized that her eagerness to engage Yvonne in exciting activities was an attempt at seduction that had been too overwhelming for a child whose threshold for excitement and retaining self-control is especially low. The therapist and the sessions themselves had become the focus of fear as they represented the invitation to give full rein to impulses that Yvonne found both exciting and dangerous. In subsequent hours, the therapist verbalized how excited and frightened Yvonne had become and how important it was for her to feel safe again. In addition to inviting the mother into the room, the therapist eliminated the more stimulating paints and Play-Doh while assuming a more low-key and patient approach to Yvonne. After several sessions Yvonne was again comfortable being alone with her therapist and continuing, at her pace, the exploration of this new setting and the struggle over expression of impulses that brought her into treatment.

In contrast to the younger child, many school-age children are well aware of the troubles that have prompted their referral for treatment. With children of this age, the therapist will need to discuss more directly the children's and therapist's ideas about why children are coming for psychotherapy. When appropriate, the therapist may want to negotiate directly with older school-age children such issues as the scheduling of sessions and elicit their interest in helping with the therapist's choice of materials available in the room. The goal here is to create a bridge,

or neutral ground, in which children can begin to describe directly or in displacement their experience of themselves internally and in relation to others in day-to-day life. Although school-age children may choose the same materials as younger children, such as play figures, puppets, a doll house, and markers and paper, older children may prefer activities less clearly associated with their younger selves. A deck of cards, checkers or chess, and models to be constructed may all play a role in the psychotherapy of older school-age children. Children may employ such activities as "something to do" while they talk, or children may use them in the service of representing their difficulties around aggressive, competitive, and superego conflicts.

B. Case Example 2

John was a 10-year-old, highly constricted boy who shied away from engaging with peers or attending to his schoolwork when referred for evaluation and subsequent psychotherapy. Over the course of his 18-month treatment, the theme of competition became increasingly linked to danger as he developed play and written stories about armies fighting over a country and the affections of its ruler, the queen. The sessions often would end with each of the armies being decimated. As the therapist eventually commented on how dangerous the battles seemed for both sides. John replied outside of the play, "Well, that's what can happen when you want something too badly." During the work, John could reveal through play and discussion the extent to which his wish to be the best at everything preoccupied him. This longing was accompanied by intense rivalrous and destructive fantasies that were directed toward his father and siblings whom he felt were competitors for his mother's exclusive attention and, by extension, toward peers for the teacher's. Equally intense were John's sense that his wishes were morally unacceptable and in direct conflict with the positive attachments he felt to his rivals. For John, any competitive strivings engendered the same massive superego repudiation, guilt, and accompanying anxiety that greeted his unconscious fantasies and the conviction that his destructive wishes would come true. As John became more conscious of the link between his fantasies and his symptomatic avoidance of any show of competence and competition, his academic and peer involvement significantly improved. Exploring the origins of intensely rivalrous feelings through play and talk led to a greater tolerance for himself and an increased sense of safety in

the fact that, as he put it, "Wishes are only wishes, you know."

The use of elaborate board games, while reflecting age-appropriate interests, often narrow the focus of the therapeutic work to the task of mastering specific rules and strategies, thereby closing off other avenues of representation and communication that might be expressed and observed more easily in a less demanding game. The repetitive and circumscribed nature of elaborate games may, in fact, serve the defensive function of avoiding conscious awareness of fantasies and associated troubling feelings. In addition to the tasks of listening, observing, and exploring the contents of the imaginative play, games, or discussions, the therapist must be able to appreciate the importance of children's defensive operations in order to assist in developing a safe enough forum in which fantasies and feelings can be elaborated. In some treatments, such as John's, the original use of displacement (or the expression of conflictual themes and feelings via characters in play, narratives accompanying drawings, or discussion of the lives of "others") may lead to greater insight, conscious recognition, and verbalization of the links between inner life and patterns of behaviors. In many other treatments, however, the use of displacements themselves may provide just the opportunity children need to work through new solutions to conflicts that have given rise to the symptoms and troubles that have brought them into psychotherapy. Verbalizing formulations that reflect hard-won insight into the presenting problems may be more of a need for the therapist than for such children.

Similarly, the developmental tasks of adolescence demand a very different approach from preschool and school-age children, usually from the moment of referral. Although young and mid-adolescents may come for treatment primarily at the instigation of parents or school, usually they have a very clear idea of why others think they are in trouble. It is important in the beginning work for the therapist to recognize that adolescents' protests that it is parents or others who have the real problems does not determine or predict the extent to which they will be able to engage in the psychotherapeutic process. Instead, adolescents may have a very different agenda concerning psychotherapy from the adults who have encouraged, or required, them to seek help. Although the therapist may want to make some effort to negotiate with adolescents the differences between their agenda and that of the adults, if adolescents are to be engaged successfully in their own treatment, the therapist must acknowledge and, when possible, accept their agenda as the central psychotherapeutic task.

With adolescents whose feelings of mistrust, displays of negativism as a defense against fears of passivity, and a negative transference are common, it is important for the therapist to ally with those parts of the patient's ego that strive for harmony. An initial focus on the adolescent's strengths is often the best way to foster a therapeutic alliance. Adolescents, even more than adults, find it easier to fight external conflicts than internal ones. Helping the patient put the former in better perspective often builds confidence in the therapist that allows for later exploration of the latter. The therapist's ability to use language that stretches the patient's awareness, but does not talk down or sound autocratic to him, is crucial for the patient to hear what the therapist is conveying. Two other aspects of psychoanalytic psychotherapy with adolescents must be kept in mind. One is that adolescents frequently have a confused sense of time. It is not uncommon that only the near future is recognized. The past is what as soon-to-be-adults they want to put behind them, while adulthood beyond the 20s is too much like their parents' lives to comprehend. This concentration on "now" may leave a feeling of rapid movement and of being in a hurry to go they know not where that requires understanding by a therapist. Another aspect of adolescence that may intrude into the therapeutic interaction are the paradigms of love and mourning, which may intrude to take the patient's mind off the therapy. These are typical of the age and, rather than resistance, are usually short-lived and can be learned from.

Unlike preschool or school-age children, adolescent patients may be much more comfortable sitting and talking "like an adult" rather than playing. However, the psychodynamic developmentally informed therapist understands that the operative word here is "like," not "as." Young to mid-adolescents, although wishing to appear adultlike, often are not able to sustain for long the sort of introspective, self-reflective stance that characterizes many adults seeking treatment. Adolescents may feel most comfortable talking about their life with peers or about the failings of their parents. On the other hand, they may be very reticent to engage in or reveal the self-reflection and troubling affects that may accompany such "neutral" topics that are seemingly so distant from internal experiences. It is the therapist's task to introduce adolescents gradually to a more self-reflective stance and to help them to sustain such a stance during sessions. Because it is the central developmental task of the young to mid-adolescent to achieve greater psychological independence and separation from parents, adolescents experience any thoughts, fantasies, or feelings that they associate with earlier

developmental levels as a dangerous move backward toward earlier childhood feelings (i.e., regression); therefore, they go to great pains to avoid them. When adolescents experience the psychotherapeutic process as exerting a regressive pull toward psychological reengagement with the parent of childhood, they are most likely to flee psychotherapy in the service of reestablishing what they are convinced is a developmentally necessary separation and attainment of greater autonomy. For these reasons, it is the therapist's task to approach the inner conflicts of adolescents, which inevitably carry with them this regressive valence, with great tact and developmental understanding. Young to mid-adolescents may be most comfortable "chatting" during their hours about sports, apparently superficial peer relationships, or television shows and characters. During the early phase of treatment, the therapist may have to work almost exclusively through the displacements afforded by such seemingly bland topics, which, over time, may help both to establish a feeling of control and safety in sessions as well as to provide his or her version of the bridge to discussing more directly increasingly relevant personal material.

In attempting to make adolescents feel comfortable, the therapist may make the mistake of trying to present himself or herself as a "hip" pal by initiating conversation that adolescents experience as dangerously seductive or intrusive (e.g., presenting as knowledgeable and "up" on culturally current topics, such as the latest sports or cultural figures and popular music). Adolescents in treatment are most comfortable with a therapist who is clearly an adult, but one who is an especially careful and thoughtful listener. Young adolescents often will become more comfortable as they feel confident that the therapist will not intrude on their burgeoning sense of psychological autonomy by moving to intolerably "deep" levels too quickly or making interpretations that they experience as "wild" and tactless. For adolescents who have the greatest difficulty in tolerating any verbal engagement or face-to-face contact that increases the sense of being scrutinized, the offer of simple games (e.g., card games, checkers, chess) may provide a more neutral basis of interaction. Again, adolescents' experience of control and of the therapist as nonintrusive may allow them to feel safer revealing themselves in their own good time and guided by their own wish to feel relief from struggles that have brought them to treatment.

The choice of materials, scheduling, and frequency of meetings is crucial in setting the tone of the therapeutic relationship. These decisions should be informed by the therapist's understanding of the patient's

developmental level. For preschool children, a minimum of twice-a-week appointments usually is necessary to provide the continuity in which psychodynamic lens can be employed usefully. Although older children may be able to develop a sense of therapeutic continuity in a once-a-week treatment, here, too, more frequent weekly appointments help therapist and children to cultivate a sustained "therapeutic atmosphere" in which the material of sessions can be understood by both participants to reflect the children's inner world with its conflicts and defenses. This therapeutic atmosphere, which includes the even, observing attention of the therapist to children's underlying conflicts and defenses as they are revealed in their play, behavior, and talking, permits children and therapists to develop a shared therapeutic language.

More so than with younger patients, the possible use of psychopharmacological agents arises increasingly with age. If medication is prescribed by someone other than the psychotherapist, this can affect the patient-therapist relationship. Up until the past 10 to 20 years, there was also much debate as to whether medications negatively affected the therapeutic relationship even if the psychotherapist was also the prescriber. It is now clear that if the patient has a disorder for which medication is helpful, alleviation of symptoms make psychotherapy more effective. At the beginning of the 21st century, there is more concern that psychoactive medications are given without psychotherapy, than the reverse. For the psychodynamic psychotherapist, the important aspect of medications, often overlooked in other types of psychotherapy, is the monitoring of the patient's fantasies and/or symbolic meanings of, and expectations, appreciation, and/or disappointment with, the medication.

VIII. WORKING WITH PARENTS AS AN ADJUNCT TO TREATMENT

Collaborative work with parents can be a crucial component when working psychodynamically with children under the age of 13. Children, even of grade-school age, are not able to present a full picture of their daily lives and behavior. In particular, children may wish to avoid reporting external events for fear of the critical judgment of the therapist. Meetings with parents during which they can report on events in children's daily lives are important for filling out the therapist's understanding of the children. Here we offer a few guidelines and warnings.

Collaborative work with the parents is critical to the psychodynamic treatment of children age 6 and under.

Unless parents share information concerning a child's daily life and behavior with the therapist, his or her capacity to understand the referents of the child's play may be severely compromised. In addition, parents of young children in treatment frequently are quite anxious or confused about how to handle their children's behavior. Developmental child guidance attuned to the needs of the specific family and child can be extremely useful in ensuring the parents' continuing support of the treatment. When necessary, helping the parents understand why they should alter their approaches to the child and in helping them develop new strategies may be an important factor in supporting gains the child may be making within the treatment hours. Children younger than age 5 have not yet developed a firm cognitive understanding of privacy or secrets and expect that the significant adults in their life share a mutual concern for their well-being; for these reasons, children under 5 usually are quite comfortable with the idea of meetings between parents and therapist.

Children over age 5, however, have begun to develop a strong sense of privacy and secrets and may be much less comfortable with the notion that material from their sessions might be shared with parents. For this reason, the therapist of school-age children must not only assure the children of the confidentiality of material from sessions but must in fact be careful during parental child guidance sessions that the material children wish to have kept private is not revealed.

Parental meetings should be scheduled often and regularly enough that parents understand their importance in conveying significant information about their child's ongoing life. Frequency and regularity of contact between parent and therapist also helps parents recognize that they have a critical contribution to make to the success of their child's treatment; under such circumstances, parents are less likely to retain the magical notion that they can turn their child over to the therapist to be "fixed." In addition, parental meetings underpin the development of sufficient trust in the therapist for the parents to utilize any development child guidance that is offered. Finally, such meetings permit the therapist to gain adequate understanding of the parents' personalities to know whether it would be useful to the success of the child's treatment to refer one or both parents for their own treatment. If such a referral is indicated, the therapist who has developed a collaborative relationship with the parents will have an adequately informed working alliance so that he or she can decide how to best approach the question.

Although it is usually the parent of the adolescent who initiates the contact with the therapist and un-

doubtedly pays for any treatment undertaken, collaboration with parents of children of this age is more difficult. Because adolescents are moving toward greater psychological independence and autonomy from their parents, they may experience any collaboration with their parents as threatening; collaboration thereby runs the risk of compromising the usefulness of the treatment to the adolescents. In general, adolescents are also better reporters of their daily lives and behavioral difficulties than younger children. For these reasons, parental contacts should be infrequent in the treatment of adolescents and in most cases they should not occur without the adolescent being present. Often, however, parents of adolescents feel most confused and upset about how to handle their child's behavior; they may express the need for increased contact with the therapist as a way of allaying their own anxieties and of developing new ways of handling their child. During the initial contact with the parents, the therapist must make clear the developmental reasoning behind the necessary restriction of contact between parents and therapist. Often treatment of adolescents is enhanced or successful only when the parents are seen on a regular, or as needed, basis by a colleague. With information about the parents and their contributions to family interactions alongside of reports from the adolescent's therapist, the collaborating clinician will be in a good position to help parents develop and assess new ways of understanding and responding to their adolescent more effectively while helping to maintain the confidentiality of the adolescent's treatment itself.

IX. CHILD PSYCHOANALYSIS

The principles we have described for psychodynamic psychotherapy have been derived from child psychoanalysis. The differences between psychoanalysis and psychodynamic psychotherapy lie in the frequency of appointments, the analyst's more consistent focus on defense and transference issues, and the relative abstinence of the analyst's stance toward the child patient. Children in analysis are generally seen four or five times a week. This frequency allows the analyst to be more patient for material to emerge; he or she can be confident that important psychic material will appear over and over again in different forms. As a result, the analyst does not need to rush to understand or to make what may well be premature interventions based on limited material. The frequent sessions also make the child's characteristic modes of defense against conflict much more clear and the child's attention can be more

easily drawn to his or her defensive activities. In a similar way, it becomes easier for the analyst to sort out what aspects of the child's relationship with him or her are being driven transferentially and what aspects may constitute the "real relationship." Finally, the analyst's confidence that significant clinical material will emerge in a context that both analyst and child can understand allows the analyst to be somewhat less active, or relatively more abstinent, in the clinical setting, counting on the interpretation of conflict, defense, and transference to carry the primary therapeutic action.

The intensity and details of the treatment relationship and material that can emerge in a psychoanalysis require additional training for the clinician who engages in this specialized area of clinical practice. Graduate psychoanalysts have had a rigorous and extensive clinical training following completed graduate education as a psychiatrist (M.D.), psychologist (Ph.D.), or clinical social worker (M.S.W.). Psychoanalytic training consists of three parts. Candidates attend a multiyear sequence of courses on development, psychoanalytic theory, and technique. They undergo a personal analysis. They conduct a number of psychoanalyses under close clinical supervision. Usually child psychoanalysts have completed training in adult psychoanalysis as well as child and adolescent psychoanalysis. The latter training involves an additional sequence of courses and the supervision of the psychoanalysis of children and adolescents. There are a small number of training programs that train candidates in the practice of child and adolescent psychoanalysis without training in the practice of adult psychoanalysis. There is no federal or state accreditation for psychoanalysts, but the standards of training are maintained by two major professional organizations: The American Psychoanalytic Association and the International Psychoanalytic Association. Training programs are affiliated with either or both of these organizations, which establish, accredit, and maintain the affiliated training programs.

When, then, is psychoanalysis the recommended treatment for a child as opposed to once or twice weekly psychodynamic psychotherapy? Why would a child analyst make the decision to recommend analysis for a particular child and when would it be appropriate for a nonanalyst to make a referral of a child to an analyst?

A child would be an appropriate candidate for psychoanalysis if (1) he or she is strongly defended against acknowledging the severity of his or her problems; (2) if the relationship with the clinician is dominated by transference dynamics that have not yielded to a less intense form of intervention; and, (3) at times, when the severity and intractability of the child's symptoms have resulted in a developmental arrest that seriously

impedes the child's ability to move forward developmentally. This latter situation may, at times, include children with ego vulnerabilities.

Some children, particularly latency-age children, are quite resistant to being able to recognize the severity of their problems. Grade-school age children in once-a-week treatment may use board games to ward off the encroachment of reality outside the clinician's office, the reality in which they are most symptomatic. Attempts on the part of the clinician to confront the child with his or her symptomatic behavior outside the office are met with staunch denial and an insistence that "everything is fine." Such a child is well able to maintain the comforting fiction that whatever problems he or she may face are really someone else's problems. When externalization successfully deflects the patient's capacity for self-observation, psychoanalysis may yield a great deal more data and opportunity for joint scrutiny of the sources of internal conflict and discomfort and the counterproductive ways in which unwanted struggles are characteristically jettisoned.

A. Case Example 1

Ten-year-old Amy had a history of sabotaging her friendships by her passive-aggressively expressed critical stance toward others; she would roll her eyes mockingly, make a low-voiced angry comment, or fail to interpret correctly the social cues given by other children. Amy experienced herself as endlessly falling victim to the meanness of others, whether it was to her classmates' "cattiness" or to her parents' "unfairness." When her attention was forcefully drawn to these reported problems, she would respond at first with denial and then would sadly insist that she "couldn't help" being so angry "because my parents are divorced." Amy's relationship with her therapist was dominated by her need to present herself as a nice cheerful girl who enjoyed coming to therapy to play cards. A year of once-weekly psychodynamic psychotherapy had not allowed Amy to make any real progress; she remained as insistent as ever that the world had dealt her a bad hand of cards and that other people should change. A recommendation for psychoanalysis would be appropriate for Amy. The frequency of sessions would make it more difficult for Amy to sustain her "niceness" with her therapist; it would be expected that her symptomatic critical, hostile behavior would come more directly into the relationship with the analyst, even if her mode of communication continued to be to play cards. In addition, the frequency and intensity of the clinical hours would allow the analyst to scrutinize more carefully the defen-

sive aspects of Amy's pleasant facade with him. Amy's attention could then be drawn to the defensive aspects of her "niceness," her underlying fear that she was a stinky, nasty girl whom nobody could really like, as well as provide a better understanding about what drove her aggressive conflicts.

Similarly, the intransigence of symptomatic behavior may be an important indication that too little about the nature of the underlying internalized conflicts has been revealed, understood, or worked through. This may be especially the case when the child has, in fact, been well-engaged in a psychotherapy and the parents have been able to alter life circumstances of and responses to the child based on their full involvement in parent guidance work.

B. Case Example 2

Five-year-old Joey was referred for treatment because of his provocative, combative stance toward people in authority, not only his father, but his female kindergarten teacher and the playground monitor. Parental child guidance had helped the father and mother change their handling of Joey, recognizing that much of his provocative behavior was driven by an underlying anxiety. The parents had also intervened with his classroom teacher who responded by making the rules and structure of her classroom clearer and praising Joey for his academic success. In his once-weekly treatment, Joey continued to play out stories of knights stealing beautiful princesses, fighting the king for the castle, and stories of motorcycle daredevils who took life-threatening risks to great acclaim. Joey's relationship with his male therapist was at times provocative, but when his therapist attempted to draw Joey's attention to his behavior, Joey quickly "settled down," turning from his dramatic play to some sort of "busy work." His behavior outside the classroom continued to be very problematic, with Joey hitting other children, disrupting playground games, and seeming to invite a punitive response from those in charge. Joey's analyst hypothesized that if Joey were in analysis, his attention could be drawn to the ways in which his occasional provocative behavior within his sessions was driven by his underlying fantasy that his "kinglike" analyst was out to take away Joey's power, making him feel once again helpless and little as he had so often in the past with his exciting and powerful father.

Psychoanalysis may also be indicated when symptoms and age-inadequate functioning derive from vulnerabilities in ego functioning that intensify the intransigence of

internalized, neurotic conflicts. Difficulties involving poor impulse and affect regulation, deficits in capacities for synthesis and integration of stimuli, or paucity or primitive nature of defenses may only be observed, understood, and addressed fully in the context of an intensive, long-term analytic relationship.

C. Case Example 3

Six-year-old Betsy was referred for psychoanalysis because of her inability to adapt to many age-appropriate expectations. Her parents, though loving, had had little ability to set any appropriate limits for Betsy: She was not expected to go to bed at any particular time, she watched unlimited television, she ate only what she wanted and when she wanted. Weekly meetings with the parents helped the clinician understand the severity of the parents' own conflicts around aggression; the parents experienced any limit setting as dangerous and cruel. They recognized that their daughter was ill-prepared for life outside the family but felt quite helpless to do anything about it. Clinical evaluation revealed that Betsy was a bright child who was unusually comfortable at retreating into her own fantasy world of happy, magical fairies whenever reality made a demand on her. Betsy expressed a high level of anxiety about how dangerous the world outside the family was; she found it hard to concentrate in school because of her preoccupation with the idea that a fire might break out. She was equally concerned with the idea that the weather might suddenly and inexplicably turn seriously bad; in her mind there was a constant possibility of tornadoes or catastrophic storms. When she had such thoughts, Betsy quickly turned away from reality and withdrew into her magical fantasy world. The evaluating clinician viewed Betsy as a child with clear ego vulnerabilities, particularly in the realm of tolerating frustration, delaying gratification, vulnerability to ego regression under the press of her anxiety, and a reliance on a retreat from reality as a primary mode of defense. The clinician felt that once- or twice-weekly psychotherapy would prove inadequate to addressing the severity of these vulnerabilities because of the comfort Betsy experienced in withdrawing from the demands of reality. It was felt that only with the development of an emotionally significant relationship with the analyst would Betsy be able to tolerate the level of anxiety she experienced and become able to relinquish her reliance on such primitive modes of defense.

As suggested earlier, adolescence may be the most difficult period of development in which to engage a youngster in a close therapeutic relationship that involves

self-revelation. Although the diagnostic indications are similar to those described for younger children, there must be a particular urgency, either from the adolescent himself or herself or from his family or community that is necessary to sustain an analytic treatment in this phase of development. The analyst's recognition of the normative developmental demands that pull the adolescent away from an intensive therapeutic process require a level of flexibility with regard to frequency and continuity of treatment even when the adolescent has agreed in principle to its necessity.

D. Case Example 4

Having been involved in a series of delinquent acts, Dean was 15 years old when he was referred for treatment by the state run group home to which he had been remanded as a condition of probation. Dean had a long history of outpatient and residential treatment for a range of depressive, antisocial, and anxiety symptoms that had made it impossible for him to live at home from the age of 9. With an extensive traumatic history that included exposure to domestic violence between his parents, their subsequent divorce, witnessing his mother's suicide attempts, and leaving his mother to live with his father and stepmother, Dean frequently provoked fights with peers, teachers, and family members. His use of alcohol and drugs, like his involvement in burglaries and vandalism, were exciting refuges from feeling sad, abandoned, frightened, and helpless. While he entered psychotherapy as an adolescent under duress, Dean enjoyed regaling the therapist with excited stories about illegal and dangerous activities. He eagerly agreed to the suggestion that he might have a great deal on his mind and that once-a-week meetings were insufficient. Dean was eager to meet more regularly and agreed to the suggestion of four sessions per week.

In the context of the frequent contact, Dean was able to sustain the treatment even when furious with the analyst about his suggestions of a possible link between Dean's unhappiness and provocative behavior. Missed appointments occurred most predictably when Dean experienced his increasing longings for an idealized mother most keenly in the transference. At these times, Dean needed to reassert his independence at precisely the time when he felt most like a helpless infant. However, the analyst's continued availability combined with sanctioned expectations of probation forced and allowed Dean to sustain his treatment. In the context of reliable and intensive engagement with his analyst, Dean was able to tolerate his intense longings as he explored, and

increasingly understood their early origins. Behavioral, academic, and social symptomatology diminished significantly when he could appreciate that the ways in which he defended against feeling small, helpless, and enraged also invited the rejection that confirmed bad feelings about himself and the sanctions that restricted his freedom and autonomy. The regularity, frequency, and relative flexibility of contact allowed Dean to sustain a treatment experience that replaced the dangers of infantile regression with mastery that accompanied insight. The intensity of the therapeutic relationship provided an opportunity for Dean to locate the sources of his current difficulties in the disappointment, fear, and rage of the past. As a result, he was more able to relinquish hope of recovering what could not occur in the past, in favor of seeking relationships and accomplishments that could be gratifying in the present.

X. CONCLUSION

All psychodynamic interventions focus on the dynamic interplay between internal agencies of the mind, the inner life of fantasy, cognitive abilities and neurophysiologic regulatory capacities, and how the demands of external reality are experienced. Psychodynamic treatment may take a variety of forms: psychoanalysis, intensive long-term psychotherapy, weekly play therapy, brief treatment, semistructured sessions, and consultation with parents. The multiplicity of methods employed in psychodynamic interventions are linked by a set of shared principles:

1. The individual has an "inner world" that includes representations of central wishes and fears, associated feelings, characteristic modes for avoiding discomfort, displeasure, and tension (defenses) as well as for obtaining pleasure.
2. Aspects of the inner world are unconscious.
3. Conflict is inherent within the inner world between wishes, within and between psychic structures, and between the inner world and the demands of reality.
4. Conflict within the inner world may either stimulate or impair developmental progression.
5. The inner world unfolds developmentally, supported, enhanced, or compromised by constitutional givens and environmental responses.
6. Behavioral symptoms reflect the child's efforts at finding a compromise solution to conflict.
7. The nature of the child's inner world can be understood through observations of play, verbalizations,

behavior, and relationship to the therapist and significant others.

The data that inform clinical decisions are derived from observations of the child in the consulting room—modes of relating, thematic content, regulation of emotions, activity levels, and self-observation capacities—as well as what is reported about the child's life outside of the consulting room. The form of the psychodynamic intervention is determined by the child's developmental level, the nature of environmental stresses and supports, and the child's constitutional endowment. The fundamental techniques employed are influenced by the child's level of developmental organization but are likely to include imaginative play; discussion; observation of behavior and feelings; and exploration, verbalization, and clarification of wishes, fears, and feelings.

See Also the Following Articles

Correspondence Training ■ Family Therapy ■ Home-Based Reinforcement ■ Parent–Child Interaction Therapy ■ Primary-Care Behavioral Pediatrics ■ Therapeutic Storytelling with Children and Adolescents

Further Reading

- Cohen, D., & Leckman, J. (1991). Tic disorders. In M. Lewis (Ed.), *Child and adolescent psychiatry: A comprehensive textbook*. Baltimore, MD: Williams & Wilkins.
- Fonagy, P., & Target, M. (1996). A contemporary psychoanalytical perspective: Psychodynamic developmental therapy. In E. Hibbs & P. Jensen (Eds.), *Psychosocial treatment for child and adolescent disorders: Empirically based strategies for clinical practice* (pp. 619–638). Washington, DC: American Psychological Association.
- Fonagy, P., & Target, M. (1999). An interpersonal view of the infant. In A. Hurry, et al. (Eds.), *Psychoanalysis and developmental therapy*. Monograph series of the Psychoanalysis Unit of University College, London and the Anna Freud Centre. Madison, CT: International Universities Press.
- Marans, S., & Dahl, K. (1998). Principles of psychodynamic treatment. In J. Noshpitz, N. Alessi, J. Coyle, S. Harrison, & S. Eth. (Eds.), *Handbook of child and adolescent psychiatry, Volume 6, Basic Psychiatric Science and Treatment* (pp. 335–349). New York: John Wiley & Sons.
- Marans, S., & Adelman, A. (1997). Experiencing violence in a developmental context. In J. Osofsky (Ed.), *Children and youth violence* (pp. 202–222). New York: Guilford.
- Marohn, R. C. (1997). Failures in everyday psychotherapy. In L. T. Flaherty & H. A. Horowitz (Eds.), *Adolescent psychiatry* (pp. 287–303). Hillsdale, NJ: The Analytic Press.
- Moran, G., & Fonagy, P. (1987). Psychoanalysis and diabetic control. *British Journal of Medical Psychology*, 60, 357–272.
- Neubauer, P. (1987). The many meanings of play: Introduction. *Psychoanalytic Study of the Child*, 42, 3.
- O'Brien, J. D. (1992). Children with attention deficit hyperactivity disorder and their parents. In J. D. O'Brien et al. (Eds.), *Psychotherapy with children and adolescents: Adaptation to the psychodynamic process*. Washington, DC: American Psychiatric Press.
- O'Brien, J. D., & Perlmutter, I. (1997). The effect of medication on the process of psychotherapy. *Child and Adolescent Clinics of North America*, 6, 185–196.
- Pynoos, R. S., Steinberg, A. M., & Wraith, R. (1995). A developmental model of childhood traumatic stress. In D. Cicchetti & D. Cohen (Eds.), *Manual of developmental psychopathology*. New York: John Wiley & Sons.
- Ritvo, R., Al-mateem, C., Ascherman, L., Beardslee, W., Hartmann, L., Lewis, O., et al. (1999). Report of the psychotherapy task force of the American Academy of Child and Adolescent Psychiatry. *Journal of Psychotherapy Practice and Research*, 8, 93–102.
- Sarles, R. M. (1998). Individual psychotherapy with adolescents. In H. S. Ghuman & R. M. Sarles (Eds.), *Handbook of child and adolescent outpatient, day treatment and community psychiatry* (pp. 259–263). Philadelphia: Brunner/Mazel.
- Schaffer, D. (1989). *The Diagnostic Interview: Schedule for Children (DISC-2): Its development and administration*. Paper presented at the annual meeting of the American Academy of Child and Adolescent Psychiatry, New York.
- Schowalter, J. E. (1989). Psychodynamics and medication. *Journal of the American Academy of Child and Adolescent Psychiatry*, 28, 681–684.
- Shengold, L. (1989). Autohypnosis and soul murder: Hypnotic evasion, autohypnotic vigilance and hypnotic facilitation. In H. Blum, E. Weinschel, & F. Rodman (Eds.), *The psychoanalytic core* (pp. 187–206). Madison, CT: International Universities Press.

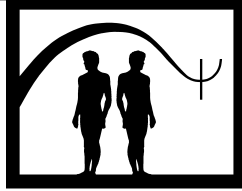

Cinema and Psychotherapy

Irving Schneider

Georgetown University Medical School

- I. History of Commercial Films and Psychotherapy
 - II. Teaching Films
 - III. Use of Films in Therapy
 - IV. Summary
- Further Reading

GLOSSARY

teaching films Use of films for demonstrating clinical pathology.

Modern psychotherapy and movies were invented at the same time. In 1895, Lumiere first publicly demonstrated the new motion picture system, and, in the same year, Freud and Breuer published *Studies in Hysteria*. The histories of the two inventions have been strikingly parallel. Both started humbly and in their long, early development were seen as dangerous or immoral. The pioneers in both endeavors were largely outsiders or members of minority groups. After a period of increasing respectability, intellectual acceptance, and popularity, both became powerful cultural forces but then began to wane under pressures from competing systems, TV and medications. Both inventions responded with modification and experimentation and are now fighting for survival in a changing world.

From the beginning, both psychiatry and the movies have borrowed themes and terms from each other. Dreams, madness, and old motivations have been the

subject of countless movies; dream screens, frame analysis, and flashbacks have infiltrated psychological discourse. But beyond this, the movies and psychiatry have always demonstrated a special affinity for each other, because to an uncommon extent they share an interest in human behavior in general and deviations from the norm in particular. Movie stories and psychiatric case histories have always drawn their content from the same reservoir of heightened emotions and unusual motivations.

As early as 1900, 5 years before the proliferation of nickelodeons, Clifford Beers testified to the psychological power of the new medium in his groundbreaking *A Mind That Found Itself* when he described his psychotic break in these terms:

I imagined that these visionlike effects, with few exceptions, were produced by a magic lantern controlled by some of my myriad persecutors. The lantern was rather a cinematographic contrivance. Moving pictures, often brilliantly colored, were thrown on the ceiling of my room and sometimes on the sheets of my bed. Human bodies dismembered and gory, were one of the most common of these.

As therapy and cinema developed, they have interacted in three major directions: the commercial film has depicted psychiatry and psychotherapy in various ways; teaching films have been developed to illustrate psychopathological states and treatments; and movies have been used in therapy to highlight themes of troubled patients.

I. HISTORY OF COMMERCIAL FILMS AND PSYCHOTHERAPY

Early movies, apart from a variety of trick and fantasy subjects, were mainly depictions of real-life events, and real or faked historical occurrences. A number of physicians, intrigued by the new invention, used it as a teaching tool to photograph an array of neurological and psychiatric pathological states. Only a year after the first public showing of a motion picture in 1897, Paul Schuster of Berlin filmed patients with a variety of neurological disorders. A year later the Romanian clinician, George Marinesco, filmed the gait in hemiplegia and paraplegia. About 1905, Emil Kraepelin in Munich began to make films of psychiatric cases. In 1908, Camillo Negro of Turin made a number of medical films of neuropathic disorders. The first attempt to use movies to depict neurological patients in the United States was made by Dr. Walter Chase of Boston. It was a film demonstrating characteristics of epileptic seizures. On a sunny day in 1905, he assembled on the lawn 125 naked patients, covered only with blankets, and waited. A fixed movie camera stood in readiness. As soon as a patient began to have a seizure, the blanket was removed, and the patient was placed in front of the camera. On that one day, 21 grand mal seizures were filmed.

By the middle of the first decade of the century, story films began to predominate. These were one reelers, about 10 min in length, leaving little room for character development or subtlety. The first treatment of psychiatric patients consisted mostly of comic chases in which asylum patients, dressed as Napoleon in some films, outwit their attendants in escaping from the hospital, lead them a merry chase through the countryside, tormenting them along the way, and then return to the asylum. *The Escaped Lunatic*, *The Maniac Chase*, and *Dr. Dippy's Sanitarium* are examples of these films. Other films of the period featured such titles as *The Kleptomaniac*, *What Drink Did*, and *A Drunkard's Reformation*. More serious and dramatic treatments of mental illness appeared in D. W. Griffith's 1909 *The Maniac Cook* and *The Reformation*.

The 1906 chase film *Dr. Dippy's Sanitarium* depicted the first psychiatrist, an asylum doctor, to appear in films, and the 1909 Griffith one reeler *The Criminal Hypnotist* featured the first outpatient psychiatrist. However, these movies are interesting for another reason. These two crude films present, at the very outset of movie depiction of psychiatrists, the three dominant models of mental health workers that would recur throughout film history. First, a brief synopsis of the films.

Dr. Dippy's Sanitarium opens with Dr. Dippy hiring a new attendant. The employee is introduced to four patients who are to be in his care, one of whom is a woman. The four inmates perform comic "lunatic" routines and then begin to harass him. Finally, the three male patients escape from the hospital, closely followed by the corpulent, frantic Dr. Dippy and excited attendants. As was characteristic of other maniac chase films, the escape ends up back at the hospital where the goofy doctor distracts and soothes the increasingly violent patients by giving each a pie (is this the first major tranquilizer in the movies?).

The Criminal Hypnotist tells the story of a party hypnotist who puts a young woman under his spell and instructs her to steal money from her father's desk drawer. He absconds with the money and leaves her in her home still in a trance. Her father sends for a "mind specialist," a term apparently more meaningful in that era than psychiatrist or alienist. The large, stocky, bearded specialist quickly responds. He immediately recognizes the problem and lightens her trance, preserving enough of it to enable the young woman to lead him, her father, and a policeman to the hypnotist's lair. As the policeman takes the villain away, the "mind specialist" fully clears the young woman's mind, and she falls happily into her father's embrace.

What appears in these films is the emergence of three distinct types of mental health specialists (when the hypnotist is included as a mental expert), essentially archetypes. Irving Schneider has named them Dr. Dippy, Dr. Wonderful, and Dr. Evil. All movie depictions of therapists can be seen as featuring one or another of these types. Dr. Dippy is the typical comical movie psychiatrist, the one who is crazier or more foolish than his patients. Some classic films in which he has appeared are *Mr. Deeds Goes to Town* (1936), *Bringing Up Baby* (1938), *Carefree* (1938), *What's New Pussycat?* (1965), and *High Anxiety* (1977).

Dr. Evil, as he appears in so many movies, has an urge to master or control, often for criminal purposes, but just as often for the sheer pleasure in power. He is willing to experiment without regard to human consequences, and those who come under his control are often driven to murder, suicide, or crime. When he treats patients, he is likely to use methods seen as coercive: ECT, lobotomy, drugs. Examples of his appearance are *The Cabinet of Dr. Caligari* (1919), *Nightmare Alley* (1947), *I, the Jury* (1982), *Dressed to Kill* (1980), and *Frances* (1982).

Dr. Wonderful is all that Dr. Evil is not. He is humane, earnest, modest, and deeply caring. He is always ready to come to the patient's rescue, whatever the time or circumstance. He is gifted at improvisation, especially when necessary to uncover traumatic events, and thereby achieves instant cures. His treatment is almost always the talking cure, seldom drugs or procedures seen as coercive. Some classic examples of these films are *Secrets of a Soul* (1926), *Now, Voyager* (1942), *Spellbound* (1945), *The Snake Pit* (1948), and *Ordinary People* (1980).

Throughout movie history the Dr. Dippys and Dr. Evils have outnumbered the Dr. Wonderfuls, which is either a commentary on movie plots or a reflection on how the profession is viewed by much of the public. Some typical movies of the decades since the 1930s that are examples of each of the three archetypes follow, representing a Dr. Dippy, a Dr. Evil, and a Dr. Wonderful. The 1930s had few psychiatric movies, but among them were *Mr. Deeds Goes To Town*, *The Testament of Dr. Mabuse*, and *Private Worlds*. In the 1940s, *Miracle on 34th Street*, *Nightmare Alley*, and *King's Row*. In the 1950s, *Harvey*, *I, the Jury*, and *The Three Faces of Eve*. The 1960s saw *Three On a Couch*, *A Fine Madness*, and *Pressure Point*. The 1970s featured *Deep Throat*, *One Flew Over the Cuckoo's Nest*, and *I Never Promised You a Rose Garden*. The 1980s had *Lovesick*, *Dressed To Kill*, and *Ordinary People*. The 1990s, *What About Bob?*, *Basic Instinct*, and *Good Will Hunting*. A complete filmography of psychiatric movies appears in the Krin Gabbard and Glen O. Gabbard book *Psychiatry and the Cinema*.

The very first film to depict psychotherapy was made in Germany in 1926. An executive of UFA, the principal German film company, suggested to Karl Abraham that he participate in making a film that would illustrate some of the mechanisms of psychoanalysis. Freud was not happy with the project but did not actively discourage it, so it proceeded with Abraham and Hans Sachs (who was increasingly involved because of Abraham's fatal illness) acting as consultants. The resulting film, directed by G. W. Pabst, was the famous *Secrets of a Soul* (*Die Geheimnisse Einer Seele*), subtitled *A Psychoanalytic Playlet*.

The story, taken from life according to the credits, tells of a chemist who develops a knife phobia, impotence, and homicidal impulses and is cured by psychoanalysis. Dream analysis plays a significant role in the treatment, with somewhat sophisticated visuals and interpretations.

The film is prefaced by the following statement:

There are desires and passions which are hidden beneath our conscious minds. These unconscious desires come to the surface especially in moments of mental conflicts and depressions. At such times, mysterious sickness can develop which are part of the field of psychoanalysis. The progressive teaching of the university professor Dr. Sigmund Freud showed doctors trained in psychoanalysis the way toward healing such sickness.

As it turned out, psychoanalysis has become the principal theory and method of movie psychiatry. Sometimes wacky and sometimes serious portrayals and explanations of psychotherapy have taken off from the psychoanalytic model. Consider how psychoanalyst Fred Astaire explains his profession to reluctant patient Ginger Rogers in *Carefree* (1938):

Miss Cooper, you understand the principle of psychoanalysis, don't you? ... You do know that you have two minds, the conscious and the subconscious? The conscious mind is the ego; that's a thing that says, "I am I and you are you" ... let me put it this way. [Hand to back of head] Back here is a jungle full of the most noble and horrible things. ... That's your subconscious mind. It works all the time, even when you sleep. It dreams. It never forgets anything. Your conscious mind lies here [Hand to front of head] It doesn't dream. It thinks. What we try for is perfect coordination between the two. Do you understand? ... To psychoanalyze you, I have to interpret your dreams. What sort of things do you dream?

A somewhat more sophisticated statement appears in the 1945 film *Spellbound*. By that time, psychoanalysis had become popular in the movie colony. The producer, David Selznick, had been in personal analysis with May Romm who became consultant to the film, and the screenwriter, Ben Hecht, had done his homework interviewing several analysts. Here is how European analyst, Michael Chekhov, explains his work to amnesiac patient, Gregory Peck:

I'll explain to you about dreams so you don't think it is hokey. The secret of who you are and what has made you run away from yourself – these secrets are buried in your brain, but you don't want to look at them. The human being very often doesn't want to know the truth about himself because he thinks it will make him sick; so he makes himself sicker trying to forget. You follow me? ... Here is where dreams come in. They tell you

what you are trying to hide, but they tell it to you all mixed up like pieces of a puzzle that don't fit. The problem of the analyst is to examine this puzzle and put the pieces together in the right place and find out what the devil you are trying to say to yourself.

In recent years, such explanations of psychodynamic principles have not been necessary. Both Hollywood and the movie public have grown more sophisticated about psychotherapy. The treatment course in movies, however, remains stereotyped and elementary. It follows a typical path. As doctor and patient get to know each other, sometimes with initial conflict, they begin to explore the patient's life. At a critical moment, perhaps as a result of some outside event, the Dr. Wonderful makes a crucial intervention, and the causative traumatic event is unveiled. The patient is cured; often patient and doctor fall into each others' arms, and they all live happily ever after. To achieve this outcome, drugs or invasive treatments are almost never used. Examples of this include *Home of the Brave* (1949), the first modern film about race; *Ordinary People* (1980), *Good Will Hunting* (1998), and *Analyze This* (1999).

In contrast to this felicitous but uncommon outcome, real therapy requires patience and attention and yields occasional, but not so dramatic, breakthroughs. Probably the most realistic therapy scene depicted in the movies occurs in Paul Mazursky's *Bob & Carol & Ted & Alice* (1969). It features Don Muhich, a real-life psychiatrist, as the therapist, and Dyan Cannon as the patient. As Muhich sits stonefaced in his chair, she sits on the couch talking animatedly about her marriage. At one point, she makes a significant slip of the tongue, which he points out to her. She is startled about what the slip may mean, but as she starts ruminating about it the hour comes to a close. The doctor's problem now becomes how to get the reluctant patient out of the office in time for his next patient, while at the same time not closing out her new insight. The scene is played for comedy, but most therapists will immediately recognize the genuineness of the scene, as they might in some other realistic portrayals in *Blume In Love* (1973), *An Unmarried Woman* (1978), and *Lovesick* (1983).

Many of the rules for Dr. Wonderful do not seem to apply to female therapists. The career path for female therapists is quite different from their male counterparts. As Glen Gabbard has pointed out, no film in Hollywood history has ever shown a satisfying personal life and a successful analytic career co-existing in the same woman. Female therapists are either single, unhappily married, divorced, childless, or otherwise unfulfilled. And in their work there is almost no example of the fe-

male therapists effectively and ethically treating the male patient. The most glaring boundary violations occur in the area of romance. In real life, the most frequent occurrence of patient-doctor sexual violations takes place between male therapists and female patients. In the movies, however, female therapists frequently and approvingly fall in love with a male patient. The female side trumps the therapist's side. Consider Ingrid Bergman in *Spellbound*, Barbra Streisand in *The Prince of Tides* (1991), Lena Olin in *Mr. Jones* (1993).

Another difference between movie therapy and real-life therapy is manifest in the mental conditions being treated. Rather than the more common cases of depression, anxiety, bipolar illness, schizophrenia, and just plain unhappiness that therapists treat most often, movies, although including these, that is schizophrenia with *David and Lisa* (1962) and *The Snake Pit* (1948), have concentrated on the more dramatic diagnoses. The list of disorders overly represented in the movies includes dissociative reaction, especially amnesia and multiple personality (*Spellbound*, *Three Faces of Eve* 1957); homicidal mania, especially when combined with dissociative identity disorder (*Psycho* 1960, *Dressed To Kill* 1980, and *Halloween* 1978); substance abuse (*The Lost Weekend* 1945, *Days of Wine and Roses* 1962); disorders of impulse control; hysterical paralysis (*Home of the Brave*); phobic disorders (*Vertigo* 1958 and *High Anxiety* 1977); paranoid disorders (many action and horror movies); and no mental illness, with or without greater wisdom. This last category has been the terrain in which Dr. Dippy reigns supreme. Many of the Woody Allen movies are examples of this category. A popular version is *What About Bob?* (1991) in which a patient pursues his pompous psychiatrist to his summer home, ingratiates himself with the doctor's family and colleagues, and proceeds to take over his practice.

Psychological conflict and heightened emotion have been the dramatic material for commercial movies since the industry started. From the beginning and all through the years, psychotherapists and psychotherapy have periodically appeared to add a professional identity to the plot. This juncture at which therapy and dramatic content meet has been the subject of the first part of this article.

II. TEACHING FILMS

As already noted, the use of films for demonstrating clinical pathology began early in motion picture history. This effort has continued, but because of problems with sound reproduction and other technical

issues, this endeavor has tended to concentrate on neurological problems, and studies in infant and child behavior rather than therapy. The most famous of these were Arnold Gesell's films at the Yale Clinic of Child Development, Kurt Lewin's Iowa State University studies of social behavior, Rene Spitz's films of emotional starvation in infants, and Margaret Fries's studies of the effects of different maternal attitudes on the child's development. Though not directly dealing with therapy, these films had an effect on therapeutic theory and practice.

World War II led to John Huston's famous *Let There Be Light* (1945), which depicted the sodium pentothal treatment of various combat-related neuroses. However, the use of actual patients limited the showing of the films, ostensibly to protect the identity of the patients. Parenthetically, a similar fate befell Frederick Wiseman's *Titicut Follies* (1967), filmed in a Massachusetts prison hospital for the criminally insane with actual inmates.

After the war, the National Film Board of Canada made one of a series of mental health films, *The Feeling of Rejection* (1947). This was intended as an aid to group therapy, but like many of the Board's films it received a response from all audiences. By 1949, there was a heightened demand for films on mental health. The National Institute of Mental Health of the U.S. Public Health Service participated in establishing the Mental Health Film Board. This group supervised the production of many mental health films, including *Angry Boy* and *Fears of Children*.

In the late 1940s and early 1950s, the Veterans Administration produced a series of mental health films, including a group titled Psychotherapeutic Interviewing Series. Carl Rogers conducted a group of therapy sessions on film for teaching purposes. Several pharmaceutical companies sponsored films for therapists. The National Institute of Mental Health in the 1960s filmed a complete psychoanalysis, lasting for years. This film required extra-long reels of film, special projectors and cameras, and a room with a one-way mirror. There were high hopes for the research gains from this project, but very little was accomplished. Hundreds of film cans are stored somewhere but never seen.

From 1960 through the 1990s, Edward A. Mason, a psychiatrist/filmmaker at Harvard University Medical School produced a well-made series of teaching films. The subjects include consultation techniques, interview methods, street corner research, and above all, children's issues. His Wediko Series featured residential treatment of a group of conflicted adolescent boys. Unlike many of previous mental health films, his films are not acted; they depict real people in real-life situations.

Filmmaking is an expensive undertaking. Filmmakers like Mason are always concerned with budget and fund-raising. With the advent of video, it suddenly became possible with a small investment in equipment to become a moviemaker. Film and processing costs were no longer a problem. Many therapists began making films at centers all over the country. Two pioneers in this endeavor were Milton Berger on Staten Island and Ian Alger in New York City. The video revolution deserves notice but cannot be dealt with here.

III. USE OF FILMS IN THERAPY

The use of commercial films as a stimulus to therapy has become popular, but it also has a history. In the late 1930s, the Commission of Human Relations of the Progressive Education Association used material from 30 feature films for group discussion. However, given the costs and practical requirements of renting that many films, the effort had little influence.

Similarly, when Steven Gressitt in the 1970s compiled a catalogue of films dealing with a variety of mental traits and diagnoses for teaching psychiatry students and laypersons about varieties of human behavior, getting that many films was a problem in cost and accessibility. Harvey Greenberg avoids that drawback. In his book, he advocates asking patients about their favorite movies. He has found this to be a useful device, almost a projective test for highlighting patients' dynamics.

With the advent of videocassettes, all the problems of accessibility have been resolved. A spate of books has been published that describe the use of video in therapy. Typically in these books, commercial movies are catalogued according to theme. This may involve a diagnosis, a dominant feeling, or a painful event. All are generally available in the local video store. According to what the therapist sees as the patient's problem, the appropriate video is assigned for home viewing. The resulting experience is then discussed in the therapy session that follows. The claim is that this process illuminates the issues and frees the pent-up emotion. One example of this approach is included in the Further Reading section.

IV. SUMMARY

Movies are one of the principal inventions of the 20th century. Whole populations have been educated

in the ways of dress, manners, vocations, romance, sex, criminal behavior, and history. Censors have forever fought to limit access to one or another of these influences. Throughout the history of movies, one theme has remained prominent, the vagaries of human behavior. This, too, has been the realm of psychotherapy. Inevitably, cinema and psychology have found common ground. Some aspects of this interaction have been presented in this article.

See Also the Following Articles

Art Therapy ■ Bibliotherapy ■ History of Psychotherapy
■ Virtual Reality Therapy

Further Reading

- Gabbard, Glen O., & Gabbard, Krin G. (1999). *Psychiatry and the cinema*. Washington, DC: American Psychiatric Press.
- Greenberg, Harvey Roy. (1994). *Screen memories: Hollywood cinema on the psychoanalytic couch*. New York: Columbia University Press.
- Hesley, John W., & Hesley, Jan G. (1998). *Rent two films and let's talk in the morning*. New York: John Wiley & Sons.
- Rabkin, Leslie Y. (1998). *The celluloid couch: An annotated international filmography of the mental health professions in the movies and television from the beginning to 1990*. Lanham, MD: Scarecrow Press.
- Schneider, Irving. (1987). The theory and practice of movie psychiatry. *American Journal of Psychiatry* 144, 8.

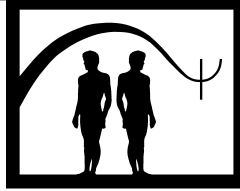

Clarification

W. W. Meissner

Boston Psychoanalytic Society and Institute and Boston College

- I. Meaning of Clarification
 - II. Recounting and Reconstructing
 - III. Clarification of the Self
 - IV. Clarification and the Transference
 - V. Therapeutic Contexts
 - VI. Summary
- Further Reading

GLOSSARY

clarification Technique for gaining clearer understanding of the meaning of a patient's conscious (manifest) behavior and experience.

confrontation Technique of directing a patient's attention to inner experiences or perceptions of outer reality of which he or she is conscious or is about to be made conscious.

interpretation Verbalized understanding of meaning, conscious or unconscious, of patient behavior or experience.

introjection Form of internalization by which properties or functions of another person in a relationship are assimilated to the self-structure but remain partially integrated, instinctually motivated, and defensively organized. Introjective structure is reflected in self-representations.

reconstruction Recovery and formulation of past events to gain understanding of hidden meanings.

entiate meanings more accurately, and particularly to gain clearer and more accurate differentiation of self-organization and the relationship to the world he or she lives in. Earlier views saw clarification as consisting in restating the patient's feelings or thoughts in clearer or more precise terms. A fundamental distinction lay between clarification and interpretation: Interpretation involved conveying meaning or some form of explanation, however hypothetical, whether of meaning or causality. The general consensus was that clarification did not refer to unconscious (repressed or otherwise warded off) material but to conscious and/or preconscious processes, of which the patient was not sufficiently aware or which escape attention, but which can be recognized more-or-less readily when clearly presented to the patient. In contrast, interpretation may deal with conscious or unconscious content and processes and typically focuses on unconscious rather than conscious material.

Clarification is also distinguished from confrontation, which, along with clarification, provides another technical channel for dealing with conscious content in the patient's ongoing behavior. Although clarification has the function of making clear or of bringing about recognition, it does so in a more neutral and dispassionate fashion; confrontation adds the note of activity on the part of the therapist, emphasis, even forcefulness, and the overcoming of resistance. Clarification does not target resistance, but unclarity or lack of awareness. There may be defenses behind these

I. MEANING OF CLARIFICATION

The concept of clarification is centered on the basic idea of helping the patient to see more clearly, to differ-

obscurities, but clarification goes no further than calling attention to them when apparent. But even more subtle differences may come into play. There is a difference between accusing the patient of wasting time versus observing that the patient is still reacting as if his or her work with the therapist were doomed to be unproductive. The former is confrontative of resistance and renders a judgment, the latter provides merely a translation. The latter statement is more in the order of directing the patient's attention to a subsequent line of interpretation. The difference has to do with the presence of the therapist in the intervention. The patient's assent to the first intervention necessarily involves accepting both the fact and the role of the therapist, whereas assent to the latter requires only acceptance of the fact. In a sense, then, confrontation involves the therapist's forcing of the self on the patient, an intrusiveness involving real activity on the part of the therapist beyond transference considerations.

In these approaches, clarification is treated as a form of intervention aimed at clarifying something in the patient's mind. But before that can be done, clarification has to take place in the therapist's mind. Clarification, then, is involved in the inquiry directed to understanding for both patient and therapist. Its objective is seeking information. The focus of clarification can be something the patient tells us about his or her experience outside the consulting room, something related to activities or relations with other people. What we want to find out are the details, the specifics of action and interaction to whatever extent the patient can remember or reconstruct them. The basic tactic is to encourage the patient to tell us more about the event or events in question, to convey interest, to ask questions to elicit more information. The point of course is that the devil is in the details—the more we can know about the specifics the better purchase we can get on the meanings and motives embedded in the account, the more opportunity we have of hearing the subtle reverberations of repetitive themes and transference enactments. Among the more important details are whatever affects or feelings the patient can recount; the closer one gets to the concrete details of the situation, the more available are the relevant affects. In addition, the closer one gets to the specifics, the greater the likelihood that the material in the current event will reverberate with comparable events in the patient's network of associative material, and that parallel or comparable material from the patient's life history will become available, thus facilitating the process of free association.

II. RECOUNTING AND RECONSTRUCTING

Fundamental to the therapeutic role of clarification is the fact that as the patient develops his or her account of the events, whether that be some recollection of past, even childhood, events, or events occurring in recent or current experience, the patient subjects the material to a process of objectifying in constructing the narrative material, first in his or her own mind and then in telling it to another listener. In so doing, the patient reviews the material in his or her own mind, objectifying it in the process of reconstructing details. In this way, patient and therapist take the first steps along the path toward interpretation. Not only does the therapist gain a better understanding of what was involved in the event and why, but the patient does also—not by reason of any input from the therapist, but solely by reason of personal objectifying review and reconstruction.

As has been noted from the time of Freud, the patient's reconstruction, whether of a memory, fantasy, dream, and so on, is not necessarily a veridical recounting of actual events, but a rendering conducted through the lenses of retrospective construction (Freud's *Nachträglichkeit*), screen functions, selection, defensive distortion, and so on. These introjectively derived fantasy-related phenomena and their role in early object relations as well as current transference relations can be further clarified, helping to specify the patient's introjective configuration and progressively delineate it from reality. The interpretive process aims ultimately at maintaining a distinction between fantasy and reality: this issue, the clarification of the boundaries between the patient's fantasy life and its derivatives and reality is one that pervades the interpretive process from beginning to end. Even at the earliest stages of interpretive work with many patients, the therapist's effort is also directed toward beginning to establish the rudiments of a working alliance, which may require some clarification and at least phenomenological interpretation of the patient's experience in the therapeutic relationship as reflecting more therapeutic misalliance than therapeutic alliance.

Drawing the account closer to the concrete specifics does not eliminate these factors but does modify their impact to a degree. We are consequently forced to accept a degree of partiality or probability in any such account, that will usually yield to further elaboration or correction as the therapeutic inquiry continues, but never allows us the consolation of achieving an assuredly factual narrative, that is we may never get beyond narrative truth. If we do not arrive at the certitude of a factual account, however, neither do we necessarily have to settle for an

historical fiction. I would question the assumption that the truth generated in the course of therapeutic inquiry is either exclusively narrative or historical; the account of the past rather shares to some extent in aspects of both. The account of the past reconstructed from the patient's memories and associations is basically a subjective account that may or may not approximate to some degree the veridical historical events. However, the therapist is not directly interested in establishing such a veridical account but is concerned with finding the meaning of the reconstructed events in the patient's mind. If the account is not based in some degree on historical truth, that is based on data that bear the stamp of real happenings in the patient's memory and thus have a verifiable factuality, the reconstruction remains a fiction or illusion lacking credibility and impact for the patient. Thus, I would argue, not any reconstruction will do, but only that reconstruction that conveys a sense of factuality and resonance with the patient's experience and achieves a level of consensual acceptance for both therapist and patient.

From this point of view, then, clarification can be seen as integral to the interpretive process. Even more tellingly, clarification emerges as a process involving therapist and patient in a dialectic of inquiry, each enacting a contributory role in the process—the patient remembering, reconstructing, and recounting, the therapist listening and inquiring. This emphasis on the interactive quality of clarification process moves beyond early views of clarification in a one-person paradigm and locates the therapist's clarifying activity in a two-person process without changing the essentials of what the therapist does or what it means. In the classic view, the therapist clarifies by presenting a clarifying comment for the patient's consideration; but in the present view such an active intervention is only one dimension of clarification that reflects an underlying process of seeking for clearer information and understanding.

III. CLARIFICATION OF THE SELF

Clarification has another and even more important focus, namely what is involved in the patient's experience of self in whatever context of action and reaction or interaction encountered. We are concerned here with clarification with respect to the patient's self-introspection, that is the subjective experience of self as object. Clarification in this respect involves the same attention to specifics and detail as described earlier with regard to external events, but here the focus is on the patient's subjective self-experience, with special attention to affective states and feelings. The supposition

here is that the configuration of qualities the patient attributes to himself as a person plays a crucial and central role in the patterns of maladaptive, self-defeating, and pathogenic action and experience that lie at the root of the neurotic difficulties or character faults. This aspect of the subjective inner world can be described phenomenologically in terms of pathogenic self-images or self-representations, that is of the patient's self- and object representations and their relation to self- and object roles in the therapeutic interaction, or in more structurally oriented terms as introjective configurations.

The introjects are derived from internalizations of significant objects in the patient's developmental history, but in distinction from identifications, are based on instinctual motivations, largely aggressive and narcissistic, and reflect corresponding defensive organization and expression. The introjective configuration can be schematized along the lines of aggressive and/or narcissistic derivatives distributed in polarized components. The aggressive components are centered in the aggressor introject versus the victim introject; narcissistic components find expression in the superior versus inferior introjects. These introjective configurations are all present and active in all forms of psychopathology, but with varying patterns of expression and emphasis. One component may dominate the structure of the self as object, while the rest are repressed or left operating more subtly in the background. In masochistic patients the victim introject may hold sway and determine the patient's self-experience, but not without contributions from the other components. In shame-prone patients, the narcissistic inferior introject is prominent, while the others remain in the background. Moreover, where one component dominates, the polar opposite is always in one way or other operative and will in time and with continuing inquiry and clarification come into play. Where the aggressor introject predominates, there is always a corresponding sense of the self as victim; where the narcissistic inferior introject is on display, the superior introject (grandiose self) is not far behind.

The clarification of these pathogenic introjects, including the gradual delineation of the component elements, identification of the polarized aggressive and narcissistic dimensions, awareness of their reciprocal defensive involvement, and the manner in which they form an integral whole within the subject's experience of himself, as well as progressive differentiation between elements of fantasy and reality, all contribute to the gradual delineation and undermining of the embeddedness and investment in the introjects. This much of the process is rarely sufficient for effective therapeutic intervention but leads to a further step of exploring and establishing their derivation.

The introjects are internalized derivatives of relationships with important others, so that exploration of their derivation requires clarifying the specific ties to past and/or present individuals in the patient's experience. How to accomplish this is a matter of clinical judgment and technique. With some patients exploration of this area of their experience can be done fairly actively, but this is not often the case. More frequently, the exploration must be more indirect and subtle and requires a considerable degree of self-discipline and patience on the part of the therapist. Little by little, the picture of the patient's past relationships, particularly with parental figures, becomes clearer. The pitfalls are familiar enough, and it often takes a considerable amount of time and work before more reliable information about the patient's past experience becomes available. Early reminiscences or even the first or second rendition of the patient's past experience cannot be taken as having unquestionable validity. The picture that the patient paints in the first rough sketching of his or her past will be progressively filled in, resketched, refined, and recast as the therapy progresses. It is not simply a matter of recapturing a past reality. Rather, what is in question is the recapturing of the patient's experience, which may be overladed and permeated with elements of fantasy, wish, desire, and defense. The task is to retrace the patient's experience, to establish the links between the present organization and structure of the introjects and the patient's past experience of personal relationships. The critical persons in this context are, of course, the parents, though not exclusively. Other important figures may enter in, depending on the peculiarities of the patient's life experience. Siblings may play a vital role, or other relatives such as aunts or uncles, or even nonfamily figures.

Likewise, the clarification of important relationships can only be usefully undertaken in the context of a reasonably good therapeutic alliance; it may not be useful to try to clarify or confront the patient's convictions about important objects, because disruption of such object connections may be more damaging than helpful. Patients can be brought gradually to a point of recognizing and understanding the more realistic aspects of their relationships, but this comes as the fruit of therapeutic effort and can be achieved only in the context of a solid therapeutic alliance.

IV. CLARIFICATION AND THE TRANSFERENCE

Nonetheless, confrontation along with clarification may have an important role to play, especially early in

the course of the therapy. Interpretation is not possible or useful until the patient has developed some degree of at least a working alliance. As long as the therapist's interpretations are caught up in the vicissitudes of the patient's projective distortions and negative transference reactions, they will be heard as either threatening or destructive, or if reflecting a more idealized transference situation as unempathic reinforcements of the patient's transference views. Consequently, a relative focus on the patient's daily life experience and a process of gentle and gradual clarification can lead not only to the establishing of a better alliance but can also gradually clarify and delineate the pathological patterns of interaction that the patient generates both within the therapeutic interaction with the therapist and in important relationships outside the therapy. Success with many more severely disturbed patients is a function of the accuracy, empathy, and timeliness of the therapist's gentle and understanding clarifications and confrontations that lay the basis for later interpretations and to a degree contribute to unveiling transference. Especially, gentle confrontation and clarification of the patient's feelings about the therapist can open the way to clarification of therapeutic alliance issues and further analyze transference reactions.

Part of the process of clarification of the introjects depends on their display in the transference. The clarifying process tries to link aspects of both aggressive and victim introjects and superior and inferior narcissistic introjects, as discovered in the other aspects of the therapeutic work, with the patterns emerging in the transference, as deriving from a common root. Recognizing and acknowledging these patterns in the ongoing interaction with the therapist can often make a powerful impression on the patient and add conviction and vividness to the basic patterns.

In the interest of maintaining the therapeutic alliance, the therapist must pay careful attention to negative transference elements. A consistent element in many therapies is the patient's efforts to defeat the therapist, to make the therapy into a meaningless and ineffectual game as well as to destroy whatever there is in the experience that may be positive and constructive. Behind this lies the inner necessity on the part of the patient to maintain the introjective configuration that provides the core of the often-fragile and unstable self-organization. As I have already suggested, the projective elaboration underlies and induces a transference-countertransference interaction, the underlying motivation for which is preservation of the pathogenic introjective organization. Thus, a constant attention to focusing, clarifying, and eventually interpreting negative transference elements is of particular

importance in the interest of establishing and maintaining a therapeutic alliance.

Therapeutic clarification is particularly useful when the patient adopts the victimized position, reflecting the underlying victim introject. The need for some patients to preserve the sense of victimization (victim introject) forces them to provoke aggressive or devaluing responses from the therapist, often in the form of acting out around the dimensions of the therapeutic structure, forcing the therapist, for example, to take remedial limit-setting measures. It is essential for the therapist to set limits to maintain the parameters of the therapeutic situation, but the risk of being drawn into a transference-countertransference interaction cannot be ignored. A clear statement of the patient's victimized position, or of the potential victimizing effects of a projected course of acting out, can serve as a useful way of focusing on the underlying dynamics and the motivations related to them and of bringing into focus their effects on the therapeutic work and particularly the therapeutic alliance. Such clarifications, and where necessary, confrontations with the patient's potential self-destructiveness, and need to assume the victimized position carry with them a reassurance that the patient is not on this account abandoned or rejected, and undercut the pull in the countertransference reaction to playing into the patient's victimization, thus reinforcing it.

The risk of acting out of the transference can be dealt with by a combination of clarification, confrontation, and interpretation. The extent to which these interventions can be usefully employed in such situations depends on the degree to which the therapeutic alliance is effectively intact. Where the alliance is disrupted or significantly distorted, interpretive efforts are liable to yield little fruit. Nonetheless, active confrontation and clarification of the issues, particularly in alliance terms, and a clarification of the possibly harmful consequences for the patient and the role of the patient's intended acting out in undermining the work of the therapy is often sufficient to short-circuit the patient's impulse.

These experiences have considerable potential value in that they immediately involve both patient and therapist in the process. The therapist does not have to rely on a secondhand account with all its potential for distortion and obscurity but is himself engaged in the process with the patient, so that the elements that enter into the patient's need to act out can be more directly and effectively identified and dealt with. In a mild form, for example, the patient may act out around the issue of coming to the appointments on time. Usually, this reflects some distortion in the therapeutic alliance and may or may not reflect underlying transference dynamics. Yet the con-

tributing factors lie ready at hand for examination as a part of the ongoing therapeutic interaction and can be clarified, explored, and dealt with in those terms. The patient who comes late following the therapist's vacation is usually expressing some degree of resentment or anger at abandonment by the therapist. Clarification and interpretation of the feelings of abandonment can usually effectively modify the patient's behavior.

For some patients in whom the impulse to act out is inconsistent with their self-image and creates anxiety, the therapist's effort to clarify, and even at times interpret the basis of the impulse and the possible consequences are enough to forestall the behavior and enable the patient to reestablish reasonable control. Often, the clarification of the patient's feelings, particularly what the feelings may be about and against whom they would be directed, or a clarification and exploration of possible consequences of the actions envisioned by the patient, or even clarification and interpretation of the patient's impulse by comparing it to similar impulses in other contexts, whether in the patient's current life situation or in the past life experience, to whatever extent that is available, enables the patient to gain some perspective and objectivity about the projected course of action and allows him or her to bring resources to bear to forestall a self-destructive or potentially detrimental course of action. At times substitute actions can be discussed, which would be in the long run more adaptive and even effective for the patient. At times it is also useful for the therapist to anticipate patterns of acting-out behavior, especially when the previous experience of the ways in which the patient has dealt with similar stimulus situations would lead the therapist to expect that some parallel pattern of behavior might evolve. The classic example is the exploration of a patient's projected behavior during the therapist's vacation. The exploration of these possibilities and the comparison of the anticipated pattern of behavior with similar previous experiences can be both clarifying and extremely helpful.

One young man who was given to impulsive rage attacks became furious during an argument with his girlfriend and put his fist through a wall. The consequences were that not only did he have to pay for the damage to the wall, but he also broke his fist, which had to be put in a cast, which meant that he could not work and subsequently lost his job. In subsequent therapeutic work with this patient, it was extremely helpful to anticipate situations of conflict and tension in which his impulse to act out in some self-destructive way could be discussed, clarified, the feelings explored and connected with a variety of similar and previous contexts, and some sense of

adaptive options developed that might provide more mature and even constructive outlets for his anger.

Extending the exploration and clarification to include the derivation of the introjects has the additional benefit of clarifying that the patient's experience of self and the world around—and particularly relationships with other important figures—is dependent on experiences and patterns of responding deriving from the patient's own infantile past. The disparity between that past and the present experience reinforces insight into the fantasy quality of the experience generated from the introjects and clarifies the distinction between elements of that experience and the real world of the patient's present life. In the transference neurosis, of course, this understanding and realization are borne in on the patient with particular force, because it allows him or her to see most clearly and vividly how the patterns of infantile relating play themselves out in inappropriate and unrealistic ways.

V. THERAPEUTIC CONTEXTS

There is some differentiation in the role of clarification with respect to expressive versus supportive approaches to therapy, although the climate of opinion has shifted somewhat to seeing psychotherapy for the most part as combining supportive and expressive techniques. More expressive approaches seek to bring about structural change by way of clarifying and interpreting the patient's distortion of self and the object world primarily through analysis of transference. More supportive approaches, in general, recommend focusing on current events and recent sources of stress in the patient's life and tend to focus away from transference elements, particularly where they seem regressive; attention is directed to clarifying feelings and reinforcing a sense of reality. The therapist takes a more active stance in supporting and reinforcing the patient's adaptive capacities, supporting useful defenses, and generally acting as an auxiliary ego. Thus, supportive approaches tend to rely more extensively on techniques of clarification focused on current conscious manifest experience, whereas expressive approaches seek to go further and deeper to interpret psychogenetic, dynamic, and unconscious implications of the patient's behavior. If therapy shifts more in the direction of an expressive modality, interpretation comes to play a more prominent and central role. When the therapy is more supportive, interpretation is by no means ruled out but tends to assume a more modest role in favor of a more prominent use of

other more supportive techniques, including clarification, confrontation, giving support, encouragement, advice, and so on.

Clarification has a special role to play in family therapy. In dealing with the family, the therapist must be clear about the nature of the relationship to the patient and how that interdigitates with the relationship to the family and what his or her purpose and role is in each of those related contexts. Ultimately, the desire for all parties involved must be taken as seeking the well-being of the patient as connected with the better- and healthier functioning of the family system and ultimately to the benefit of all parties involved. This clarification and stance must be maintained in the face of continual pressures from all sides, on the part of both the individual patient and the family, to undermine this position, to draw the therapist into one or other transference position, and to elicit from him or her some form of countertransference response that will serve to undermine the therapeutic alliance, destroy the therapeutic position and make him or her ineffectual as a therapist, and thus preserve the underlying fantasies and narcissistic and aggressive distortions that are an integral part of the neurotic family system.

Often enough treatment of adolescents involves work with the family. The difficulties in maintaining a therapeutic alliance with a disturbed adolescent patient are monumental enough, but when the therapist moves into the realm of family therapy, in addition to the work with the patient, the situation inevitably becomes more complex and difficult. There is a kind of cost-benefit analysis involved—the cost in terms of the jeopardy to the alliance and the individual therapeutic effort versus the gains to be gotten from the work with the family. That analysis is not always negative. Where the therapeutic alliance with the adolescent is sufficiently stabilized, where the therapeutic interaction is such that the potential difficulties in the alliance that may arise from the involvement with the family system can be explored and clarified and understood, and where the therapist is able to maintain a sufficiently balanced position in the dual role as individual and family therapist, the process can often be gratifying and successful.

VI. SUMMARY

This article discusses the nature of clarification as an integral component of the interpretive process, and as distinct from both confrontation and interpretation. Clar-

ification concerns inquiry and seeking for understanding, thus providing the basic material essential for further interpretation. Clarification focuses not only on the patient behavior and experience with others in external interactions, present or past but includes consideration of the person's inner subjective experience of self as acting and experiencing, especially aspects of the affective experience. Clarification of both aspects of the experience provides the basis for clearer and more meaningful understanding both of self and of his or her behavior.

See Also the Following Articles

Confrontation ■ Differential Attention ■ Interpretation ■ Resistance ■ Transference ■ Working Alliance

Further Reading

- Edelson, M. (1975). *Language and interpretation in psychoanalysis*. New Haven, CT: Yale University Press.
- Meissner, W. W. (1978). *The paranoid process*. New York: Jason Aronson.
- Meissner, W. W. (1981). *Internalization in psychoanalysis*. (Psychological Issues, Monograph 50). New York: International Universities Press.
- Meissner, W. W. (1994). *Psychotherapy and the paranoid process*. Northvale, NJ: Jason Aronson.
- Meissner, W. W. (1996). *The therapeutic alliance*. New Haven, CT: Yale University Press.
- Spence, D. P. (1982). *Narrative truth and historical truth*. New York: Norton.
- Wallerstein, R. S. (1986). *Forty-two lives in treatment: A study of psychoanalysis and psychotherapy*. New York: Guilford Press.

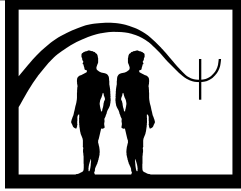

Classical Conditioning

Steven Taylor

University of British Columbia

- I. Description of Treatment
 - II. Theoretical Bases
 - III. Exposure Therapies: Applications and Exclusions
 - IV. Empirical Studies
 - V. Case Illustration
 - VI. Summary
- Further Reading

GLOSSARY

classical conditioning A form of associative learning in which a neutral stimulus is paired with an unconditioned stimulus. After a sufficient number of trials the neutral stimulus comes to elicit responses similar to those originally evoked by the unconditioned stimulus.

counter-conditioning A classical conditioning procedure in which a stimulus that formerly elicited one response (e.g., pleasure) is conditioned to elicit a different response (e.g., nausea). Sometimes used in the treatment of paraphilias and substance use disorders.

exposure A group of methods commonly used to treat phobias and other anxiety disorders. Exposure involves presenting the person with harmless but fear-evoking stimuli until the fear response is extinguished.

extinction Reduction of a learned response by presenting the conditioned stimulus in the absence of the unconditioned stimulus.

operant conditioning A form of associative learning in which a given behavior is shaped by its consequences. In the case of phobias, for example, avoidance and escape from feared stimuli increases in frequency because these behaviors are reinforced by short-term fear reduction.

Classical conditioning, as conceptualized in early work and in contemporary theories, provides a way of understanding the occurrence of a range of maladaptive emotional and behavioral responses. Although there are multiple ways in which these responses can be learned, classical conditioning appears to represent an important pathway. Classical conditioning theories provide a basis for understanding how such responses can be treated. Exposure therapies for treating fears are among the most useful interventions to arise from these theories. Exposure therapies also are effective for reducing fears arising from other forms of learning.

I. DESCRIPTION OF TREATMENT

A. Overview

Treatments based on classical conditioning fall into two broad categories: aversion therapies, which are designed to reduce appetitive responses, and exposure therapies, which are designed to reduce aversive or unpleasant responses. Aversion therapies have been vividly portrayed in novels and films such as *A Clockwork Orange*. The focus is on reducing maladaptive responses that the patient might find enjoyable, such as the elimination of excessive alcohol consumption or, in the case of Little Alex, the protagonist of *Clockwork Orange*, the elimination of his passion for “ultraviolence.” Classical conditioning methods for reducing alcohol consumption include emetic treatments, where the person ingests

a nausea-inducing drug and then is asked to sample his or her favorite alcoholic beverage. Over a series of trials, the person learns to associate drinking with immediate nausea. Thus, the former association between drinking and pleasure is replaced by an aversive association, thereby reducing alcohol consumption. Similar treatments have been devised for treating self-injurious behavior in children and paraphilias in adults.

Aversion therapies are not commonly used today. This is because of ethical concerns about inflicting harm on patients, and concerns about patient welfare. The efficacy of aversion therapies is also debatable. Some critics argue that these treatments are short-lived in their effects, and that they only suppress maladaptive responses without teaching the patient more adaptive alternatives. Aversion therapies are widely regarded as interventions of last resort, to be used only when more benign methods have failed. If used, aversion therapies should be administered by a trained professional, with the approval of the institution in which the professional is working. Informed consent should be obtained and regional laws should be considered, because aversion therapies have been outlawed in some jurisdictions.

A more popular application of classical conditioning is the exposure therapies. These treatments are used to help people overcome specific phobias and other anxiety disorders in which excessive fear plays a prominent role, such as agoraphobia, social phobia, posttraumatic stress disorder, and obsessive–compulsive disorder. Given that exposure therapies for treating phobias are the most widely used applications of classical conditioning, these treatments and their theoretical bases will be the focus of this chapter.

The treatment of fears is not a trivial undertaking. Severe phobias can produce extreme distress and can severely impair a person's functioning. Driving phobia, arising after a motor vehicle accident, for example, may prevent the person from earning a living and may lead to social isolation if the person lives in a remote area. Even common phobias such as spider phobias can be debilitating. One patient reported being too afraid to enter rooms of her house in which she had seen spiders, and experienced intense panic attacks whenever she unexpectedly came across a spider. She lived in an area in which spiders were commonly encountered, and therefore was chronically hypervigilant for spiders, and worried about encountering them. This was associated with persistent tension and irritability. Her fear, avoidance, and preoccupation significantly interfered with her marital relationship. Fortunately, even severe phobias such as this one can readily be treated by exposure therapies.

During exposure therapy, the person is presented with fear-evoking stimuli in a controlled, prolonged fashion, until the fear diminishes. Patients are encouraged to focus on the stimulus and to notice their anxiety, without engaging in distraction or other forms of avoidance. Treatment is collaborative, with the patient and therapist working together to decide how and when exposure will take place. Exposure duration depends on many factors, including the type of feared stimuli and the severity of the person's fears. Typically, an exposure session lasts 20 to 90 minutes, and sessions are repeated until the fear is substantially reduced. Sessions may be either therapist-assisted or completed by the patient as a homework assignment. Antianxiety drugs such as benzodiazepines should be used sparingly or not at all with exposure therapies, because these drugs can interfere with the effects of exposure. Sources of perceived safety, such as the therapist or significant others, are also faded out during exposure therapy, so that patients can overcome their fears in the absence of safety cues.

There are several ways that exposure can be conducted. The person may be exposed to real stimuli or may simply imagine the stimuli. Exposure may be to intensely fear-evoking stimuli, or may be gradual, working up a hierarchy of feared stimuli. Type of stimuli (real vs. imagined) and intensity of exposure (gradual vs. highly fear-evoking) are the variables distinguishing the four main types of exposure therapy: graded *in vivo* exposure, flooding, systematic desensitization, and implosion.

B. Graded *in Vivo* Exposure

This is the method most commonly used to reduce fear. It has two components. First, the patient is instructed how to rate the intensity of discomfort using a Subjective Units of Distress Scale (SUDS). This measure of fear and distress ranges from 0 to 100, where 0 = none, 50 = moderate, and 100 = extreme. Second, the therapist and patient devise a hierarchy of real-life fear-evoking stimuli, ranging from stimuli that evoke little or no fear or distress, to extremely frightening or upsetting stimuli. Table 1 shows an example of a hierarchy used in the treatment of agoraphobia.

Typically there are 8 to 10 stimuli in the hierarchy, separated by SUDS increments of approximately 10 points, so that the stimuli are not too discrepant in the levels of fear or distress they evoke. Patients begin by exposing themselves to items lowest on the hierarchy. Exposure to a given stimulus is repeated until the fear or distress abates. When fear of a given stimulus is

TABLE 1
Sample Exposure Hierarchy for Agoraphobia: Fear of Traveling Far from Home

Exercise: Walking to ... and then returning	SUDS ^a
1. End of street (2 blocks away from house), accompanied by spouse	10
2. End of street, unaccompanied	25
3. End of street and one block around the corner (so house is not visible), accompanied	35
4. End of street and one block around the corner, unaccompanied	50
5. To the nearby park (6 blocks from house), accompanied	60
6. To the nearby park, unaccompanied	75
7. To the grocery store (8 blocks from house), accompanied	80
8. To the grocery store, unaccompanied	90

^a Subjective Units of Distress Scale, ranging from 0 (no fear or distress) to 100 (extreme fear or distress).

reduced, the other stimuli on the hierarchy also tend to become less fear evoking. The patient gradually works up the hierarchy; once the fear of one stimuli is diminished, exposure to the next stimulus is attempted. This continues until all the stimuli on the hierarchy no longer evoke fear or distress.

Sometimes it is necessary to develop more than one hierarchy to reduce all the patient's fears. For a person with generalized social phobia, a patient might work through a public speaking hierarchy, a hierarchy of situations involving one-to-one conversations with people of the opposite sex, and a hierarchy involving asserting oneself to authority figures. The disadvantage of graded *in vivo* exposure is that it is slower than the more intensive flooding method. The advantage of graded exposure is that it teaches patients a skill for overcoming their phobias in a simple, step-by-step fashion. By progressively working up a hierarchy, patients can overcome their phobias gradually, without enduring extreme fear or distress. After a formal course of therapy ends, patients can continue to devise hierarchies on their own for overcoming any remaining fears.

C. Flooding

Flooding involves exposure to real-life fear stimuli that are at the top of the person's hierarchy. A person with a dog phobia might be exposed to a large boisterous dog until the person is no longer afraid. The advantage of flooding is that it is the most rapid method for reducing phobias; four 2-hour sessions are often all that is required. Sometimes phobias can be successfully reduced within a single 3- to 4-hour session.

There are several disadvantages to flooding. First, it requires the person to tolerate a great deal of distress.

Some people, particularly those with severe phobias, are unable to do this. Second, flooding can produce temporary but intense side effects such as irritability and nightmares. Third, flooding is often too difficult for patients to conduct alone, and so this treatment does not teach patients a skill they can readily use on their own. A further concern is that patients may be more likely to refuse or drop out of very intensive programs, compared to less demanding programs. When used, flooding is typically implemented with the support and encouragement of a therapist. It is most often used when there is some pressing need for the rapid elimination of the fear. If a person had a phobia of hospitals and medical staff, for example, flooding might be used if the person were to be admitted to the hospital for an urgent medical procedure.

D. Systematic Desensitization

Systematic desensitization consists of gradual, imaginal exposure to stimuli organized on a hierarchy constructed using SUDS ratings. The stimuli in Table 1, for example, could be used in systematic desensitization by having the patient imagine each stimulus. Typically, systematic desensitization is combined with some form of relaxation training. The patient is asked to sit back in a comfortable chair and practice a relaxation exercise. Once a state of deep relaxation is attained, the patient is asked to imagine the least upsetting stimulus on the hierarchy. Exposure duration might be only for a few minutes, alternating relaxation with imaginal exposure until the imagined stimulus no longer evokes fear or distress. The procedure is then repeated with the next stimulus on the hierarchy. The disadvantage of systematic desensitization is that it is slow, and that it is

often necessary to eventually implement some form of real-life exposure in order to fully reduce the fears. The advantage is that it is easily tolerated and is therefore a good place to start when treating patients with extremely severe fears.

E. Implosion

Implosion involves exposing the person to intensely fear-evoking imagined stimuli, which lie at the top of the fear hierarchy. Often exposure is embellished by having the patient imagine extremely terrifying forms of the stimuli. Implosion is often used in the treatment of posttraumatic stress disorder, where the goal is to reduce the fear and associated distress associated with traumatic memories. More often, however, the feared stimuli are simply imagined in great detail, with the person imagining all the sensory aspects of the stimulus (e.g., sights, sounds, smells), along with any bodily sensations, emotions, and thoughts that might occur when the stimulus is encountered. A person who developed posttraumatic stress disorder as a result of being in a motor vehicle accident, for example, would be asked to repeatedly imagine the traumatic experience, typically for 30 to 45 minutes per treatment session over several sessions. The narrative of the experience might be spoken into a tape recorder or written down, and the person would be encouraged to repeatedly go over the tape or transcript until the memory of the traumatic event no longer evokes distress.

The advantage of implosion is that by reducing the distress associated with traumatic memories, the other symptoms of posttraumatic stress disorder also tend to abate. In other words, implosion can lead to reductions in reexperiencing symptoms (e.g., nightmares, flashbacks), hyperarousal symptoms (e.g., irritability, increased startle response), and avoidance and numbing symptoms (e.g., avoidance of reminders of the traumatic event). A further advantage is that implosion enables the patient to overcome fears for which live exposure is impossible or impractical. Fear of thunderstorms, for example, can be reduced by having the patient repeatedly imagine such events.

The disadvantage of implosion is that it can be demanding on patients; they must be able to tolerate intense distress. A further problem is that implosion does not teach patients a skill that they can readily employ by themselves at home, simply because it is often too difficult because of the degree of emotion generated. Even if a patient is able to complete a course of implosion, it is often necessary to add some form of real-life exposure in

order to completely reduce the fear. A person with a thunderstorm phobia might need to actually experience a thunderstorm in order to fully overcome his or her fear.

II. THEORETICAL BASES

A. Two-Factor Theory

During the 1960s and 1970s the most influential conditioning model of fear was O. Hobart Mowrer's *two-factor theory*, which has its origins in the 1920s work of Ivan Pavlov and John B. Watson. Mowrer proposed that fears are acquired by classical conditioning and maintained by operant conditioning. *Classical conditioning* is the learning of associations between an unconditioned stimulus (UCS) and conditioned stimulus (CS). In the case of learned fears, UCSs are stimuli that evoke pain or fear in the absence of any prior learning. Fear or pain evoked by UCSs are called unconditioned responses (UCRs). Conditioning occurs when a CS is paired with a UCS over one or more trials. Gradually, the organism learns that the CS is premonitory of the UCS. Thus, the CS becomes fear-evoking. The acquired fear is the conditioned response (CR). Operant conditioning is learning in which a given behavior is shaped by its consequences. Avoidance and escape from feared stimuli increases in frequency because these behaviors are reinforced by short-term fear reduction. Thus, avoidance and escape behaviors fall under the influence of operant conditioning.

A rodent phobia, for example, might arise from a traumatic incident where the person is bitten on the hand by a rat while organizing boxes in a dark cellar. Stimulation of the pain receptors in the hand might represent the UCS, which evokes pain and fear (UCRs). Through the process of associative learning, pain and fear become paired to stimuli associated with the UCS (e.g., CSs such as rats, mice, places frequented by rodents). In turn, the CSs elicit fear (the CR). The strength of the CR is determined by a number of factors including the intensity of the UCS and factors influencing the strength of the association between the CS and UCS, such as the number of pairings between the two. Stimuli resembling fear-evoking CSs can become fear-evoking in their own right by processes of stimulus generalization and second-order conditioning. As a consequence, a wide range of rodent-related stimuli may elicit fear and associated behaviors, such as escape or avoidance.

The strength of the CR tends to decline over successive trials in which the CS is presented without the UCS.

Thus, fear would gradually decline if the rodent phobic had repeated harmless encounters with rats. Given a sufficient number of trials of CS without UCS, the CS eventually ceases to elicit the CR. When this occurs the CR is said to be *extinguished*. Extinction does not occur if the UCS is occasionally encountered. Driving phobia would be unlikely to extinguish if a person occasionally experiences “near misses” while driving. For many people with phobias, the process of extinction is blocked from occurring because the person learns that fear can be minimized (at least in the short term) by avoiding or escaping from the CS. In other words, avoidance or escape (operant behaviors) prevent classically conditioned fears from being unlearned.

Mowrer’s theory is supported by a good deal of evidence (see Marks, 1987; O’Donohue, 1998). In brief, evidence from a variety of sources supports the theory, including (1) studies of the experimental induction of fear in animals; (2) naturalistic observations of soldiers during military combat; (3) clinical observations from anxiety-disordered patients; (4) incidental findings from studies of aversion therapy. Studies of the experimental induction of fear in children provide mixed support for the theory, possibly because of methodological limitations and ethical constraints that preclude the induction of intense fears.

B. Are Conditioned Associations Indelible?

It was once believed that extinction was a process of weakening or even breaking the CS–UCS association. Findings emerged, however, to call this assumption into question. When the CR is extinguished by repeatedly presenting the CS in the absence of the UCS, it was found that the CR could be rapidly reestablished by only a few CS–UCS pairings. Reinstatement of the CR is often more rapid than the original conditioning of the CR. Moreover, extinguished CRs sometimes “spontaneously” reemerge, or reappear when the person undergoes some unrelated stressful experience. These findings suggest that the CS–UCS link is preserved to some extent even when the CR is extinguished. Indeed, some researchers have argued that fear memories (i.e., representations of a link between a CS and aversive UCS) are indelible.

If CS–UCS links are preserved (to some extent) even after the CR is extinguished, then how does extinction occur? There are several possibilities. CR extinction may be due to counter-conditioning, where the CS is conditioned to competing UCSs. To illustrate, in a con-

ditioned dog phobia, dogs (CSs) are associated with pain or physical injury (aversive UCSs). Over a course of exposure trials, consisting of exposure to friendly, harmless dogs, the conditioned fear (CR) extinguishes. This may occur because the extinction trials cause dogs to become associated with pleasurable UCSs (e.g., pleasurable tactile stimulation from patting dogs; or a state of enjoyment from playing with dogs). If the link between the CS and a pleasant UCS is stronger than the link between the CS and an aversive UCS, then the CR will tend to be pleasure rather than fear. Thus, extinction can be regarded as a process of building up competing responses that inhibit or interfere with the link between the CS and an aversive UCS. Other models of extinction also have been postulated. The interested reader should consult O’Donohue (1998).

The preservation of links between the CS and aversive UCS has important implications for exposure therapy. It suggests that successfully treated phobic individuals are at risk for relapse if, for example, some event caused the CS–aversive UCS link to become strengthened. A former dog phobic might discover that his or her phobia reemerges after an unpleasant encounter with a dog. Therapists need to prepare patients for the possibility of relapse. This can be done by discussing the issue with the patient, and formulating a plan for dealing with any reemergent fears. It is important that the patient understands that if the phobia returns, it can be readily eliminated by reapplying exposure techniques such as graded *in vivo* exposure.

C. Pathways to Fear

Despite its strengths, there are several problems with Mowrer’s two-factor theory: (1) It sometimes appears that fears are acquired in the absence of conditioning; (2) conditioning theory fails to account for the uneven distribution of fears; that is, some stimuli are more likely to become feared (e.g., harmless snakes and spiders) compared to others (e.g., guns, knives, electrical outlets); and (3) people sometimes fail to acquire fears in what should be fear-evoking situations (e.g., air raids). Rather than reject the two-factor theory, theorists have attempted to modify it to account for these findings.

To account for fear acquisition in the absence of conditioning, S. J. Rachman postulated three pathways to fear acquisition: (1) classical conditioning, (2) modeling (e.g., vicarious fear acquisition due to observational learning), and (3) verbal information (e.g., receiving fear-evoking information or misinformation from others) (see Rachman, 1990). Several retrospective studies

of fears have assessed the relative importance of these pathways. Results show that approximately half of clinical phobias are associated with classical conditioning, with a smaller proportion of phobias associated with modeling or verbal information. Research also suggests that classical conditioning plays a greater role in phobias than in milder fears. A minority of people with phobias appear unable to recall the origins of their fears. This may be because they have forgotten the precipitating events. Another possibility is that some people cannot recall the origins of their fears because some fears are innate.

Aversive conditioning experiences are not just reported by phobics; they also occur in nonfearful people. As noted earlier, the fact that some people may have a history of “conditioning events” without developing phobias is one of the criticisms of the two-factor theory. To account for this anomaly, it has been proposed that aversive conditioning experiences are less likely to produce phobias when the person has a history of fearless contact with the stimulus in question. For example, an aversive experience (e.g., falling from a horse) may not be phobogenic when the person has a history of mishap-free equestrian adventures. This fear-impeding effect is known as latent inhibition or fearless familiarity. Latent inhibition has been experimentally demonstrated in a variety of organisms, including children and (under certain circumstances) adults. Latent inhibition appears to occur because the CS fails to become fear-evoking because a history of fear-free CS presentations causes the CS to be a predictor of the *absence* of fear. The high incidence of condition events for nonfearful people may be due to the mechanisms responsible for latent inhibition.

D. Prepared Fears

In 1970, Martin E. P. Seligman observed that phobias have a number of characteristics that seem inconsistent with the two-factor theory. Phobias can be (1) rapidly acquired (e.g., single-trial learning), (2) resistant to extinction, (3) “nongenerative” (i.e., phobias persist even when the person “knows” the stimulus is harmless), and (4) differentially associable with stimuli of evolutionary significance. With regard to the latter, the two-factor theory assumed an equipotentiality of stimuli; all neutral stimuli can be converted into a conditioned stimulus. Yet, some stimuli (e.g., small animals) are more likely to be fear-evoking than others (e.g., guns, knives, electrical outlets). As Seligman observed, only rarely, if ever, do we have pajama phobias, grass phobias, electric-outlet pho-

bias, hammer phobias, even though these things are likely to be associated with trauma in our world.

Seligman proposed that people (and other organisms) are biologically prepared to acquire fears of particular stimuli. That is, evolution has predisposed organisms to learn easily those associations that facilitate species survival. As a result of a sufficiently long period of natural selection, organisms are prepared (“hard wired”) to fear some events, unprepared for others, and contraprepared for still others. Stimuli such as guns, knives, and electrical outlets have not been around long enough for such preparedness to occur. Seligman conceptualized preparedness as an ease of learning continuum; that is, the relative preparedness for learning about a stimulus is defined by the amount of input (number of learning trials, bits of information, etc.) required in order for an output (responses) to occur reliably.

Preparedness theory has stimulated a large body of research. The most impressive evidence comes from the studies of Rhesus monkeys. In some studies, “observer monkeys” watched videotapes of other monkeys behaving fearfully with a toy snake or crocodile. As a result, the observers acquired a fear of those stimuli. In comparison, observer monkeys who watched videotapes of monkeys showing the identical fear behaviors (via videotape splicing) to artificial flowers or toy rabbits generally did not acquire fears of the flowers or toy rabbits. Thus, there were significant differences in the conditionability of fear to fear-relevant stimuli compared to fear-irrelevant stimuli.

Evidence from human studies has not been so compelling. An extensive review of the research by Richard J. McNally found that some experiments supported Seligman’s preparedness hypothesis, while other studies did not. The evidence most consistent with the theory is enhanced resistance to extinction of electrodermal responses to “prepared” fear stimuli. Moreover, “prepared” phobias are generally no more difficult to treat than “unprepared” phobias. What we are left with is the fact that there is a nonrandom distribution of fears and phobias; that is, fears of some stimuli (snakes) are more common than others (e.g., hammers). Latent inhibition to stimuli such as hammers, electric outlets, and so forth may account for the rarity of fears of such stimuli (i.e., children typically receive parental instruction as to the safe use of such stimuli).

In summary, to attempt to overcome the more important limitations of the two-factor model, it has been proposed that (1) there are multiple pathways to fear, of which conditioning is one, (2) the failure to acquire fears may be due to latent inhibition (i.e., a history of

fearless familiarity with potential fear stimuli), and (3) the uneven distribution of fears arises because some fears are prepared in an evolutionary sense. Although these explanations have their merits, they also have some weaknesses, including weak or equivocal empirical support.

E. Neo-Conditioning

Contemporary approaches to classical and operant conditioning are known as neo-conditioning models (e.g., Davey, 1992; Rescorla, 1988). They propose that conditioning involves processes that draw on cognitive mechanisms such as expectations and memory representations of the CS and UCS. Here, UCS–CS links are acquired because CSs are predictors of the occurrence of the UCS. To illustrate, a person with a fear of driving might learn that poorly lit, wet roads (CSs) are predictive of life-threatening motor vehicle accident (UCS). The strength of the conditioned fear is a function of two factors: (1) the strength of the UCS–CS link (i.e., subjective probability that a given CS will lead to a given UCS), and (2) the perceived aversiveness of the UCS (e.g., perceived dangerousness of motor vehicle accidents).

The neo-conditioning approach also entails a revised view of operant conditioning of avoidance behavior. Here, avoidance is not directly determined by the experience of fear, but by the individual's expectation of whether a given behavior (e.g., driving in the rain) will lead to an aversive outcome (e.g., a fatal accident). Avoidance behavior is not reinforced by reduction of fear; it is reinforced by full or partial confirmation of one's expectations (e.g., by a "close call" while driving). According to the neo-conditioning perspective, UCS evaluation (and reevaluation) can influence the acquisition, extinction, and inflation of fears. When an association between a CS and UCS has been formed, the representation of the CS (stored in long-term memory) evokes a representation of the UCS. Information about the UCS contained in this representation is evaluated, and the result of this evaluation process determines the strength of the CR. If the UCS is evaluated as aversive or noxious, this will result in a fear CR.

Mild conditioned fears can escalate into phobias when the UCS is reevaluated. To illustrate, a person might acquire a mild fear of spiders after sustaining a painful but harmless spider bite. The fear may escalate into a phobia if the person later learns that spider bites are often lethal. Thus, the intensity of the UCS is inflated from a harmless painful bite to a painful and potentially life-threatening bite. As a consequence, the

nature of the CS changes (i.e., spiders now become predictive of life-endangering events) and the conditioned fear increases accordingly.

F. Emotional Processing

The neo-conditioning model proposes that the CS and UCS are cognitively represented, possibly in networks of interconnections among CSs, CRs, UCS, and UCR. The emotion processing model developed by Edna B. Foa and others (e.g., see Foa and Kozak, 1986) can be seen as an extension of the neo-conditioning model. According to the emotional processing model, fears are represented in networks known as fear structures stored in long-term memory. The networks contain cognitive representations of feared stimuli (e.g., oncoming trucks, driving at night), response information (e.g., palpitations, trembling, subjective fear, escape behaviors), and meaning information (e.g., the concept of danger). In the network the three types of information are linked (e.g., links between oncoming trucks, danger, and fear). Links can be innate (i.e., UCS–UCR links) or acquired by processes such as classical conditioning (CS–UCS links and CS–CR links). Fear structures are activated by incoming information that matches information stored in the network. Activation of the network evokes fear and motivates avoidance or escape behavior. According to Foa and colleagues, fears are reduced by modifying the fear structure through the incorporation of corrective information (e.g., safety information acquired during behavioral exposure exercises).

The neo-conditioning perspective and the emotional processing model are useful ways of conceptualizing fears, and can account for phenomena that are not explained by the two-factor theory (e.g., postconditioning fear inflation due to UCS inflation). A further advantage is that these models are compatible with other cognitive models of fears, such as those discussed in the following sections. The emotional processing model has the advantage of readily including multiple pathways for the acquisition of fears, such as classical conditioning, modeling, and verbal information. The possibility of innate fears is also consistent with the model, if one assumes that some networks or fragments of networks are innate. The model also includes a role for dysfunctional beliefs, which may amplify fears and other emotional reactions. Beliefs are represented in the network as links between meaning concepts and stimulus or response concepts (e.g., "tunnels are dangerous" is represented by a link between "tunnel" and "danger").

G. Dysfunctional Beliefs

Theories of fear have become increasingly complex in recent years. Classical conditioning and many other factors are thought to be involved. Consistent with the neo-conditioning and emotional processing models, some theorists have proposed that exaggerated beliefs about the probability and severity of danger may play an important role in motivating fear and avoidance. Such dysfunctional beliefs play a prominent role in contemporary theories of agoraphobia and social phobia, and may play a more important role in these disorders compared to specific phobia. People with social phobia tend to be preoccupied with their social presentation and have heightened public self-consciousness. They also tend to be self-critical, to excessively worry about being criticized or rejected by others, and to overestimate the likelihood of aversive social events. This suggests that such dysfunctional beliefs may be important in maintaining generalized social phobia. These beliefs appear to persist because of a variety of factors, such as avoidance of fear-evoking stimuli. Avoidance behavior limits the opportunity for collecting information that might disconfirm erroneous beliefs. Recent empirical studies support the role of distorted beliefs and appraisals in social phobia, and may be important targets for treatment. However, treatment outcome research provides mixed support for the view that adding cognitive restructuring to exposure improves treatment outcome. This may be because exposure is a potent vehicle of cognitive change.

H. Anxiety Sensitivity

In an effort to account for individual differences in the tendency to acquire conditioned fears, Steven Reiss and colleagues proposed that anxiety sensitivity is a fundamental fear that amplifies or exacerbates other fears, such as fears of animals, social situations, blood–illness–injury stimuli, and agoraphobic situations. Anxiety sensitivity is the fear of anxiety-related sensations (e.g., fears of palpitations, dizziness, and tremulousness), which arises from beliefs that these sensations have aversive somatic, psychological, or social consequences.

Anxiety sensitivity can be considered to be a fundamental fear because (1) anxiety is inherently noxious and therefore feared by most people, and (2) anxiety sensitivity provides reasons for fearing a variety of stimuli, whereas ordinary fears do not have this property. To illustrate, fear of flying can be exacerbated by, or entirely due to, the following: (1) Fear of the plane crashing (ill-

ness–injury sensitivity), (2) fear of anxiety evoked by bumpy flights (anxiety sensitivity), and (3) fear of embarrassing oneself by becoming airsick (fear of negative evaluation). Thus, a common fear (fear of flying) may be logically reduced to one or more fundamental fears such as anxiety sensitivity. Empirical support for this proposition has been provided by a number of studies.

Several studies have reported that the severity of anxiety sensitivity is correlated with the severity of various common fears, and that anxiety sensitivity predicts the person's risk for developing later fears and other anxiety symptoms. Anxiety sensitivity is reduced by exposing the person to feared arousal-related body sensations. This is called interoceptive exposure. For example, aerobic exercise can be used to extinguish the person's fear of palpitations. Voluntary hyperventilation exercises can be used to reduce fear of dizziness.

III. EXPOSURE THERAPIES: APPLICATIONS AND EXCLUSIONS

A. Medical Contraindications

Exposure techniques, such as graded *in vivo* exposure, are safe for the great majority of patients. The only medical contraindications are serious diseases that prevent the patient from entering the situations or make the experience of intense emotions hazardous to the person's physical health. Pregnancy or serious heart disease would contraindicate the use of flooding therapy. Medical conditions that seriously limit mobility—such as severe obstructive lung disease—can prevent the patient from completing some forms of *in vivo* exposure (e.g., walking long distances from home in the case of agoraphobia). In practice, however, it is rare to encounter a patient who is medically unsuited for at least some form of exposure.

B. General Guidelines for Conducting *in Vivo* Exposure

Given that graded *in vivo* exposure is the most commonly used exposure technique, it will be described in detail. There are several protocols for conducting *in vivo* exposure. Rather than describe them all, we will review the general guidelines. The guiding principle is for the person to remain in the situation until the fear has declined. Ideally, exposure also teaches the person that exposure to a feared stimulus has no harmful consequences. Thus, in addition to fear reduction, it is

important that patients remain in the feared situation until they can observe the true consequences of being exposed to the feared stimulus. Persons with a fear of heights would be encouraged to remain at, for example, the fourth floor balcony until they learn that they will not “lose control” and topple over the edge. The goals of exposure—fear reduction and expectancy change—are derived from modern conditioning theories, which emphasize the role of expectancies (see Section II).

Exposure therapies should only be implemented by a suitably trained therapist. The therapist should not only be skilled in exposure therapy, but should have a good understanding of psychopathology and psychiatric diagnosis, and should be skilled in the psychotherapeutic interventions commonly used in conjunction with exposure therapy (e.g., cognitive therapy, social skills training, relaxation training). Relaxation training is particularly useful for phobic individuals who are chronically anxious. If the patient experiences intense anger or guilt during exposure, as sometimes happens when treating patients with posttraumatic stress disorder, it is often necessary to combine exposure with cognitive therapy. The latter is used to address any dysfunctional beliefs associated with anger or guilt.

The patient should be a willing participant in the process of exposure therapy, with complete control over the nature and timing of any exposure exercises. Exposure may be traumatizing if forced on an unwilling patient. Exposure should be used only if the patient is able to tolerate some degree of distress, and is sufficiently motivated to overcome his or her fears. Patients should be told about the side effects of exposure treatment (e.g., transient increases in irritability), so they can make an informed choice about whether or not to proceed with treatment. Therapists also need to consider the patient’s other problems before initiating a course of exposure. If an agoraphobic patient was suicidally depressed, then one would need to consider whether the distress caused by exposure therapy would precipitate a suicide attempt. In such cases the depression would be the first target of treatment.

In vivo exposure exercises should be specific and well-defined, in terms of duration, situation, and what the patient must do (or not do). The exercises should be written down so they are not forgotten by either patient or therapist. The patient and therapist might generate an assignment such as the following: “Walk seven blocks from home to the supermarket. Don’t take your Ativan, cell phone, or Medi-Alert bracelet. As you walk along, pay attention to your anxiety and to your surroundings.”

In vivo exposure exercises can be practiced during therapy sessions and as homework assignments. The exercises should be ones that patients can realistically accomplish, given their current levels of functioning. Patients should not be asked to attempt exercises that they are too frightened to complete. The patient should actively participate in the exposure situation in order to be exposed fully to the various stimulus elements. Joanne N., who suffered from agoraphobia, was asked to park her car at the back of the shopping mall parking lot so she would have to walk some distance to the mall and would not have rapid access to the “safety” of her vehicle. Instead of racing through the mall, she was encouraged to stroll through, taking time to browse through the stores and ask questions of sales clerks. Contrast this therapeutic exposure to her brief exposures prior to treatment, in which she would park her car as close as possible to the mall entrance, then run in to purchase what she needed, and then race out.

In vivo exposure should be comprehensive, with different exercises covering different manifestations of the feared situations. A patient who fears and avoids shopping at supermarkets, for example, would be advised to perform this activity in many different shopping conditions, including different stores (e.g., small vs. large stores), at different locations (e.g., near vs. far from home), at different times (e.g., times in which the store was busy vs. quiet), and with different purchases (e.g., few vs. many items). This ensures that learning generalizes across settings and difficulty levels.

C. Frequency and Duration of *In Vivo* Exposure Sessions

Long, continuous periods of exposure tend to be more effective than short or interrupted periods. Although short exposure sessions (e.g., 10 to 15 minutes) can be effective, longer sessions (20 to 60 minutes) are often necessary. With regard to the frequency of exposure exercises, the research has produced conflicting results. Some studies have found that the higher the frequency of exposure sessions, the greater the rate of dropouts, the greater the short-term response for treatment completers, but the higher the rate of relapse later on. Some *in vivo* exposure is better than none, and so phobic patients should be counseled to practice their exposure exercises as frequently as they reasonably can, depending on the type of exercise and on the logistic constraints. Patients frightened of riding on buses might practice this activity 4 times per week. Patients frightened of riding as a passenger in a car might

be only able to practice this activity only 1 to 2 times each week, depending on the availability of someone to drive them.

D. Assisted Exposure

There are numerous ways that patients can be assisted in completing *in vivo* exposure exercises. Among the more commonly used are (1) therapist-assisted exposure, conducted either from the clinic or from the patient's home, and (2) exposure in which the patient is assisted by a friend, partner, or family member. Assistance consists of initially accompanying the patient, and by providing prompting and encouragement for attempting the exposure exercises. Assistance can be particularly useful during the initial attempts at exposure. Therapist-assisted exposure is also a good way for the therapist to learn about the patient's subtle avoidance behaviors. There are several ways that the therapist can directly help the patient complete *in vivo* exposure exercises:

1. The therapist can provide just enough assistance for the patient to perform the exercise, and then the assistance is faded out. If the task is to walk around a 10-block circuit from the patient's house, the therapist might accompany the patient all the way on the first trial. On the second trial the therapist might accompany the patient for 5 blocks, and on the third trial the patient might complete the circuit alone, with the therapist waiting outside the patient's home. On the fourth trial the patient might complete this task without the therapist's presence.

2. The therapist can demonstrate (model) how the exercises are performed. Here, the patient observes the therapist perform the exercise *in vivo*. For example, the patient and therapist might travel to the foot of a bridge, and then the patient would observe the therapist walk to the midpoint of a bridge without holding onto the railing, then pause and look over the edge. The therapist would then return to the foot of the bridge and the patient would perform the task. Alternatively, each step of the task could be modeled. For example, the therapist could walk to the midpoint, and then the patient would do so. The therapist would then look over the edge. The patient then follows suit.

3. The therapist can provide any support that may be required. The therapist might offer his or her arm for assistance when the patient is first approaching a bridge railing. A therapist in a hospital setting who is helping a patient overcome fear of elevators might reserve a service elevator for some of the exposure session. The therapist and patient would have exclusive

control of the elevator, and so it could be used for various exposure assignments (standing in a stationary elevator with the doors open, then with the doors closed, then traveling to the next floor, etc.). The interested reader should consult Williams (1990) for detailed descriptions of these methods.

A friend of the patient or significant other can be recruited as a "coach" to provide prompting, encouragement, and guidance. This person also can be used as a stimulus in the exposure hierarchy, as illustrated in Table 1. Later in treatment, all forms of assistance should be faded out, along with other safety signals and safety behaviors. Otherwise, patients may attribute their gains to the aid they received, rather than to their own efforts.

E. Troubleshooting

Adherence problems are the most common difficulties encountered when using *in vivo* exposure. Patients may refuse to perform the exercises. Other, more subtle, adherence problems consist of using distraction during the exercise, or limiting the intensity or duration of exposure. The best strategy for dealing with adherence problems is to avoid them before they occur. The following can help avoid these difficulties:

1. Ensure that patients understands why the exercises are important. Periodically check their understanding.

2. The interventions should not be too complicated. Understandably, patients might become confused if asked to do many things at once in a given situation.

3. Ensure that the patient understands that the selection of exercises is a collaborative venture, negotiated between patient and therapist. Tasks can be readily modified in such a way that the patient can perform them.

4. Perform the exercises yourself so the patient can see they are safe (i.e., modeling). As a rationale, the therapist might say to the patient, "I wouldn't ask you to do something I wouldn't do myself, so I'm to show you how this exercise is done."

5. Adherence can be maintained at an adequate level if the patient is sufficiently motivated to complete the various treatment exercises. To sustain motivation it can be useful to (1) reinforce (e.g., verbally praise) the patient for his or her efforts in completing each therapy assignment, and (2) have the patient self-reinforce for these efforts (e.g., praising oneself or using other incentives). Initially, reinforcement from the therapist should occur frequently. As therapy progresses, reinforcement

from the therapist can be faded out as the patient continues to use self-reinforcement.

If adherence continues to be poor then it is important to identify the source of the problem. Does the patient regard exposure exercises to be relevant to his or her problems? If not, then the patient may regard the task as pointless. Is the timing right for using exposure? More time may need to be spent on developing a trusting therapeutic relationship. Also, more time may be needed for cognitive restructuring to address beliefs about feared stimuli. For patients on PRN (as needed) medication, it is important to ensure that medication is not used as a way of avoiding the experience of fear.

F. Variations on Exposure

Exposure therapies have been applied to all kinds of disorders in which excessive fear plays an important role. Apart from the disorders discussed earlier, exposure therapies have been successfully used in treating obsessive-compulsive disorder. Here, the treatment consists of exposure and response prevention. A person with contamination obsessions and cleaning compulsions, for example, would be exposed to a “dirty” object such as a doorknob, and then asked to refrain from engaging in handwashing compulsions. In this way, the contamination-related distress gradually diminishes, and the obsessions about contamination and associated compulsions similarly abate. Exposure and response prevention are most often used in the form of graded *in vivo* exposure, although flooding is sometimes used.

Other anxiety disorders can be similarly treated with exposure methods. Acute stress disorder and posttraumatic stress disorder can be successfully treated with implosion or systematic desensitization. Here, the person is exposed to traumatic memories of the trauma, and also exposed to harmless but distressing real-life trauma-related stimuli. For example, the person might be asked to return to the site of a traumatizing motor vehicle accident. Panic disorder is treated by exposing the person to feared body sensations that lead to panic attacks (i.e., interoceptive exposure). Generalized anxiety disorder, for which excessive worry is a central feature, can be treated by exposing the person, in a prolonged fashion, to his or her worries. The person might spend 20 minutes each day writing out his or her main worries. The distress associated with the worries gradually abates, and the person correspondingly learns to dismiss the unrealistic concerns.

IV. EMPIRICAL STUDIES

A. Efficacy of Exposure

Decades of research have established that exposure therapies, particularly graded *in vivo* exposure and flooding, are the treatments of choice for specific phobias and play an important role in treating other anxiety disorders. These treatments produce clinically significant reductions in fear in about 60 to 80% of cases. Systematic desensitization is the least effective of the exposure therapies. Although it is not often used as a stand-alone treatment, this mild, undemanding intervention is a useful starting place in an exposure program for patients who are extremely phobic.

A growing number of studies have investigated whether the efficacy of real-life exposure (flooding or graded *in vivo* exposure) can be enhanced by combining it with other interventions such as relaxation training, cognitive restructuring, or social skills training. For the average phobic patient, exposure alone is no less effective than exposure combined with either cognitive restructuring or relaxation training. Few studies have investigated whether particular treatment packages are best suited to particular patterns of symptoms. Combined exposure and relaxation, compared to exposure alone, may be most effective for phobic patients who have intense chronic anxiety. Similarly, combined cognitive restructuring and exposure, compared to exposure alone, might be most effective for phobics who have a great deal of negative thoughts (e.g., many pessimistic or self-disparaging thoughts, or numerous catastrophic thoughts about the occurrence of threatening events). There is some evidence to support these conjectures, although further research is required.

In clinical practice it is common for patients to be receiving a combination of drug treatment and psychological therapy. This raises the question of whether combined exposure and antianxiety medication is more effective than exposure alone. The research on this topic has focused mainly on combining real-life exposure (flooding or graded *in vivo* exposure) with benzodiazepines such as Valium (diazepam) or Xanax (alprazolam). These are among the most widely prescribed antianxiety drugs. Research shows that adding benzodiazepines to exposure therapy either has no effect on treatment outcome, or may actually impair the efficacy of exposure.

It has been suggested that drugs interfere with exposure because of state-dependent learning. That is, the learning that takes place during treatment (e.g., learning

that agoraphobic situations are not dangerous) may be available in the patient's working memory only when the retrieval conditions match the conditions under which the learning originally took place. Learning acquired under the effects of an antianxiety drug may not be retrieved when patients are in a drug-free state. Research has provided mixed results for the state dependency hypothesis. Although state dependency might explain the exposure-impairing effects of antianxiety drugs in animal research, the same effects might not be as important in humans.

Recent research shows that a good predictor of relapse from combined exposure and drug treatment is the degree to which patients attribute their improvement to their antianxiety drugs rather than to their own efforts. Patients who attribute improvement to their drugs tend to be less confident about coping and have more severe withdrawal symptoms during the drug taper period. Withdrawal symptoms may further lead patients to attribute treatment gains to their drugs (instead of their own efforts) and also lead patients to expect to relapse once the medication is withdrawn. Attributing improvement to effective self-initiated action (i.e., self-directed exposure exercises), rather than to an external agent like a drug, may reduce the chances of relapse. This is because attributing improvement to self-initiated action encourages the person to persist with exposure exercises even while experiencing drug withdrawal effects. People who attribute their gains to the drug are less likely to enter feared situations when they notice the waning effects of the drug.

If patients are taking benzodiazepines when they commence exposure therapy, it is not uncommon for the exposure therapist, in consultation with the prescribing physician, to gradually taper the patient off their drugs, so that they may eventually complete an exposure program without relying on drugs.

B. Long-Term Follow-Up

Conditioning research suggests that fear memories (i.e., representations of the link between the CS and an aversive UCS) are relatively permanent, and that exposure may exert its beneficial effects by inhibiting links between a CS and an aversive UCS, possibly by creating competing links between the CS and a pleasant UCS. The animal research on the reinstatement of fears suggests that exposure therapies should be short-lived in their effects, with relapse common. Outcome studies on people with phobias have examined the durability of the benefits of exposure therapy, with follow-up assessments typically conducted 6 to 12 months post treat-

ment. Although relapse sometimes occurs, the majority of patients maintain their treatment gains. How are we to reconcile this with the putative "indelibility" of fear memories? It may be that such memories are indelible and that patients often do experience minor resurgence of fear, of insufficient severity to represent a relapse of the phobia. During exposure therapy patients are taught skills for overcoming their fears, such as the skill of constructing a fear hierarchy and systematically exposing themselves to fear-evoking stimuli. These skills may help patients deal with minor resurgences of fear, thereby reducing the fear before it can escalate into a full-blown phobia. Thus, even if fear memories are indelible, that does not mean that patients will inevitably relapse. Patients who do relapse can be successfully treated with a further course of exposure therapy.

C. Symptom Substitution

Psychodynamic theories posit that phobias are expressions of unconscious conflicts. In Sigmund Freud's famous case of Little Hans, for example, the child's horse phobia was conceptualized as arising from an Oedipal conflict (i.e., unacceptable impulses consisting of libidinous longing for the mother and aggression toward the father). Such theories imply that exposure therapies simply treat the symptom (i.e., the phobia), without treating the underlying conflict, and that if one symptom is eliminated, then another will emerge in its place as a further expression of the unresolved conflict.

Research on exposure therapies for phobias has revealed no convincing evidence of symptom substitution. Once fears or phobias are eliminated by exposure therapy, the treatment-related gains tend to be maintained. Although new symptoms may sometimes later emerge (e.g., depressive symptoms), a more common pattern is that there is a generalization of treatment effects; once a patient's phobia has been reduced by exposure, the patient's mood may improve and he or she may become happier in general. This effect is most often seen when debilitating phobias have been eliminated, thereby enabling the person to enjoy a higher quality of life. Interestingly, in the treatment of phobias, even Freud recommended *in vivo* exposure as an important component of therapy.

V. CASE ILLUSTRATION

Michelle K. was a 32-year-old single woman working as an administrative assistant in a large corporation. She had a long-standing history of generalized social phobia

and intermittent alcohol abuse. Michelle had been shy for as long as she could recall. During her adolescent years she was overweight and suffered from bad acne, which bought her ridicule and rejection from schoolmates. As a result of a series of particularly disturbing episodes of teasing during grades 10 through 12, she became increasingly anxious in social settings, including talking in groups and having one-to-one conversations, particularly with members of the opposite sex. Michelle also developed intense fear of eating in public after an episode in which she vomited during lunchtime in the school cafeteria. This appeared to have been the result of influenza combined with the effects of high anxiety.

Michelle suffered for many years until she saw a television program describing cognitive-behavior therapy for social phobia. When she presented for treatment, at age 32, her major problems were eating in public, giving oral presentations at work, and initiating and maintaining conversations with men. Whenever she had to eat in public, her hands trembled and she worried that others would think she was “weird.” While giving oral presentations, she would tremble, blush, and sweat profusely, and sometimes would have a panic attack. As a result of these problems, she recently turned down a promotion because it would have required her to give speeches and to attend business dinners. Although Michelle very much wanted to be in an intimate relationship, she rarely dated because of fear of being rejected. She believed it would be “terrible” to be rejected. Michelle attempted to cope with her anxiety by consuming “a few drinks” before social engagements. On occasion this resulted in her become extremely intoxicated and behaving inappropriately. These embarrassing episodes exacerbated her social fear and avoidance.

Michelle’s history suggested that aversive conditioning experiences (e.g., vomiting at school) gave rise to some of her social fears (e.g., fear of eating in public). Operant conditioning also appeared to play a role (i.e., reinforcement of avoidance and escape behaviors, and reinforcement of using alcohol to dampen her social anxiety). Conditioning alone seemed insufficient by itself to account for all of her problems. The fact that her shyness was long-standing suggested that some form of *diathesis* (vulnerability factor) predisposed her to acquire social fears. This might have been due to some combination of genetics and childhood learning experiences. With regard to the latter, Michelle recalled that her father had long emphasized the importance of being popular with others. Maladaptive beliefs, arising from these diatheses or from other sources, also seemed to play a role (e.g., the belief that it would be “terrible” to be rejected). Social skills deficits (e.g., deficits in conversation

skills) appeared to exacerbate her social anxiety. Thus, as is often the case in anxiety disorders, Michelle’s problems appeared to be multifactorial in origin. Accordingly, treatment was multifaceted, with different interventions addressing different aspects of her problems.

Michelle received 16 sessions of cognitive-behavior therapy, involving cognitive restructuring of maladaptive beliefs, social skills training, and graded *in vivo* exposure. She was also counseled to abstain from alcohol before and during social engagements. This was for several reasons. First, it was important that she avoided exacerbating her social fears by drunken behavior. Second, without the mind-clouding effects of alcohol, Michelle was better able to concentrate on practicing her social skills. Third, alcohol may have inhibited the effects of *in vivo* exposure in the same way that benzodiazepines interfere with exposure.

Given that this chapter is concerned primarily with classical conditioning and associated treatments, the remainder of this case illustration will focus primarily on the exposure exercises used in Michelle’s treatment. To reduce her fear of public speaking, Michelle completed a series of graded *in vivo* exercises, conducted during therapy sessions and as homework assignments. She began by delivering increasingly longer speeches to her therapist during the sessions. Her SUDS were initially 75/100. After two sessions of repeated practice her SUDS declined to 10/100. For homework she practiced giving these speeches to her dog, who turned out to be a generally attentive listener (although he tended to doze off during the boring parts). Then she practiced giving speeches to her sister and elderly neighbor. As her confidence grew, Michelle asked her supervisor for permission to present aspects of the weekly reports at staff meetings. Before and during each of her oral presentations, Michelle’s therapist encouraged her to “feel the fear” without distracting herself or using alcohol, and to treat each presentation as an opportunity for honing her presentation skills.

Michelle’s fear of eating in public was similarly treated with graded *in vivo* exposure. Initially, exposure exercises took place during treatment sessions held at lunchtime, during which Michelle and her therapist would eat at the hospital cafeteria. During the first exposure session, Michelle ate “nonmessy” foods (e.g., sandwiches), which evoked low levels of anxiety. She later progressed to eating “messy” foods, such as soups, salads, and spaghetti. Michelle was encouraged to allow herself to feel anxious and to allow her hands to tremble. During these exposure exercises her fear gradually declined and the trembling also abated. Michelle’s in-session exposure exercises were complemented by a series of homework assignments. The latter began with relatively easy tasks (e.g., eating by

herself in the food court of a large shopping mall). As she became comfortable with these tasks she moved on to more fear-evoking exercises, such as eating with co-workers in the office lunchroom.

Her fear of dating was treated with a combination of graded *in vivo* exposure and social skills training. Michelle was encouraged to attend social functions whenever the opportunity arose, and to make increasing efforts at being actively involved in conversations. Michelle began to take up offers from her friends to join them on social outings, and thereby had numerous opportunities to enter into conversations with people she met, both women and men.

By the end of treatment Michelle's social phobia had abated considerably. She was able to comfortably give oral presentations at work and to attend work-related dinners. She also had accepted a promotion. The added opportunities for *in vivo* exposure entailed in her new job led to further reductions in social anxiety, and to increases in self-confidence. Treatment concluded with a review of the gains made during therapy, a discussion of the goals that remained to be attained, and a discussion of how she would go about using the skills learned in therapy to attain these goals. For example, Michelle was still anxious about dating, and was also frightened of making extemporaneous speeches. For each fear, she was encouraged to construct a hierarchy of feared situations, and systematically exposed herself to them. Michelle was also counseled on the situations that might lead her social phobia to worsen (e.g., an episode of being criticized by a supervisor) and how to use exposure and cognitive restructuring for dealing with any exacerbation. Michelle was advised to recontact the clinic if she experienced any further problems.

VI. SUMMARY

Classical conditioning theories have become considerably more complex since the early formulations by O. H. Mowrer and others. Modern conditioning models emphasize the role of cognitive factors such as memory processes and expectancies in the etiology and maintenance of conditioned responses. As theories of fear have developed, other pathways to fear acquisition have been added, although classical conditioning continues to be seen as important. Classical conditioning theories have led to a number of important treatments, with the most widely used being the exposure therapies for reducing fear. According to contemporary views, extinction of the CR can be regarded as a process of exposure to corrective information. Exposure involves having the person repeatedly expose himself or her-

self to a feared stimulus until fear abates. Patients play an active role in choosing what they will be exposed to, and when the exposure will occur. Exposure therapies can successfully reduce conditioned fears and fears arising from other forms of learning.

Of the exposure therapies, graded *in vivo* exposure and flooding are among the most effective treatments of phobias, and play an important role in treating disorders in which fear plays a prominent role (e.g., social phobia, agoraphobia). For patients who are extremely phobic, the least demanding form of exposure (systematic desensitization) is typically the exposure intervention to be used first. Graded *in vivo* exposure is particularly important because it involves teaching patients skills for overcoming their fears. Patients can continue to apply these skills on their own, without the aid of a therapist. Exposure therapies can be combined with other psychological interventions, such as relaxation training and cognitive restructuring. For the average phobic patient, combination treatments tend to be no more effective than exposure alone. However, there are likely to be exceptions to this rule, and some patients may benefit most from a combination of psychotherapeutic procedures. Combining exposure with anti-anxiety drugs does not improve outcome, and may actually impair the effects of exposure. The benefits of exposure therapy tend to be long lasting, with no evidence of symptom substitution. Patients sometimes relapse, although their reemerged fears can usually be successfully treated with a further course of exposure therapy.

See Also the Following Articles

Anxiety Management Training ■ Avoidance Training ■ Behavior Therapy: Historical Perspective and Overview ■ Behavior Therapy: Theoretical Bases ■ Conditioned Reinforcement ■ Exposure ■ Extinction ■ Flooding ■ Habit Reversal ■ Implosive Therapy ■ Operant Conditioning ■ Panic Disorder and Agoraphobia

Further Reading

- Craske, M. G., Barlow, D. H., & Antony, M. M. (1998). *Mastery of your specific phobia: Client workbook*. San Antonio, TX: Psychological Corporation.
- Davey, G. C. L. (1992). Classical conditioning and the acquisition of human fears and phobias: A review and synthesis of the literature. *Advances in Behaviour Research and Therapy*, 14, 29.
- Foa, E. B., & Kozak, M. J. (1986). Emotional processing of fear: Exposure to corrective information. *Psychological Bulletin*, 99, 20.
- Marks, I. M. (1987). *Fears, phobias, and rituals*. New York: Oxford University Press.

- Masters, J. C., Burish, T. G., Hollon, S. D., & Rimm, D. C. (1987). *Behavior therapy: Techniques and empirical findings* (3rd ed.). New York: Harcourt Brace Jovanovich.
- McNally, R. J. (1987). Preparedness and phobias: A review. *Psychological Bulletin*, *101*, 283.
- O'Donohue, W. (Ed.) (1998). *Learning and Behavior Therapy*. Boston: Allyn and Bacon.
- Rachman, S. J. (1990). *Fear and courage* (2nd ed.). New York: Freeman.
- Rescorla, R. A. (1988). Pavlovian conditioning: It's not what you think it is. *American Psychologist*, *43*, 151.
- Taylor, S. (1999). *Anxiety sensitivity: Theory, research, and treatment of the fear of anxiety*. Mahwah, NJ: Erlbaum.
- Taylor, S. (2000). *Understanding and treating panic disorder: Cognitive-behavioural approaches*. New York: Wiley.
- Williams, S. L. (1990). Guided mastery treatment of agoraphobia: Beyond stimulus exposure. *Progress in Behavior Modification*, *26*, 89.

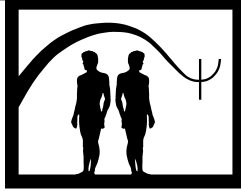

Cognitive Appraisal Therapy

Richard L. Wessler

Cognitive Psychotherapy Services, New York

- I. Description of Treatment
 - II. Theoretical Bases
 - III. Empirical Studies
 - IV. Summary
- Further Reading

I. DESCRIPTION OF TREATMENT

Cognitive appraisal therapy (CAT) began as a form of cognitive-behavior therapy (CBT) and evolved into an integrated psychotherapy for personality-related disorders. CAT departs from conventional cognitive-behavior therapy in its view of affect and motivation:

- Affect is a result of prior cognitive processing in CBT; in CAT cognition can also be the result of emotional processing.
- Behavior is affect-driven in CAT, not cognition-driven. Nonconsciously motivated attempts to reexperience familiar feelings (personotypic affects) account for symptomatic behaviors and self-handicapping actions.

Whereas reduction of symptoms of anxiety and depression and improvements in social and familial functioning are the ultimate goals of treatment, they are not the primary focus in CAT. Instead, the emphasis falls on the discovery of a person's patterns of personality (affect, behavior, and cognition).

These patterns emerge in therapeutic dialogues, especially during initial contacts. The Millon Clinical Multiaxial Inventory is used to confirm preliminary diagnostic impressions of personality functioning, but another test (e.g., the MMPI) could also be used for this purpose.

To achieve self-understanding, the therapist assists in describing affective, cognitive, and behavioral patterns,

GLOSSARY

emotional setpoint A nonconscious prescription about how and what a person should feel. When affect deviates from the setpoint processes are automatically activated to restore the setpoint. Negative deviations prompt defensive maneuvers; positive deviations prompt security-seeking behaviors and justifying cognitions.

justifying cognition Perception and thought that elicit and rationalize personotypic affect, and restore the emotional setpoint.

personal rule of living Conscious and nonconscious cognitions that form a personal rule book for guiding decisions, behavior, and the processing of social information. They may function as mediators of emotional experiences or as nonconscious algorithms for value-based responses.

personotypic affect Certain emotional experiences that are frequently experienced by the individual, depending on his or her socialization environment; the person's emotional "default" setting.

security-seeking behavior Behavior, especially interpersonal, that elicits personotypic affect and restores the emotional setpoint.

their interrelations, and their functions in a person's life. Together client and therapist develop plans to work against these patterns using the client's new awareness.

CAT is not a set of specific procedures, but rather a portrayal of emotional and behavioral processes the client can readily comprehend and work to change. Because self-awareness and understanding can be achieved in various ways, the techniques employed vary with each individual. Special attention is given to three areas:

1. *Affect*: Methods of comforting oneself and soothing one's feelings are encouraged. These new methods usually replace ones that have been more maladaptive than adaptive (e.g., alcohol, drugs, avoidance).
2. *Behavior*: Clients are encouraged to do what they deem to be right at any given moment in time, and thereby give expression to their moral code and the raising of positive self-appraisals. They also identify self-handicapping actions (security-seeking behaviors).
3. *Cognition*: Clients work to identify and change cognitive distortions, especially those concerned with poor self-image and pessimism about the future, and justifying cognitions that support familiar affect. These in turn promote effective future actions.

Sessions are conducted in plain language. All forms of jargon (including our own), psychobabble, and counseling clichés are actively discouraged. Theoretical assumptions are divulged only when they might prove helpful (e.g., in understanding failure to maintain changes). Formal homework is not assigned. Bibliotherapy, thought records, daily logs, and the like, common in CBT, are seldom used. The emphasis is on establishing new patterns of interaction and self-care, not intensive self-examination of cognitive content or of one's past.

By speaking in an open, self-disclosing manner, therapists attempt to create a strong working alliance and a shame-free environment. Therapists disallow self-criticism and call attention to the minutest self-critical remark. It is expected that anger be expressed respectfully, and when necessary therapists model ways to express anger and other emotions. The endless expression of affect is discouraged because catharsis is counterproductive.

In an effort to reduce self-pity, therapists do not sympathize with clients but affirm the respectful and optimistic position that everyone has the capacity to cope with personal tragedies, and that humans are far more resilient than they may realize. Complaining is discouraged and clients are required to behave actively rather than passively and not to continue as helpless victims stuck in an unresolvable paradox.

All clients address two questions: "What do you want?" and "What are you willing to do to get what you want?" These questions identify therapeutic goals and get the client's commitment to them and to the assuming of responsibility while relinquishing the self-imposed status of victim or incompetent.

Self-appraisals, central to most forms of psychological therapy, receive special attention in CAT. Most clients set arbitrary standards of worth or goodness that they must attain, and view themselves negatively when they fail. These standards often involve achieving success or social popularity or other outcomes not fully under the control of the individual. Because human worth is a moral or ethical question, clients are urged to adopt a different standard: Positive self-appraisals should only be made when one acts ethically and morally. Actions are controlled by the person (a humanistic aspect of CAT) and therefore clients can control self-appraisals by doing what they think is right.

When clients do not act in accord with their personal values, it is suggested that most of us are tempted to do what feels good rather than what is right. A self-respecting life comes not from pursuing hedonistic pleasures, but from acting responsibly, morally, and ethically; only then can self-respect be achieved.

The CAT therapist understands setbacks, so-called resistance, and stalled therapeutic progress by using the concept of emotional setpoint and the person's nonconscious motives to reexperience personotypic affects.

There are no formal termination procedures in CAT, because therapy is viewed as a continuing resource to clients. (Administrative policies in some settings may prohibit this.) Rather, clients are asked to decide when to schedule their "next session," which, of course, may never occur.

II. THEORETICAL BASES

The phrase cognitive appraisal therapy was adopted to distinguish it from other forms of cognitive behavior therapy, especially rational-emotive therapy. The phrase also emphasizes the fact that evaluative cognitions (a synonym for appraisal) are centrally involved in emotional processes and are a target for therapeutic intervention.

People seem unaware of their most significant appraisals, which function as nonconscious algorithms—stored routines for the processing of social information. These algorithms, in the form of therapeutic hypotheses about covert mental functioning, can be inferred from what people say and do. Cognitive evaluations,

along with patterns of behaving and emoting, are used in CAT to describe personality.

Personality vulnerabilities are the central focus of CAT. Clinical conditions result from psychosocial stressors interacting with personality variables within a social context. These clinical conditions are personality-related disorders. CAT thus has a holistic orientation rather than a syndromal focus.

Emotion and behavior are viewed as the end result of cognitive processing in most forms of cognitive-behavior therapy. Beliefs or cognitions are said to mediate between stimulus and response, producing the “frightened animal” model of emotion: An animal reacts with flight and fear to a stimulus it interprets as dangerous.

In humans, the interpretive process uses cognitive inferences and appraisals to create an emotional response, and these cognitive processes are targets of therapeutic interventions. In CAT, inferences and appraisals are labeled personal rules of living—personal versions of correlational and cause-and-effect relationships, and of moral principles and social values. For example, if one has an inferential rule that all dogs will bite and an evaluative rule that pain is bad and should be avoided, the person will avoid dogs in order to avoid pain—exactly what phobic persons do.

This mediation model of episodic emotion accounts for a person’s reaction in specific situations, and can be helpful in relieving emotional distress in crises. However, most patients are not in psychotherapy for crisis intervention. The disordered emotions for which they seek treatment are habitual rather than reactive, chronic rather than episodic. They are emotional habits rather than emotional responses.

In order to sustain emotional habits thinking and acting must be brought into harmony with feelings. Each person, it is assumed in CAT, has one or more emotions that have been practiced so often they become, in computer terminology, his or her “default setting.”

CAT hypothesizes that people need to reexperience familiar feelings in order to have a sense of psychological security that originated in preadult patterns of attachment. People feel most comfortable and secure in familiar surroundings, with familiar people, and with their own possessions (familiar objects). Too much familiarity can be boring, but too much novelty can be threatening. CAT postulates an emotional setpoint—a familiar prescription about how a person should feel.

When a person’s subjective feelings fail to match his or her setpoint automatic processes are activated. Deviations below the setpoint are corrected by mood-lifting thoughts and actions (psychological defenses) that raise the emotional state. When one feels too good, au-

tomatic processes (security-seeking maneuvers) lower the individual’s affect to his or her accustomed, and therefore secure, state.

Two important but easily overlooked feelings that receive close attention in CAT are shame and self-pity. Shame is a feeling of personal deficiency, a form of self-criticism so extensive that one feels like an outcast from one’s community of friends and family. Self-pity is the feeling that one is weak and disadvantaged through no fault of one’s own. Prompting pity in others may result in motivating them to assist, but self-pity does not lead to self-help initiatives because the feelings confirm that the person is powerless. When shame and self-pity are personotypic affects, they move people to engage in behaviors that elicit criticism (shame) or tempt others to take advantage of them (self-pity). Although consciously abhorring these feelings, when people repeatedly act as if they seek them it provides evidence that the feelings are personotypic and their actions fit a pattern of security-seeking.

Both shame and self-pity are implicated in rage. The target of rage is often people who shamed or victimized the enraged person or who refuse to help. Because of the self-image of weakness, the person seldom expresses rage directly due to fear of retaliation.

Self-respect is necessary to combat shame and self-pity. It is difficult to feel ashamed when doing what is right, nor is it easy to feel sorry for oneself. Self-respect based on moral actions gives power to the person, and a powerful person cannot readily feel shame or self-pity, because the person feels adequate and worthwhile, not inferior and vulnerable.

III. EMPIRICAL STUDIES

CAT originated as individual psychotherapy, and its concepts have been applied to children, adolescents, adult groups, and couples. Because it is a theoretical perspective on personality and motivation, CAT can be adapted to other forms of psychotherapy. When therapy stalls, CAT concepts offer a fresh perspective on resistance to change; familiarity is a powerful force in people’s lives. Developed in a private practice setting, CAT has not yet stimulated empirical studies.

IV. SUMMARY

CAT treats the personality vulnerabilities that underlie anxiety and mood disorders. It assumes that people seek to restore their emotional setpoint by distorting

perception and cognition and by pulling responses from others that prompt personotypic affects. Failure to change or maintain change is due to the power of the emotional setpoint. Therapeutic procedures focus on the understanding of these patterns of personality and using such awareness to work against them. Special attention is given to achieving self-respect, based on personal responsibility for doing what is right, to combat shame, self-pity, and rage.

See Also the Following Articles

Anxiety Disorders: Brief Intensive Group Cognitive Behavioral Therapy ■ Cognitive Behavior Group Therapy ■ Cognitive Behavior Therapy ■ Rational Emotive Behavior Therapy

Further Reading

- Hankin, S. W. R. (1997). El proceso terapeutico en la terapia de valoracion cognitiva. In I. Caro (Ed.), *Manual de terapias cognitivas*. Barcelona: Paidos.
- Stern, J. (2000). Parent training. In J. R. White & A. S. Freeman (Eds.), *Cognitive-behavioral group therapy for specific problems and populations*. Washington, DC: American Psychological Association.
- Wessler, R. L. (1993). Cognitive appraisal therapy and disorders of personality. In K.T. Kuehlwein & H. Rosen (Eds.), *Cognitive therapies in action: Evolving innovative practice*. San Francisco: Jossey-Bass.
- Wessler, R. L. (1993). Groups. In G. Stricker & J. Gold (Eds.), *Comprehensive handbook of psychotherapy integration*. New York: Plenum.
- Wessler, R. L., & Hankin-Wessler, S. W. R. (1991). La terapia de valoracion cognitiva. In Caballo V. E. (Ed.), *Manual de tecnicas de terapia y modificacion de conducta*. Madrid: Siglo Vientiuno Editores.
- Wessler, R. L. (1990). Cognitive appraisal therapy. In J. K. Zeig & W. M. Munion (Eds.), *What is psychotherapy?: Contemporary perspectives*. San Francisco: Jossey-Bass.
- Wessler, R. L., & Hankin-Wessler, S. W. R. (1990). Emotion and rules of living. In R. Plutchik & H. Kellerman (Eds.), *Emotion: Theory, research and experience*. New York: Academic Press.
- Wessler, R. L., Hankin, S., & Stern, J. (2001). *Succeeding with difficult clients: Applications of cognitive appraisal therapy*. New York: Academic Press.



Cognitive Behavior Group Therapy

Sheldon D. Rose

University of Wisconsin-Madison

- I. Outcome Research on CBGT
 - II. The Relevance of the Group in CBGT
 - III. The Structure of the CBGT Group
 - IV. Phases of CBGT
 - V. Intervention Strategies
 - VI. Some Closing Remarks
- Further Reading

GLOSSARY

cognitive behavior group therapy (CBGT) Therapy that occurs within the context of a group and that incorporates a variety of cognitive strategies, modeling techniques, and other behavioral techniques.

generalization phase In this phase clients are prepared to transfer what they have learned in group to the natural environment. Extra-therapeutic assignments are designed to be carried out in the community.

intervention phase Situational analyses and goal setting are the primary foundations. Technical applications include correcting cognitive distortion, providing corrective information, exposure, modeling, and behavior rehearsal, with input from other group members.

Cognitive-behavior group therapy (CBGT) refers to a variety of different group approaches. What they have in common is that therapy occurs within the context of a group, and that intervention exploits various cognitive strategies, modeling techniques, and other behav-

ioral strategies as well. The goals of intervention are behavioral, cognitive, and/or emotional change. Specifically they aim at the reduction of stress and anxiety responses, depression, eliminating panic responses, reducing bulimic behavior losing weight, the resolution of phobic disorders, ameliorating agoraphobia, effective management of chronic pain, improving general social functioning, abstinence from risky sexual activity, and increasing self-control in the area of drug and alcohol abuse. (A comparable program has been described by Rose in 1998 for use with disturbed children and adolescents.) In the model proposed in this article the clients make use of the conditions of the group to enhance the clients' learning and motivation. Most CBGT models teach specific skills for coping with and resolving unique problem situations. Skills are usually developed for coping effectively with situations that trigger stress, anxiety, pain and/or anger through the use of various cognitive and behavioral procedures. In some cases where the goals are approaching anxiety-producing situations or phobic objects, the clients are gradually exposed to the phobic targets, often as a group. In almost all CBGT groups extragroup tasks (homework) are negotiated with the clients as a means of transferring learning to the real world. These tasks are monitored at a subsequent session. The therapist in CBGT, although presenting a highly structured program, in most cases involves the clients in many goal, task, and intervention decisions. Before we discuss CBGT in more detail, let us examine some of the research related to this approach.

I. OUTCOME RESEARCH ON CBGT

The research tends to provide support of the effectiveness of CBGT in the treatment of social phobias. For example, Heimberg in 1990 conducted a study comparing CBGT with a credible placebo control in the treatment for social phobias of 49 participants. Groups met weekly for twelve 2-hour sessions. The CBGT condition ($n = 25$) consisted of exposure to simulated phobic events, cognitive restructuring of maladaptive thoughts, and homework for self-directed exposure and cognitive restructuring between sessions. The educational supportive psychotherapy comparison group (ES) ($n = 24$), which acted as a control, consisted of lecture–discussion and group support. While both groups demonstrated significant pretreatment-to-posttreatment change, CBGT patients' phobias were rated as significantly less severe than those of ES patients at posttest assessment. Six-month follow-up data revealed a similar pattern.

In another study Mattick and Peters in 1988 conducted a study to assess the effectiveness of guided exposure in groups with and without cognitive restructuring in 51 subjects (24 male) with severe social phobia. The guided exposure model of CBGT emphasized the role of avoidance behavior in the etiology and maintenance of phobias and involved exposure to moderately difficult situations, the subjects being directed into increasingly difficult situations, and self-directed exposure homework assignments. The combined model of guided exposure and cognitive restructuring emphasized both avoidance behavior and the role of irrational thoughts in initiating and maintaining behavior and included systematic rational restructuring with elements of rational-emotive therapy as well as identifying, challenging, and altering maladaptive beliefs and attitudes. The combined methods group showed a significantly greater improvement than the exposure group from before to after treatment. Results from the self-report measures of target phobia avoidance rating indicated that the treatment resulted in greater approach to the phobic object.

Support for CBGT in the treatment of agoraphobia with panic disorder in intensive short-term CBGT (two all-day workshop) was provided by Evans, Holt, and Oei in 1991. They assigned 97 participants with the diagnosis of agoraphobia with panic attacks to either the treatment ($n = 74$) or the control wait-list group ($n = 23$). All subjects in the treatment condition attended the brief intensive CBGT, which consisted of lectures regarding agoraphobia, relaxation training, cognitive rehearsal of panic control messages, *in vivo* exposure, and group discussion. Waiting list participants were all consecutive re-

ferred to the clinic following the treatment phase. Results revealed that patients who received the treatment program had improved significantly at posttreatment and at follow-up and that significantly more patients were symptom-free or symptom-reduced following the CBGT treatment than the control group.

Lidren and colleagues in 1994 reported the results of a study that compared the effectiveness of CBGT in treating panic disorder (PD). Thirty-six men and women who met criteria of the DSM-III-R for PD were randomly assigned to one of three conditions: bibliotherapy (BT), group therapy (CBGT), or a waiting-list control (WL) group. Both groups were compared to a no-treatment control condition, and all three conditions contained 12 subjects. Results in terms of decreased panic attacks and lessening of severity of behavioral avoidance suggested the greater effectiveness of both treatment conditions over the wait list.

A number of studies support the effectiveness of CBGT in the treatment of eating disorders. For example, Telch, Agras, Rossiter, Willfley, and Kenardy in 1990 assessed the effectiveness of CBGT in treating binge eating disorders. Forty-four female patients who binged were randomly assigned to either CBGT ($n = 23$) for ten sessions or a waiting list control condition ($n = 21$). At posttreatment assessment, between-group comparisons revealed that subjects in the intervention group reported significantly reduced binge eating episodes compared with subjects in the waiting list control group. CBGT participants continued to binge significantly less frequently than at baseline. However, bingeing was usually not eliminated entirely.

Tanco, Linden, and Earle in 1997 conducted a study evaluating the effectiveness of a cognitive group treatment program on morbidly obese women. Sixty-two obese women were randomly assigned to either the cognitive program (CBGT), a behavior therapy weight loss program (BT), or a wait-list control condition (WL). Both treatment groups consisted of eight to 2-hour weekly sessions with the wait-list control condition lasting 8 weeks. However, results revealed that scores for the CBGT group improved significantly across time, while those for the BT group and the control group did not. The CBGT group and the BT group, but not the control group subjects, lost significant amounts of weight during the course of treatment. Analysis of body mass index (BMI) revealed a decrease with time in both the CBGT group and the BT group. Finally, the proportion of subjects in the CBGT group exercising regularly increased significantly over the course of treatment. Six-month follow-up data suggested that all treatment benefits were maintained.

A number of studies lend modest support to the use of CBGT in treating patients with hypochondriacal complaints or somatization. Lidbeck in 1997 conducted a study of the effectiveness of a short cognitive-behavioral group treatment model for somatization disorder in general practice. The CBGT condition consisted of six treatment groups with three groups of six patients and three groups of five patients making a total of 33 subjects receiving cognitive-behavioral therapy. The treatment included patient education to explain the psychological and physiological stress symptoms in order to enable cognitive restructuring, relaxation training, and homework consisting of one relaxation training session. CBGT consisted of eight 3-hour sessions. The control group consisted of 17 people: five groups of 3 patients and one group of 2 patients. Although no significant differences were found in dealing with social problems in either condition, reduction of illness behaviors was significantly greater in the CBGT condition than in the control condition, both at posttreatment evaluation and at the 6-month follow-up, and there was also a group difference reported for hypochondriasis at the 6-month follow-up. No significant differences were reported for anxiety, depression, or sleep disturbance, either at posttreatment or at the 6-month follow-up. Medical usage was significantly different between the CBGT and control conditions at the posttreatment evaluation and at the 6-month follow-up.

Avia and colleagues in 1996 also examined the effectiveness of CBGT with hypochondriacal patients. Seventeen participants were assigned to either the CBGT groups or the wait-list control group. The CBGT condition consisted of six weekly 1.5-hour sessions of general education covering inadequate and selective attention, muscle tension/bad breathing habits, environmental factors, stress and dysphoric mood, explanations given to the somatic signals, practical exercises implementing educational material, and homework to practice skills related to topic areas. The two CBGT groups were identical except for the assigned therapist. The waiting list control condition did not receive any form of treatment for the duration of the experiment. Results suggested a significant difference between CBGT and the control condition in the reductions of physical symptoms, bodily preoccupation, symptom interference, an overall reduction of the IAS, and also in their overall change in dysfunctional health beliefs. One year follow-up data reported that subjects maintained their reductions in their worry about illness and continued reducing symptom interference.

CBGT has found some support in the treatment of drug and alcohol abuse. Fisher and Bentley in 1996 conducted a study looking at the effectiveness of two

group treatment models, CBGT, disease and recovery approach, and a usual treatment comparison group. The CBGT condition consisted of interventions to enhance self-efficacy, provide more realistic and appropriate expectations about the effects of the abused substance on symptoms of personality disorders, increase adaptive coping skills, and enhance relapse prevention capacity. The disease and recovery group approach consisted of interventions to develop an "alcoholic" or "addict" identity, acknowledge a loss of control over the substance abuse and the effects of the personality disorder, accept abstinence as a treatment goal, and included participation in support group activities such as AA. Both experimental groups met for three 45-minute weekly sessions for 4 weeks. The usual treatment comparison group did not receive experimental interventions and met three times weekly in an open-ended group format. The analysis revealed that within the outpatient setting, the CBGT was significantly more effective than the disease and recovery group and the control group in reducing alcohol use, enhancing psychological functioning, and in improving social and family relations.

Eriksen, Bjornstad, and Goetstam in 1986 evaluated the efficacy of a CBGT model that used primarily social skill training procedures with patients who abused alcohol. Social skills training as part of inpatient treatment for patients with DSM III diagnosis of alcohol dependence delivered in a group format resulted in better outcomes than a traditional discussion group. Over the 1-year period after discharge, patients who had received social skills training were abstinent 77% of days, whereas control patients were abstinent 32% of days. In 1997, Vogel, Eriksen, and Bjoernelv also found support for the greater efficacy of the treatment of alcoholics in social skill groups over those in a control condition 1 year after the end of therapy.

Roffman and colleagues in 1997 assessed the effectiveness of CBGT to prevent HIV transmission in gay and bisexual men. Approximately 159 men were matched and assigned to receive either the 17-session group counseling ($n = 77$) or remain in an 18-week wait-list control ($n = 82$) condition. The CBGT condition was based on a relapse prevention model. Early sessions emphasized building group cohesion (one of the few studies that explicitly did so), HIV education, motivational enhancement, and goal setting. Middle sessions focused on determining antecedents to risky behavior and developing appropriate coping strategies that included coping skills training in high-risk situations that involved communication, cognitive activities, and behavioral strategies. Maintenance strategies for the preservation of safer behaviors were also included. This

study utilized one specific dependent measure: abstinence from AIDS-risk sexual activity over the 3-month period prior to reassessment. Data reveal men exposed to the treatment group had roughly 2.3 times the odds of success experienced by men assigned to the no-treatment control condition. Also, results indicate that the intervention appeared to be more effective with exclusively gay than with bisexual men.

Lutgendorf and co-workers in 1997 conducted a study of gay men diagnosed with HIV seropositive status to measure the psychological and immunological effects of a cognitive-behavioral stress management group (which could also be classified as CBGT) ($n = 22$) versus a wait-list control ($n = 18$). The CBGT group met for weekly 135-minute sessions that consisted of didactic components explaining physiological effects of stress, stress-immune associations, cognitive-behavioral theory of stress and emotions, identification of cognitive distortions and automatic thoughts, rational thought replacement, coping skills training, assertiveness training, anger management, identification of social supports, group discussion of personal examples, and homework.

Results of measures assessing relaxation practice and mood changes revealed a correlation between regularity of relaxation practice and changes in depression and anxiety, and in assessing immunologic effects. No changes, however, were found between groups at posttest or within groups over time in most of the immunological measures.

Adjustment of newly diagnosed cancer patients was found in a study by Bottomley, Hunton, Roberts, Jones, and Bradley in 1996. The groups compared were a CBGT condition ($n = 9$), a social support group ($n = 8$), and a wait list control condition ($n = 14$). Both treatment groups met for 8 weeks with sessions lasting 90 minutes. The cognitive-behavioral intervention focused on challenging dysfunctional thinking and learning coping skills while the social support group encouraged open and honest expression of ideas and employed topic-based discussions as primary treatment modalities. No significant differences were found between treatment groups at postintervention. However, differences in groups' scores on the Fighting Spirit subscale approached significance, suggesting that patients in the CBGT group received the most significant benefit in developing coping styles such as fighting spirit. However, at 3-month follow-up data indicate that the CBGT group significantly improved in their fighting spirit as compared to the other two groups. Also, a trend toward deterioration in the scores of the nonintervention condition was statistically significant in terms of increased helplessness and depression.

In the use of CBGT in the treatment of men who batter (see review by Tolman and Edleson in 1995), the results are mixed, although the authors note that consistent findings in varying programs, using various methods, seem to result in a large number of men stopping their violent behavior. In most studies they report that CBGT was more effective than a control group but not significantly more effective than alternative treatments.

In summary, the research cited earlier lends some evidence for the effectiveness of CBGT with a wide variety of presenting problems, although more research is needed. Often the group phenomena was confounded with the cognitive-behavioral procedures. The control groups were often not randomly assigned although the authors provided evidence for similarity of experimental and control conditions. In addition, it should be noted that in many of these and other studies, the number of subjects was low, and hence the power to reject the null hypothesis extremely small. It is in fact surprising that so many studies found a significant difference between control group and treatment conditions in spite of the small number. In all cases there was at least a no-treatment control group but often in the absence of a best possible alternative permitted only the conclusion that CBGT was better than nothing. In the several studies in which contrast groups existed, differences occasionally existed. No power analysis was reported prior to the intervention of most of the studies. The individual was in all cases the unit of analysis in spite of the fact that the treatment was in groups, thus incurring both statistical as well as psychological dependency.

One of the reasons for the modest methodological quality of research on small therapy groups is the complexity of such designs for groups and difficulty in recruiting sufficient subjects to meet quality design requirements. Second, because of the need to standardize treatment packages, individualization in experiments had to be ignored in contrast with actual practice. Third, most of the studies were field experiments that required special protections for the subjects that often worked against a strong design.

II. THE RELEVANCE OF THE GROUP IN CBGT

It is possible to do therapy in groups without making very much use of the group. Although most of the studies cited earlier do not include group interventions and group problems in their description, at the very least, all of them employed some form of group discussion

and member interaction. Unfortunately, the content and purpose of this discussion was not always made clear. This section describes the potential advantages as well as the difficulties, created by working with clients in a CBGT or any other group approach. Ways for dealing with some of the difficulties inherent in groups are also suggested. Many of the assumptions stated have been drawn from clinical practice. (For more details for adult groups see Rose's 1989 work and for groups of children and adolescents see Rose's 1998 research.)

A. Advantages of the Group

First, group membership commonly ends the sense of isolation many clients feel. It is difficult to maintain the feeling that you are the only person experiencing a particular problem when you are surrounded by other individuals who are dealing with similar issues. One of the potentially therapeutic factors in group treatment is the interaction with others who share common concerns (Yalom in 1985 referred to this as "universality"). Listening to others who describe and solve problems brings hope to the client that his or her problems are also manageable, which Yalom in 1985 also stated is a curative factor. These group phenomena are supported by the therapists who continuously permit members to help each other and create other conditions that increase the cohesion and work focus of the group. Helping others, a form of altruism and group cohesion, has also been described as curative factors by Yalom in 1985.

The group provides the client with a source of feedback about those behaviors that are irritating or acceptable to others and about those cognitions that can be viewed as distorted, self-defeating, and/or stress eliciting. As a result the group contributes to improved self-assessment for the individual client.

Another reason for using groups is the frequent and varied opportunity for mutual reinforcement. We have noted that clients find reinforcement from other group members more powerful than reinforcement from a single therapist. Reinforcement is a highly valued commodity in interpersonal relationships. As clients increase the frequency of reinforcing others, they note that they are reciprocally reinforced by others, and mutual liking increases. Each client is given the chance to learn or to improve his or her ability to mediate rewards for others in social interactive situations (with acquaintances, friends, family members, acquaintances in other groups, with other group members, etc.). The group therapist can create situations in which each client has frequent opportunity, instructions, and rewards for rein-

forcing others in the group. Special group exercises have been designed to train clients in mutual reinforcement, and extragroup tasks (homework assignments) are used to encourage clients, deficient in reinforcement skills, to practice them in the real world. The completion of these tasks is monitored by other group members.

In groups, a client must learn to deal with the idiosyncrasies of other individuals. Clients must wait while other people explain their problem. They must learn to tolerate what they perceive to be inadequate or even inane advice. Clients may be required to tolerate major differences with other group members and in some cases to deal with them. They must learn how to offer other clients critical feedback and advice in a tactful and helpful manner. By helping others, clients are likely to practice a set of strategies for helping themselves and learn a model of helping others that can be applied outside of the group. In this way they are likely to improve their relationships with others.

Therapy groups simulate the real world of natural friendship groups more accurately than does individual therapy if the therapist permits and even encourages such simulation. Individual therapy consists solely of a high-status therapist and a low-status client. Due to the greater similarity of the group to other social situations in the real world, the group setting facilitates transfer of newly learned behavior from the therapeutic setting to the community.

Groups create the opportunity for the group therapist to use an abundance of therapeutic procedures that are either unavailable or less efficient in individual treatment. Among these procedures are the "buddy system," numerous group exercises (see, e.g., Rose's work in 1998), multiple modeling, group feedback, group brainstorming, and mutual reinforcement. Groups also provide each client with a large number of models, role-players for overt and covert behavioral rehearsal, manpower for behavior monitoring, and partners for use in a "buddy system." By simulating the social world, the group provides a natural laboratory for learning, discussion, behavioral testing, and leadership skill development. All of these acquired skills are essential to form good social relationships in any setting.

In the process of interaction in therapy groups, norms (informal agreements among members as to preferred modes of action and interaction in the group) often arise, which serve to control the behavior of individual members. If these norms are introduced and effectively maintained by the group therapist, they serve as powerful therapeutic tools. The group, through group discussion of the implication of nonconformity to the norms, pressures deviant members to conform to such norms as

attending regularly, mutual reinforcement of assignment completion, self-disclosing, analyzing problems systematically, and assisting peers with their problems. Of course, if the group therapist is not careful, antitherapeutic norms also can be generated such as members coming regularly late, or having group members inappropriately or prematurely confronting one another.

In addition to modifying the norms of the group, the group therapist can facilitate the attainment of both individual and group therapy goals by such procedures as modifying the cohesiveness of the group, the status pattern, or the communication structure in the group. Group problems are also dealt with and resolved when they arise. Much of the power of group therapy to facilitate the achievement of therapy goals is lost if negative group attributes are permitted to fester.

B. Limitations of the Group as the Context of Therapy

Of course, groups are not without major disadvantages. Two mentioned earlier were that antitherapeutic norms occasionally develop and may be maintained if the therapist does not deal with such norms with the group members. Moreover, such phenomena as group contagion and mutual aggression can sometimes get out of hand in groups. In spite of such complications strategies for dealing with such group phenomena are available.

A relevant limitation to be concerned with is that it is more difficult to individualize each client in the group than in individual therapy. For efficiency, the group therapist is continually looking for common goals to pursue and may, therefore, overlook the unique needs of one individual. Within many complex group interactions, identifying the distinct needs of specific individuals requires a great deal of attention. Another threat to individualization is the fact that in order that everyone has a chance to participate actively in every session, restraints must be placed on people who talk more than their share. This is sometimes frustrating, but failure to limit excessive talking can result in the frustration of other members. The use of exercises with built-in restrictions depersonalizes the giving of structure and usually makes it more acceptable.

Confidentiality is more difficult to maintain in groups than in the therapeutic dyad. Confidentiality and the consequences of breaches need to be dealt with by the therapist in pregroup screening and early group sessions so that all group members conform to appropriate standards of conduct. Nevertheless, the participants are not professionally trained and abuses do occasionally occur and when revealed have to be dealt with in the group.

Finally, working with groups requires an extensive repertoire of skills and training to be minimally effective. Unfortunately, such training programs are not ubiquitously found in psychology, social work, counseling, psychiatry, or other professional training programs. However, training programs are available in the form of workshops. Exercises are available that can be used to develop in-service training (see Rose's 1998 discussion for more detail).

If the group therapist is aware of these limitations, all of the above potential problems can be avoided or, should they occur, dealt with. In this and the following sections the specific ingredients of CBGT are described. Since there are many models of CBGT, the focus is on the most eclectic approach, one that uses a wide variety of interventions and takes advantage of the group phenomena. How this model differs from other models is occasionally pointed out.

III. THE STRUCTURE OF THE CBGT GROUP

Before the interventions and phases of treatment are described, a number of practical questions need to be answered regarding number of participants, number and duration of sessions, number of therapists, and characteristics of members.

A. Size of the Group

The size of a group depends on its purpose, need for individualization, and practical considerations such as available space, length of stay in the institution, and available staff. Since individualization within a group is highly valued, the outpatient groups with which this approach has been used usually range in size from three to eight members. Generally, however, six members makes it possible to involve everyone at every session. Having a group with less than three members seems to lose many of the beneficial group attributes discussed earlier. A group larger than eight makes it difficult to allow every member to bring in a problematic situation at every meeting.

There are sometimes clinical practical reasons to modify this range. A limited number of staff may be available and a need for a group has been established. In some agencies groups of 12 or more clients have been carried out effectively, especially when all the clients share a common problem area, or if there are two therapists and the activities of the group are frequently carried out in subgroups. If there are two expe-

rienced therapists available, it would, based on my experience, be more efficacious to have two small groups than one large group. Often these larger groups have a more didactic than therapeutic goal purpose.

Institutional groups tend to be larger because they often overlap with the residential group. In order to facilitate greater individualization, the group may be divided into two subgroups, one led by the group therapist and the other by the residential worker or family worker or even a supervisor. Another reason for larger groups in institutions is that as a rule they meet much more frequently than outpatient groups. If a group meets every day, even if the group is large, each individual in the course of the several meetings a week will have the opportunity to focus on his or her problems.

B. Frequency, Length, and Duration of Group Sessions

Group size is also a function of the frequency, length, and duration of sessions. Most outpatient groups are time limited, and meet for approximately 2 hours a week for 6 to 18 weeks. In our review of the literature the modal number is 8, but most therapists prefer 12 to 18 sessions in order to achieve most treatment goals. Regular weekly sessions rather than the more variable schedule recommended later are the general pattern primarily because of the personal or work schedules of the families, of the clients, and of the group therapist rather than for any particular therapy rationale. Some have been able to follow 8 weekly sessions with 4 monthly ones as a way of providing the clients with more gradual fading of the intensity of treatment.

The exact number of sessions for outpatient groups depends on the purpose of the group, its composition, and certain practical limitations. In heterogeneous groups (members enunciating diverse presenting problems), in order to deal with a wide range of problems 14 to 18 sessions are usually required to meet treatment goals. When a highly specific and limited goal is pursued, a fewer number of sessions may suffice. In general, however, assuming major goals have been achieved after one set of therapy sessions, clients are referred to nontherapy groups such as at the YMCA/YWCA, yoga classes, bridge clubs, or sports groups to provide relatively safe opportunity to practice, unsupervised, what they have learned in therapy. Referral to individual therapy or support groups may also occur if clients have demonstrated increased motivation but are not yet ready to demonstrate their skills in the real world.

In institutions, transitional groups (groups that prepare the client to go back to the outside world) will

meet from 1 to 3 hours daily from their onset until termination, which is usually about 3 to 6 weeks. Only modest research exists to point the way to differences in the number of sessions. In adult groups in the therapy of social anxiety, D'Alelio and Murray in 1981 demonstrated that eight 2-hour sessions was significantly more effective in reducing social anxiety than four 2-hour sessions, perhaps because there is more extragroup time to practice what is learned in the group. In anger management groups for adolescents, Lochman in 1985 demonstrated the greater effectiveness of 16 sessions over 8 in increasing the control of anger by the youth.

As we mentioned earlier, although most outpatient groups are closed, some are also open-ended and have no set duration. In private practice especially, these groups of indefinite length tend to be organized. When the clients provide evidence that goals have been attained and a plan for generalization has been designed, the clients are helped by the other members to plan to terminate. Of course in such groups, termination of a given individual may also occur against the advice of the group therapist, as the attraction of the group fades for that individual without concurrent achievement of treatment goals.

In residential treatment, CBGT groups tend to meet every weekday or every other day for an hour and half for as long as the client is in the institution. Occasionally a client will miss sessions for such practical reasons as illness, doctor's appointments, court appearances, psychological testing, and special programs. Some institutions use CBGT only 2 or 3 of the 5 days, using the other days for more traditional methods.

C. Number of Group Therapists

As the number of group therapists in any one group increases so does the cost to the client, to the agency, or to the community. There is no evidence that two experienced group therapists are more effective than one, provided that the group therapist is experienced and trained. Thus, in most cases one group therapist is adequate and less costly than two or more. Moreover, two therapists often seem to amplify what the other says, which limits the time available for the clients to participate. There are, however, several situations in which more than one group therapist is required: if one of the therapists is in training, if both therapists are learning the method for the first time, if the group is larger than 10 persons, and if there are several acting-out persons in the group.

IV. PHASES OF CBGT

A. Beginning the Group

The structure of interaction in most models of CBGT can be divided into phases. Each phase overlaps with other phases, but in each phase the therapist focuses somewhat more on one set of behaviors than another. All have a "beginning the group" phase in which clients are oriented to the method, get to know each other, and the cohesion of the group is developed. Orientation involves explaining to clients what they can expect from the group experience and what is expected from them. The therapist usually describes the larger structure in the beginning and gradually fills in the details as the group progresses or as a new intervention is introduced.

Cohesion refers to the mutual liking of members with each other and with the therapist and their attraction to the program of the group. In our groups, the cohesion of the group can be enhanced by the use of group introductory exercises in which members interview each other in pairs and partners introduce their partner to the group. It is also a safe way of increasing broad participation and is the first step in self-disclosure. Cohesion is also enhanced by creating opportunities for continued broad participation, protecting members from premature and/or too harsh confrontation, keeping the interaction generally positive, using variation in the program, occasionally using humor, and developing opportunities for choice and self-decision-making by the members. The cohesion is continually monitored at the end of every session on one question of a postsession questionnaire (see later).

B. The Motivational Enhancement Phase

At the same time that the group begins and continuing into the later phases, in some models of CBGT the therapist focuses on increasing the motivation of the participants. (In most of the research cited earlier, this phase has not been explicated. One exception is found in the study by Roffman in 1997). When most clients enter a treatment group for the first time, they are often anxious, afraid of what others might think of them, and hesitant to expose their flaws to other people. They are often poorly motivated to work on the very problems that brought them to, or resulted in their being sent to, the group. This lack of motivation is particularly apparent in groups of involuntary clients such as men who batter, prisoners, and those who suffer from addictions.

However, even in voluntary groups, this ambivalence can often be detected. The type of behaviors often observed at the first session or even in the pregroup interview are a reluctance to speak, some anger about being in treatment, denial of any serious problems, setting themselves apart from the others in the group, speaking only to the therapist, an unwillingness to disclose anything about themselves, and an unwillingness to develop goals, treatment plans, or extragroup tasks.

Motivation has been operationally defined as the readiness of the client to participate actively in the treatment process (as discussed by Miller and Rollnick in 1991). This can be assessed by therapist's observations of the level of self-disclosure and other forms of participation of a self-report checklist. Strategies for enhancing motivation have been developed and are implemented throughout the treatment process to maintain the client's ever-changing commitment to change. Although in 1991 Miller and Rollnick viewed motivation as an individual characteristic, one often observes in groups a phenomenon in which motivation of each mutually influences the motivation of others. There appears to be a shared or prevailing group level of motivation. Miller and Rollnick identified a number of principles to be considered in the process of enhancing motivation. Some of these principles include normalizing ambivalence, contrasting costs and benefits of changing or resolving problems, eliciting and reinforcing self-motivational statements, and removing barriers to treatment. In addition, the therapist carries out a set of interviewing principles, such as supporting self-efficacy, avoiding argumentation, providing clear advice, and delivering continued feedback to the client. In groups the members are encouraged to respond in a similar fashion to each other.

C. Assessment Phase

Overlapping with cohesion building and orientation is the assessment phase. This actually begins with the client selecting a given group with a general theme in which she or he is interested or has major concerns (e.g., anxiety management, anger control, dealing with HIV infection). In the group and even in an intake interview, the particulars of the problem begin to be spelled out. Many practitioners make use of such paper and pencil tests as Beck's 1976 depression inventory, the fear survey schedule, and the fear questionnaire. Many other instruments are to be found in research summarized earlier. For practitioners a useful qualitative procedure often used is some form of situational analysis. Members can be trained by means of group

exercises and therapist modeling to identify and describe recent problematic or stressful situations in which they are dissatisfied with the responses. These situations are highly specific events that represent a sample of the more general complaint.

Client: Even though I am lonely most of the time and would like to meet people, I guess I don't do much to help myself (general problem).

Therapist: Can you give me a recent example of when you avoided doing something that would bring you in contact with others?

Client: That's easy; just this evening my brother called me to come for dinner, Friday. He said there would be some interesting new people there (situation). (This point is the critical moment.) The idea of meeting all those people scared the hell out of me (affective response) so I lied to him and told him I would have to be working that night (verbal response). I guess I'll never meet people that way (indicates dissatisfaction). But the people in this group have told me I'm a pleasant person and an interesting one, too (resources), so maybe this is something I can work on (goal).

Client 2: Sure, I have trouble controlling my temper (general problem). My dad was that way too (early background). But, Jeez, sometimes my wife, Shirley, really pushes my button with all her nagging (recent background). Thursday, when she told me to take the garbage out for the third time (situation) (at this point the critical moment), I thought, "there she goes again, nagging me" (cognitive response), then I really got teed off (affective response) and I let her have it (physical response). She called the cops (consequence) and I'm out on my own again (long-term consequence).

After the client provides a brief background, the situations are described in terms of what happened, where it happened, with whom it happened, and when it happened. Each client identifies a critical moment in the event and the behavioral, emotional, and cognitive response at the critical moment. (The critical moment is that instant in time that separates the triggering event from the response of the client.) The clients also state their level of dissatisfaction with the response and examine the long- and short-term consequences of their responses. In the assessment phase the group is used by having members evaluate each other's presentation as to how well the description meets the criteria.

Goal setting is also part of the assessment phase. Both individual treatment and common treatment goals are developed by each client, and, later in the process, group goals are formulated concerning group conditions requiring change. The attainment of group goals should

mediate the achievement of the individual treatment goals. As part of systematic problem-solving, specific treatment targets or goals are concrete behaviors, sets of actions, or identifiable cognitions that occur in response to a given specified problem situation. These behaviors and cognitions are specific to a given client and are identified in the interaction among members and in their description of problematic situations that they experience in their day-to-day social encounters. Since goal attainment is future oriented, the group therapist, group members, and each client together estimate a time frame for attaining the goal, which is incorporated into the formulation of the goal. Although clients identify unique individual goals, in groups common goals shared with some or all of the other group members are also identified. Common goals permit greater efficiency in terms of information to be provided, group exercises to be used, and problems to be solved. Most goals are developed over time, as members learn the language of therapy and begin to describe their problems in this highly specific terminology. When goals are not forthcoming from a given individual, the other members can "brainstorm" goals, based on earlier discussions, that might be considered by the reluctant client.

Group goals refer to a future change in interactive phenomena that occur in the group. An example of one group goal is "at the end of this session, all the members of the group will have actively participated in the role-plays." Another is "by the end of the next session, the members all establish a norm that extra-group tasks will be completed if agreed to at a prior session." A third example is "the attraction of the members to each other (as measured on a postsession questionnaire) will increase from the previous session to the end of this session." Although we urge formal goal setting as part of the treatment process, in some versions of CBGT the use of goals is more implicit than explicit. Group goals can sometimes be estimated by means of a postsession questionnaire distributed at the end of each session.

In the postsession questionnaire (PSQ) participants rate their own response to various aspects of each group session. A variety of group problems and group goals can be formulated in terms of these scales, which are in the form of 6 to 12 questions administered to all the members and the therapist at the end of every session. Some of the following are examples of PSQ items commonly used.

1. How useful was this session?

1-----2-----3-----4-----5-----6-----7-----8-----9

not at all very little somewhat quite a bit extremely

2. How actively involved were the members in today's session?

1-----2-----3-----4-----5-----6-----7-----8-----9

not at all very little somewhat quite a bit extremely

3. How helpful were members to each other during this session?

1-----2-----3-----4-----5-----6-----7-----8-----9

not at all very little somewhat quite a bit extremely

4. How much did the members reveal about themselves (their real thoughts, feelings, motivations, and or concerns) during this session?

1-----2-----3-----4-----5-----6-----7-----8-----9

not at all very little somewhat quite a bit extremely

5. How close did the members feel to each other during this session?

1-----2-----3-----4-----5-----6-----7-----8-----9

not at all very little somewhat quite a bit extremely

6. How upset or angry were the members during this session?

1-----2-----3-----4-----5-----6-----7-----8-----9

not at all very little somewhat quite a bit extremely

7. How much did the members control the content and direction of this session?

1-----2-----3-----4-----5-----6-----7-----8-----9

not at all very little somewhat quite a bit extremely

Means, discrepancies among the members, and discrepancies between the mean of the members and the therapist's observations provide a rough estimate of some of the group phenomena as perceived by the members with the group. These data and member comments are discussed at the beginning of the subsequent session.

Group attainment scaling can also be used in group therapy as a way of estimating whether group goals are achieved. Group goals usually refer to a change in process such as broader participation, greater cohesion, increase in on-task behavior, greater decision making by members, and reduction of in-group conflict. A commonly used example of a Group Goal Attainment Scale (for more details on goal attainment scaling, see Kiresuk, Smith, and Cardi's 1994 discussion) in CBGT is the following:

Much less than expected (−2). Members talk almost exclusively to group therapist (91% or more).

Moderately less than expected (−1). Members talk primarily to group therapist (65%–90% of the time).

Expected level (0). Members talk about equally to other members and to group therapist (35%–64%).

Moderately more than expected (+). Members talk primarily to other members (10%–34% toward leader).
Much more than expected (+2). Members talk almost exclusively to each other (9% or less toward leader).

As observed in some of the research summaries presented earlier, individual and common treatment goals in CBGT have included a wide range of targets including managing pain, stress, anger, depression, or anxiety; reducing and/or eliminating the use of drugs, alcohol, or cigarettes; eliminating violence toward one's spouse and children; improving parenting skills; reducing the frequency of bulimic behavior; increasing safe sex practices; increasing positive life experiences in the face of personal tragedies; building more satisfying experiences; and reducing negative or self-defeating self-statements or avoidance behavior. Most of these goals can be broken down into even more specific short-term goals to be achieved by the end of one or two subsequent sessions.

D. Intervention Phase

Situational analyses and goal setting become the foundation for the intervention phase, which may involve correcting cognitive distortions implied in the situation, providing corrective information, exposure to the anxiety-producing object, systematic problem solving, modeling and rehearsing alternatives, reinforcing successful actions, and other interventions, most of which are carried out in the group with the help of the other group members. All of these interventions as they are applied in groups are described later.

E. Generalization Phase

In the generalization phase, which overlaps with the earlier phases, clients are prepared to transfer what they have learned in the group to the outside world and to maintain what they have learned in therapy beyond the end of therapy. In particular, extragroup tasks are designed for each member, usually at the end of every session, to be carried out in the community. Some of the other principles that are incorporated into treatment and that guide the planning for generalization are teaching the target behaviors in varied and multiple ways, finding opportunities for clients to teach what they have learned to others, encouraging clients to go public with their intervention plans and goals, gradually increasing the level of difficulty of expected behavior, preparing the clients for potential setbacks, having booster sessions following termination,

and encouraging membership in support or social recreational groups following group therapy.

V. INTERVENTION STRATEGIES

Almost all models of CBGT make use of a wide variety of interventions. Different models tend to emphasize different sets of interventions. These include cognitive change procedures, guided group exposure, modeling techniques, relaxation training, problem-solving techniques, operant procedures, community change strategies, relationship enhancement methods, and small group techniques, all of which are now discussed in more detail.

A. Cognitive Change Methods

Since the method is referred to as cognitive-behavioral, the major strategies employed focus on correcting distorted cognitions and replacing them with coping thoughts. Specifically, it includes such techniques as cognitive restructuring, cognitive modeling, self-instructional training, and realistic goal setting.

The most commonly used form of cognitive restructuring in groups is derived from the work of Aaron Beck in 1976. Bottomley, Hunton, Roberts, Jones, and Bradley in a 1996 study described earlier used Beck's method of challenging dysfunctional thinking of clients by the therapist. In groups the challenging may also be the responsibility of the other group members as they learn the correct techniques. In addition, the clients are helped to develop alternative cognitive coping skills and some behavioral alternatives as well (e.g., relaxation, recreational skills, social skills). The cognitive coping responses are often practiced in the group in role-plays (cognitive rehearsal). One technique proposed by Beck and Emery in 1985 that lends itself in particular to groups is "point counter point." In this technique a target client argues why his position is distorted or illogical, while another member or the group therapist try to support the illogical position. The discussion is first developed in pairs and then later presented to the entire group. The group members may coach the target client in his or her new role. The danger is that sometimes the group is too aggressively confrontative. To avoid this the group members are first trained through therapist modeling and explanation and a group exercise how to deliver and receive critical feedback.

Another version of cognitive restructuring as discussed by Meichenbaum in 1977 that we employ most

frequently as noted by Rose in 1998 is characterized by a set of procedures used to change self-defeating or illogical patterns of thinking to self-enhancing or logical ones. It is the first step used in improving cognitive coping skills. It is assumed that in a given set of circumstances cognitions partially mediate overt behavioral responses. These cognitions include how one values oneself and one's actions and how one specifically thinks or responds covertly in a given situation. The clients are trained to identify self-enhancing and self-defeating thoughts in case examples or exercises. Later they learn to identify their own self-defeating thoughts and try to change these to self-enhancing thoughts. They are taught through modeling initiated by the therapist and rehearsal by the client of the new cognition. Rehearsals may be carried out by all the group members, one after the other. Self-instructional training as described by Meichenbaum in 1977 combines cognitive restructuring and problem solving. It consists of the members being encouraged to make step-by-step verbalizations concerning the problem definition ("What's wrong with the way I'm thinking about this?"), problem focus ("What can I do about it?"), focusing of attention ("I should think about how that will get me in trouble"), coping statements ("If I keep relaxing I won't blow it!"), and self-reinforcement ("Wow! I did it! See, I can do it!"). To prepare for implementation of these strategies the group therapist or another client demonstrates (modeling) what might be said to oneself. This is followed by practice (rehearsal) by the client with the problem, first stating the coping statements aloud, then whispering, and eventually silently stating the coping statements to himself or herself. The group members serve as coaches for each other. This technique is often integrated into guided group exposure.

B. Guided Group Exposure

This technique has been primarily used in the treatment of agoraphobia, as described by Hand, LaMontagne, and Marks in 1974, although some practitioners and researchers have used it with other phobic objects usually in combination with cognitive restructuring and other techniques. The guided exposure involves exposure of the client in groups to feared situations *in vivo*, first together with other group members and then eventually alone. For example, a group of clients who suffered from agoraphobia went together to a department store after preparing by means of cognitive restructuring and the modeling sequence. The first trial was in the morning when the store was almost empty;

later they went at noon when it was more crowded; and the third time they went to the department store during a high volume sale. Later, they tried out the same exercises with partners from the group and eventually they performed them alone. Emmelkarnp and Kuipers in 1985 reviewed the commonly used procedures and the current research that lends support to these methods. As described earlier Mattick and Peters in 1988 conducted a study to assess the effectiveness of guided exposure with and without cognitive restructuring. The combined model of guided exposure and cognitive restructuring was significantly more effective than guided exposure alone. Evans, Holt, and Oei in 1991 reported on the long-term effects of a brief intensive CBGT in which group exposure methods combined with cognitive and other procedures were successfully used in treating agoraphobia. Heimberg and Colleagues in 1990, as described earlier, successfully used exposure methods and cognitive restructuring to significantly change the prosocial behavior of social phobics.

C. Modeling Methods

In our experience, symbolic modeling is one of the most effective strategies in group therapy. As we noted earlier, modeling by the therapist and the members for each other was an integral part of all of the other strategies described so far. Modeling strategies in groups have also been used in preventive and behavioral medicine with patients using the health care system (as described, for example, by Newton-John, Spence, and Schotte in 1995, and by Subramanian in 1991 and 1994). It has also been used successfully with mentally ill patients with social impairments, (as discussed by Daniels and Roll in 1998, and by Van Dam-Baggen and Kraaimaat in 1986). Modeling techniques are the central procedures in assertion training and play an important role in teaching clients how to cope with stress. In addition, because of the presence of many potential models and sources of feedback, modeling is especially useful in groups.

Symbolic modeling involves simulated demonstrations (role-playing) by group members, the group therapist, and/or special guests in the group. It may also include video or audio tapes of actors or real clients. The advantage of symbolic modeling over real-life modeling is that simulated modeling can be focused and developed systematically by the group and group therapist. It can be applied in simple situations with one critical moment or eventually in complex situations consisting of many critical moments. In symbolic modeling the group therapist can direct the action so that successful efforts

can be reinforced and unsuccessful ones terminated and redeveloped. The small group is especially well-suited to the use of symbolic modeling since it affords a rich source of ideas as to what the model should do, and multiple models and multiple sources of feedback to the person attempting to duplicate the role of the model. The techniques used in enhancing the modeling effects are drawn from the assumptions about and research on social learning, theory according to Bandura in 1977.

As in the earlier examples, most modeling is used solely by the therapist to demonstrate a given behavior or set of behaviors. However, modeling may be used as a major intervention package. In that case the modeling sequence in its entirety makes use of a number of steps.

1. The therapist orients the group to modeling and demonstrates the modeling steps (the first few times only).
2. Based on a situational analysis of an interactive situation, each client presents a situation he or she wants to have role modeled. The client clarifies the roles of model, target person, significant others, and observers.
3. A model is selected who demonstrates the desired behaviors. The model may be the therapist, a group member, or a guest invited for that purpose.
4. The target person rehearses or practices what she or he has observed, if necessary with some coaching or assistance from others (rehearsal plus coaching). If coaching is used the rehearsal is repeated without coaching.
5. The target person is provided with feedback from the other group members and the group therapist.
6. The practice is repeated as many times as time permits and the target person requires in order to be comfortable in his or her new set of behaviors. If necessary, additional practice may be carried out in pairs or triads to save time.
7. With the assistance of the group or a partner, each client designs an extragroup task to perform the modeled behavior in the real world or to practice again outside of the group.

D. Relaxation Methods

Relaxation is a way of teaching clients to deal directly with such strong emotions as anxiety, stress, pain, or anger for which no external coping behavior is possible or where cognitive coping behavior is insufficient (although the two procedures are often paired). This technique primarily involves teaching clients a

modified version of the system developed by Jacobson in 1929 and 1978 in which various muscle groups are alternately tensed and relaxed. This is often referred to as neuromuscular relaxation. In later phases, the tensing of muscles is eliminated. To make use of the group, after an initial demonstration by the therapist, the clients teach, monitor, and reinforce each other's efforts in the group for suitable performance and practice. Various alternatives uniquely suited to specific populations are also taught. Modest research support for the use of neuromuscular relaxation procedures for reducing anxiety and stress is to be found in studies by Stovya in 1977 and Lyle, Burish, Korzely, and Oldham in 1982. However, Heide and Borkovec in 1983 showed that relaxation may increase anxiety for some individuals. Meditation and breathing exercises can be taught as alternatives to neuromuscular relaxation depending on the preferences of the group members and the skills of the group therapist.

E. Systematic Problem Solving

Many models of CBGT make use of some form of systematic problem solving insofar as clients bring problems of concern to the group. The group, under the therapist's guidance, attempts to help find solutions to those problems. It is systematic insofar as the members follow specified steps, which include orienting the members to the basic assumptions of problem solving, identifying and defining the problem and client resources for dealing with the problem, generating alternative solutions, evaluating and selecting the best set of solutions, preparing for implementation, implementing the solution outside the group, and evaluating the outcome with the other group members at a subsequent session (as discussed by Heppner in 1978 and Goldfried and D'Zurilla in 1969). We have added the intermediate step called preparation for implementation. In this preparation, modeling, cognitive restructuring, or information giving may be used and an extragroup task is designed to be carried out prior to the next session. The tasks may involve small and gradually increasingly difficult steps toward performing the goal behavior.

Systematic problem solving is most effective as a group procedure, because in generating ideas for dealing with the problem, the many group members are a rich resource for potential solutions. Moreover, in evaluating these ideas the many group members provide varied life experiences on which to support or reject some of these solutions generated. The group is also a source of reinforcement and support for carrying out the task.

F. Operant Methods

These methods involve procedures in which the immediate consequences of a given behavior are followed in some systematic manner by a reinforcing event. It may also involve procedures in which the immediate conditions that lead to, or are parallel with, a given behavior are changed to create circumstances more amenable to the performance of a desired behavior. The latter is often referred to as stimulus control.

In groups, clients receive many kinds of reinforcement for the performance of prosocial group behavior and the completion of extragroup assignments or home tasks. With adults, this reinforcement takes the form of praise by the group therapist or other group members. Occasionally, it takes the form of smiles, applause, approving nods, and delighted laughter. Reinforcers are withheld in response to undesirable behaviors. This is referred to as extinction and is an occasional response in groups when someone is frequently off-task or complains a great deal. However, because in groups so many people are involved, it is a difficult procedure to manage.

Operant procedures, especially reinforcement, lend themselves to group conditions if the therapist trains and encourages members to reinforce each other and significant others outside of the group. Exercises have been developed to train members in effective use of praise and constructive criticism as communication skills in their own right.

Modifying the antecedent conditions or stimulus control was exemplified by a client in a weight-loss group who was urged by the others to eat only at a set table and with food that had been cooked. The group had a pot luck dinner in which the behavior was modeled. Two college students in a study skill enhancement program developed with each other a plan in which they only studied at a clean desk and did nothing but study at that desk. They monitored each other. They removed the telephone and food from the study room. Success was followed by group approval and self-reinforcement.

G. Community Interventions

Community interventions are used as part of the generalization process. It involves the client in dealing with other organizations or social systems in which they might find social support, social recognition, and reinforcement. For example, a group of parents of intellectually challenged children organized a float on which their children sat in a local parade as means of educating the public that they were not ashamed of their children.

This same group developed a little booklet for physicians on how to deal with the parents of special children and the children themselves as described by Kirkham, Schinke, Schilling, Meltzer, and Norelius in 1986. In working with clients with limited resources, referral to needed services may be considered. Ideas for community interventions may also come from the group.

H. Relationship Enhancement Methods

A number of skills have been identified as crucial to any helping relationship, (as discussed by Goldstein and Higgenbottom in 1991), regardless of whether this relationship is dyadic or within the structure of a small group. We have noted in our supervision of group therapists that in spite of high levels of technological skill, failure of group therapists to possess these relational or clinical skills results in high dropout rates from groups, disinterest on the part of the clients, and high levels of group problems.

Many of these skills are to be found in the other methods described earlier. For example, group therapists who can comfortably and frequently provide their members with high levels of reinforcement and protect the clients from premature or abusive feedback tend to establish sound relationships with group members. Similarly, group therapists who model self-disclosure (and all of the other skills that the members are expected to carry out) discover that the indicators of group problems (high levels of conflict, low cohesion, low satisfaction, exclusive pairing off, low group productivity) seldom arise.

Some skills are unique to relationship building. For example, the use of humor with clients is not addressed in the methods above. Yet, successful therapists must be able to play and joke with clients. Involving clients and the group in their own therapy is a skill that is essential for achieving generalization of change. This involves helping clients to take a chance at answering the questions of their fellow members, to make suggestions to each other for plans of action, to help each other to clarify the essential aspects of their problems, and to formulate appropriate goals. The process by which clients are involved is a vital relationship-building skill. Another skill is letting clients make their own decisions as much as possible concerning goals, extragroup tasks, and the extent of their participation. The more clients perceive themselves as deciding on what happens to them, the more likely it is that they will make use of interventions (similar to the ideas of Miller and Rolinick in 1991).

Listening to clients is a skill not discussed earlier, yet the absence of careful listening often results in choosing wrong change targets. Effective listening does not necessarily require seeing the underlying implications of the client's words, but rather has to do with grasping the obvious meanings. While hastening to carry out the items on a group's given agenda, for instance, therapists might interrupt or ponder next steps while a client is still speaking. This can cut off important interpersonal messages.

Attending skills refers to competency in observing nonverbal responses such as eye contact, body posture, and voice tone. Although these are nonspecific characteristics that are difficult to define, ratings by observers of group therapists in action tend to indicate whether such skills are indeed operating.

Setting limits on disruptive or off-task behavior is another relational skill that must be considered if the goals of change are to be pursued in a safe environment. This is one of the more difficult of the relational skills and one of the most frequently needed. It is not always clear when to set limits and when to ignore disruptive behavior. Skill in reinforcement and developing interesting and attractive program content often protects the group therapist from frequent application of limit setting.

I. Small Group Procedures

We have already discussed the unique opportunities as well as the limitations offered in therapy in small group settings. As mentioned earlier, interventions such as modeling, cognitive restructuring, and relaxation are administered in such a way as to encourage broad participation and high attraction among group members. In addition to the specific intervention strategies adapted from individual treatment mentioned earlier, there are some concrete group procedures that appear to contribute to helping clients move toward change. These group procedures include broad group participation, role-playing, the buddy system, subgrouping, leadership skill delegation, group exercises, and sociorecreational procedures. All of these techniques are described below. Combinations of these procedures are often applied to attain group goals or resolve group interaction problems.

Broad group participation refers to client-to-client verbal as well as client-to-therapist interaction in which all members participate extensively. It is the essential element by which problems are laid out and considered, solutions are shared and evaluated, decisions are formulated and affirmed, values are deliberated, and friendships are made. Maximum involvement of all group

members is essential for high cohesion and effective therapy. Broad group participation in the discussion is a necessary ingredient in the evaluation process, in problem solving, in assessment as members respond to other persons' stories, and in providing feedback to each other. Although not typical of many CBGT groups, issues sometimes arise that need to be discussed, such as stereotyping of persons with the client's problems and group problems (e.g., someone dominating the interaction). The therapist usually encourages such discussions but holds them to tight time constraints in time-limited groups.

Role-playing, in its most elementary form, can be defined as the practice of roles under simulated conditions. The group therapist, by acting as a guide and structuring the role-playing, contributes to the process and to the outcome achieved through role-playing. If the group therapist is clear about the purposes of role-playing, this technique can prove highly beneficial in promoting change, broadening participation, and in increasing cohesion. Role-playing may be used in assessment to discover how clients actually handled a given situation. In the modeling sequence, role-playing is used both to demonstrate specific skills and to practice them. Role-playing is also used to demonstrate and practice specific therapy skills such as giving and receiving feedback or showing empathy to others. Role reversal is a form of role-playing in which the client plays a significant person in his or her life and that person or another group member plays the client. It is a procedure that gives insight into how it feels to be the other person. Finally, role-playing is used to practice generalization strategies evolved in the group. Some clients are initially reluctant to role-play; however, the activity appears to eventually gain the enthusiastic cooperation of almost all members if it is implemented in a supportive, nonthreatening atmosphere.

Subgrouping is a simple procedure in which clients work in pairs, triads, or other sized subgroups to increase interaction among group members and provide them with an opportunity to work without the oversight of the therapist. It also may increase the amount of work that can be done in a given period of time. Subgrouping creates an opportunity for group members to practice leadership skills and afford clients the opportunity to help others while being helped themselves. The buddy system (as discussed by O'Donnell, Lydgate, and Fo in 1979) is a special subgrouping procedure for clients to work together outside of the group. In addition to the advantages mentioned earlier, it contributes to the transfer of learning from the group to situations outside of the group. The danger of

subgrouping is that the interaction occurs without the supervision of a therapist. In the group sessions the therapist can sample the interaction by floating from subgroup to subgroup. Moreover, subgroup activities are usually highly structured.

Group exercises refer to the use of structured interactive activities as ways of teaching clients the skills that mediate the achievement of therapeutic goals. For example, an introduction exercise is used in which a client interviews and is interviewed by at least one other client in the group and then introduces the partner to the others. Another exercise is one in which the clients study a case and discuss how each of them is different from the person in that case. Other exercises involve teaching clients how to give and receive both praise and criticism to a partner in the group. To be effective exercises are usually in writing and the goals as well as the activities are stated.

The therapist must make sure that the exercise is understood before they begin. Usually, at least one group exercise is carried out in every session. Other interventions, in addition to subgrouping, may be embedded within group exercises. For instance, a "round robin" exercise uses modeling and rehearsal at a fast clip in order to provide multiple trials of new behavior. In teaching how to ask for help, Pete asks Don for help, then Don asks Robin for help, then Robin asks Jerry for help, and finally, Jerry asks Pete for help.

VI. SOME CLOSING REMARKS

In this article the process of using cognitive behavioral and small group strategies in the treatment of individuals in groups has been described. Although the focus has been on adults, most of the same principles apply equally to group therapy for youth and children (Rose in 1998 provided a detailed account of this approach with youth). Where relevant literature was available, it was cited. However we have also drawn on our own experience and that of other practitioners for examples and practice principles. This article has stressed the use of procedures commonly used by various helping persons as they can be applied in groups. It should be noted that this chapter has drawn from practice, research, theoretical, and clinical literature produced by psychologists, social workers, psychiatrists, and others in the helping professions and social sciences. The therapists of the groups exemplified in this book come from diverse professional backgrounds. The label most commonly attributed to work with groups to achieve social-therapeutic goals has been "group therapy." In

many cases, the labels group treatment, group work, group training, or group counseling could have been used just as appropriately. We have referred to the individual who leads the process as group therapist—a label that cuts across all of the above fields. The group therapist might just as readily have been identified as group worker, group leader, or group counselor, since the activities of each overlap the others considerably. We have used the words, “clients” and “members” interchangeably to refer to the persons belonging to the groups.

As noted often, CBGT is not one approach but several similar ones. I have tried to point out some of the differences as well as similarities. Some stress one intervention strategy such as modeling, cognitive restructuring or guided imagery, while others use a wide range of interventions. The particular model stressed in this chapter is cognitive-behavioral interactive group therapy (CBIGT) because of its emphasis on the use of the group as the means as well as the context of therapy, along with a wide variety of both cognitive and behavioral procedures.

See Also the Following Articles

Adjunctive/Conjoint Therapies ■ Anxiety Disorders: Brief Intensive Group Cognitive Behavior Therapy ■ Cognitive Appraisal Therapy ■ Cognitive Behavior Therapy ■ Group Psychotherapy ■ Psychodynamic Group Psychotherapy ■ Self-Help Groups

Further Reading

- Avia, M. D., Ruiz, M. A., Olivares, M. E., Crespo, M., Guisado, A. B., Sanchez, A. & Varela, A. (1996). The meaning of psychological symptoms: Effectiveness of a group intervention with hypochondriacal patients. *Behavioural Research Therapy*, 34, 23–31.
- Bottomley, A., Hunton, S., Roberts, G., Jones, L., & Bradley, C. (1996). A pilot study of cognitive behavioral therapy and social support group interventions with newly diagnosed cancer patients. *Journal of Psychosocial Oncology*, 14, 65–83.
- Daniels, L., & Roll, D. (1998). Group treatment of social impairment in people with mental illness. *Psychiatric Rehabilitation Journal*, 21, 273–278.
- Fisher, M. S., & Bentley, K. J. (1996). Two group therapy models for clients with a dual diagnosis of substance abuse and personality disorder. *Psychiatric Services*, 47, 1244–1250.
- Kiresuk, T. J., Smith, A., & Cardi, J. E. (Eds.). (1994). *Goal attainment scaling: Applications, theory, and measurement*. Hillsdale, NJ: Erlbaum.
- Lidbeck, J. (1997). Group therapy for somatization disorders in general practice: Effectiveness of a short cognitive-behavioural treatment model. *Acta Psychiatrica Scandinavica*, 96, 14–24.
- Lidren, D., Watkins, P. L., Gould, R. A., Clum, G. A., Asterino, M., & Tuloch, H. L. (1994). A comparison of bibliotherapy and group therapy in the treatment of panic disorder. *Journal of Consulting and Clinical Psychology*, 62, 865–869.
- Lutgendorf, S. K., Antoni, M. H., Ironson, G., Klimas, N., Kumar, M., Starr, K., McCabe, P., & Cleven, K. (1997). Cognitive stress management decreases dysphoric mood and simplex virus-type-2 antibody titers in symptomatic HIV-seropositive gay men. *Journal of Consulting and Clinical Psychology*, 65, 31–43.
- Newton-John, T., Spence, S., & Schotte, D. (1995). Cognitive-behavioral therapy versus EMG biofeedback in the treatment of chronic lower back pain. *Behavioral Research Therapy*, 33, 691–697.
- Roffman, R. A., Downey, L., Beadnell, B., Gordon, J. R., Craver, J. N., & Stephens, R. S. (1997). Cognitive-behavioral group counseling to prevent HIV transmission in gay and bisexual men: Factors contributing to successful risk reduction. *Research on Social Work Practice*, 7, 165–186.
- Rose, S. D. (1998). *Group therapy with troubled youth, a cognitive-behavioral interactive approach*. Thousand Oaks, CA: Sage.
- Subramanian, K. (1994). Long-term follow-up of a structured group treatment for the management of chronic pain. *Social Work Practice*, 4, 208–223.
- Tanco, S., Wolfgang, L., & Earle, T. (1998). Well-being and morbid obesity in women: A controlled therapy evaluation. *International Journal of Eating Disorders*, 23, 325–339.
- Tolman, R., & Edleson, J. (1995). Intervention for men who batter: A review of research. In S. Stith & M. Straus (Eds.), *Understanding partner violence: Prevalence, causes, consequences, and solutions* (pp. 262–274). Minneapolis, MN: National Council on Family Relations.
- Vogel, P., Eriksen, L., & Bjoerndal, S. (1997). Skills training and prediction of follow-up status for chronic alcohol dependent inpatients. *European Journal of Psychiatry*, 12, 51–63.

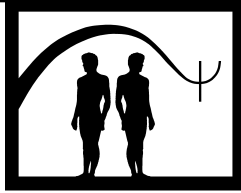

Cognitive Behavior Therapy

Deborah A. Roth

Center for the Treatment and Study of Anxiety,
University of Pennsylvania

Winnie Eng and Richard G. Heimberg

Adult Anxiety Clinic of Temple University

- I. Description
- II. Theoretical Bases
- III. Empirical Studies
- IV. Summary
- Further Reading

I. DESCRIPTION

Cognitive behavior therapy (CBT) incorporates principles associated with information-processing and learning theories. A basic assumption of CBT is the recognition that there is a reciprocal relationship between clients' cognitive processes (what they think) and their affect (emotional experience), physiology, and behavior. Although CBT treatments for individual disorders differ in both their form and application, they all emphasize the importance of changing cognitions and behaviors as a way of reducing symptoms and improving the functioning of the affected person.

CBT clearly defines roles for both the therapist and the client, both of whom are active participants in the therapy. The clinician assumes the role of educator, teaching the client about cognitive models that have been developed to understand the etiology and, more importantly, the maintenance of the client's specific problems. The clinician is also responsible for teaching clients the cognitive and behavioral techniques designed to alleviate their problems. The client is considered to be the expert on his or her personal experiences, and the two of them work together to overcome the client's difficulties.

The stance taken by therapists in CBT is quite different from that taken by therapists who employ different modes of treatment, most notably psychodynamic therapy. In CBT, therapists clearly communicate to clients that they do not have all of the answers and that they

GLOSSARY

- automatic thoughts** The self-critical or exaggerated negative self-statements that go through a person's mind and are accepted as true by the person without testing their accuracy.
- cognitive restructuring** A treatment technique that attempts to identify and modify negative or unrealistic thoughts or attributions.
- cognitive triad** A person's view of him- or herself, of the world, and the future, which may lead to depression when negative.
- exposure** A treatment approach in which clients systematically confront their feared objects or situations.
- exposure and response prevention** An approach to treatment for obsessive-compulsive disorder (and other disorders such as bulimia nervosa) in which the client is systematically and gradually exposed to his or her feared thoughts or situations while compulsive rituals or other behaviors are actively prevented.
- schema** An enduring and stable belief system that assists in explaining experiences, mediating perception, and guiding response.
- self-monitoring** A treatment technique in which clients systematically observe and record behaviors or responses and may be used to highlight subsequent changes in patterns of responses.

must collaborate to solve the client's problems. For clients to experience symptom relief, they must also actively seek out new experiences and must learn to look at the world in new ways. Clients are, in effect, taught over time to serve as their own therapists, to apply the principles of CBT with decreasing amounts of guidance from the therapist. Encouraging clients to take on this role might be part of the reason why gains experienced over the course of CBT tend to be maintained or even increased once treatment has ended.

A core assumption of cognitive behavioral approaches to understanding and treating mental disorders is that people are active processors of information. In Aaron Beck's original cognitive model of depression, three important concepts were introduced to help to explain the psychological underpinnings of the disorder, and these concepts have greatly informed our understanding of other disorders as well. First, Beck introduced the cognitive triad, a term to describe his contention that depressed people have negative views of themselves, their ongoing experiences, and their futures. The second core component of Beck's model is the schema. Each day, humans are barraged with numerous stimuli from the environment, and it would be impossible to attend to every single one. Furthermore, once a person actually attends to a stimulus, how he or she comes to understand and process it might be very different from how another individual might react to that same stimulus. Beck suggested that our reactions to stimuli are determined by relatively stable cognitive structures called schemas. Once activated, schemas can have effects reaching far beyond the immediate situation. For example, a relationship break-up might trigger a depressive schema (which might relate, for example, to the inevitability of the loss of all things good) and lead the individual to view unrelated events in a similar vein. For example, having an important piece of mail get lost might be interpreted as just one more example of how "no one cares for me," while prior to the break-up (and the activation of the depressive schema), that same event might have been interpreted in a more neutral and less hurtful way.

Finally, Beck also introduced the idea of faulty information processing. Specifically, depressed people tend to erroneously think in an "extreme, negative, categorical, absolute, and judgmental" fashion, not surprisingly leading to negative affect. According to Beck, these thinking errors maintain clients' negative beliefs about the self, their experiences, and the future, even in the presence of contradictory evidence.

Given that negative affect and behaviors are facilitated and maintained by faulty information processing, it makes sense that the main goal of cognitive behavior therapy is to fix errors in thinking. Thoughts can often be changed directly, in which case clients are instructed to be attentive to subsequent changes in their mood, physiology, and behavior. Conversely (as will be discussed in more detail below), clients are also taught that changes in behavior can result in subsequent changes in cognition. These behavioral changes can also have a profound impact on affect and physiology. In short, clients are encouraged to always keep the important reciprocal relationship between cognition and behavior in mind and to remember that alleviation of symptoms can come about via changes in thinking and/or changes in behavior.

An important component of treatment is to make clients aware of their negative automatic thoughts. Often, clients are so accustomed to having negative thoughts, and the thoughts come to them so quickly, that they are not even aware of having them. Furthermore, clients rarely come into treatment having a clear understanding of the ways in which negative thoughts impact affective, physiological, and behavioral processes. Therefore, a first step in treatment is to help clients to become more aware of their thoughts, primarily through self-monitoring exercises. In line with Beck's cognitive triad, important targets of CBT include beliefs and expectancies about oneself and one's future, about others, and about the world. Once clients become adept at this process, it is essential also to teach them to evaluate their thoughts and to restructure them to be more rational and adaptive, all the while being cognizant of how changing thinking patterns can influence feelings as well as patterns of behavior. Although cognitive restructuring is very effortful at first (and requires the guidance of the therapist), clients gradually become more adept at the process, and many remark that this new style of looking at the world becomes integrated into their internal thought processes.

As noted above, changes in behavior can also have a profound impact on thinking patterns. Behavioral exercises in CBT can take many forms. The client is encouraged to take the stance of a scientist, viewing dysfunctional beliefs as hypotheses that can be tested, rather than as facts. This process of hypothesis testing involves not only cognitive restructuring, but also behavioral exercises. An important assumption behind this scientific stance is that beliefs can only be changed if there is concrete evidence to support the integration of new ways of looking at the self, the world, and the future.

Behavioral techniques used in CBT are also greatly informed by the assumption that psychological difficulties are often maintained by dysfunctional patterns of behavior, including avoidance. As such, an important component of CBT is the use of exercises aimed at changing clients' expectancies about their ability to function in particular situations. For example, the key to treating a specific phobia of spiders is to actually expose the client to spiders. Through this experience, clients learn that their anxiety will habituate over time, that the terrible consequences that they associate with spiders are unlikely to occur (e.g., that the spider will have fangs that result in violent bites), and that they have the skills to deal with their anxiety in this feared situation.

Another behavioral technique used in the treatment of some disorders is exposure and response prevention (EX/RP). Here, clients are encouraged to resist the urge to engage in dysfunctional behaviors while exposing themselves to the stimuli that typically elicit these behaviors (e.g., refraining from bingeing after eating a bit of a fattening food in the case of bulimia nervosa; refraining from washing after touching something perceived by the client as contaminated in the case of obsessive-compulsive disorder). These exercises are again intended to test out the veracity of the client's beliefs (e.g., eating a bit of a forbidden food does not need to invariably result in a binge; touching something dirty will not result in something terrible happening), as well as to teach clients to use more effective coping strategies and to feel more in control of their behaviors.

An important component of CBT is relapse prevention. Throughout treatment, clients are encouraged to integrate CB techniques into their daily lives, with the intention that in doing so, CBT will remain effective after therapy ends. Some interventions, however, are specifically aimed at preventing posttherapy relapse. Specifically, clients are made aware of the fact that they might have difficult times in the future even following successful treatment. In line with cognitive-behavioral principles, they are encouraged not to interpret a single difficult event as a failure. Although the same difficult events might come up pre- and posttherapy, clients are reminded that they have come away from therapy with many useful skills that they did not previously have at their disposal. As already noted, an important goal of therapy should be to ensure that clients can apply cognitive and behavioral techniques on their own, with less reliance on the therapist over time, thus facilitating relapse prevention efforts.

CBT is a very versatile treatment, adaptable to both group and individual settings. It has been used with

children, adolescents, and adults across a wide range of cultural and socioeconomic backgrounds. CBT is also a time-efficient treatment, with most uncomplicated cases of anxiety or depression being treated in 4 to 14 sessions. This efficiency comes about for a number of reasons. First, the CBT therapist performs a thorough assessment prior to treatment that is aimed at identifying a principal problem that will be the focus of treatment. The clinician then develops a treatment plan that specifies how long the problem should take to treat and what should be accomplished during each session to meet that goal. This efficiency has been greatly aided by the development of CB treatment manuals, written for a range of psychological disorders. While these manuals help clinicians to structure treatment, they also encourage flexibility in terms of tailoring the treatment to suit the progress of the individual client.

Another factor in the time-limited nature of CBT is its focus on the "here and now." The CB view of symptom maintenance is greatly informed by learning theory. Simply put, difficulties are viewed as maladaptive "habits" that have been learned as a result of the association between certain stimuli and certain responses or as the result of reinforcement of specific responses in specific situations. Rather than looking back on why a particular problem developed (e.g., why a stimulus came to be associated with a particular response), focus is placed on developing new, more adaptive stimulus-response associations through the use of both cognitive and behavioral techniques.

CBT is an effective treatment for a wide range of client groups, although there are some contraindications. CBT is generally not indicated for people with thought disorders, although it should be noted that some researchers have explored the efficacy of CBT for schizophrenia (as reviewed recently by Faith Dickerson) and the research done to date suggests that the approach might be more promising than intuition would suggest. CBT is also not indicated for people with organic brain disorders or for people who do not have a good grasp of the language in which therapy is being conducted. Beyond these limitations, CBT has been used successfully with clients from a broad range of educational backgrounds.

Clients who embark on CBT must also be willing to accept the basic premise of the cognitive-behavioral approach to understanding and treating psychological disorders. Thus, clients who are very wedded to a particular theoretical or therapeutic approach and who are not willing to consider alternative perspectives might not do well in CBT. Furthermore, clients must be willing to

commit time and effort to their treatment. They are expected to work on their own between sessions, and research has suggested that adherence to homework assignments is predictive of good treatment outcome. As such, clients who are so impaired that they are unable to actively engage in treatment might not be good candidates for CBT until they experience some symptom relief from other approaches (e.g., medication).

II. THEORETICAL BASES

Cognitive-behavioral theories resulted from a gradual evolution of thought in the field of psychology that began as a reaction to the psychoanalytic theories that dominated clinical psychology and psychiatry in the 1960s. In its classical formulation, Sigmund Freud's psychoanalytic theory rested on the reductive analysis of the psyche, conducted from a scientifically detached posture. The main features of this theory included an emphasis on the unconscious, intrapsychic processes, and early childhood experiences. By its very nature, psychoanalytic constructs were not conducive to empirical investigation or validation. A growing dissatisfaction with the length and expense of psychoanalytic therapy and an ongoing controversy about its relative effectiveness led to a rise in treatments based on behavioral theories of psychotherapy.

Behavioral theories in the 1960s and early 1970s were based on the assumption that behavior develops and is maintained according to the principles of learning. One of the earliest influences on behavioral models of psychopathology was the seminal work of the Russian physiologist Ivan Pavlov on the principles of classical conditioning. His specific findings on animal learning processes, as well as his controlled methods of laboratory investigation, made important contributions to the study of behavior by prompting the view that a particular psychological symptom may be a response triggered by a specific stimulus or event. In one of the most significant investigations of learned behavior, John Watson and his colleagues demonstrated that specific fears could be both conditioned and deconditioned in human beings via the principles of classical conditioning. Using these and his own research findings, Joseph Wolpe developed a treatment for human anxiety referred to as systematic desensitization, wherein deep muscular relaxation is paired with images of anxiety-provoking situations. Over time, clients using this technique would experience less anxiety in response to the feared stimulus because the condi-

tioned relaxation response was incompatible with the physiological response of fear. B.F. Skinner explored another learning principle called operant conditioning. Theories based on operant conditioning rest on the notion that many behaviors are performed spontaneously and are controlled primarily by their consequences. Thus, the removal of a reinforcing consequence should decrease the frequency of an unwanted behavior and conversely, applying a reinforcing consequence should increase the frequency of a desired behavior.

This belief that psychological disorders arise from an inappropriate conditioning history led to the development of behavioral treatments based on the tenet that symptoms can be reshaped into adaptive behaviors through a program of response-contingent reinforcement. Behavioral therapy was compatible with experimental methodologies, was time-efficient and heralded success in reducing anxiety and overcoming maladaptive avoidance behaviors. However, criticism of strict stimulus-response behaviorism soon followed. Albert Bandura, a social learning theorist, showed that cognitive processes were critical to the acquisition and maintenance of maladaptive behaviors and emphasized a more reciprocal relationship between the person and the environment. Other limitations of strict behavioral therapy, including a neglect of affective processes and a lack of success in the treatment of depression, opened the way for a more cognitive approach to the theory and treatment of psychological disorders.

Albert Ellis has been credited for his pioneering work in formulating the first coherent system of cognitive behavior therapy called rational-emotive therapy (RET). RET uses direct cognitive debate, logical persuasion, and behavioral homework assignments to challenge irrational beliefs and negative thinking. The goal of this therapy was to modify the core cognitive dysfunctions that are the basis of psychological disturbance. Unlike strict behavioral theories, cognitive theories assert that individuals are active participants in their environments, judging and evaluating stimuli, interpreting events and sensations, and appraising their own responses.

As mentioned earlier, Aaron Beck has been a highly influential figure in the history of cognitive therapy. In contrast to earlier theorists, Beck placed a great deal of emphasis on the cognitive aspects of psychopathology, while also advocating the integration of established behavioral techniques.

The marriage of these two approaches provides the foundation for a cognitive-behavioral approach to psychotherapy, wherein overt behavior and covert cognition, along with the interaction between the two, are crucial

for explaining the development and maintenance of emotional distress. This approach attempts to integrate the rigors of a behavioral research methodology and performance-based exercises with the centrality of mediating information-processing factors in cognitive therapy. This therapeutic approach thus offers greater explanatory power through an integration of cognitive, behavioral, emotion-focused, and social aspects of change.

The field of cognitive-behavioral therapy has been increasingly specialized and refined since the early work of Beck and Ellis, and cognitive-behavioral treatments have been applied to a wide range of psychological conditions and problems. However, these treatment programs have a common core that belies their common ancestry.

III. EMPIRICAL STUDIES

Studies of the efficacy of CBT for the different disorders have generally sought to answer some common questions. Researchers often begin to explore whether CBT is an effective treatment for a particular disorder through “open-label” trials, wherein all participants in a study receive CBT and change is assessed from before to after treatment. Once it has been demonstrated that CBT is associated with improvement in the problem of interest, other essential questions with respect to its efficacy must be explored. First, is CBT more effective than no treatment? Second, how does CBT compare to other psychological treatments? Third, how does CBT alone compare to either medication alone or a combination of medication and CBT? Finally, if a treatment is shown to be effective, it is also important to establish whether it remains effective in the long term once active interventions (e.g., therapy sessions) have been discontinued.

A. Mood Disorders

As noted earlier, CBT was first developed as a treatment for depression. CBT for depression has been shown in numerous studies to be more effective than no treatment at all and more effective than nonspecific treatments (those not specifically targeted at depression). CBT has also been shown to be at least as effective as, or more effective than, other psychological and pharmacological treatments. Also of note, CBT seems to reduce the risk of experiencing subsequent depressive episodes following treatment.

Despite a long and relatively successful tradition of using CBT to treat depression, this approach does not

seem to be a “cure-all” and not all research studies have provided strong endorsements. The National Institutes of Mental Health (NIMH) Treatment of Depression Collaborative Research Program compared CBT to interpersonal psychotherapy (IPT) (a treatment developed specifically for depression by Myrna Weissman, Gerald Klerman, and colleagues that focuses on the relationship between mood and life events, particularly those related to interpersonal relationships), the tricyclic antidepressant imipramine, and pill placebo. All three active treatments performed equally well, with a little over 50% of participants who completed all 16 weeks of treatment experiencing a significant response. Although CBT was slightly more effective than the other active treatments for people with less severe cases of depression, it fared less well for people with more severe cases. Furthermore, the three active treatment groups did not differ in terms of relapse rates 18 months after treatment had ended. Although a greater percentage of responders in the imipramine group ended up relapsing as compared to responders in the CBT and IPT groups, it should be noted that these latter two groups relapsed at the same rate as participants in the placebo group.

In a more recent study, Steven Hollon and his colleagues compared the efficacy of 12 weeks of CBT alone, imipramine alone, a combination of CBT and imipramine, and 12 weeks of imipramine followed by another year of active drug treatment. After 12 weeks, the groups did not differ. At 2-year follow-up, the participants who had taken only 12 weeks of imipramine fared worse than all of the other groups. This study also demonstrated that CBT worked well, and its efficacy was not improved by the addition of imipramine. In contrast to the NIMH Treatment of Depression Collaborative Research Program described above, more severely depressed participants responded as well to CBT in this study as did the less depressed participants.

Although the use of CBT as the sole treatment for unipolar depression has certainly been advocated, CBT is viewed as an adjunct to pharmacotherapy in the treatment of bipolar disorder. At the current time, very few studies have been conducted, but researchers are taking a greater interest in the application of CBT to this disorder. Monica Ramirez Basco and John A. Rush have published a CBT treatment manual for bipolar disorder that should facilitate research. Furthermore, a federally funded, multisite study is currently under way that is exploring the relative efficacy of CBT, IPT, and family-focused therapy for bipolar disorder.

B. Anxiety Disorders

CBT, or components of it, have also been used for many years in the treatment of anxiety disorders. In general, CBT has been shown to be effective across the anxiety disorders. CBT is generally seen as *the* treatment of choice for specific phobia and has been used for this disorder for many years. Medication has not been shown to be effective for the treatment of specific phobias, nor have alternate psychological therapies.

Another successful application of CBT in the realm of anxiety disorders has been in the treatment of panic disorder. David M. Clark and his colleagues compared the efficacy of CBT, applied relaxation, and imipramine. Clients placed on a wait-list served as an additional comparison group to ascertain whether changes could be attributable to the simple passage of time. At the end of treatment, clients in all three active treatment groups were doing better than clients assigned to the wait-list control group, and CBT clients fared better than those who received applied relaxation or imipramine. Furthermore, at 15-month follow-up, the CBT group was still doing better than the other two treatment groups. The most notable finding was that between 6 and 15 months following treatment, 40% of the imipramine group relapsed, compared to only 5% of the CBT group.

In another large-scale study of the treatment of panic disorder, David H. Barlow, Katherine Shear, Jack M. Gorman, and Scott Woods compared the efficacy of CBT alone to imipramine alone and to a combined treatment (CBT and imipramine). The results of their study suggested that CBT and imipramine were both superior to pill placebo. Although imipramine produced a somewhat better quality of response than CBT, the latter was better tolerated and proved to be more effective in the long term. The combination of CBT and imipramine was not as promising as the investigators had expected. In fact, participants in the combination group experienced the highest relapse at follow-up, suggesting that the addition of CBT to drug therapy did not protect against the relapse that has been associated with withdrawal from drug therapy in past studies of panic disorder clients. It is interesting to note, however, that there are studies suggesting that CBT can be very useful in helping clients to withdraw from benzodiazepines, antianxiety drugs commonly used in the treatment of panic disorder. In short, CBT has been shown to be very effective in the treatment of panic disorder, particularly in terms of long-term efficacy. Recent studies have also suggested that a shorter course of CBT for panic disorder using

self-study modules may be as effective as longer courses of treatment.

CBT has also been shown to be as effective as alternative treatments for social phobia, when delivered in either individual or group format. Richard G. Heimberg, Michael R. Liebowitz, and their colleagues have compared the efficacy of cognitive behavioral group therapy (CBGT) to that of the monoamine oxidase inhibitor phenelzine. For comparison, some participants in this study were assigned to either pill placebo or to a psychotherapy control condition (educational supportive group therapy). The general finding from their study was that clients taking phenelzine improved more quickly than did clients who received CBGT, but CBGT seemed to be more effective in terms of long-term efficacy once treatment had ended. The same research team is now exploring the efficacy of combined treatment (CBGT and phenelzine) for social phobia.

A highly successful approach to treating obsessive-compulsive disorder (OCD) is through the use of exposure plus response prevention (EX/RP, described earlier). Since the utility of EX/RP was first explored in the late 1960s, the approach has gained ample empirical support, with the combination of exposure *and* response prevention proving to be more effective than either component alone. Although certain medications [particularly clomipramine and some of the serotonin reuptake inhibitors (SRIs)] seem to be modestly effective in the treatment of OCD, continued success depends on continued use, suggesting (as in other anxiety disorders) that CBT might be a more effective treatment than medication in the long term. Isaac M. Marks and his colleagues have explored the efficacy of combined treatments (clomipramine and EX/RP) for OCD. In general, his studies have suggested that EX/RP is a more powerful, and a more long-lasting treatment than clomipramine and that the combination of the two treatments has only a small and short-lived additive effect. The issue of the combined treatments in OCD is also being explored in an ongoing study by Michael Liebowitz, Edna Foa, and Michael Kozak. In line with Marks's findings, preliminary data suggest that EX/RP is superior to medication alone and the combination of medication and EX/RP does not seem to be superior to EX/RP alone.

In contrast to the other anxiety disorders, treatment for generalized anxiety disorder (GAD) is still in its infancy and furthermore, while treatment for GAD (including CB-type treatments) is more effective than no treatment at all, comparative studies have failed to find differences between active treatments. Many factors

have contributed to the relative slowness in the development of treatments for GAD. First, the diagnostic criteria for GAD have changed a great deal over time. Uncontrollable and excessive worry was not specified as the core feature of the disorder until 1994. As such, past treatments have included nonspecific interventions, such as relaxation training and biofeedback, rather than interventions specific to treating uncontrollable and excessive worry. In line with changes in the diagnostic criteria, there have also been major changes in the way that people understand the etiology and maintenance of GAD. Newer treatments place greater emphasis, for example, on the important role of emotion in GAD. These developments are greatly informed by current cognitive models of the disorder, like that of Tom Borkovec and his colleagues, which suggests that worry functions as a means of avoiding more emotionally laden, painful thoughts. Over the next few years, continued research into the nature of GAD may lead to the development of exciting new treatments for this disorder.

There have also been few controlled studies of CBT as a treatment for posttraumatic stress disorder (PTSD). However, various approaches based on CBT have been used to treat the disorder with encouraging results. These approaches have included stress inoculation training (SIT), a treatment originally developed by Donald Meichenbaum. In SIT, clients are first helped to make sense of the trauma that they endured and to understand the responses that they are experiencing to their trauma (in terms of cognition, behavior, and physiology). Clients are then taught coping skills to increase their sense of efficacy and to help them to feel that they have gained mastery over their fears. Coping skills are targeted at alleviating physiological symptoms (e.g., through muscle relaxation), cognitive symptoms (e.g., through guided self-dialogue), and behavioral avoidance (e.g., through modeling and role playing). Dean G. Kilpatrick and his colleagues found SIT to be effective in uncontrolled case studies but since this initial work, it has not been found to be superior to other treatments, particularly in the long term where exposure therapy seems to show greater efficacy.

Edna Foa and her colleagues have explored the use of exposure therapy for PTSD with particular focus placed on treating rape-related trauma. Their treatment, referred to as prolonged exposure, is premised on the assumption that PTSD occurs when people do not adequately process their rape experience. As such, treatment must involve processing the trauma by, in effect, exposing the client to the memories of the trauma until a fear response is no longer elicited. Foa and her col-

leagues have found that clients enrolled in prolonged exposure do better than clients on a wait-list and that prolonged exposure is more effective than SIT in terms of long-term efficacy. Patricia A. Resick and Monica K. Schnicke have also used a CB approach to treating PTSD in victims of sexual assault. Their cognitive processing therapy (CPT) involves both exposure and cognitive-restructuring techniques, with the latter based on the assumption that the experience of sexual assault is incongruent with schemas that were held prior to it. As such, CPT involves dealing with thoughts pertaining to such issues as danger, safety, intimacy, and competence. Studies have shown that clients enrolled in CPT do better than those on a wait-list, and CPT seems to have good long-term efficacy.

C. Bulimia

Bulimia nervosa has been treated with CBT for many years, beginning with the work of Christopher G. Fairburn in the 1970s. CBT has been associated with reductions in frequency of binge eating and purging, levels of dietary restraint, and concern over shape and weight. Furthermore, CBT for bulimia has been shown to improve general functioning (including social functioning) and to increase self-esteem. As in the case of the anxiety disorders, CBT for bulimia seems to be effective in the long term, suggesting that clients learn skills that they can continue to apply on their own once treatment has ended. In comparison studies, CBT has been shown to be more effective than alternative therapies, drug therapies or a combination of drug therapy and CBT. The one treatment besides CBT that seems to hold particular promise for individuals with bulimia is IPT (described above). Fairburn and his colleagues compared CBT and IPT and found that although CBT seemed to work more quickly than IPT, the efficacy of the two treatments evened out during the follow-up period. It is interesting to note that IPT in that study was (as in the treatment of depression) focused on interpersonal relations, not on the eating disorder, suggesting that there is more than one way to foster improvement in eating disorder symptomatology.

D. Alcohol Use Disorders

CBT has also been applied to the treatment of alcohol problems. Alcohol use is viewed as a learned behavior that can be modified once a clear understanding is reached of the antecedents and consequences of its use. Several successful treatments have been developed

with roots in CBT. Behavior self-control training (BSCT) is a treatment aimed at teaching clients self-regulation strategies. Although the goal of BSCT can be abstinence, the more common goal is moderation. Focus is placed on engaging in self-monitoring as a means of understanding motives underlying drinking, learning ways to cut back on drinking, and developing more adaptive coping skills with which to replace drinking. BSCT has been shown to be more effective than no treatment and at least as effective as treatments aimed at complete abstinence. William R. Miller and his colleagues also found that BSCT had good long-term efficacy for individuals with moderate drinking problems.

As mentioned earlier, RP is an essential part of CBT for all disorders, but the strategy was initially developed for the treatment of people with alcohol use problems by G. Alan Marlatt. Drawing from research on self-efficacy, RP is based on the premise that the probability of relapse can be predicted by client's perceptions of their abilities to handle difficult situations. RP can be easily integrated into other treatments. Over the course of RP, clients are taught to identify high-risk situations and to use cognitive and behavioral coping strategies when they find themselves in such situations. Furthermore, cognitive techniques are used to help clients deal with inevitable lapses. Clients are taught to view a lapse as a one-time mistake, rather than a sign that they have failed or that they are failures. If clients come to view lapses in this way, a single lapse will be unlikely to evolve into a full-blown relapse. James R. McKay and his colleagues explored the efficacy of RP in a sample of clients who had completed behavioral marital therapy, a CB treatment for alcohol abuse that includes the client's spouse. Their study showed that low self-efficacy at the end of behavioral marital therapy was related to a greater likelihood to relapse—but only in the group of clients that did not receive RP treatment as an adjunct to therapy.

E. Other Applications

Treatments based on CB approaches have also been demonstrated effective in the treatment of other psychological disorders (e.g., other substance use disorders, borderline personality disorder, sexual dysfunction) as well as other problems with living (e.g., couples distress). Interested readers can find more detailed information in books included in the Further Reading list.

IV. SUMMARY

Cognitive behavioral therapy is an integrative therapeutic approach that assumes that cognitions, physiology, and behaviors are all functionally interrelated. This model posits that client's emotional or behavioral distress is influenced by the manner in which they perceive, manipulate, and respond to information within their cognitive system. Treatment is aimed at identifying and modifying biased or distorted thought processes, attitudes and attributions, as well as problematic behaviors via techniques that actively involve the client's participation, such as self-monitoring, cognitive restructuring, and hypothesis testing. As such, the treatment goal is to develop a more rational and adaptive cognitive structure, which in turn is seen as a pathway to improving both affect and maladaptive patterns of behavior.

See Also the Following Articles

Anxiety Disorders: Brief Intensive Group Cognitive Behavioral Therapy ■ Behavior Rehearsal ■ Behavior Therapy: Historical Perspective and Overview ■ Cognitive Appraisal Therapy ■ Cognitive Behavior Group Therapy ■ Eating Disorders ■ Exposure ■ Matching Patients to Alcoholism Treatment ■ Mood Disorders ■ Post-Traumatic Stress Disorder ■ Schizophrenia and Other Psychotic Disorders

Further Reading

- Bandura, A. (1977). *Social learning theory*. Englewood Cliffs, NJ: Prentice-Hall.
- Barlow, D. H. (Ed.). (2001). *Clinical handbook of psychological disorders, third edition*. New York: The Guilford Press.
- Beck, A. T. (1976). *Cognitive therapy and the emotional disorders*. New York: International Universities Press.
- Beck, A. T., Rush, A. J., Shaw, B. F., & Emery, G. (1979). *Cognitive therapy of depression*. New York: The Guilford Press.
- Beck, J. S. (1995). *Cognitive therapy: Basics and beyond*. New York: The Guilford Press.
- Clark, D. M., & Fairburn, C. G. (Eds) (1997). *Science and practice of cognitive behaviour therapy*. New York: Oxford University Press.
- Ellis, A. (1962). *Reason and emotion in psychotherapy*. New York: Stuart.
- Hope, D. A., Heimberg, R. G., Juster, H., & Turk, C. L. (2000). *Managing social anxiety: A cognitive-behavioral therapy approach (client workbook)*. San Antonio, TX: The Psychological Corporation.
- Kendall, P. C. & Hollon, S. D. (Eds.). (1979). *Cognitive behavioral interventions: Theory, research and procedures*. New York: Academic Press.
- Persons, J. P. (1989). *Cognitive therapy in practice: A case formulation approach*. New York: W.W. Norton & Co.



Collaborative Care

Nicholas A. Cummings

University of Nevada, Reno and the Foundation for Behavioral Health

- I. Collaboration as a Range of Concepts
- II. The Traditional Models of Collaboration
- III. The Two Integration Models of Collaboration
- IV. Barriers to Collaborative Care
- V. Examples of Population-Based and Disease-Based Integrated Therapies
- VI. The Future of Psychotherapy as Integrated Primary Behavioral Care
- VII. Summary
Further Reading

GLOSSARY

collaboration The practice in which health professionals from two or more disciplines cooperate in the diagnosis, treatment, and disposition of an individual patient.

co-location The collaborative model in which a behavioral health practitioner is actually located and functions within the primary care setting.

disease management The focus of a primary care team on a disease or diseases with the use of integrated programs of care (examples: asthma, depression, diabetes, hypertension, panic and anxiety disorder.)

hallway hand-off The term used for frequent, informal collaboration accorded by behavioral care providers being on co-location with primary care physicians.

integration, horizontal Programs that attempt to provide a general collaborative response to the diverse needs of the primary care population.

integration, vertical Programs that focus on a specific segment of the primary care population.

PCP A primary care provider who is usually a family medical practitioner, an internist, or a pediatrician. In some venues this term is extended to include nurse practitioners.

psychoeducational programs The term given to most vertical programs because they encompass a strong didactic component designed to inform the patient about the disease or condition.

referral The practice by a primary care physician of sending a patient to a specialist for diagnosis or follow-up services within that specialty.

specialist A physician or surgeon other than a primary care physician who has advanced training and standing in a specified area of practice, and is board certified in that field (examples: neurology, psychiatry, radiology, oncology, cardiology, psychology).

team The group of primary care physicians, behavioral health providers, nurse practitioners, and health educators serving the diverse needs of a primary care population (horizontal integration) or those that provide programs that are focused on a segment of that population (vertical integration).

triage The practice of determining the appropriate service, specialty, or community resource for an individual patient or segment of patients.

I. COLLABORATION AS A RANGE OF CONCEPTS

For the most part, collaboration is an occasional or infrequent occurrence. Defined as cooperation regarding the diagnosis and/or treatment of an individual patient

among two or more practitioners from different health fields, such laissez-faire arrangements fall short of today's expectations among those in medicine who advocate a closer working relationship among the various care disciplines. But even if this basic definition is accepted as valid, there is essentially an absence of collaborative care in the way medical practice is currently conducted. In most practices the primary care physician makes a referral to a specialist who then assumes responsibility for that aspect of the patient's care. Interaction with psychologists is usually a referral for psychodiagnostic testing, the results of which go back to the primary care provider (PCP) who makes the final disposition, or the patient is referred for psychotherapy to a separate mental health system. The relationship is usually from physician in independent solo or group practice referring to a mental health specialist also in solo or group practice. Some physicians who refer a patient for psychotherapy ask for occasional feedback, but most do not.

In the current managed health care climate there is considerable discussion accorded the concept of collaboration, but most of the movement toward a meaningful goal is largely lip service. The interest in the subject is usually sparked by psychologists and other mental health professionals who are looking for ways to expand their declining practices. Nonetheless, professional planning meetings will devote some time to the discussion of collaboration, often laughingly described as an unnatural act between two nonconsenting adults. Two organizations, however, were founded to promote collaboration. The first of these is the National Academies of Practice (NAP), founded in 1981 and composed of 10 Academies that are recognized by the federal and state governments for independent, reimbursable practice: Dentistry, Medicine, Nursing, Osteopathic Medicine, Optometry, Pharmacy, Podiatric Medicine, Psychology, Social Work, and Veterinary Medicine. Each Academy is composed of no more than 100 Distinguished Practitioners, chosen because they have received all the honors of their profession and are now prepared to disregard turf in the interest of the national health. The NAP essentially views collaboration as the cooperation among two or more professionals from different disciplines who are in independent, and most often solo practice. It publishes a journal on collaborative care, the *National Academies of Practice Forum*.

A smaller, but more activist organization is the Collaborative Family Healthcare Coalition that was founded recently and publishes *Families, Systems and Health*. It conceptualizes collaboration as the integration of behavioral health into primary care, as will be discussed below.

II. THE TRADITIONAL MODELS OF COLLABORATION

Psychotherapists, and mental health professionals in general, have long worked closely with medical practitioners. Usually the physician has a psychologist or two who are highly regarded and are the recipients of a stream of referrals. Occasionally this informal arrangement results in a physician/psychologist consultation on a difficult or unusual patient, or other forms of informal collaboration. The characteristic of the traditional model, however, is that two independent practitioners come together in a laissez-faire arrangement in the interest of better patient care.

This informal, independent relationship has at times been expanded in some arrangements to include innovative or unusual services. For example, a surgeon may ask that a stressed or fearful patient receive preoperative counseling in the hospital. Some dentists rely on psychotherapists to work with patients who manifest a severe fear of going to the dentist, and many psychologists are cultivating relationships with dentists with the same intensity that they do with physicians. Some psychologists specializing in the diagnosis of attention deficit and attention deficit hyperactivity disorders (ADD/ADHD) actually have regularly scheduled times in which they administer psychological tests in the neurologist's office. In all these arrangements the traditional characteristic prevails in which independent practitioners are collaborating.

Interestingly, some current arrangements between independent medical and psychological practitioners closely approach the integrated models to be discussed below. In one example a group practice of psychologists assigns its members to be on co-location in hospitals, working side by side with physicians on a regular schedule. In others psychologists are similarly assigned to be on co-location in outpatient settings, mimicking full integration except that being from two different entities the behavioral care practitioners lack decision-making authority and equity in the system being serviced.

III. THE TWO INTEGRATION MODELS OF COLLABORATION

The most far-reaching conceptualization of collaboration is that of the *integration* of behavioral health into primary care in a seamless, indistinguishable system. Actually this model encompasses two different models, both of which are compatible within the same setting,

and will be described separately below. These integration models are seen by many authorities to be the health delivery systems of the future, and they are currently being implemented in a number of large health systems in several states. The largest and most aggressive implementation is at Kaiser Permanente with its 2.4 million enrollees in Northern California. Others in varying stages of implementation include the Group Health Cooperative of Puget Sound (Washington), HealthPartners and Allina (both Minnesota), and HealthCare Partners (Southern California). These systems anticipate decreased costs, especially from medical cost offset through integrated behavioral care, as well as increased access, more appropriate care, and greater patient and provider satisfaction, all as value added. If these organizations (or even just one with a winning formula) attain these goals, the health system will move rapidly toward integration.

As previously mentioned, the integration model is really two compatible models. The first is horizontal integration, which seeks to provide a general response to the diverse needs of primary care. It, in itself, is a series of models, beginning with minimal integration and proceeding in intensity. At its simplest form horizontal integration may provide a toll free number where a PCP can obtain consultation on difficult patients on a 24-hour-a-day basis. For health systems that are not prepared for anything comprehensive, this telephone on-call can be plugged in quickly and with a minimum of disruption. Horizontal integration can proceed upward where the PCP can request specific behavioral health consultations to address medication and psychological treatment strategies, triage, treatment compliance, relapse prevention, lifestyle changes, and a multitude of other kinds of consultative services.

The midpoint in the increase of horizontal integration is co-location, where behavioral care providers are in primary care settings working side by side with PCPs. Extensive research has demonstrated the superiority of this model in patient acceptance of the referral for therapy. In the traditional referral model only 40% of those needing behavioral interventions are identified and referred for therapy. Of these, only 10% follow through and seek psychotherapy. Thus, in the usual primary care setting, only 4% of those needing behavioral care receive it. In the co-location model, where the physician walks with the patient a few steps down the hall to the psychologist's office and participates in a three-way 15-minute session (patient, PCP, and psychologist), 85 to 90% of these patients go into psychotherapy. Patient satisfaction is high, and patients

seemingly see the referral as within the medical system rather to an outside mental health system with its unfortunate stigma attached.

Physician satisfaction is equally high inasmuch as access to behavioral intervention is immediate, readily accepted by the patient, and effective in its outcome. This and the opportunity to catch a behavioral care provider for consultation in the setting at any time is called the hallway hand-off.

Proceeding upward through the scale of horizontal integration is the formation of teams consisting of PCPs, behavioral care providers, nurse practitioners, and health educators who are given the responsibility for all the health care (direct as well as referral to specialists) for a specified population cohort. In its ultimate form, there is an obliteration of departments of medicine, psychiatry, and nursing, and the team is a semiautonomous unit with its own budget and support staff.

Perhaps the most far-reaching example of this team approach is found in the retooling of the Kaiser Permanente system in Northern California. Its 2.4 million enrollees are being divided into cohorts of 20,000 enrollees, each having its own primary care team of physicians, psychologists, nurse practitioners, and a health educator. Kaiser anticipates achieving the advantages of "small group practice" while retaining the leverage and clout of a huge total enrollment.

The second type of integration, called vertical integration, focuses its programs on specific segments of the primary care population. These are usually segments that account for disproportionate medical costs, often because of psychological problems that accompany them, or because of noncompliance to medical regimen. The most frequent are group programs for arthritis, asthma, diabetes, hypertension, ischemic heart disease, and emphysema, which together account for 40 cents of the health care dollar in the age group of 18 to 55. Other programs focus on psychological problems that also result in high medical utilization. The most important of these is depression, from which at one time or another 40% of primary care patients will suffer. Other psychological group programs are panic and anxiety disorders, including agoraphobia, and pain management. The programs are conducted by the team and will be described in a later section.

The usual vertically integrated programs employ one or two, and at most three programs. A notable exception is found at Kaiser Permanente in San Jose, where over a dozen such program have been used successfully for almost a decade. There the psychologist who heads the Department of Behavioral Medicine works closely with the

head of the Department of Medicine in a joint endeavor that has often been regarded as a model to be emulated.

In a well-integrated primary care system, horizontal and vertical integration are not only compatible, but they are both indispensable. Most programs beginning the path to integration adopt one vertical program, such as depression, and make very hesitant moves toward expanding to additional vertical programs. Horizontal integration seems to proceed even slower, with the infusion of beginning consultation programs between PCPs and behavioral health providers, and a reluctance to proceed to the next step. Two factors are required to proceed on a well-scheduled integration program. The first is the ability to electronically track the financial and other benefits, a capacity most health systems lack. The second is the buy-in of both the medical and administrative leaders to the need for integration. In even the most determined systems, a satisfactory level of buy-in required to proceed appropriately from early to more advanced steps involves a minimum of 1 year.

IV. BARRIERS TO COLLABORATIVE CARE

There are a number of formidable barriers to collaboration, especially as these pertain to the more extensive concept of integration. Some are historic, whereas others are current, and they all involve economic, turf, or training issues. Social policy moves slowly; health care policy moves even more slowly. We are confronted by centuries of tradition, attitudes, beliefs, and biases, and at least one century of modern medicine in which allopathics and the biomedical model have contributed enormously, along with public health, to our longevity, well-being, and quality of life. This very success can mitigate against change. The following are the more apparent barriers to collaboration and integration.

A. Mind–Body Dualism

Descartes, the 16th century philosopher and physician, is regarded as the one who first admonished medicine that the mind and the body are separate. This dualism exists in various forms to this day. The lines of demarcation between separate departments of medicine and psychiatry have spawned a necessary profession known as liaison psychiatry that attempts to bridge the gap between the two specialties. The existence of liaison psychiatry underscores the dualism, and in providing a stop-gap response it perpetuates it.

Reductionism, which posits that disease can best be understood at the molecular level of biology and physiology is, along with the mind-body dualism, at the very heart of the medical culture and the basis for much of its past scientific progress. It disregards research in medical psychology that demonstrates the interplay between the body's tissues and their environment, and that along with genetics, lifestyles are integral to most modern diseases. Long before Descartes, Hippocrates argued that it is more important to know what kind of person has a disease, than what disease a person has.

B. Entrenched Behaviorism

Psychology in the United States has never completely overcome the heritage given it by John B. Watson, who maintained that at birth a child is a blank slate and that the environment can make of a child a genius or a criminal. Biology has not received appropriate attention by American psychology, which has self-opted out of what is now known as the genetic revolution. The ultimate psychosocial model is no more prepared to deal with DNA than the strict biomedical model can explain disease-producing behavior. Integration involves the sharing of turf on both sides of the mind–body dualism.

C. Financial Barriers

1. *Not Out of My Budget*

Little progress has been made in integrating behavioral and medical health care through arrangements in which money is pooled from either or both of the departmental budgets of medicine and psychiatry. In a few settings where PCPs are having difficulty managing “troublesome” patients who manifest a variety of behavioral problems, medical budgets have been used to cover a limited collaboration. This is usually done to relieve PCPs from being overburdened with these patients. More often, however, collaboration costs are expected to come from the psychiatric budget. Consequently, most collaborative efforts never get beyond the discussion stage because each department is guarding its own strained budget, not recognizing that integrated care yields a medical cost offset that can be shared. (For more information on health care financing, as well as medical cost offset, see “Economic/Policy Issues” in this *Encyclopedia*.)

2. *Resistance from the Carve-outs*

The delivery of behavioral care through separate companies known as carve-outs has grown to encom-

pass over 150 to 175 million Americans, depending on how populations are counted. Collaboration is problematic, and integration is next to impossible when the primary care system has a different ownership than the behavioral care system. Separate behavioral care delivery is currently a huge industry that pays lip service to “carving-in,” because serious consideration to do so lacks financial incentive and may actually reduce profits. This equity separation is the most formidable barrier, as integration (or the carve-in) can only be accomplished by dissolving the ownership of large for-profit companies, something that does not seem probable in the immediate future.

3. Resistance by Specialists

In the usual health care arrangement, the primary care system refers to specialists for care beyond the primary level. With the increases in capitation and risk pools, this means the primary care system can lose money if it overly refers to specialists, since these specialists are usually practitioners outside the primary care system that must still be reimbursed from the primary care system. The trend, therefore, is to do the front-end specialty work (such as minor surgery, as well as less severe gastroenterology, cardiology, pulmonology, and even oncology) right in the primary care setting. Consequently, PCPs are doing more of what previously was referred to specialists, nurse practitioners and physician assistants are doing more of the PCP’s work, lesser trained nurses are doing what previously required registered nurses, and so forth. The more primary care includes specialty practice, the fewer are the referrals to specialists. This trend increases with degrees of integration, and with the subsequent loss of turf, specialists understandably oppose integration arrangements and models. Among the most resistant of the specialists are practicing psychotherapists who prefer solo (separate) practice, and whose referrals would decrease in an integrated system.

D. What, More Training?

More than half of all behavioral care is delivered by PCPs who still miss as much as 80% of the patients who could benefit from such services. Clearly, PCPs need much more than the few hours of the lectures in psychiatry that are included in the 4-year medical school curriculum, and psychologists and social workers must be grounded in the biological sciences with further courses in neuroanatomy, neurology, and clinical medicine. Because of the overloaded curriculum in

both medical schools and graduate psychology and social work programs, there is strong opposition from academia, necessitating postgraduate training.

E. Primary Care Time Constraints

The average patient appointment with a primary care physician in the United States is 7 minutes. This is the result of the pressure to see more and more patients within the course of a day, leaving the physician no time to listen to the patient’s problems beyond the initial complaint. Research has shown that lifestyle problems that may be at the root of the patient’s physical disease do not emerge until well after the 7-minute limit. Every clinician fears opening the Pandora’s box and seeing the patient dissolve into tears and emotional turmoil while the waiting room is filled with patients with and without appointments. Under current managed care arrangements, there is an even greater pressure on the PCP to see more and more patients.

F. The One-on-One Complex

Traditional health care delivery, whether this be medical or behavioral, is based on a one-on-one relationship and responsibility between doctor and patient. When referral is made it is to a specialist who replicates the one-on-one arrangement. The resistance to changing this to the more team-oriented innovative and integrated therapies is enormous on both the parts of medicine and behavioral health. Arguments for the preservation of the system are couched in terms of the doctor–patient relationship and in confidentiality, regardless of the fact that integrated services have demonstrated that patients readily extend the doctor–patient relationship to the treating team, and are comfortable in trusting the matter of confidentiality to the same team.

V. EXAMPLES OF POPULATION-BASED AND DISEASE-BASED INTEGRATED THERAPIES

Integrated therapies are almost always group programs conducted by primary care teams and serve three functions with varying degrees among the various programs as to which is the primary in a specific model: treatment, management, and prevention. These programs are based on empirically derived protocols and are often called psychoeducational. These can be further described as disease-based programs that will be discussed

first, and population-based programs to be described later. The disease-based programs can be further delineated into those that address physical diseases (e.g., arthritis, asthma, diabetes, emphysema, hypertension, ischemic heart disease) and those that address psychological conditions (e.g., depression, panic/anxiety states, borderline personality disorder, agoraphobia, and multiple phobias).

A. Treatment

The surprising feature of psychoeducational group models is that they can be therapeutic, and for some conditions, more effective than traditional modes. Research indicates that the greatest therapeutic effect is most likely to be with lifestyles that reflect the patient's overscrupulousness: perfectionists, agoraphobics, adult children of alcoholics, and other conditions in which the patient suffers from overbearing neurotic guilt. Lesser therapeutic effect is seen in personality disorders, addicts, and other patients who are rebellious and challenge authority. These patients also manifest chaotic lifestyles and are noncompliant with medical or psychological regimens. Because these patients can also develop depressions, panic attacks, and other psychological conditions, it is important to separate them into their own psychoeducational groups where their chaotic lifestyles and rebelliousness can not only be addressed, but also will be prevented from disrupting the treatment of the nonchaotic patients.

B. Management

In chronic medical conditions such as arthritis, asthma, diabetes, hypertension, and other diseases, the goal is not to cure that which cannot be cured. This does not mean that reduction in pain and morbidity are not in themselves therapeutic; the emphasis, however, is in disease management. It is with these intractable conditions, medical and psychological, that management is important. Patients with physical diseases are taught how to comply with medical regimens; monitor their own condition; reduce stress through relaxation, imagery, and other stress management techniques; and provide a support system for each other. Most so-called Axis II patients can learn impulse control so that they become more manageable and less vulnerable to the consequences of their own emotional lability. Schizophrenics are also incurable, but they can learn independent living as well as techniques to prevent the

"crises" that provoke acute exacerbation requiring hospitalization. All management programs have in common the increased coping skills of the various patients represented in the widely differing conditions.

C. Prevention

The remarkable finding is that for appropriate patients assigned to appropriate psychoeducational programs, the demand for more intrusive services is significantly, if not dramatically, diminished. This is true prevention: Services are no longer needed (i.e., the "demand" side in health economics), as contrasted with reducing services as found in most cost containment (i.e., the "supply" side in health economics). Reducing costs by reducing demand is certainly more desirable than rationing care, and is the very essence of both prevention and cost containment. Hospitalization, the costliest health care, can be reduced for patients suffering from chronic medical conditions, schizophrenia, and borderline personalities. The latter characteristically threaten suicide, necessitating hospitalization as a precaution. Further more, patients in these programs learn skills instead of taking pills, thus reducing the skyrocketing cost of pharmacology. The support system replaces the patient's need for frequent emergency room visits, and it has been found that these programs significantly reduce the need and demand for costly, protracted individual psychotherapy.

D. Elements of Psychoeducational Programs

There are a number of elements that psychoeducational programs have in common, although not every protocol will contain each and every one of the following:

An educational component from which the patient learns a great deal about the medical or psychological condition, as well as the interplay between one's body and emotions.

Pain management for those populations suffering from chronic pain. This includes help in reducing undue reliance on medication and addressing any problems of iatrogenic addiction.

Relaxation techniques, which include meditation and guided imagery.

Stress management, adjusted to meet the needs of specific conditions and populations.

A support system, which includes not only the group milieu, but also the presence of "veterans" who have been through the program. A useful modification of

this element is the pairing of patients into a “buddy system” that allows them to call each other in time of need.

A *self-evaluation component*, which not only enables the patient to assess how well he or she is doing psychologically, but also teaches the patient to monitor such critical features as blood pressure, diet, insulin, and other signs important in chronic illness.

Homework is assigned after every session. The homework is carefully designed to move the patient to the next step of self-mastery, and may include desensitization, behavioral exercises, planned encounters with one’s relationships or environment, readings, and other assignments that are critical to the well-being of the patient. The homework is never perfunctory. It is always relevant to the condition being treated and well timed to enhance development.

Timing, length, and number of sessions vary from protocol to protocol, reflecting the needs of each population or condition, and in accordance with research and experience.

Treatment of depression for those patients whose severely altered mood is interfering with their ability to participate in the program.

Self-efficacy (after Albert Bandura), refers to the belief that one can perform a specific action or complete a task. Although this involves self-confidence in general, it is the confidence to perform a specific task. Positive changes can be traced to an increase in self-efficacy brought about by a carefully designed protocol that will advance the sense of self-efficacy.

Learned helplessness (after Martin Seligman) is a concept that holds that helplessness is learned and can be unlearned. Some patients with chronic illnesses fall into a state of feeling helpless in the face of their disease. A well-designed protocol will enable a patient to confront and unlearn helplessness.

A *sense of coherence* (after Anton Antonovsky) is required for a person to make sense out of adversity. Patients with chronic physical or mental illness feel not only that their circumstances do not make sense, but neither does their life. The ability to cope often depends on the presence or absence of this sense of coherence, and the protocol should be designed to enhance it.

Exercise is an essential component of every protocol, and is the feature that is most often neglected by patients. Exercise helps ameliorate depression, raises the sense of self-efficacy, and promotes coping behavior. The patient should be encouraged to

plan and implement his or her own exercise regimen and then to stick to it.

Modular formatting enables a protocol to serve different but similar populations and conditions by inserting or substituting condition-specific modules. Well-designed protocols permit and even augment a practice called “mixing and matching.”

E. Population-Based Programs

Programs that utilize all or most of the medical and psychological protocols within a specific population do so because that population is often best addressed as a cohort or entity. One of the most successful such programs is the Teenage Clinic at Kaiser Permanente in San Francisco which for several decades has treated adolescents by their parents’ consent without the parental presence or control usually found in pediatrics. Teams of pediatricians, behavioral health practitioners, and nurse practitioners have demonstrated that this population-based arrangement significantly reduces teenage pregnancy, drug abuse, and sexually transmitted diseases. These successes are attributed to the opportunity accorded teenagers to discuss issues they fear mentioning to their parents and to a team that includes providers highly trained and experienced in the integration of adolescent psychology and primary care.

Integrated substance abuse programs meld addiction treatment with most or all of the protocols previously described, addressing the nearly universal comorbidity that is characteristic of addicted patients. Integrated substance abuse programs have protocols in food and gambling addictions along with the usual chemical addiction approaches. In this way psychological and medical conditions are treated in an appropriate manner in which the treatment of the substance abuse remains paramount, whereas in the usual primary care setting the primacy of the addiction treatment might well be subordinated.

Because the needs of older adults tend to be so different from those of the general populations, separate Medicare programs are growing in popularity. These patients face higher rates of chronic illness, and even terminal illness for themselves or their spouse than are found in the general population. Marital, occupational, parenting, and other issues common to younger adults are of little importance, while bereavement, loneliness, alienation, and physical/psychological limitations are at the forefront.

VI. THE FUTURE OF PSYCHOTHERAPY AS INTEGRATED PRIMARY BEHAVIORAL CARE

The next frontier in organized health care delivery is the integrated program where behavioral health is an integral part of primary care. As these integrated programs increase in numbers, traditional psychotherapy practice (whether solo or in small groups) will continue to decline while opportunities in health psychology will abound. Several large-scale health care systems are in the process of integrating. The nation's largest HMO has launched a major retooling after which 2.4 million covered lives will be divided into 20,000 person cohorts, each served by integrated teams of primary care physicians, behavioral health providers, nurse practitioners, and health educators. As these programs continue to report medical cost offset savings, more effective care, financial enhancement, and high patient and provider satisfaction, there will be a national acceleration in the integration of health care. Co-location will be the typical arrangement, with behavioral health providers practicing in close collaboration with primary care physicians.

The behavioral health provider of the future will need training quite different from that offered now in most graduate programs. The curriculum of the future will be heavily weighted with courses in medical psychology, behavioral medicine, outcomes research and program planning, finances, and administration. Proficiency in group psychoeducational protocols that are both disease- and population-based will replace the current emphasis on individual psychotherapy. Although psychoeducation will never fully replace individual psychotherapy, experience in currently integrated large-scale programs would predict that the following proportions of the psychotherapist's time will prevail in the not too distant future: 25% individual psychotherapy, 25% time-limited group therapy, and 50% psychoeducational programs. Several health care settings are already reflecting this configuration. Extrapolating this time allocation, taking into account that eight or more patients are seen in groups during the time required to see just one individual patient, 90% or more of patients will be treated in models reflecting group protocols.

VII. SUMMARY

Collaboration refers to a range of concepts, but it always involves cooperation in diagnosis and treatment of an individual patient by two or more practi-

tioners from different fields of health care. For the psychotherapist, its simplest form is an informal arrangement for referral and consultation between a behavioral specialist and a primary care physician or other medical specialist. Each is otherwise independent of the other and each bills the patient or the third party payer separately for the services provided. This traditional concept of collaboration is sometimes expanded to include innovative or unusual services provided by the behavioral care specialist on a regular basis. For example, a surgeon may wish preoperative counseling in the hospital for each patient. Or a neurologist may wish the regular scheduled presence of a psychologist to conduct testing with cases suspected of ADD/ADHD.

There are two integration models of collaboration, known as horizontal and vertical integration, which differ but can be compatible in the same health care delivery system. With true integration, however, the health care system requires successive degrees of intensity as it becomes more comprehensive and complex. Horizontal integration may proceed from a simple 24-hour consultation telephone number available to all physicians, through co-location where the behavioral practitioner works side by side with primary care physicians, to complete integration in which health care is provided by teams of practitioners that include behavioral care practitioners.

Vertical integration focuses its programs on specific segments of the primary care population, and especially for those in which psychological problems are accompanied with high medical costs. These are termed population-based, or disease-based programs. The most frequent group programs are for chronic medical conditions, such as arthritis, asthma, diabetes, hypertension, ischemic heart disease, and emphysema, all of which manifest a strong psychological component often expressed by noncompliance with their medical regimen. Other group programs address essentially psychological programs that complicate the medical system. These include borderline personality disorder, agoraphobia and multiple phobias, panic and anxiety disorder, and pain management. Health care systems utilizing both horizontal and vertical integration are relatively recent, but may be the forerunner of the future in collaborative care.

Barriers to collaborative care are centuries of mind-body dualism reflected in separate departments of medicine and psychiatry (or psychology). From the psychological standpoint, American behaviorism lags behind in the integration of the physical into its psy-

chological theories. It can be said that all specialties, medical as well as psychological, inadvertently preserve the separation by zealously guarding their individual turf. The most formidable barriers, however, are financial. These range in the usual health setting from the not-out-of-my-budget mentality to the prevalence today of behavioral care carve-outs that perpetuate organizational separation.

Population and disease-based integration has developed a number of group programs that have both a psychotherapeutic and a psychoeducational component, and consistently share a number of characteristics in their protocols. These characteristics have all three essential elements: treatment, management and prevention.

See Also the Following Articles

Bioethics ■ Cancer Patients: Psychotherapy ■ Informed Consent ■ Integrative Approaches to Psychotherapy ■ Medically Ill Patient: Psychotherapy ■ Neurobiology

Further Reading

- Blount, A. (Ed.). (1998). *Integrated primary care: The future of medical & mental health collaboration*. New York: W.W. Norton.
- Cummings, N. A., Cummings, J. L., & Johnson, J. N. (Eds.). (1997). *Behavioral health in primary care: A guide for clinical integration*. Madison, CT: Psychsocial Press (an imprint of International Universities Press).
- Goleman, D., & Gurin, J. (Eds.). (1993). *Mind-body medicine*. Yonkers, NY: Consumer Reports Books.

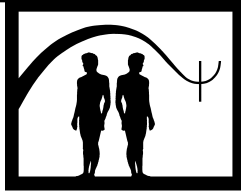

Communication Skills Training

David Reitman and Nichole Jurbergs

Louisiana State University

- I. Description of Treatment
 - II. Theoretical Bases
 - III. Empirical Studies
 - IV. Summary
- Further Reading

peal. For example, recent modifications of CST for persons with developmental disabilities have proven valuable in the treatment of challenging behavior associated with limitations in communicative ability and useful in promoting choice.

GLOSSARY

feedback Information provided to an individual following a response that is intended to promote the acquisition of behavior.

modeling Action performed by a therapist or coach to illustrate important elements of a response requiring imitation by clients or patients. Feedback and instructions are also used to shape the behavioral repertoire to approximate more closely the actions of the model.

Communication skills training (CST) promotes problem-solving skills by teaching patients to resolve disputes through restructuring their attitudes, adopting and adhering to new rules of social interaction, and clearly expressing and receiving meaning. In CST, therapists frequently combine elements of behavioral, family systems, humanistic, and other approaches to reduce interpersonal problems. Although initially developed in the context of family interaction (e.g., spouse to spouse, or parent to adolescent), in recent years the approach has been found to have broad ap-

I. DESCRIPTION OF TREATMENT

Communication skills are vital for achieving goals through social interaction. CST emphasizes pragmatics, communication in a social context, and can be useful in a wide range of treatment programs for many types of individuals and situations because of a diverse, yet sound conceptual and empirical base.

As it is most commonly known, CST is used to teach problem-solving skills, most frequently to help resolve parent-adolescent and marital conflict. Because of the diversity of programs, it is useful to identify specific operations common to all CST. First, most CST seeks to promote the clear expression and reception of meaning. Effective problem-solving requires minimizing negative communication habits and speeds the process of arriving at mutually favorable solutions. By contrast, emotionally charged accusations, frequent changes of topic, and interruptions frequently impede the promotion of clear communication. CST also attempts to teach the individual how to restructure attitudes (e.g., zero-sum or all or nothing thinking) that may inhibit or derail effective problem-solving. Second, CST trains

families in reflective listening (i.e., relating perceived meaning back to the speaker) in an attempt to enhance the behavioral component of problem-solving. Moreover, ensuring that clients take an active role in trying to understand one another minimizes the likelihood that a “nonparticipant” will seek to undermine solutions. A third dimension of CST focuses attention on the quality of family relations. In general, CST emphasizes a democratic approach to family relations. Issues are raised and clarified through mutual agreement and the rights of all parties are respected in arriving at a solution (i.e., equalization of decision-making power).

An early example of the CST approach is the four-step model introduced by Arthur L. Robin, Sharon L. Foster, and colleagues as a component of their problem-solving communication training (PSCT) for parents and adolescents. During the first of a course of four to six sessions, families are introduced to the model. Specifically, families are told to (1) define the problem concisely without accusations, (2) brainstorm alternative solutions, (3) evaluate solutions by listing their positive and negative consequences and deciding on a mutually satisfactory agreement, and, finally (4) specify the actions required to implement the solution. This training also involves the therapist’s provision of feedback, modeling, and behavioral rehearsal (i.e., role-play) to correct negative habits. Families are also taught to self-monitor negative communication patterns such as interruptions, lack of eye contact, and sarcasm, and to replace them with more effective behaviors such as maintaining eye contact, active listening, verification of meaning, appropriate voice tone, and appropriate nonverbal posturing (e.g., leaning slightly forward to indicate interest).

At each session, a specific problem, such as chore completion, curfew obedience, or homework compliance, is discussed. Therapists then help guide families through a structured discussion and intervene when family members stray from the four-step guidelines. Therapist prompts may be in the form of a discussion of the inappropriate behavior, demonstration of more appropriate behavior, or direct feedback about the error. Often, family members are uneven in their mastery of the communications skills and will receive additional feedback and instruction during the sessions. Cognitive restructuring (i.e., challenging or reframing maladaptive thoughts) and planning for the generalization of treatment gains through homework assignments are also common features of PSCT.

Applications of CST to marital and relationship problems have been theoretically diverse and include systems-oriented and social-learning approaches. One

of the best known interventions for relationship problems, behavioral marital therapy (BMT), represents an application of reinforcement principles to problems encountered in romantic relationships. Over the years, BMT has been broadened by Neil Jacobson and colleagues to include other features; however, the core of BMT appears to be the promotion of “support-understanding techniques” and problem-solving training. Support-understanding techniques encourage collaboration and positive affect. For example, each partner might first generate a list of behaviors that they would like their partner to perform. Subsequently, each partner agrees to perform three of the actions from their partner’s list. Problem-solving techniques are very similar to those described by Robin and Foster.

Couple Communication is a recent example of a systems-oriented program designed by Sherod Miller and Peter A.D. Sherrard to teach important communication skills to couples in conflict. Its three main goals are to help couples communicate more effectively about day-to-day issues, manage and resolve conflicts more effectively, and to help build a more satisfying relationship. The intervention model aims to increase awareness of the relationship, teach skills for communicating more effectively, expand options for enriching the relationship, and increase satisfaction with the relationship itself. Although incorporating many features of more experiential and family-systems therapies (i.e., employing the use of skill mats to promote kinesthetic learning), the program is notable for its systematic incorporation of feedback, coaching, and contracting and shares these features with the model promoted by Robin, Jacobson, and others.

CST can be useful in helping patients with disabilities such as mental retardation or autism to communicate effectively in social settings. Although significant modifications are required to adapt CSTs for the communication impaired and developmentally disabled, Fred P. Orelove and Dick Sobsey have outlined a program to teach basic functional communication to children with severe or multiple disabilities. Before implementing such a program, four decisions must be made: (1) which communication functions would be most useful to the individual, (2) what specific content or messages should be communicated, (3) which form (mode) of communication should be selected—vocal, gestural, or graphic, (4) how each item should be taught. After these decisions have been made, a program of assessing and teaching specific patterns of communication can be implemented based on five fundamental principles: maximization (striving for the greatest increase in appropriate communication), functionality (focusing on social outcomes), individualization (uniquely assessing

each child and what he or she requires), mutuality (aiming at both communication partners and their context assessment and intervention), and normalization (teaching common communication unless there is an undeniable benefit to the individual in teaching different skills). Another program, designed by Laura G. Klinger and Geraldine Dawson, is intended to facilitate social interaction, specifically for children with autism. It comprises two strategy levels and is based on the five general principles outlined by Orelove and Sobsey. Level One involves facilitating attention to people, social contingency, and turn-taking. Level Two targets imitation, early communication, and joint attention skills. These strategies may be implemented by parents, teachers, psychologists, and other developmental specialists.

Interventions have also been designed based on the premise of teaching communication skills as an alternative to challenging behavior. In their review of functional communication interventions, David P. Wacker and Joe Reichle describe a number of simple and effective programs that involve two common steps. First, factors maintaining problem target behaviors must be identified. Second, the maintaining factors (e.g., rewards) must be made available only when the specified appropriate communicative response is made. These interventions are performed in three general phases: assessment, initial intervention, and expanded intervention aimed at generalizing and maintaining outcomes. V. Mark Durand and colleagues have explored several factors that increase the success of functional communication training in reducing challenging behavior. The four main factors are response match, response mastery, response milieu, and the consequences of the challenging behavior. "Response match" means that the newly trained response should produce the same consequence as the targeted challenging behavior. For example, raising a hand should garner attention in the same way that striking a peer would have prior to training. Other concepts such as "response mastery" and "response milieu" speak to the importance of ensuring that the newly trained functional communication response becomes more efficient in producing changes in individual's environment than the formerly high-frequency problem behavior. Taken together, the diverse applications of CST are impressive in scope.

II. THEORETICAL BASES

Communication skills training has gradually evolved from a treatment approach focused on reducing family

conflict to a much broader array of therapies concerned with the resolution of human conflict in areas ranging from the home to business and institutional settings. The initial conceptual underpinnings of CST, however, spring from a humanistic, social-learning perspective suggesting that conflict is often produced by perceived differences in power. As originally conceptualized by Robin and colleagues, PSCT suggests that adolescents initially argue with their parents in a developmentally appropriate quest for independence. Unfortunately, overly "authoritarian" responses from parents sometimes lead to increased conflict. Reacting in a more "democratic" manner, that is, emphasizing mutual solutions and the equalization of decision-making power, replaces negative communication with a social environment more likely to yield solutions to problems arising in parent-child relations. This early form of CST was based on the principles of behavior modification, experimental problem solving, and effective communication.

Behavioral marital therapy emerged most directly from reinforcement and social learning theory. The early BMT notion of behavioral exchange was modeled on behavioral formulations of the marital relationship in terms of contingency contracting and seeking to foster changes in partner behavior. In more recent years, BMT has expanded to incorporate a theoretically diverse number of treatment techniques, including a greater focus on communication and problem-solving skills, and more acceptance-based procedures. The Couple Communication program is based on systems-theory concepts and principles. Viewing a relationship as a "system," and more specifically as a "self-managing-adaptive system," implies that relationships are not static and that the behavior of the partners constitutes the dynamic of their relationship. The Couple Communication program and the concepts and skills taught in the program are designed to enhance the couple's ability to communicate effectively and become their own best problem solvers.

The theoretical justification for employing CST for persons with developmental disabilities is that the difficulties of these individuals are due largely to deficits in social communication, rather than simply speech production. Research in this field has only recently begun to focus on the social-emotional domain rather than on cognitive or linguistic deficits. Functional communication training is derived from learning theory and behavior analysis. Adherents of this perspective argue for the functionality or adaptiveness of the existing problem behavior (for example, self-injury may communicate physical discomfort) and note that when taught an appropriate communicative alternative, such as a gesture to obtain medical care, individuals with developmental

disabilities will often show substantial reductions in self-injury and other forms of problem behavior.

III. EMPIRICAL STUDIES

A large body of research on CST has pointed to its effectiveness in a variety of applications. Robin has conducted a host of studies that demonstrate the versatility of his CST approach with the most recent applications in the context of eating disorders. The effectiveness of his problem-solving communication training program has been established in both hypothetical (analogue) and actual therapy settings during structured treatment programs. Improvements in problem-solving have also been noted outside of training settings. For example, in one study, reductions in parent-adolescent conflict in the home were still evident up to 10 months following therapy. A lack of generalization is sometimes cited as a treatment limitation in other studies and reviews. Evidence of both parent and adolescent satisfaction with the improvements in family interaction has also been noted.

BMT is among the most heavily researched treatment programs of any kind. Findings have suggested that it is superior to no-treatment controls and placebo and equivalent to or more effective than other forms of marital therapy. Although generalization and maintenance of treatment effects and the clinical significance of results have sometimes been a concern, researchers continue to work to improve outcomes. Empirical support for the Couple Communication program is less robust than for BMT, but some evidence of increases in constructive communication skill use, relationship satisfaction, and maintenance of treatment effects have been reported.

V. M. Durand, David Wacker, Brian Iwata, and a host of others have found solid support for the use of functional communication and other behaviorally oriented skills training as a treatment modality for challenging behavior among persons diagnosed with developmental disabilities. The data have been encouraging in the assessment and treatment of problems such as aggression, self-injurious behavior, and stereotyped behavior, as well as other problems associated with autism. Moreover, these studies have been conducted in a variety of settings (e.g., schools, group homes, and vocational settings) and implemented by professionals, paraprofessionals, and family members alike.

IV. SUMMARY

The main elements that unite all the CST programs are the clear expression and reception of meaning, re-

structuring of inappropriate attitudes (on the part of each member of the interaction unit), and equalization of decision-making power. CST programs typically utilize the above model to reframe disagreements and to generate solutions to recurrent problems that plague the family or relationship partners. There are now a large number of empirical studies that support the efficacy and wide applicability of CST in the family context, including specific applications for problems that intersect the interpersonal sphere such as alcoholism, sexual dysfunction, and depression.

In recent years, CSTs have also been developed for patients with developmental disabilities. Indications are that persons with disabilities and their caretakers also benefit from structured programs that teach persons in the caretaker-patient relationship how to communicate more effectively in the social milieu. Once the strategies for each individual have been developed based on an ideographic assessment, they may be implemented by parents, teachers, and other specialists involved in the individual's care. Communication skills programs may also be used to design more effective interventions for challenging behavior. When implemented, their goal is to replace problem behavior, such as self-injury, with socially appropriate communication. These programs, too, appear to have a high success rate. Although technically difficult to implement and sometimes effortful or unpleasant for participants, it is expected that further development of CST programs will be undertaken with increasingly diverse populations.

See Also the Following Articles

Anger Control Therapy ■ Family Therapy ■ Functional Communication Training ■ Interpersonal Psychotherapy ■ Language in Psychotherapy ■ Parent-Child Interaction Therapy ■ Psychodynamic Couples Therapy

Further Reading

- Durand, V. M., Berotti, D., & Weiner, J. (1993). Functional communication training: Factors affecting effectiveness, generalization, and maintenance. In J. Riechle & D. P. Wacker (Eds.), *Communicative alternatives to challenging behavior: Integrating functional assessment and intervention strategies: Vol. 3*. Baltimore, MD: Paul H. Brookes.
- Foster, S. L., & Robin, A. L. (1998). Parent-adolescent conflict and relationship discord. In E. J. Mash & R. A. Barkley (Eds.), *Treatment of childhood disorders* (2nd ed.). New York: Guilford.

- Holtzworth-Munroe, A., & Jacobson, N. S. (1991). Behavioral marital therapy. In A. S. Gurman & D. P. Kniskern (Eds.), *Handbook of family therapy* (Vol. 2). Philadelphia, PA: Brunner-Mazel.
- Jacobson, N. S. (1984). A component analysis of behavioral marital therapy: The relative effectiveness of behavior exchange and communication/problem solving training. *Journal of Consulting Clinical Psychology, 52*, 295.
- Klinger, L. G., & Dawson, G. (1992). Facilitating early social and communicative development in children with autism. In S. F. Warren & J. Reichle (Eds.), *Causes and effects in communication and language intervention*. Baltimore, MD: Paul H. Brookes.
- Miller, S., & Sherrard, P. A. D. (1999). Couple communication: A system for equipping partners to talk, listen, and resolve conflicts effectively. In R. Berger & M. T. Hannah (Eds.), *Preventive approaches in couples therapy*. Lillington, NC: Edwards Brothers.
- Orelove, F. P., & Sobsey, D. (1996). *Educating children with multiple disabilities: A transdisciplinary approach* (3rd ed.). Baltimore, MD: Paul H. Brookes.
- Robin, A. L. (1981). A controlled evaluation of problem-solving communication training with parent-adolescent conflict. *Behavioral Therapy, 12*, 593.
- Robin, A. L., & Foster, S. L. (1989). *Negotiating parent-adolescent conflict: A behavioral-family systems approach*. New York: Guilford.
- Robin, A. L., Kent, R., O'Leary, D., Foster, S. L., & Prinz, R. (1977). An approach to teaching parents and adolescents problem-solving communication skills: A preliminary report. *Behavioral Therapy, 8*, 639.

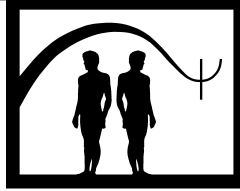

Comorbidity

William M. Klykylo

Wright State University School of Medicine

- I. Definition and History of Concept
 - II. Comorbidity and Substance Abuse
 - III. Comorbidity in Childhood Disorders
 - IV. Other Comorbidities
 - V. Applications of Concept
- Further Reading

GLOSSARY

comorbidity The co-occurrence of more than one disorder in the same individual.

endocrinopathy A disorder caused by or affecting the endocrine system of the body.

epidemiologic Relating to the study of epidemiology or to the characteristics of a disease or physiologic phenomenon in a population as a whole rather than in individuals.

I. DEFINITION AND HISTORY OF CONCEPT

Comorbidity is defined as the co-occurrence of more than one disorder in the same individual. In its broadest sense, comorbidity can include the co-occurrence of medical and psychiatric disorders, such as the dementia associated with organic conditions or the affective changes resulting from endocrinopathies. In psychiatry, comorbidity is generally taken to mean the association of diagnosable psychiatric disorders. Comorbidity is an epidemiologic phenomenon, relating to the character-

istics of a population, and the reported comorbidity of certain disorders in a population does not necessarily imply that they will be comorbid in any given individual. However, observations of comorbidity among populations may be extremely useful in informing the therapist's understanding of an individual patient.

The observation of comorbidity between disorders does not in and of itself demonstrate any particular type of relationship between them, least of all causality. Comorbidity can result from many factors. One disorder may represent an early manifestation of another. There may be problems of classification, in which the use of same or similar symptoms define different disorders. Detection artifacts can occur. For example, the presence of one disorder in a patient may make another condition more visible, even though it may be no more common than in a general population. Similarly, the presence of one disorder may influence the observations of clinicians and make them more likely to report the presence of another disorder.

Nonetheless, rates of co-occurrence of psychiatric disorders that are far in excess of what could be expected from chance have repeatedly been reported among many different populations. The recognition of this fact by mental health professionals has been long in coming but represents a major advance in the basic assumption of mental health care. Documentation of comorbidities have likewise led to important advances in our knowledge of mental illness and thereby our ability to provide effective, comprehensive care.

One may speculate as to why the recognition of comorbidity came later to mental health than to some other areas of medicine. Often therapists have found a unitary explanation for their patients' problems to be both of heuristic value and a source of comfort. The psychodynamic concepts of nuclear conflict and infantile neurosis, although valuable in many respects, may have engendered a notion that individuals have one great problem alone. The tendency in some psychotherapeutic schools to value contemporaneous observations of process over a more "medical" model of diagnosis, especially prior to *DSM-III* may have rendered irrelevant the concept of comorbidity, based as it is on diagnosis. The ascendance of the empiric model of *DSM-III* and *-IV* can create an epistemological problem for some therapists, in that many of the plethora of diagnoses contained in the *DSMs* have numerous features in common. This level of detail enhances the utility of *DSM* criteria as discriminators among diagnoses. However, these commonalities can also obscure the differences among conditions and thereby lead clinicians to gloss over comorbidities. In any case therapists today are much more likely than in the past to recognize that their patients frequently most confront a variety of illnesses and problems. These may often aggravate each other and must be addressed in their multiplicity if the patient is to find meaningful symptomatic relief and functional improvement.

Therapists approach patients with a certain mindset, reflective of particular schools of therapy but also of generally accepted values, such as empathy, professional responsibility, and the importance of a conceptual framework for diagnosis and treatment. Part of this framework for any therapist today must be the possibility of comorbid disorders in any patient. This point of view, like any other assumption, should be used to enrich and amplify one's view of the patient rather than to unnecessarily codify or stereotype that view. Most data on comorbidity is epidemiologic, although each patient has an individual course of life. In addition, the recognition of an additional problem or disorder does not necessarily require that it be treated, especially in today's climate of focused and time-limited psychotherapies. Still, most therapists have a desire to know as much as they can about their patients' life so as to serve both the patients' needs and enhance their own satisfaction.

II. COMORBIDITY AND SUBSTANCE ABUSE

Therapists should be aware of many particular comorbidities that have been documented in psychiatric re-

search. The most extensive documentation of comorbidity involves substance abuse and psychiatric disorders. Alcoholism and other addictions affect 20% of the population at some time in their lives, and this number is greatly increased if one also considers tobacco consumption a form of substance abuse. It is reckoned that at least one third of persons with addictions have some other comorbid Axis I disorder. In the national comorbidity survey reported in 1988, 47% of alcoholics had a comorbid psychiatric diagnosis. This number rises even higher in psychiatric inpatient settings and among the homeless.

Anxiety and affective disorders are the most common mental illnesses other than substance disorders in the general population. Thus, it is not surprising to find a high rate of comorbidity between these conditions and substance abuse. Some authors report a particular association between the primary onset of an anxiety disorder and the subsequent development of alcoholism, but the opposite temporal relationship is also quite possible. Persons with affective disorders often are attracted to substance use and abuse in an attempt to self-medicate. The Epidemiological Catchment Area (ECA) study showed that 30% to 50% of their alcoholic patients had comorbid major depression, although this rate of occurrence decreased substantially with abstinence.

Persons with schizophrenia, especially men, are also more likely than nonill controls to have a comorbid substance abuse problem. Lifetime concurrence in this group of around 50% is frequently reported for alcohol use disorders. In 1990, a report from the Eastern Psychiatric Institute showed that, among schizophrenic patients, 47% abused alcohol, 42% abused cannabis, 25% abused stimulants, and 18% abused hallucinogens. In this population, drug dependence was associated with more hospitalizations and with more psychosocial symptoms.

Other reports have suggested an increased level of comorbidity for substance abuse among adolescents and young adults with attention deficit hyperactivity disorder. This may be particularly marked among patients with associated learning problems, family dysfunction, or social economic distress. Researchers have speculated as to whether this might result from an underlying biobehavioral predisposition, the consequence of an impulsive lifestyle and social and educational failures, or various other combinations of factors.

III. COMORBIDITY IN CHILDHOOD DISORDERS

Comorbidity of psychiatric disorders in children occurs far in excess of chance. In the studies of this

phenomenon that have been conducted in the last 15 years, rates of co-occurrent disorders in participants studied from 40% to 70% are commonly reported. Child adolescent psychiatry disorders are commonly described as externalizing, such as conduct disorder and hyperactivity, and internalizing, such as anxiety and depressive disorders. Researchers have demonstrated an especially high comorbidity within each of these categories but also a very significant comorbidity between these two areas. As early as 1982 Puig–Antich reported a significant association between conduct disorder and depression, and a frequent association between hyperactivity and depression has also been reported. At times this degree of overlap has led observers to question whether or not some of these conditions are actually separate disorders.

The most commonly diagnosed psychiatric disorder in children in the United States is attention deficit hyperactivity disorder (ADHD). Various rates of prevalence from 3% to 10% have been reported. The recognition of this disorder is influenced by many external factors, such as particular family, social, and educational expectations and the availability of mental health services. It is said that this condition is both heavily underdiagnosed and overdiagnosed. It is also frequently misdiagnosed; for example, many children described as having ADHD actually have a primary depression. Nonetheless rigorous studies of children with this condition have repeatedly disclosed the frequent occurrence of comorbid conditions. As many as two thirds of elementary school age children with ADHD have at least one other diagnosable psychiatric disorder. In the Ontario Child Health Study investigators noted that 42% of such children had comorbid conduct disorder, 17.3% had somatization disorder, and 19.3% had the broad category of emotional disorder. Another study conducted by Cohen and his coworkers reported similar findings including 23% of children with overanxious disorder, 24% with separation anxiety, and 13% with major depressive disorder.

Not surprisingly a converse comorbidity is seen among children with disruptive behavior disorders such as conduct disorder and oppositional defiant disorder. Some 50% of these children have mood disorders, and perhaps 20% or more have learning problems or learning disabilities.

Anxiety disorders in children have been traditionally underrecognized. This may be a result of early theoretical notions that regarded anxiety as mainly a symptom of neurosis that could be expected to abate incidentally in the course of psychotherapy. We have learned in recent years that, regardless of its origin, anxiety persists

in children as with a life of its own, regardless of its origin. The *DSM-IV* notes the existence of separation anxiety disorder and generalized anxiety disorder in children. Children may also experience social phobia and panic disorder. Obsessive–compulsive disorder (OCD) is one of the anxiety disorders as is posttraumatic stress disorder (PTSD).

All of these disorders, including PTSD, can be comorbid with each other. Clinicians who follow patients over the years meet children who may first present with a separation anxiety disorder, then go on to develop a social phobia and later in life manifest OCD. Many other sequences also occur, and any and all of these conditions can occur simultaneously. It is reported that the majority of children with the specific phobia also have a second anxiety disorder diagnosis. Two thirds of children with anxiety disorders also have depressive disorders, at least at some time in their lives. Seventeen to twenty-two percent of children with a primary anxiety disorder may have ADHD, and a comorbidity with conduct disorder and oppositional defiant disorder has also been observed. Posttraumatic stress disorder in children as well as in adults requires special consideration. This disorder in and of itself has a protean range of symptoms, which may lead the clinician to misattribute symptoms that might be reflective of a concurrent or preexistent second psychiatric disorder. Depression and anxiety disorders are most especially observed in the company of PTSD and may require psychiatric treatment in addition to that being already offered for trauma.

Eating disorders are regrettably common in our appearance-oriented society. It is reported that 75% of female teenagers describe themselves as fat. One to four percent of adolescent and young adult women go on to develop anorexia nervosa or bulimia and perhaps one tenth as many young males. People with anorexia have increased rates of major depressive disorder, dysthymia and OCD. Persons with bulimia also have high rates of anxiety and addictive disorders. In the experience of many clinicians, it is impossible for many patients to recover from their eating disorders without adequate treatment for these comorbid conditions.

IV. OTHER COMORBIDITIES

Any of the comorbidities reported in child and adolescent psychiatric patients may also be seen in adulthood. In addition, the clinician must be mindful of other frequently reported co-current conditions. Patients with schizophrenia often have concurrent

cognitive deficits and affective disorders. Suicidality is common in young males with schizophrenia especially early in their illness.

There is extensive comorbidity among the affective disorders. Many researchers believe this is a manifestation of early appearance of disorders. For example, a patient who has recurrent depressive episodes may go on in time to develop full bipolar illness. More than 40% of patients with major depression can expect to have one or more "nonmood" psychiatric disorders during their lifetimes. These include alcoholism and substance abuse, anxiety disorders, eating disorders, and certain personality disorders such as borderline personality disorder. Affective disorders are often seen in association with somatoform and conversion disorders, although firm numbers for comorbidity are difficult to come by.

Persons with panic disorder have an extremely high rate of comorbidity with other anxiety disorders such as social phobia, generalized anxiety disorder and OCD. They also have a very high rate of substance abuse. Virtually all of these people, who represent 2% to 5% of the general population, have some other associated psychiatric disorder. Social and specific phobias are also reported to be comorbid with other disorders, though this comorbidity seems less than that of panic disorder. The comorbidity of PTSD with many other conditions as reported among children, is also seen in adults.

Sixty-seven percent of persons with primary OCD can expect to have a major depression during their lifetimes, and typically 31% of them at any given time. OCD also has a demonstrated concurrence with Tourette syndrome that probably results from shared neurobiological factors. OCD patients may have a delusional component to their condition, which at times may be so intense as to resemble psychosis and even require antipsychotic medication. It is not certain however as to whether there is any increased occurrence of true psychosis among these patients. Patients with OCD do have a high rate of concurrent anxiety disorders such as social phobia, specific phobia, and panic disorder.

The comorbidity of psychiatric and medical illnesses constitutes a major *raison d'être* for psychiatry as a specialty and is the basis for an entire subspecialty, consult-liaison psychiatry. A comprehensive treatment of this area is beyond the scope of this article. The *DSM-IV* notes that general medical conditions can be responsible for psychotic disorders, anxiety disorders, mood disorders, sexual dysfunction, sleep

disorders, catatonia, and personality changes. Medical conditions such as endocrine disorders, infectious diseases, metabolic disorders, malignancies, and neurological injuries and diseases have all been associated with mental illness. Any patient entering psychotherapy should be receiving ongoing primary medical care. A patient with a known medical illness, or whose condition suggests the possibility of medical illness, deserves thorough medical assessment. The reader should consult a comprehensive textbook for further consideration of this area.

V. APPLICATIONS OF CONCEPT

It should be apparent that in many areas of psychiatry comorbidity is the rule rather than the exception. What is the psychotherapist to do with this information? Obviously one must be aware that a patient describing a single unitary problem may have a larger range of problems or disorders. It may be necessary for the therapist to address problems beyond those originally proposed to help the patient. Even if the patient does not wish to pursue treatment for these other areas, the ethical therapist has a responsibility to share his or her observations and to advise the patient of any difficulties the patient might be facing.

Therapists may be inclined at times to omit or minimize their discussion of comorbid factors of patients. This may be out of a desire to avoid discouraging the patient or aggravating a condition. However, in the longer term, the goals of any psychotherapy are better served by honesty accompanied by tact and sensitivity. While some patients may be daunted by an enumeration of comorbid problems, many others will be reassured by a delineation of what exactly they are facing, and may even be encouraged by what progress they have already made in the face of multiple problems.

See Also the Following Articles

Collaborative Care ■ Cancer Patients: Psychotherapy ■ Medically Ill Patient: Psychotherapy ■ Substance Dependence: Psychotherapy

Further Reading

Bucholz, K. K. (1999). Nosology and epidemiology of addictive disorders and their comorbidity. *Psychiatric Clinics of North America*, 22,(2) 221-239.

- Goldsmith, R. J. (1999). Overview of psychiatric comorbidity, practical and theoretical considerations. *Psychiatric Clinics of North America*, 22,(2) 331–349.
- Kay, J., Tasman, A., & Lieberman, J. A. (2000). *Psychiatry: Behavioral science and clinical essentials*. Philadelphia: W. B. Saunders.
- Klykylo, W. M., Kay, J., & Rube, D. (1998). *Clinical child psychiatry*. Philadelphia: W. B. Saunders.
- Offord, D. R., & Fleming, J. E. (1996). Epidemiology. In Melvin Lewis (Ed.), *Child and adolescent psychiatry: A comprehensive textbook* (pp. 1166–1178). Baltimore: Williams & Wilkins.

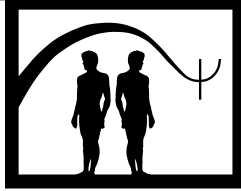

Competing Response Training

Raymond G. Miltenberger

North Dakota State University

- I. Description of Treatment
 - II. Theoretical Bases
 - III. Applications and Exclusions
 - IV. Empirical Studies
 - V. Case Illustration
 - VI. Summary
- Further Reading

GLOSSARY

awareness training A component of competing response training in which the therapist teaches the client to identify each occurrence of the habit behavior or antecedents to the habit behavior.

competing response An incompatible behavior that the client engages in contingent on the occurrence of the habit behavior as part of competing response training.

habit disorder A repetitive behavior that does not typically serve any social function but occurs with sufficient frequency or intensity to cause distress to the client or significant others. Habit disorders include nervous habits such as thumbsucking, nail biting, and hair pulling, tics such as head jerking or facial grimacing, and stuttering which involves word or syllable repetition, prolongation of word sounds, and blocking.

I. DESCRIPTION OF TREATMENT

Competing response training is a treatment procedure used with habit disorders including nervous

habits (fingernail biting, thumbsucking, hair pulling, etc.), tics (head jerking, facial grimacing, shoulder jerking, etc.), and stuttering. The essence of competing response training is to teach the client to become aware of each instance of the habit behavior and to engage in an incompatible behavior contingent on the occurrence of the habit or the antecedents to the habit. Competing response training involves two components, awareness training and competing response practice. Awareness training is critical to the use of competing response training because the client must be aware of each occurrence of the habit to effectively use the competing response contingent on the habit.

Competing response training was originally developed as a component of the habit-reversal procedure outlined by Nathan Azrin and Greg Nunn in 1973. The habit-reversal procedure involves a number of treatment components including awareness training, competing response practice, habit control motivation, and generalization training. Azrin and Nunn and other researchers evaluated the effectiveness of habit reversal for a variety of nervous habits, tics, and stuttering. Researchers also demonstrated that competing response training (involving awareness training and competing response practice) was an effective procedure as well. For example, in 1985 Ray Miltenberger, Wayne Fuqua, and Tim McKinley showed that both habit reversal and competing response training were effective in the treatment of motor tics exhibited by children and adults. Other research by Miltenberger and Fuqua in 1985

showed that competing response training was effective for the treatment of nervous habits such as nail biting and hair pulling exhibited by adults. Miltenberger and his colleagues have referred to competing response training as simplified habit reversal because it consists of a subset of the original habit-reversal components.

Competing response training is typically implemented in one or a small number of outpatient treatment sessions. Following an assessment interview, the therapist implements the awareness training procedure and then the competing response practice procedure with the client.

A. Awareness Training

The goal of awareness training is to teach the client to identify each occurrence of the habit and to identify the antecedents or warning signs that the habit behavior is about to occur. A number of procedures are used to achieve this goal.

First, in the response description procedure, the client is asked to describe the habit behavior. The client describes all the behavioral movements involved in the habit behavior and all of the different ways in which the habit behavior may occur. Next, in the response detection procedure, the client is taught to detect each occurrence of the habit behavior in session. The therapist starts by simulating the habit behavior and having the client identify the occurrence of the behavior when exhibited by the therapist. The client then practices identifying each occurrence of the habit that he or she exhibits in the session. Some habit behaviors such as motor and vocal tics or stuttering may naturally occur in session. Other behaviors such as nervous habits (e.g., hair pulling, nail biting) typically do not occur in session. For tics or habits that occur in session, the client is instructed to indicate each time the habit naturally occurs. The client might say “there’s one” to identify the occurrence of a motor tic or raise a finger to indicate the occurrence of a vocal tic or stutter. The therapist praises the client for correctly identifying the habit behavior when it occurs. If a habit behavior occurs and the client does not identify it, the therapist points out to the client that the behavior just occurred. This process continues until the client reliably identifies (without prompts) each instance of the habit as it occurs.

For habit behaviors such as nervous habits that do not typically occur in the treatment session, the therapist implements response detection by having the client simulate occurrences of the habit. The client will

simulate the movements involved in the habit behavior and then identify the occurrence of the behavior.

After the client has practiced response detection a number of times, the therapist then focuses on detecting the antecedents or warning signs that precede the occurrence of the habit behavior. The therapist first has the client identify the situations or behaviors that precede the occurrence of the habit behavior. For example, a client might touch her hair before hair pulling or inspect his finger nails for rough edges before nail biting. The therapist also has the client identify any thoughts, feelings, or physical sensations that precede the occurrence of the habit. For example, the client might experience a sensation such as tension in a muscle before engaging in a motor tic. If the antecedent is an overt behavior, the therapist has the client simulate the behavior and identify its occurrence. If the antecedent is covert, the therapist has the client imagine its occurrence. Any time the antecedent naturally occurs in the session, the client is instructed to identify its occurrence. The therapist provides praise for correct identification of antecedents in session and prompts the client if the client fails to identify an antecedent that just occurred.

B. Competing Response Practice

The goal of competing response practice is to teach the client to engage in a competing response each time the habit behavior occurs or when an antecedent to the habit behavior occurs. The therapist implements competing response practice after awareness training is completed, and the client can identify each occurrence of the habit or antecedents to the habit.

To begin competing response practice, the client (with the aid of the therapist) chooses one or more competing responses that can be used in situations in which the habit behavior typically occurs. The therapist instructs the client that the competing response should be a behavior that is, (a) physically incompatible with the habit behavior, (b) easy for the client to engage in, and (c) inconspicuous so that the competing response does not draw attention to the client when the client is around others. An example of a competing response for hair pulling or thumbsucking might be to make a fist while holding the hands down at the side. An example of a competing response for a motor tic such as head jerking might be to tense the neck muscles while pulling the chin down slightly toward the chest. The therapist instructs the client to engage in the competing response for about one minute each time the habit behavior occurs or when an antecedent to the habit behavior occurs. After choosing the competing

response(s), the therapist has the client practice use of the competing response contingent on the habit or antecedents to the habit in the session.

If the habit behavior occurs naturally in session (e.g., tics or stuttering), the client practices use of the competing response each time the habit occurs. The therapist praises the client for using the competing response at the appropriate time and prompts the client to use the competing response if the habit occurs but the client fails to use the competing response. This practice continues until the client reliably uses the competing response immediately contingent on the habit. The therapist also has the client practice use of the competing response contingent on the antecedents to the habit. After reviewing the antecedents with the client, the therapist instructs the client to use the competing response each time one of the antecedents occurs. If the antecedents are overt, the therapist will provide praise for correct use of the competing response or prompts to use the competing response if the client did not use it at the correct time. If the antecedents are covert, the therapist cannot provide such feedback but rather praises the client for reports of successful use of the competing response contingent on the covert antecedents.

If the client's habit behavior does not naturally occur in session (e.g., nail biting, hair pulling), the therapist will implement competing response practice as described above as the client simulates the habit behavior and the antecedents to the habit behavior. For example, the client will reach up to her scalp to simulate a hair pulling behavior, stop the behavior, and immediately engage in the competing response. During competing response practice, the client will simulate a variety of ways that the behavior may occur or a variety of situations in which the behavior occurs and implement the competing response. The therapist will have the client practice the competing response in about 10 to 12 simulations of the behavior or antecedents to the behavior. After the competing response practice is completed in the session, the therapist instructs the client to use the competing response outside of the therapy session every time the habit behavior or an antecedent to the habit behavior occurs.

After implementing the awareness training and competing response practice procedures with the client in the initial treatment session, the therapist then conducts a number of followup or booster sessions to evaluate the client's progress using the procedures to control the habit behavior outside of the treatment session. In followup sessions, the therapist will review the procedures and have the client practice the procedures. The therapist will review difficult situations and help

the client identify ways to consistently use the competing response in those situations.

II. THEORETICAL BASES

The success of the competing response training procedure depends on consistent use of the competing response contingent on the occurrence of the habit or the antecedents to the habit. The competing response produces reductions in the habit behavior through one or two behavioral processes. Use of the competing response may function as an activity punisher. Thus, the contingent use of the competing response would punish the habit behavior. The other possible explanation for the effectiveness of the competing response in reducing habit behaviors is that the competing response is an alternative behavior that occurs in place of the habit behavior and supplants the habit behavior. The occurrence of the habit or an antecedent to the habit serves as a cue for the client to engage in the competing response as an alternative behavior. The therapist and significant others reinforce the correct use of the behavior. Whether the competing response supplants the habit behavior or punishes the habit behavior is not clear. It is possible that one or both processes are operating to decrease the habit behavior in any particular case.

III. APPLICATIONS AND EXCLUSIONS

Research has shown that competing response training is effective in reducing motor tics such as head shaking, eye blinking, facial tics, shoulder jerking, and head jerking; nervous habits such as nail biting, hair pulling, thumbsucking, chewing on clothes, scratching, and eye rubbing; and stuttering in children and adults. Competing response training has also been used to reduce outbursts of anger during athletic competition and to decrease rumination (regurgitation and rechewing of food) following meals.

Research has also shown that competing response training may not be effective with young children and with individuals with mental retardation. The ineffectiveness of competing response training may be due to the fact that children or individuals with disabilities are less motivated to change their behavior. They may not be distressed by the behavior and, therefore, may not express a desire to stop the habit and may not comply with the treatment procedures.

IV. EMPIRICAL STUDIES

Research by Miltenberger and colleagues has shown that competing response training is effective for a variety of habit disorders. For example, in 1985, Miltenberger, Fuqua, and McKinley showed that both habit reversal and competing response training were effective in decreasing motor tics. In 1985, Miltenberger and Fuqua also showed that competing response training was effective for nervous habits. In 1993, Joel Wagaman, Miltenberger, and Rich Arndorfer showed that competing response training was an effective treatment for stuttering in children. In addition to these studies, other research has demonstrated the effectiveness of competing response training for habits, tics, and stuttering.

Research also suggests that, in some cases, social support procedures or other operant contingencies may be necessary to ensure the effectiveness of competing response training, especially with children. For example, in 1999, Ethan Long and colleagues used differential reinforcement and response cost procedures with children and individuals with mental retardation after competing response training by itself was ineffective in the treatment of thumbsucking, nail biting, and hair pulling. Social support or other reinforcement contingencies may help promote the consistent use of the competing response by the client with the habit disorder. When the competing response is used consistently each time the habit behavior occurs, competing response training is more likely to be effective.

V. CASE ILLUSTRATION

Keith was a 12-year-old male who exhibited two motor tics: a mouth tic in which he pulled back the corners of his mouth, stretched his mouth open, and stuck out his tongue; and an eye-blinking tic involving hard eye blinking. Keith was diagnosed with Tourette's disorder and attention deficit hyperactivity disorder and was receiving sertraline (25 mg) daily. He received competing response training as part of a research project completed by Doug Woods, Ray Miltenberger, and Vicki Lumley in 1996.

The therapist first established a recording plan in which Keith was videotaped for 20 minutes in his home two times a week to evaluate the occurrence of tics before and after treatment. The occurrence or nonoccurrence of both tics was recorded in continuous 10-second intervals, and a percentage of intervals with tic occurrences was calculated for each tic. Competing response training was implemented with Keith for his mouth tic

in a one-hour treatment session and two 20-minute booster sessions scheduled one week apart. After improvements were seen in the mouth tic, the same treatment regimen was administered for the eye-blink tic.

The therapist began with awareness training to teach Keith to become aware of each occurrence of the tic. Keith described the movements involved in the tic and demonstrated the tic for the therapist as part of the response description procedure. Keith was not able to identify any antecedents to his tics. As part of the response detection procedure, he then observed himself on videotape and pointed out each occurrence of the tic that he saw on the tape. After identifying occurrences of his tic on tape, Keith practiced identifying each instance of the tic that occurred in the session as he talked with the therapist. The therapist praised him for correctly identifying the occurrence of the tic and pointed out any time a tic occurred that Keith failed to recognize.

After Keith was reliably identifying each occurrence of his tic, the therapist initiated competing response practice. The competing response for Keith's mouth tic involved pursing his lips for one minute. This behavior was chosen because it was incompatible with the tic and was an inconspicuous behavior that Keith could engage in whenever the tic occurred. Keith was instructed to engage in this competing response any time the tic occurred or when he was about to engage in the tic. After describing the competing response and delivering instructions to use it contingent on the tic, the therapist had Keith practice the competing response in the session. Each time that Keith engaged in the tic and then immediately engaged in the competing response, the therapist provided praise. Each time Keith engaged in the tic and failed to use the competing response, the therapist provided a reminder to use the competing response. Competing response practice continued until Keith had correctly identified 10 to 12 instances of the tic in the session with praise from the therapist.

The therapist also instructed Keith's parents to praise him for using his competing response and prompt him to use the competing response if he engaged in a tic and failed to do so. The initial session ended with the therapist instructing Keith to use his competing response contingent on the tic in all situations outside of the session and instructing the parents to provide praise and prompts at appropriate times outside of the session.

In each of the two booster sessions, the therapist reviewed the treatment components with Keith and his parents and had Keith practice the competing response contingent on instances of the tic in session. Keith was encouraged to use the competing response consistently outside of the session and was reminded that consistent

use of the competing response would produce the best results in reducing the frequency of his tic.

After Keith's mouth tic decreased from a baseline mean of 26% of observation intervals to less than 3% following the use of competing response training, the same procedures were implemented with the eye-blink tic. The competing response for the eye-blink tic involved a controlled blink every 3 seconds for a total of 15 seconds. The eye-blink tic occurred in 21% of observation intervals before treatment and was reduced to less than 3% of intervals after treatment.

VI. SUMMARY

Competing response training involves two components of the habit-reversal procedure: awareness training and competing response practice. In one or a small number of outpatient treatment sessions, the client learns to become aware of each occurrence of the habit behavior and to use a competing response contingent on the habit behavior. Competing response training, similar to habit reversal, has been shown to be a successful treatment for a variety of tics, nervous habits, and stuttering in children and adults.

See Also the Following Articles

Forward Chaining ■ Habit Reversal ■ Response Cost

Further Reading

- Azrin, N. H., & Nunn, R. G. (1973). Habit reversal: A method of eliminating nervous habits and tics. *Behaviour Research and Therapy, 11*, 619–628.
- Long, E., Miltenberger, R., Ellingson, S., & Ott, S. (1999). Augmenting simplified habit reversal in the treatment of oral-digital habits exhibited by individuals with mental retardation. *Journal of Applied Behavior Analysis, 32*, 353–365.
- Miltenberger, R., & Fuqua, R. W. (1985). Contingent versus noncontingent competing response practice with nervous habits. *Journal of Behavior Therapy and Experimental Psychiatry, 16*, 195–200.
- Miltenberger, R., Fuqua, R. W., & McKinley, T. (1985). Habit reversal with muscle tics: Replication and component analysis. *Behavior Therapy, 16*, 39–50.
- Miltenberger, R., Fuqua, R. W., & Woods, D. (1998). Applying behavior analysis with clinical problems: Review and analysis of habit reversal. *Journal of Applied Behavior Analysis, 31*, 447–469.
- Rapp, J., Miltenberger, R., Long, E., Elliott, A., & Lumley, V. (1998). Simplified habit reversal for chronic hair pulling in three adolescents: A clinical replication with direct observation. *Journal of Applied Behavior Analysis, 31*, 299–302.
- Wagaman, J., Miltenberger, R., & Arndorfer, R. (1993). Analysis of a simplified treatment for stuttering in children. *Journal of Applied Behavior Analysis, 26*, 53–61.
- Woods, D., Miltenberger, R., & Lumley, V. (1996). Sequential application of major habit reversal components to treat motor tics in children. *Journal of Applied Behavior Analysis, 29*, 483–493.



Complaints Management Training

Gu drun Sartory and Karin Elsesser

University of Wuppertal, Germany

- I. Description of Complaints Management Training
- II. Theoretical Bases
- III. Empirical Studies
- IV. Summary
- Further Reading

I. DESCRIPTION OF COMPLAINTS MANAGEMENT TRAINING

The basic aim of the treatment protocol is to provide a range of techniques that allow patients to manage their specific anxiety-provoking symptoms and thereby promote perceived control over them. The selection of management techniques is tailored to the individual complaints and needs of the patient. Accordingly, one core element of CMT is the continuous self-monitoring and recording of complaints in a diary to serve as a basis for selecting individual treatment techniques. In the following, examples will be cited from panic disorder and benzodiazepine withdrawal, for the treatment has been applied in these two conditions. CMT consists of three steps: (A) assessment of complaints; (B) training phase; and (C) generalization and relapse prevention.

GLOSSARY

- benzodiazepines** Tranquilizers (e.g., diazepam and alprazolam,) with wide-ranging effect on the nervous system. The main sites of action are the limbic system and the cerebellum; they have a calming and muscle relaxant effect.
- dyspnea** Difficulty in breathing or in catching the breath.
- GABA** Gamma-amino-butyric-acid, the major inhibitory neurotransmitter system of the brain.
- tachycardia** Abnormally rapid beating of the heart.
- vagal innervation** Increasing the vagal (parasympathetic) tone which leads to a decrease in heart rate.
- valsalva** An eighteenth-century physiologist after whom the vagal innervation technique of exerting pressure on the chest is named.

Complaints management training (CMT) is a cognitive-behavioral intervention for anxiety disorders in which somatic symptoms or complaints are a major source of distress. This entry contains a description of the treatment together with its hypothesized mode of action. Outcome data are presented for panic disorder and withdrawal from long-term tranquilizer use.

A. Assessment of Complaints

A detailed assessment is carried out into the range of somatic and bodily complaints, their antecedents, and consequences, in addition to the usual diagnostic procedures investigating the nature of the patients' disorder. Scales with lists of symptoms, such as the list of panic symptoms of the DSM-IV edited by the American Psychiatric Association (APA) in 2000 or the Body Sensation Questionnaire from Diane Chambless and co-workers published in 1984 may also be employed. Alternatively, an idiosyncratic list of the patient's

Date	Sept. 01		
Symptom:	I	A	I	A	I	A	I	A	I	A	I	A	I	A
Dyspnea	6	9												
Tachycardia	8	10												
Perspiration														
Tightness in chest/throat														
Dizziness, imbalance														
Muscle ache or tension														
Trembling/shaking	4	6												
Depersonalization														
Derealization														
Headache	5	3												
Nausea														
Tension, sleep disruption														
Other symptoms:														
<i>restlessness</i>	6	5												

Please indicate intensity (I) of each symptom and anxiety/stress (A) evoked by the symptom from 0 = not at all to 10 = extreme

FIGURE 1 Daily record of complaints: intensity and anxiety.

symptoms can be compiled (as an example, see Figure 1). The list is handed over to patients in the form of a diary. An anxiety rating should be added to the identified symptoms. Before the treatment techniques are selected, patients complete the diary for two weeks to indicate which symptoms are currently occurring and are the most distressing. The patients continue to complete the diary throughout treatment to provide feedback about the relief of symptoms and about changes in the extant symptoms, and thereby the need to change the treatment strategy. During the assessment phase, patients are usually given either relaxation or breathing exercises to be carried out daily in preparation of the following treatment.

B. Training Phase

Before being given training in specific techniques, patients are fully briefed about the impending treatment starting with psychoeducation.

1. Psychoeducation

At first, patients receive extensive psychoeducation as to the nature of their disorder. Depending on their relevance, models of anxiety are presented such as the three components model, the threshold model, and the vicious circle of panic model. If applicable, information about benzodiazepines and their effects, the danger of addiction with long-term use, and a full account of withdrawal symptoms are given. Explanations are supported by graphs, and patients are given a written account of this information because many of them tend to be too anxious to process the information during the session. Within this information explanations are reported for the identified symptoms. It is suggested that the symptoms are normal, harmless, and transient, and eased or counteracted by specific management techniques.

2. Training in Specific Techniques

During the assessment phase, patients carry out exercises in progressive muscle relaxation and breathing

retraining (slow, abdominal breathing with short pauses at the beginning and end of each respiratory cycle). Specific techniques are then chosen on the basis of the complaints indicated in the diary. Frequently employed management skills are shown in Table 1. Techniques are practiced within sessions until patients master them. Practice is first carried out in a relaxed state and afterward, whenever possible, under challenge to produce the symptom. Alternatively, stressful situations, symptoms, or states are imagined and counteracted with the newly learned technique. In some cases, instantaneous feedback of the not otherwise observable physiological changes may support the acquisition of skills. This feedback has been shown to be useful when teaching vagal innervation techniques that aim to control tachycardias.

Vagal innervation techniques offer a direct way to lower heart rate, which can be achieved by massaging the carotid, pressing on one eye during expiration, and using the Valsalva maneuver. The Valsalva technique is preferred by patients and consists of increasing pressure in the chest by tensing abdominal and intracostal muscles after a deep inhalation. It is assumed that these techniques stimulate baroreceptors and thereby lower heart

rate. Training of the Valsalva maneuver benefits from being supported by a beat-by-beat heart-rate monitor. Whenever instruments are used to aid the acquisition of skills, patients need to be made familiar with the apparatus and its functioning.

C. Generalization and Relapse Prevention

Patients are instructed to practice the newly learned management techniques between sessions and to record successes and failures for discussion in the following session. Having acquired a management technique, patients are asked to apply it at the first sign of an emerging symptom. Training is then extended to everyday life situations that have previously given rise to complaints. To be able to cope with setbacks, patients are instructed as to the incremental nature of the improvement and are told that minor lapses are not indicative of a relapse. Depending on the nature and severity of the disorder, treatment typically takes six to twelve sessions.

II. THEORETICAL BASES

The aim of complaints management training is to convey control over bodily reactions that are anxiety-eliciting. Assuming that elevated anxiety states between attacks are engendered by their unpredictability and uncontrollability, a technique that is perceived as bringing them under control will also reduce fears about the occurrence of further attacks and thereby reduce generalized anxiety states. Together with the ability to change intentionally a physiological function, the fear of its signaled consequences—be they health concerns or the next panic attack—will also attenuate. Two lines of evidence are cited in support of the validity of the complaints management approach. First, acquiring perceived control over feared objects and events often leads to a reduction of anxiety. Second, some anxiety disorders appear to be uniquely sensitive to bodily symptoms.

A. Controllability

Aversive stimuli are considered more unpleasant if they are also uncontrollable. Electric shocks are rated to be more unpleasant if they cannot be changed compared with shocks of equal intensity that could be regulated—although participants did not actually reduce their intensity. Having to listen to a radio program is

TABLE 1
Frequently Reported Complaints
and Employed Management Techniques

<i>Complaints</i>	<i>Management techniques</i>
Dyspnea	Slow abdominal breathing
Tachycardia	Valsalva
Perspiration	Cooling of wrists
Tightness in chest and throat	Slow breathing, relaxation, Valsalva
Dizziness, imbalance	Seeking support, e.g., wall or furniture, slow breathing, focusing on visual and acoustic stimuli
Muscle ache, muscle tension	Hot baths, relaxation
Trembling/shaking	Relaxation
Depersonalization (changed bodily perception)	Reality testing: e.g., stamp on the ground, strong grip
Derealization	Focusing on objects at different distances, touching of objects
Headache	Relaxation, massage
Nausea	Fresh air/smelling substances
Tension, sleep disruption	Relaxation

more irritating when there is no control over the volume. Finally, monotonous work routines are considered less stressful if rest periods are presumed to be under one's own control. In turn, phobic stimuli or objects are seen to be uncontrollable by phobics, who tend to have no coping reactions at their disposal with which to contain the stimulus or render it harmless.

Conveying control over a fear-inducing stimulus has an anxiety-reducing effect. Giving specific phobics control over the duration of exposure to slides of the phobic object resulted in them being less fearful of the slides than controls who were exposed for the same duration but could not switch off the slides themselves. Being instructed that they can leave the fear-inducing situation made agoraphobics less anxious during exposure, although they did not make use of their privilege.

B. Sensitivity to Bodily Symptoms

Anxiety disorders differ with regard to the target of the fear reaction. Although the focus of the phobic attention and reaction is directed towards objects or situations in the environment, general anxiety states tend to be preoccupied with somatic and social concerns. Panic disorder is uniquely sensitive to bodily changes. Given the massive distress created by a panic attack, bodily symptoms experienced during the attack—and thereby associated with them—are thereafter able to elicit panic attacks. Individuals who suffer from intense anxiety attacks direct their attention to bodily changes that might signal the advent of the next panic attack in an effort to be able to predict, and prepare for, the next attack. This, in turn, also makes them more sensitive to bodily changes.

A similar sensitivity to somatic symptoms is also reported by long-term users of benzodiazepines, particularly during withdrawal from the drug. It is as yet unclear whether the somatic sensitivity is part of panic disorder—a frequent comorbid disorder of benzodiazepine dependence—or whether long-term use of tranquilizers by itself results in heightened somatic sensitivity. Benzodiazepines support the activity of GABA, a neurotransmitter with an ubiquitous inhibitory effect in the nervous system. Assuming that prolonged use of the medication leads to a reduction of the brain's own production of inhibitory ligands, tolerance to and withdrawal from the drug can be expected to result in heightened activity of the brain systems that have hitherto been inhibited, thereby inducing somatic complaints. Over time, these have

been found to subside with renewed use of the drug, which is probably also the reason why withdrawal is difficult for the majority of patients. As with panic disorder, a technique that is perceived as bringing under control a somatic symptom that is associated with anxiety states can be expected to be anxiety-reducing during drug withdrawal. It is thought that the coping strategies will thus become behavioral alternatives to drug taking.

C. Hypothesized Mechanism of Complaints Management Training

Acquiring perceived control over anxiety-inducing bodily sensations reduces their threatening impact; it relinquishes fears about their meaning and consequences and the occurrence of further attacks, and thereby also reduces generalized anxiety states. Two considerations are important in the choice of techniques:

1. *Specificity*: Unlike anxiety management training in which a generalized anxiety state is counteracted by a similarly generalized relaxation response, complaints management training has been developed to deal with specific somatic responses. Given the specificity of some of the physiological reactions that assume a signaling function in panic disorder, it is necessary to create specific techniques with which to bring physiological reactions under control.
2. *Rapidity of action*: The more rapid the relief from the somatic symptom, the more fear reducing will the employed technique be as it conveys a greater extent of relevant feedback of its success.

III. EMPIRICAL STUDIES

There are two areas in which the principles of complaints management training have so far been applied in treatment: (A) panic disorder and (B) withdrawal from tranquilizer use. Complaints management training is successful in giving rapid relief of panic disorder. Within a few sessions it was more efficacious than breathing retraining. It was also as successful as cognitive restructuring, resulting in some 50% reduction in panic attacks within three sessions. Complaints management training also promotes discontinuation of long-term use of benzodiazepines. It eases withdrawal symptoms and improves depressive mood compared to anxiety management training.

A. Panic Disorder

A number of different techniques have been employed to bring under control somatic responses that are related to panic. The most frequently used technique is respiratory training. David H. Barlow and his associates have termed this approach panic control training. Eleven sessions of a combination of cognitive restructuring with breathing retraining and interoceptive exposure constitute a highly effective treatment in panic disorder. This treatment worked equally well with and without imipramine, a tricyclic antidepressant, and appeared more durable than imipramine alone six months after treatment cessation. Psychological treatments of panic disorder have previously been shown to be more effective than alprazolam, a benzodiazepine.

In 1988, Gudrun Sartory and Deli Olajide compared breathing retraining with Valsalva, a vagal innervation technique, and found a slight advantage of the latter. Both groups received progressive relaxation and the instruction that panic could be brought under control with their respective technique—slow breathing or vagal innervation. The number of weekly panics and somatic symptoms decreased equally in both groups, but the group receiving vagal innervation techniques evidenced less cognitive anxiety and considered panics to be less disruptive than the breathing retraining group. It was thought that vagal innervation techniques conveyed more rapid control over panic and therefore more relevant feedback regarding its efficacy than the breathing technique.

Comparing complaints management training with cognitive restructuring showed that they worked equally well. Initially, both groups received extensive psychoeducation as to the nature of panics, after which one group was trained in control techniques and the other spent the sessions discussing dysfunctional thoughts and attributions. As improvements set in fairly rapidly, it is thought that the initial psychoeducation had in itself a major effect. Explanations as to how panics come about constitute a form of reattribution that is known to be effective.

B. Tranquilizer Withdrawal

Elsesser et al. compared the effect of complaints management training with that of anxiety management training, the treatment that had previously been shown to be effective in facilitating benzodiazepine withdrawal. Immediately after treatment, the abstinence rate was higher in the complaints than in the anxiety management group

(Fig. 2a), and patients in the former were also less anxious and depressed (Fig. 2b). At followup, there was no longer a significant difference between groups in terms of abstinence rate (65%). Complaints management training appears, however, to ease withdrawal and to lower anxiety and depression more rapidly than anxiety management training.

The evaluation of the efficacy of a single-treatment mode presents some difficulty, for treatment trials usually combine a number of approaches in any condition and group. Caution must therefore be exercised when attempting to interpret the outcome of trials in terms of the effect of any single component of treatment. Some of the components are necessary to introduce or convey the techniques and have been found to be in themselves effective. Teaching the technique of slow abdominal breathing is usually embedded in progressive relaxation training, as tense abdominal muscles are likely to prevent slow and easy breathing. A further component is an extensive rationale as to why a particular technique will be helpful for a symptom. This necessitates discussion of the symptoms, including—to a certain extent—their reattribution. This strategy is the mainstay of cognitive restructuring, which is by itself highly effective in the treatment of panic disorder. Furthermore, in order to learn to control a certain physiological response, it has to be elicited in the first place. Exposure to fear-eliciting stimuli also has an anxiety-reducing effect. Studies dismantling the respective effects of the different components have so far not been carried out.

While taking into account these constraints on evaluation, complaints management training can be said to be of use in anxiety disorders with a prominent focus on bodily sensations. This is the case in panic disorder, tranquilizer withdrawal, and conceivably also in somatoform disorders, although there are as yet no formal treatment data available.

IV. SUMMARY

Complaints management training is a cognitive-behavioral intervention for anxiety disorders in which somatic symptoms are a major source of distress. It contains a range of techniques that enable patients to ease bodily symptoms and thereby promote perceived control over them. A detailed assessment is carried out on somatic and bodily complaints with the help of a diary. Patients are given extensive psychoeducation as to the nature of their disorder and are trained in techniques that are chosen on the basis of their spe-

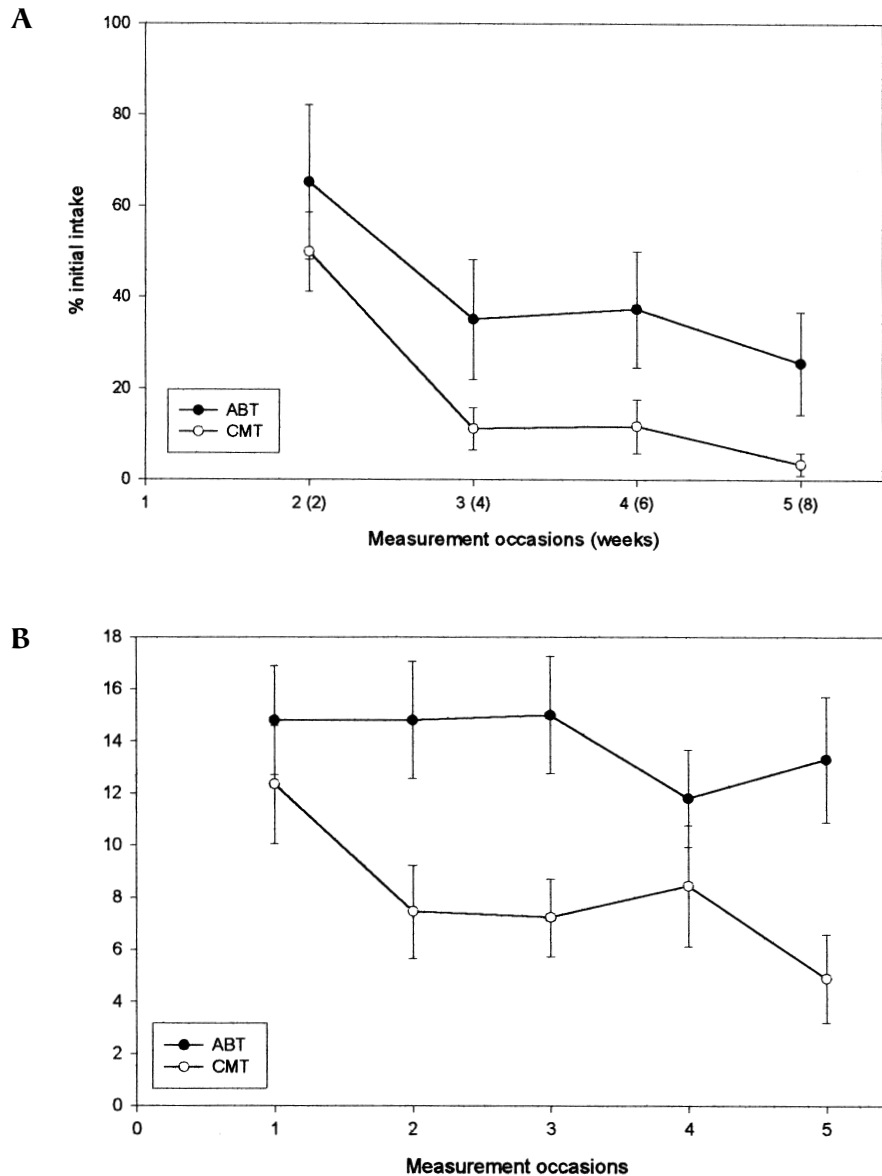

FIGURE 2 Two groups of long-term users of benzodiazepines (BZ) who had previously been unsuccessful in their attempt to withdraw were treated either with anxiety management training (AMT) or complaints management training (CMT). Both groups received nine weekly sessions; measurements took place at two weekly intervals. (A) shows the decrease in BZ consumption and (B) the course of depression ratings in the two groups. [Reprinted from Elsesser et al. (1996) with permission from Elsevier Science].

cific complaints. Frequently used techniques are Valsalva, a vagal innervation method to control tachycardias, breathing retraining for hyperventilation, and relaxation for feelings of tightness and muscle tension. Complaints management training has so far

proved successful in panic disorder and as psychological support of benzodiazepine withdrawal. It is thought that perceived control over the anxiety-provoking bodily symptom constitutes the main therapeutic mechanism.

See Also the Following Articles

Anxiety Disorders ■ Anxiety Management Training ■
Behavioral Assessment ■ Cognitive Behavior Therapy ■
Panic Disorder and Agoraphobia

Further Reading

- American Psychiatric Association. (2000). *DSM-IV text revision*. Washington, DC: American Psychological Association.
- Ashton, H., & Golding, J. F. (1989). Tranquillisers: Prevalence, predictors and possible consequences. Data from a large United Kingdom Survey. *British Journal of Addiction*, 84, 541–546.
- Barlow, D. H., & Craske, M. G. (1994). *Mastery of your anxiety and panic, II*. San Antonio, TX: San Graywind Publications Inc. The Psychological Corp.
- Barlow, D. H., Gorman, J., Shear, M. K., & Woods, S. W. (2000). Cognitive-behavioral therapy, imipramine, or their combination for panic disorder. *Journal of the American Medical Association*, 283, 2529–2536.
- Chambless, D. L., Caputo, G. C., Bright, P., & Gallagher, R. (1984). Assessment of fear in agoraphobics: The Body Sensations Questionnaire and the Agoraphobic Cognitions Questionnaire. *Journal of Consulting and Clinical Psychology*, 52, 1090–1097.
- Elsesser, K., Sartory, G., & Maurer, J. (1996). The efficacy of complaints management training in facilitating benzodiazepine withdrawal. *Behaviour Research Therapy*, 34, 149–156.
- Miller, N. E., & Magruder, K. M. (1999). *Cost-effectiveness of psychotherapy: A guide for practitioners, researchers and policymakers*. New York: Oxford University Press.
- Sartory, G., & Olajide, D. (1988). Vagal innervation techniques in the treatment of panic disorder. *Behaviour Research Therapy*, 26, 431–434.

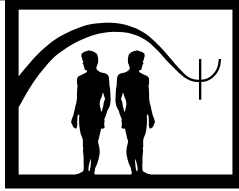

Conditioned Reinforcement

Ben A. Williams

University of California, San Diego

- I. Pavlovian Conditioning as the Basis of Conditioned Reinforcement
 - II. Laboratory Examples of Conditioned Reinforcement
 - III. Practical Advantages of Conditioned Reinforcement
 - IV. Theoretical Issues and Interpretations
 - V. Clinical Applications of Conditioned Reinforcement
 - VI. Summary
- Further Reading

activity. But it is also possible to create reinforcers from stimuli that have no initial biological significance by creating a learned association between those stimuli and biological reinforcers. Such reinforcers are labeled conditioned reinforcers (or “secondary reinforcers” in the early experimental literature) to reflect the fact that a learning procedure is necessary for the development of their reinforcement value.

GLOSSARY

higher-order conditioning A form of Pavlovian conditioning in which the unconditioned stimulus (US) is the conditioned stimulus (CS) from previous conditioning.

Pavlovian conditioning Learning that occurs when a stimulus that naturally elicits an unconditioned response (UR) is preceded by an initially neutral stimulus (CS). Because of the association established by the CS–US pairing, the CS elicits a response (CR) related to the UR.

reinforcement The psychological principle that a response followed by a reward will increase in strength; the more immediate the reward, the greater the strength.

A significant number of psychotherapies utilize the principle of reinforcement as the conceptual foundation of their treatments. Reinforcement theory originated in the laboratory with animal subjects, where the rewards used to reinforce the desired behavior have obvious biological value, such as food, water, and sexual

I. PAVLOVIAN CONDITIONING AS THE BASIS OF CONDITIONED REINFORCEMENT

The great majority of reinforcers that control human behavior have little immediate impact on satisfying the biological motives that underlie the reinforcement contingencies commonly studied in the laboratory. People are not born with a tendency to work for money, to like the taste of alcohol or coffee, or to value Porsches over Chevrolets. Such values are learned, according to the current consensus, by the process of *Pavlovian conditioning*. A stimulus paired with a stimulus that has unlearned *reinforcement* value (which Pavlov designated the unconditioned stimulus or US) acquires not only the ability to elicit the responses appropriate to the Pavlovian US but its reinforcing value as well. Thus; a conditioned reinforcer is a Pavlovian conditioned stimulus (CS) that has been paired with a US of positive value. The implication is that variables that govern

Pavlovian conditioning also determine when initially neutral stimuli become conditioned reinforcers.

It is important to recognize that Pavlovian conditioning is not the simple process that it was once supposed. Simple pairing between the CS and US is inadequate for conditioning to occur because the CS must also provide information about the US occurrence that is not available from other sources. Associations between the CS and US may also occur even when they are not directly paired, due to shared associations with a third stimulus. In Pavlov's studies of "second-order conditioning," for example, a bell was first paired with food in the dog's mouth, so that the bell elicited salivation. Then a light was paired with the bell, and the light also elicited salivation without itself being paired with the food. Pavlov also studied higher-order mediated associations but found that the conditioned response was not maintained beyond the third-order level. Pavlov nevertheless believed that mediated associations were of major importance for Pavlovian conditioning of human behavior because language could serve as a "second signaling system" that provided a basis for such mediated associations readily to occur.

Although the present discussion will consider only events that assume positive value because of their conditioning history, it is important to recognize that stimulus events may assume negative value as well, thus serving as conditioned aversive stimuli that may motivate various types of avoidance and escape behavior. Conditioning of aversive properties to initially neutral stimuli, and the behavioral dynamics that result from such conditioning, have played a major role in theories of various forms of neurotic behavior, for example, phobias, and compulsive behavior such as incessant hand-washing. We will confine ourselves to positive conditioned reinforcement, both because of the need to limit the range of discussion and because the scientific investigation of positive conditioned reinforcers and conditioned aversive stimuli has evolved into essentially separate enterprises, as has their application to clinical situations. Nevertheless, it is important to appreciate that similar conceptual issues occur in both arenas.

II. LABORATORY EXAMPLES OF CONDITIONED REINFORCEMENT

A simple example of how conditioned reinforcement has been studied is provided by the report by B. F. Skinner in his first major book, *Behavior of Organisms*, published in 1938. Rats were first trained to approach a food

cup at the sound of the pellet dispenser, and then food was removed from the situation when a lever was introduced into the experimental chamber. Lever presses produced the sound of the pellet dispenser but no food. The rate of lever pressing increased over the first 5 to 10 minutes, then decreased, and finally was reduced to near-zero levels after 30 to 45 minutes of training. Approximately 40 to 80 total bar presses occurred over that period of time. Skinner's results are typical of many subsequent studies. The response-contingent presentation of a stimulus previously paired with the primary reward produces some initial level of acquisition, but then loses its ability to maintain the behavior as training continues. Presumably this loss of control over responding reflects the extinction of the conditioned value of the conditioned reinforcer in that its presentation in the absence of the primary reinforcer removes the conditioned value that was originally established by the pairings of the initially neutral stimulus and the primary reward. The rate at which this extinction process occurs thus determines the duration of time over which a conditioned reinforcer will be effective after it is no longer paired with the primary reward.

A more durable method for using conditioned reinforcement is to maintain separately the correlation between the stimulus and primary reward while at the same time making the conditioned reinforcer contingent on a designated response that otherwise is never followed by the unconditioned reward. An example of such a procedure was developed by Dr. J. W. Zimmerman and his colleagues in the 1960s. Pigeons received food delivery randomly distributed in time, but any scheduled food presentation was delayed until 6 seconds had elapsed without a peck to a small illuminated disc, in order to ensure that pecking behavior was not adventitiously followed by food. While the pecking behavior was never followed by food, it did produce conditioned reinforcers, consisting of brief presentations (0.5 sec) of the stimulus complex that ordinarily accompanied food presentation. Because this stimulus complex (a light onset and distinct sound) was paired with the food deliveries that occurred in the absence of pecking, it continued to be paired with the food reward. Consequently, pecking was maintained by the conditioned reinforcer presented in the absence of food, despite the pecking behavior delaying food presentations that otherwise would have occurred. Despite its maladaptive character, pecking behavior was sustained for months of training, as long as the pairings of the stimulus complex and the food were maintained.

III. PRACTICAL ADVANTAGES OF CONDITIONED REINFORCEMENT

Conditioned reinforcers have substantial advantages over primary reinforcers in a significant number of training situations. One problem with using a primary reinforcer is that its consumption may interrupt the stream of behavior that is being trained. For example, in animal acts such as “Shamu the Killer Whale” at Sea World, the primary reward is a quantity of fish presented at the side of the tank. Thus, if only the food reward were used when Shamu executed the various parts of his performance, the continuous stream of behavior would be disrupted by trips to the side of the pool to obtain the food. So instead the training procedure involves presenting auditory signals (usually audible only to the whale) as feedback for the various segments of the performance, which allows the behavior segments to be reinforced without the requirement that the subject procure the reward by approaching the food site.

A similar advantage for conditioned reinforcement contingencies may be seen in even the simplest animal training. When using a food reward to train your dog to roll over, for example, a typical problem is that the dog will quickly discriminate that you are the source of the food and will attend closely to you, often approaching and begging for the food at the expense of the behavior that you are attempting to shape. Although it is possible to extinguish this competing behavior, a more expeditious procedure is first to establish a discriminative contingency such that the food is delivered only after the sound of a clicker, and then to use the clicker as a conditioned reinforcer contingent on the behavior being shaped. The underlying principle is that Pavlovian contingencies may often compete with the operant contingencies, so that a judicious choice of the stimulus signaling reward availability is often necessary to minimize competition from the sign tracking that so often occurs when signals for food are physically localized in the environment.

A further example of the utility of using conditioned reinforcers is when the consumption of the primary reinforcer may be debilitating and therefore can occur only infrequently. One representative experiment is the study of various pharmacological manipulations on the lever-pressing behavior of a male rat that is maintained by access to a receptive female rat. Whenever the female rat has been obtained, the lever pressing that produced her access is typically disrupted for substantial periods of time, so that at most one to three primary reinforcers per day can be presented (because of the inherent difficulties

of delivering only small portions of the reward). Thus, the primary reinforcer is presented only after extended periods of bar pressing (e.g., the first bar press after 30 minutes has elapsed). The result is that the amount of maintained behavior is very low, making it difficult to study how the pharmacological variables affect the male rat's performance. However, when presentation of the female is preceded by a 30-second signal, and that signal is presented on its own more frequent schedule, the lever pressing greatly increases in frequency, allowing the drug effects to be assessed more easily.

The most common laboratory usage of conditioned reinforcement involves situations in which the primary contingencies of reinforcement are delayed in their presentation. Delayed reinforcement is much less effective in controlling behavior than is immediate reinforcement, and if the delay is sufficiently long, the animal may be incapable of learning even simple behaviors. For example, if a pigeon is presented a choice between a horizontal and vertical line, with the outcome of the choice presented one minute later (food or no food depending on whether the choice was to the stimulus the experimenter designated as correct), the pigeon will almost always fail to learn the discrimination. However, if differential stimuli are presented during the 60-second delay (e.g., a red light leading to food at the end of the delay versus a green light leading to no food at the end of the delay), the pigeon will learn the line-tilt discrimination almost as rapidly as if food/no food had been presented immediately after the pigeon's choice response. Thus, a major function of conditioned reinforcement is to facilitate control by delayed primary reinforcement.

A third important usage of conditioned reinforcement is in the training of behavioral chains. A common laboratory exercise for beginning psychology students is to train a rat to perform an apparently complex sequence of behavior, including, for example, running through a hoop, pulling a string through a hole, pressing a lever, and then pushing a marble, with the entire sequence required before the rat earns its food reward. The key concept for successfully training such behavior is “backward chaining.” The last element of the chain, in this case the marble pushing, is first trained with the food reinforcer; then the presentation of the marble serves as a conditioned reinforcer for training the preceding chain element (the lever press). The presentation of the lever then serves as a conditioned reinforcer for training the string pulling, and the presentation of the string can then be used as a conditioned reinforcer for training the running through the hoop.

Using this procedure, one can establish quite elaborate sequences of behavior, which appear extremely impressive until the observer learns the very simple principles that are involved. Backward chaining is often used in applied settings, especially for severely retarded children learning complex tasks such as feeding themselves or learning to tie a necktie.

After a chain sequence has been established, the pattern by which it extinguishes when food is removed from the situation also reveals an important principle. The element closest to the food extinguishes first, then the penultimate element, and so on. Extinction of a chain thus occurs in the reverse order of how it was learned. This is important because the initial elements of a chain may persist for prolonged periods of time after removal of the primary reinforcer. For example, a rat that has learned a complex maze may quickly run through the initial portions of the maze even after it has learned that no food is now in the goal box, but then gradually slow down its behavior the closer it gets to the goal box, ultimately not even entering it. The persistence of the early links of the chain occurs because the value of the conditioned reinforcer that maintains it must be extinguished before the behavior ceases. In the preceding example, after the rat learns that marble pushing is no longer followed by food, the presentation of the marble loses its conditioned value, which causes the lever pressing to decrease, which in turn causes the presentation of the lever to lose its value, and thus allows extinction of the string-pulling behavior. Each type of extinction takes some amount of time, so that prolonged training after the food has been removed is often necessary before the initial elements of the chain gradually wane. A commonplace example is when a coke machine that someone uses regularly no longer functions, keeping one's money while not delivering a coke. Often the behavior of going to the coke machine will persist even when the act of putting money into the machine does not occur. Thus, the terminal element of the chain has been extinguished due to the experience of losing one's money, but the early elements of the chain will persist until they, too, are extinguished by the arrival at the coke machine losing its value as a conditioned reinforcer.

IV. THEORETICAL ISSUES AND INTERPRETATIONS

The major issue concerning conditioned reinforcement as a theoretical concept is the basis of the facilitation by conditioned reinforcers of delayed primary

reinforcement. Professional animal trainers such as those who work at Sea World often describe the stimuli appearing in the delay between the response and the primary reward as "bridging stimuli," which suggests that the function of conditioned reinforcers is to facilitate the association between the animal's response and the delayed reward. That is to say, the intervening stimulus serves as a cognitive mediator that may have no value in itself except as it cues the subsequent delivery of the primary reinforcer. In contrast, the traditional conception of conditioned reinforcement is that conditioned reinforcers do indeed have value because of their Pavlovian association with the primary reinforcer.

For most practical purposes, it makes little difference which of these two interpretations is correct; it is possible that either may be correct depending on the specific training situation. Nevertheless, considerable research has been devoted to developing experimental tests that critically distinguish between then bridging versus conditioned value conceptions of conditioned reinforcement. An illustrative experiment that distinguishes between the two theoretical interpretations of conditioned reinforcement involves the line-tilt discrimination described above. Pigeons chose between vertical and horizontal lines, with the outcome of their choice (food or no food) occurring 60 seconds later. When different colored lights correlated with the outcome were present throughout that 60-second delay (e.g., red after a correct choice and green after an incorrect choice), the discrimination was rapidly learned. Moreover, when the differential colors occurred only for the first few seconds after the choice, and then the last few seconds prior to the outcome, the discrimination was learned as rapidly as if the colors had been present throughout the delay. The critical condition in the experiment, which distinguishes between the bridging versus conditioned value interpretations of conditioned reinforcement, was that which reversed the colors occurring at the beginning versus the end of the delay-of-reinforcement interval. Thus, red occurred immediately after the correct choice for a few seconds, and then green was presented a few seconds prior to the food reward contingent on that correct choice; also, green occurred immediately after the incorrect choice for a few seconds, and then red occurred during the last few seconds of the delay interval but here was not paired with food. The design of the experiment thus pitted the delayed primary reinforcement contingencies against the immediate conditioned reinforcement contingencies. The result was that after a brief period

of random responding all subjects began predominantly choosing the incorrect choice alternative because it was followed immediately by the color that preceded the food at the end of the delay.

Eventually, however, the choice behavior ceased to occur because continuous choice of the incorrect alternative meant that the red color no longer was paired with food and thus lost its conditioned value. But at no time did the animals learn to choose the correct line orientation because the color never paired with food was always immediately contingent on that behavior. The experiment thus demonstrates that the conditioned value of the conditioned reinforcer, not its ability to bridge the delay interval to food, determined its ability to control behavior.

The concept that a conditioned reinforcer has value in its own right provides insight into numerous experimental outcomes that otherwise seem odd or inexplicable. As one example, consider the phenomenon of “contrafree-loading,” the finding that animals will engage in operant behavior even when the food reinforcer contingent on the behavior is also freely available in the conditioning chamber itself. Moreover, animals will learn to emit the response even when the free food is available from the outset of training. Such behavior has been observed with several different species, with several different types of reinforcers. The behavior appears paradoxical because it violates the law of least effort, which otherwise has been upheld in many different settings. This paradox disappears, however, when the role of conditioned reinforcement is appreciated. The critical ingredient is the stimulus change contingent on the operant behavior that does not occur during procurement of the free food. Thus, the operant response is followed by the stimulus change plus the food, while the approach to the free food container is followed only by the food. Because the stimulus change is paired with the food, it apparently gains value in its own right, thus making the stimulus plus food combination more valuable than food alone. This interpretation is supported by the finding that when the stimulus change is equated for the two sources of food, preference for free food quickly develops.

A more general psychological phenomenon for which conditioned reinforcement serves as an explanatory framework is imitation learning. Consider first how talking birds acquire comprehensible vocal behavior. An apparent prerequisite for such vocal behavior is that the bird develop an attachment to its caretaker, so that attributes of the caretaker acquire positive value via their pairings with the primary rewards provided by the caretaker. One of these attributes is the sound of the caretaker's

voice, including specific verbal utterances. The bird then increasingly approximates these sounds because the similarity between the bird's own sounds and those of the caretaker cause the bird's own sounds to have positive value as well. Thus, the closer the bird approximates its caretaker's verbal utterances, the greater the degree of conditioned reinforcement contingent on vocalizing. Close matches will eventually occur because that is when conditioned reinforcement is at its maximum.

The foregoing analysis can be extended easily to a considerable amount of human behavior. The most obvious is the development of the phonetic structure of infant babbling, which evolves from including the entire spectrum of sound to being restricted to only those phonemes in the immediate linguistic community. An increasingly pervasive example is provided by the ubiquitous changes in the language patterns of teenagers. To the chagrin of many parents, an epidemic of speech insertions that serve no semantic function has developed: “you know, “like,” and so forth. These patterns of verbal behavior have spread to a remarkable degree among teenagers, with the result that they often seem to be speaking in their own idiosyncratic dialect. Informal observations suggest that most are unaware that their speech patterns elicit disdain from the adult linguistic community, and they often are unaware that their speech is in fact deviant from cultural norms. The concept of conditioned reinforcement offers a ready explanation for why such behavior is maintained. Teenagers are reinforced by assuming the characteristics of their peers, characteristics that include speech patterns as well as clothes and social customs such as piercing one's body with various metal adornments. The robustness of the behavior in face of adult censure provides striking confirmation of the power of the conditioned reinforcement value of peer-modeled behavior.

The most pervasive of all applications of conditioned reinforcement is the industry of advertising. John B. Watson, who founded Behaviorism as a distinct school of psychology in 1913, was the first to recognize the enormous power of Pavlovian conditioning as a means of establishing value to commodities that were otherwise neutral. After a very successful academic career, in 1920 he was fired from Johns Hopkins University for his sexual misconduct (an affair with a graduate student, whom he later married). After no other universities would hire him, he assumed a job with a major advertising company in New York. His initial marketing research determined that most consumers were unable to distinguish between different brands of the same product when tested

without knowledge of the product brand being tested. He then speculated that it was primarily the associations that were attached to a product name that gave that product its commercial appeal, and he proceeded to demonstrate experimentally that this was in fact the case. Much of the modern industry of advertising continues to be based on that simple idea.

Numerous laboratory experiments, involving many kinds of animals including humans, have demonstrated that the value of many different commodities, objects, and the like, can be systemically changed by their pairing with primary reinforcers. A significant number of these experiments involved gustatory stimuli (tastes), where initially neutral stimuli were paired either with something pleasant (e.g., milkshake) or aversive (quinine). Later when the same tastes were presented in a neutral medium such as water, tastes previously paired with the pleasant substance were rated as much more desirable or pleasant than tastes initially of the same value but not involved in the training procedure. Conversely, tastes that had been paired with the unpleasant substance were rated as much less desirable than tastes that had not been trained. It should be apparent that conditioning taste preferences plays an important role in much of human appetitive behavior. For example, most people do not initially like the taste of beer but quickly develop a positive value for that taste after only a few pairings of the taste with the alcohol in the beer.

Such "Revaluation" experiments have also been conducted with aesthetic judgments. In a typical experiment, pictures (e.g., travel slides) are divided into the categories of pleasant value, negative value, or neutral, and then different sets of the neutral slides are followed in their presentation by either the positive or the negative stimuli. The result has been that the value of the initially neutral slides is changed in the direction of the stimuli that follow them, as assessed by ratings by the subject after the different types of pairings. These changes have been independent of whether the subject had been aware of the different types of sequences. The fact that the subject is unaware of the change in his or her evaluation of the stimuli is of special importance to the advertising industry in that it allows manipulation of the consumer's attitudes and values without the consumer being aware of that manipulation.

The conditioned value of commercial products due to their pairing with primary reinforcers can also be made durable by using several different kinds of primary reinforcers. Conditioned reinforcers that are associated with

several different kinds of primary reinforcer have been labeled "generalized reinforcers" by B. F. Skinner, who assumes that their associations with multiple reinforcers makes them extremely resistant to extinguishing their value. Money is the most obvious example of a generalized conditioned reinforcer.

V. CLINICAL APPLICATIONS OF CONDITIONED REINFORCEMENT

Explicit manipulation of the value of Pavlovian conditioned stimuli, whether positive conditioned reinforcers or conditioned aversive stimuli, plays an important role in various clinical applications. Aversion therapy is the most obvious type of application. Stimuli associated with maladaptive behavior such as smoking or alcoholism have become positive conditioned reinforcers through their pairing with the pharmacological effects of nicotine or alcohol, and thus help maintain the behaviors of smoking or drinking. The goal of aversion therapy is thus to reverse the value of these Pavlovian conditioned stimuli from being positive conditioned reinforcers to being conditioned aversive stimuli. For smoking-related stimuli, the method most commonly used has been the rapid-smoking procedure, whereby the client is encouraged to smoke at a very high rate, thus creating an aversive bodily state that is paired with all of the stimulus properties of smoking. For the aversion therapy treatment of alcoholism, the smell and taste of various alcoholic beverages have been paired with emetic agents that cause nausea and vomiting, in order that these unpleasant bodily states become associated with those alcohol-related stimuli. Such procedures are generally regarded as among the more effective procedures for treating these common addictions.

The role of conditioned reinforcers in maintaining maladaptive behavior is often not fully appreciated. As an example of the practical importance of understanding the dynamics of conditioned reinforcement in clinical settings, consider a recent analysis of the maintenance of smoking behavior and the consequent implications for smoking-cessation treatments. It is now generally acknowledged that the pharmacological reward properties of nicotine are crucial for maintaining smoking behavior, with the result that nicotine replacement, either by nicotine chewing gum or the nicotine skin patch, has become a major therapeutic approach. While a significant improvement in smoking cessation rates, relative to placebo controls, usually

does occur with this approach, the effect is typically small, primarily it seems because nicotine replacement has little impact on the degree of craving for cigarettes, even though it greatly reduces the number of physiological symptoms associated with smoking withdrawal (e.g., nervousness, weight gain). The apparent basis of the persistence of craving in spite of the continued presence of nicotine is that the sensory properties of smoking have acquired hedonic value in their own right, and it is they, not nicotine itself, that are the object of craving. Support for this hypothesis comes from several studies in which various methods of mimicking the sensations of smoking (e.g., inhalation of aerosols of dilute citric acid) have substantially reduced the level of craving, sometimes to a degree comparable to smoking a commercial cigarette. The interpretation of this effect is that the sensory properties of smoking have become conditioned reinforcers that retain their hedonic value even when the subject is in the state of nicotine satiation at the physiological level. The implication is that smoking-cessation treatments must consider the conditioned-reinforcement properties of smoking-related cues as being as important, if not more so, as the primary reward properties of nicotine itself.

The most explicit use of conditioned reinforcement in clinical settings involves token economies in which many different aspects of behavior are monitored and reinforced when appropriate with some type of token that later can be traded for desired commodities. The experimental research on which some applications are based dates to experiments in the 1930s in which chimpanzees were trained to work for poker chips that could be traded for food only after the work session was completed. In the 1960s Teodoro Ayllon and Nathan Azrin, two of the early pioneers in adapting the principles of behavioral psychology to applied settings, administered a token economy in a state psychiatric hospital. Patients received tokens for behaviors such as attending activities on the ward, group meetings, and therapy sessions, and for grooming, making one's bed, showering, engaging in appropriate meal-time behavior, and socially interacting. Tokens could be exchanged for a variety of reinforcers such as cosmetics, candy, cigarettes, and clothing; renting chairs for one's room; ordering items from a mail-order catalog; using a piano or radio; spending time in a lounge; watching television; and having a private room.

Token economies in many other psychiatric settings were developed during the ensuing two decades, and their effects have been systematically compared to the

traditional psychiatric treatments under controlled conditions. Such comparisons have shown token economies to be more successful than traditional treatments in reducing bizarre behavior, improving social interaction and communication skills, and developing participation in activities. Perhaps most importantly, these gains have been reflected in the increased number of patients discharged and in their adjustment in the outside community after termination from the program.

Token economies have been used with a variety of populations in numerous types of settings. Among them are the mentally retarded, nursing-home residents, alcoholics, and drug addicts. Perhaps their most common venue has been educational settings, but they have also been used in day-care centers, prisons, and business and industry.

It is important to keep in mind the two important advantages that token economies have over forms of reinforcement contingencies. First, they allow the immediate delivery of a reinforcer in a nonintrusive way that does not disrupt the stream of behavior. For example, if a retarded child is studying diligently at his desk, presenting a token to the child is much less likely to disrupt his behavior than if the reward were a cookie. Second, because many different types of rewards can be paired with tokens, the idiosyncratic variation among peoples' preferences will not be problematic in determining what type of reward will be an effective reinforcer. For example, some children may be insensitive to the reward of social praise, but they are unlikely to be insensitive to all of the various kinds of things that tokens will purchase.

The major issue in using token economies is how to fade out the tokens and replace them with the more usual social contingencies of praise, the value of a job well done, and the like. The specific techniques used in fading out the token contingencies vary widely with the setting in which the token economy has been implemented, and there is a large professional literature about the procedures necessary to prevent the gains established under the token economy from being lost.

VI. SUMMARY

The present brief review has touched on only the major applications of the concept of conditioned reinforcement. Other interesting aspects of human behavior that potentially could be enlightened by the concept are fetishes, daydreaming, and changing tastes in fashion. Such diversity of applications reflects the basic fact of

human nature that the great majority of the events, activities, and commodities that motivate and reinforce human behavior are creations of our learning histories. The basis of that learning is often obscure because the underlying associations with biologically based rewards are mediated by multiple second-order associations, so that no one individual linkage between a conditioned and primary reinforcers seems essential. Nevertheless, when conditioned reinforcement contingencies are explicitly manipulated, they have been shown to be tremendously powerful determinants of human behavior.

See Also the Following Articles

Behavior Therapy: Historical Perspective and Overview ■
 Classical Conditioning ■ Covert Positive Reinforcement ■

Negative Reinforcement ■ Operant Conditioning ■
 Positive Reinforcement

Further Reading

- Kazdin, A. E. (1977). *The token economy: A review and evaluation*. New York: Plenum.
- Mowrer, O. H. (1950). *Learning theory and personality dynamics*. New York: Ronald Press.
- Paul, G. L., & Lentz, R. J. (1977). *Psychosocial treatment of chronic mental patients: Milieu versus social learning program*. Cambridge, MA: Harvard University Press.
- Rescorla, R. A. (1988). Pavlovian conditioning: It's not what you think it is. *American Psychologist*, 43, 151.
- Skinner, B. F. (1953). *Science and human behavior*. New York: Free Press.
- Williams, B. A. (1994). Conditioned reinforcement: Experimental and theoretical issues. *The Behavior Analyst*, 17, 261.

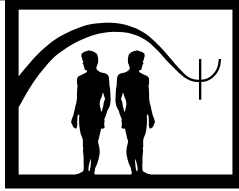

Confidentiality

Norman Andrew Clemens

Case Western Reserve University

- I. Introduction
 - II. Why Confidentiality Is Fundamental to Psychotherapy
 - III. Ethical Foundations of Confidentiality
 - IV. Legal Protections of Confidentiality in Psychotherapy
 - V. Exceptions to the Privilege of Confidentiality
 - VI. Case Illustrations
 - VII. Electronic Communications and Confidentiality
 - VIII. Legislative and Regulatory Developments Affecting Confidentiality
 - IX. Summary
- Further Reading

GLOSSARY

confidentiality Characterizes an understanding between parties in a defined relationship; the necessary ingredient is trust that one party (e.g., a professional or a spouse) will not divulge information about the private life of the other party (e.g., a person using professional services or the other spouse).

privacy An individual person's right to control one's own body, mental life, possessions, and business affairs, with freedom from intrusion, interference, or knowledge on the part of others.

privileged Communication that has special safeguards (e.g., from divulgence or legal action) in a judicial arena or other investigation at law, such as a legislative proceeding. The legal basis of the protection is called a *privilege*.

I. INTRODUCTION

The doctor–patient relationship is the cornerstone of psychotherapy. Fundamental to that relationship is

strict adherence to a code of professional ethics. At the heart of these ethical principles is confidentiality. Skills are also vital to psychotherapy, although effective psychotherapy by a beginner can take place in a well-supervised learning situation. However, ethical behavior, including preservation of privacy and confidentiality, is essential from the very outset of all psychotherapy. Confidential communications are protected by law in certain relationships with an attorney, member of the clergy, physician or mental health professional, and husband or wife. In addition, formal ethical codes of the professions govern physicians, attorneys, and the clergy. Rapidly evolving information systems create many new challenges to confidentiality.

II. WHY CONFIDENTIALITY IS FUNDAMENTAL TO PSYCHOTHERAPY

Effective psychotherapy depends on the patient's feeling safe to be completely frank and candid. Such openness does not develop quickly. The patient has to gain trust in the therapist's ethical reliability not to break confidence or to demean or exploit the patient. Frequently the patient is not aware of deeper motives or feelings, except perhaps through a vague sense of anxiety, and only the work of treatment will bring these to light. Patients also may be aware of motives, feelings, thoughts, fantasies, dream material, or actions that cause painful shame and/or guilt. Only in an atmosphere

of trust and confidence can the patient open the door to these intimate mental contents to another person. Frequently patients explicitly ask for reassurance about confidentiality before embarking on a sensitive topic. The material that emerges is often a surprise to the therapist and even the patient.

Psychotherapy modalities vary considerably in how much they facilitate the patient's divulging sensitive material. Psychoanalytically based treatments (psychoanalysis, psychodynamic psychotherapy) employ methods that encourage free association, the patient's freedom to speak whatever comes to mind. Therapists using these treatments anticipate that part of a patient's mental life is hidden even from the patient. Improvement in symptoms, function, and overall quality of life result from emerging self-knowledge and conscious mastery of hitherto unconscious elements from past experiences or current inner conflicts. Psychodynamic treatments are open to exploring unexpected twists and turns in mental life. Structured, short-term psychodynamic treatments may narrow the scope of what will be addressed, but they nonetheless must be prepared for surprises and have a strategy for dealing with them.

Interpersonal psychotherapy focuses more exclusively on the patient's roles and relationships with other people that frequently generate powerful emotions. Disclosure is essential for the patient and the therapist to know what these really are, so that the patient can understand and manage them better. Cognitive-behavioral therapy requires openness on the part of the patient to observe, identify, and work to control or modify automatic thoughts, dominant patterns of thinking, and repetitive, maladaptive behaviors. Strict behavioral therapies, being focused on the patient's actions rather than inner mental life, may involve less disclosure, but behaviors must be known to be treated, including those that induce shame or guilt in the patient. Regardless of the form of treatment, patients expect a confidential atmosphere, which must be maintained. Being unschooled in the fine distinctions between therapeutic methods, patients may expect or wish to talk about sensitive issues regardless of the chosen format. Sometimes the technique and focus of the treatment will have to change as a result of new revelations by the patient.

Patients commonly talk about their relationships in psychotherapy, which means that extensive knowledge of other people's private lives enters into the therapy. The patient must also feel secure that these people and these relationships will not be harmed as a result of disclosures in psychotherapy. It must be in the patient's

domain alone, not the therapist's, to take actions that affect others or change the nature of relationships.

Even more, the patient must feel secure that disclosures to a therapist will not damage the patient's life situation in any way. This entails protection from prosecution, investigation, harm in civil proceedings, public shame or humiliation, disruption of personal relationships—let alone any kind of exploitation on the part of the therapist. Only when the patient feels that no harm will come from telling the truth can that person take on the task of facing the unknown, understanding mental processes, dealing with consequences, resolving anger, anxiety, shame or guilt, establishing self-control, and realigning one's inner and outer life. This benefit to the patient, and the consequent benefit to society of access to this valuable treatment method, is the basis of legal and ethical protections of confidentiality in psychotherapy.

III. ETHICAL FOUNDATIONS OF CONFIDENTIALITY

The bedrock of ethics in Western medicine lies in the ancient Hippocratic Oath, written around 400 B.C.E. and recited to this day by physicians as they graduate from medical school. From it come these words about confidentiality:

Whatsoever I see and hear concerning the life of men, in my attendance on the sick or even apart therefrom, which ought not to be noised abroad, I will keep silence thereon, counting such things to be as holy secrets.

Another fundamental tenet of Western medicine is *Primum non nocere*—first, do no harm. Confidential information revealed to others can, of course, do enormous personal and financial harm.

Confidentiality remains central to the ethical principles of the healing professions today. The American Medical Association's (AMA's) Principles of Medical Ethics, presented in the Preamble as "standards of conduct which define the essentials of honorable behavior for the physician," state that "A physician . . . shall safeguard patient confidences within the constraints of the law" (Section IV). The American Psychiatric Association (APA) adds to the AMA principles "Annotations Especially Applicable to Psychiatry." The annotation for this section begins,

Psychiatric records, including even the identification of a person as a patient, must be protected with

extreme care. Confidentiality is essential to psychiatric treatment. This is based in part on the special nature of psychiatric therapy as well as on the traditional ethical relationship between physician and patient.

Detailed elaboration deals with the many situations in which confidentiality comes into conflict with other societal needs or interests. Among these is the setting itself in which the treatment takes place: A hospital or multidisciplinary clinic where several professionals may work with a patient poses a different challenge than the private office of a solo practitioner. Other professions that practice psychotherapy have similar ethical positions.

IV. LEGAL PROTECTIONS OF CONFIDENTIALITY IN PSYCHOTHERAPY

The laws of every state of the United States protect medical confidentiality, and, as cited by the U.S. Supreme Court in the 1996 decision in *Jaffee v. Redmond*, all states also have statutes establishing some form of psychotherapist–patient privilege in court proceedings. Laws in various jurisdictions safeguard the confidentiality of patient information, but some also specify situations in which it may or must be superceded by other priorities, such as reporting child abuse or imminent threats of violence. In addition, state professional licensing boards have the right to sanction or remove the license of a practitioner who breaches ethical codes, including confidentiality. Psychotherapy of couples, families, or groups pose special issues in regard to legal protections of confidentiality, because other people are in the room with the therapist and the individual identified as a patient in a legal proceeding. Special measures are usually taken to pledge participants to preserve confidentiality in these situations, but there is little case law to establish whether it could be challenged in court.

Ironically in comparison with the states, a privilege protecting confidential psychotherapy information in federal courts was nonexistent until recently. This changed radically in 1996 when the U.S. Supreme Court handed down a decision regarding the admissibility of psychotherapy data as evidence in federal courts in *Jaffee v. Redmond*. Although this decision technically applies only to rules of evidence in the district in which the case arose, it has been highly influential in subsequent decisions in the states as well as federal courts. Its rationale and authority have also been used to advocate for legislation and/or regulation

to protect the confidentiality of information obtained during psychotherapy.

Jaffee v. Redmond arose from an incident in which a female police officer shot and killed a man who appeared about to stab another person. The officer subsequently was so distressed that she sought psychotherapy with a social worker. The family of the deceased suspect sued the officer and the city for damages. The psychotherapist refused to testify or divulge the records of her patient, and the case was ultimately appealed to the U.S. Supreme Court. Many professional organizations submitted *amicus curiae* briefs in this case, including the American Psychiatric Association, the American Psychological Association, and a consortium of psychoanalytic organizations.

In a strongly worded decision with only one dissent, the Court ruled in favor of protecting confidentiality of psychotherapy as an absolute privilege on a par with the attorney–client privilege. (Although general exceptions may exist for an absolute privilege, e.g., breach of confidence to prevent imminent bodily harm, the privilege may not be subjected in individual cases to a balancing test against other compelling needs, such as the full disclosure of evidence.) The rationale for the *Jaffee* decision rested on the fact that effective psychotherapy, an important social good, could not take place without the patient's being able to place complete trust in the confidentiality of communications in treatment. In the Supreme Court's words:

Effective psychotherapy ... depends upon an atmosphere of confidence and trust in which the patient is willing to make a frank and complete disclosure of facts, emotions, memories, and fears. Because of the sensitive nature of the problems for which individuals consult psychotherapists, disclosure of confidential communications made during counseling sessions may cause embarrassment or disgrace. For this reason, the mere possibility of disclosure may impede development of the confidential relationship necessary for successful treatment.

The decision clearly affects psychotherapy regardless of the profession of the psychotherapist, specifically in this case a social worker.

Because the *Jaffee* decision of the Supreme Court applies specifically and only to psychotherapy and establishes an absolute privilege, it can be convincingly argued that the decision protects information revealed in psychotherapy more than ordinary health data or even information about especially sensitive conditions,

such as mental illness, addictions, HIV–AIDS or genetic abnormalities.

V. EXCEPTIONS TO THE PRIVILEGE OF CONFIDENTIALITY

In all exceptions to psychotherapist–patient confidentiality the prevailing concern of the psychotherapist must be to limit disclosure as stringently as possible, consistent with the purpose that necessitates disclosure. At times the psychotherapist may be more vigorous than the patient in defense of confidentiality because of potential damage not only to this patient but also to the trust of other people who contemplate entering psychotherapy.

A. Prevention of Harm to the Patient or Others

The most compelling exceptions to the confidentiality of psychotherapy have to do with preventing physical harm to the patient or other people. For example, a psychotherapist could act to hospitalize a patient to prevent imminent suicide or to treat a psychosis in which the patient could do irreparable damage. In most instances this breach of confidentiality would be considered defensible. Some but not all jurisdictions have specific requirements that health professionals warn potential victims of imminent homicidal behavior, and some require reporting of abuse of children and/or elderly people. Judicial precedent also exists in the landmark *Tarasoff* case in California state courts, in which a “duty to protect” potential victims of violence was stated.

The requirement to report child or elder abuse raises dilemmas for psychotherapists in situations where the long-term achievement of understanding and ending the abuse may be derailed by breach of trust and confidence resulting from mandatory reporting to the authorities. Some therapists warn the patient in advance that legal statutes require them to report abuse revealed to them by the patient. The disadvantage of this approach is that the patient may fail to reveal a central, serious problem so that it can be addressed in psychotherapy. Such warnings would be antithetical to the basic rule of psychoanalysis and render it impossible to establish a treatment process. On the other hand, confronting an ongoing, seriously damaging behavior pattern and invoking external restraint to stop guilt-provoking, out-of-control activities may facilitate treatment by challenging denial, limiting discharge

through action, and bringing the issues under clearer scrutiny in the treatment situation.

Ethical codes also acknowledge the fact that clinical or legal requirements may force a breach of confidentiality. The AMA Principles of Medical Ethics cited earlier qualified its confidentiality statement by adding the phrase “within the constraints of the law.” The APA annotation states that “Psychiatrists at times may find it necessary, in order to protect the patient or the community from imminent danger, to reveal confidential information disclosed by the patient.”

B. Disclosure Authorized by the Patient

Patients frequently sign consent forms permitting blanket disclosure of clinical information to process claims for insurance benefits. Such perfunctory consent forms at the outset of a treatment relationship cannot be considered to be informed consent, because the patient does not know the nature of the information to be disclosed, when or to whom disclosure will take place, and what use of it will be made by the recipient of the information. It is essential that the therapist discuss with the patient the full implications and risks of waiving confidentiality for a specific disclosure. One should document the informed consent with the patient’s signature, the date, a defined recipient, and often details about what may or may not be divulged and a finite time period during which the authorization is valid.

Authorization is also required for disclosure to another health care professional because of transition to another therapist or concurrent treatment by another clinician, such as a patient in psychotherapy by a social worker who is working with a psychiatrist to manage medications. Therapists may obtain supervision or consultation without the patient’s authorization, in which case the supervisor or consultant is fully bound by the constraints of confidentiality.

The rise of managed care, which now covers over 175 million Americans, has raised many issues about confidentiality. Patients and therapists are reluctant to reveal information from psychotherapy to managed care reviewers whose identities and professional qualifications are unknown, and to accept unwanted interference in the therapeutic approach, to obtain approval for payment for therapy. As a result many skilled and experienced psychotherapists refuse to contract with managed care organizations. New government regulations to be discussed later will limit communications

with third-party payers to the minimum necessary to accomplish the essential purpose.

C. Does Limited Disclosure Invalidate Confidentiality?

An important unresolved issue is whether the fact of having made a disclosure for any reason totally invalidates the psychotherapy privilege in subsequent legal proceedings. A New York state court opinion in 2000 took the position that limited disclosure to warn a potential victim of violence did not waive the psychotherapy privilege. Revelation of limited information such as a diagnosis for insurance claim purposes does not invalidate the psychotherapy privilege. To minimize the risk to the privilege it is important to separate a therapist's notations about the specific contents of psychotherapy from administrative information about the broader clinical care of the patient.

D. Disclosure Required Because of Legal Action Initiated by the Patient

When a patient initiates a legal matter in which her medical condition is at issue, she generally waives the privilege of confidentiality of general medical records. The records from all relevant health care providers are likely to be open to the court and to attorneys for both plaintiff and defendant. Common examples are claims for damages for physical or mental harm due to accidents and claims against employers for work-related disability determinations. However, it may still be possible to maintain the privilege of confidentiality of psychotherapy records. Psychotherapists tend to oppose the release of information regarding the contents of psychotherapy, using the arguments associated with *Jaffee v. Redmond*. The resolution of such difficult situations commonly involves review of the records by the presiding judge *in camera* to select for disclosure only information relevant to the case at hand. Strong opposition to exposing the details of psychotherapy is essential to minimize the misuse of records by attorneys for "fishing expeditions" or to harass or embarrass opposing litigants and their relatives or associates.

If the patient initiates malpractice litigation or a complaint to a licensing board against her psychotherapist, the patient's psychotherapy records may be used without authorization in the investigation and adjudication of the matter. Full and fair investigation of an ethics complaint to a professional organization against

a psychotherapist necessitates the patient's authorization of access to psychotherapy records and information. Professional colleagues conduct the investigation within the ambit of confidentiality.

E. Law Enforcement

Criminal investigators sometimes seek access to mental health care records to identify potential suspects. Therapists are ethically obligated to resist such unauthorized intrusions into patients' psychotherapy notes by every available legal means. Investigations of health care professionals for possible insurance fraud and abuse or violations of state professional codes may also bring law enforcement officers to a therapist's office demanding to see records. Although legal or ethical violations by a therapist cannot be condoned, establishing due legal process and procedural safeguards to protect patients' private information is an indispensable obligation of all parties to such an investigation.

F. Research

Participation in research studies requires the patient's full and informed, written consent. If the patient is not available to give consent for retrospective studies, the optimal condition is that only information completely devoid of all identifying information may be used, with suitable safeguards to prevent the cross-linking of deidentified data with other identifying databases. Psychotherapy advocates take the position that the preservation of the full confidentiality of psychotherapy must take precedence over potential benefits of research investigation. Institutional review boards commonly scrutinize proposed research for protection of confidentiality but may not be fully cognizant of the special requirements for confidentiality in psychotherapy.

VI. CASE ILLUSTRATIONS

A. Mr. A.

A man in his late 40s in his seventh psychotherapy session, Mr. A. paused and then asked his psychiatrist if everything he said was truly confidential. The psychiatrist replied that within the limits of the law, and with the exception of any emergency involving threat to life and limb, confidentiality would be maintained. The psychiatrist added that she would actively use all legal means to resist any efforts to intrude in any case. Mr. A. then haltingly revealed, with great shame, that

he had disturbing sexual thoughts about his teenaged daughter. They went on to work with the origins of these thoughts in his own early sexual experiences in family life. Both the intensity of the thoughts and the shame about them diminished, and the patient felt comfortable that he could control any such impulses in the future.

If the therapist had responded to this revelation as potential abuse and reported it to the authorities, the patient and his family would have been harmed, and he would not have had the opportunity to master the conflict within himself. The case also highlights the fact that psychotherapy may open doors to discussion of fantasies, dreams, and impulses on which the patient would be highly unlikely to act. An important tenet of psychotherapy, not always understood in everyday life, is that thought is not the same as action. In mental life people may have extreme thoughts and feelings or consider seriously problematic behaviors before deciding on a more reasonable course of action.

B. Mr. B.

A managing partner of a major law firm, Mr. B., brought to psychotherapy complicated, sensitive difficulties involving a number of prominent people in business and politics in his community. He was in the initial stages of his own candidacy for the state legislature. For him to work effectively in psychotherapy to understand his feelings and judiciously manage his delicate role in the situation, he had to be absolutely sure that all information regarding situations, himself, and other persons would remain totally confidential.

C. Mrs. C.

Mrs. C. was involved in an extramarital affair that was not going well. She wanted to preserve and rehabilitate her marriage, but divorce was a possibility. She felt she could only work out her conflicting issues if the affair would remain a secret that would be divulged only by her if at all, after due consideration and not by intrusion into her therapy records.

D. Joe D.

Joe D. is a 19-year-old boy devastated by the loss of his girlfriend to another man. In psychotherapy he ventilated his rage and expressed the wish to use his old truck to push the other man's car off a cliff. By verbalizing fury in this way, he gradually settled down and

avoided impulsive, dangerous action. The case illustrates the fact that patients sometimes reveal drastic impulses on which it would be very uncharacteristic for them to act, and that expressing them both relieves pressure and provides opportunities to reinforce self-control. In a psychotherapy record in court such statements could be misinterpreted without consideration of the treatment context in which the therapist evaluated them and concluded that they presented no significant risk of harmful action.

E. Officer Mary Lu Redmond

Mary Lu Redmond, the policewoman defendant in the U.S. Supreme Court case, *Jaffee v. Redmond*, would have been unable to enter psychotherapy to deal with her distress about having killed a man in the course of duty, had she known that what she said could be used in a civil action against her. The U.S. Supreme Court stated that neither the public interest nor equity would be served by denying police officers access to psychotherapeutic care that was available to the rest of the community.

VII. ELECTRONIC COMMUNICATIONS AND CONFIDENTIALITY

Health care records have traditionally been maintained on paper. Electronic communications by fax, e-mail or the Internet now present a much broader risk of instant disclosure to unauthorized entities. Medical records maintained in a computer database may be useful in coordinating care by many different health care providers, but they can potentially be used by insurance companies to deny health, disability, life, or even auto insurance. Insurance carriers maintain a central medical information bureau that underwriters can access. This facilitates discrimination against people with mental illness. Health insurance claims to self-insured employers have sometimes been used to make employment decisions. With growing consolidation of the banking, investment, and insurance industries, records of payments by check to psychotherapists could be revealed to an insurance carrier that is part of the financial organization and be used to deny insurance coverage. Recent revelations regarding FBI access to e-mail communications, without the knowledge of individuals using an Internet service provider, raise serious questions about the use of e-mail for communications with a physician or for long-distance psychotherapy. Studies of methods to deidentify

health care information have demonstrated that the possibilities for cross-linking with widely available databases make it perhaps impossible to remove potentially identifying data without totally corrupting the data and making it unreliable. Privacy advocates in the psychotherapy community caution against the use of electronic means for storing or communicating information regarding psychotherapy without very high standards of protection through encryption, audit trails, and thoroughly erasing records that are no longer active.

VIII. LEGISLATIVE AND REGULATORY DEVELOPMENTS AFFECTING CONFIDENTIALITY

These issues have prompted efforts to establish privacy regulations for electronic communications and databases, both in health care and in the business world. Privacy advocates are staunchly opposed by powerful forces in the insurance industry, financial institutions, public health agencies, medical and demographic research, and electronic communications industries. In 1996 the U.S. Congress appointed the National Committee on Vital and Health Statistics, representing the broad spectrum of interested parties, to investigate the problem and recommend solutions. The committee's report thoroughly discussed the issues and proposed actions that remain controversial. The Congress also set a deadline of 1999 for itself to develop health care privacy legislation, and if it failed to do so, tasked the Department of Health and Human Services (HHS) to develop privacy regulations in the Health Insurance Portability and Accountability Act (HIPAA). Many bills failed to reach enactment in Congress, and in August, 1999, HHS proposed a set of regulations for health care information transmitted by electronic communications. The proposed regulations also devoted attention to preventing unauthorized secondary disclosure to other entities by entities that had received authorized data. After analyzing a record-setting 52,000 comments on the draft regulations, HHS in the Clinton administration promulgated the final HIPAA regulations in December, 2000, to take effect in April, 2003.

The final regulations extend to all medical records, electronic or otherwise, and set national standards without invalidating stricter state statutes. In contrast to the draft regulations, they retain the customary requirement of initial patient consent for the release of medical information for treatment operations and claims processing purposes. They also establish a higher level of authorization required for disclosure of

specific information for certain purposes. Patients will be allowed to inspect their general medical record and require corrections or insert comments if they take issue with the information it contains. Employers may not have access to health care records without patient authorization. The lengthy and complex regulations are undergoing extensive analysis by all stakeholders at the time of this writing, so that any interpretations are provisional. Companion regulations of security procedures, such as encryption and audit trails, essential to the successful application of the privacy regulations, remain to be promulgated. Although already published in the Federal Register, the privacy regulations may be subject to modification by Congress or the Bush administration.

Citing *Jaffee v. Redmond*, the HIPAA regulations propose a high level of specific protection for psychotherapy notes. Psychotherapy notes—the psychotherapy part of the identifiable medical record—are singled out from medical records in general for protection from unauthorized disclosure. The regulations apply to individual, group, marital, and family therapy. Authorization for disclosure must not be a required precondition for treatment or insurance eligibility, enrollment, or payment for treatment. However, psychotherapy records may be disclosed without patient authorization for health care oversight (e.g., investigation for fraud or violation of professional licensing codes) or defense of litigation against the therapist. There is also an exception “when needed to avert a serious and imminent threat to health and safety.” Notes may be disclosed to coroners or medical examiners to determine the cause of death. “Consent” is required to use notes to “carry out treatment” or for supervision in training. Many other details and ramifications remain unclear.

IX. SUMMARY

Confidentiality is essential to the work of psychotherapy. It is protected both by professional ethical standards and state law. The U.S. Supreme Court decision in *Jaffee v. Redmond* in 1996 established an absolute privilege protecting information from psychotherapy from use as evidence in federal courts. This decision has been influential in the state courts as well as in comprehensive HIPAA privacy regulations that will take effect in 2003. Numerous threats to the privacy of psychotherapy information nonetheless exist in a rapidly expanding environment of information gathering and exchange. They must be addressed by the individual practitioner,

professional organizations, and the public at large through vigorous advocacy efforts.

See Also the Following Articles

Bioethics ■ Documentation ■ Economic and Policy Issues
 ■ Informed Consent ■ Legal Dimensions of Psychiatry ■
 Online or E-therapy

Further Reading

American Psychiatric Association. (1999). *Documenting psychotherapy by psychiatrists*. Washington, DC: Author.
 Appelbaum, P., & Gutheil, T. (Ed.). (1991). *Clinical handbook of psychiatry and the law* (2nd ed.) Baltimore: Williams & Wilkins.

Bollas, C., & Sundelson, D. (1995). *The new informants: The betrayal of confidentiality in psychoanalysis and psychotherapy*. Northvale, NJ and London: Jason Aronson.
 Edwards, R. (Ed.). (1997). *Ethics of psychiatry*. (pp. 263–281). Amherst, NY: Prometheus Books.
 Etzioni, Amitai. (1999). *The limits of privacy*. New York: Basic Books.
 Jaffee v. Redmond, 518 U.S. 1 (1996). (Accessible, along with numerous *amicus* briefs and information about subsequent developments at www.jaffee-redmond.org)
 Slovenko, R. (1998). *Psychotherapy and confidentiality: Testimonial privileged communication, breach of confidence, and reporting duties*. Springfield, IL: Charles C Thomas.
 U.S. Department of Health and Human Services. *Final standards of privacy for individually identifiable health information*.
 Wettstein, R. (1994). Confidentiality. *Review of Psychiatry* 13, 343–364.

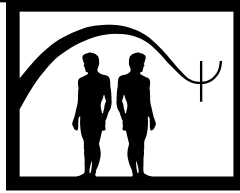

Configurational Analysis

Mardi J. Horowitz

University of California, San Francisco

- I. Description of Treatment
- II. Research Issues
- III. Use of Configurational Analysis
- IV. Defining What Changes in Psychotherapy
Further Reading

GLOSSARY

configuration An association of meanings whereby each set of meanings is given a position relative to the other sets.

motives A term that refers to the intrapsychic reasons for explaining why a mental process occurs. A given subsystem of mental processes may contain intrinsic properties that function as motives when that subsystem is activated. There may be motives to do or not to do an act or to perform or not perform a mental function.

person schemas High-order, well-organized views of self and others. Person schemas are psychological meanings that reflect identity, relationships, and potential social activities.

psychodynamic configuration A constellation of motives and person schemas that organize information processing, intentions, and expectations. These configurations include beliefs, wishes, fears, and defensive strategies. A conflictual configuration often involves a *wish*, a *threat* of a dreaded state, and a *defensive posture*. The defense is a way of compromising the wish to avoid its feared consequences.

role-relationship models Inner schemas and scripts that function as cognitive maps for interpersonal emotions and transactions. They can be activated unconsciously as well as consciously. Roles for self in such models contribute to a sense of identity, and the roles of self and other can define a sense of affiliation and attachment.

schemas Usually, unconscious cognitive maps that can serve as organizers in the formation of thought. Schemas influence how motives reach conscious awareness as well as how external stimuli are interpreted. Schemas tend to endure and to change slowly with integration of new information. Small-order schemas can be nested into hierarchies such as configurations of role-relationship models for a particular attachment.

I. DESCRIPTION OF TREATMENT

Configurational analysis is a method of psychological formulation that focuses on cognitive-emotional conflicts and the dynamics of identity and relationship roles. It combines concepts derived from psychodynamic, interpersonal, cognitive-behavioral, and family systems theories. It also integrates ego-psychology, object relations, and self-psychology methods of formulation. Configurational analysis is a simplified, practical, and teachable system based on agreements reached in clinical research.

Configurational analysis is a system that can be used for initial case formulation, case reformulation during treatment, and analysis of what changed after treatment. The steps most repeated in all three operations involve state analysis, control of emotional topics analysis, and person schematic analysis, which clarifies the deeper organization of emotional and conflicted themes by varied views of and beliefs about self and others. These steps can explain recurrent and maladaptive

interpersonal patterns as well as some psychiatric symptoms and syndromes.

The system is an integrated one that combines concepts from various schools of thought. It uses definitions that were developed in a clinical research effort and that combine concepts from psychodynamics (with its varied schools), social systems theory (with its attention to roles and social schemas), and cognitive science (with its connection to neurobiological systems).

By repeating the steps of configurational analysis successively from the perspectives of initial formulation, formulation of therapy process, and formulation of therapy outcome, clinicians can increase specifications of what changed and how that change came about. The result empowers clinicians as their own researchers and can improve their clinical effectiveness, their ability as teachers, and their sense of personal growth.

Configurational analysis begins with an emphasis on what can be observed and reported. The objective phenomena then to be explained may be symptoms or patterns of maladaptive interpersonal behavior. Next, the states of mind in which these phenomena occur are described, including those states with variants. This method of formulation includes paying attention to defensive controls of emotional and relationship expressions. At the level of states, this means attention to degrees of regulation of action and feeling as in undermodulated states (impulsive behavior, intrusive ideas, and floods of emotion), well-modulated states (deliberate expression of emotional intensity), and overmodulated states (rigidity, pretense, or stifling of unwanted experiences).

These states of mind can be examined in terms of wishes, fears, and defenses against expressions in thought and action. That is, a person may desire certain states, dread others, and enter a particular state (such as aloof indifference) as a defensive compromise. An initial *configuration* emerges from such an analysis. This configuration is the relative association of desired, dreaded, and compromise states that occur in a recurrent maladaptive cycle.

This cycle of states may then be further examined for important topics of concern and the defensive control processes that are used to control intense and alarming levels of emotion. In this third of the four steps of configurational analysis (phenomena, states, topics-and-controls, self-other views), the reasons for the repeated maladaptive cycle are partly clarified. This effort at lucidity is continued in the fourth step, which infers self and other views that organize different states of mind. This leads to a configuration of *role-relationship models* and the states in which they

do or do not occur. In this approach to formulation, one then integrates the inferences and plans a treatment strategy. These steps of configurational analysis are summarized in Table 1.

The four principal steps of configurational analysis function as a formulation of the initial or current condition of a patient to be treated by psychotherapy. The following paragraphs provide condensed instructions for clinicians who use this method.

Step 1. Phenomena to Be Explained

List symptoms, signs, problems, or specific sets of maladaptive traits. Separate the initial complaints made

TABLE 1
Steps of Configurational Analysis

(Each step can also include social and biological levels as well as past developmental contributors to the current situation.)

1. PROBLEMS
Select and describe the symptoms, life problems, and/or maladaptive character traits that need to be explained.
 2. STATES OF MIND
Describe states in which the selected phenomena do and do not occur as well as recurrent maladaptive cycles of states. Organize these when possible into configurations of desired states, dreaded states, and compromise states.
 3. TOPICS OF CONCERN
AND DEFENSIVE CONTROL PROCESSES
Describe topics of concern during problematic states. Describe how expressions of ideas and emotions are obscured. Infer how avoidant states may function to ward off dreaded, undermodulated states. Describe differences in emotional styles in desired, dreaded, and compromise states. Describe how control shifts lead to a shift in state.
 4. IDENTITY AND RELATIONSHIPS
Describe organizing roles, beliefs, and scripts of expression in each state. Describe wish-fear dilemmas in relation to desired and dreaded role-relationship models. Infer how defensive control processes and compromise role-relationship models ward off dangers. Identify dysfunctional attitudes and how these are involved in maladaptive state cycles.
 5. INTEGRATION
Consider the interactions of problems, states, controls, and role-relationship modes. Plan how to stabilize working states by support, how to counteract defensive avoidances by direction of attention, and how to alter dysfunctional attitudes by interpretation, trials of new behavior, and repetitions.
-

Source: Horowitz (1997).

by the patient from those reported subsequently. List difficulties the observer recognizes but the patient does not complain of directly. Include both intrusions and omissions from rational consciousness and behavior. Intrusions are episodes of consciousness or action that are unwanted, unbidden, or hard to dispel, such as an impending sense of doom, an unwelcome repetition in memory, images of a traumatic event, or a temper outburst. Omissions include the absence of desired and adaptive experiences or actions, such as inability to become sexually aroused, inability to recollect a loved one, and failure to confront the implications of important situations. Indicate how these symptoms and signs occur in current life outside the session, how they developed in the past, and if and when they were observed directly in the clinical setting.

Step 2. States of Mind

List recurrent states and define them by patterns and discords of verbal and nonverbal behavior, as well as by reports of subjective experiences. Indicate common shifts between states and triggers for entry into undermodulated states. Begin with states that contain the major distressing phenomena described in Step 1. These are often undermodulated states. Next list states that seem more controlled and complete the list with overcontrolled states of mind. The term shimmering state can be used to define states in which mixed and contradictory signs occur (e.g., tearing and stifling sadness). Discuss which states are desired, which are dreaded, and which are defensive compromises that reduce pleasure but prevent the risk of unpleasurable states.

Step 3. Topics of Concern and Defensive Control Processes

Describe unresolved and conflictual topics. These are often the themes associated with repetitive intrusions into and omissions from adaptive trains of thought. Model these themes as constellations of ideas, emotions, and cognitive maneuvers to control emotion such as inhibition of ideas, shifts in topic, and distortions of appraisals.

State why it has been hard for the person to reach a point of resolution, decision, or acceptance on a problematic topic. Relate constellations of memory and fantasy to recent life events, psychosomatic reactions, and social situations. State the degree to which objective reality accords with the subject's subjective beliefs. Identify dysfunctional beliefs. Indicate the subject's stress-induced versus habitual use of defensive operations. Relate different defenses, resistances, or obstacles to the different states of mind noted in Step 2.

Step 4. Identity and Relationships

Extend inferences about dysfunctional beliefs to cover erroneous views of self and others. Develop a role-relationship model for each important state of mind in the state cycle. From these, infer configurations of desired, dreaded, problematic compromise, and quasi-adaptive compromise role-relationship models. When there is sufficient information, reconstruct the development of the dysfunctional beliefs contained in these person schemas. Describe the degree of integration and harmonization of schemas or the lack thereof, as in extreme, irrational, contradictory, or dissociated views of self or others.

Configurations of desired, dreaded, and defensive compromise role-relationship models are the deepest level of inference in this method of formulation. They explain recurrent states. Compromise role-relationship models organize states that avoid the feared consequences embedded in wish-fear dilemmas. These compromise role-relationship models avoid the dilemma of linked desired and dreaded intentions and expectations. Defensive controls can activate such compromise role relationships.

Formulating the patient's defensive styles (Step 3) before formulating their role-relationship models (Step 4) helps the clinician find person schematic beliefs in two ways. First, when heightened defenses are observed, the topics that come up provide a focus for discovering unexpressed beliefs that are conflictual, unresolved, antithetical, or contradictory. Second, by asking how and why increased defensiveness has occurred at this moment, the therapist and patient can learn to counteract otherwise automatic avoidances and distortions. As a result, the patient will be able to express usually warded off ideas and feelings.

For example, consider a patient in psychotherapy for the maladaptive effects on his life from his Narcissistic Personality Disorder. He defensively used externalization of blame by sliding meanings to exaggerate the faults of others and to minimize his own role in disputes. He did this to prevent entry into a dreaded sense of identity inferiority and shame.

Analysis of episodes of blaming others excessively clarified his surface role as a superior righteous person and as a critic who said whether self or other was at fault or was inferior or superior. It also clarified his deeper role as an inferior shamed person.

During psychotherapy, the importance of the critic role in the patient's preconscious thinking was emphasized, and this then heightened his level of self-observation. He was later able to use such heightened self-observation to examine his vulnerability to shame, modify his irrational expectations of devastation from

shame, and so curb his automatic tendency to expressively blame others. This in turn modified his maladaptive interpersonal pattern.

This patient desired to experience a state organized by self as good and strong and others as approving, leading to pride. But he dreaded an opposite state of devastated shame organized by a dreaded role as bad and inferior. In a compromise self-righteous rage state, this patient had a role-relationship model in which he was strong and good, facing a bad adversary, with the sense of a critic allied with himself. He was the admired, heroic avenger doing virtuous battle. When a transition into a problematic mixed state of shame, rage, and anxiety occurred, he shifted to a role-relationship model in which his harm to others was excessive, the adversary was wronged, and he sensed a critic allied with his opponent. Expectations of accusation from the critic role led to a role-relationship model of an inferior and bad self being degraded by a strong and good other, leading into his state of devastated shame.

His mixed state of shame, rage, and anxiety occurred before, sometimes instead of devastated shame. In the mixed state he was anxious as to who was to blame, ashamed at his part, but also angry at the bond established between the sensed critic and his opponent. Clarification required conscious examination of beliefs in each of these recurrent states. Then the source of his vulnerability to share and his defensive externalization of all blame by irrational projections were examined. For example, shifts in blaming characterized his family. Each person in the mother–father–son triad was alternately admired and blamed for problems by the other two. He was periodically allied in distortions and abandoned by extrusions.

II. RESEARCH ISSUES

Following the publication of *States of Mind: Configurational Analysis of Individual Personality*, the method was systematized in empirical research. These investigations evolved definitions of states of mind, defensive control processes, and person schemas that could be agreed upon with the reliability of independent judges. With reliable measures of these constructs, validity was evaluated by seeing how well patterns cohered and associated with other variables. The key elements in configurational analysis—states of mind, defensive control processes, and person schemas—that were found to have reliability and predictive validity were then put together into an updated system presented in *Formulation As a Basis for Planning Psychotherapy Treatment*.

III. USE OF CONFIGURATIONAL ANALYSIS

The psychiatric diagnosis system is based on categories of description rather than categories of etiology. For that reason, it is hard to relate diagnosis to rational psychotherapy plans. An intervening case formulation is needed. Configurational analysis provides a system for such formulations. The steps are few, and the clinician can keep them in mind.

As has already been discussed, the steps start at the surface of observation: signs and symptoms. The next step organizes these and other phenomena into states of mind, maladaptive but recurrent cycles of state shifts, and it stipulates the emotional topics that lead to such shifts. When emotional conflicts are partially identified, it is possible to infer deeper levels of state organization in terms of models (person schematizations), configurations of desired, dreaded, and defensive self-concepts, and role relationships. In each role-relationship model, characteristics, traits, emotions, values, intentions, and expectations of self in relation to an important other are considered. Such configurations help us to understand how people may have multiple and contradictory views.

Aspects of formulation using the configurational analysis method can be discussed with a patient. State analysis is especially close to experience and can enhance self-observation. Change can occur during the process of enhanced awareness, new decisions, and trials of new expressive behaviors in psychotherapy.

In addition to initial case formulation, change can be described using configurational analysis: What phenomena are new and what phenomena have gone? What states of mind have been modified? What new and less defensive modes of awareness and expression have altered a habitual style? What new insights and plans counteract irrational beliefs? Such analyses can answer the question, “what can change” in psychotherapy.

IV. DEFINING WHAT CHANGES IN PSYCHOTHERAPY

The steps of configurational analysis, once learned as a systematic approach to early case formulation, can be applied to the study of process and outcome of therapy. A pathway is indicated as a sequence of 10 steps outlined in this entry. These steps can answer the question, “What changes in psychotherapy, and how does it come about?” The steps repeat the steps of configurational analysis from three perspectives: initial evaluation, therapy process, and treatment outcome.

A. Formulating the Initial Condition

The initial condition is formulated using the four steps already described. The following steps (5–10) are repetitions of steps 1–4 as related to analyzing the therapeutic process and formulating treatment outcomes.

B. Analysis of Therapeutic Process

Step 5. Problems and States of Mind

Review symptom changes that occurred during treatment. Focus on entry into and exit from the states listed in Step 2 as they (a) occur in therapy or are reported for (b) current outside-of-session relationships, and (c) past relationships. Describe the states of the therapist and the therapist and patient as a pair or group. Describe the effect of therapist interventions on states. Include the effects of medication and social situational changes.

Step 6. Topics of Concern and Defensive Control Processes

Describe the effects of the therapist's interventions on key themes and defenses.

Step 7. Identity and Relationships

Discuss the effects of transference, countertransference, therapeutic alliance, separations, and new attachments. Indicate the dilemmas of the therapist. Describe new relationship experiences and reschematization of identity and role-relationship models.

C. Formulation of Treatment Outcome

Step 8. Problems and States of Mind

Describe outcome in terms of changes from pre- to post-therapy (or termination) periods. Include discussion of the effects of external changes, including shifts in family, social, and environmental contexts. Discuss new states and modifications of state cycles.

Step 9. Topics of Concern and Defensive Control Processes

Describe outcome in terms of changes in the topics of concern. Indicate resolutions of conflicts as well as residual problematic themes and continued dysfunctional avoidances or distortions.

Step 10. Identity and Relationships

Describe changes (or persistence) in maladaptive interpersonal behavioral patterns. Infer the changes and developments in person schemas. Include modifications in enduring attitudes, value hierarchies, and personal agendas.

By repeating the steps of configurational analysis successively from the perspectives of initial formulation, formulation of therapy process, and formulation of therapy outcome, clinicians can increase specifications of what changed and how that change came about. The result empowers clinicians as their own researchers and can improve their clinical effectiveness, their ability as teachers, and their sense of personal growth.

See Also the Following Articles

Control Mastery Theory ■ Formulation ■ Psychodynamic Group Psychotherapy ■ Structural Analysis of Social Behavior ■ Supportive-Expressive Dynamic Psychotherapy ■ Time-Limited Dynamic Psychotherapy

Further Reading

- Horowitz, M. J. (1979/1987). *States of mind: Configurational analysis of individual psychology*. New York: Plenum Press.
- Horowitz, M. J. (1981). Self-righteous rage and the attribution of blame. *Archives of General Psychiatry*, 38, 1233–1238.
- Horowitz, M. J. (1988). *Introduction to psychodynamics: A new synthesis*. New York: Basic Books.
- Horowitz, M. J., (1998). *Cognitive psychodynamics: From conflict to character*. New York: John Wiley & Sons.
- Horowitz, M. J., (Ed.). (1991). *Person schemas and maladaptive interpersonal patterns*. Chicago: University of Chicago Press.
- Horowitz, M. J. (1997). *Formulation as a basis for planning psychotherapy treatment*. Washington, DC: American Psychoanalytic Press.
- Horowitz, M. J., Marmor, C., Krupnick, J., Wilner, N., Kaltreider, N., & Wallerstein, R. (1984). *Personality styles and brief psychotherapy*. New York: Basic Books.
- Horowitz, M. J., & Stinson, C. H. (1995). Consciousness and processes of control. *Journal of Psychotherapy Practice and Research*, 4, 123–139.
- Horowitz, M. J., Znoj, H., & Stinson, C. H. (1995). Defensive control processes: Use of theory in research, formulation, and therapy of stress response syndromes. In M. Zeidner & N. Endler (Eds.), *Handbook of coping* (pp. 532–553). New York: John Wiley & Sons.

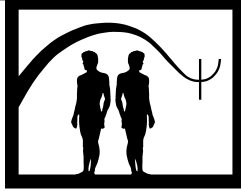

Confrontation

W. W. Meissner

Boston Psychoanalytic Institute and Boston College

- I. Meaning of Confrontation
 - II. Confrontation versus Interpretation
 - III. Clinical Application
 - IV. Countertransference and Confrontation
 - V. Regression
 - VI. Confrontation and the Therapeutic Alliance
 - VII. Dealing with Denial
 - VIII. Narcissism
 - IX. Summary
- Further Reading

parameter (adjective parametric) Technical intervention beyond or in addition to ordinary use of interpretation, confrontation, clarification, or limit-setting.

reality testing Ego function discriminating thought from perception, fantasy from reality.

therapeutic alliance Component of therapeutic relationship facilitating collaboration and cooperation between therapist and patient in the work of therapy.

GLOSSARY

clarification Technique for gaining clearer understanding of the meaning of a patient's conscious (manifest) behavior and experience.

confrontation Technique of directing a patient's attention to inner experiences or perceptions of outer reality of which he or she is conscious or is about to be made conscious.

countertransference The therapist's unconscious feelings and attitudes toward the patient reflecting his or her earlier experiences with important others.

interpretation Verbalized understanding of meaning, conscious or unconscious, of patient behavior or experience.

introjection Form of internalization that acts as part of self-structure (i.e., self-as-object) and is reflected either consciously or unconsciously in self-representations. They form the basis for projections and are invested in varying degrees with infantile motivations. Aggressive patterns are expressed as either aggressive (hostile, sadistic) or victim (vulnerable, masochistic) introjects, narcissistic patterns as either superior (grandiose) or inferior (devalued) introjects.

I. MEANING OF CONFRONTATION

To begin, we should be clear about exactly what we mean by "confrontation," namely a technique designed to draw the patient's attention to certain inner experiences or perceptions of outer reality. Confrontation comes into play typically in an effort to overcome the patient's resistance to acknowledging or recognizing a particular content or connection, and is not meant to force any change in the patient's conduct, attitudes, or decisions. It is therefore intended to change the patient's thinking and not his or her behavior. The distinction from clarification, another useful form of intervention, is often difficult, since they are frequently used in conjunction. Although clarification has the function of making clear or of bringing about recognition, it does so in a more neutral and dispassionate fashion; confrontation adds the note of activity on the part of the therapist, emphasis, even forcefulness. The confrontative element is often carried in subtle ways by the therapist's tone of voice, unusual use of language,

humor, the element of surprise, affective tone, and so on. The therapist can even convey his or her emphasis by way of facial expressions: raising an eyebrow, assuming a quizzical or doubtful look, shaking the head, and so on. Even a shrug can convey to a patient a sufficient connotation to make an effective confrontation. Confrontations are not always or necessarily forceful; they may be subtle, gentle, and inviting as well.

II. CONFRONTATION VERSUS INTERPRETATION

It is customary to distinguish confrontation from interpretation. From one point of view, interpretation involves sharing a hypothesis with the patient along with an invitation to engage in its exploration and understanding; confrontation, however, involves presenting a more unilateral view of what the therapist regards as reality. Confrontation can be regarded as a starting point for bringing to light new problems, associations, or understandings, which become the object for further exploration, whereas interpretation implies more of a closure or resolving of some connection or understanding that had been hitherto obscure or in doubt. Thus, interpretation has the purpose of resolving internal conflicts by bringing unconscious elements to the surface and drawing them within the patient's awareness, whereas confrontation is designed to create conflict where there had previously been none.

Confrontation, as a therapeutic technique, seems to imply that the therapist knows or sees something that the patient does not. Recent debates among analysts have centered around the question of whether and to what degree the analyst can have any privileged knowledge of or access to reality or any better or deeper understanding of motives and their implications than the patient. Some have argued that the therapist can have no special knowledge, or can have no better knowledge of the real than the patient, especially when it comes to knowing or understanding what is going on in the patient's mind. The argument has a certain validity, but would only have convincing effect if it were applied to a caricature of confrontation. When the therapist confronts the patient, his or her assertion does not imply that the therapist is right and the patient is wrong, but the confrontation offers the patient another perspective or directs the patient's attention to something he or she is ignoring or overlooking and thereby opens the way to an alternate consideration and a rethinking or reconsideration of his or her position. One of the benefits of ther-

apy is that the patient's problems are engaged by two heads rather than one.

Even more subtle differences may come into play. There is a difference between accusing the patient of wasting time and observing that the patient is still reacting as if the work with the therapist were doomed to be unproductive. The former renders a judgment and an accusation, and has more the flavor of a confrontation, whereas the latter offers more of a translation. The latter statement is more in the order of a clarification or even an interpretation. The difference has to do with the presence of the therapist in the intervention. The patient's assent to the first intervention necessarily involves accepting both the fact and the confrontative, even authoritative, role of the therapist. Assent to the latter requires only acceptance of the fact, whereas the therapist's role is more in the line of suggesting or clarifying. In a sense, then, confrontation involves a certain forcing of the therapist on the patient, or even an intrusiveness of the therapist, however gentle, calling for or creating a pressure toward internalization of the therapist by the patient. The interaction is not simply the product of the patient's projective imagination, but involves real activity on the part of the therapist, in one or other degree amalgamated with transference elements, but setting the stage for a defensively toned introjection rather than a more selective and secondary process identification.

III. CLINICAL APPLICATION

Confrontation as a therapeutic technique has a more prominent position in the treatment of more primitive or highly resistant patients. Along with clarification, it is the primary channel for dealing with manifest content in the patient's ongoing behavior. Confrontation is a part of the therapy in some degree with all patients, but particularly in regressed patients or in regressive crises with some borderline patients, confrontation is often essential.

Confrontation carries with it the connotations of activity, energy, forcefulness, challenge, and the overcoming of opposition, all of which reflect in some degree the aggressive derivation of confrontation in overcoming an obstacle to therapeutic progress and its degree of deviation from what many would regard as more neutral therapeutic techniques. In the ordinary run of therapy, confrontation is usually employed as a means of overcoming resistances, promoting further therapeutic progress, and as leading to interpretation of the patient's defenses and their underlying motivations. In

the treatment of character disorders, the confrontations with the patient's patterns of characterologic behavior are frequently a necessary step in arriving at the underlying conflicts and their unconscious motivation.

Confrontations are not always benign or merely conflictual, but may also turn out to be dramatic or heroic. We can regard a confrontation as heroic when it becomes an emotionally charged, parametric, manipulative, technical tool demanded by development of an actual or potential situation of impasse and utilized to remobilize a workable therapeutic alliance. An example might include telling a patient that it was no wonder that no one liked him if he behaved in such an unpleasant manner whenever anyone tried to help him. Another example might be confrontation of a somewhat paranoid patient, in which the therapist tells the patient that his premises were wrong and that, if he so wished, he could become paranoid, but another possibility was that he could also accept the therapist's effort to be helpful and that they could choose either to work together or not, but if the patient chose to continue with his paranoid attitudes, he would run the risk of further sickness and hospitalization. Similarly, a therapist may decide to confront a patient enmeshed in a prolonged resistance and therapeutic misalliance that the therapist found necessary to interrupt by telling the patient that he was getting nowhere in the treatment and that he ought to consider some other alternatives besides continuing therapy with him. Only the threat of the loss of the transference object was able to shake the patient's resistance to development of the transference neurosis and lead to further analytic progress. Such confrontations have as their purpose the reconstitution of a disrupted or distorted therapeutic alliance.

Heroic confrontations are called for when the therapy has reached an impasse, when the therapeutic alliance has been or is in danger or disruption, or has reached a point of chronic distortion so that the therapeutic misalliance has frustrated and subverted the work of the therapy. The success of such heroic confrontations depends in large manner on the capacity of both patient and therapist to regain the ground of some workable therapeutic alliance without which therapy is doomed to disruption, stalemate, and failure. An additional note is that confrontation is usually oriented toward reestablishing the patient's sense of the therapeutic role of the therapist and the therapeutic situation, or of some other external reality in the patient's life situation.

Many patients have a remarkable capacity to see the world on their own terms, taking their own psychic reality as the reality. This propensity is particularly marked

in borderline patients, who experience the therapist more or less exclusively in transference terms resulting in various forms of therapeutic misalliances. The work of tactful clarification and confrontation with the actuality of the therapeutic situation is often a central and persistent aspect of the therapeutic work with borderline patients, although it is by no means rare in other forms of personality disorder. In general, these patients do not have a stable sense of self based on introjections and identifications derived from experiences with real, responsive, caring, and responsible people in their developmental past. For these patients, actual characteristics of the therapist, whether mediated through the alliance or as aspects of their real personality, may be critical elements in the restructuring of the internal objects necessary for adequate ego functioning. Confrontation of these characteristics in the therapist-patient interaction may be a major aspect of the treatment process.

In therapy with such patients, the use of confrontation implies a shift to a more active, involved, and real interaction with the patient. It also implies a shift to a more supportive orientation, even within the context of a longer-term uncovering and exploratory effort. Particularly in the context of a regressive crisis or of a more chronic regressive stance, when the patient's capacity for therapeutic alliance is tenuous, or when the alliance is disrupted or severely distorted and failures of reality testing become apparent, confrontation may be essential to preserve and continue the therapeutic work.

IV. COUNTERTRANSFERENCE AND CONFRONTATION

Confrontation also involves inherent risks of becoming a vehicle for expression of countertransference. Therapeutic confrontation must not become a vehicle of irritation, frustration, or sadism, but must be offered from a therapeutic perspective and with the therapeutic intention of benefit to the patient as an objective. Confrontation is never far from slipping over into a more controlling, determining, advising, or authoritative, even authoritarian, stance, which easily yields to the influence of countertransference reactions and transference-countertransference interactions. As a cautionary note, therefore, it is important to keep in mind that confrontation always serves a subsidiary function to the overriding focus on exploring, uncovering, and understanding the patient's dynamics and underlying motivations.

It is generally agreed that therapists must exercise caution in the expression of their own feelings, since they

can readily become the vehicle for countertransference influences and will inevitably have a powerful effect on the patient. Any expression of feelings must be carefully monitored, expressed only in terms that are beneficial to the patient, and with thoughtful consideration of the countertransference implications. As some analysts have argued, countertransference enactments are unavoidable, so that when they occur the therapist should try to put them to good use in the therapeutic work. But I would suggest that such enactments cannot be effectively processed to the benefit of the therapy except within the context of the alliance—there is no basis within a transference-countertransference interaction for such a therapeutic perspective. Only when it can be experienced and understood from the perspective of the alliance can such an enactment be turned to therapeutic advantage. Confrontation is therefore primarily a device for directing the patient's attention in a more effective manner to some aspect of his or her mental content or behaviors or to aspects of the patient's interpersonal or environmental involvements, especially those occurring in the therapy in relation to the therapist, that otherwise would remain hidden or repressed. Confrontation is useful insofar as it leads toward interpretation or makes the material for interpretation more available. Confrontation can be regarded, therefore, as a routine part of psychoanalytical or psychotherapeutic technique and as necessary for the analysis of resistance.

V. REGRESSION

Although at points of regressive crisis confrontation may be essential, it is also at such points in the therapeutic course that patients are most vulnerable to the misuse of confrontation and the contamination by countertransference. In the treatment of more primitive personality disorder patients, I would emphasize the tenuousness of the therapeutic alliance and the need to utilize confrontation with caution with an eye to building the patient's trust in the therapist's good judgment and constructive intentions. Observing certain restrictions can help to achieve this objective:

1. Assess the reality and related stress in the patient's current life situation. In situations of external stress, particularly when they provoke a regressive reaction in the patient, it does not help to increase the level of stress within the therapy. The therapist's empathy and thoughtful evaluation guides the advisability of confrontation and the need for support at any given point.

2. Avoid breaking down needed defenses: Here again the titration of activity versus passivity, support versus

challenge, call for a balancing act that is at times delicate. In regressive states, patients may need to maintain even primitive levels of defense and it becomes therapeutically inadvisable to confront such defenses when there is danger of precipitating a more severe regression. However, there are also times when confrontation is required to pull a patient out of his or her regressive slump, reconstitute the therapeutic alliance, and get the therapy back on course.

3. Avoid overstimulating the patient's wish for closeness. Greater levels of activity and attempts to be supportive can have a secondary effect of creating a closer and more personal contact between therapist and patient, or, in other words, drawing the patient into a more real relation with the therapist and correspondingly diminishing the effectiveness of the alliance. This can be both overstimulating and seductive, and, while it runs the risk of precipitating further defensive retreat or regression, can also have the long-term effect of creating expectations that will make the continued effectiveness of the therapeutic effort down the line more precarious. The patient may have to take flight in defensive panic or rage or act out from the intensity of the feelings that may be precipitated. This can plunge the patient into intense fears of abandonment, loneliness, and fear of his or her own self-destructive impulses and destructiveness.

4. Avoid overstimulating the patient's rage. Confrontation, particularly when it is connected with limit-setting, often has the effect of reestablishing the boundaries between patient and therapist and cause the patient to feel deprived and frustrated. The rage brings with it fears of abandonment and annihilation, which only increase the regressive risks.

5. Avoid confrontation of narcissistic entitlement. We can distinguish between narcissistic entitlement and the more profound and regressive entitlement to survive. Confrontation of the patient's entitlement may have the intention of calling attention to the patient's narcissistic entitlement, but it can easily miss the mark and only threaten the patient on the level of his or her entitlement to survive. Certainly, the periods of regression are hardly the time to challenge any patient's narcissism at whatever level. Narcissism is better dealt with only at points at which the therapeutic alliance is more stable and positive, and then preferably through gradual and progressive techniques of clarification and interpretation. Confrontations of the patient's narcissism are at best risky, even under optimal conditions. There is always risk in such confrontations of precipitating a regressive crisis.

Confrontation may also be called for when some dangerous or self-defeating consequence is involved in

the regressive episode. One young man, who presented with a variety of hysterical and phobic anxieties, began his analysis with a fair amount of precipitant anxiety. Within a short order, he was seized with panic and a terror-stricken fear that the analyst would attack him from behind and stab him in the chest. This created an immediate threat that the analysis would be prematurely and disruptively terminated by this paranoid terror. Without having any idea of what was involved in the patient's panic, the analyst took a relatively strong confrontative position and pointed out that the patient was experiencing terror for reasons that neither he nor the patient were at that point aware, but that, if the patient allowed his fears to dominate, that they were in danger of disrupting the analysis. He insisted that the patient be able to control his fear so that it did not result in self-defeating acting out and that he and the patient try to work together to understand what was happening. The patient quieted down at least to the degree that he was able to remain on the analytic couch, and the ensuing exploration revealed the multiple layers of implication that determined the patient's panic.

The risks of regression are obviously more at issue in patients in the lower-order borderline spectrum, and are correspondingly less of a problem in higher-order patients, and even less so in narcissistic and neurotic levels. In higher-order patients the same issues are alive, but the patient's capacity to enter and maintain an effective therapeutic alliance serves as a buffer both to the underlying regressive potential and the patient's vulnerability to countertransference influences. Nonetheless, the rules of thumb for utilizing confrontation are relevant even for these patients, and are reflective of general norms of tact and consideration in dealing with any patients.

VI. CONFRONTATION AND THE THERAPEUTIC ALLIANCE

An important issue in considering the therapeutic role of confrontation is the relationship between confrontation and the therapeutic alliance. Confrontation can be brought into play in the service of building a therapeutic alliance, but also of salvaging a disrupted alliance or more persistent misalliance. When the therapeutic alliance is intact and operating meaningfully, confrontation usually has little if any place. When the alliance is failing or has been disrupted, however, confrontation may become essential. The alliance includes a degree of meaningful empathic attunement, which guides the therapist's decision whether to confront or not, and also sets the stage for the patient's receptivity and responsiveness to the con-

fronting initiative. In a sense, then, confrontation can be used in the absence of a therapeutic alliance for purposes of establishing or retrieving the alliance. This is possible only if the confrontation on the part of the therapist is brought to bear from the perspective of his or her part in the alliance in an effort to engage the patient and reestablish the interpersonal context of collaborative effort.

Confrontation offered from a position of consistent caring and respect for the patient's autonomy, and generated from a basic concern for maintenance and reinforcement of the therapeutic alliance can have a powerful therapeutic effect. It must be remembered, however, that the confrontation is intended to lead in the direction of further therapeutic work and understanding. Confrontation for confrontation's sake inevitably runs the risk of countertransference contamination. It is more advantageous to try to understand where the patients are, and why they are where they are, than to confront them where they are not. Consequently, confrontations that lead in the direction of further exploring the basis for resistances or of examining the roots of transference distortions are therapeutically helpful. Where they do not, they run the risk of simply reinforcing the transference-countertransference dynamics and may simply lead in the direction of further patient compliance and counterproductive submissiveness.

Nonetheless, confrontation along with clarification may have an important role to play in any therapy, especially early in the course of the therapy. Interpretation is not possible or useful until the patient has developed some degree of at least a working alliance. To the extent that the therapist's interpretations are offered while the patient is caught up in the vicissitudes of projective distortions and negative transference reactions, they will be heard as either threatening or accusatory, or in an idealizing transference situation as unempathic reinforcements of the patient's views. Consequently, a relative focus on the patient's daily life experience and persistent gentle and gradual confrontation and clarification can lead not only to establishing a better alliance but can also gradually clarify and delineate the pathological patterns of interaction that the patient generates both within the therapeutic interaction with the therapist and with important objects outside of the therapy. Success with many patients, even difficult patients, is a function of the accuracy, empathy, and timeliness of the therapist's gentle and thoughtful confrontations, which both open the way for later interpretations and to a degree help to draw out the transference. Gentle confrontation and clarification of the patient's feelings about the therapist can open the way to dealing with therapeutic alliance issues and further catalyzing transference reactions.

VII. DEALING WITH DENIAL

One of the specific contexts in which confrontation is often required is when denial becomes a prominent factor in the patient's resistance. Denial, as with other defensive mechanisms, can operate at all levels of intensity, but can function at a relatively massive level even to the point where the patient becomes unaware of any inner feelings or impulses. When such denial affects the assessment of potentially threatening or dangerous consequences of a course of action, or has become sufficiently embedded so that therapeutic progress is stalemated, confrontation may be the only resource in the therapist's armamentarium that will enable him or her to break through the patient's denial. The element of unmasking denial is inherent in all forms of true confrontation, not as an attack on the patient's vulnerability, but that in whatever fashion confrontation is implemented, it is directed against the defense with the aim of unmasking and coming to grips with the patient's protected vulnerability.

The confrontation of denial may be spread over a considerable period of time, rather than being focused at a single point of time. One young man experienced occasional episodes of total immobilization, as if he were in a trancelike state in which he had great difficulty in following what has happened in his immediate environment and was unable to respond or react in any comfortable manner. Gentle questioning on my part, a subtle insistence that his experience must be connected with a mental process reflecting something significant in his life experience, gradually began to shift the ground and enabled him to slowly come in contact with the underlying affect. Sometimes days after the event, he would begin to experience some feeling of anger or irritation, or on rare occasions he would be suddenly overwhelmed with a burst of intense rage that he was completely at a loss to connect with any stimulus or context in the immediate situation.

The rage underlying these experiences was nearly psychotic in proportion and terrified him, presumably because of a previous psychotic breakdown, in which the intensity of his rage had welled up with overwhelming and traumatic effect. Gradually, the patient began to experience rage attacks that he found overwhelming at the time of their occurrence, but in therapy was able to reflect on and explore what he had been experiencing and gradually to connect his intense feelings with the traumatic experiences of his difficult and traumatic relationship with his parents. When it became clear to me that rage was at the root of his disturbing experiences, and that the level of his protective

denial prevented any easy access to these feelings, I continued to use a confrontational approach so that whenever any of these episodes came into focus I was not slow to suggest that what underlay the patient's experience was his anger and rage, and that our therapeutic task was to find out what his anger was about. The effort I am describing took place over a period of years of intensive psychotherapy. Consequently, confrontation is not always limited to a specific here-and-now intervention, but may involve a process that extends over continual periods of time.

VIII. NARCISSISM

Another difficult area in which confrontation can at times play a significant role is in dealing with the patient's narcissism. One context occurs when patient and analyst are caught up in a narcissistic alliance based on the patient's narcissistic expectations, gratifications, and fantasies, which impedes progress toward a more meaningful and effective therapeutic alliance. Gentle confrontation with the patient's narcissistic expectations and fantasies within the limits of his or her narcissistic vulnerability is a possible vehicle for addressing the distortions in the alliance and helping the patient to gain a better foothold for the therapeutic work. As previously noted, the decision whether to confront or not, rests in part on an assessment of the degree to which the patient is using the narcissistic alliance for defensive or resistive purposes, as opposed to the extent to which the narcissistic alliance may be the best the patient can do at that point in time and must be tolerated as necessary for maintaining any therapeutic relationship whatever. In the latter instance, confrontation may not be the best tactic, and the therapist might better wait until some degree of therapeutic alliance has evolved, or until enough of the components of the narcissistic transference are available for interpretation.

Other aspects of the patient's narcissism have to do with narcissistic entitlements and the need for engaging with and ultimately working through the underlying components of shame and inferiority. These dynamics and the underlying structural components can be described in terms of narcissistic superior and inferior introjective configurations. Keeping in mind the distinction between narcissistic entitlement and the entitlement to survive, it is nonetheless at times essential to confront the patient's entitlements. When these are expressed in the form of provocative behavior, it is useful to point out the patient's entitled attitudes, and even to focus on their impact on the therapist. The patient

may be outraged at this challenge to his or her self-proclaimed “rights,” but such confrontation may be the only path toward further exploration and understanding. The patient may respond by foregoing any provocative behavior and adopting a more compliant facade out of fear of abandonment and loss of the therapist, but these maneuvers and the misalliances they reflect can also be confronted, leading to further exploration and analysis. Whether such confrontations are made with essentially neutral affect or with a tinge of irritation is a matter of clinical judgment, and involves questions related to the amount of self-disclosure that will be therapeutically useful on one hand and the degree of countertransference contamination on the other. If the therapist’s irritation is not completely suppressed, it may bear fruit in letting the patient know that his or her infantile entitlement can evoke hostility from the important others in the patient’s life.

Although excessive entitlements reflect the dynamics of the superior narcissistic introject, the inferior narcissistic introject may also play out its brand of entitlement in a form of restricted entitlement in which patients play out their inferiority, fail to stand up for themselves, or allow others to take advantage of them. This behavior also requires confrontation, but this can run the risk of inflicting a narcissistic injury in that it calls attention to the patient’s inadequacy and failings. This too, however, can open the way to further exploration and meaningful resolution of the underlying fears and impediments. The art of confrontation of a patient’s narcissism lies in dosing and timing, and maintaining a positive and respectful view of the patient. Confrontations tend to inflict narcissistic injuries on patients, and the therapist must keep in mind that these toxic effects must be administered in tolerable doses, so that untoward side effects are not created. The process is a form of gradual desensitization, which slowly increases the titration of confrontation and its immediacy and directness within the limits of the patient’s tolerance and the mitigation of his or her narcissistic vulnerability.

The therapeutic task in the treatment of narcissism lies in making contact with, articulating, and gradually analyzing the inferior side of the patient’s narcissism, particularly the sense of inferiority and shame, which pervades the inner world of all narcissistic patients, whether the inferior aspect of the patient’s narcissistic introjects is relatively conscious or not. In narcissistic patients, the underlying sense of shame often gives rise to projections, which take the form of expecting humiliation or criticism, experiencing the otherwise benign reaction of others as forms of humiliation or criticism, and other forms of ridicule, scorn, contempt and rejection from important

others including the therapist. Analysis of these components of the patient’s inner world cannot proceed unless these elements have been drawn into conscious awareness to some degree. Confrontation can often usefully accomplish this objective. Only when the patient is aware of this dimension of his or her inner life is it possible to seek further for explanation and understanding.

IX. SUMMARY

This discussion of confrontation can be summarized in the following guidelines for the use of confrontation:

1. Confrontation draws upon empathy, but empathy does not mean that we share an identity or an ideology with the patient.

2. Countertransference distortions are likely when we find ourselves angry, disappointed, exasperated, gratified, especially frustrated, jealous, or in some other way imposing our individual imperatives upon confrontations.

3. Confrontations can be contaminated by fantasies of being the magic healer, rescuer, shaman, sage, or parent, because this may not be the level of need and communication on which the patient is operating.

4. Confrontation consists of mutually self-corrective activities. It is not intended to be a directive or a prohibition for the patient. We seek forbearance, not compliance, firmness, not coercion from the patient. We cannot offer options; we can only help someone to use the options he or she has.

5. Efforts to understand too much are suspicious indications of countertransference ambition. We cannot respond to every demand and confront every defense. Denial cannot be eliminated completely, because strategic denial may be a requirement for the patient is keep on living.

6. A tendency to overemphasize technique or, conversely, to discourage thoughtful reflection as “cerebral” are signs of countertransference distortions.

7. Confrontations are more effective in a context of trust. Trust means only that we have a common field of acceptance. Although it is feasible to have a mutual alliance at the outset, trust is always conditional.

8. Words are not magic, nor must confrontations be followed by signs of conspicuous change. Confrontations are only special vehicles of communication that seek an opening at a point of contact with protected vulnerability.

9. On the whole, confrontations are only statements about the other person’s existence, not hypotheses about

his or her status as a scientific object. We respond to his or her separate reality and cannot, therefore, be too punctilious about the longitudinal truth of what we say.

10. We can generalize; we can be precise. But it is essential that we also be contemporaneous.

See Also the Following Articles

Anger Control Therapy ■ Clarification ■ Countertransference ■ Interpretation ■ Patient Variables: Anaclitic and Introjective Dimensions ■ Reality Therapy ■ Resistance

Further Reading

Adler, G. (1985). *Borderline psychopathology and its treatment*. New York: Jason Aronson.

Adler, G., & Myerson, P. G. (Eds.). (1973). *Confrontation in psychotherapy*. New York: Science House.

Boyer, L. B. (1983). *The regressed patient*. New York: Jason Aronson.

Greenson, R. R. (1967). *The technique and practice of psychoanalysis*. New York: International Universities Press.

Kohut, H. (1971). *The analysis of the self*. New York: International Universities Press.

Meissner, W. W. (1978). *The paranoid process*. New York: Jason Aronson.

Meissner, W. W. (1981). *Internalization in psychoanalysis*. New York: International Universities Press [Psychological Issues, Monograph 50].

Meissner, W. W. (1988). *Treatment of patients in the borderline spectrum*. Northvale, NJ: Jason Aronson.

Meissner, W. W. (1996). *The therapeutic alliance*. New Haven, CT: Yale University Press.

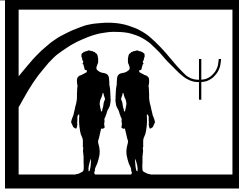

Contingency Management

Christopher A. Kearney and Jennifer Vecchio

University of Nevada, Las Vegas

- I. Definition
 - II. Types of Consequences
 - III. Initial Steps to Contingency Management
 - IV. Types of Contingency Management
 - V. Parameters of Contingency Management
 - VI. Potential Problems of Contingency Management
 - VII. Target Groups for Contingency Management
 - VIII. Sample Case
 - IX. Summary
- Further Reading

- punishment* Application of a negative stimulus that decreases the frequency of a behavior.
- shaping* Reinforcing successive approximations of a desired response until that behavior is fully achieved.
- time-out* Extinction of undesirable behavior by removing attention-based reinforcers for that behavior.
- token economy with response cost* Establishment of primary and secondary reinforcers contingent upon the presence of a desired behavior or absence of an undesired behavior.

GLOSSARY

- contingency contracting* Distribution of rewards and punishments for a behavior via a written contract constructed between two or more parties.
- contingency management* A therapeutic procedure involving the modification of behavior via the control or manipulation of consequences (contingencies) to the behavior.
- differential reinforcement of other or incompatible behavior* Rewarding general behavior other than an undesirable behavior or rewarding specific behavior that is antagonistic to an undesirable behavior.
- extinction* Removal of a positive stimulus that decreases the frequency of a behavior.
- negative reinforcement* Removal of a negative stimulus that increases the frequency of a behavior.
- positive reinforcement* Application of a positive stimulus that increases the frequency of a behavior.
- Premack's principle* Reinforcing a target behavior by awarding some privilege to engage in a more desired behavior afterward.

I. DEFINITION

Contingency management refers generally to the modification of behavior via the control or manipulation of consequences (contingencies) to the behavior. In essence, some control is sought over what follows a certain behavior to increase or decrease the frequency or other characteristics (e.g., intensity) of that behavior. Contingency management involves a collection of therapeutic techniques derived from Skinnerian principles of reinforcement. In addition, practitioners of contingency management often enlist those who surround a particular client to distribute consequences, but contingency management may involve the client himself or herself as well.

II. TYPES OF CONSEQUENCES

Consequences that follow a particular behavior can often be categorized as positive or negative. In addition,

such consequences may be given or taken away. A positive consequence that is given refers to positive reinforcement and generally serves to increase the frequency of a behavior. Examples include providing bonus incentives for workers or rewarding a child for extra chores via a new privilege. A positive consequence that is taken away is a form of extinction and generally serves to decrease the frequency of a behavior. Examples include hanging up the telephone on an obscene caller or depriving a child of attention as he or she throws a temper tantrum. In each case, the perpetrator is denied access to reward (e.g., arousal, attention), which should lessen the frequency of the behavior in the future. Extinction may involve the absence of negative consequences as well, according to Tryon in 1996.

A negative consequence that is given refers to punishment and generally serves to decrease the frequency of a behavior. A common example is spanking a child for recklessly running into the street. Finally, a negative consequence that is taken away refers to negative reinforcement and generally serves to increase the frequency of a behavior. Examples include wearing deodorant to ward off complaints from others and avoiding an anxiety-provoking situation (e.g., driving across a bridge) to lessen anxiety as one leaves the situation. Contingency management generally involves manipulating these consequences, both positive and negative, to modify a particular behavior.

Specific types of consequences used in contingency management include tangible and intangible stimuli. Positive tangible consequences include such things as food, money, toys, and privileges, whereas negative tangible consequences include such things as pain or physical discomfort. Positive intangible consequences include such things as attention, sympathy, and social support, whereas negative intangible consequences include such things as emotional deprivation, lack of conversation, or failure to help.

III. INITIAL STEPS TO CONTINGENCY MANAGEMENT

A contingency management approach to therapy begins with selecting and carefully defining the behaviors to be changed as well as rewards, penalties, and punishments. In doing so, input should be sought from the person who is displaying the behavior of interest as well as those who often surround the person and/or who have significant influence on him or her. Input may be solicited directly via interview or more indi-

rectly via questionnaire, videotaping, or analogue observation in an office setting. In the case of a child, for example, input may be derived from the child, parents, teachers, siblings, peers, dating partners, grandparents, group leaders, or relevant others. For adults, relevant others generally include a spouse, children, friends, relatives, and business associates, among others.

Targeted behaviors should also be clearly defined. In the case of a child who throws temper tantrums, for example, specific targeted misbehaviors might include crying, throwing an object, hitting someone, screaming, or refusing to move. In the case of an adult with alcoholism, specific targeted misbehaviors might include missing work days, showing up unannounced at a friend's house, or driving while drunk. Each of these behaviors can be easily observed and recorded. Vague descriptions of targeted behaviors, such as aggression or lack of respect for others, should be avoided. Other criteria for targeted behaviors include feasibility and desirability. Targeted behaviors should be practical, make sense to those involved, and be within a client's value system.

IV. TYPES OF CONTINGENCY MANAGEMENT

Several treatment techniques come under the general rubric of contingency management, including token economy with response cost, contingency contracting, shaping, differential reinforcement of other or incompatible behavior, time-out, and procedures based on Premack's principle. Each is discussed briefly next.

A. Token Economy with Response Cost

A token economy involves the establishment of primary and secondary reinforcers contingent upon the presence of a desired behavior and/or the absence of an undesired behavior. Specifically, a system is set up such that a behavior is linked to the receipt of tokens, points, or some other stimulus to compensate a person for engaging in or not engaging in a behavior. In doing so, some form of compensation is given immediately following the desired behavior. Accumulation of these stimuli (i.e., tokens, points) is later exchanged for primary and usually tangible reinforcers that the person enjoys (e.g., food, access to toys, privileges, release from chores). Failure to accumulate a specified number of points usually means a failure to receive the reward, or the token economy can be structured so that different

accumulations of tokens or points lead to different levels of reinforcement. For example, a large amount of accrued tokens could be rewarded with 10 hours of release time from an inpatient unit, whereas a smaller amount of accrued tokens could be rewarded with 5 hours of release time.

Token economies are often supplemented with a response cost procedure whereby a person loses tokens or points for some specified misbehavior (e.g., noncompliance, stealing, screaming). In this scenario, the person is fined for the misbehavior by losing some, but not necessarily all, of their accumulated tokens or points. This procedure thus penalizes misbehavior and provides immediate feedback to the person about the inappropriateness of his or her behavior. For example, running down the hallway at school could be penalized by asking the offending child to hand over three tokens. Response cost is typically used to curb behavioral excesses.

Token economies have been used successfully in many areas, but are most common to classrooms and institutional settings. Classroom token economies are often used to address academic behaviors such as handing in assignments or completing projects, disruptive behaviors such as getting out of one's seat or inappropriate talking, and organizational behaviors such as studying and keeping one's desk neat. Institutional token economies are common to inpatient units and residential facilities for persons with disabilities. These token economies are often used to improve daily living and social skills, attendance at therapy sessions, and self-destructive and other behaviors.

B. Contingency Contracting

Contingency contracting involves the distribution of rewards, penalties, and punishments via a written contract constructed between two or more parties. Contracting is often used in family therapy as a vehicle for problem-solving, but is also an excellent way of providing rewards, penalties, and punishments in a structured and agreed-on format. After a specific behavior (e.g., curfew) is defined as the presenting problem, each party (e.g., parent and adolescent) develops parameters to indicate how they would like the behavior defined and what consequences may follow its presence or absence. In the case of curfew, each party may eventually decide that 9:30 p.m. curfew on weeknights and 11:00 p.m. curfew on weekends is desirable. Both parties may then agree that adherence to this curfew time will be rewarded via continued allowance, whereas broken curfew will be met with grounding and suspension of allowance.

Contracting usually requires that each party negotiate behaviors of interest as well as acceptable consequences. Contracting typically begins with a mildly problematic behavior that is easily defined and amenable to placement in a contract. This is done to give the conflicting parties practice at the contracting process and to experience success in problem-solving. Subsequent contracts gradually become more detailed and complex, and may involve multiple behaviors and consequences. For example, a teenager may agree to attend school, adhere to curfew, and complete homework in exchange for visits with friends, money, and special privileges. Failure to complete these tasks may result in loss of these reinforcers or assignment of other punishers such as chores. Many contracts are also designed so that basic behaviors are not directly reinforced. For example, many parents object to paying their children to go to school, a task they should be doing anyway. To address this, a contract may specify that a child must attend school to earn the opportunity to complete chores at home for which he or she is paid (i.e., a two-part reinforcement contingency). Of course, each contract should reflect that family's value system.

Contracts are often used with parents and children but can also be used for other clinical populations. For example, a person with substance abuse can contract with co-workers to attend work sober, a person with schizophrenia can contract with a therapist to maintain medication use, and a person with depression can contract with friends to increase attendance at social events. Contracting is also preferable in chaotic situations where increased structure for problem-solving and consequence administration is desired.

C. Shaping

Shaping refers to reinforcing successive approximations of a desired behavior until that behavior is gradually achieved. General examples include learning to play a musical instrument or playing a sport such as golf. In these activities, small, gradual steps must be taken toward the final goal. In many clinical populations, asking a client to reach a certain goal is untenable because of some interfering behavior such as fear, withdrawal, noncompliance, or lack of skill. Therefore, smaller steps toward the overall goal are designed to facilitate progress. A common example is approach toward a feared stimulus such as a dog. A person phobic of dogs will not simply walk up to a canine and pet it; instead, gradual steps toward the dog must be taken without fear. Shaping also involves the distribution of

rewards, penalties, and punishments for completing or failing to complete each step.

Gradual approach without fear is a common example of shaping, but many other examples are available. For children with school refusal behavior, for example, shaping often involves requiring a child to attend one class/hour per day and gradually increasing the number of classes/hours attended over time. For persons with depression, shaping could involve asking a client to make two calls a week to friends, and subsequently increasing his or her number of social contacts. For couples with sexual dysfunction, shaping could involve reconstructing the sexual repertoire so that only certain areas of the body are initially touched; as therapy progresses, more intimate contact is allowed and reinforced. Shaping generally involves only those steps that resemble the final overall goal (e.g., active social interactions).

D. Differential Reinforcement of Other or Incompatible Behavior

Differential reinforcement of other behavior (DRO) refers to rewarding behavior other than a specified undesirable behavior. A child with autism, for example, may be given a reward during any 5-minute interval during which he or she plays with no aggressive behavior. In related fashion, an adult may be rewarded for interacting with others and not avoiding an anxiety-provoking situation. Differential reinforcement of incompatible behavior is similar to DRO, but involves rewarding a behavior that is specifically antagonistic to, or not able to be done physically at the same time as, an undesirable behavior. For example, a child may be rewarded for folding his or her hands on a desk, a behavior incompatible with hair pulling. Or, an adult in a group home for persons with schizophrenia may be rewarded for doing a chore in the home, a behavior incompatible with running away.

E. Time-Out

Time-out involves the extinction of undesirable behavior by removing positive reinforcers for that behavior. Time-out is most commonly used for children, and often involves isolating a child for misbehavior to deprive that child of attention from others. A child who is disruptive in class, for example, can be sent to another room alone so that reinforcing peer attention is denied. In-school suspension is sometimes used in this regard. Or, a parent may choose to ignore a child for having a temper tantrum to deny the child the benefit of parental attention. Time-

out is also used as a punishment in that the isolating setting should be a boring one devoid of fun.

Several caveats to time-out are often ignored and can lead to problems with the technique. First, time-out will only work for those whose misbehavior is attention-seeking in nature. If a child is disruptive in class to escape an aversive assignment, for example, then time-out serves more as a reward. Similarly, for children with autism, time-out is often more a negatively reinforcing event than a punishing one. Second, time-out is generally more effective if the person knows why he or she is being placed in time-out. Children, for example, should be informed before and after time-out as to why time-out occurred. Finally, time-out should not be linked with a stoppage of the required task before time-out. If a child was picking up toys prior to a tantrum and subsequent time-out, then he or she should return to the task following time-out.

Time-out may be used for other populations as well. For example, a person with schizophrenia on an inpatient unit may be placed in his or her room for aggressive behavior, an adolescent in a group home may be placed in time-out for yelling at another resident, and a couple who engages in heated arguments can agree to place themselves in temporary time-out to ease passions and prevent an abusive situation from taking place. As such, time-out can serve as a preventative measure as well as a mechanism for depriving reinforcement for a misbehavior.

F. Premack's Principle

Premack's principle (or the differential probability hypothesis) refers to reinforcing a target behavior by awarding some privilege to engage in a more desired behavior afterward. For example, a child may be told that he or she can have dessert after eating his or her vegetables, or be told that he or she can play baseball after completing a certain chore. The more highly desirable behavior is used to entice a person to engage in a usually productive, albeit less enjoyable, activity. Typically, Premack's principle is used by parents in addressing their children, and therapists often build this principle into their parent-training regimens. Premack's principle is used loosely in other clinical settings as well. For example, a person who successfully loses weight may then be allowed to shop for new clothes.

Premack's principle is often extended in parent-training programs to encourage appropriate child behavior and discourage inappropriate behavior. For example, parents may establish a set of house rules that

carry rewards if followed and punishments if not. The establishment of this consequence system is often linked to other areas of parent training such as modifying parental commands, setting up daily routines, and increasing supervision of the child.

V. PARAMETERS OF CONTINGENCY MANAGEMENT

No matter what contingency management procedure is used in a therapeutic setting, one must still decide on certain parameters for its use. One parameter is who actually distributes the rewards, penalties, and punishments. Generally speaking, those closest to a person and/or those who have the most influence over the person's behavior should be considered. For children, this almost always involves parents, but also teachers, older siblings, grandparents, dating partners, and peers. For adults, this almost always involves a spouse, but also friends, children, co-workers, and other relatives. In addition, rewards, penalties, and punishments may be given by the client himself or herself. For example, a person with depression who successfully modifies an irrational thought can be taught or encouraged to praise oneself for doing so.

Another parameter to be considered is where contingencies should be distributed. Generally speaking, the contingencies should apply closely to the setting in which the misbehavior occurs. For example, if a child is disruptive at school, some consequences should be given there. Likewise, for an adult with depression who is moping at home, consequences may be given there. This allows for more immediacy of rewards, penalties, and punishments, which is crucial to the success of contingency management. This does not preclude, however, the use of consequences in other settings. A child disruptive at school, for example, should also face consequences from his or her parents at home that night.

Another parameter to be considered in contingency management is whether consequences should be given in an individual or group format. In an individual format, the identified person solely receives rewards or punishments. A person who successfully attends a shopping mall and withstands a panic attack without fleeing, for example, could be praised by a spouse at that time. However, a group format may be used to increase help or peer pressure to change behavior. For example, a classroom of children could be told that if everyone turns in five math homework assignments that week, the class will have a party on Friday. How-

ever, if even one person fails to do so, no party will take place. The idea here is to increase peer support, tutoring, and other factors that will increase the likelihood that all children, with a particular focus on one or two, will complete their work. The potential downside, of course, is coercion or negative feelings toward one who does not reach the goal. Therefore, it is best to use this approach in a more cooperative environment. Another example is to penalize a group of people for the misbehavior of one person. In this situation, the same goal and caveats apply.

Group contingencies can be modified so that rewards, penalties, and/or punishments are applied to individuals who successfully or unsuccessfully attain a certain goal. In this situation, the group may know that an individual is up for a reward and assist him or her to get it, or may know that the entire group is up for a reward if the individual is successful. Here, the group is not necessarily penalized for an individual's failure to reach a certain goal. To enhance the cost-effectiveness of group contingencies, a lottery system may be established. In this system, group members are told that they are eligible for a prize drawing if they reach a certain goal (e.g., treatment completion). Eligible members then participate in a lottery that rewards one or more persons but not necessarily everyone who is eligible.

VI. POTENTIAL PROBLEMS OF CONTINGENCY MANAGEMENT

Aside from the caveats to group contingency management just presented, other potential problems should be noted by therapists. One of the biggest threats to the success of contingency management procedures is inconsistent application of the rewards, penalties, and punishments. Several scenarios for this apply to parents and children. First, it is often difficult for parents, who may have had a long history of reflexively attending to their child's misbehavior, to break free from that pattern and respond only to appropriate behavior. Second, parents who have little history of rewarding their children, who emphasize punishment instead, may require time to correctly implement a positive reinforcement system. Third, a mother and father may inconsistently apply contingencies or some third party (e.g., grandparent) may sabotage the process. Fourth, parents may implement contingency management procedures at first but then relapse to old patterns of behavior or for some reason delay the administration of consequences. In these cases, it is best

for the therapist to explore the reasons for treatment noncompliance or failure and perhaps simplify the procedures or target fewer behaviors.

Another threat to contingency management is poor preparation for generalization of treatment effects. The positive effects of contingency management tend to fade over time and especially once the procedures are discontinued. Continued use of the procedures or, if not feasible, some type of intermittent reinforcement or booster session, is recommended. In addition, it should be reemphasized that contingency management is not usually conducted as a sole treatment technique, but combined with other behavioral methods to enhance therapeutic outcome.

Other potential problems to contingency management are more generic. For example, a common problem is that the consequences are not salient enough for an identified client. In this case, rewards, penalties, and/or punishments may need to be intensified or modified to better fit the preferences of the person. Another problem is delay in the immediacy of the consequences. Preferably, consequences should be delivered very soon after appropriate or inappropriate behavior. Finally, contingency management procedures will work best if cooperation from all relevant parties is present. This is most crucial to children with behavior problems, as parents, teachers, and others should be in frequent contact so that different types of behavior can be well-defined and addressed consistently.

VII. TARGET GROUPS FOR CONTINGENCY MANAGEMENT

Contingency management procedures have been used successfully for a number of clinical populations, most notably for children and persons with pain, substance abuse, or pervasive developmental disability. With respect to children, the most common use of contingency management has been with youth with disruptive behavior, especially attention deficit hyperactivity and conduct/oppositional defiant disorder. In this population, contingency management procedures have been shown to produce short-term improvements in academic productivity and accuracy as well as disruptive behavior. In most cases, home-based and school-based contingency management are utilized simultaneously. Contingency management has also been used for children with internalizing problems such as fear, anxiety disorders, and selective mutism. In this population, children are rewarded for successfully engaging in exposure-based tasks. In addition, contingency manage-

ment is often used to address problems of physical functioning such as enuresis and encopresis. Most often, children with these disorders are rewarded for instances of dryness and required to engage in cleanliness practices as a deterrent to soiling.

With respect to persons with pain, contingency management is often combined with other behavioral procedures to address those whose overt pain behavior persists beyond the normal healing process. Contingency management is typically targeted toward behaviors such as verbal pain behavior (e.g., complaints, crying), nonverbal pain behavior (e.g., limping, grimacing), level of activity (e.g., excessive resting), and inappropriate use of medication. In this situation, significant others are encouraged to lessen sympathy, attention, and support whenever the targeted person engages in these maladaptive behaviors. In addition, positive reinforcement should be given whenever the person is active, using medication appropriately, and focusing on life events other than pain.

Various researchers have also used contingency management procedures to address persons with substance abuse. In this population, contingency management has been used to help improve treatment session attendance, abstinence, appropriate medication use, accurate predictions of drug screens, and relapse prevention. Common reinforcers include take-home doses of medication, money, clinic privileges, vouchers for services, employment, housing, and reimbursement of fees. However, the effectiveness of contingency management for this population is subject to factors such as type of drug abused, type and immediacy of reinforcement, frequency of drug screens, patient diversity, and acceptance of the program.

For persons with pervasive developmental disabilities, contingency management is used to reduce maladaptive behaviors and increase adaptive behaviors. Common maladaptive behaviors of focus include self-injury, aggression, inappropriate vocalizations and verbalizations, improper sexual activity, and excessive self-stimulation. Common adaptive behaviors of focus include daily living skills (e.g., eating, dressing, toileting, washing), social interactions, and treatment compliance.

Contingency management procedures have been used for other clinical groups as well. For example, they have been used successfully to address persons with polydipsia, irritable bowel syndrome, vomiting, depression, marital problems, delusional verbalization, bedtime disruptions, pacifier use, and violent behavior. In addition, contingency management has been used to increase adaptive behaviors such as oral hygiene, appropriate eating, cooperation, productivity, homework, writing, and exercise.

VIII. SAMPLE CASE

Following is a sample case of a child with school refusal behavior whose treatment plan included parent training in contingency management. Derek was a 10-year-old boy referred to an outpatient clinic for recent difficulties attending school. Since the beginning of the academic year, Derek had displayed intermittent problems going to school, sometimes throwing temper tantrums in the morning in an effort to stay home with his mother and younger sister during the day. These problems were manageable to some extent in the beginning, but had escalated in the past 3 weeks to the point where Derek's parents could no longer get him to school. Attempts on their part to get him to go to school were met with screaming, crying, refusal to move, clinging, and locking himself in the bedroom or car. In addition, on two recent occasions when Derek did attend school, he left during the day to return home.

A thorough assessment indicated that Derek was not anxious about school and did not have any academic or social problems there. Indeed, Derek's teachers indicated that he was a good student when in class. The assessment also ruled out any medical conditions that might explain Derek's behavior. Instead, the assessment revealed that Derek had a long history of attention-seeking misbehavior, beginning with temper tantrums when he was a young child. These misbehaviors had grown in intensity over the years and had now extended to school refusal behavior. The problem was exacerbated by the fact that Derek's father had to go to work early in the morning, leaving Derek's mother to contend with her son. During the day when not at home, Derek enjoyed several amenities, including running errands with his mother, playing video games, and riding his bicycle. The situation was further problematic in that the school had recently threatened to charge Derek's parents with educational neglect.

To address these misbehaviors, Derek's parents were trained in various aspects of contingency management in addition to adjusting parental commands and setting routines during the morning, day, and evening. Parental commands were modified to be more succinct, straightforward, and devoid of lecturing or asking questions. Three target behaviors were then chosen to be the focus of contingency management. These behaviors included, in order of severity, screaming, refusal to move, and locking himself in a room or car. Consequences were first set up to target screaming: If Derek engaged in any screaming in the morning, he would lose privileges during the

day and be required to sit on the edge of his bed during school hours. His nighttime routine would also be restricted to the house (i.e., no play time with friends). If he did not scream in the morning, especially following commands to go to school, then he would complete chores and schoolwork during the day and be allowed to see his friends for an hour at night.

In addition to this consequence system, Derek's parents were instructed not to pay any physical or verbal attention to their son when he engaged in inappropriate behavior (unless severe injury was being risked). Instead, they were encouraged to smile and speak to him only when he was preparing for school (e.g., getting dressed without complaint), completing schoolwork, or otherwise acting appropriately. This took some practice, as both parents had been used to interacting with Derek primarily when he misbehaved. However, following several days of intervention, Derek's screaming did subside.

The next misbehavior was more severe: refusal to move in the morning. A consequence system was established such that, if Derek refused to move in the morning (e.g., would not get out of bed, dress, eat breakfast, or go to the car), he would be completely grounded for the day, be required to complete schoolwork, and lose allowance. However, if he successfully prepared for school, got in the car, and allowed his mother to drive him to school before returning home, he would be allowed to see his friends 2 hours per day at night. Although school attendance was not yet required at this point, it was made clear to Derek that that would be the next step. Following some tantrums the next day and implementation of the contingencies, Derek's behavior in this regard gradually improved.

Finally, Derek was required to do all of the above in addition to entering the school building and attending class. All parties had reported that Derek would go to class without any problem once there, so getting him there was the primary goal at this point. Similar consequences applied to his refusal and willingness to attend school, and procedures were designed so that both of Derek's parents would be available to take him to school. On the first 2 days of the intervention, Derek refused to attend school and even ran out of the house once to be with friends. However, he was found and restricted to his room for the rest of the day. During the next 2 days, Derek made it to school but refused to enter the school building. Again, consequences were issued. On the following day, Derek did attend school for the entire day, and school personnel increased their supervision of him to prevent any escape. Derek was subsequently rewarded for his attendance via play time

with friends at night, choice of an activity with the family, and praise from his parents. Although intermittent success going to school was seen during the next few days, Derek eventually returned to full-time school attendance within 2 weeks. Derek's parents reported that the consequence system would be continued and extended into other areas of noncompliance.

IX. SUMMARY

Contingency management is a commonly used therapeutic technique that has been administered successfully to treat various clinical problems. The technique is based on Skinnerian laws of reinforcement, or that consequences to a behavior serve to shape the frequency and other characteristics of that behavior. Examples include token economy with response cost, contracting, shaping, differential reinforcement of other or incompatible behavior, time-out, and use of Premack's principle. Although commonly used with parents and children, contingency management has also been applied to various adult populations. Advantages of contingency management include its portability, easy-to-understand nature, wide applicability, and naturalness. Threats to contingency management include inconsistent application and lack of salience of consequences, factors that should be monitored closely by therapists.

See Also the Following Articles

Behavioral Contracting ■ Extinction ■ Negative Reinforcement ■ Positive Reinforcement ■ Punishment ■ Time-Out ■ Token Economy

Further Reading

- Allen, K. D., & Stokes, T. F. (1989). Pediatric behavioral dentistry. *Progress in Behavior Modification*, 24, 81–83.
- DuPaul, G. J., & Stoner, G. (1994). *ADHD in the schools: Assessment and intervention strategies*. New York: Guilford.
- Eysenck, H. J., & Martin, I. (1987). *Theoretical foundations of behavior therapy*. New York: Plenum.
- Griffith, J. D., Rowan-Szal, G. A., Roark, R. R., & Simpson, D. D. (2000). Contingency management in outpatient methadone treatment: A meta-analysis. *Drug and Alcohol Dependence*, 58, 55–66.
- Kennedy, R. E. (1982). Cognitive-behavioral approaches to the modification of aggressive behavior in children. *School Psychology Review*, 11, 47–55.
- Latimer, P. R. (1982). External contingency management for chronic pain: Critical review of the evidence. *American Journal of Psychiatry*, 139, 1308–1312.
- Matson, J. L. (1980). Chronically institutionalized schizophrenics. *Progress in Behavior Modification*, 9, 192–193.
- Murphy, J. J. (1988). Contingency contracting in schools: A review. *Education and Treatment of Children*, 11, 257–269.
- Nezu, A. M. (1989). *Clinical decision making in behavior therapy*. Champaign, IL: Research Press.
- Petry, N. M. (2000). A comprehensive guide to the application of contingency management procedures in clinical settings. *Drug and Alcohol Dependence*, 58, 9–25.
- Pigott, H. E. (1986). Interpreting the conflicting results of individual versus group contingencies in classrooms: The targeted behavior as a mediating variable. *Child and Family Behavior Therapy*, 74, 1–15.
- Rappoport, M. D. (1983). Hyperactivity: Treatment parameters and applications. *Progress in Behavior Modification*, 14, 234–236.
- Salend, S. J. (1987). Contingency management systems. *Academic Therapy*, 22, 245–253.
- Tryon, W. W. (1996). Observing contingencies: Taxonomy and methods. *Clinical Psychology Review*, 16, 215–230.

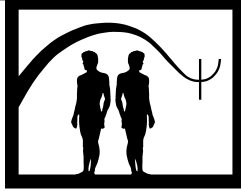

Controlled Drinking

Harold Rosenberg

Bowling Green State University

- I. Definition, Prevalence, and Stability of Controlled Drinking
 - II. Specific Interventions to Teach Moderate Drinking
 - III. Modes of Controlled Drinking Training
 - IV. Social Support for Moderate Drinking
 - V. Theoretical Bases
 - VI. Applications and Exclusions
 - VII. Empirical Studies
 - VIII. Case Illustration
 - IX. Summary
- Further Reading

problem drinker General term used to refer to persons who abuse alcohol or are physiologically dependent on alcohol; also sometimes used to mean nondependent alcohol abusers.

standard drink Serving of an alcoholic beverage containing approximately 0.5 ounce of ethanol (e.g., 12 ounces of 4% beer, 4 to 5 ounces of 10 to 12% table wine, 1 to 1.5 ounces of 40 to 50% distilled spirits).

GLOSSARY

behavioral self-control training Clients are taught to set drink limits, self-monitor their drinking, and employ coping skills to exercise control over when, where, why, and how much they drink.

controlled drinking Nonabstinent outcome by persons who have had drinking problems, often defined in terms of limited quantity and frequency of drinking, lack of negative drinking-related consequences, and subjective sense of mastery or control over drinking.

cue exposure Therapy procedure in which client is repeatedly exposed to stimuli that elicit craving to drink so that person learns to resist urges to continue drinking in the presence of alcohol and other drinking cues.

harm reduction Broadly defined, refers to policies and interventions designed to reduce, minimize, or eliminate unhealthy outcomes that might result from continuing to engage in high-risk drinking and drug-taking.

I. DEFINITION, PREVALENCE, AND STABILITY OF CONTROLLED DRINKING

The term *controlled drinking* is used to describe non-abstinence outcomes—that is, moderate or non-problem drinking—by persons who have abused or have been dependent on alcohol. Definitions of controlled drinking typically include some limit on the quantity of alcohol consumed per day; for example, consumption of no more than 3 to 5 “standard drinks” per day (1 standard drink = 0.5 ounce of ethanol). Similarly, the British Department of Health recommends that men limit their consumption to no more than 4 “units” per day and that women limit their consumption to no more than 3 “units” per day (1 unit = 8 grams of ethanol). In addition to limits on quantity consumed per day, some definitions of controlled drinking prescribe limits on the number of drinking days per week and limits on the speed with which one

consumes each drink (e.g., no more than one unit or standard drink per hour).

Controlled drinking is also typically defined by the reduction or absence of harmful drinking-related consequences. These include drinking-related health problems (e.g., significantly elevated liver enzymes, pancreatitis), legal problems (e.g., arrests for public intoxication, driving under the influence), occupational problems (e.g., missed work, poor performance, lost jobs due to drinking), and social and familial problems (e.g., drinking-related loss of friends, separation or divorce).

Controlled drinking also may be defined in terms of the drinker's subjective sense of control, but this is more difficult to assess than quantity consumed and consequences experienced. Although people without drinking problems occasionally experience urges or cravings for a drink, and persons without drinking problems occasionally drink more than they intend, the non-problem drinker typically experiences a sense that he or she is choosing when and how much to drink. Adapting Bandura's concept of self-efficacy, the definition of controlled drinking by problem drinkers could include the realistic belief that one can engage in self-control behaviors to create a moderate drinking outcome.

These three components of controlled drinking provide researchers, clinicians, and clients specific guidelines to evaluate the degree to which a problem drinker is moderating his or her drinking; however, problem drinkers need not fulfill all three components to reduce their drinking problem and improve their psychosocial functioning. As is the case with anxiety, mood, and other behavior disorders, improvement of drinking problems is not an all-or-none outcome.

Some clients and clinicians find the term "controlled drinking" an ambiguous and provocative one. It is ambiguous in the sense that all problem drinkers could be said to be "controlling" their drinking in the sense that they almost always exercise some choice regarding where, when, what, how much, and with whom they drink, even when their drinking is excessive and results in harmful consequences. It is provocative in the sense that some models of "alcoholism" assert that controlled, moderate, harm-free drinking is impossible once problem drinkers have manifested abuse or dependence.

Both treatment outcome studies and investigations of spontaneous remission or natural recovery have demonstrated that controlled drinking occurs in a meaningful subset of persons diagnosed with alcohol abuse and dependence. The likelihood of controlled drinking appears to differ depending on the severity of the population studied, but even in studies of chronic, dependent

drinkers, 10 to 15% have met study criteria for controlled drinking at follow-up. What is perhaps especially discouraging is the finding that abstinence by dependent drinkers appears to be no more frequent than is controlled or moderate drinking. The majority of alcohol-dependent patients experience relapse episodes or return to continuous problem drinking, and it is difficult to be optimistic about long-term, continuous abstinence or moderate drinking by dependent drinkers.

Is moderate drinking more or less stable an outcome than abstinence? The empirical evidence on this question is mixed, with some studies showing relapse more often following controlled drinking, some showing relapse more often following abstinence, and some showing no difference. Stability of any drinking pattern should not be taken for granted and many problem drinkers alternate among periods of abstinence, moderation, and excessive drinking. The stability of *both* moderate drinking and abstinence are probably influenced by multiple factors, including clients' psychological characteristics (e.g., psychological adjustment, impulsivity), drinking history, beliefs or expectations about drinking and abstinence, social support for abstinence versus moderate drinking, participation in abstinence-oriented or controlled drinking training, and the frequency of and ability to cope with transient intrapersonal and environmental stress.

II. SPECIFIC INTERVENTIONS TO TEACH MODERATE DRINKING

A. Basic Alcohol Education

To help set the foundation for later interventions—such as building motivation to restrain drinking, setting drink limits, and self-monitoring—clients are taught how alcohol is absorbed and metabolized, its effect on the central nervous system, beverage equivalencies, and the correlation between blood alcohol level and behavioral impairment. Basic alcohol education can be provided using pamphlets and book chapters on the topic or the therapist can provide basic alcohol education during an early session in the course of therapy.

B. Assessing and Building Readiness to Change

Despite cultural and clinical lore to the contrary, many problem drinkers are well aware of their excessive drinking and its consequences. To label as "denial"

the ambivalence that many problem drinkers (and people with other problems) feel about changing a cardinal feature of their behavior is simplistic and often inaccurate. Awareness alone, however, does not resolve ambivalence. Cultural mores that devalue expressions of personal “weakness,” and clinical interviewers who adopt an insensitive, disrespectful, and confrontational style, make it difficult for clients to verbalize—to family, friends and therapist—the disappointment, guilt, or shame they feel about their failed attempts to alter their problem drinking.

History-taking during assessment often reveals that a client’s excessive drinking serves one or more psychological functions, while concurrently impairing the client’s functioning in other life areas. Although the reinforcing properties of heavy drinking may appear intermittent and unclear to the therapist, they are powerful to the client and may overshadow the short- and long-term punishing effects of such drinking. Furthermore, as much as clients may recognize the disadvantages of their drinking, they are also afraid of the physiological and psychological consequences of quitting or reducing their alcohol consumption, many of which they have experienced during previous voluntary or unintentional periods of abstinence.

Therefore, to assess the client’s readiness to change, and to help build the client’s motivation for what may be a difficult process of initiating and maintaining a change in one’s drinking, the therapist can use empathy and reflective listening to explore the client’s ambivalence and to uncover and reinforce commitment to change. Motivation may also be assessed and strengthened by having the client list the advantages and disadvantages of both continuing to drink and of reducing or quitting drinking. Paper-and-pencil measures of readiness to change and useful guides to motivational interviewing are available to help the clinician undertake this intervention.

C. Goal Setting

The therapist provides guidance as the client sets (and periodically reviews) explicit, healthy limits on the maximum number of standard drinks or alcohol units he or she will consume per day and the maximum number of drinking days per week. In addition to setting this regular daily limit (for example, no more than 3 standard drinks per day and no more than 5 days of drinking per week), clients may be encouraged to consider limiting the number of drinks per hour and allowing themselves “special days” on which they may

exceed the regular limit (for example, up to 4 or 5 standard drinks once per month at a party).

Some therapists recommend that clients set themselves an initial 4-week period of abstinence—to reduce their tolerance, recover from any minor impairment in liver function, and demonstrate self-control—before they undertake moderate drinking. Alternatively, some therapists have clients reduce their daily limits over several weeks, “stepping-down” the daily limits over time to reach the client’s ultimate drinking limit, without an intervening period of abstinence. Further research may determine whether an initial period of abstinence is generally more or less productive of successful controlled drinking than stair-step decreases to moderation. In the absence of an unequivocal answer, and in light of individual differences in clients’ drinking histories, health statuses, and goal preferences, therapists may prefer to negotiate this issue with clients on a case-by-case basis.

D. Self-Monitoring

The drinker records, usually on a preprinted paper form, relevant aspects of his or her drinking, including, for example, urges to drink, number of drinks consumed, type of beverage consumed, and where and with whom the drinking occurred. Some therapists design the self-monitoring form in collaboration with the client; others present the client with copies of a preprinted form. In either case, the value of self-monitoring should be described to or elicited from the client, and the client should be encouraged to monitor every drink (and/or urge to drink), as soon as it is consumed (or experienced).

In addition to paper-and-pencil recording, self-monitoring could also employ other technologies, such as audio-recording and miniature personal computers, to record the selected drinking information. Similarly to its use with a wide variety of behavior problems, self-monitoring serves both as an assessment tool, because it provides the client and clinician with data about the target behavior, and as an intervention, because some clients will reactively decrease their consumption as a function of self-monitoring reactivity.

E. Change Drinking Pattern

The client is encouraged to change the manner and situations in which he or she drinks, in part to interrupt long-standing drinking habits that have led to excess. For example, the client could switch from undiluted

spirits to diluted drinks or beer; the client could wait at least 30 minutes between each drink and/or substitute nonalcoholic beverages between each alcoholic drink; and the client could delay the onset of drinking until the middle or late evening. The manner in which the client consumes each drink can also be modified, for example, by sipping rather than gulping drinks and by setting down one's glass between sips.

Using the self-monitoring data and client recollection of past drinking situations, the therapist can also help the client brainstorm ways to avoid high-probability situations for excessive drinking (or plan to exercise vigilance in those situations). Other ways to change the manner and situations in which one drinks include engaging in nondrinking activities (games, sports) while drinking, avoiding participation in round-buying (or skipping rounds to stay within one's limit), and restricting drinking to meals. The client can also be encouraged to appreciate the effects and benefits of moderate drinking. For example, the client can be encouraged to drink to enjoy the taste and initial feeling of intoxication, rather than to fit in with a group of heavy drinkers, to cope with depression or anger, or to postpone dealing with problems.

F. Social Skills Training

Research on self-reported reasons for relapse indicates that many clients drink excessively to cope with social pressure, negative emotions, stress resulting from daily hassles, and major life events. Therefore, specific skill training has been employed to help clients cope with challenges to their drinking goals, whether abstinence or moderate drinking. These skills include assertive drink refusal, progressive muscle relaxation, and problem-solving.

G. Contingency Contracting

Contingency contracts, which specify the relationship between performance of a target behavior and its consequences, have been used with problem drinkers to reinforce both abstinence and moderate drinking. Although behavioral contracts can take a variety of forms, there are several basic elements of most behavior contracts. These include a clear and detailed description of a client's drinking limits (including, for example, the inter-drink interval, number of abstinent days per week, definition and frequency of special drink days); a time limit for attaining the drinking goal (or approximations to the final goal); specific and immediate positive reinforcements for main-

tenance of the drinking limits; and self-monitoring or some other method of observation, measurement, and recording of the target behavior.

Contracts may also include punishments (e.g., loss of money or valued object) for failure to meet contractual obligations. The contract should also include an explicit date for renegotiation and all relevant parties should sign the contract, assuming it is written. It is not uncommon for the therapist to have a role in the monitoring of contract compliance and delivery of reinforcements. As therapy proceeds, it is best to find ways to transfer these tasks to others in the client's natural environment. Empirical evidence does not consistently favor the effectiveness of mutually authored contracts over therapist-authored contracts, but some clients will prefer the former and coauthored contracts probably engage the client more fully in the contracting process.

H. Making Use of Found Time

The client may have some difficulty filling the time once taken up with heavy, prolonged drinking and its aftermath. To avoid boredom, and to help support a moderate drinking habit, the client can be encouraged to take up new (and increase existing) recreational activities to take the place of drinking. The therapist can guide the client as he or she considers a wide range of athletic, intellectual, social, political, religious, musical, and other activities he or she might want to sample. The client can also be encouraged to consider what functions heavy drinking had served, and what nondrinking activities might also accomplish those goals (e.g., other ways of mixing with people without spending long periods of time in bars).

I. Challenging Unrealistic Alcohol Outcome Expectancies

Alcohol expectancies are the beliefs one holds about the positive/desirable and negative/undesirable outcomes of drinking. For example, some people believe that drinking alcohol will make it easier for them to meet new people; that drinking helps them perform better sexually; that drinking will result in difficulty thinking clearly or speaking clearly. Such beliefs result from observing the outcomes of drinking by others (both *in vivo* and portrayed in popular culture) and by recalling (and anticipating) effects from one's own past drinking. Beliefs about the outcomes of drinking also appear to be contextual, depending on, for example, how much one anticipates drinking and what type of alcohol one will drink.

Using interview and any one of several paper-and-pencil self-report inventories, therapists and clients can learn the content and strength of the client's alcohol outcome expectancies. Clients are guided to examine which of their expectancies are realistic, and which exaggerate the benefits or minimize the harms of excessive drinking. Unrealistically positive outcomes that the client associates with excessive drinking can be challenged; alternate ways to achieve positive outcomes can be explored; and undesirable outcomes expected as a result of immoderate drinking can be reinforced.

J. Cue Exposure Therapy (CET)

Another cognitive-behavioral intervention—cue exposure with response prevention—has been used to help clients who want to control their drinking, as well as those who want to abstain. The assumption underlying CET is that a variety of cues have been associated over time with craving for and excessive consumption of alcohol. As a result, cues paired with withdrawal and relief drinking can come to elicit a conditioned desire or craving when the experienced drinker is in the presence of those cues. These cues include, for example, seeing or imagining one's favorite alcohol beverage, experiencing certain emotional states, being in the presence of other problem drinkers, and attending social events such as parties. Locations where one buys or consumes alcohol, illicit drug use and cigarette smoking, and, of course, consumption of an alcoholic beverage, may also trigger craving and excessive drinking.

CET is based on the idea that repeated exposure to these cues—without engaging in the conditioned response of perseverative drinking—can break the connection between experience of these cues, the strong desire or craving to drink, and relapse drinking. For clients with a moderate drinking goal, CET helps the client learn to resist urges to continue drinking in the presence of alcohol and other drinking cues *after* having consumed one or more alcoholic drinks.

CET with a moderate drinking goal (CET-MDG) involves repeated sessions during which the client is exposed to cues designed to elicit desire for additional alcohol after the client has consumed a priming dose of one or more drinks. In addition to the sight and smell of one's favorite beverage, cues can include photos or videos portraying other people drinking, verbal descriptions of likely drinking situations, and role-plays designed to provoke emotions that elicit craving. Each CET-MDG session typically involves two or three "cue exposure episodes," with repeated assessment of craving,

intoxication or self-efficacy, often combined with practice of coping skills to deal with one's desire to continue drinking. CET continues until the client reports that exposure to cues no longer provokes meaningful cravings. Throughout the therapy, clients are encouraged to engage and work through their cravings, instead of fearing, avoiding, or giving in to cravings.

Although the therapy takes place initially in the clinical setting, the client can be instructed to engage in self-guided cue exposure sessions in between sessions to build self-efficacy and promote generalization to the natural environment. Another way to facilitate generalization is to follow successful clinic-based sessions with therapist-guided cue exposure sessions in real-life settings. For example, clients could be escorted to a bar or restaurant where they typically drink excessively. Similarly to the clinic-based sessions, after consuming the priming dose of alcohol, the client would be asked to imagine experiencing emotions or interacting with persons who might provoke craving. As in the clinic, craving and self-efficacy would be measured periodically during the *in vivo* cue exposure session and the therapist and client would review how the client responded to cue exposure.

During the course of CET-MDG, the client learns that the desire to continue drinking, even after one has had a priming dose (that is, a moderate amount of alcohol), will dissipate with the passage of time (habituation) and the employment of various coping skills. Although cue exposure is based on classical conditioning, and presumably works by gradual extinction or deconditioning of craving, cue exposure may also work by increasing a client's self-efficacy. That is, CET-MDG may also increase a client's belief that he or she can successfully and repeatedly resist the temptation or craving to continue drinking past one's limits, even after consuming one or more drinks. For some clients, this realization is a powerful therapeutic experience.

III. MODES OF CONTROLLED DRINKING TRAINING

Behavioral self-control training and cue exposure therapy may be delivered using both individual therapy and group therapy. In addition, there are self-help pamphlets and books that have been written for clients (and therapists) to employ as guides to moderate drinking. For those clients who are comfortable with personal computers, there is software that teaches clients behavioral self-control techniques to modify their drinking.

IV. SOCIAL SUPPORT FOR MODERATE DRINKING

It seems reasonable to assume that family and friends serve as models for both controlled and uncontrolled drinking, and the therapist should assess whether their drinking habits will serve as a model for moderate drinking by the client. Also, because friends, family members, employers, probation officers, and others may believe that abstinence is the only achievable outcome for the client, clinicians should assess how supportive significant others will be of a controlled drinking goal by the client. These persons may benefit from education by the therapist regarding the prevalence of controlled drinking and the advantages of a trial of behavioral self-control training and cue exposure therapy for clients who want to moderate their drinking.

Social support may also be provided by other former problem-drinkers who are moderating their drinking. For example, mutual help groups for problem drinkers who want to moderate their drinking have been formed in the United States (Moderation Management; website address: <http://www.moderation.org>). Therapists might also consider facilitating postdischarge support groups for clients who have participated in controlled drinking training programs.

V. THEORETICAL BASES

Most controlled drinking interventions described above are based on teaching and reinforcing behavioral self-control. That is, the client is taught new skills and encouraged to employ existing skills to exercise control over when, where, why, and how much he or she drinks alcohol. The vast majority of outcome studies assessing the effectiveness of controlled drinking training have evaluated interventions based on principles of operant, associative, and observational learning. It is important to note, however, that cognitive-behavioral therapies are frequently used to help clients achieve abstinence, and that psychodynamic, humanistic, and other therapeutic approaches may be employed to help clients who want to moderate their drinking.

VI. APPLICATIONS AND EXCLUSIONS

Although some problem drinkers want to and will be able to drink moderately, many clinicians wonder if it is

worth offering controlled drinking training. Shouldn't clients always be told to abstain, both for their mental and physical health? Although abstinence might seem the easier and safer goal choice for those who abuse or are dependent on alcohol, there are several advantages of offering moderation as an outcome goal and moderation training as an intervention for persons with drinking problems.

A. Advantages of Offering Controlled Drinking in Treatment

First, moderation training may be viewed as one form of harm reduction. Harm reduction, broadly defined, refers to interventions designed to reduce, minimize, or eliminate unhealthy outcomes that might result from continuing to engage in high-risk behaviors. For example, controlled drinking by high-risk and incipient problem drinkers may arrest or reduce a pattern of drinking that would result in negative consequences later in life. It may also benefit heavy drinkers who might not otherwise go on to develop drinking problems, but who would still benefit from reducing their consumption.

Second, there is a growing body of evidence indicating potential health benefits of moderate drinking. Controlled drinking may also facilitate client participation in social, familial, and occupational situations and activities in which alcohol is consumed in moderation, both for its taste and its effects on conviviality. Even if only a subset of those with drinking problems are able to moderate their drinking, a history of alcohol abuse or dependence need not automatically preclude every problem drinker from enjoying the benefits of moderate consumption of alcohol.

Third, some outcome studies suggest that younger, male patients may be less likely to relapse, or more likely to experience healthy psychological and social functioning, if they are moderating their drinking rather than abstaining. Just as abstinence is a more stable and functional outcome for some problem drinkers, controlled drinking appears to be a more stable or functional outcome for others. Excessive drinking often leads to poor health and poor psychosocial adjustment, but that does not mean abstinence is the exclusive or automatic route to good health and adjustment.

Fourth, an abstinence-only requirement may reduce the attractiveness of psychotherapy for many alcohol-dependent and alcohol-abusing persons. A therapist who is open to discussion of nonabstinence outcome goals may be more likely to motivate change by problem drinkers who are ambivalent about the prospect of

life-long abstinence and who would otherwise not seek or stay in therapy. In addition, controlled drinking has advantages as an intermediate step on the way to abstinence for clients who might decide to abstain after successfully (or unsuccessfully) attempting to moderate their drinking.

A related advantage is that open discussion of controlled drinking, as either an intermediate or final outcome goal, acknowledges the reality that the ultimate decision to aim for abstinence or moderate drinking rests with the client. A clinician can provide helpful guidance as the client wrestles with this decision, but it is unrealistic to think that clients automatically accept treatment goals imposed on them by psychotherapists, probation officers, physicians, AA sponsors, or family members. Contrary to clinical lore about the necessity of accepting abstinence as the first step in recovery, some researchers have found that patients' acceptance or rejection of abstinence-only beliefs is not related to drinking outcome. The insistence by some service providers that clients accept abstinence as a condition of treatment may not be necessary for treatment success.

Finally, the client who selects his or her drinking outcome goal may be more likely to engage in therapy than the client who believes that an abstinence or moderate drinking goal has been imposed by someone else. For those health care professionals who have limited experience negotiating outcome goals with clients, William Miller and Stephen Rollnick published a book in 1991 on motivational interviewing techniques that are designed to promote change without countertherapeutic confrontation.

As any clinician who conducts controlled drinking therapy will readily acknowledge, some problem drinkers—based on their drinking history, previous treatment experience, health status, and so on—are best counseled to consider abstinence rather than controlled drinking. However, encouraging abstinence based on a client's individual situation seems likely to foster a different working relationship than demanding abstinence as a condition of therapy. Even for those clients for whom abstinence seems a healthier short-term or final outcome goal, moderate drinking is an improvement over the excessive, unhealthy drinking that led to treatment.

B. Who Is an Appropriate Candidate for Moderate Drinking?

It appears that a subset of problem drinkers control their drinking, either through their own efforts or with

training in behavioral self-control skills. Furthermore, controlled drinking does not inevitably result in relapse, and perhaps no more so than does abstinence. Therefore, the important question faced by both clinicians and problem drinkers is not, "Does controlled drinking occur?," but rather, "For which problem drinkers is controlled drinking an appropriate goal?" Reviews of patient characteristics associated with controlled drinking, abstinence, and relapse have concluded that several variables hold promise as predictors of moderate drinking, including severity of dependence, "alcoholic" self-concept or identity, and psychological and social functioning.

1. Severity of Dependence

This characteristic has received considerable attention as a factor that differentiates good candidates for controlled drinking from poor candidates. Specifically, some investigations have found moderate drinking more likely if the problem drinker has a history of relatively few signs and symptoms of dependence. However, other studies have reported that severity of dependence was not associated with outcome or found outcome associated with certain aspects of severity (e.g., presence of liver disease), but not others (e.g., duration of problem drinking).

The inconsistency with which severity of dependence predicts outcome across studies may be a function of how severity is measured. Future research may reveal that some measures of dependence (e.g., number of withdrawal symptoms, duration of drinking, negative consequences) predict controlled drinking better than do others. Also, even though the likelihood of moderate drinking may decline as severity of dependence increases, there may be a range of severity within which the likelihood of controlled drinking remains relatively constant. A subset of even the most severely dependent drinkers may be able to moderate their drinking as a function of other personal and environmental factors.

2. Alcoholic Identity

This characteristic, which has also been summarized using the term "persuasion," reflects the self-conceptualization of the problem drinker. Specifically, patients' selection of controlled drinking as their outcome goal, their beliefs and expectations of control, and their rejection of the label "alcoholic" appear to be associated with moderate drinking. Nonetheless, the number of problem drinkers who want to moderate their drinking (and the number who want to abstain) is larger than the number who will achieve their desired outcome. In addition, we

are faced with the challenge of distinguishing problem drinkers whose selection of controlled drinking (or abstinence) as an outcome goal is reasonably attainable from those whose choice is unrealistic. Furthermore, severity of dependence and self-conceptualization may be correlated in a substantial subset of problem drinkers. Subjective expectancy of being able to control one's drinking, and one's willingness to adopt an identity as "alcoholic," are probably correlated with one's history of tolerance and withdrawal and the experience of negative alcohol-related consequences that are considered indications of dependence.

3. Psychological and Social Functioning

In light of research showing that premorbid functioning predicts outcome in a variety of psychological disorders, it is not surprising that pretreatment psychological and social functioning also predict outcome in persons with alcohol problems. Specifically, psychological adjustment and better social functioning (e.g., intact family, social support, employment) are correlated with moderate drinking after discharge from alcoholism treatment. Social and psychological stability may contribute to outcome independently of severity of dependence and alcoholic identity, but we should consider the possibility that psychosocial functioning probably influences, and is influenced by, a problem drinker's drinking history, goal choice, and identity.

4. Demographic Variables and Family History Variables

Based on the current evidence, education and race are not consistently correlated with outcome, although there is some support for the prospect that younger drinkers (and perhaps older drinkers who have "burned out") may be appropriate candidates for controlled drinking. Also, some investigations that have included both genders found a larger proportion of those controlling their drinking during follow-up were women, and more research may reveal the biological, psychological, and social aspects of gender that influence drinking outcome. Although there has been considerable attention to the hypothesis that a predisposition to alcoholism is inherited, family history of drinking problems does not appear to be a consistently reliable predictor of which clients will moderate their drinking and which will abstain.

5. Integrating Multiple Predictors

An integrative model to predict treatment outcome published by G. Elal-Lawrence and colleagues in 1986 may serve as a useful guide to assessing a client's candi-

dacy for controlled drinking therapy. This model posits that it is the congruent or incongruent interrelationship among cognitive, behavioral, and physiological characteristics that predicts controlled drinking, abstinence, or relapse. Specifically, controlled drinking would be more likely if a problem drinker does not hold an abstinence-only ideology, believes he or she can control his or her drinking, and is in good physiological health. Abstinence would be more likely if the problem drinker holds an abstinence ideology, believes he or she can abstain from drinking, and is physiologically healthy. The model predicts relapse will result when the problem drinker has a poor physiological history (i.e., greater severity of dependence) and does not expect to be able to abstain, but believes that abstinence is the only appropriate outcome goal.

The model is a useful addition to the literature on predictors of outcome because it integrates multiple variables into meaningful dimensions, rather than simply counting the number of characteristics associated with controlled drinking or abstinence. It also explains why relapsers, abstainers, and moderate drinkers appear similar on some variables while differing on others: it is not any one client characteristic that is predictive, but the congruence–incongruence of one's drinking identity, one's outcome expectancies, and one's severity of dependence that is predictive. In addition to assessing these client characteristics, the clinician and client should also consider posttreatment environment and skills for coping with stressful life events as predictors of drinking outcome over time.

Although moderate drinking has been associated with lower severity of dependence, rejection of an alcoholic identity, selection and expectation of controlled drinking as an outcome goal, psychosocial stability, and a supportive posttreatment environment (and perhaps youth and female gender), these results should not be interpreted as indicating that every problem drinker who possesses these characteristics will be able to control his or her drinking. Nor should one assume that a problem drinker must possess all of the predictive characteristics to moderate one's drinking successfully. There is still considerable need for research on how to best match clients to specific therapies and specific environments to help them achieve specific drinking outcomes.

C. Acceptance of Controlled Drinking

As noted earlier, controlled drinking training is controversial in some countries and its application may be

limited by institutional treatment philosophy and setting. For example, abstinence is the predominant outcome goal prescribed for alcoholics and problem drinkers in American alcoholism treatment programs. A survey of American alcohol treatment agencies found that controlled drinking was considered unacceptable for clients in almost every responding residential program (including inpatient detoxification and rehabilitation services as well as halfway houses). However, almost one-half of the responding outpatient programs reported moderate drinking as appropriate for a minority of their clientele (e.g., drunk driving offenders).

Canadian alcohol treatment programs typically report somewhat more acceptance of controlled drinking than their geographic neighbor. A nationwide survey employing a random sample of Canadian alcohol treatment services found that about 40% of responding agencies endorsed controlled drinking as an acceptable goal for their clientele. Furthermore, one-third of the respondents working in agencies that did not offer controlled drinking reported moderate drinking as acceptable for clients in other services or for their own clients after they left the agency. Acceptance rates vary by type of service, with those programs treating more severely dependent clients (e.g., inpatient programs, community residential services, and halfway houses) rejecting controlled drinking as an outcome goal more frequently than outpatient services.

Unlike the United States, national surveys of Western European and Australian services have found widespread acceptance and application of controlled drinking as an outcome goal for problem drinkers. For example, two surveys of British alcohol treatment agencies revealed that about three-fourths of services found controlled drinking acceptable. Norwegian alcohol treatment centers are even more accepting of controlled drinking; 90% of respondents reported allowing outpatient clients to choose between abstinence and moderate drinking and 59% reported allowing inpatients a choice between outcome goals. Controlled drinking is also widely acceptable in Australia, with almost three-fourths of surveyed agencies in New South Wales accepting controlled drinking as an appropriate goal for some proportion of clients. Similarly to the results of surveys in the United States, United Kingdom, and Canada, acceptance varied by type of service in the Australian study. The vast majority of community-based services and alcohol treatment units endorsed controlled drinking, but none of the private services and only about one-fourth of residential services reported controlled drinking as acceptable.

VII. EMPIRICAL STUDIES

Empirical evaluations of controlled drinking training began to be published in the early 1970s. Over the past three decades, investigators have conducted studies using single case experimental designs and group designs to assess the effect of different components of behavioral self-control training and, to a lesser extent, cue exposure therapy, in a variety of outpatient and inpatient settings with both alcohol abusing and more severely dependent drinkers. Although the results of any one study may be discounted based on concerns about the quality of treatment, definition of the subject population, and validity of dependent measures and follow-up procedures, the effectiveness of cognitive-behavior therapy to help clients moderate their drinking has been demonstrated repeatedly.

Although not without their own disadvantages, meta-analytic reviews offer an alternative to critiques of individual investigations and narrative reviews because meta-analysis averages effect sizes across outcome studies that have employed different dependent measures. Furthermore, meta-analysis can be used to assess the association of outcome with client and study characteristics. In 2000, Glenn Walters conducted just such a meta-analysis to evaluate the efficacy of behavioral self-control training (BSCT) for problem drinkers.

Following a literature search to gather potentially relevant studies for review, Walters selected 17 studies published between 1973 and 1997 in which the investigators had compared BSCT to either a no-treatment control or otherwise treated comparison group. The combined effect size across all studies, dependent measures, follow-up periods, and types of drinking problem was .33, indicating a statistically significant and clinically meaningful relationship between this form of therapy and improved functioning.

Analyses of effect sizes by type of comparison group revealed that BSCT was superior to no-treatment controls and to other non-BSCT interventions for controlled drinking; BSCT was equally effective in achieving improvements in drinking and functioning as were abstinence-oriented interventions. Effect sizes did not differ significantly by type of outcome variable (that is, alcohol consumption versus drinking-related problems), by severity of client drinking (that is, alcohol abuse versus alcohol dependence), or by length of follow-up (that is, less than 1 year versus 1 year or longer). On this basis, Walters concluded that behavioral self-control training has been, on average, as effective as abstinence-oriented interventions and more

effective than non-BSCT interventions to reduce alcohol consumption and drinking-related problems over meaningful follow-up periods in a wide range of problem drinkers.

Cue exposure therapy with a moderation goal has been subjected to considerably less extensive evaluation, but initial research is very promising. For example, a recent study compared BSCT to CET-MDG using a short-term (6 sessions), outpatient, group therapy format (three or four clients with one therapist) with non-dependent, but seriously abusive, drinkers. Clients in the CET-MDG condition consumed a priming dose of 2 or 3 standard drinks (depending on gender), followed by in-session cue exposure and intersession homework of self-directed cue exposure in progressively more challenging situations. Both treatments showed improvements in perceived control, dependence symptoms, and quantity/frequency consumed, but the CET participants reported more improvement on the quantity and frequency measures than the BSCT participants.

VIII. CASE ILLUSTRATION

J.T. was a 21-year-old, male, never-married university student who was referred to an outpatient psychology clinic for assessment of his drinking following a conviction for DUI. By his report, J. typically drank at a student-oriented tavern near campus (although occasionally also in his dorm room) and his average consumption was two or three 15-ounce mugs of beer on Wednesdays, and six 15-ounce mugs of beer on Thursday, Friday, and Saturday nights. Self-monitoring during the initial weeks of therapy were consistent with this report, and also revealed that he occasionally drank as many as 15 standard drinks (beer and distilled spirits) on some evenings. Although the DUI conviction led to his referral, he readily acknowledged concern about his occasional inability to stop drinking once he had begun and he expressed a fear that he was on his way toward becoming a "serious alcoholic."

J.'s responses on the Michigan Alcoholism Screening Test (MAST) indicated he had experienced meaningful negative consequences from drinking, even though his total MAST score (14) was considerably lower than most problem drinkers seen in residential settings. His motivations for drinking were social companionship and enjoyment of the "buzz" of intoxication, but he was more likely to drink if he was feeling frustrated after an argument with his ex-girlfriend, a hectic week, or conflicts with family or friends. His parents were

currently occasional social drinkers, but one of J.'s siblings had had a drinking problem while attending college, and he considered two of his grandparents and several aunts and uncles to be "alcoholics."

During the assessment, J. stated that he desired a goal of controlled drinking rather than abstinence. His age (young adult), abusive (but not dependent) drinking history, lack of commitment to abstinence, and social stability suggested that he was a good candidate for a controlled drinking goal. Discussing with his therapist the advantages of explicit limit-setting, J. decided to moderate his drinking to not more than two or three drinks per night, and not more than three drinking episodes per week. Other therapy goals included increased self-confidence and self-esteem, increased assertiveness, and decreased reliance on alcohol as a coping skill to deal with interpersonal problems.

As both an outcome evaluation and therapeutic intervention, J.T. was asked to self-monitor his drinking, which continued throughout treatment. The self-monitoring initially included type and amount of alcohol consumed per day, drinking context (e.g., time of day, drinking location, companions), and consequences of drinking (both desirable and undesirable). Later in therapy, the self-monitoring form was revised to include recording of his drinking urges and accompanying thoughts and feelings, in addition to amount and type of alcohol consumed.

Initially, several additional components of BSCT (basic alcohol education, goal setting, functional analysis of drinking behavior, generation of coping strategies to be employed in high-risk drinking situations) were employed to help him moderate his drinking. Although the quantity consumed per drinking day decreased compared to baseline, neither J. nor his therapist was satisfied with the impact of these techniques on his drinking. Following an explanation of the rationale and procedure of CET with a moderation goal, J. agreed to a trial of CET. Sessions increased to twice per week for the next 5 weeks: One session each week was devoted to cue exposure and the other session was devoted to working on J.'s non-drinking-related difficulties. (During and following CET, self-esteem, relationship issues, and assertiveness were addressed using a supportive, rational-emotive therapy-based, problem-solving approach. Specifically, the therapist and client engaged in role-play, therapist-guided imagery, and discussion to dispute his unrealistic beliefs.)

The first two CET sessions were conducted in the psychology clinic. The sessions began by having J. drink a priming dose of alcohol (12-ounce can of his favorite

beer consumed in a glass mug), followed by formalized blocks of exposure to visual, tactile, and olfactory cues for drinking (i.e., he opened another 12-ounce can of his favorite beer, poured it into the glass mug, and followed instructions to hold the glass, look at the beer, smell the beer, and imagine how tasty it would be to drink it). The therapist also prompted him to rate his degree of intoxication and craving on a periodic basis.

The next three cue exposure sessions were conducted *in vivo* at J.T.'s favorite tavern. The client and therapist met at the clinic, walked to the tavern, and J. purchased the priming dose (15-ounce mug of his preferred beer). He then made a baseline rating of his desire for a drink and drank the priming dose over a period of approximately 15 minutes. Fifteen minutes after he finished the priming dose, a second mug of beer was purchased and placed in front of the client. He was asked to make the three standard ratings (desire, intoxication, and ability to resist a drink), but formalized blocks of visual, tactile, and olfactory cues were not used in the *in vivo* sessions. Instead, the client and the therapist discussed how delightful it would be to consume the second beer and how wasteful it would be to leave the beer unconsumed. Every several minutes, J. was asked to rate his desire for the beer, his degree of intoxication and his perceived ability to resist consuming the beer. In between ratings, J. and the therapist discussed ways he could cope with cravings.

Self-monitoring data during the CET phase and post-CET counseling phase of therapy revealed that the number of days each week on which he exceeded his drinking goal decreased meaningfully compared to both pretreatment and the initial, pre-CET period of therapy. However, there were occasional days on which he exceeded his goal, sometimes by two or three beers and sometimes by twice that many standard drinks. Qualitative data mirrored the self-monitoring record and revealed a notable change in J.T.'s identity: "[I've] realized I'm not the alcoholic I thought I was turning into, and I've been good about controlling it. There has been more than a couple of times that it has gotten out of hand, but for the most part there are other times that it could have gotten out of hand ... but didn't." When asked what components of therapy he found most helpful, he noted, "[Most useful for me was] probably the self-monitoring, you know, writing stuff down. And the cue exposure stuff we [did] ... especially going to [the *in vivo* bar] a couple of times. I think that's helped a lot ... just realizing I can go there and control it. You know, I had this mindset that once I got in there I wouldn't be able to stop once I started, you know, if I

had one ... I'd have 10." Ten months following termination, a follow-up interview revealed continued maintenance of moderate drinking, absence of negative consequences from drinking, and a psychological sense of mastery over his drinking.

IX. SUMMARY

The definition of controlled drinking may comprise three components: limits on the quantity, frequency, and rate of consumption; lack of negative drinking-related consequences; and a sense of self-efficacy about controlling one's drinking. Although controlled drinking—and abstinence—are relatively infrequent outcomes by more severely dependent drinkers, controlled drinking is apparently common by problem drinkers at the lower end of the severity continuum. Moderate drinking also has been associated with rejection of an alcoholic identity, selection and expectation of controlled drinking as an outcome goal, psychosocial stability, and a supportive posttreatment environment. However, given the instability of drinking patterns in many problem drinkers, and conflicting indicators in some clients, models that propose an interaction among drinking history, health, and cognitive and environmental factors may prove more useful in conceptualizing and predicting drinking over time. Despite the clinical advantages of offering controlled drinking to problem drinkers, and the empirical support for behavioral self-control training and cue exposure therapy to help some problem drinkers moderate their consumption, many alcohol treatment services in the United States and Canada do not offer controlled drinking training or accept controlled drinking as an outcome goal. The acceptance of controlled drinking as an outcome goal is considerably more widespread in Norway, Australia, and the United Kingdom.

See Also the Following Articles

Addictions in Special Populations: Treatment ■ Behavioral Weight Control Therapies ■ Contingency Management ■ Matching Patients to Alcoholism Treatment ■ Self-Control Therapy ■ Substance Dependence: Psychotherapy

Further Reading

Elal-Lawrence, G., Slade, P. D., & Dewey, M. E. (1986). Predictors of outcome type in treated problem drinkers. *Journal of Studies on Alcohol*, 47, 41.

- Heather, N., & Robertson, I. (1981). *Controlled drinking*. New York: Methuen.
- Hester, R. K., & Miller, W. R. (1989). Self-control training. In R. K. Hester & W. R. Miller (Eds.), *Handbook of alcoholism treatment approaches: Effective alternatives*. Boston: Allyn & Bacon.
- Kishline, A. (1994). *Moderate drinking: The new option for problem drinkers*. Tucson, AZ: See Sharp Press.
- Marlatt, G. A. (Ed.) (1998). *Harm reduction: Pragmatic strategies for managing high-risk behaviors*. New York: Guilford.
- Monti, P. M., Abrams, D. B., Kadden, R. M., & Cooney, N. L. (1989). *Treating alcohol dependence: A coping skills training guide*. New York: Guilford.
- Rosenberg, H. (1993). Prediction of controlled drinking by alcoholics and problem drinkers. *Psychological Bulletin*, *113*, 129.
- Sanchez-Craig, M., Wilkinson, D. A., & Walker, K. (1987). Theory and methods for secondary prevention of alcohol problems: A cognitively based approach. In W. M. Cox (Ed.), *Treatment and prevention of alcohol problems: A resource manual*. New York: Academic Press.
- Sobell, M. B., & Sobell, L. C. (1993). *Problem drinkers: Guided self-change treatment*. New York: Guilford Press.
- Walters, G. D. (2000). Behavioral self-control training for problem drinkers: A meta-analysis of randomized control studies. *Behavior Therapy*, *31*, 135.

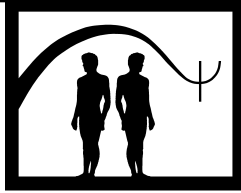

Control-Mastery Theory

Joseph Weiss

San Francisco Psychotherapy Research Group, San Francisco Psychoanalytic Institute,
and University of California, San Francisco

- I. Introduction to the Theory
 - II. Theoretical Bases
 - III. The Therapeutic Process
 - IV. The Therapist's Approach
 - V. Empirical Studies (Including Studies of the Patient's Plan Formulation)
 - VI. Summary
- Further Reading

GLOSSARY

anti-plan intervention An anti-plan intervention (including an interpretation), is an intervention that may impede patients in their efforts to carry out their unconscious plans. For example, a person who is working to become more independent may be set back by the interpretation that he or she is afraid of his or her dependency (see unconscious plan).

pathogenic belief A belief that is in varying degrees unconscious and that underlies the patients' problems. It warns persons suffering from it that if they attempt to solve their problems, they will endanger themselves or others. For example, persons may be impeded in their quest for success by the pathogenic belief that if they are successful they may hurt others.

pro-plan intervention An intervention (including an interpretation) that patients may use in their efforts to carry out their unconscious plan. For example, patients who want to be successful but believe that their success will hurt others may be helped by the interpretation that they are holding themselves back lest they hurt others.

survivor guilt The kind of guilt felt by persons who believe they have surpassed others by obtaining more of the good

things of life than others. Pathogenic beliefs are often concerned with survivor guilt toward parents and siblings.

unconscious plan The patients' unconscious plan (which in some cases may be partially conscious) specifies where patients want to go in their therapy. The unconscious plan is usually broad, loosely organized, and opportunistic. It is not a blueprint. It takes account of the therapist's personality and of changing life circumstances. An example is a person's planning to overcome his or her fear of rejection so that he or she may develop closer ties to others.

unconscious test An experimental action, ordinarily verbal, that the patient produces in relation to the therapist. The patient's purpose is to disprove his or her pathogenic beliefs. Patients hope that the therapist will pass their tests and so help them to disprove these beliefs. For example, patients who believe that they will be rejected may threaten to stop treatment, hoping unconsciously that the therapist will indicate or imply that the patient should continue.

I. INTRODUCTION TO THE THEORY

Control-mastery theory is a theory of the mind, psychopathology, and psychotherapy. It was introduced by Joseph Weiss, and was investigated empirically and developed by Weiss, Harold Sampson, and the San Francisco Psychotherapy Research Group (formerly the Mount Zion Psychotherapy Research Group).

Control-mastery theory assumes that patients are highly motivated, both consciously and unconsciously, to solve their problems, to rid themselves of symptoms, and to seek highly adaptive and important goals, such

as a sense of well-being, a satisfying relationship, or a meaningful career. Patients are in conflict about wanting to accomplish these things. This is because they suffer from pathogenic beliefs that tell them that by moving toward their goals they will endanger themselves or others. Throughout therapy, patients work with the therapist to change these beliefs and to reach their forbidden goals. They work to disprove their pathogenic beliefs by testing them in relation to the therapist, hoping that the therapist will pass their tests. In addition, patients use therapist interventions and interpretations to realize that their pathogenic beliefs are false, and a poor guide to behavior. The therapist's task is to help patients in their efforts to disprove their pathogenic beliefs and to move toward their goals.

II. THEORETICAL BASES

As our research and the research of academic psychologists have demonstrated, people perform many of the same functions unconsciously that they perform consciously. They unconsciously assess reality, think, and make and carry out decisions and plans. They unconsciously ward off mental contents, such as memories, motives, affects, and ideas, as long as they consider them dangerous. They unconsciously permit such contents to become conscious when they unconsciously decide that they may safely experience them.

Patients develop the pathogenic beliefs, which underlie their psychopathology, usually in early childhood, through traumatic experiences with parents and siblings. These beliefs, which are about reality and morality, may be extremely powerful. This is because for the infant and young child, parents are absolute authorities whom the infant or the young children needs in order to survive. Young children are highly motivated to maintain their all-important attachments to their parents. In order to do this they must believe their parents' teachings are valid, and that the ways their parents treat them are appropriate. For example, a young boy, who experienced himself as neglected by his parents, developed the pathogenic belief that he would and should be neglected, not only by his parents, but also by others.

The strength of children's attachments to their parents, and of the pathogenic beliefs acquired in their relations to their parents, is shown by the observation that adults, who in therapy are attempting to give up their pathogenic beliefs, often feel disloyal to their parents. If adult patients believe they have surpassed their parents by giving up the maladaptive beliefs and behav-

iors that they learned from their parents, and by acquiring more of the good things of life than their parents, they are likely to experience survivor guilt (surpassing guilt) to their parents.

III. THE THERAPEUTIC PROCESS

The therapeutic process is the process by which patients work with their therapists to change their pathogenic beliefs and to pursue the goals forbidden by these beliefs. Patients test their pathogenic beliefs by trial actions (usually verbal) that according to their beliefs should affect the therapist in a particular way. They hope that the therapist will not react as the beliefs predict. If the therapist does not, they may take a small step toward disproving the beliefs. If patients experience the therapist as passing their tests, they will feel safer with the therapist, and they will immediately change in the following ways:

1. They will become less anxious.
2. They will become bolder.
3. They will become more insightful.

Patients in therapy work in accordance with a simple unconscious plan that tells them which problems to tackle and which ones to defer. In making their plans, patients are concerned with many things, especially with avoiding danger. For example, a female patient who unconsciously believed that she had to comply with male authorities lest she hurt them, felt endangered by her therapy with a male therapist. She feared that she would have to accept poor interpretations or follow bad advice. Her plan for the opening days of therapy was to reassure herself against this danger. She tested her belief that she would hurt the therapist if she disagreed with him. First she tested indirectly, then progressively more directly. The therapist passed her tests; he was not upset, and after about 6 months' time the patient had largely overcome her fear of complying with the therapist, and so became relatively comfortable and cooperative.

IV. THE THERAPIST'S APPROACH

The therapist's task is to help patients disprove their pathogenic beliefs and move toward their goals. The therapist's attempts to accomplish this are case-specific. They depend on the therapist's assessments of the

patient's particular beliefs and goals, and the patient's ways of testing his or her pathogenic beliefs. For example, if a patient's primary pathogenic belief is that he or she will be rejected, the therapist might be helpful if he or she is friendly and accepting. If the patient's primary pathogenic belief is that he or she will be intruded upon, or possessed by the therapist, the therapist may be helpful by being unintrusive.

V. EMPIRICAL STUDIES (INCLUDING STUDIES OF THE PATIENT'S PLAN FORMULATION)

The San Francisco Psychotherapy Research Group (formerly the Mount Zion Psychotherapy Research Group) was founded in 1972 by Harold Sampson and Joseph Weiss to investigate and develop the control-mastery theory by formal empirical research methods. A number of our studies were carried out on the transcripts of the analysis of Mrs. C, which had been recorded and transcribed for research purposes. Several of these studies were designed to test our assumption that patients unconsciously control the coming forth of unconscious mental contents, bringing them to consciousness when they unconsciously decide that they may safely do so.

In one such study, Suzanne Gassner, using as data the transcripts of the first hundred sessions of Mrs. C's analysis, tested our hypothesis against two alternative hypotheses. According to one alternative, the patient brings forth repressed unconscious contents when the contents (in this case impulses) are frustrated, and so intensified to the point that they push through the patients' defenses to consciousness. According to the other alternative, the patient brings forth repressed contents when they are disguised to the point that they escape the forces of repression. The three hypotheses may be tested against one another because they make different predictions about what patients feel, while previously repressed contents that have not been interpreted are becoming conscious.

According to our hypothesis, patients have overcome their anxiety about the repressed contents before they come forth and so will not feel particularly anxious while they are emerging. Moreover, because they have overcome their anxiety about the contents, they will not need to defend themselves against experiencing them as they are coming forth, and so will experience them fully. According to the hypothesis that the contents come forth by pushing through the defenses, the

patient will come in conflict with them, and so feel increased anxiety while they are coming forth. According to the hypothesis that they come forth because they are disguised (or isolated) the person will not feel anxious about them as they are emerging, and because they are disguised, will not experience them fully.

Gassner located a number of mental contents that had been repressed in the first 10 sessions of Mrs. C's analysis, but which came forth spontaneously (without being interpreted) after session 40. She then had judges, by use of rating scales, measure the patient's degree of anxiety, and her level of experiencing, in the segments in which the contents were emerging. Her findings strongly support our hypothesis. The patient was not anxious in these segments (by one measure, she was significantly less anxious than in random segments). Moreover, her level of experiencing in these segments was significantly higher than in random segments.

Another research study was designed to test our hypotheses about the patient's unconscious testing of the therapist, and was carried out by George Silberschatz, using the transcripts of the first 100 sessions of Mrs. C's analysis. From our study of Mrs. C, we had assumed that Mrs. C unconsciously made demands on the analyst so as to assure herself that she could not push him around. We assumed that she would be relieved when the analyst did not yield to her demands. Another group of investigators assumed that Mrs. C unconsciously made demands on the therapist in order to satisfy certain unconscious impulses. They assumed that Mrs. C would become more tense and anxious when the analyst did not yield to her demands. Silberschatz, whose research design was considered satisfactory to both groups of investigators, demonstrated that when the analyst responded to Mrs. C's demands by not yielding to them, Mrs. C became less tense and anxious than before the analyst's response. Silberschatz' findings were statistically significant. These findings strongly support our assumption that the patient is unconsciously testing the analyst by her demands, rather than unconsciously seeking the gratification of unconscious impulses.

Another series of investigations was carried out by our group to test the hypothesis that patients benefit from any intervention, including any interpretation that they can use in their efforts to disprove their pathogenic beliefs and to pursue the goals forbidden by them. We assumed that after a pro-plan intervention, the patients' pathogenic beliefs are temporarily weakened. Therefore, we hypothesized that since patients maintain their repressions in obedience to their pathogenic beliefs, that after a pro-plan intervention, patients

would become a little more insightful, and a little less inhibited. We assumed, too, that anti-plan interventions would not help the patient, or might even set the patient back.

The first step we took in preparation for studying the effects of pro-plan and anti-plan interventions was carried out by Joseph Caston, in 1986. It was to demonstrate that independent judges could agree reliably on a formulation of the patient's plan. Caston broke down the patient's plan formulation into four components: (1) the patient's goals, (2) the obstructions (pathogenic beliefs) that impede patients in the pursuit of their goals, (3) the tests the patient might perform in their efforts to disprove their pathogenic beliefs, and (4) the insights patients could use in their efforts to disprove their pathogenic beliefs.

Caston gave independent judges extensive lists of goals, pathogenic beliefs, tests, and insights, along with the condensed transcripts of the first 10 sessions of Mrs. C's analysis. The judges were asked to read the transcripts, and then to rate the items in each category for their pertinence to the patient's plan. Caston found that the judges did agree on a plan formulation, and that their agreement was statistically significant.

Caston used his plan formulation to evaluate Mrs. C's responses to pro-plan and anti-plan interventions. Caston tested the hypothesis that the patient would respond immediately to pro-plan interventions by becoming bolder and more insightful, and that she would respond negatively to anti-plan interpretations by becoming less insightful, and less bold. Caston found strong confirmation of this hypothesis in his pilot study; however in the replication study he found that the hypothesis held for pro-plan interventions, but not for anti-plan interventions. Apparently Mrs. C responded favorably to pro-plan interventions but was not set back by anti-plan interventions.

In a study of the last 100 sessions of Mrs. C's analysis, Marshall Bush and Suzanne Gassner in 1986 tested the hypothesis that Mrs. C would demonstrate an immediate beneficial effect when offered pro-plan interventions, but that she would be set back by anti-plan interventions. They found strong statistical support for this hypothesis.

Our research group also studied the immediate effects of pro-plan and anti-plan interpretations in brief psychotherapies. Polly Fretter, Jessica Broitman, and Lynn Davilla studied three 16-session psychotherapies to determine whether pro-plan interpretations had a beneficial effect. They used a new version of Caston's method of obtaining a plan formulation that had been

developed by John Curtis and George Silberschatz. In addition, unlike Caston, they did not study the effect of all interventions, but only of interpretations (that is, interventions designed to provide insight).

Fretter showed that following a pro-plan interpretation, the patient was less defensive, and so developed a statistically higher level of experiencing. Broitman demonstrated that after a pro-plan interpretation, the patient became more insightful, as measured by a generic insight scale. Her finding was statistically significant. Davilla, whose findings were statistically significant, demonstrated that the patient, following a pro-plan interpretation, moved toward his or her goals as defined in the patient's plan formulation.

Our group also studied the long-term (as opposed to the immediate) effect of pro-plan interventions. In the three cases investigated by Fretter, Broitman, and Davilla, it was demonstrated that the patient who was offered the highest percentage of pro-plan interpretations did the best, as measured by a series of outcome measures, administered 6 months after the termination of treatment. The patient who received the second highest proportion did the second best, and the patient who received the lowest percentage did the worst.

We also investigated the immediate effect of pro-plan interpretations on the patient's pulse rate, skin conductance, and body movement, in three brief psychotherapies (these are not the same therapies studied by Fretter, Broitman, and Davilla). Nnamdi Pole demonstrated that pro-plan interpretations had an immediate effect on the patient's pulse rate: the pulse rate decreased. His research also showed that the patient sometimes responded very rapidly to pro-plan interpretations: The patient's pulse rate would sometimes fall before the therapist finished an interpretation, and before the patient consciously acknowledged the validity of the interpretation.

Our research group has also studied brief psychotherapies to test the hypothesis that a patient shows an immediate favorable reaction when the therapist passes her tests. Curtis and Silberschatz, in the study of two brief psychotherapies, demonstrated that immediately after a passed test, the patient showed a higher level of experiencing than before the passed test. In another study, Tom Kelly demonstrated that the patient responded to a passed test by an immediate decrease in tension, as measured by a voice stress measure. In a study of one patient, Jerry Linsner showed that after a passed test the patient demonstrated an increase in pro-plan insight as defined in the patient's plan formulation. In a study of three patients, Jack Bugas demonstrated that after a passed test

the patient demonstrated a greater capacity to exert control over regressive behavior.

In our clinical work we observed that pathogenic beliefs are often concerned with survivor guilt. Lynn O'Connor and Jack Berry conducted a series of investigations concerning the role of survivor guilt in psychopathology. These studies were conducted by means of a new pencil-and-paper questionnaire, the Interpersonal Guilt Questionnaire (IGQ), developed by O'Connor and others to measure survivor guilt and several other forms of guilt. The investigations, which were statistically significant, demonstrated that survivor guilt is highly correlated with feelings of shame, and also with feelings of fraudulence and pessimism. It correlates with a tendency to be submissive, and it is high in persons suffering from depression. It is high in recovering addicts and children of alcoholics. It predicted recidivism in a group of women on probation in Massachusetts.

VI. SUMMARY

The control-mastery theory assumes that patients' problems stem from grim, frightening, unconscious, maladaptive beliefs. These beliefs, here called "pathogenic," impede the patient's functioning, and prevent the patient from pursuing highly adaptive goals. Patients suffer from these beliefs, and are highly motivated both to disprove them and to pursue the goals forbidden by them. The patient works throughout therapy in accordance with an unconscious plan to accomplish these things. The thera-

pist's basic task, which follows from the above, is to help patients to disprove their pathogenic beliefs and to pursue their goals. The theory has been supported by numerous formal quantitative research studies.

See Also the Following Articles

Character Pathology ■ Psychoanalytic Psychotherapy and Psychoanalysis, Overview ■ Thought Stopping ■ Unconscious, The

Further Reading

- Curtis, J., Silberschatz, G., Sampson, H., Weiss, J., & Rosenberg, S. (1988). Developing reliable psychodynamic case formulations: An illustration of the plan diagnosis method. *Psychotherapy, 25*, 256–265.
- O'Connor, L. E., Berry, J. W., & Weiss, J. (1999). Interpersonal guilt, shame, and psychological problems. *Journal of Social and Clinical Psychology, 18*, 181–203.
- Sampson, H. (1992). The role of "real" experience in psychopathology and treatment. *Psychoanalytic Dialogues, 2*, 509–528.
- Silberschatz, G., Fretter, P., & Curtis, J. (1986). How do interpretations influence the process of psychotherapy? *Journal of Consulting and Clinical Psychology, 54*, 646–652.
- Weiss, J. (1993). *How psychotherapy works: Process and technique*. New York: Guilford Press.
- Weiss, J., Sampson, H., & The Mount Zion Psychotherapy Research Group. (1986). *The psychoanalytic process: Theory, clinical observations, and empirical research*. New York: Guilford Press.

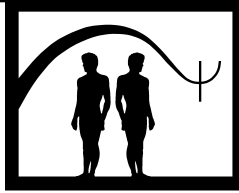

Corrective Emotional Experience

Deborah Fried

Yale University

- I. Introduction
- II. Definition, History, and Contemporary Uses of the Corrective Emotional Experience
- III. Therapeutic Alliance, Corrective Emotional Experience, and the Outcome of Psychotherapy
- IV. Summary
Further Reading

GLOSSARY

defenses A person's habitual ways of protecting herself or himself against uncomfortable thoughts and feelings.

expressive therapy Therapy aiming to uncover unconscious thoughts, beliefs, and feelings; often stirring up anxiety as new mental content is discovered.

intrapsychic Within one person's mind, not between people.

psychoanalytic Pertaining to the school of thought that values understanding the unconscious mind (e.g., via expressive therapy and psychoanalysis).

supportive therapy Therapy geared at lowering anxiety, helping a patient feel better without necessarily understanding new things about himself or herself.

transference The patient's thoughts, feelings, and beliefs about the therapist that are derived from the relationships the patient had with earlier important relationships such as parents.

I. INTRODUCTION

In 1946, Franz Alexander wrote of the "corrective emotional experience" as the essential helping factor in

psychotherapy. The corrective emotional experience (CEE) refers to the "reexposure of the patient, under more favorable circumstances, to the emotional situations which he could not handle in the past." The reexposure is undertaken in psychotherapy via a reparative relationship with the therapist. Although considered by some to be a mainstay of psychotherapy, the CEE has had a very negative reputation in some circles, notably psychoanalytic ones. This has been perhaps because of some of Alexander's specific practices with the CEE, such as active role-playing in the analytic session. Contemporary studies of the elements of change and cure in psychotherapy suggest that a fresh look at the notion of the CEE reveals an important tool for the therapist. In this article, I will further define the term and put it in historical and contemporary contexts. I will describe the relationship between the CEE and the therapeutic alliance, which is the most robust predictor of good outcomes in psychotherapy.

II. DEFINITION, HISTORY, AND CONTEMPORARY USES OF THE CORRECTIVE EMOTIONAL EXPERIENCE

A. Franz Alexander's Definition

Alexander considered the basic principle of psychotherapy to be the patients' reexperiencing of formerly traumatic situations in the context of a

therapeutic relationship with a new partner, the therapist, who generates an atmosphere of tolerance and equanimity. Given the new relationship, the patient relives problematic events from the past and develops new ways to respond. The prototype for this reexperiencing was Jean Valjean, the hardened criminal in Victor Hugo's "Les Misérables." Alexander uses "reexperiencing" loosely, in that the therapeutic factor was the difference between the initial experiences and those with the therapist, in this case, a bishop.

1. Jean Valjean as the Patient

Jean Valjean was described as an ex-convict who experienced only cruelty in the world until he was startled by the kindness of a bishop he had been robbing. He discovers the effect of this encounter when he meets a little boy who dropped a coin. The ex-convict stepped on the coin, refusing to let the boy retrieve it. The boy ran off, and overcome with remorse, Valjean frantically attempted to find him, return the money, and thereby redeem himself. He did not find the boy but was, as Alexander quoted Hugo, able to start "a colossal and final struggle ... between his wickedness and that man's [the bishop's] goodness."

Alexander noted that the commonplace kindness of the bishop to a nasty ex-convict would not normally deserve our attention, but that the episode with the boy and Hugo's ensuing psychological explanation of Valjean's conversion were a prescient observation about the effects of psychotherapy. The catalyst to the criminal's change was the overwhelming nature of the bishop's generosity. Such generosity threw the criminal's expectations of people's responses into total disarray. Alexander noted that the emotional balance established by the criminal was based on his cruelty in response to his repeated experiences of the cruelty of the world he lived in. When the bishop broke that rule, Valjean experienced "the most formidable assault by which he had yet been shaken." In this state, he mistreated the little boy as if to reestablish the familiar patterns of cruelty by which he had organized his world. But the experience with the bishop so challenged that pattern that he no longer saw the world this way.

Alexander clarifies that a single experience of this sort could not "undo the cumulative effects of lifelong maltreatment" unless the criminal originally had a decent conscience in the first place, one that was later severely tarnished by years of hardship. The originally intact conscience rendered the criminal a good candidate for the very brief "psychotherapy," this experience with the bishop and the little boy.

2. The Role of the Therapist

Alexander specifies that the main job of the therapist is to offer a response to the patient that is utterly unlike the response expected from an authoritative person. Thus, the patient has a repeated opportunity to face, under more favorable circumstances, emotional experiences that were previously intolerable but can now be dealt with in a different manner. He noted that a patient's intellectual understanding of his problems would be insufficient to their cure, that the feelings stirred up in the therapeutic relationship were a mainstay that enables a patient to change.

Alexander described several steps to the process of treating emotional conflict. First, the future patient experiences a number of problematic events, emotionally distressing to the point of being traumatic. The patient comes to expect trouble, especially from significant others around him. The therapist now steps in with a different attitude than the patient expected, and the patient is surprised. The bishop was kind to the man who was robbing him. In being treated better than he deserved, the criminal's armour was chinked—he could no longer perceive people as deserving his meanness, and so began a transformation of his character, an apocryphal tale used by Alexander to describe this new concept, the corrective emotional experience.

Alexander emphasized that the therapist is not neutral, but always maintains a helpful attitude. He also noted that the reactions of the therapist should often not be spontaneous, lest they repeat the parents' problematic reactions to the budding patient, for example, "with impatience or solicitude which caused the neurosis" in the first place. Alexander was referring to patients' tendency to elicit from those around them characteristic responses. The job of the therapist is to know when to respond unspontaneously, to disconfirm the patient's expectations, no matter how tenaciously the patient pulls for them.

B. Reactions to the CEE

Several problems with the CEE concept have discouraged its use over the decades. Four specific problems will be discussed: Alexander's use of medications in the sessions, the lack of applicability of the CEE to all kinds of patients, the use of role-playing to create the CEE in the therapy, and the history of a disdainful attitude toward supportive techniques, as the CEE has generally although erroneously been described.

1. “Narcosynthesis”

Alexander suggested that drug-induced states of mind could be ideal for the CEE to unfold in therapy. Under narcotic treatment, patients could relive in fantasy the past dangers that they had been unable to master. With the therapist present, the patient’s anxiety would be reduced and the patient could become better able to face the previously intolerable situation. Today, in session, use of medications in this way, “narcosynthesis,” is rare, although “reliving” the past with the therapist is a viable strategy for some clinicians, as discussed below.

Writing in the 1940s, Alexander had far less available to him in the way of a pharmacopoeia. Currently, disorders of mood and thought, with symptoms such as mood instability, psychosis, anxiety, and depression are usually addressed with medications. Any current discussion of the CEE makes most sense with the proper use of medications in mind, because no relationship between therapist and patient can begin until the symptoms are manageable. Ironically, although Alexander’s use of in-session medications has little following, the general use of medicines is ubiquitous and psychotherapy can often progress only because of their effects.

2. The Problem of Applying the CEE

Detailed review of past experiences is often a way psychotherapy begins. How such review is used subsequently in the treatment varies with patient and clinician. There is controversy about the efficacy of this method for the treatment of some disorders, given the potential risks that an attempted CEE could bring. For some patients with posttraumatic stress disorder, symptoms can worsen after reexposure to past traumas. In contrast, some recent research by Edna Foa and others shows that it can be very helpful when a patient therapeutically reexperiences past trauma. The astute clinician carefully follows the patient’s state of mind in sessions and knows when reviewing certain material would be likely to help the patient.

3. The Problem of Role-Playing

Alexander was in line with some current psychoanalytic thinking in his emphasis on the patient’s relationship with the therapist as the curative factor in the therapy. He ran afoul of psychoanalytic communities with his approach to the patient via role-playing in psychotherapy. Alexander (and his followers) would attempt to revisit traumatic interpersonal events in a patient’s life by taking the role of the previously trau-

matizing other (e.g., parent, teacher, boss) and enacting scenarios designed to counter these early pathogenic experiences. In the therapeutic setting, the therapist would facilitate reality testing and so enable the patient to feel and respond differently than in the past. The goal was to allow the patient to have the new experience in the safety of the therapist’s office and apply the learning outside the office in his daily life. These psychotherapies were brief in duration, a number of months, and part of the mission was to use role-playing in order to shorten therapies that were growing increasingly unwieldy in their multiyear duration.

Psychoanalysts continue to criticize role-playing as a manipulation of the transference, forcing the patient to notice the “goodness” of the therapist contrasted with the “badness” of previously hurtful others. Howard Levine, writing an annotated list of essential reading in psychoanalytic psychotherapy in 1995, called this play acting the *bete noire* of psychoanalysis, and noted that role-playing contrasted with standard psychoanalytic thoughts of how therapy produces change. Role-playing can be seen as putting the patient in an artificial position, having to respond to the therapist’s theatrics rather than reaching greater awareness about his or her own mental life in the context of the relationship with the therapist.

4. The Problem of CEE as a Supportive Technique

Different kinds of psychotherapies have different aims, which can be described on a supportive–expressive continuum. Supportive techniques shore up a patient’s defenses; expressive techniques analyze defenses and uncover unconscious material. Support in psychotherapy serves to decrease a patient’s anxiety, helps patients feel better about past actions and events, and enables patients to appreciate their skills in adapting to events around them. In psychoanalytic terms, what is supported is the patient’s ego function. The patient is not necessarily helped to understand more about his or her unconscious mind via supportive techniques (but is only able to do so when adequately supported). An example of a supportive comment is: “You seemed to have worked very hard to finish that project and yet the professor crushed you with his comments about it” rather than the relatively unsupportive but more exploratory “How do you understand the professor’s response to your work?” This is relatively unsupportive, but not absolutely; while there is support in the therapist’s attention to and wondering about the story the patient tells, this is an example of expressive technique,

aimed to uncover more than what the patient already knows, thinks and feels.

The generally supportive experience of being accepted is a main feature of the corrective emotional experience, but the emphasis on support was another strike against the CEE. Historically, although not universally, support has been considered a risky if not poor psychoanalytic technique, undermining the possibility for patients to further their understanding of what had been previously unconscious. Anxiety can be a motivator for further self-exploration. When patients are feeling supported, they can relinquish the anxious mood but perhaps also any interest in understanding what they feel and why and how they create trouble in their life. When the goal of treatment is to allay a symptom such as anxiety rather than foster deeper understanding, support is a predominant tool. In psychoanalytic endeavors, anxiety is considered an ally to the therapeutic mission when it motivates the patient to think in new ways and uncover new mental material. As Alexander's use of Jean Valjean as a case example demonstrates, the CEE is both supportive and expressive. In this case, a seemingly supportive move by the bishop was actually experienced as quite anxiety producing for the thief. The thief's capacity for remorse, introspection, and reparative attempts evolved only after his perceptions of the world were shaken, after the bishop startled him with persistent kindness. The thief and the bishop exemplify naturally corrective experiences of life with other people, consistent with Alexander's note that the CEE need not take place only in the relationship with the therapist; there are opportunities for corrective experiences within the relationships of the daily life of the patient.

Given these problems with and misunderstandings about the CEE, it is little wonder that it has not always been considered a useful construct. Thoughtful appraisal of how Alexander defined and used the CEE brings us to the next consideration: how the CEE can be used within the context of the therapeutic alliance.

III. THERAPEUTIC ALLIANCE, CORRECTIVE EMOTIONAL EXPERIENCE, AND THE OUTCOME OF PSYCHOTHERAPY

A. The Therapeutic Alliance

1. Definition of the Therapeutic Alliance

The therapeutic alliance is the connection between patient and therapist, the mutual agreement to work

together on tasks related to the patient's well-being. The alliance is a joint sense of mission, collaboration, trust in the other, and hope. With such an alliance, the patient expects the therapist will understand him, tolerate him, and help him understand himself better and then feel better, now and in the future.

The feeling of being understood, cared about, and cared for is an important emotional state in which to embark on psychotherapy, a *sine qua non* for most patients to even begin considering candid revelation to an utter stranger, the therapist. To feel allied with another person can itself be corrective. When the match between therapist and patient is successful, a surprising, impressive amount of work can be accomplished. It is no surprise then that the single factor in psychotherapy that explains the outcome of the psychotherapy has been repeatedly demonstrated to be the therapeutic alliance.

2. The Therapeutic Alliance and Psychotherapy Outcome Studies

Psychotherapy is difficult to study. Psychotherapy outcome studies show that psychotherapy does work: patients, family members, therapists, and neutral research judges agree, based on a generous variety of measures such as symptom checklists, mental health rating scales, and measures of ability to function at home and at work. The one element common to the successful psychotherapies is the therapeutic alliance. The repeated showing of the alliance as the main predictor of good outcome leads scholars and clinicians to consider the alliance the "quintessential" aspect of all psychotherapies.

B. The CEE as a Tool for the Therapist Who Has a Therapeutic Alliance with the Patient

Psychotherapy takes place only in the context of an adequate therapeutic alliance. In this circumstance, the therapist has access to various tools such as supporting the patient's better efforts at self-understanding, questioning the wisdom of others, medicating the more severe symptoms, and using the CEE to alert the patient to a new perspective on interpersonal relationships. In this context, the surprises of the corrective emotional experience can unfold as the therapist disconfirms the expected responses that the patient has long come to elicit from others.

Much that is inherent in psychotherapy would be an example of the CEE tool: the therapist being timely, in speech and presence; having reasonably pleasant facial

expressions when greeting the patient; looking at and listening the patient; remembering the content of the last session and the dreams and stories of previous discussions; knowing the important anniversary dates in the patient's life, and so on. These techniques tell the patient he or she is valued, worthy of listening to, and being helped. The CEE as a tool differs from the narrower specificity of other tools, such as interpretive comments about material previously out of the patient's conscious awareness. Once thought by psychoanalysts and analytically oriented clinicians to be the most crucial technique for therapeutic success, interpretations are now considered by some to be another valid tool but not the most valuable one. Hanna Levenson, in her 1995 review of time-limited therapies, considers the CEE to be the "modernist" way of construing the historically important accurate and precise interpretation of unconscious material, emphasizing the relational rather than the intrapsychic in psychotherapy. The importance attributed to relational over interpretive tools of the therapist has increased in recent years, concordant with the repeated findings of good therapeutic outcome based on the relationship rather than on the accuracy of interpretation.

C. The Therapist's Judgment

The importance of the therapeutic alliance, the therapist's most basic tool, and the use of the CEE as a specialized tool are not to suggest that the therapist is without judgmental capacity. Therapy would not be worth much were that so. Rather, the therapist offers a reasonably balanced ear and may certainly disagree with and disapprove of some of the patient's behaviors and plans. For example, a patient prone to feeling entitled to more than her due, who treats others with contempt, has her CEE when the therapist enables her to hear her disdain and consider how this stance puts people off and has probably contributed to the patient's need for the therapy.

IV. SUMMARY

The CEE as an explicit concept has been with therapists since the 1940s. It has elements of both supportive and expressive psychotherapeutic technique. The corrective emotional experience is felt by the patient who expects certain responses from people but is instead surprised by the therapist's disconfirmation of the

expected response. It is a tool available to the therapist who has formed a good therapeutic alliance with the patient. In its more dramatic incarnations, such as when induced by medications in a therapy session, it has been eschewed by psychoanalysts. More gently introduced, it is part of every psychotherapy that has helped a patient and merits a place in future psychotherapy research studies that can further the understanding of how and why psychotherapy works.

Acknowledgments

I want to express my appreciation to Jonathan Fried for editorial assistance, and to colleagues Susan Bers, Lisa Marcus, Nancy Olson, and Joan Wexler for insightful comments about the CEE.

See Also the Following Articles

Effectiveness of Psychotherapy ■ History of Psychotherapy ■ Outcome Measures ■ Role-Playing ■ Supportive-Expressive Dynamic Psychotherapy ■ Time-Limited Dynamic Psychotherapy ■ Transference ■ Working Alliance

Further Reading

- Alexander, F., & French, T. M. (1946). *Psychoanalytic psychotherapy: Principles and application*. New York: The Ronald Press Company.
- Baker, R. (1993). The Patient's Discovery of the Psychoanalyst as a New Object. *International Journal of Psychoanalysis*, December 74 (Pt 6), 1223–1233.
- Foa, E. B. (2000). Psychosocial treatment of posttraumatic stress disorder. *Journal Clinical Psychiatry*, 61 (Suppl. 5), 43-8; discussion 49–51.
- Kantrowitz, J. L. (1995). The beneficial aspects of the patient-analyst match. *International Journal of Psychoanalysis*, April 76 (Pt 2), 299–313.
- Levenson, H. (1995). *Time limited dynamic psychotherapy*. Basic Books, New York.
- Levine, H. (1995). Psychoanalytic psychotherapy. In M. H. Sacks, W. H. Sledge, & C. Warren (Eds.). *Core readings in psychiatry (3rd ed.)*. Washington, DC: APA Press.
- Martin D. J., Garske, J. P., & Davis, M. K. (2000). Relation of the therapeutic alliance with outcome and other variables: A meta-analytic review. *Journal of Consulting and Clinical Psychology* 68, 438–450.
- Rockland, L. H. (1989). *Supportive psychotherapy: A psychodynamic approach*. New York: Basic Books.
- Winston, A., Pinsker H., & McCullough, L. (1986). A review of supportive psychotherapy. *Hospital and Community Psychiatry*, 37, 1105–1114.

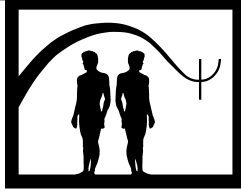

Correspondence Training

Karen T. Carey

California State University, Fresno

- I. Description of Treatment
 - II. Theoretical Bases
 - III. Empirical Studies
 - IV. Summary
- Further Reading

Correspondence training involves developing the relationship between children's verbal accounts of behavior and their actual behavior, between saying and doing. According to Ruth Baer, J. Williams, Patricia Osnes, and Trevor Stokes in 1983, correspondence training is training in "promise keeping."

GLOSSARY

- delayed reinforcement** Reinforcement occurs after some period of delay following a correct response to a target behavior.
- generalization** The result of behavior change occurring under different conditions, settings, and behaviors from the original targeted conditions, settings, and behaviors.
- maintenance** The maintaining of behaviors over time following an intervention.
- natural communities of reinforcement** Reinforcement that is available in the normal, day-to-day environment.
- prompt** Verbal directions, modeling, or physical guidance that help an individual initiate a response.
- self-regulation** Involves observation or monitoring of one's own behavior, judgmental processes concerning one's own performance, and reactions of the individual to his or her behavior and performance.
- social reinforcement** Reinforcement that can include physical contact such as hugs or verbal statements such as approval when an individual engages in an appropriate response.
- tangible reinforcement** Objects, such as toys or stickers for young children, given when an individual engages in an appropriate response.
- target behavior** The behavior selected for change.

I. DESCRIPTION OF TREATMENT

The focus of correspondence training is on verbalizations used to mediate behaviors. According to Ruth Baer, J. Williams, Patricia Osnes, and Trevor Stokes in 1983, "reinforcement is made contingent on both promising to engage in a target response and then actually doing so, or on truthfully reporting past actions" (p. 479).

In general, the treatment involves asking the child what he or she plans to do in a certain situation (e.g., "Are you going to talk to your teacher today?"). If the child responds positively to the question asked, the adult restates the behavior or tells the child to engage in the behavior (e.g., "Ok, you will talk to your teacher today"). If the child does not spontaneously respond to the initial question, the adult prompts the child until the child responds.

After the child has had an opportunity to engage in the behavior the child is provided with feedback regarding his or her behavior. If the child engaged in the behavior (i.e., talked to the teacher), the child is verbally,

socially, or tangibly reinforced. If the criterion was not met (i.e., the child did not talk to the teacher), the adult tells the child the criterion was not met and does not provide a reinforcer (e.g., "You said you were going to talk to your teacher today, but you didn't, so you can't have a sticker"). By repeatedly reinforcing correspondence between a child's verbal and nonverbal behavior it is expected that the child's verbal behavior will serve as a powerful discriminant stimulus for appropriate responding.

II. THEORETICAL BASES

Correspondence training is a self-mediated intervention technique. Such techniques are based on the concept of self-regulation, which involves one's ability to monitor one's own behavior. According to Frederick Kanfer and Paul Karoly in 1982, self-regulation or self-management "signifies the gradual assumption of control by the individual over cueing, directing, rewarding, and correcting his or her own behavior" (p. 576). Methods of external control by parents, teachers, or peers can be used to teach self-management skills.

Furthermore, language has been a target for many self-regulation intervention efforts for several reasons. First, language is often a well-developed skill with a pattern that results in some control over one's behavior. Second, language can be readily used across different environments and with different individuals. Lastly, language can be used conveniently and with little effort. Thus, language may facilitate behavioral changes across inconvenient settings and difficult circumstances.

Correspondence training is a type of self-regulation whereby the individual verbally agrees to engage in some targeted behavior and then after doing so is reinforced. Results of a number of studies indicate that it is a successful intervention for changing behavior.

III. EMPIRICAL STUDIES

In 1985, Ruth Baer, J. A. Williams, Patricia Osnes, and Trevor Stokes studied the effects of correspondence training with a 3-year-old boy described as having normal intelligence and no major behavior problems. Three behaviors were selected for training: picking up his pajamas after dressing, picking up his clothes after a bath, and choosing fruit for dessert. His mother observed both occurrences and nonoccurrences of the targeted behaviors.

The procedure was examined across two conditions. In the first condition, the child was questioned about specific home behaviors in the late afternoon prior to going home. During this private questioning period the child was asked by the teacher what he was going to do at home. When the child responded correctly he was praised. Prompts were provided to the child when needed in order for him to respond. However, prompts were required for only several sessions in order to elicit complete sentences (e.g., "I'm going to choose fruit for dessert"), and then were withdrawn.

On the next day, reinforcement was given only if the correct promise had been made the preceding day. Even if the behavior was not performed, the correct promise was reinforced. The consequences were described as follows by Ruth Baer, Patricia Osnes, and Trevor Stokes: "a grab bag containing slips of paper, each with one of the following written on it: 1 Big Hug; 2 Big Hugs; 2 Tosses in the Air; 3 Tosses in the Air; 3 Swings; 4 Swings; 5 Swings; 2 Tickles; 3 Tickles; 4 Tickles; Piggy Back Ride; Pick a Toy. If (the child) drew Pick a Toy, he was allowed to choose from a selection of inexpensive trinkets."

In the second condition, the teacher gave social praise and tangible reinforcers for actual correspondence between the promise and behavior: "Yesterday you said you would ... and you did! That's very good! You get to draw from the surprise bag today." Or "Yesterday you said you would ..., but you didn't. That means that you can't pick a surprise today."

The results showed that the second condition involving reinforcement of correspondence immediately changed target behaviors. The delay of reinforcement was successful without the correspondence training only when followed by the successful application of correspondence training to two prior targeted behaviors. Thus it was first necessary to establish a history of correspondence.

Correspondence training may be used for generalization and maintenance of responses. According to Patricia Osnes and Trevor Stokes, correspondence training may help with generalization to facilitate entry into natural communities of reinforcement by increasing the likelihood of reinforcement and positive attention from adults and peers. Through correspondence training children achieve a successful history between verbalizations and actions: what they say they will do and how they actually behave.

Correspondence training has also been used to enhance dinnertime conversation for preschool children. In 1979, Jacque Jewett and Hewitt Clark described the

intervention in the following way: "If the teacher could obtain reasonably accurate information on the children's dinnertime conversation, they could reinforce their corresponding verbal behavior on a delayed basis in the preschool group setting."

The subjects were four children ages 4 and 5 described as middle class, having intelligible speech, and with at least one sibling over the age of 4. Families were paid a nominal amount for participation. The evening meal was tape-recorded and was returned each morning to the school.

Outcome measures of conversations were (1) children's statements of appreciation, (2) conversational questions, and (3) comments "to prompt or to coach the target children" (p. 591). Conversational comments included initiating a topic, continuing a topic, or restating a comment. The central features of the study were (1) taped dinnertime conversations between family members, (2) the simulated family meal held by the preschool teacher, (3) the training sessions, and (4) the feedback sessions.

The training sessions were held in the preschool classroom prior to lunchtime. Based on the teacher's judgment the sessions lasted anywhere from 1 to 10 minutes. The teacher selected topics for the conversations and on the first day of a new topic the teacher modeled examples of comments for that topic. The comments were then taught, using prompting, modeling, practice, and social reinforcement. When the child was able to verbalize the comments independently or within 30 seconds of a modeled comment, the criterion was considered to have been met. The child then had to verbalize the appropriate set of comments for the next meal. Practice was directed toward any difficulties the child had. Correct sentence structure and variation of comments were also prompted.

The teacher then held simulated family style lunches. During this time, the children and teacher role-played a dinnertime meal with the teacher acting as different members of the child's family. Within the context of the teacher's role, she provided the child with social reinforcement. During the first day of each training session the teacher gave prompts freely. Predinner practice occurred in the afternoon and was the same as the prelunch practice.

Each day, at 10:30 a.m. the teacher held a feedback session to check correspondence between what the children reported and what comments were actually made at dinner the previous night. The teacher gave a prompt and the child was asked to repeat the comments: "Did you say all of the right things at dinner?"

"Who did you ask questions to and what did you ask them?"

Further prompts and modeling of the correct responses were allowed for "eligible" children. If the teacher had to assist a child, a brief delay was given. ("Now you're saying it right, but I had to help you. I'll come back in a minute to see if you can remember all by yourself".)

Assistance was given to those children who had not met the criterion. The prompts were continued until the child met the criterion without assistance and earned the reward. The criterion was one comment to each specified family member in each planned category.

A social and snack reinforcement was provided contingent on the correspondence between verbal report and the use of the comments during the family dinner. Lunch feedback, in the afternoon, was identical, except that it focused on the simulated family meal.

Results indicated the effectiveness of the intervention for all four subjects. After the teacher discontinued the intervention, a 2-week follow-up revealed that each child's dinnertime conversation was being maintained by the natural community of reinforcement within each family through parent-child attention, family interaction, and new topics.

Correspondence training has also been used to enhance sharing in young children. Ann Rogers-Warren and Donald Baer, in 1976, developed and implemented such an intervention for use with 33 preschool children. The children were taught to share and praise one another for sharing. The teacher modeled the behaviors for the children and the children practiced sharing and praising one another. Following appropriate sharing and praising, the teacher reinforced the children.

In the first condition, children modeled the behavior and then were asked to report whether or not they engaged in sharing and praising. In this phase, both true and untrue reports of sharing and praising were reinforced. The second condition consisted of reinforcement for true reports of actual sharing and praising, following modeling. Both conditions were effective in increasing sharing behaviors and generalized to other settings. By training children in correspondence between saying and doing, the researchers effectively increased these children's prosocial behaviors.

IV. SUMMARY

Correspondence training is a type of self-regulation with demonstrated usefulness in getting individuals to

do what they say they will do. Particularly useful with young children, correspondence training allows children to achieve success between verbalizations and actions. Learning rules governed by language and then followed by reinforcement can be beneficial in altering children's behavioral trajectories.

See Also the Following Articles

Behavior Rehearsal ■ Child and Adolescent Psychotherapy: Psychoanalytic Principles ■ Objective Assessment ■ Parent-Child Interaction Therapy ■ Primary-Care Behavioral Pediatrics ■ Role-Playing ■ Self-Control Therapy ■ Self-Statement Modification ■ Therapeutic Storytelling with Children and Adolescents

FURTHER READING

- Baer, R. A., Williams, J. A., Osnes, P. G., & Stokes, T. F. (1985). Generalized verbal control and correspondence training. *Behavior Modification, 9*, 477.
- Barnett, D. W., Bell, S., & Carey, K. T. (1999). *Developing preschool interventions: A practitioner's guide*. New York: Guilford.
- Barnett, D. W., & Carey, K. T. (1992). *Designing interventions for preschool learning and behavior problems*. San Francisco: Jossey-Bass.
- Karoly, P., & Kanfer, F. H. (1982). *Self-management and behavior change: From theory to practice*. New York: Pergamon.
- Osnes, P. G., Guevremont, D. C., & Stokes, T. (1986). If I say I'll talk more, then I will: Correspondence training to increase peer-directed talk by socially withdrawn children. *Behavior Modification, 10*, 287.

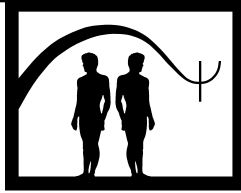

Cost Effectiveness

William H. Sledge

Yale University

Susan G. Lazar

Washington Psychoanalytic Institute

- I. Introduction
 - II. Insurance Coverage for Psychotherapy
 - III. Difficulties in Providing a Psychotherapy Medical Benefit
 - IV. Cost Effectiveness
 - V. Studies of Cost Effectiveness
 - VI. Conclusion
- Further Reading

GLOSSARY

charges A manager's efforts to recoup costs based on considerations of cost, market, and regulatory compliance—what the market will bear and not necessarily a function of the resources that must be consumed to bring about an intervention.

effectiveness The effect of an intervention in terms of bringing about desired outcomes in real-world conditions.

efficacy The ability of a treatment to bring about desired outcome under ideal conditions (i.e., homogeneous patient population, high fidelity of treatment to an ideal, delivery of defined care, etc.) that usually only pertain in highly controlled research or academic settings.

efficiency The ratio of the cost to benefits, for instance in a cost-benefit analysis, an efficiency ratio of less than one means that the intervention actually makes money.

elasticity The medical service utilization feature that is a measure of the sensitivity of the utilization of benefit to the generosity of the insurance benefit. A particular intervention or service is said to be elastic to the extent that its use is influenced by how much the patient must pay out of pocket as opposed to how much the patient wants/needs the benefit.

CEA ratio The expression of the relative costs per unit of outcome of an intervention designed to improve care in comparison to another intervention or no care.

cost-benefit analysis A method used to evaluate the outcomes and costs of interventions designed to improve health in which all the variables are expressed in economic units.

cost-effective analysis A method used to evaluate the outcomes and costs of interventions designed to improve health in comparison to one another.

cost offset The idea that expenditures in one realm (i.e., psychotherapy benefit) may be accompanied by reduction in expenditures in another (i.e., hospitalization).

opportunity costs The maximal value of a resource if the resource has some alternative use. An example might be the lost wages for the time spent in a doctor's waiting room.

parity The equalization of medical benefit coverage across illness domain categories. For instance, it has been common practice to provide more generous insurance coverage for the expenses associated with medical or physical illnesses in comparison to psychiatric or mental illnesses.

QALY (quality adjusted life years) The preferred outcome measure for societal CEAs in which disability and changes in life expectancy are components of outcome. The quality adjusted dimension refers to a weighting that is based on the premise that some people would rather be dead than live a certain way or alternatively would be ready to trade fewer years of a higher quality of life for more years at a lesser quality of life.

I. INTRODUCTION

Costs have preoccupied the purchasers of care in the last quarter century as health care costs have steadily

outpaced the inflation indices or other measures of costs. With this focus on costs has come also a deep interest in the effectiveness of health care expenditures. Managed care has been one effort to contain costs and direct resources to fund effective care.

The practice of psychotherapy has changed (many would say "suffered") greatly from the policies of managed care that have emphasized reducing costs and utilization in order to save money. This process is documented elsewhere in this Encyclopedia. The efforts to show that psychotherapy is cost-effective for a variety of conditions has been largely successful, if not exhaustive. This article reviews some of the basic ideas of cost-effectiveness generally, as well as specifically for psychotherapy, and indicates some of the questions that the future must address. Formal features of the structure of the field of psychotherapy, such as its large number of potential practitioners and its application to illnesses that are imprecise in their definition and sometimes difficult to distinguish from variants of normal behavior, have created a great deal of wariness on the part of those who manage benefits and pay the bills. Psychotherapy has posed a great challenge to public policymakers who attempt to rationalize the U.S. medical system. Psychotherapy has been denied and limited more than most medical interventions, perhaps in part as a function of the stigma associated with mental illness.

II. INSURANCE COVERAGE FOR PSYCHOTHERAPY

Even before the current era of managed mental health care benefits in which few patients are provided the psychotherapy benefits they actually need, it was common practice for insurance companies to limit coverage for psychotherapy with higher co-payments, stricter yearly limits, and lower lifetime limits than for other medical care. Parity for psychotherapy has not existed. These discriminatory practices were considered justified by insurers because of the widespread assumption that psychotherapy benefits are vulnerable to abuse by those not in need and will, therefore, unnecessarily inflate health care expenditures in a way not shared by other medical benefits. Psychotherapy benefits were said to have "elasticity" in which the use of the benefit is particularly sensitive to what the patient must pay.

The idea of parity of insurance coverage for mental health benefits (i.e., at the same level as for other medical benefits) has been hotly debated with opponents arguing that parity for mental health coverage is far too

expensive to provide. A RAND study by Sturm examined assumptions about the high price of mental health parity expressed in the policy debates surrounding the Mental Health Parity Act of 1996. This study demonstrated that while access to mental health specialty care under conditions of parity increased to 7% of enrollees (compared to 5% of enrollees found in the free care condition in the earlier RAND Health Insurance Experiment), there was a relative shift to outpatient care, reduced hospitalization rates, and reduced payments per service. Children were the main beneficiaries of the expanded availability of benefits that were estimated to cost only an additional \$1.00 per enrollee per year. The assumptions underlying concerns about the high costs of parity for mental health benefits were shown to be incorrect, based on outdated data, and dramatically overstated by a factor of 4 to 8.

III. DIFFICULTIES IN PROVIDING A PSYCHOTHERAPY MEDICAL BENEFIT

The psychotherapy coverage in health care insurance systems in the United States has a long, complex history. The clearest current inadequacy is the lack of parity with medical services for mental as well as physical illness. Physical illnesses are viewed by the public as inevitable, occurring as a person ages, or as a tragic event striking a person down in early life. Except perhaps for those illnesses caused by an individual's behavior that can be seen as self-destructive, such as the role of obesity in heart disease or poor diabetes control, patients who are stricken have the benefit of societal sympathy. Parson's explication of the sick role points to an institutionalized "forgiveness" of a patient's usual social role obligations, as well as the expectation that the patient has not been able to control the condition and will seek competent medical help.

In contrast, mental illness in a family often arouses intense shame and guilt in connection to the anticipated perception of weakness in the ill person as well as in family members. Contributing to these feelings is an ethic in the industrialized Western world that values self-sufficiency and self-control. Mental illness can readily be viewed as a failure to function in the self-contained manner expected.

The social stigma attached to people with mental illness can also spread to those who treat them. The treatment of a person with mental illness is usually highly confidential, commonly resulting in misconceptions

within the lay public about the nature of that treatment, the patients who suffer mental illness, and those who treat them. It is not unusual for patients and their therapists to be regarded with denigration.

Defining and measuring psychotherapy is an important challenge, particularly for those who would manage such care. The delivery of psychotherapy has also only recently become somewhat standardized with the development of a few relatively specific and behaviorally oriented "manualized" approaches. Psychotherapy manuals offer a way to specify indications, goals, and specific techniques of psychotherapy to give a standardized approach. For research ends, standardization has been essential to develop reliable means of evaluating psychotherapy. Furthermore, these approaches have assisted in the clinical training of psychotherapy. However, among clinicians the manualized approach has been criticized for its rigidity and that it can never truly substitute for the expertise of an experienced, dedicated clinician.

IV. COST EFFECTIVENESS

Increasingly policymakers and payers are insisting on a consideration of the economic dimensions of care before an intervention will be provided as a benefit covered by insurance or provided as part of a public sector program for un- or minimally insured patients. Cost-effectiveness (CEA) and cost-benefit analyses (CBA) have emerged as tools that allow an estimation of the cost of providing a particular form of care in relation to other interventions or no care. Cost-benefit and CEAs are similar ways to express the value of an intervention in relation to the effort to bring it about. Cost benefit analyses seek to represent all dimensions of the cost-benefit equation in monetary values whereas CEAs do not require the expression of outcomes in monetary terms. Cost effective analyses are preferred in most health service approaches because of the difficulty in expressing the outcome variables of symptoms, quality of life, and mortality experience in monetary terms. The principles of CEA for medical and mental health programs in general apply to psychotherapy efforts in particular.

A. Perspective

One major issue in the assessment of costs and effectiveness is the perspective of the study that determines the breadth of what is being examined. Different perspectives include: (a) only the resources

furnished by the provider (the "management" perspective), (b) all the explicit resource costs associated with production of the services (the "accountant" perspective), or (c) all explicit and implicit resource costs that would address opportunity costs such as those for resources that are both donated or already owned (the "economist" perspective or "societal" perspective). For example, the management perspective of costs of developing a psychotherapy service in a public sector outpatient clinic would include the number, type, and hours of the psychotherapists assigned to or hired for such a service, the amount of electricity and other utilities they consumed, the costs of their malpractice insurance, and so on. The accountant would add the cost of the management of those services, and various other overhead expenses allocated to this function indirectly but directly incurred by the institution for doing business as an institution, such as the need to provide parking for all the workers, a security force, and so on. The economist would add the "opportunity" costs of using the resources (such as real estate, equipment, personnel) differently (even if they were "donated" without direct cost to the institution), as well as other hidden costs such as the supervision of the staff that was provided free to the institution and in exchange for a faculty appointment by another institution. The societal perspective allows studies to be more easily compared and to understand more clearly the full implications of choices about what to support and not to support.

B. Dimensions of Benefit

A comprehensive cost-effective analysis must take careful account of the economic benefits of an intervention in assessing net economic costs. Just as costs have multiple dimensions, so do benefits. As Weisbrod noted in 1983, these benefits for psychiatric patients might include increased earnings of those treated, changes in labor market behavior that address the ability and willingness of the patient to seek employment, improvement in decision making about the use of expensive services, improved role functioning in terms of family and economic behavior, and improved physical and mental health. It is enormously difficult to measure these benefits economically and to express them accurately in monetary terms. Increasingly, to standardize studies allowing for comparisons and clarity of interpretation of results, one consensus outcome of CEAs is the cost-effectiveness ratio, an expression of the cost per unit of effect or the difference in the cost between the

two compared treatments divided by the difference in effectiveness of the two compared treatments. The cost-effectiveness ratio is the incremental cost of obtaining a particular effect from one intervention in comparison to another. Such a comparison also calls for a universal measure of outcome, the quality adjusted life year (QALY). This measure is the increase in life years (when that is an appropriate measure of effect), weighted for quality, brought about by the intervention.

One difficulty in establishing a broad and coherent policy addressing the support of psychotherapy has been the measurement of the various effects or outcomes of psychotherapy. For instance, it is only recently that there is a growing consensus that outcomes should include not only symptomatic relief, but also the capacity for greater social and vocational performance, utilization of nonpsychiatric as well as psychiatric health services, as well as other quality-of-life measures.

C. Dimensions of Costs

Cost is a complex idea. Cost is the value of the resources being withdrawn from society to bring about a specific intervention. Costs are to be distinguished from charges which are simply a manager's efforts to recoup costs based on considerations of cost, market, and regulatory compliance. Domains of costs that must be considered in a CEA are the following: (a) changes in the use of health care resources, (b) changes in the use of non-health resources, (c) changes in the use of informal care giver time, and (d) changes in the use of the patient time.

Health care costs include the direct costs of the intervention itself (drugs, personnel, supplies, etc.). The methodology for estimating total direct costs (of an intervention, program, etc.) is generally based on determining the unit cost of services and multiplying it by the amount of such services consumed. Different programs within an agency may use different production strategies to produce similar treatments. For instance, long-term psychotherapy provided by social workers may have a different cost structure from long-term psychotherapy provided by psychiatrists.

Another issue concerning the measurement of unit costs concerns the precise definition of the service unit. Service units can be defined as outputs that measure the services received by clients or as input or production inputs that measure the number of hours of staff effort. For example, if a therapist sees five patients during an hour-long group session, the group session can be counted as five client visits and five group hours in terms of output or as one group hour from the perspective of input.

An important concept and a consideration of the cost and benefit of any delivered medical service is the impact on other medical service-seeking behaviors. For instance, it has been shown in some instances that the provision of consultation or psychiatric services reduces the length of stay of hospitalized patients, particularly those suffering from orthopedic injuries. In this case, the difference between the cost of care with and without the second procedure, in this case psychotherapy, is called the "cost offset factor," in which the provision of a relatively inexpensive treatment can substantially influence the utilization of an expensive (usually inpatient) treatment by patients with various illnesses.

Non-health care resources used in the production of an intervention must also be considered. When an agency produces many different services, there are costs not directly attributable to the service in question but which are necessary to the agency's capacity to provide service. These include explicit as well as implicit, off-budget agency costs such as, for example, the time and effort of management to lobby the legislature for increased mental health services.

Furthermore, there are multiple types of costs in addition to production costs. In mental health studies it is customary to address maintenance costs for food, shelter, and other necessities for patients involved because some of the interventions (inpatient settings, some partial hospital programs) provide these services. Law enforcement costs are another type of cost that are relevant in considering the possible cost shifting when the criminal justice system is used as a de facto substitute for the psychiatric treatment system. Other well-known costs are the considerable cost shifting between psychiatric and other health care costs.

The time of the informal care giver(s) must also be considered. The concept of "family burden" addresses the resources consumed by a patient's family to provide care. If a particular service achieves cost reduction by shifting the burden to family members, then this service may end up not being cost-effective from a societal view, but very cost-effective from a provider's view.

The time the patient spends in seeking and receiving treatment is a cost that must also be considered. It should be included in the numerator if it is conceptualized as an opportunity cost and expressed in monetary terms. It can be included in the denominator of the cost-effectiveness ratio if it is conceptualized and measured as a dimension of QALY. If the experience of the treatment is included as part of the effect of care, then it will be difficult to monetize the dimension of time, and it probably should be considered a dimension of QALY.

Another class of costs that can be considered either in the cost numerator or the effectiveness denominator is a class of costs sometimes referred to as indirect costs or productivity costs.

V. STUDIES OF COST EFFECTIVENESS

There have been many studies of the cost-effectiveness for specific disorders or illnesses. A few selected topics are addressed here. These are anxiety disorders, affective disorders, physical illnesses, borderline personality disorder, substance abuse, schizophrenia, and general considerations.

A. Anxiety Disorders

Anxiety disorders are the most common mental health problems and the most expensive, costing 31% of all mental health costs (both direct and indirect) and totaling over \$46.6 billion in 1990. Salvador-Carulla and colleagues measured cost offset in panic disorder that is treated by psychotropic medication and supportive psychotherapy. Patients followed for 1 year experienced a reduction in use of medical treatments in the year following treatment, compared to the year prior, but had an increase in direct costs because of the expense of psychiatric visits and medication. Nonetheless, the indirect costs from sick days decreased by 79%, leading overall to a 30% reduction in total costs for those patients with the treatments.

B. Affective Disorders

Affective disorders are a common illness with 11% of the adult population in the United States suffering each year with an affective disorder. Of these patients, one half have major depression, one third dysthymia, and one sixth bipolar disorder. One fifth of Americans will have an affective illness during their lifetime. Greenberg and colleagues estimated the cost of depression in the United States in 1990, including both the direct costs of medical treatment and the indirect costs from mortality and reduced productivity, at 43 billion dollars. Several investigators have documented the greater disability and medical costs from depression than for other common medical conditions and other mental health disorders. In addition, depressed patients seek general medical care and have higher general medical costs than non-depressed patients.

There are a handful of studies that document directly the cost impact and cost savings of psychotherapy for depressed patients. For patients with major depression, several studies demonstrate cost-effectiveness, particularly when psychotherapy contributes to reduced hospital duration and hospital costs or to decreased costs of successful treatment compared to more usual care. Psychotherapy also leads to decreased costs from reduction in length of hospital stay for depressed medical inpatients. Depression is an extremely costly illness in lost productivity, in pain and suffering, in increased general medical costs, and in loss of life through suicide. If all societal costs are considered, any psychotherapy that has been demonstrated to be effective can almost presumptively be considered cost-effective. In addition, a small number of studies demonstrate directly the cost-effectiveness of a variety of psychotherapeutic approaches for this enormous public health problem.

C. Physical Disorders

Concomitant mental illness complicates medical illness and emotional reactions short of mental illness can profoundly affect the course of physical conditions. Psychotherapeutic interventions have been shown to be profoundly helpful in decreasing pain and suffering in a host of medical conditions and in some they can lead to improved physical health and cost savings in medical care.

A number of studies document the fact that depressed, anxious, and emotionally distressed medical patients utilize more medical services and have more medical expenses and longer hospital stays. Furthermore, patients who are medically ill with psychiatric illness do not respond as well to medical treatment if their psychiatric illness is left untreated. Druss and colleagues have demonstrated that the cost of medical care for depressed patients is higher than for those without mental illness. Rosenheck and colleagues have shown that if the depression is not treated, the medical costs may be increased along with the disability days.

Other results of investigations concerning physical illnesses have included the finding that psychotherapy for families of patients with Alzheimer's disease lowers the health care costs of these patients; that psychiatric consultation lowers health care costs for patients with somatization disorder, and that group therapy in addition further lowers medical costs for these patients. Linden and colleagues undertook a meta-analysis of psychological therapies for patients with heart disease and found significant clinical improvement and improved survival

for those treated with the addition of a psychological approach. Johannesson and colleagues found clinical improvement of coronary artery disease in cardiac patients for programs with multifaceted interventions that include psychotherapy and demonstrated cost-effectiveness in terms of life years gained. Psychotherapeutic services for orthopedic patients have been documented to be cost-effective in the care of some orthopedic patients as well as pain patients by reducing the utilization of other medical services.

While a number of studies of psychotherapy for cancer patients illustrates its beneficial effects in improving adjustment and ameliorating emotional distress, three groups in particular document improved survival when psychotherapy is added to the treatment plan. These cancers are as follows: breast cancer, malignant melanoma, and leukemia and lymphoma.

D. Borderline Personality Disorder

Borderline Personality Disorder is a psychiatric diagnosis that carries a high degree of disease burden in morbidity, mortality, as well as general medical, psychiatric and social costs. Borderline patients have a high rate of suicide attempts and use of emergency medical services. Borderline personality disorder is a potentially devastating mental illness with high costs in pain, suffering, disability, suicide attempts, completed suicides, and high medical, hospital and psychiatric costs. Several different approaches to psychotherapy have proven to be highly cost effective for this disorder by demonstrating that effective care substantially reduces the need for hospital level care. The work of Linehan is the closest to a cost effectiveness study in demonstrating this point.

E. Substance Abuse

Substance abuse is also an enormously expensive public health problem. Tobacco use is associated with 400,000 deaths per year. The costs of alcohol abuse to society have been estimated conservatively to be 99 billion dollars. Patients who abuse alcohol have higher rates of absenteeism, lowered productivity, and disability.

Psychotherapy is a potentially useful and cost-effective treatment for all substance abusers. It more than doubles the number of smokers who quit. Hester and colleagues performed an extensive review of treatments for alcohol abuse and found that brief interventions, social skills training, motivational enhancement, and a community reinforcement approach are all effective. Fals-Stewart found that behavioral couples therapy

provides a highly cost-effective treatment for substance abusers living with a partner, compared to individual treatment. Although both approaches provided cost savings in the social costs of substance abuse, the couples approach was three times as cost savings.

F. Schizophrenia

Schizophrenia is another costly illness for which psychotherapy can be cost-effective. The cost of schizophrenia in the United States in 1991 was 65 billion dollars, including treatment costs (19 billion dollars) and productivity lost due to illness (46 billion dollars). Psychotherapy, especially family therapy, given in combination with medication, has been shown to be cost-effective in the treatment of schizophrenia by decreasing the rate of relapse and the number of days spent in the hospital. Family therapy has been shown to be most effective for the families of patients with schizophrenia who are characterized as showing high "expressed emotion," meaning that there is a tendency for family members to express critical and overinvolved attitudes toward the schizophrenic patient and his or her illness. A number of studies have demonstrated the superiority and cost-effectiveness of family therapy compared to other treatments for schizophrenia.

Lieberman and colleagues as well as others have documented that a form of psychotherapy, social skills training, is also effective in schizophrenia. Patients treated with social skill training show improved social functioning, lowered relapse rates, and decreased time in the hospital compared to controls given other treatments, demonstrating a cost savings effect.

G. General Studies

There are also a number of general studies that have shed light on the question of cost-effectiveness of psychotherapy. Gabbard and colleagues carried out a survey of the literature on the economic impact of psychotherapy published between 1984 and 1994. This review of 18 studies, 10 with random assignment and 8 without random assignment, found that 80% of the former and 100% of the latter suggested that psychotherapy reduces total costs. This review found that psychotherapy appears to be cost-effective, especially for patients with severe disorders, including schizophrenia, bipolar affective disorder, and borderline personality disorder.

One study demonstrating substantial cost offset is a Bell South pilot project from 1991 to 1993 by Saeman, which hints at the complex relationship between medical

services utilization and costs and psychiatric services utilization and costs. Three thousand Bell South workers and their families were given psychiatric benefits including two psychotherapy visits per week or a total of 52 visits a year, a lowered co-payment for psychotherapy visits, partial psychiatric hospitalization services, and an employee assistance program (EAP). There were significant subsequent decreases in psychiatric inpatient stays (by 30%) as well as in both outpatient and inpatient medical and surgical services (by 78% and 87%, respectively). Total health care expenses per company member declined from \$17 to \$8 per month even though outpatient psychiatric services increased by 33% and partial psychiatric hospitalization increased by 45%.

Two other studies demonstrate cost-effectiveness by virtue of a reduction in lost workdays. Klarreich and colleagues found that providing rational-emotive psychotherapy through an EAP of one large company led to a decrease in absenteeism from 10 to 3 days per year per employee equal to a decrease of \$1,054 in the annual cost of absenteeism per employee. For each dollar spent on psychotherapy, the corporation saved \$2.74. In a British study by Mynors-Wallis and colleagues randomly assigned 70 primary care patients with concomitant psychiatric illness to a problem-solving therapy by a trained nurse. The outcome compared with the usual treatment delivered by a general practitioner. There was no difference in clinical outcome as measured by four structured clinical assessment measures. However, the patients who received the psychotherapy had fewer subsequent lost workdays that more than offset the cost of providing the therapy.

VI. CONCLUSION

Although there are too few large-scale studies addressing the cost-effectiveness of psychotherapy for specific diagnostic groups of patients, we can arrive at some important impressions from the studies that we do have. Those that exist do confirm that, for many conditions psychotherapy works, is cost-effective, can often provide a significant cost offset in other medical and hospital expenses, and is not overused or "abused" by those not truly in need. However, there is much work to be done to add explicit detail to these findings.

See Also the Following Articles

Alternatives to Psychotherapy ■ Economic and Policy Issues ■ Efficacy ■ Outcome Measures ■ Relapse Prevention ■ Termination

Further Reading

- Druss, B., Rosenheck, R., & Sledge, W. (2000). Health and disability costs of depressive illness in a major U.S. corporation. *American Journal of Psychiatry*, *157*, 1274–1278.
- Fals-Stewart, W., O'Farrell, T. J., & Birchler, G. R. (1997). Behavioral couples therapy for male substance-abusing patients: a cost outcomes analysis. *Journal of Consulting and Clinical Psychology*, *65*(5), 789–802.
- Fawzy, F., Fawzy, N., Hyun, C., Elashoff, R., Guthrie, D., Fahey, J., & Morton, D. (1993). Malignant melanoma: effects of an early structured psychiatric intervention, coping, and affective state on recurrence and survival six years later. *Archives of General Psychiatry*, *50*(9), 681–689.
- Gabbard, G., Lazar, S., Hornberger, J., & Spiegel, D. (1997). The economic impact of psychotherapy: A review. *American Journal of Psychiatry*, *154*(2), 147–155.
- Gold, M. R., Siegel, J. E., Russell, L. B., & Weinstein, M. C. (1996). *Cost-effectiveness in health and medicine*. New York: Oxford University Press.
- Greenberg, P., Stiglin, L., Finkelstein, S., & Berndt, E. (1993). The economic burden of depression in 1990. *Journal of Clinical Psychiatry*, *54*(11), 405–418.
- Johannesson, M., Agewall, S., Hartford, M., Hedner, T., & Fagerberg, B. (1995). The cost-effectiveness of a cardiovascular multiple-risk-factor intervention programme in treated hypertensive men. *Journal of Internal Medicine*, *237*, 19–26.
- Klarreich, S., DiGuseppe, R., & DiMattia, D. (1987). Cost-effectiveness of an employee assistance program with rational-emotive therapy. *Professional Psychotherapy Research Practice*, *18*, 140–144.
- Lazar, S. G., & Gabbard, G. O. (1997). The cost-effectiveness of psychotherapy. *Journal of Psychotherapy Practice and Research*, *6*(4), 307–314.
- Lieberman, R. P., Mueser, K. T., & Wallace, C. J. (1986). Social skills training for schizophrenic individuals at risk for relapse. *American Journal of Psychiatry*, *143*, 523–526.
- Linden, W., Stossel, C., & Maurice, J. (1996). Psychosocial interventions for patients with coronary artery disease: a meta-analysis. *Archives of Internal Medicine*, *157*(11), 1268–1269.
- Linehan, M., Heard, H., & Armstrong, H. (1993). Naturalistic follow-up of a behavioral treatment for chronically parasuicidal borderline patients. *Archives of General Psychiatry*, *50*, 971–974.
- Miller, W. R., Brown, J. M., Simpson, T. L., Handmaker, N. S., Bien, T. H., Luckie, L. F., Montgomery, H. A., Hester, R. K., & Tonigan, J. S. (1995). What works? A methodological analysis of the alcohol treatment outcome literature. In R. K. Hester & W. R. Miller (Eds.), *Handbook of alcoholism treatment approaches: effective alternatives* (2nd ed., pp. 12–44). Needham Heights, MA: Allyn & Bacon.
- Mynors-Wallis, L., Davies, I., Gray, A., Barbour, F., & Gath, D. (1997). A randomised controlled trial and cost analysis of problem-solving treatment for emotional disorders given

- by community nurses in primary care. *British Journal of Psychiatry*, 170, 113–119.
- Parsons, T. (1951). Social structure and dynamic process: The case of modern medical practice. In T. Parsons (Ed.), *The Social System* (pp. 428–479.) New York: Free Press.
- Rosenheck, R. A., Druss, B., Stolar, M., Leslie, D., & Sledge, W. (1999). Effect of declining mental health service use on employees of a large corporation. *Health Affairs*, 18, 193–203.
- Saeman, H. (1994). Integrated care model works, says Bell South. *National Psychologist*, 3(4), 12–13.
- Salvador-Carulla, L., Segui, J., Fernandez-Cano, P., & Canet, J. (1995). Costs and offset effect in panic disorders. *British Journal of Psychiatry Supplemental*, 27, 23–28.
- Spiegel, D. (1999). Psychotherapy for cancer patients. In D. Spiegel (Ed.), *Efficacy and cost-effectiveness of Psychotherapy* (pp. 159–183). Washington, DC: American Psychiatric Press.
- Sturm, R. (1997). How expensive is unlimited mental health care coverage under managed care? *Journal of the American Medical Association*, 278(18), 1533–1537.
- Weisbrod, B. A. (1983). A guide to benefit-cost analysis, as seen through a controlled experiment in treating the mentally ill. *Journal of Health, Politics and Law*, 7, 808–845.
- Wolff, N., Helminiak, T. W., & Tebes, J. K. (1997). Getting the cost right in cost-effective analyses. *American Journal of Psychiatry*, 154, 736–743.

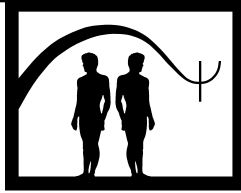

Countertransference

William H. Sledge

Yale University

- I. Definition
 - II. History
 - III. Types of Countertransference
 - IV. Technical Implications
 - V. Conclusion
- Further Reading

terial that has been extruded from the projecting person. The target of the projection may or may not become unconsciously responsive to this process and may or may not actually experience elements of it and act accordingly.

transference The emotional reactions of the patient toward the therapist, in which thoughts or feelings related to an early stage of development are “transferred” from the objects (usually parents) of that earlier period to the therapist.

GLOSSARY

countertransference Broadly speaking, any emotional reaction of the therapist toward the patient. There are two definitional traditions: classical and totalistic.

1. The classical definition defines countertransference as the emotional “transference” reactions that the therapist has toward the patient.
2. Totalistic countertransference refers to all the therapist’s emotional reactions toward a patient, which are composed of (a) the therapist’s irrational transference feelings toward the patient, (b) the “realistic” emotional reactions of the therapist toward the patient, and (c) the emotional psychological reactions of the therapist toward the patient that are in response to the patient’s transference reactions toward the therapist.

parallel process Refers to the replication in the relationship between the supervisor and the supervisee of some of the dynamic transference and countertransference elements in the relationship between the patient and the supervisee.

projective identification The process whereby primarily unconscious fantasy is “projected” or imagined to exist in another person with the result that the person projected into will return in some modified version the psychological ma-

I. DEFINITION

Countertransference is a complex concept. Basically, the broad conceptualization is intended to include all the psychological and emotional reactions of the therapist toward the patient. More recently, it has come to signify not only the irrational or transference reactions of the therapist toward the patient, but also the therapist’s emotional reactions to the transference of the patient. Finally, some authors define an aspect of countertransference as the “objective” elements of the therapist’s reaction toward the patient. This includes the idea that the therapist is responding to the realistic dimensions of the qualities of the patient.

II. HISTORY

Freud had coined the term countertransference (*gegenübertragung*) and referenced it only on several occasions during his writing, and never treated it

systematically. Freud seemed to conceptualize countertransference as the analyst's transference toward the patient. Consequently, for Freud the notion of countertransference was a part of therapy that needed to be managed and "kept in check."

Several early analysts conceptualized the relationship between analyst and patient differently from Freud and were interested in modifying the strict rule of neutrality and abstinence. Ferenczi was clearly in this school, as was Michael Balint. Helene Deutsch was among the first to emphasize a different dimension of countertransference, in which she put forward the "complementary attitude" of the identification with the transference objects. She indicated that although these reactions could be an interference with therapy, they also could be a constructive influence and could serve as the underlying elements of empathic responsiveness.

These ideas of the possible usefulness of the countertransference were developed more systematically by Racker and Little, both of whom, coming from an object-relations perspective, developed the idea of the usefulness of countertransference in elucidating the unconscious mental life of the patient. By the time that Racker was writing, the notion of projective identification had been established through the Kleinian approaches.

As the concept of countertransference broadened, and included realistic and predictable dimensions of the analyst's response to the patient and dimensions of the analyst's own conflicts, there grew, along with the admonishment of the dangers of countertransference, the increasing belief that countertransference reactions on the therapist's part could provide important and valuable information about the patient.

With the effort to apply psychoanalytic principles to the treatment of people with severe psychotic disorders, the role of the therapist's response became increasingly more important as a therapeutic tool in the treatment of such patients. Harold Searles was instrumental in developing the idea of the centrality of the therapist's emotional reactions to the patient for a genuine therapeutic process. His work was based on that of many who had gone before, including Freida Fromm-Reichmann, Margaret Little, Phyllis B. Cohen, and Sandor Ferenczi, as well as Harry Stack Sullivan.

III. TYPES OF COUNTERTRANSFERENCE

Countertransference types can be conceptualized on the basis of the content (love, hate, turning away) as a

function of the psychopathology of the patient (psychotic, depressive, borderline, etc), as elements in the analyst's life (the sick, pregnant, or recently traumatized analyst), and specific content as a function of a stage of therapy (beginning, termination, etc.). Enumerating all these possible countertransference reactions is, of course, beyond the scope of this article. However, an account of problematic countertransferences might prove useful.

Victor Altshul and I identified three kinds of problematic countertransferences. These are the turning away countertransference, activated countertransference, and unconscious enactment. Each poses a different kind of problem.

The turning away countertransference includes those kinds of reactions that represent some kind of reduction in interest or investment in the patient. Such states as boredom, apathy, sleepiness, repugnance and forgetfulness are all the manifestations of such a reaction. They all share the property of an inability to feel engaged by the patient. There are, of course, many reasons why the therapist may experience a "turning away" reaction. Such a difficulty in engaging the patient might be due to a psychological effort on the part of the patient to make him- or herself uninteresting or unattractive, and this kind of psychological effort, albeit unconscious, might also reflect a hostile set of motivations toward the analyst.

Whatever the motivations for the genesis of a turning away reaction, it is important for the therapist to recognize that he or she is having such a reaction and to relate it to what is going on with the therapist and the therapy. One of the most important steps in this process is the accurate diagnosis of the emotional responsiveness of the therapist to the patient.

Another form of countertransference that we identified is the activated countertransference. In this instance, empathy is hampered by an intensely positive or negative feeling toward the patient. Positive countertransference might be characterized by intense liking/loving of the patient, desire to be with the patient, and the idealization of the patient's efforts in psychotherapy. Erotic countertransference is a common manifestation, as is an intense maternal countertransference. An intensely negative countertransference is also a form of activated countertransference. Intense hatred or strong negative feelings allude to a special importance in the therapist's mental life filled by the patient.

Activated countertransference carries the burden and seduction of a compulsion to take action. Intense admiration, idealization, erotic feelings, and rescue fantasies for the patient seem so compelling that the impulse to

action is irresistible for some. These reactions become problematic when the therapist loses his or her sense of control of the therapeutic relationship and begins to feel that he or she is there for a different reason, such as to rectify a wrong in the patient's life or to provide comfort when insight is more appropriate.

Another form of problematic countertransference are unconscious enactments. These problematic reactions entail the acting out of a technical failure without the experience of a conscious reaction in the form of a judgment of the failure. For example, as we noted in our previous work, one of us worked with a therapist who forgot the second appointment with the new patient. Initially, he was at a loss to understand why and did not feel particularly troubled or uncomfortable. As the therapy progressed, it became clear that the patient had been severely neglected by parental figures in her past, frequently acting as if the patient did not exist. It soon became clear that the patient had succeeded in evoking in the therapist the feeling of rage and reproach that had to be dealt with by the forgetting enactment.

IV. TECHNICAL IMPLICATIONS

By far the major challenge is for the therapist to be prepared educationally and personally to be aware of and capable of examination of such feelings toward the patient. The therapist must seek to understand the realistic elements of his or her own transference reactions and his or her response to the projective identification processes entailed in the patient's own transference.

Recognizing the problem is a major step in solving it. The key that there is a problem is the presence of any strong feeling about the patient, whether positive or negative. Other clues are attitudes that are unusual for the therapist, slips, momentary forgetting, and other parapraxia may also allude to the fact that there is an unconscious and unacknowledged process between the patient and the therapist that needs to be examined.

It is important for the therapist to be able to recognize his or her own unmet needs that are aroused by the therapy and to identify clearly the patient's contribution to his or her countertransference. There has been a substantial debate in psychotherapeutic circles as to whether elements of countertransference should be disclosed to patients. There are rare occasions when it is useful for there to be substantial disclosure of countertransference feelings toward the patient. Such disclosure is more likely to be burdensome, intensive, and confusing to most patients than it is to be therapeutic. There may be occasions in which it is sensible

for a limited disclosure, but for the most part, disclosure of the therapist's emotional reactions to the patient becomes a burden, particularly early on in the therapy. The therapist should stay away from tactless, intrusive confessions to the patient. However, when the therapist enacts an error and obvious lapse in technique, then it is sensible to acknowledge the lapse and explore this with the patient.

One specialized aspect in which countertransference can play out is in the supervisory process. Sometimes, through the mechanism of unconscious communication and projective identification, the therapist and the supervisor can unwittingly begin to enact by replicating dimensions of the transference-countertransference relationship between the patient and the therapist. This can lead to the therapist coming to act more like the patient in relationship to the supervisor. Again, these kinds of enactments and processes can be used to great benefit to help clarify the kinds of emotional and unconscious themes in the relationship between the patient and the therapist. This process is referred to as a parallel process.

V. CONCLUSION

Countertransference, like resistance, is a concept describing a phenomenon that in the early days of psychoanalysis was viewed as a problematic component of the work. However, the term countertransference has come to be redefined so that it is viewed as an inevitable aspect of the work with patients in an intensive psychotherapeutic manner. Furthermore, this new use of countertransference can be a rich source of information of what is going on within the patient.

See Also the Following Articles

Alderian Psychotherapy ■ Confrontation ■ Psychoanalytic Psychotherapy and Psychoanalysis, Overview ■ Resistance ■ Sullivan's Interpersonal Psychotherapy ■ Transference ■ Transference Neurosis ■ Unconscious, The

Further Reading

- Abend, S. M. (1986). Countertransference, empathy, and the analytic ideal: the impact of life stresses on analytic capability. *Psychoanalysis Quarterly*, 55, 563–575.
- Gorkin, M. (1987). *The uses of countertransference*. Northvale, NJ: Jason Aronson.
- Heimann, P. (1950). On countertransference. *International Journal of Psychoanalysis*, 31, 81–84.

- Jacobs, T. J. (1986). On countertransference enactments. *Journal of American Psychoanalytic Association*, 34, 289–307.
- Kernberg, O. (1976). Transference and countertransference in the treatment of borderline patients. In O. Kernberg (Ed.), *Objects relations theory and clinical psychoanalysis* (pp. 161–184). New York: Jason Aronson.
- Levy, S. T. (1977). Countertransference aspects of pharmacotherapy in the treatment of schizophrenia. *International Journal of Psychoanalytic Psychotherapy*, 6, 15–30.
- Loewald, H. W. (1986). Transference-countertransference. *Journal of American Psychoanalytic Association*, 34, 275–287.
- Racker, H. (1953). The countertransference neurosis. *International Journal of Psychoanalysis*, 34, 313–324.
- Searles, H. (1965). Oedipal love in the countertransference. In H. Searles (Ed.), *Collected papers on schizophrenia and related subjects* (pp. 284–303). New York: International Universities Press.

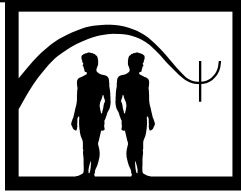

Couples Therapy: Insight-Oriented

Douglas K. Snyder

Texas A&M University

- I. Description of Treatment
 - II. Theoretical Bases
 - III. Empirical Studies
 - IV. Summary
- Further Reading

GLOSSARY

insight-oriented couples therapy A therapy that emphasizes the interpretation of recurrent maladaptive patterns from a developmental perspective.

Insight-oriented couples therapy emphasizes the interpretation of recurrent maladaptive relationship patterns from a developmental perspective. This article describes the sequence of interventions comprising insight-oriented couples therapy, theoretical explications of the presumed processes by which partners gain a new understanding of dysfunctional relationship themes and modify maladaptive interpersonal exchanges, and empirical findings regarding this treatment approach.

I. DESCRIPTION OF TREATMENT

Insight-oriented approaches to couples therapy emphasize recurrent maladaptive relationship patterns that develop from early interpersonal experiences either in

the family of origin or within other significant emotional relationships. These approaches vary in the extent to which they emphasize the unconscious nature of these relational patterns, the developmental period during which these maladaptive patterns are acquired, and the extent to which interpersonal anxieties derive from frustration of innate drives. However, a shared focus of insight-oriented strategies are previous relationship injuries resulting in sustained interpersonal vulnerabilities and related defensive strategies interfering with emotional intimacy, many of which operate beyond partners' conscious awareness. Consequently, insight-oriented approaches to couples therapy emphasize that partners' maladaptive relationship patterns are likely to continue until they are understood in a developmental context. This exploration and new understanding serve to reduce the couple's attendant anxiety in current relationships and permit them to develop alternative, healthier relationship patterns.

The general sequence of intervention components comprising insight-oriented couples therapy is presented in Table 1. Understanding of maladaptive relationship patterns begins with identifying exaggerated emotional responses to current situations—for example, intense hurt or anger in response to modest disapproval from one's partner. Both partners are encouraged to explore early relationship experiences that evoked similar feelings and to consider how these emotional responses may have originally developed as protective coping strategies or as tactics for satisfying interpersonal needs.

TABLE 1
Sequential Components of Insight-Oriented
Couples Therapy

-
1. Identifying exaggerated emotional responses to current situations.
 2. Framing these responses as acquired affective dispositions in a developmental context.
 3. Identifying affective coping strategies that interfere with higher relationship values.
 4. Promoting resolution of these developmental conflicts through interpretive and related cathartic techniques.
 5. Promoting alternative coping strategies that enhance relationship intimacy.
-

An essential prerequisite to interpretation of relational themes is a thorough knowledge of each partner's relational history. Critical information includes not only the pattern of relationships within the family of origin, but also relational themes in the family extending to prior generations. Beyond the family, intimate relationships with significant others of both genders provide insight regarding prior struggles with such issues as perceived acceptance and valuation by others, trust and disappointment, stability and resilience of relationships to interpersonal injury, levels of attachment and respect for autonomy, and similar relational themes.

Initially, previous relationships are explored without explicit linkage to current relational difficulties, in order to reduce anxiety and resistance during this exploration phase. Both partners are encouraged to remain "intently curious" about their own relational history but to refrain from premature interpretations that may be either incorrect, incomplete, or excessively self-critical. Just as important is for the individual's partner to adopt an accepting, empathic tone during the other's developmental exploration, encouraging self-disclosure in a supportive but noninterpretive manner.

Gradually, as the couple continues to explore tensions and unsatisfying patterns in their own relationship, both partners can be encouraged to examine ways in which exaggerated emotional responses to current situations have at least partial basis in affective dispositions and related coping styles acquired in the developmental context. Developing a shared formulation of core relationship themes is a critical antecedent to subsequent linkage of these themes to current relationship exchanges. Both individuals can be helped to understand that, whereas certain relational coping

strategies may have been adaptive or even essential in previous relationships, the same interpersonal strategies interfere with emotional intimacy and satisfaction in the present relationship.

In insight-oriented couples therapy, the therapist's direct access to exchanges between partners affords a unique opportunity for linking enduring relationship themes to current relationship events. Rather than interpreting exaggerated responses that distort exchanges between either partner and the therapist, the focus is on partners' own exchanges in the immediate moment. Interpretations emphasize linkage of each partner's exaggerated affect and maladaptive responses to his or her own relationship history, emphasizing the repetition of relationship patterns and their maintaining factors in the present context. In linking the couple's current struggles to enduring relationship patterns the therapist encourages attention to the following: How does the immediate conflict between partners relate to core relationship themes explored earlier in the therapy? What are each person's feelings toward the other and their desired response? What impact do they wish to have on the other in this moment? How do their perceptions regarding their partner's inner experience relate to their attitudes toward themselves? What fantasies do they have regarding their partner's possible responses? What kinds of responses from their partner would they anticipate being helpful in modifying their core beliefs about their partner, themselves, and this relationship?

In insight-oriented couples therapy, cognitive linkage of relational themes from early development to the current context is frequently insufficient for reconstructing or modifying these interpersonal patterns. The affective component of interpretation is seen in the reconstruction of these critical emotional experiences in the immediate context; new understanding by both partners often promotes more empathic responses toward both themselves and the other, facilitating more satisfactory resolutions to conflict. Often the individuals must be encouraged to work through previous relationship injuries, grieving losses and unmet needs, expressing ambivalence or anger toward previous critical others in the safety of the conjoint therapy, and acquiring increased differentiation of prior relationships from the present one.

Partners' insight into enduring maladaptive relationship themes makes possible but does not inevitably lead to changes in their own relationship. In addition to interpretive strategies, insight-oriented couples therapy promotes interactions that counteract early maladaptive schemas. Thus, the couple therapist

allows partners' maladaptive patterns to be enacted within limits, but then assists both partners in examining exaggerated affective components of their present exchange. Partners' exaggerated responses are framed as acquired coping strategies that interfere with higher relationship values such as intimacy, trust, altruism, and compassion. Interpretations of the developmental context underlying the current unsatisfactory exchange help both partners to depersonalize the noxious effects of the other's behavior, to feel less wounded, and consequently to be less reactive in a reciprocally negative manner.

Both individuals are encouraged to be less anxious and less condemning of both their own and their partner's affect, and are helped to explore and then express their own affect in less aggressive or antagonistic fashion. Throughout this process, each individual plays a critical therapeutic role by learning to offer a secure context in facilitating their partner's affective self-disclosures in a softened, more vulnerable manner. The couple therapist models empathic understanding for both partners and encourages new patterns of responding that enhance relationship intimacy. That is, by facilitating the nonoccurrence of expected traumatic experiences in the couple's relationship, both individuals are able to challenge assumptions and expectations comprising underlying maladaptive schemas. Thus, therapeutic change results from the experiential learning in which both partners encounter relationship outcomes different from those expected or feared. In response, partners' interactions become more adaptive and flexible in matching the objective reality of current conflicts and realizing opportunities for satisfying more of each other's needs.

II. THEORETICAL BASES

Couple interventions emphasizing the interpretation of maladaptive relationship themes derive from diverse theoretical approaches that can be placed on a continuum from traditional psychoanalytic techniques rooted primarily in object relations theory to schema-based interventions derived from more traditional cognitive theory (see Figure 1).

In its most orthodox formulation, insight-oriented couples therapy derives from object relations theory and its central tenet that the primary drive in infants is to secure attachment to the mother. From interactions primarily with the mother, infants develop internalized images of the self, images of significant others, and sets of trans-

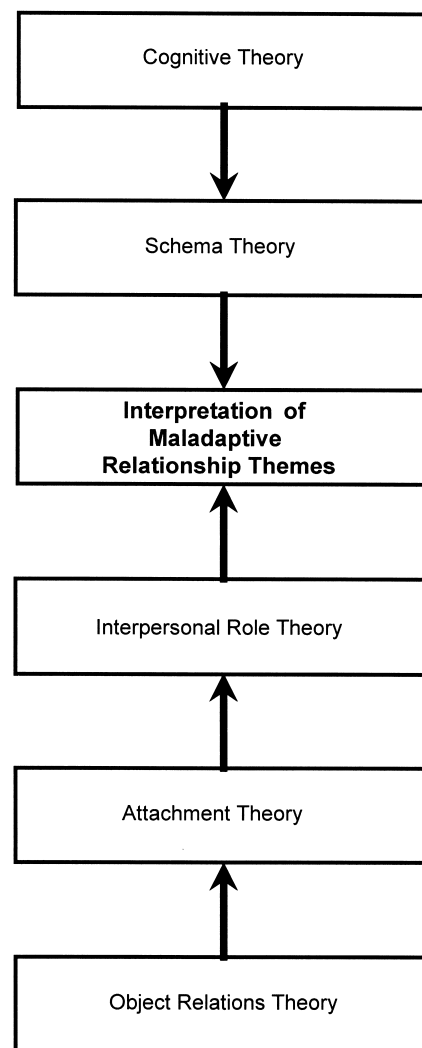

FIGURE 1 Theoretical approaches emphasizing affective and developmental components of couples' distress.

actions connecting these images or objects. From an object relations perspective, maladaptive relationship patterns of adults reflect enduring pathogenic introjects that give rise to inevitable frustration when these are projected onto relationships with significant others. In a distressed marriage, partners' pathogenic introjects interact in an unconscious, complementary manner resulting in repeated disappointments culminating in persistent conflict. Consequently, the goal of psychoanalytically oriented couples therapy is helping partners to modify each other's projections, to distinguish these from objective aspects of their own self, and to assume ownership of their own projections.

Evolving from object relations theory, attachment theory emphasizes the importance of emotional closeness to others as an innate survival function from which infants develop information-processing capabilities and emotional responses intended to foster secure emotional bonds. From an attachment perspective, difficulties in intimate adult relationships may be viewed as stemming from underlying insecure or anxious models of attachment. Partners' dominant emotional experiences drive reciprocal feedback loops maintaining such behaviors as excessive clinging or avoidance. Susan Johnson and Leslie Greenberg developed "emotionally focused couples therapy" (EFT) from an attachment theory perspective.

Interpersonal role theory regards the persistence of maladaptive interpersonal patterns as resulting from their reinforcement by the responses of significant others. Rather than stressing constructs of projective and introjective identification, interpersonal theory emphasizes the unconscious assignment of specific roles to oneself and others in which feared relational events are elicited and enacted by the individual in his or her interactions with others.

Schema theory emphasizes relationship schemas extending beyond attachment to the mother (object relations theory) or significant others (attachment theory) to consider more generally how early relationship experiences influence adult intimate relationships. Although schema theory is linked more closely to traditional cognitive theory than to psychodynamic theory, schema-based approaches to couples therapy overlap considerably with more traditional insight-oriented strategies in their emphasis on interpretation of interpersonal exchanges within the therapy session as a vehicle for change, attention to affect during the processing of schema-related events, and their emphasis on the childhood origins of maladaptive schemas and the emotional reworking of these early experiences.

Drawing on earlier psychodynamic formulations, Douglas Snyder and colleagues described an insight-oriented approach to couples therapy emphasizing affective reconstruction of previous relationship injuries. In affective reconstruction, developmental origins of interpersonal themes and their manifestation in a couple's relationship are explored using techniques roughly akin to traditional interpretive strategies promoting insight, but emphasizing interpersonal schemas and relationship dispositions rather than instinctual impulses or drive derivatives. Previous relationships, their affective components, and strategies for emotional gratification and anxiety containment are reconstructed with a focus on

identifying for each partner consistencies in their interpersonal conflicts and coping styles across relationships. In addition, ways in which previous coping strategies vital to prior relationships represent distortions or inappropriate solutions for emotional intimacy and satisfaction in the current relationship are articulated.

III. EMPIRICAL STUDIES

Among insight-oriented approaches to couples therapy, both the emotionally focused therapy developed by Susan Johnson and Leslie Greenberg and the affective reconstructive therapy described by Douglas Snyder and colleagues have been shown to be effective in reducing couples' distress and improving relationship satisfaction.

Several controlled trials of EFT have been conducted by Johnson, Greenberg, and colleagues—yielding an average effect size of 1.3, indicating that the average couple receiving EFT was better off at the end of treatment than 90% of couples in no-treatment control conditions. Findings have indicated that roughly 70% of couples receiving EFT experience significant reductions in distress in 8 to 12 sessions, and that treatment effects remain stable or improve over time. Research on the process of EFT suggests that engagement with emotional experience and interactional shifts are the active ingredients of change in this approach.

Douglas Snyder and Robert Wills compared their insight-oriented approach emphasizing affective reconstruction with a traditional behavioral couples therapy emphasizing communication skills training and behavior exchange techniques. Thirty couples were randomly assigned to each of these two treatment conditions, and 20 couples were assigned to a wait-list control group. At termination after approximately 20 sessions, couples in both treatment modalities showed significant gains in relationship satisfaction compared to the control group. The effect sizes for both treatments were approximately 1.0, indicating that the average couple receiving either treatment was better off at the end of treatment than 85% of couples in the control condition. By termination, 73% of couples receiving the insight-oriented therapy and 62% of couples receiving the behavioral therapy experienced significant improvement. In addition, couples in both treatment conditions generally maintained their therapeutic gains at 6 months following termination.

However, Snyder and colleagues followed up couples in their treatment study 4 years later and found striking

differences between couples treated with insight-oriented versus traditional behavioral therapy. At 4 years following treatment, 38% of the behavioral couples had experienced divorce, in contrast to only 3% of couples treated in the insight-oriented condition. Based on these findings, Snyder and colleagues argued that spouses' negative views toward their partner's behavior are modified to a greater degree and in a more persistent manner once individuals come to understand and resolve emotional conflicts they bring to the marriage from their own family and relationship histories.

IV. SUMMARY

An important source of couples' difficulties includes partners' emotional injuries from previous relationships resulting in sustained interpersonal vulnerabilities and related defensive strategies interfering with emotional intimacy. Insight-oriented couples therapy affords partners a unique opportunity to free themselves from recurrent maladaptive relationship patterns and pursue the rich emotional rewards that intimate relationships offer.

See Also the Following Articles

Behavioral Marital Therapy ■ Family Therapy ■ Interpersonal Psychotherapy ■ Object Relations Psychotherapy ■ Parent–Child Interaction Therapy ■ Psychoanalytic Psychotherapy and Psychoanalysis, Overview ■ Psychodynamic Couples Therapy ■ Sex Therapy ■ Spouse-Aided Therapy ■ Structural Analysis of Social Behavior

Further Reading

- Johnson, S. M. (1996). *The practice of emotionally focused marital therapy: Creating connection*. New York: Brunner/Mazel.
- Kernberg, O. F. (1995). *Love relations: Normality and pathology*. New Haven, CT: Yale University Press.
- Scharff, D. E., & Scharff, J. S. (1991). *Object relations couple therapy*. Northvale, NJ: Aronson.
- Snyder, D. K. (1999). Affective reconstruction in the context of a pluralistic approach to couple therapy. *Clinical Psychology: Science and Practice*, 6, 348–365.
- Young, J., & Gluhoski, V. (1997). A schema-focused perspective on satisfaction in close relationships. In R. J. Sternberg & M. Hojjat (Eds.), *Satisfaction in close relationships* (pp. 356–381). New York: Guilford Press.

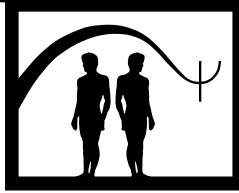

Coverant Control

E. Thomas Dowd

Kent State University

- I. Description of Treatment
 - II. Theoretical Bases
 - III. Applications and Exclusions
 - IV. Empirical Studies
 - V. Case Illustration
 - VI. Summary
- Further Reading

GLOSSARY

behavioral rehearsal A covert, imaged-based rehearsal of a desired sequence of behavior or course of action.

coverant A covert (internal) operant or response.

covert conditioning The reinforcement, punishment, or extinction of covert (private) events to alter their frequency.

extinction The decrease in the probability of a behavior due to lack of reinforcement.

homogeneity assumption The assumption that all categories of behavior, covert and overt, follow the same laws.

hypnotic susceptibility (trance capacity) The ability to enter a hypnotic trance and to experience a wide variety of perceptual alterations. It is relatively invariant across time and is normally distributed in the population. It may be related to the ability to vividly imagine.

implosive therapy (flooding) Reduction of fear responses by repeated exposure to images of the feared situation without being able to reduce the fear by avoidance.

interaction assumption The assumption that the categories of behavior—overt, covert, and physiological—interact with each other in a reciprocal fashion.

learning assumption The assumption that all behaviors are controlled by the same laws.

modeling (vicarious learning) An increase or decrease in the probability of a behavior that results from observation of a model being reinforced or punished rather than from direct reinforcement or punishment.

negative reinforcement Any consequence that increases the probability of an antecedent response by the withdrawal of the consequence.

operant Any individual response that operates on the environment.

positive reinforcement Any consequence that increases the probability of an antecedent response by its application.

Premack Principle The reinforcement of a lower probability response by a higher probability response.

private event An event or behavior observable only by the observing individual, not by the observing community.

punishment Any consequence that decreases the probability of an antecedent response by its application.

systematic desensitization Reduction of fear responses by repeated pairing images of the feared event with relaxation in a graduated hierarchy.

I. DESCRIPTION OF TREATMENT

In order to modify coverants, psychologists engage in covert conditioning or the conditioning by behavioral procedures in order to control private events. There are several types of covert conditioning procedures, each designed to achieve different results. Four of them, covert sensitization, covert extinction, covert response cost, and the self-control triad (thought-stopping) are designed to decrease the frequency of unde-

sirable behaviors. Two of them, covert positive reinforcement and covert negative reinforcement, are designed to increase the frequency of positive behaviors. Covert modeling can be used to either decrease or increase a target behavior. I will describe each in turn.

A. Covert Sensitization

This is a procedure designed to reduce the frequency of an undesirable behavior by pairing it in imagery with an aversive stimulus (e.g., a nauseous scene). Three aspects are important. First, classical conditioning is used by repeatedly pairing the undesirable behavior with the unpleasant scene. Second, escape conditioning is provided through the use of negative reinforcement whereby the reduction in the undesirable behavior is paired with positive feelings when the unpleasant scene is terminated. Third, it is helpful to relax the client first. For example, a therapist might instruct a client to graphically and in detail visualize how nauseous he feels when he sees a pack of cigarettes and then imagine himself feeling much better as he turns away from the cigarettes. This procedure has been used in hypnotic contexts as well as in imagery. The outcome probably depends on the client's ability to visualize, which in turn may be related to hypnotic susceptibility. This procedure was widely used at one time, more than any other covert conditioning procedure, and there has been research documenting its effectiveness, although other variables (such as expectancy) may be involved as well.

B. Covert Extinction

In this procedure, clients are instructed to imagine performing an undesirable behavior (the target behavior) and then not being reinforced for that behavior. For example, a client who talks too much will be instructed to imagine herself talking with no one listening.

C. Covert Response Cost

In this procedure, clients are instructed to imagine performing an undesirable behavior and then to imagine that they have no reinforcer for that behavior other than what is maintaining the response. This is similar to covert extinction except that in covert response cost there is a reinforcer but only the original one. There is no other reinforcer so there is a cost to making the response because other responses might provide more reinforcement.

D. Self-Control Triad (Thought-Stopping)

This procedure consists of three parts (hence the term "triad"). First, clients are instructed to shout "stop" to themselves (preferably not aloud, especially in public!) whenever they think of the undesirable behavior or thought. Second, they are instructed to take a deep breath, exhale, and relax. Third, they then imagine a pleasant scene as a reward for terminating the undesirable thought. Thus, negative reinforcement or escape conditioning is involved. Less obvious variations of this procedure have been used such as snapping a rubber band on one's wrist as an aid to stopping the thought or cognitive distraction from the intrusive thought to another image. The self-control triad can be useful for clients who are plagued by constant negative ruminations.

E. Covert Positive Reinforcement

In this procedure, clients are asked to imagine the positive target behavior and then to imagine a pleasant scene. For example, a client who has a fear of flying may be asked to imagine herself walking comfortably onto a plane, sitting in her seat, and then imagining a pleasant scene such as lying on a sunny beach. Thus, the pleasant scene acts as a positive reinforcer for the image of walking comfortably onto a plane.

F. Covert Negative Reinforcement

In this procedure, clients are asked to imagine an aversive situation or event, then to terminate this image, and immediately imagine a response to be increased in frequency. For example, a man might be asked to imagine himself arguing with his wife (an aversive event) and to switch immediately to imagining himself making an assertive response to her. Thus, the termination of the aversive event is reinforced by the image of the new assertive response.

G. Covert Modeling

In this procedure, clients are asked to imagine observing a model performing the target behavior and then to imagine either a reinforcing or punishing consequence applied to the model's behavior. For example, a client with a fear of authority figures may imagine a model acting assertively with her boss and being reinforced by the boss's change of mind. This should result

in an increase in the probability of assertive responses in the future. Or, an overly aggressive client may be asked to imagine a model acting overly assertive with her boss and being punished by the loss of her job. This should result in a decrease in the probability of aggressive responses in the future.

Coverant control is ideally suited for self-control training. Its reliance on imagery-based procedures makes it extremely flexible and adaptable to a wide variety of client situations. Therapists can train clients in their offices to use these procedures in their daily lives.

Covert behaviors can serve a variety of functions. First, they may act as antecedents of other behaviors. They become the covert cues for subsequent behavior. For example, fear and avoidance of many objects are due to covert images of what might happen if one is placed in the fear-producing situation. The most prominent examples of changing the cuing functions of these covert images are systematic desensitization and "flooding" or implosion therapy. Both of these procedures have been shown by research to be effective in modifying subsequent behavior, though probably not for the reasons originally thought. In systematic desensitization, relaxation is used to change the covert cues that arouse the fear and avoidance so that it is no longer aroused to the same degree, beginning with covert cues low on the anxiety-producing hierarchy and gradually moving higher. In flooding, one begins at the top of the fear-producing hierarchy and uses repeated exposure through imagery to the fear-producing situation until it no longer evokes the same response. Other techniques for changing antecedent covert cues, such as focused attention, hypnosis, biofeedback, meditation, and autogenic training may also be effective in changing subsequent behavior.

Covert behaviors can also act themselves as target behaviors to be changed. Perhaps the best-known example of this procedure is Donald Meichenbaum's original self-instructional training. In this procedure, negative self-statements, such as, "I know I'm going to fail!" are gradually replaced with more adaptive self-statements, such as, "If I take my time, I know I can succeed." Therapists model these adaptive self-statements and train the clients how to use them. This procedure has been applied to a variety of covert target behaviors, such as test anxiety, impulsivity, and schizophrenic "crazy talk." Thought-stopping, described earlier, is another example of covert behaviors as target behaviors. Indeed, the cognitive therapies developed by Aaron T. Beck and Albert Ellis consist in large part of modifying covert target behaviors, which are called

negative self-statements. Clients gradually learn how to identify their negative self-statements (negative covert target behaviors) and replace them with more positive and adaptive self-statements (positive covert target behaviors).

Covert behaviors can also act as consequences; that is, they can themselves function as reinforcers and punishers. Imagined consequences of specific actions have long been known to exert a powerful control on behavior and emotion. Thus, changing an image about the likely consequence of an action can change the action. Behavioral rehearsal, or the imaginal rehearsal of a desired behavioral sequence of action, is an example. In this procedure, clients are asked to imagine themselves engaging in a sequence of action they desire, which is reinforcing, as well as providing them with new ideas for action. This imagined course of action can be modified in discussions with the therapist. Covert sensitization, covert positive reinforcement, covert negative reinforcement, covert extinction, and covert modeling, as described earlier, are also examples of covert behaviors used as consequences.

II. THEORETICAL BASES

Although it has been known by other names for centuries, coverant control was first identified and described by that name by Lloyd Homme. The term coverant is simply a contraction of the terms covert operant and refers to internal responses, such as thinking, fantasizing, daydreaming, feeling, or imagining. They are responses than laypeople would call mental operations. Certain physiological sensations would also be classed as coverants. Thus, coverant control refers to control of private mental or physiological events, observable only to the observing individual, rather than to the control of events observable to everyone.

Coverant control is assumed to be derived from the same behavioral laws, primarily those of operant conditioning, that govern overt control, or the control of publicly observable behavior, and coverants are subject to the same laws of learning. This is known as the learning assumption. Furthermore, there is a continuity between overt and covert behavior such that conclusions about one class of behavior can be transferred to the other. This is known as the homogeneity assumption. Coverants can be increased in frequency via the technique of positive or negative reinforcement or decreased in frequency via the technique of punishment and extinction. Thus, coverant control is a behav-

iorally oriented control method, differing from overt behavior control only in the observability of the events. Coverant control is therefore an aspect of behavioral psychology, not cognitive psychology. However, coverant control is based heavily on the imagery process or, in some cases, hypnosis and hypnotic imagery. Indeed, it operates primarily on the use of imagining because this provides the vehicle by which the private events are assessed and the reinforcing or punishing consequences are administered. Essentially, the imagery processes act as mediating stimuli between the reinforcing or punishing consequence and the antecedent event.

Coverant control also uses modeling or vicarious learning as originally developed by Albert Bandura. He discovered by extensive research that it was possible to increase or decrease the probability of a behavior without an individual being exposed directly to reinforcing or punishing consequences. Rather, it was sufficient to observe a model being reinforced or punished for learning and behavior change to occur in an observer. Bandura called this "vicarious conditioning" and he argued that it is the basis on which most human learning occurs. Bandura also distinguished between a coping model (who made mistakes) and a mastery model (who did not) and found that the former was actually a more effective model. Perhaps this is true because clients can more easily identify with a coping model. Indeed, as Bandura has noted, people even respond in accordance with their perception of a reinforcer rather than an actual reinforcer itself.

Coverant control also makes use of the Premack Principle. The Premack Principle states that behaviors engaged in with a greater probability can be used as reinforcers for behaviors engaged with a lower probability or not at all. For example, studying behavior in students, which is a lower probability behavior, can be reinforced by watching television, which is a higher probability behavior. Thus, students may set a contract by which every 2 hours of diligent study will be rewarded by a half-hour of television. It is important to note, however, that the high probability behavior must be intrinsically reinforcing to the individual and not simply one that carries little or no reinforcement value.

Coverant control assumes that the various categories of behavior, such as overt, covert, and physiological, interact with and influence one another in ways that can be derived from basic laws of learning. This is known as the interaction assumption. In other words, thinking, behaving, and feeling all influence each other reciprocally. It should be noted, however,

that what are commonly called "emotions" or "feelings" may be essentially a situationally specific cognitive labeling of a physiological arousal, the emotion thus identified being dependent on the social context in which the arousal is noted and labeled. In addition, it is often difficult to identify a "first cause" for the content of this interacting system, although in most situations it is probably behavior.

Although it is not usually discussed as such, covert control can be based on classical conditioning. Many negative coverants (e.g., negative images) were originally conditioned by being paired with negative life events. For example, extreme trauma, such as occurs in wartime combat, can result in (by classical conditioning) very negative images that occur repeatedly as flashbacks. These flashbacks can be seen as a form of covert events. Repeatedly pairing these flashbacks, spontaneous or elicited, with more positive feeling states (such as relaxation) or positive self-statements may lead to a reduction in frequency and severity. In principle, any negative covert event might be reconditioned by being paired repeatedly with a more positive event or other coverant (image).

III. APPLICATIONS AND EXCLUSIONS

Coverant control only represents an extension of the basic laws of learning to internal, private events, that is, those observable only to the observing individual (the homogeneity assumption). Because these laws are thought to be universally applicable to humans, regardless of various aspects of human diversity (the learning assumption), no racial, gender, or ethnic groups should be excluded. Coverant control has been applied to a variety of populations, including outpatient adult clients, children, and the elderly, as well as residential school, and hospitalized clients. However, different events or consequences will be differentially rewarding (or aversive) to different cultural or other groups; indeed to different individuals within those groups. Therefore, behavioral psychologists should carefully assess which consequences are likely to be reinforcing or punishing to different individuals within and across these groups. It cannot be assumed that common reinforcers or punishers are reinforcing or punishing to everyone.

In addition, individuals vary considerably in the extent to which they are able to create vivid images and therefore to make use of imagery-based procedures.

This ability has been linked to hypnotic susceptibility, which is normally distributed in the population. Although those individuals who have difficulty creating vivid mental images may improve somewhat with practice, they are unlikely to become imaging virtuosos. Hypnotic susceptibility has been shown to be a relatively stable characteristic of human functioning.

Because the internal behaviors to be changed cannot be directly observed by others and the reinforcing consequences must be self-applied, it is especially important that clients be motivated and willing to disclose appropriate target behaviors. Clients who are not self-referred may lack the motivation to make coverant control methods useful. In addition, they are probably not appropriate for crisis intervention because immediate action may be required by an external agent.

There are also certain people for whom coverant control might be difficult or not applicable because of their inability to understand or follow instructions. For example, very young children may not yet possess the ability to concentrate and create vivid images. Individuals with severe mental or behavioral disorders, or significant intellectual deficits, may also have great difficulty using imagery-based procedures. However, even within these populations, certain individuals may have the capacity, at least in part and with training, to formulate and use images. Thus, no population should be excluded from this procedure *only* on the basis of group membership. Indeed, for all clients, regardless of group membership, it is very helpful prior to treatment to conduct an assessment of ability to use imaginative procedures.

IV. EMPIRICAL STUDIES

Of all the various covert conditioning procedures, covert sensitization has been the most empirically investigated. Early studies showed that it was effective for a wide variety of problems with lasting effects. Later studies by David Barlow and his colleagues in the late 1970s supported this conclusion. Joseph Cautela and Albert Kearney summarized research from the 1970s and early 1980s indicating that in general covert positive reinforcement and, to a lesser extent, covert sensitization was effective. However, the research evidence was mixed and the mechanism often unclear. Other studies from the 1970s indicated that coverant control was effective in increasing the rate of positive self-evaluations, reducing neurotic depression, losing weight, and reducing annoying personal habits. How-

ever, it was difficult to rule out the causal effects of other variables.

Curiously, almost no research appears to have been conducted on the effectiveness of coverant control since then. A survey of the literature up to early 2000 turned up almost exclusively publications describing theoretical arguments and procedural descriptions. One study published in 1981 by Joseph Cautela found covert reinforcement to be more effective than reciprocal inhibition in modifying pain response. Another study published in 1986, however, failed to support Cautela's theoretical explanation of covert conditioning as based on operant conditioning.

V. CASE ILLUSTRATION

Although covert sensitization is the procedure most commonly used and investigated in the coverant control literature, it has been applied mostly to the elimination or reduction of entrenched habit disorders such as smoking. Therefore, in this section I will present an example of a more versatile technique that can be applied to increasing the frequency of a wide variety of positive behaviors: covert positive reinforcement. It can be used to modify both maladaptive behavior and avoidance behavior. In the operant conditioning literature, positive reinforcement has been shown to be more effective in general than alternative behavior change methods.

"Joe" (not his real name) was a young man of 20 who was highly date-phobic. Although he had been popular in high school among the boys and had some casual female acquaintances, he had not had a real date other than a contrived encounter with an acquaintance of his aunt 2 years previously. That experience had proved to be extremely anxiety-provoking for him and he spent the entire evening in a sweat thinking of what to say next. His anxiety had rubbed off on the woman who talked less and less in the course of the time they were together. As a result, whenever he thought of calling a woman for a date, his mind flashed back to that one painful encounter and he became so anxious that he avoided thinking of dating to eliminate the anxiety. Interestingly, he was able to relate to adult women who were not potential romantic partners relatively easily and could even talk with women his age who were unavailable for other reasons. It was only when the female in question was a potential date that his anxiety surfaced.

The therapist soon determined that Joe's avoidance behavior was continuously reinforced by escape from

the anxiety-producing image of his agonizing first (and only) date. This image with its associated feelings was so powerful that it appeared to be unwise to attempt to eliminate it. Accordingly, the therapist decided to use covert positive reinforcement instead and to teach Joe this technique so he could use it whenever he interacted with a potential date.

The therapist's first task was to identify a positive reinforcer that Joe could use. After an extended discussion, it appeared that the best one was Joe's love of fishing. Nothing was as rewarding to him or as relaxing as sitting in a boat with his line and hook in the water. It hardly mattered if he caught anything; indeed the activity required to "land" a fish disturbed his reverie. Accordingly, the therapist asked Joe to relax, close his eyes, and to imagine the following scene as vividly as he could:

Joe, I'd like you to imagine sitting in a boat, fishing ... with your line in the water, your bobber floating a few feet away. It's a warm summer day and you can feel the sun on your body, feel its warmth penetrate your entire body. The boat is bobbing gently on the lake and you can hear the lapping of the water on the side of the boat. There is a very slight breeze, just enough so you can feel it but not enough so it is distracting. As you sit there, you can feel yourself relaxing more and more—with all the warmth and peace filling your body and your mind.

This scene was repeated with minor variations until Joe could easily visualize and experience it, along with the associated feelings of relaxation, peace, and warmth. The therapist then gave Joe the following instructions:

Joe, in a minute I'm going to ask you to imagine a scene as vividly as you can. When you have that image firmly in your mind, raise the index finger of your right hand (or left hand if Joe is left-handed). When you do that, I'm going to say the word "reinforcement" to you and I want you to imagine the fishing scene we practiced earlier. As soon as that scene is clear, raise your finger again. Ok?

After Joe had closed his eyes and relaxed, the therapist then presented the following scene:

Now, Joe, I want you to imagine that you meet a woman on the street who you know from your friends would like to date you. You begin to walk toward her. Raise your finger when this scene is clear. ("reinforcement"). Now, imagine her beginning to speak with you; raise your finger when this is clear. ("reinforce-

ment"). Now imagine yourself beginning to speak with her; raise your finger when this is clear. ("reinforcement"). Now, imagine yourself finishing your conversation with her and beginning to leave; raise your finger when this is clear ("reinforcement"). Good, now terminate that scene from your mind.

After several repetitions of this extended scene paired with the reinforcing scene, Joe was able to imagine himself meeting and speaking with available women. The therapist then asked him to practice this sequence at home on a regular basis. When he was able to do this, Joe was asked to practice it in an actual situation, taking care not to extend the conversation too long at first. With repeated practice, Joe was able to hold longer and longer conversations with women.

In conducting covert reinforcement, it is important to repeat the procedure many times in order to associate the aversive scene with the reinforcing scene. In this manner, the former may gradually become associated with the latter instead of with anxiety. The proper selection of the reinforcing scene is crucial because it should be important enough to overcome the considerable previous conditioning of the aversive situation.

VI. SUMMARY

Coverant control is a set of procedures that grew out of primarily operant conditioning methods and is applied to covert, or internal, behaviors rather than external. It uses many of the same techniques as overt conditioning and is based on the same theoretical explanations. According to this model, internal activities such as images, thoughts, and feelings, are considered to be behaviors following the same laws of conditioning as external activities. It is potentially quite flexible because it can be implemented anywhere by clients themselves. There may be individual differences in how vividly clients can visualize images and therefore use the techniques. Although some research findings have demonstrated support for the procedures, especially covert sensitization, others have not and it has not been shown that coverant control is generally more effective than alternative procedures. In addition, research has not clearly demonstrated that the hypothesized theoretical mechanisms actually account for the change. Since the early 1980s, the literature on the topic has consisted almost entirely of theoretical and procedural aspects and the number of articles has declined from the 1960s and 1970s.

See Also the Following Articles

Covert Positive Reinforcement ■ Covert Rehearsal
 ■ Covert Reinforcer Sampling ■ Extinction ■ Implosive
 Therapy ■ Modeling ■ Negative Reinforcement ■
 Positive Punishment ■ Systematic Desensitization ■
 Thought Stopping

Further Reading

- Bandura, A. (1969). *Principles of behavior modification*. New York: Holt, Rinehart, & Winston.
- Bennett, A. K., & Cantela, J. R. (1981). The use of covert conditioning in the modification of pain: Two experimental tests. *Journal of Behavior Therapy & Experimental Psychiatry*, 12, 315–320.
- Cautela, J. R., & Kearney, A. J. (1986). *The covert conditioning handbook*. New York: Springer.
- Cautela, J. R., & Kearney, A. J. (1993). *Covert conditioning casebook*. Pacific Grove, CA: Brooks/Cole.
- Dowd, E. T. (2000). *Cognitive hypnotherapy*. Northvale, NJ: Jason Aronson.
- Hayes, S. C., Brownell, K. D., & Barlow, D. H. (1978). The use of self-administered covert sensitization in the treatment of exhibitionism and sadism. *Behavior Therapy*, 9, 283.
- Homme, L. E. (1965). Control of coverants: The operants of the mind. *Psychological Record*, 15, 501.
- Meichenbaum, D. (1977). *Cognitive-behavior modification: An integrative approach*. New York: Plenum.
- Thoresen, C. E., & Mahoney, M. J. (1974). *Behavioral self-control*. New York: Holt, Rinehart, & Winston.

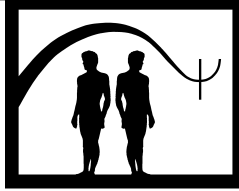

Covert Positive Reinforcement

Gerald Groden and June Groden

The Groden Center, Inc. and Brown University

- I. Description of Treatment
 - II. Theoretical Bases
 - III. Empirical Studies
 - IV. Summary
- Further Reading

GLOSSARY

analogue studies Studies similar to clinical studies but not using clinical patients or clinical level problems.

antecedent A preceding event, condition, or cause.

baseline Measures taken on a behavior before initiating a treatment program. This is used to evaluate the effect of a behavior treatment program.

cognitive restructuring A cognitive-behavioral procedure in which the client is assisted in utilizing different cognitive perspectives or frameworks in the process of treatment.

control group A contrast group used in experiments to help ensure that study findings are not due to confounding factors, such as subject expectation.

covert extinction An imaginal procedure in which the reinforcer is no longer delivered for a previously reinforced response that results in a decrease in the probability or likelihood of the response.

covert sensitization An imagery-based treatment in which clients imagine themselves engaging in an undesired behavior (e.g., overeating) and then imagine an aversive event or state. The treatment is designed to decrease the undesired behavior.

demand/request phase An experimental control phase in which a request is used to rule out the possibility that the request, or implied request, affected the behavior.

dependent measures Measures of a variable that is expected to change as a result of experimental events or changes in these events.

functional assessment Evaluation of the behavior and of antecedents and consequences associated with the behavior in order to understand the role of the antecedents and consequences in the occurrence of the behavior.

multiple baseline An experimental design that demonstrates the effect of a contingency by introducing the contingency across different behaviors, individuals, or situations at different points in time. A causal relationship between the experimental contingency and behavior is demonstrated if each of the behaviors changes only when the contingency is introduced.

picture rehearsal (or cognitive picture rehearsal) A therapeutic procedure developed by June Groden in which the client views and recites a sequence of scenes involving a behavior to be changed and the consequence of that behavior.

placebo An inactive substance or condition serving as a control in an experiment.

reciprocal inhibition Weakening the bond between an anxiety-evoking stimulus and an anxiety response by pairing an anxiety-inhibiting response with an anxiety-evoking stimulus.

reinforcement An increase in the probability or likelihood of a response when the response is immediately followed by a particular consequence. The consequence can be either the presentation of a positive reinforcer or the removal of a negative reinforcer.

response prevention Preventing a response in the presence of an event that usually produces it.

satiation A loss of reinforcer effectiveness that occurs after a large amount of the reinforcer has been delivered.

self-control triad The self-control triad, developed by Joseph Cautela, is a combination of three techniques: thought-stopping, relaxation, and pleasant imagery. When an individual wants to decrease the probability of a behavior, he or she says to himself or herself "STOP." He or she takes a deep breath, relaxes, and imagines a pleasant scene.

systematic desensitization The systematic presentation of successively stronger anxiety-producing stimuli in the presence of an anxiety-inhibiting response resulting in a reduction of anxiety.

target behavior The behavior to be altered during a behavior change program.

visual imagery A procedure in which one creates an image in one's mind of an object or event, generally with one's eyes closed.

I. DESCRIPTION OF TREATMENT

A. Definition of Covert Positive Reinforcement

Covert positive reinforcement (CPR) is a procedure that was developed in 1970 by Joseph R. Cautela under the rubric of covert conditioning. Other covert conditioning procedures are covert sensitization covert extinction, covert response cost, and the self-control triad. These procedures were designed to decrease the frequency of behaviors. Covert positive reinforcement and covert negative reinforcement increase the frequency of desirable behaviors.

Positive reinforcement occurs when the behavior to be increased is followed by a consequence or event that results in an increase in the probability of that behavior. Covert positive reinforcement occurs when an individual imagines the behavior to be increased and then imagines a pleasant consequence or reward. This results in an increase in the probability of that behavior.

There are three main ingredients in the CPR procedure: (1) identifying the antecedent event; (2) selecting the target behavior; and (3) selecting an appropriate reinforcer or pleasant event. The use of functional assessment of behavior or a behavioral assessment is a prerequisite to designing a covert positive reinforcement program and provides the information that is necessary to design the scripts for the covert positive reinforcement scenes.

B. Presentation Formats

1. Visual Imagery

In implementing CPR, clients are instructed to imagine a scene in which they are performing the behaviors

to be increased. The reinforcing scene should be clearly visualized within 5 seconds after imagining this scene. One pair of target and reinforcing scenes is referred to as a single trial. In 1986, Joseph Cautela and Albert Kearney stated that an intertrial interval of at least 1 minute is recommended in order to avoid inhibition of reinforcement and too rapid a growth of inhibitory potential.

The therapist first presents the scene asking clients to keep their eyes closed and imagine the scenes that are described. Sensory details should be included (e.g., hear the sound of the ocean, smell the flowers). The client then repeats the scene. When the client first imagines the scene, the therapist asks questions to see if the client is visualizing (e.g., what does the ocean look like?). Audio tapes can also be used for home practice. Cautela recommends that at least 60 scenes be completed (for a typical adult) over a period of time before results are expected. After completing the practice scenes, when a situation occurs that involves the target behavior, the client is taught to recognize the antecedent, and repeat to himself or herself the behavior that is practiced in imagery and then use the appropriate behavior that has been rehearsed in imagery.

2. Picture Rehearsal

There are some individuals who have difficulty in visualizing the scenes. This may include persons with developmental disabilities or those who report problems in getting a clear visual image. June Groden, Joseph Cautela, Patricia LeVasseur, Gerald Groden, and Margaret Bausman in 1991 developed an adaptation of covert positive reinforcement by designing scenes that can be presented using written scripts or pictures that depict the scene and put it into the same format as the CPR procedure.

C. Designing a CPR Program

1. Identify the Antecedent Event

Antecedents are those events that precede the target behavior. These events can be people, places, time of day, or situations that influence the occurrence of the target behavior. Information obtained from the behavioral assessment should be incorporated into imagined scenes. Often, there are many different antecedents that influence a targeted behavior. In this case, scenes can be designed so that the antecedents are rotated when practicing the different scenes, or an antecedent that is non-specific can be used. For example, if a person finds it difficult to socialize at parties or at work, the scene might either begin with "you are at a party" or "you are at work" or "you are somewhere" (nonspecific).

2. Identify the Target Behavior

Target behaviors can be identified in a number of ways: (1) self-report from either the client or in the case of children, legal guardians or caregivers; (2) paper-and-pencil surveys; or (3) natural observations. Establishing a baseline, which is taken prior to beginning any formal intervention, involves data collection to gather information about frequency, duration, and the topography of the behavior. The baseline data are then used to measure effectiveness of the procedure. It is also useful during the course of treatment. If there is not a positive change in the data or the trend line, modifications can be made to the scenes to incorporate new information and alter the scripts to reflect this new information.

3. Create a Personalized Menu of Pleasurable or Reinforcing Events

Each imagery scene in the CPR format should conclude with an imagined pleasant scene that is specific for each client. Information for these scenes can be obtained from self-report, paper-and-pencil surveys, or direct observations, particularly in free choice situations. Reinforcement sampling described by Teodoro Ayllon and Nathan Azrin in 1968 may also be used to acquaint individuals with reinforcers they may not have been exposed to previously. It is important to have a number of reinforcers from which to choose in order to prevent satiation (i.e., ice cream may not be as reinforcing to imagine following the consumption of an ice cream sundae).

D. An Example of a CPR Scene

In 1981 Avis Bennett and Joseph Cautela described the following CPR scene to increase the target behavior of not eating dessert:

Imagine you are standing at the dessert table with your friends. As dessert is passed, you politely refuse, and feel good about staying on your diet.

This is followed by a pleasant scene:

Imagine you are your ideal weight. You look really slim in your favorite color and style. Someone you like says to you, "Gee, you've lost weight. I've never seen you look so good."

E. Advantages of CPR

CPR has many advantages. All positive procedures are preferred over techniques that are aversive and put

the individual at risk for discomfort, stress, or other side effects. In addition to sharing the advantages of all positive procedures, the advantages of using CPR include the following:

1. Scenes in the use of CPR can be adapted to various cognitive levels and learning styles.
2. It allows for more opportunities for practice and repetition that can be done overtly. As the number of trials increases, learning becomes stronger.
3. Spatial and temporal restrictions are not limited since the procedures are done in imagination. Environments can be created that are not accessible in overt situations.
4. The opportunities for generalization increase since many more scenes can be practiced in different settings and with different people without having to go to those settings or having the persons actually present.
5. An individual's general level of reinforcement can be increased by imagining pleasant events.
6. In order to administer the therapy, it is not necessary to interrupt daily life functioning (i.e., unlike the administration of tokens in a classroom, which interrupts the classroom program, CPR can be administered in another setting, and the change will occur in the classroom through the imagined practice).
7. There is no need to use materials or equipment that are difficult to carry or that are interfering.

CPR can be a preventative procedure. Problematic situations can be anticipated. Scenes of stressful antecedents and the appropriate response to them can be practiced in imagery. The stressful and aversive antecedent does not actually have to occur for the practice to take place. This can avert a problematic behavior when the aversive stimulus actually occurs and the patient exhibits appropriate behavior.

II. THEORETICAL BASES

Covert conditioning is a theoretical model that involves a set of assumptions about imagery-based procedures that change response frequency. Covert is the term used because the client is asked to imagine the target behavior and the consequences. The covert conditioning procedures are based on three main assumptions:

1. Homogeneity: This assumption implies a continuity between overt and covert behaviors. The covert and overt processes share similar importance and similar properties in explaining, maintaining, and modifying behavior.

2. Interaction: Covert events can influence overt events and overt events can influence covert events. In addition, these events can occur concomitantly.

3. Learning: Covert conditioning is based on the assumption that covert and overt behaviors are governed by laws of learning, primarily operant conditioning, and that overt and covert behaviors interact according to these same laws.

III. EMPIRICAL STUDIES

Most of the studies on this topic appeared in the early 1970s and 1980s shortly before the period in which studies in learning/conditioning techniques for therapeutic purposes waned and cognitive-based ones captured experimenters' and clinicians' interests. Many of these studies were not written or reviewed with the scientific rigor that we often find now in collaborative studies. In fact, it is only recently that rigorous study guidelines are receiving general acceptance. Earlier reviews of CPR were published by Donald Scott and Anne Rosentel in 1975, Alan Kazdin and George Smith in 1979, and Michael Stevens in 1985. These concluded, with some reservations regarding study design and other problems, that evidence suggested that CPR was effective.

Literature utilized for this review were controlled experimental studies resulting from a literature search using the terms covert positive reinforcement and covert reinforcement. The search covered the period 1970, the time of the first article on CPR by Joseph Cautela, to the present. The search resulted in 34 articles. This literature contained both clinical research (8 studies), as well as analogue research, that is, research in which CPR was used to modify either clinical-type problems in persons who did not have them to the extent that they would be classified as patients, or non-clinical behaviors (26 studies).

A. Summary of CPR Effectiveness

In the clinical studies, the effectiveness of CPR was compared to one or more of the following conditions: an alternate treatment thought to have some empirical support; a placebo condition, in which the subjects thought that they were receiving treatment, but were

not actually receiving it; and no-treatment. In the analogue studies, CPR was compared to an alternate treatment, an expectancy or attention group (analogous to placebo controls for the clinical studies), and/or a no-treatment group. Some of these studies included additional comparison groups for the purpose of testing the theory on which CPR is based.

Overall, in the clinical studies, CPR was more frequently superior to alternate treatment and placebo comparisons. This was also the case, although to a lesser extent, for no-treatment comparisons. The analogue experiments indicate CPR to be generally or at least equal to alternate procedures, with mixed results for expectancy or attention controls and no-treatment control comparisons. Although the majority of studies were analogue, because CPR was developed as a clinical procedure, it is thought that the results of the clinical studies should receive emphasis in judging CPR's therapeutic efficacy.

B. Discussion of Comparison Studies

1. Clinical Studies

Of the clinical studies, five utilized group designs. In two of these the effectiveness of CPR as a technique for effecting weight loss was evaluated. Two other studies involved test-taking anxiety reduction, while another concerned self-concept enhancement. There were also three single-case design studies. Two of these involved improving social behaviors in children with developmental disabilities and the third involved fear reduction in a college student. In the group studies, CPR was found to be more effective than an alternate treatment in one out of one comparison. CPR was also more effective than placebo controls in three out of four comparisons and more effective than no treatment in two out of three comparisons. The findings of the single-case studies were somewhat supportive of CPR.

2. Analogue Studies—Clinical-Type Behaviors

There were 13 analogue studies in which CPR was used to modify clinical-type problems in persons who did not have them to the extent that they would be characterized as patients. Study participants were generally college students participating in the studies as part of a course requirement and not because they were independently seeking treatment. Three of the studies were on attitude change, concerning attitudes toward persons with mental retardation, physical handicaps, or self-esteem; five involved fear reduction; and five involved test-taking anxiety reduction.

In all, five out of five studies comparing CPR to an alternate procedure reported CPR to be equal to, or more effective than, that procedure. Four out of seven studies, including a placebo control, found CPR to be superior to the placebo condition. Nine of the studies utilized a no-treatment control group. Of these, two found CPR to be superior. Thus in this group of studies CPR was more frequently equal to or superior to an alternate procedure, slightly more frequently superior to placebo, but not superior to no treatment.

3. Analogue Studies—Non-Clinical-Type Behaviors

There were 13 analogue studies in which the target behavior was nonclinical, such as influencing over- or underestimation of circle size, and the subjects were frequently college students. In 1 of these studies, subjects were patients hospitalized in a psychiatric facility. In four of the studies, the target behavior was increased tolerance to experimentally induced pain. In three studies the target behavior was attitude change, and the remaining six involved influencing verbalizations, circle size estimation, eye contact, and yawning.

In four comparisons with alternate procedures, CPR was more effective than these treatments in three of four instances. CPR was more effective in one of four comparisons with an expectancy condition. When compared to no-treatment conditions, CPR was superior in four of nine studies. An additional study in this category found CPR effective, but it did not lend itself well to this type of analysis. Thus, CPR was generally superior to alternate procedures, but not superior to expectancy or no-treatment conditions.

Several studies addressed the question of whether or not, when CPR proved efficacious, operant conditioning was responsible for its effect, as Cautela proposed. Some of these studies cast doubt on this crucial assertion and offered alternate explanations, such as reciprocal inhibition or exposure and response prevention.

4. Interpretation Problems

The introduction to the empirical studies review noted problems in past CPR research, making it difficult to render valid conclusions regarding its effectiveness. These problems have been noted by other reviewers as well. In addition to those already mentioned, these studies suffered from either not containing as many as 25 subjects per condition (a number recommended by Dianne Chambless and Steven Hollon in 1998 to be the minimum number for detecting

differences between groups), different experimenters conducting different groups, or the experimenters conducting placebo or expectancy conditions not being blind to conditions. Frequently, subjects in these groups were not asked post-study whether or not they thought they were receiving treatment. A number of studies relied on subjects' reports regarding the extent they practiced CPR homework scenes that were assigned to them. Also, the articles frequently did not sufficiently describe the CPR procedures employed, used nonstandardized instructions and reinforcing stimuli, lacked no-treatment or placebo controls, and used unvalidated dependent measures. In addition, comparison treatments characterized in this review as alternate treatments considered to have some empirical support were often not carried out with as much richness as they might have been in actual clinical treatment. Nonuniform subject characteristics, such as motivation, and variable experimenter characteristics, such as competence in procedures used, also characterized the literature. Finally, it should also be noted that CPR is a clinical procedure that, for maximal effectiveness, should be carried out in a highly individualized manner in which the clinician is sensitive and adjusts to the idiosyncrasies of the client. Group studies in which instructions are often taped and the procedures predetermined would be expected to put it at a disadvantage.

IV. SUMMARY

In summary, CPR is a learning-theory-based therapeutic procedure in which imagined target, behaviors, and consequences are substituted for overt ones. The literature suggests its effectiveness, but characteristics of the studies make it difficult to conclude this with any certainty. Future, improved studies will hopefully clarify the merits and mechanisms of this innovative and potentially promising procedure. Joseph Cautela was certainly one of the pioneers in the use of imagery in therapy and its incorporation into cognitive behavioral therapy, behavioral medicine, and sports psychology.

See Also the Following Articles

Assisted Covert Sensitization ■ Behavior Rehearsal ■ Covert Control ■ Covert Rehearsal ■ Covert Reinforcer Sampling ■ Negative Reinforcement

Further Reading

- Agras, W. S. (1972). Covert conditioning. *Seminars in Psychiatry*, 4, 157–163.
- Cautela, J. R., & Bennett, A. K. (1981). Covert conditioning. In R. Corsini (Ed.), *Handbook of innovative psychotherapies*. New York: Wiley.
- Cautela, J. R., & Kearney, A. J. (1986). *Covert conditioning handbook*. New York: Springer.
- Cautela, J. R., & Kearney, A. J. (Eds.). (1993). *Covert conditioning casebook*. Pacific Grove, CA: Brooks/Cole.
- Groden, J. & LeVasseur, P. (1995). Cognitive picture rehearsal: A system to teach self-control. In K. A. Quill (Ed.), *Teaching children with autism: Strategies to enhance communication and socialization*. Albany, NY: Delmar Publishers, Inc.
- Kazdin, A. E., & Smith, G. A. (1979). Covert conditioning: A review and evaluation. *Advanced Behavior Research Therapy*, 2, 57–98.
- Scott, D. S., & Rosentiel, A. K. (1975). Covert positive reinforcement studies: Review, critique, and guidelines. *Psychotherapy: Theory Research and Practice*, 12, 374–384.
- Stevens, M. J. (1985). A brief overview and evaluation of covert positive reinforcement. *Psychology: A Journal of Human Behavior*, 22, 71–79.

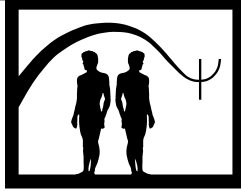

Covert Rehearsal

Zehra F. Peynircioğlu

American University

- I. Overview
 - II. Types of Covert Rehearsal
 - III. Effectiveness of Covert Rehearsal
 - IV. Covert Rehearsal of Nonverbal Materials
- Further Reading

GLOSSARY

- autobiographical memory** Memory for events from one's earlier life.
- automatic encoding** Committing to memory without any intention or effort.
- depth of encoding** Degree to which information is processed in a meaningful way when it is first encountered and committed to memory.
- episodic memory** Memory for specific personal experiences.
- flashbulb memory** Extremely vivid episodic memories that feel like they will never be forgotten.
- know-type memory** Memory for an event without the specific experience of encountering that event.
- long-term memory** Memory that lasts longer than a few minutes without active efforts to maintain it and survives the encoding of intervening events.
- mnemonic devices** Deliberate and systematic strategies to make remembering information easier.
- motor memory** Being able to do a physical action with greater facility after practice.
- reaction time** The time it takes to respond to a presented stimulus.
- reception context** In flashbulb memory research, remembering autobiographical information from when we received

the news of a flashbulb event, such as where we were, who was with us, how we felt, and so on.

remember-type memory Memory for an event that includes not only the recollection of the event but also the experience of encountering that event.

serial recall Remembering information in the order it was presented.

short-term memory Maintaining a limited quantity of information in memory for a brief period of time.

In memory research, covert or mental rehearsal refers to silently thinking about events or items with the intention of learning them, or, if already learned, strengthening or simply refreshing memory for them. In this article, the aim is to focus on what is meant by different types of covert rehearsal and to review findings from some intriguing empirical studies that have explored various aspects of covert rehearsal.

I. OVERVIEW

The function of rehearsal is to improve performance. To this end, most rehearsal in life is not covert but overt. That is, it is observable and necessarily resembles the performance itself, such as an orchestra rehearsal or basketball practice. When it comes to memory performance, however, overt rehearsal is less popular because, among other reasons, people are often reluctant to think aloud

and share their private thoughts with other people while learning new information; it is often faster and more practical to think silently, and not all thoughts are verbally communicable. In addition, in studying rehearsal, asking participants to share their mental activity can create restrictive and artificial task demands, cramp the rehearsers' style, and thus confound the purpose of the research. Thus, what is more often engaged in as well as more often explored in memory research is covert rehearsal. We engage in covert rehearsal in such cases as when we study for a test or try to memorize a list of names. Its function is to improve memory performance by enabling one to remember more events or items and with more facility. Various types of mental activity can be thought of as covert rehearsal; not all covert rehearsal is effective, or, leads to long-term memory improvement; and covert rehearsal is possible with both verbal and nonverbal stimuli.

II. TYPES OF COVERT REHEARSAL

In general, as the word implies, covert rehearsal involves repetition, or thinking about the material over and over again. However, in a less strict sense, any mental processing engaged in after as well as any "extra" mental processing engaged in during the occurrence of an event or the presentation of a stimulus item can be considered as covert rehearsal. In those cases, continual repetition per se is not necessary, although the concept of repetition is still there because any further thinking about a target stimulus by definition involves the repetition of that stimulus. Indeed, it is possible to consider any further mental processing of the target events or items as covert rehearsal even if it is a one-shot deal and does not involve any continual repetition. Among such types of covert rehearsal might be imagery, reorganizing the target material, or even involuntarily thinking about the target material on being reminded of it by an unexpected cue, although in this article we focus primarily on intentional covert rehearsal, the types that we engage in to improve memory performance.

Simple, continual repetition is perhaps the most basic and intuitively obvious type of covert rehearsal. If we want to commit something to memory, we can keep repeating it in our minds until we can recite it without needing to look at the stimulus anymore. We can then further rehearse it to make this recitation even more comfortable. Such simple repetition is perhaps most useful in trying to learn something verbatim, such as a poem or lines in a play, or when the order of the to-be-recalled items (e.g., in serial recall) is important. In addition, it is

probably the most commonly used type of covert rehearsal when we want to keep items in short-term memory, such as holding onto a phone number until we dial it, practicing our opening lines before starting a speech, or holding onto our words after having formulated just the right way of phrasing an answer to a question. It is the type of intentional covert rehearsal that probably requires the least amount of mental effort. Indeed, as R. S. Johnston, C. Johnson, and C. Gray showed in 1987, even 5-year-old children can engage in the effective use of such "inner speech" to remember words.

Other types of intentional covert rehearsal, especially those that are not necessarily dependent on simple repetition, require some creative thinking or thinking beyond the target stimuli at hand. For instance, imagery usually involves relating the target stimuli to pictorial or otherwise nonverbal entities or embedding them in more complex and usually perceptual scenarios. To be able to better remember, say, the word "viola," we may try to conjure up a visual image of the instrument, visualize its location in an orchestra, or try to mentally reconstruct how it sounds. Indeed, many mnemonic devices involve mentally thinking about the target stimuli further by arranging them in a different but more easily recoverable format. For instance, in using the method of loci, we combine imagery with a well-established map and mentally place the target stimuli in, say, different houses along the street we live on. Then, when it is time to remember, we try to reconstruct the to-be-remembered stimuli using the already known houses as cues. If the target stimuli are themselves nonverbal, such as dance moves, imagery may involve visualizing going through the moves or, in other words, mentally running through them; thus imagery can sometimes be confounded with simple, albeit nonverbal, repetition, as well.

The critical concept in all types of covert rehearsal is the concept of "further" or "extra" processing. Thus, for silent thinking to be considered to be rehearsal, it needs to occur after the initial encounter with the target stimulus, although the target stimulus need not have disappeared. If the target stimulus is still present, or the next stimulus not yet presented, there is an ostensible danger of confounding covert rehearsal with depth of initial encoding, a concept used to describe any elaborate mental processing that one engages in when one is presented with a target stimulus and a concept some psychologists keep separate from that of covert rehearsal. However, because in many contexts the fine line between deep initial encoding and rehearsal is quite blurred, especially if deep initial encoding involves mental repetition, this distinction may be unnecessary. Just as it is possible to say one is rehearsing one's lines or a piece of music even

when it is for the first time, perhaps what is considered deep encoding when one is presented with a target stimulus for the first time can be thought of also as covert rehearsal, as long as it involves “further” thinking about the stimulus. Thus, in this article, whether it involves mental repetition of the target stimulus or another strategy, any “extra” thinking about the target stimulus is considered covert rehearsal.

In addition to considering the type of mental activity involved, that is, whether it relies solely on simple repetition or involves another mental strategy, covert rehearsal may be classified in many other ways. For instance, it may be stimulus based rather than memory based in that we can keep referring to the target stimulus while rehearsing, or it may be experimenter controlled rather than participant controlled in that we rehearse what is presented to us and not what we choose. In addition, covert rehearsal may be classified in terms of whether it is effective or ineffective, that is, whether it improves memory performance or not. Not all types of covert rehearsal improve memory; sometimes, even when a person feels that his or her memory has improved because of rehearsal, such subjective feelings may not be accurate in terms of performance measures. Covert rehearsal may also be classified in terms of modality, that is, whether the target material or indeed even the mental activity involved in the process of rehearsing is verbal or pictorial or musical.

In the next two sections, the focus is on the effectiveness of covert rehearsal in different situations and on the different modalities in which covert rehearsal can be used, regardless of whether it is stimulus- or memory based or whether it is experimenter- or participant controlled.

III. EFFECTIVENESS OF COVERT REHEARSAL

In one sense, all rehearsal serves a function. For instance, simply repeating a set of phone numbers helps us remember them until we can dial them. But that involves only short-term memory recall. Usually, after a few minutes of distraction, we can no longer remember those numbers. Learning, however, often implies committing stimuli to long-term memory. We need to be able to think about other things and then still be able to remember what we had intended to learn. Thus, effectiveness of covert rehearsal refers to the success with which stimuli can be remembered later.

To this end, psychologists have made a distinction between rote and elaborate rehearsal. Usually, rote rehearsal

refers to simple repetition whereas elaborate rehearsal refers to using any other strategy such as imagery or organization. For instance, in 1973, F. I. M. Craik and M. J. Watkins showed that the amount of covert rehearsal engaged in with the intention of simply keeping a target stimulus in short-term memory had absolutely no effect on long-term remembering. In general, with verbal stimuli, such as lists of words or passages of text, covert rehearsal involving mindless repetition or shallow thinking, that is, rote rehearsal, is often quite ineffective in improving long-term memory compared to covert rehearsal involving thinking beyond the stimuli, that is, elaborate rehearsal. Indeed, M. Naveh-Benjamin and J. Jonides showed in 1986 that even when the stimuli themselves are not remembered, people can remember the frequency information; that is, when given a certain stimulus, they can remember the number of times that stimulus had been presented. Such frequency information, previously thought to be an automatically encoded aspect in memory, is also much better after elaborate rehearsal compared to rote rehearsal. In addition, using elaborate rather than rote covert rehearsal may tend to even change the qualitative nature of the memories, increasing or affecting the reporting of remember-type memories but not of know-type memories.

However, there do exist situations in which even elaborate covert rehearsal may not be effective. For instance, no amount of covert rehearsal, elaborate or rote, unless it is stimulus based, improves long-term implicit memory, that is when we are not consciously trying to remember the stimuli but our memory is measured indirectly by our performance on such tests as how fast we can read words off a screen or how well we can complete the missing letters of a given word. In such cases, the critical variable is the actual perceptual exposure to the stimuli, and silent thinking or covert rehearsal is entirely ineffective.

Psychologists have looked at the role of covert rehearsal also in a more global everyday memory setting while studying autobiographical memory and, more specifically, within the context of flashbulb memories. Although most silent thinking about real-life events tends to be in the form of inadvertent reminiscing rather than with the intention of improving our memory, such as when we keep reliving a championship game we participated in or cannot stop thinking about the last moments we spent together with a dying loved one, it is reasonable to suppose that such frequent and intense mental thinking or covert rehearsal is part of the reason why those moments may become flashbulb memories. Thus, exploring the assumed effectiveness of covert rehearsal in this context is also informative. In 1977, R. Brown and

J. Kulik postulated that rehearsal, both overt and covert, was an important variable in the formation of flashbulb memories for important public events, such as remembering, and never to forget, how we heard about John F. Kennedy's assassination. However, more recently, the effectiveness of rehearsal in the formation of flashbulb memories have been challenged by some researchers such as D. B. Pillemer in 1984, although these cases have dealt with primarily overt and "experimenter-controlled" rehearsal such as exposure to media coverage of the event. In a more recent study in 1997, A. İ. Tekcan and Z. F. Peynircioğlu specifically asked about the estimated number of times a person had thought about the event as well as the reception context to tell someone else about them. To the extent that the event was "thought about" first, such rehearsal has a large covert component. They found that this type of rehearsal did correlate with recall levels whereas strictly overt rehearsal such as exposure to media coverage did not. Thus, there is some evidence that in flashbulb memory research such rehearsal can indeed be effective and improve memory.

One area in which the effectiveness of covert rehearsal has been quite controversial is with nonverbal tasks, especially those relying on the performance of some skill. For instance, in 1989, C. A. Linden, J. E. Uhley, D. Smith, and M. A. Bush found no improvement in walking balance in the elderly following covert rehearsal of the actions. Similarly, in 1995, M. Lejeune, C. Decker, and X. Sanchez found no improvement in table-tennis performance in novice players following covert rehearsal, although covert rehearsal when combined with physical practice and observation did improve performance, and in 2000, D. R. Shanks and A. Cameron found no improvement in a sequential dot-location reaction time task following covert rehearsal. In 2000, Z. F. Peynircioğlu, J. L. W. Thompson, and T. B. Tanielian found that covert rehearsal did improve performance in free-throw shooting but not in a grip-strength task, whereas overt "psyching up" strategies improved performance in the grip-strength task but not in free-throw shooting. They concluded that covert rehearsal would improve nonverbal performance only when the task depended on the coordination of many fine and specific skills and not when the task depended on simple strength, focus, or concentration.

IV. COVERT REHEARSAL OF NONVERBAL MATERIALS

As mentioned earlier, covert rehearsal can improve performance in certain nonverbal physical tasks. Al-

though involving motor memory, improvement in such physical tasks has not been the focus of covert rehearsal studies for memory psychologists, however. Rather, the focus has been on exploring the effectiveness of covert rehearsal for remembering nonverbal stimuli in a list-learning or episodic-memory situation.

In 1980 and 1981 M. J. Watkins and T. M. Graefe explored whether effective covert rehearsal of pictures was possible. They presented pairs of thumbnail pictures or photographs of faces and after each pair cued one of the pictures for covert rehearsal. The cue came when the pictures were no longer present, thus the depth of initial encoding of the two pictures was held constant. They found that those pictures that were covertly rehearsed were better recognized than those that were not. In addition, they found that after a sequence of pictures were presented, and then any one of them cued for rehearsal, the rehearsed picture was better recognized than the others. Thus, the pictures could be conjured up in some fashion well after they had disappeared and covertly rehearsed in an effective manner. Later, in 1991, D. J. Read, R. Hammersley, S. Cross-Calvert, and E. McFadzen showed that in a face identification situation, just as with verbal materials, the timing of the covert rehearsal or how long after the presentation of the materials it occurred was crucial to its effectiveness.

Effective covert rehearsal was shown also in the nonverbal auditory domain, within the context of voice recognition. In 1982, M. J. Watkins and Z. F. Peynircioğlu presented pairs or sequences of short utterances, each utterance comprising a different phrase and spoken by a different though same gender person and afterwards cued one of these utterances for covert rehearsal. They found that the target voice in which an utterance was spoken was later more likely to be recognized among alternative same gender voices all saying the same utterance if the target utterance had been covertly rehearsed than not rehearsed. Later they also extended this finding from voices to natural sounds such as "thunder," "baby crying," or "a dentist drill." These natural sounds were also more likely to be recognized among alternative similar sounds if they had been covertly rehearsed than not rehearsed.

Thus, it appeared that nonverbal materials, whether visual or auditory, could be covertly rehearsed in an effective manner so that long-term memory for them was improved. What was unclear, however, whether such rehearsal was nonverbal in nature, as well, or whether people translated these nonverbal materials into verbal descriptions and then rehearsed these descriptions instead. To be sure, it would be quite cumbersome to label

or describe some of these materials, and the alternatives during the recognition test often shared similar verbal descriptions as the target materials. Nevertheless, a verbal rehearsal strategy with nonverbal materials could not be ruled out completely. To address whether effective nonverbal covert rehearsal was possible, in 1984, M. J. Watkins, Z. F. Peynircioğlu, and D. J. Brems presented participants with items that were depicted both pictorially and verbally. One half of these picture/word items were cued for rehearsal. For some of these cued items, participants were instructed to covertly rehearse the picture by keeping its image in mind after it disappeared from view, and for the other cued items they were instructed to covertly rehearse the name by silently repeating it. During the recognition test, one half of the verbally rehearsed items as well as one half of the pictorially rehearsed items were tested using a verbal measure, asking participants to complete fragments of words, and the other one half were tested using a pictorial measure, asking participants to identify degraded versions of the pictures. The results showed that covert rehearsal was effective only if the mode of testing matched the mode of rehearsal. That is, both verbal and pictorial covert rehearsal was effective, but it appeared that verbal rehearsal of an item did not improve memory for its pictorial depiction and pictorial rehearsal did not improve memory for its verbal label, showing that people were not simply translating pictures into words and rehearsing only verbally. Thus, effective covert rehearsal was possible in a nonverbal manner, as well.

Finally, in 1995, Z. F. Peynircioğlu looked at covert rehearsal of tones, materials that are quite difficult to label verbally for the layperson and thus are likely to be

rehearsed nonverbally. For simple pairs or triples of tones, even though physical repetition improved both short- and long-term memory and covert rehearsal improved short-term memory, covert rehearsal was quite ineffective for long-term remembering. That is, long-term memory for pitch or interval information alone could not be improved through silent thinking. Long-term memory for more complex musical materials such as 6-tone sequences or longer sequences with additional rhythmic information, however, did benefit from covert rehearsal. Thus, covert rehearsal of nonverbal materials can be effective and even carried out effectively in a nonverbal mode, but it seems that the to-be-rehearsed material needs to be meaningful or include many cognitive dimensions.

See Also the Following Articles

Assisted Covert Sensitization ■ Behavior Rehearsal ■
Coverant Control ■ Covert Positive Reinforcement ■
Covert Reinforcer Sampling

Further Reading

- Johnson, R. E. (1980). Memory-based rehearsal. In G. Bower (Ed.), *The psychology of learning and motivation* (Vol. 14, pp. 263–307). New York: Academic Press.
- Shorr, J. E., & Pennee R. (Eds.), (1989). *Imagery: Current perspectives*. New York: Plenum.
- Watkins, M. J., & Peynircioğlu, Z. F. (1982). A perspective on rehearsal. In G. Bower (Ed.), *The psychology of learning and motivation* (Vol. 16, pp. 153–190). New York: Academic Press.

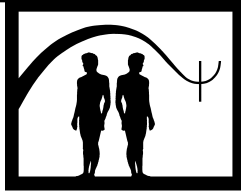

Covert Reinforcer Sampling

Patricia A. Wisocki

University of Massachusetts/Amherst

- I. Description of Treatment
 - II. Theoretical Bases
 - III. Empirical Studies
 - IV. Summary
- Further Reading

GLOSSARY

covert conditioning procedures A set of behavioral techniques that employ imagery as a way for clients to rehearse the performance of selected behaviors within the operant conditioning framework.

operant conditioning The process of increasing or decreasing the frequency of a behavior by altering the consequences that follow the performance of that behavior.

reinforcement An increase in the frequency of a behavior when that behavior is followed immediately by a particular contingent consequence.

reinforcer sampling The provision of a small sample of a potentially reinforcing stimulus in order to increase the use of the stimulus.

response priming Any procedure that initiates the first steps in a sequence of responses, and thereby increases the likelihood that the final response in the sequence will occur.

Covert reinforcer sampling is adapted from an operant conditioning technique (reinforcer sampling) that follows the principles and rules of the operant conditioning methodology, but has the stimulus presentation

occur via imagery instructions instead of by direct exposure to the stimulus. The covert reinforcer sampling procedure is designed to increase the number and range of reinforcing events available to clients by exposing them to the reinforcing elements of stimulus events or items without the direct manipulation of positive or negative consequences.

I. DESCRIPTION OF TREATMENT

Covert reinforcer sampling is employed in conjunction with other treatment interventions when the goal of therapy involves developing or strengthening reinforcers for a client. It is often used clinically with clients who are depressed and lacking access to or interest in pleasurable activities, clients who are living in environments in which stimulation may be severely lacking (e.g., in nursing homes, institutional settings), and for clients who frequently demonstrate a negative outlook on life.

The procedure is suggested for use after the therapist and client discuss the importance of a range of activities that a person may enjoy in his or her life and the problems that may develop from a limited venue of pleasurable experiences. Together the client and therapist develop a series of images that the client may find pleasurable, at least to a minimal degree. These images may involve activities (e.g., arranging a vase of flowers), settings (e.g., view of the mountains), interactions (e.g., shopping with a friend), or specific items (e.g., pictures

of grandchildren). The images may be about real or fantasized events, all of which occur on a low-frequency basis. The technique does not involve the presentation of either reinforcing or punishing consequences. The client is asked simply to imagine several of the agreed-on stimulus events in as much graphic detail as possible several times a day in blocks of 10 to 15 trials each time. It is important to include in the image as many different sensory aspects of the stimulus as possible (e.g., hearing the sound of the waves breaking on a beach, while seeing the sun setting on the water and tasting a hot dog). The stimulus material should be varied in order to avoid satiation of the reinforcer.

II. THEORETICAL BASES

Covert reinforcer sampling is derived from the operant conditioning procedure of reinforcer sampling, a variation on the technique of response priming, which is any procedure that initiates early steps in a sequence of responses. Reinforcer sampling is used to initiate the first steps in a low-frequency behavior by exposing the client to a small sample of the stimulus in order to encourage greater use of that stimulus. Once the behavior occurs on a consistent basis, the sampled reinforcer may be used to increase continued performance.

The adaptation of reinforcer sampling to an imagery venue is based on previous work with a large number of imagery-based behavioral procedures in which the client uses images to rehearse various behaviors and consequences in such a way as to produce a change in particular overt or covert activities. Many of these psychotherapeutic techniques were designed by Joseph Cautela, who referred to them as "covert conditioning procedures" and grounded them in operant conditioning methodology.

III. EMPIRICAL STUDIES

Covert reinforcer sampling has been evaluated in two case studies and one study in which it was compared with the traditional method of overt or direct reinforcer sampling. In the first case study, reported in 1976 by Patricia Wisocki, the procedure was employed along with several other behavioral techniques to help a client overcome a fear of social rejection. Covert reinforcer sampling was successfully used to help the client explore potentially reinforcing new social activities in order to enhance her social repertoire and increase the quality

and quantity of her social interactions. For example, in trying to interest the client in joining a hiking club, the therapist asked her to imagine the following scene:

Imagine that you are in the mountains on a cool, sunny day. Imagine that you are wearing heavy boots for walking, a backpack, a sweater, shorts, and a wide-brimmed hat. Imagine that you are walking with about five other people and you are all talking about the beauty around you. You see a stream nearby. It looks cold and inviting. You feel exhilarated—glad to be alive on such a day.

Scenes like this were inserted into each therapy session over a 3-month period, after which time the client became an active member of a hiking club, a church choir, an advanced French class, and a women's group. She met with friends two or three times a week, and planned and carried out social activities.

No attempt was made in this study to determine the efficacy of covert reinforcer sampling relative to the other procedures used with the client.

In the second case study, reported in 1993, Wisocki described the use of covert reinforcer sampling in a case of orofacial tardive dyskinesia experienced by a 77-year-old woman in a nursing home. The study took place over an 11-week period, including 2 weeks of an initial baseline, during which time the frequency of dyskinetic tongue thrusting movements was assessed during three 5-minute intervals during each morning, afternoon, and evening, for a total of nine intervals each day. That period was followed by 1 week of self-control instructions in which the client was asked to "try her best to relax her tongue" during the nine 5-minute sampling intervals taken in the original baseline condition. There was no decrease in the movements during this self-control phase. The tongue thrusting movements continued to occur at an average rate of 130 incidents during each 5-minute sampling interval. Relaxation training then took place over the next 2 weeks and resulted in a reduction in tongue movements to an average of 40 thrusts per interval. Covert reinforcer sampling was used during the next 2 weeks and resulted in a decrease of tongue movements to an average of 20 thrusts per interval. A second baseline, in which no treatment was provided but measurement continued, was implemented for 2 more weeks. Movements increased to an average of 60 thrusts per interval and continued at that level during the next 1 week when the client was asked to repeat the self-control instructions. Finally, the covert reinforcer sampling procedure was

reintroduced and resulted in a return to an average of 30 thrusts per interval.

Both the client and the staff working with her reported positive gains from the covert reinforcer sampling procedure. The content of the imagery scenes selected by the client stimulated discussion about the places depicted in them. They provided an occasion for the client to demonstrate her interests and showed her to have more socially endearing qualities than had been noticed previously by staff, which resulted in a reduction of the client's social isolation.

The additive design of this study did not allow for a test of the differential effects of the two interventions. Thus, it cannot be concluded that covert reinforcer sampling was more or less effective than relaxation.

Although the treatment was successful in reducing the number of dyskinetic movements, the client was not convinced that the efforts she was making to keep her tongue still were worthwhile and she demanded and received an increase in phenothiazine medication, which soon resulted in a return to severe tardive dyskinesia.

In 1980 Patricia Wisocki and Michael Telch examined the effects of covert reinforcer sampling and overt reinforcer sampling on the attitudes of a group of 56 college students, using a placebo group and a no-contact group as controls. The students' attitudes were first measured by an attitude scale. The 15 participants in the covert reinforcer sampling group were asked to imagine volunteering in a local nursing home and experiencing pleasure at interacting with the elderly residents. The imagery scene consisted of a description of a typical nursing home one would expect to encounter, including a description of various clients one might find in the setting. The scene went on to describe a positive encounter with a friendly older adult client and an ensuing positive interaction. The scene was read aloud three times during each of two 30-minute sessions and the participants were asked to imagine it in as much detail as possible for them.

The 12 participants in the overt reinforcer sampling group were taken to a nursing home and asked to interact with as many of the patients as they could during two 30-minute periods, an equivalent amount of time as given to the covert reinforcer sampling group. The 14 participants in the placebo control group were asked to imagine a scene depicting themselves volunteering to work with adults with mental retardation, using the identical procedure as provided in the covert reinforcer sampling group. The 15 students assigned to the no-contact control group simply completed the attitude scale before and after the study was completed.

Results indicated a significant increase in positive attitudes toward the elderly for both reinforcer sampling conditions. There were no changes in the attitude scale scores for the subjects in either control group. In comparing the two treatment groups, the researchers determined that the participants in the overt reinforcer sampling group increased their attitude scale scores significantly more than the participants in the covert reinforcer sampling group did. Further, participants who initially scored below the group mean on the attitude scale were found to respond significantly better to the overt reinforcer sampling procedure, while participants who initially scored above the group mean responded significantly better to the covert reinforcer sampling condition. Therefore, it appears that those subjects with an initially poor attitude toward older adults improved their attitudes more from direct contact with the population, while those with neutral or somewhat positive attitudes benefited more from the covert reinforcer sampling procedure.

IV. SUMMARY

Covert reinforcer sampling is an imagery-based procedure used therapeutically to increase the range and number of items and events that may be used as reinforcers for clients who experience a low frequency of pleasurable activities. It is derived from an operant conditioning paradigm. It has been shown effective in two cases where clients experienced a dearth of positive life experiences. It was also demonstrated to be equally effective as a direct reinforcer sampling condition in changing attitudes of college students toward elderly nursing home residents. Those in the direct reinforcer sampling condition, however, increased their attitude scale scores significantly more than those in the covert reinforcer sampling condition. Direct reinforcer sampling also appeared to be more effective with those participants whose initial attitudes toward the elderly were more negative, while covert reinforcer sampling appeared to benefit those whose initial attitudes were neutral or somewhat positive.

See Also the Following Articles

Assisted Covert Sensitization ■ Coverant Control ■ Covert Positive Reinforcement ■ Covert Rehearsal ■ Negative Reinforcement ■ Operant Conditioning ■ Positive Reinforcement

Further Reading

- Ayllon, T., & Azrin, N. (1968). Reinforcer sampling: A technique for increasing the behavior of mental patients. *Journal of Applied Behavioral Analysis, 1*, 13–20.
- Cautela, J., & Kearney, A. (1986). *The covert conditioning handbook*. New York: Springer.
- McInnis, T., Himelstein, H., Doty, D., & Paul, G. (1974). Modification of sampling-exposure procedures for increasing facilities utilization by chronic psychiatric patients. *Journal of Behavior Therapy and Experimental Psychiatry, 5*, 119–127.
- Wisocki, P. A. (1976). A behavioral treatment program for social inadequacy. Multiple methods for a complex problem. In J. Krumboltz & C. Thoresen (Eds.), *Counseling methods* (pp. 287–301). New York: Holt, Rinehart, & Winston.
- Wisocki, P. A. (1993). The treatment of an elderly woman with orofacial tardive dyskinesia by relaxation and covert reinforcer sampling. In J. R. Cautela and A. J. Kearney (Eds.), *Covert conditioning casebook* (pp. 108–115). Pacific Grove, CA: Brooks/Cole.
- Wisocki, P. A., & Telch, M. (1980). Modifying attitudes toward the elderly with the use of sampling procedures. *Scandinavian Journal of Behavior Therapy, 9*, 87–96.

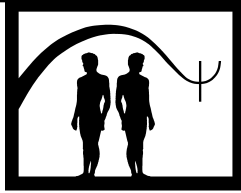

Cultural Issues

Edward F. Foulks

Tulane University School of Medicine

- I. Description of Cultural Issues and the Cultural Formulation
 - II. Theoretical Bases of Ethnic Identity
 - III. Theoretical Bases of Racial Identity
 - IV. Applications of Culturally Sensitive Psychotherapy
 - V. Empirical Studies of Psychodynamics and Culture
 - VI. Psychotherapy Specific to Cultural Groups
 - VII. Psychotherapy Technique and Culture
 - VIII. Transference—Countertransference and Culture
 - IX. Case Illustration
 - X. Summary
- Further Readings

GLOSSARY

countertransference An emotional reaction of the therapist toward the patient, usually meant to include two elements, which are the irrational feelings based on the therapist's unconscious mental organization, and the feelings and responses of the therapist in reaction to the patient's unconscious transference feelings toward the therapist.

culture The concept encompassing the collective knowledge, shared beliefs, values, language, institutions, symbols, images, and artistic works of a group that represent, signify or allude to these values, beliefs, and ideas and result in a shared world view.

cultural competency The awareness on the part of the psychotherapist of the various cultural factors influencing the behavior of the patient. These factors include the cultural identity of the individual, the cultural explanation of the individual's illness, cultural factors related to the psychosocial environment and functioning of the patient, and

cultural elements in the relationship between the individual and the clinician. The idea of competency includes the ability to use this information in treatment planning and crafting effective psychotherapeutic interventions.

cultural formulation The process whereby the ethnic/cultural identity of the patient is used in the process of diagnosis.

transference The emotional reaction of the patient towards the therapist, in which thoughts or feelings related to earlier stages of development are transferred to the therapist.

I. DESCRIPTION OF CULTURAL ISSUES AND THE CULTURAL FORMULATION

There has recently been an increasing awareness of ethnic diversity within almost every country of the world. This awareness and the advocacy of various ethnic groups for equality in multicultural environments have resulted in an emphasis on cultural competencies in medical education and practice.

Cultural competency in psychotherapy has become an explicit goal in all mental health disciplines in the United States and provides a benchmark of quality in the public mental health systems in California, New York, and many other localities serving large minority populations. Cultural competency in psychotherapy requires that the therapist develop knowledge and skills predicated on an attitude of receptiveness to "foreign" theories of illness and alternative pathways of healing such as is exemplified in the following case of Carlos:

Carlos is a 26-year-old Puerto Rican born man who was referred by a local spiritual healer in New York for medical and psychiatric workup. He had a skin rash that worried him to the point of despondency. Over the course of six months he had become more and more depressed and feared that he might be suffering a fatal illness.

Carlos was treated with psychotherapy, at first twice a week for two months and later weekly for eight months. He was also prescribed imipramine hydrochloride, orally, which was increased during a two-Week period to 150 mg at bedtime. His symptoms improved. Several weeks later, Carlos said that he was going to have a religious intervention at a session in his spiritual healer's church. His psychiatrist was invited to attend and observe the session. There were about 25 to 30 persons in attendance at the healing center. In the churchlike room, there was an altar with many statues of "Saints" from the Catholic religion. In front of the altar there was a table with numerous religious paraphernalia, such as collars, prayer books, bottles of incense, and a cup with water. After some consultation with others in attendance in accordance to the norms and rituals of the center, Carlos was called in for his spiritual/religious intervention. The spiritual healer told him that he had to pray regularly in order to be protected from bad spiritual influences. He was also told about the woman in the neighborhood who put the "root" on him, with the intention of separating him and his wife. His wife acknowledged that she had actually considered that possibility all along. Later on, the spiritual healer put a cream on his abdomen, and massaged the area supposedly affected by the "root." Then he applied a lotion in order to make his digestive system, especially his stomach, less vulnerable to "rooting." Additionally, the spiritual healer gave him and his family advice as to how to protect their home from bad spiritual influences using water and special herbs. At the end of the religious session, everyone prayed together on behalf of Carlos. Carlos' daughters were present in the session, as were also many other children who came with members of their families. He subsequently became a devout follower of this healing center religion. His religious conversion made his wife very happy, since she had always gone to the center alone or with her two daughters.

Cultural competencies have been addressed in the *Diagnostic and Statistical Manual of Mental Disorders* (Fourth Edition, DSM-IV), published in 1994. A special Task Force on Cultural Psychiatry was created by the American Psychiatric Association to identify "specific culture, age, and gender features" for each diagnosis in the DSM-IV. The Task Force emphasized that:

- Cultural pluralism has become a worldwide reality.
- Psychiatric diagnosis must be predicated on considerations of cultural factors.
- Cultural differences in the meaning of illness and of health put the clinician, who is unaware of nuances of the patients' behavioral-environment and belief system, in jeopardy of seriously misunderstanding.
- Misunderstanding can lead the clinician to judge variations in normal behavior, belief, and experience as psychopathology, when such is not the case.

The Cultural Formulation outlined in the DSM-IV focuses on the effects of culture on the expression of symptoms, definition of illness, and treatment considerations, and effectively enriches the traditional biopsychosocial model of treatment in psychiatry practice. The Cultural Formulation recommends that the clinician address the following factors involved in patient care:

A. *Cultural identity of the individual.* The clinician should specify the individual's cultural reference groups. Attend particularly to language abilities, use, and preferences (including multilingualism). For immigrants and ethnic minorities, note separately the degree of involvement with both the culture of origin and with the host or majority culture.

B. *Cultural explanations of the individual's illness.* Identify (1) the predominant idioms of distress through which symptoms are communicated (e.g., such as the case of Carlos—"nerves," possessing spirits, somatic complaints, inexplicable misfortune); (2) the meaning and perceived severity of the individual's symptoms in relation to norms of the cultural reference group; (3) any local illness category used by the individual's family and community to identify the condition . . . ; (see Part II of this Appendix, "Glossary of Culture-Bound Syndromes and Idioms of Distress" in DSM-IV); (4) the perceived causes or explanatory models that the individual and the reference group employ to explain the illness; and (5) current preferences and past experience with professional and popular sources of care.

C. *Cultural factors related to psychosocial environment and functioning.* Note culturally relevant interpretations of social stressors, available social supports (such as the spiritual center available to Carlos), and levels of functioning and disability. Special attention should be given to stresses in the local social environment and to the role of religion and kin networks in providing emotional, instrumental and informational support.

D. *Cultural elements of the relationship between the individual and the clinician.* Indicate differences in culture and social status between the individual and the clinician and problems that these differences may cause in

diagnosis and treatment (e.g., difficulty in communicating in the individual's first language, in eliciting symptoms or understanding their cultural significance, in negotiating an appropriate relationship or level of intimacy, in determining whether a behavior is normative or pathological, etc.).

E. *Overall cultural assessment for diagnosis and care.* The formulation would conclude with a discussion of how these cultural considerations specifically influence comprehensive diagnosis and care.

II. THEORETICAL BASES OF ETHNIC IDENTITY

The Cultural Formulation recommends that the clinician assess the ethnic identity of the patient as the first step in the process of diagnosis. This recommendation might seem familiar to most physicians, for they have been traditionally taught to begin the patient evaluation with "Identifying Information and Chief Complaint." Most clinical presentations begin with the phrase, "the patient is a 42-year-old, black male, who..." or "...is a 12-year-old, white female, who..." or "...is a 73-year-old, Hispanic male, who..." Such descriptors are taken for granted and by now have become almost universal in clinical conferences, ward rounds, and case reports. The ethnic/racial descriptor is most often ascribed by the examining physician rather than by the patient.

Eliciting the patient's self-perception of his or her own ethnic identity is, however, an important procedure in the diagnostic process and is also helpful in designing the treatment and management interactions that follow. How then does the physician validly describe the ethnic "identity" of the patient? The first step in this process is to ask the patient about cultural and religious backgrounds. Notice that the plural is used in "backgrounds," for the patient's mother and father may have different cultural origins. People who live in multicultural societies may have several ethnic traditions from which much of their identity is derived. In patients from minority cultural backgrounds, the identity acquired by the process of enculturating to mainstream American culture renders another layer of complexity. Modern mobility has resulted in many people growing up in different neighborhoods and even in different countries. This can add further dimensions to ethnic identifications. The dynamics of cultural influences on identity are as complex as psychodynamics are in the formation of personality. Although patients may be able to articulate some cultural influences with full aware-

ness, others may be so automatic and taken for granted that they are only discoverable by studied self-reflection and inference. In nearly all such cases, terms that we commonly use to categorize ethnicity may be too simplistic.

Giving the patient the opportunity to reflect on personal cultural identifications may allow for expressions that affirm the self and inform the clinician. Several caveats, however, must be considered in the process of assigning labels pertaining to ethnic identity. Much of the terminology now in official and common use to designate ethnic identity is actually quite questionable from a scientific perspective. For example, the ethnic categorization of people as black, Hispanic, Asian, and American Indian lacks precision and comparability because they have different referents; that is, Black refers to skin color; Hispanic to a language; Asian to a continent; and Indian to a heterogeneous group of aboriginal inhabitants within the United States.

Distinctions based on skin color have been used for purposes of social discrimination, oppression, and segregation. During the Reconstruction era following the Civil War, many families in the southern states were divided arbitrarily using the criterion of tone of skin color. Those members who could "pass" were considered "white," and those of darker hue were called "colored," "Negro," or "black." This issue remains problematic to their descendants to this day. Skin color is in fact a poor marker of ethnic or genetic differentiation.

"Hispanic" is another ethnic designator that is used as a political banner for many disenfranchised Americans but, like skin color, has dubious validity. "Hispanics," "Hispanic-Americans," or "Latinos" tend to be labeled as such regardless of country of origin and cultural background, thereby leading to clinical and research categories that are imprecise. "Hispanic" can apply to people from Spain or South America who speak Spanish. Are Spanish-speaking Filipinos to be considered "Hispanic" or "Asian"? Are Brazilians who speak Portuguese also "Hispanics"? Consider the cultural and possible genetic variability between "Hispanic" Argentinians of Jewish-European descent; Puerto Ricans of Afro-Caribbean descent; and Mexicans of Mayan Indian descent. All speak Spanish and are from "Latin" America. From the perspective of a racial grid based on skin color, one "Hispanic" group could be considered "white"; another "black"; and the third, "red."

Designations based on geographical place of origin are also inadequate indicators of ethnic identity. "Caucasian," "American Indian," "Asian American,"

and “African American” are examples of general categories used for this purpose. Caucasian refers to “white” people of European ancestry but would probably exclude those populations with epicanthic skin folds of the eye lids who actually live in the region of the Caucasian Mountains of Central Asia. “American Indian,” on the other hand, refers to a heterogeneous people from 260 different language groups, some descended from groups that migrated from North Asia during the last Ice Age and others, such as the Inuit (Eskimos), who have migrated more recently (witness recent arrivals of Eskimos from Siberia to Alaska). Ironically, these recent arrivals from Asian Siberia are not, however, considered Asian Americans.

The term Asian American commonly refers to people emanating from the Far Eastern countries such as Japan, China, and those of Southeast Asia, Vietnam, Cambodia, Laos, and Thailand. Asians from India, Pakistan, Iran, Iraq, Turkey, and so on, are usually not included in this category. Instead, they are often referred to as Muslims (a religious preference) or Middle Easterners, but as yet they have not been categorized as an official ethnic minority.

Without actively exploring these issues during the interviewing process, attributing racial and ethnic identities to the patient may be invalid and may even have pernicious results. For example, arbitrarily classifying patients according to perceived skin tones may not only identify but also reinforce historically derived categories of social discrimination and negative stereotyping. Therefore, clinicians need to be aware of and actively inquire about the patients’ self-attributions regarding ethnicity, race, social class, and religion. By exploring each of these items, the clinician can develop mutual understanding with the patient in regards to cultural and social influences on the mental disorder and its treatment.

III. THEORETICAL BASES OF RACIAL IDENTITY

There is no ready consensus these days as to what is meant by race, nor is there agreement on what is actually meant by “black” or “white.” The genetic heterogeneity of American society makes it impossible to define what is meant by race-linked terminology. In the southern United States it was census law that a drop of “black blood” made an individual black. However, it was commonly observed that a light-skinned woman

living as a black in one community might have an equally light-skinned sibling living as a “white” in another community where few had knowledge of the family’s relationships.

Despite such lack of precision and clarity with respect to racial classifications, race has taken on particular significance in the United States. The historical American experience with slavery has led to associating stereotyped concepts and stigma to dark skin. On the other hand, equally stereotypic notions of superiority and intellectual cleverness have come to be associated with light skin color.

The complexity of grouping people together on the basis of such arbitrary racial distinction is compounded by consensual identifications because of common cultural heritage. Hence, “blacks” can indeed look very different but still agree that they are African American in cultural outlook. Furthermore, only relatively recently has the notion of substantive variability in ethnic identity among blacks been examined. For example, one dark-skinned individual may be minimally Afrocentric and “mainstream” in political outlook, whereas another equally dark-skinned person may be resolutely Afrocentric. Some psychotherapists have observed that the same individual may change ethnic identity over the period of adult life with a Afrocentrism developing with maturity.

The importance of race as a dynamic factor in American life is practically ubiquitous in its effects, and the potentially problematic interaction between different racial groups is a significant element in practically every facet of life. Clinicians have come to recognize that race has some importance in the context of psychiatric practice, especially pertaining to the patient/clinician dyad and the clinician/supervisor dyad, which may be substantively influenced by racial considerations. Race can impact on clinical understanding, with significant consequences for the diagnostic process and ultimately for treatment decisions.

IV. APPLICATIONS OF CULTURALLY SENSITIVE PSYCHOTHERAPY

Cultural explanations regarding the nature and experience of illnesses are related to the initiation, process, and termination of psychotherapy. Patients often have cultural explanations for their stress and symptoms that differ from those of their psychotherapist. Many people who suffer from psychiatric disorders do not seek psychotherapy for this reason. Studies have shown

that patients who believe that their illness resulted from religious, magical, or other sources not considered valid by modern medicine were more likely to fail standard psychotherapy than those who shared a similar model of causation with their therapist. It is not uncommon in the cross-cultural treatment situation to hear patients state that religious problems contribute to their illness: that God is punishing them for past sins, that they are not in God's grace, or that their problems are God's will. Some patients believe that others have caused their sickness through voodoo or the "evil eye." Other examples of alternative nonmedical beliefs can be found in patients who follow modern popular health movements or who believe in traditional herbal practices that attribute psychological problems to imbalanced diets or to the toxic effects of sugar, meat, food additives, or other edibles. In contrast, patients who endorse medical model explanations and reject folk explanations of their psychiatric symptoms will be more likely to follow a psychotherapist's treatment advice. Similarity or difference in the explanatory model of the psychiatric illness between the psychotherapist and the patient may have a profound influence on the course of treatment. The use of psychotherapy in treating mental disorders that occur in nonmajority patients has therefore been a subject of consideration in planning psychiatric services. Many clinicians working with ethnically diverse populations have questioned several basic assumptions of psychotherapy as developed in Western Europe and the United States and its applicability to people raised in different cultural environments. For example, psychoanalytic psychotherapy is a talk therapy aimed at bringing insight and transformation to a personal, often unconscious, aspect of the individual self. According to this theoretical approach, even interpersonal relationships are "psychologized" and brought back for self-reflection in a person-centric construct focused on the individual as a unitary, active agent.

Some scholars in cultural psychiatry view this form of psychotherapy as a uniquely Western ethnotherapy that is best applied to those of this tradition (i.e., white, educated, middle class), and not used with members of other ethnic groups. A few might even regard psychoanalytic psychotherapy as a pernicious, harmful practice meant to reinforce the values of the elite majority while damaging further the self-esteem derived from traditional identity.

Although some of these arguments may be inspired by recognizing that self-esteem and identity are enhanced by the solidarity of accepting and identifying with one's ethnic or racial heritage, they ironically lend

support to the not-so-scholarly opinions of those psychotherapists who believe that, for a variety of reasons, minority or low socioeconomic status patients are not "good candidates" for insight-oriented psychotherapy. Such psychotherapists have observed that "minority" patients often express conflict by "acting out" rather than by verbalization and cognitive mastery, and that the early life traumas (common in lower socioeconomic status populations) preclude the more mature object-relational capabilities required for successful engagement in psychotherapy. Policymakers and agencies that are concerned with cost reduction in psychiatric services are also bolstered by these arguments to reduce basic psychiatric services to those who might most need them but cannot afford them.

Although psychotherapy has become an important treatment modality in general psychiatry, it has been for the most part reserved for the affluent members of society. Many surveys have revealed that minorities, particularly those of low socioeconomic status, receive less psychotherapy, for shorter periods of time, by less experienced staff.

A number of studies have indicated, however, that members of many major ethnic minority groups in the United States are as receptive to psychotherapy as members of the majority group. These studies find no differences between Mexican Americans and Anglo Americans in terms of referral, compliance, and resistance to psychotherapy, and they reveal that neither race nor ethnicity has any effect on the number of treatment sessions, treatment modality, or treatment environments. Some studies have also demonstrated the efficacy of culturally sensitive psychotherapy with Asian-American patients, refuting the cultural stereotype that Asians are unable to express themselves in emotional terms. It is well recognized by now that, even abroad in India and Japan, psychotherapy and psychoanalysis have obtained a valuable place as treatment modalities appropriately offered to many patients in these societies.

V. EMPIRICAL STUDIES OF PSYCHODYNAMICS AND CULTURE

Studies of the psychodynamics of people in Asian societies emphasize emotions as embedded in interpersonal relations, in which persons are rarely considered autonomous and separate from their society. Thoughts, feelings, ambitions, and desires are perceived to reside not in the individual, but in family and

close social networks. Some psychiatrists have reported that Japanese have no clear-cut conceptual demarcation between self and others. There seems to be “blurred ego boundaries” between self and significant others, which creates a sense of group identity rather than individual identity. The goal of one type of psychotherapy practiced in Japan (Nai-Kan—look within oneself) is to bring awareness to the patient of how ungrateful and troublesome he or she has been to parents, teachers, and benefactors. The patient is appropriately counseled as to how to show gratitude and alliance. In this process, patients realize that they have no right to expect that their personal wishes and desires will be gratified by others. Instead, they realize that they exist for the sake of others. Egocentric traits such as “sticking to a personal opinion” are seen to be neurotic and selfish. Therefore, the patient must come into harmony with group goals that may be equally assertive and competitive but will collectively serve the family, class, or company’s needs rather than personal needs.

Many Asian patients with such sociocentric orientations also have problems speaking to a psychotherapist about intrapsychic or interpersonal problems. They often have emotional and cognitive conflicts involving feelings of selfishness, ingratitude, and betrayal about considering such issues. Some psychiatrists have commented on the Asian patient’s desire to protect his “inner self” from exposure. Others have speculated that, in sociocentric societies, the inner self is undefined, with minimal referential vocabulary, or is psychologically undeveloped to the extent that the patient has little or nothing to report regarding an awareness of an inner self. Such patients will distrust talk therapy and, when severely symptomatic, will express their distress somatically rather than in psychological terms. Such presentations of illness may not only be defensive in function but may also reflect a context-dependent perspective in which organs, body parts, individuals, and groups are considered holistically balanced or imbalanced in a unified-interactive system.

Because many patients in Asian countries complain of somatic symptoms in time of distress, it is assumed that they lack psychological mindedness. Some studies have observed that the use of proverbs may provide a vehicle for expressing interpersonal and intrapsychic conflict. Asian societies use proverbs to express empathetic understanding and often point out dysfunctional defenses in a manner acceptable to the listener. Traditionally educated Vietnamese are required to memorize volumes of such verses, which are considered to be classics.

Many Vietnamese proverbs express psychological awareness of, and concern for, intrapsychic and interpersonal conflict. Proverbs are used to interpret and instruct family members and close friends in regard to their defensive handling of affects. In psychotherapy, proverbs are used in a gentle, indirect, nonconfronting way when approaching psychological or sensitive interpersonal issues, particularly in such culturally specific therapies as Nai-Kan and Morita.

VI. PSYCHOTHERAPY SPECIFIC TO CULTURAL GROUPS

Specific forms of psychotherapy practiced within unique cultural groups range from the laying on of hands and prayers that commonly occur in many Christian denominations to spiritual centers (*espiritismo centros*), evil-eye curing centers (*malocchio/mal de oio*), sweat lodges (southwestern American Indians), and root work (rural African-American communities), among many others. The merit of many of these culturally specific therapies is currently an issue of much interest and study, as at the Center for Alternative/Complementary Medicine at Columbia University. Culturally specific therapies often reaffirm traditional cultural values and reinforce group solidarity, providing support and identity to a patient in distress. In addition, many ethnic curing practices identify and explicate unique culturally related interpersonal conflicts that cause distress and provide mechanisms for appeasement or resolution.

As valuable as many of these specific cultural approaches may be for special and unique populations, their general applicability in multicultural environments seems limited. Some have suggested creating a broad array of culturally specific clinics or having each therapist or clinic achieve competence in administering the myriad culturally specific therapies required to bring an equal quality of mental health care to all diverse citizens. This would seem to be an organizational and quality assurance task of daunting proportions. In addition, sensitive civil rights issues may be encountered in triaging and assigning minority patients to culturally specific therapies, while majority patients are referred to standard treatments.

Integrating knowledge of the unique cultural values and beliefs into personal psychodynamics in the treatment of people from non-Western societies would seem to offer the most parsimonious and optimal approach to this dilemma. Familiarity with cultural traditions, val-

ues, and context as well as language ability are essential to such a cross-cultural psychotherapeutic enterprise. The following case study of a Japanese-American woman will illustrate these principles.

VII. PSYCHOTHERAPY TECHNIQUE AND CULTURE

The therapist's ability to listen openly in an empathetic, noncritical manner to what the patient is saying and to mutually decide on the goals of the treatment are fundamental to any treatment no matter what the ethnic group. These skills do not come naturally. Cross-ethnic psychotherapy must be self-consciously examined and learned. Psychotherapy requires that intimate conversations occur between socially distant individuals. In most cultures, intimate conversation is reserved for close family or acquaintances. Formal, polite, nonrevealing patterns of communication are used in conversations with outsiders. For example, it has been observed that bilingual Hispanic American patients tend to use Spanish at home and English in psychotherapy, even when the psychotherapist is bilingual. The formality of the treatment situation and the standardization of English by therapists enhance these tendencies. The patient in cross-ethnic psychotherapy may therefore establish early transferences based on previous formal relationships (e.g., with English-speaking teachers, store clerks, and ministers) where self-disclosure was kept to the minimum required to transact an interaction. One approach used in cross-ethnic psychotherapy to overcome this resistance is having the therapist use the more informal language when possible. Another is to discover with whom the patient does share personal information, contrast this mode of sharing with the more formal conversations in treatment, and ask that the patient talk in therapy as they talk to their confidants.

It may also be useful for the therapist to pay particular attention to and learn ethnic colloquialisms that characterize the patients' informal conversational style. Generally, the more knowledgeable the therapist can become regarding differences in use of vocabulary, communicative gestures, expressions of distress, and personal-culturally based values, the better will be the therapeutic alliance. For example, incorporating "dichos," or sayings that exist in Mexican-American and other Latino cultures, into psychotherapy provides useful approaches to mitigate resistance and reframing problems.

In addition to attending to the cognitive aspects of cross-ethnic psychotherapy, therapists should also become aware of their own unconscious reactions to patients of another race or culture. White therapists, for example, have been found to make more errors in speaking and have less forward lean, eye contact, and shoulder orientation when working with black patients. Body language may carry culturally specific meanings that can be easily misinterpreted and warrants exploration and understanding in cross-ethnic psychotherapy.

VIII. TRANSFERENCE-COUNTERTRANSFERENCE AND CULTURE

Cultural differences may fascinate the therapist and distract treatment from the reality of the patient's core conflict to inquiries of a more anthropological nature. An example is in the vignette of psychotherapy with a Brazilian-American patient, where substantial time was spent discussing cultural meanings of colorful and affect-laden interactions with friends during Carnival, while the patient's defensive use of hypomania was overlooked.

Conversely, many therapists deny that cultural differences have any relevance to psychotherapy, and they believe that all patients are or should be "just like me after all." The exuberance of this revelation may often pave the way to unwarranted assumptions regarding social values that may interfere with an insightful-empathetic enactment of mutual goal setting in cross-ethnic psychotherapy. In such cases, the therapist may overlook the special needs associated with specific minority membership to the point of cultural insensitivity.

Matching therapists and patients by race or ethnicity has been suggested as one way of avoiding such difficulties and facilitating the formation of the therapeutic alliance in work with ethnic subgroups.

For example, when African-American patients are matched with African-American psychotherapists, the therapists are less likely to misinterpret lifestyles as pathologic, and instead will readily recognize the strengths and positive aspects. For some patients the African-American therapist may be better able to evaluate the role of "black reality" as actual rather than as a defense or resistance to change. Such relatedness and understanding contribute to better rapport, communication, and empathy with the social reality of the patient.

Matching of therapist and patient also has its pitfalls. For example, African-American therapists can become overly concerned with the sociopolitical factors involved in their patients' dysphoria. This concern may result in emphasizing black political solidarity and perspective rather than focusing on the "personal" and familial problems unique to their client's life. Some therapists may reject "white theories" and propose theories that carry an overt or implicit political message. They may convey the message to the patient in a familiar moralizing, preacher fashion attempting to enlighten the patient regarding the social injustices he or she has endured. Some authors refer to the "blacker than thou" stance manifest in such countertransference reactions. Some patients who reject their own blackness may also project their own lack of self-esteem onto the therapist whom they erroneously perceive to be lacking in ability. Especially vulnerable may be patients who grew up in white neighborhoods. Such issues are explored most effectively, and the therapeutic alliance is enhanced by carefully working with the patient to help unfold the patient's personal life's story and to examine the patient's denied or repressed feelings and conflicts.

An "Afrocentric" approach to psychotherapy with African-American patients has been proposed as a way to recognize African influences in our society. This approach stresses person-to-person relationships, style and use of language, strong emotional expressiveness, and the spiritual orientation of blacks. Alternative forms of healing have also been advocated based on African traditional practices and folkways. These are explored and revitalized for use in current treatment programs.

Although ethnic minority patients may often prefer to be treated by therapists from their own ethnic/racial group, skin tone might have minimal relevance to shared cultural beliefs, values, and behaviors. For example, a Jamaican-American therapist of Rastafarian tradition may have few cultural values in common with a "black patient" whose father is a law professor and whose mother is Irish Catholic. In such a case, the status of the development of global racial identity may or may not be the core issue essential to treatment.

Defining "what is being matched" in matched versus mismatched therapeutic relationships is often accomplished by distinguishing ethnic and racial variables "distal" from those "proximal" in the treatment situation. Many studies of matching therapist and patient have used indicators that are distal (or remotely relevant) to the actual treatment situation. Distal indicators

might include skin color, declared ethnic identity, languages spoken, countries of origin, religion, and so on. Those factors may only superficially indicate the mutual values, behaviors, beliefs, and attitudes actually manifested in a shared therapeutic relationship. These factors are the proximal indicators of a therapist-patient match and are crucial to the valid assessment of outcomes. From this perspective, it is the actual behaviors and attitudes manifested within the treatment itself that determine the therapeutic alliance, the accuracy of interpretations, and the ultimate outcome. In this case, a match of therapist and patient is based on measures of the process of therapy itself rather than on global or declared ethnic/racial attributes of the parties involved.

In contrast, matching on the basis of superficial descriptors, such as nationality or race, indicates little about the ethnic identity, cultural orientation, or racial/ethnic group identifications of either the patient or therapist. The importance of designing therapist-patient matching strategies in terms of the substantive constructs underlying definitions of racial identity and culture, rather than superficial labels, is indicated by studies showing that therapist-patient similarities of values, locus of control, and semantic differentials are related to better outcome. In addition, studies showing that better outcome is related to similarity of demographic variables, such as marital status and socioeconomic status, indicate the importance of distinguishing ethnically specific matching variables from other characteristics that may influence the results of treatment.

Another apparent variable in the outcome of matching patient and therapist is the therapist's clinical skill. Many studies that attempt to determine the influence of ethnic matching on outcome are hampered by insufficient assessment of therapist competence as distinct from other therapist-related variables, including ethnicity. One methodological approach for estimating therapist competence, adopted by technological models of psychotherapy research, involves an independent rating of therapist adherence to the guidelines of operationalized treatment manuals. This methodology allows process-oriented evaluations of therapist behaviors and the degree to which they conform to the technical and theoretical parameters of the particular therapy model. Exclusive reliance on process variables allows specific measurements of treatment integrity and therapist performance as distinct from other therapist characteristics and independent of outcome assessment. Research strategies that specifically measure therapist adherence may, therefore, represent useful tools for researchers attempting to identify the separate contribution of therapist-patient ethnic

matching on outcome. These strategies may provide an initial methodologic framework to consider how culturally responsive activity by the therapist may be necessary in cross-ethnic therapies. In this manner, subcultural studies in the future might illuminate how culturally responsive adaptations intrinsic to the psychotherapeutic frame and process affect outcome.

IX. CASE ILLUSTRATION

Kimiko, a 26-year-old Japanese woman married to an American man, will serve as an example of how the unique experience of the self as embedded in family relationships can contribute to conflict in acculturating to a multicultural society such as that of the United States.

Kimiko had moved to the United States with her husband at the age of 23. Kimiko's reasons for beginning psychotherapy were depressed feelings and a lack of *Jibun* ("me" as a target of cognitive intentionality) or *Jiko-ishi Ki* (self-awareness). This lack showed itself as (1) inability to make choices when she had to express a personal preference; (2) her feeling that there was nothing to which she would like to fully devote herself; and (3) her sense that she was only able to pursue her own happiness indirectly by doing things for others that resulted in their happiness. Kimiko underwent 100 sessions of psychoanalytic psychotherapy with a Japanese psychoanalyst in the United States. A general theme of Kimiko's therapy was her discovery of self. Transference issues included a desire for a responsive, affectionately strong father. This desire was conditioned by Kimiko's relationship with her father who had been "reticent" or "absent." There was also an important maternal transference based on Kimiko's attachment to a nurturing and open relationship with her mother. The therapist was highly idealized in this regard, especially early in treatment. During her sixth hour of psychotherapy, Kimiko talked about her relationships with her mother, husband, and others:

Two days before my anniversary I received from my grandmother a card and a check from my mother. I know they always do something for me. But I was happy to receive so much from them even though I am economically independent ... They would be pleased to learn how I spent the money. ... They are always behind me. I can depend on them should something happen ... am not completely independent ... if an emergency happens I can receive help from them. I feel that this is *Amae* [dependency]. Even though I do not

meet them every day they are in my mind and when I feel lonely, I turn to them. I consider this as *Amae*.

Kimiko also reported a number of dreams during her psychotherapy. One of these dreams particularly captured her core conflictual relationship them: "My mother is seen far away. I wanted to call her but I could not vocalize. Her leaving home with somebody was seen remotely. I wanted to call her attention but I could not emit my voice."

Kimiko had separated from her family and culture when she moved to the United States with her husband. Themes of separation and dependency (*Amae*) are repeatedly experienced in her treatment. In addition, she complains of the lack of a sense of self, and her narrative reveals her embeddedness in the supportive family network. In the context of the United States, where independence of self is considered an asset, Kimiko feels particularly disadvantaged.

Therapists must be alerted to recognize when such contrasts occur between their own values and assumptions and those of their patients. Psychotherapists are advised to share their patients' world-view without negating its legitimacy. In the case of Kimiko, such a compromise was not an issue because she herself complained about her dependency and lack of sense of self. If Kimiko, with her depression, had experienced *Amae* as ego-syntonic, even laudable in terms of Japanese social values, the therapeutic process might have necessarily taken another course. In any case, the therapist may not be able to completely understand the patient's values but should be able to explore them empathetically and nonjudgmentally in a working, therapeutic alliance.

X. SUMMARY

The DSM-IV Cultural Formulation indicates essential principles of cross-ethnic and cross-cultural diagnosis of mental disorders. These principles include:

Knowledge of the concepts employed in studies of language, culture, and medical anthropology. Such concepts should be applied to the clinical context and include understanding:

- cultural concepts of world-view, emic-etic, values, and norms (ideal and behavioral);
- linguistic concepts of denotation-connotation, translation-interpretation, idioms and local jargon and referents;

- medical anthropology concepts of cultural “idioms of distress,” and cultural conceptions of illness and illness presentation.

Therapists must understand how culture and ethnicity can modify the importance of work, family, illness, and death in the lives of their patients. They should appreciate the ideal cultural norms with regard to family organization and loyalty (e.g., patriarchal-matriarchal authority, patrilineal-matrilineal inheritance, and patrilocal-matrilocal-neolocal residence). They should recognize when an illness represents a personal failure or moral lapse in the sufferer; when it suggests the action of a malevolent spirit that has been offended by the patient or a family member; when illness raises the question of a curse by an enemy; when the patient fears death from the malady; and in the patient’s culture, what follows after death.

Therapists should also appreciate the existence of certain culture-bound or culture-related disorders. They should understand the concept of pathoplasticity and the role played by culture in certain psychiatric conditions (e.g. eating disorder, substance-related disorders, and various somatoform, hysterical, or crisis-induced states).

Skill in the following areas:

- Diagnostic interviewing across ethnicities and cultures; methods of establishing rapport; the importance of facilitation and clarification; potential problems associated with confrontation and interpretation and education; ethnic differences in eye contact and interpersonal space (or “body envelop”) and nonverbal communication.
- Patient versus family interviewing; cultural differences regarding confidentiality and privacy; presence of a family member during assessment.
- When to use an interpreter; preparation for becoming an interpreter; conceptual models regarding interpreters; differences between translators and interpreters; problems in being an interpreter; and how to facilitate the work of a translator.

Patients’ histories can be approached in terms of their personal, family, and cultural histories. These histories are held by the patients as constructs, which can be detected by the use of keywords used over and over as they interact with the clinician. Family cultural background can be elicited from the patient’s personal explanation and meaning of the family’s developmental history through the generations. Another method of eliciting cultural identity is by using an interpersonal matrix that

involves assessing the patient’s viewpoint of particular topic areas—such as demographics (age, gender, and location), status (social, educational, and economic), and affiliations (ethnic, religious, and family)—and the behaviors, expectations, and values associated with these factors. This model helps the therapist understand that behavior can have different meanings depending on the patient’s ethnic identity and cultural perspective.

Attitude: Therapists should also be able to appreciate their own ethnicity and their ethnocentricity. They should appreciate the ethnicity of their patients and remain sensitive to the world-views of others. In particular, they should recognize how their own ethnocentricity may interfere with therapy and psychotherapy.

Therapists should be able to recognize that not all unfamiliar traits, behaviors, thoughts, or emotions in a patient are necessarily the result of psychopathology. Similarly, they should be able to consider that the unfamiliar dimensions of a patient may not be simply cultural in origin. Perhaps most important, the therapist must be able to recognize and deal with cultural countertransference, negative and/or positive.

The guidelines provided by the Cultural Formulation of the DSM-IV are fundamental to diagnosing and treating patients in a multicultural society. The cultural issues encountered in psychotherapy are especially dependent on these fundamentals.

See Also the Following Articles

Countertransference ■ Feminist Psychotherapy ■ Humanistic Psychotherapy ■ Multicultural Therapy ■ Race and Human Diversity ■ Transcultural Psychotherapy ■ Transference ■ Women’s Issues

Further Reading

- Alarcon, R., Foulks, E., & Vakkur, M. (1998). *Personality disorders and culture: Clinical and conceptual interaction*. New York: John Wiley & Sons.
- American Psychiatric Association. (1994). *Diagnostic and statistical manual of mental disorders (DSM-IV)*, 4th ed. Washington, DC: APA.
- Foulks, E. (1980). The concept of culture in psychiatric residency education. *American Journal of Psychiatry*, 137, 811–816.
- Foulks, E. (1991). Transcultural psychiatry and normality in the diversity of normal behavior. In D. Offer, & M. Sabshin, (Eds.), *Fourth contributions to the evolution of scientific normatology* (pp. 227–239). New York: Basic Books.
- Foulks, E., Bland, I. J., & Shervington, D. (1995). *Cross Ethnic Psychotherapy. Annual Review of Psychiatry*. P. Ruiz, & J. Oldham (Eds.), Washington, DC: American Psychiatric Press.

- Foulks, E. & Pena, J. (1995). Ethnicity and psychotherapy in the treatment of cocaine addiction. *The Psychiatric Clinics of North America*, 18(3), 607–620.
- Foulks, E., Persons, J., & Merkel, L. (1986). Illness beliefs and compliance in psychotherapy. *American Journal of Psychiatry*, 143, 3.
- Group for the Advancement of Psychiatry (GAP) Report 141. (1996). *Alcoholism in the United States: Racial and ethnic considerations*. Washington, DC: American Psychiatric Press.
- Nguyen, N., Foulks, E., & Carlin, K. (1991). Proverbs vs. psychological interpretation among Vietnamese. *Asian Folklore Studies*, 50, 311–318.



Danger Ideation Reduction Therapy

Mairwen K. Jones and Ross G. Menzies

University of Sydney

- I. Description of Treatment
 - II. Theoretical Bases
 - III. Empirical Studies
 - IV. Summary
- Further Reading

Therapy (DIRT) and discusses its therapeutic effectiveness by reviewing the DIRT treatment trials that have been conducted to date.

GLOSSARY

cognitive-behavior therapy A therapeutic approach designed to change mental images, thought patterns and behaviors to help sufferers overcome emotional, behavioral, and psychiatric problems.

danger ideation reduction therapy (DIRT) Developed by Mairwen K. Jones and Ross G. Menzies in the mid-1990s. DIRT is a cognitive-behavioral treatment package for OCD sufferers who experience contamination obsessions and washing compulsions. It solely aims to decrease danger-related expectancies concerning contamination and disease.

obsessive-compulsive disorder (OCD) An anxiety disorder characterized by persistent and unwanted thoughts or images, and impulses to carry out repetitive behaviors or mental acts. Obsessions about contamination and compulsions involving washing are particularly prevalent in sufferers.

This article presents a brief description of the expectancy model that underpins this treatment approach and outlines the empirical findings related to this account. It also provides a description of each of the six treatment components of Danger Ideation Reduction

I. DESCRIPTION OF TREATMENT

Danger Ideation Reduction Therapy uses a variety of techniques to decrease patient estimates of the probability of dangerous outcomes. DIRT procedures include cognitive restructuring, filmed interviews, corrective information, microbiological experiments, a probability of catastrophe estimation task and attentional focusing. A core tenet of DIRT is that clients perform compulsive washing behaviors in response to faulty beliefs about contaminants in the environment and the ease with which contact with “contaminated” stimuli will lead to illness. Each component of DIRT aims to decrease the patient’s belief in the likelihood of dangerous outcomes with respect to contamination. DIRT does not involve exposure and response prevention or employ pharmacotherapeutic agents. In addition, DIRT differs from other cognitive therapy approaches to OCD because all maladaptive beliefs other than exaggerated threat expectancies are ignored by the package.

A. Cognitive Restructuring

This procedure combines features of systematic rational restructuring developed by Marvin Goldfried in

the mid-1970s and rational-emotive therapy developed by Albert Ellis and introduced in the early 1960s. The therapist encourages the patient to identify unrealistic thoughts related to contamination/illness and teaches the patient to reevaluate these thoughts, changing them to be more realistic and appropriate to the demands of the situation. Once constructed, participants are asked to rote-learn their reappraisals, reading and copying them on a daily basis. In later sessions, participants are shown how to apply their reappraisals to novel situations.

B. Filmed Interviews

This component involves the presentation of filmed interviews with workers employed in a range of occupations which involve regular contact with contamination-related stimuli. Occupations include house cleaning, laboratory work, printing, gardening, banking, and nursing. Each interviewee describes in detail the frequent contact with OCD-related stimuli (e.g., chemicals, garden soil, animal hair, bodily fluids, money). Interviewees are then asked about their health and level of sick leave over the course of their employment. The therapist highlights the absence of work-related illnesses in each interviewed employee.

C. Corrective Information

This component involves the presentation of a list of facts related to illness and death rates in various occupational groups (e.g., the number of health care workers who had occupationally contracted HIV). The information provided to clients highlights common misconceptions about illness and disease and the ease with which a variety of conditions can be contracted. Additional information is provided to participants concerning the problems inherent with excessive hand washing. This includes a one-page microbiological report that explains how vigorous washing can damage the integrity of the skin, causing cracks and fissures that break down the protective barrier to infection.

D. Microbiological Experiments

In this procedure the therapist discusses the results of a series of microbiological experiments concerning contamination. The experiments involved the researchers “contaminating” one hand by touching a number of stimuli commonly found to be anxiety provoking to OCD washers, (including garbage bins, toilet doors, and animal hair), while the other hand acted as a control.

Fingerprints from both hands were imprinted on sheep blood agar plates. Following the description of the experiments the therapist directs the patient to the research report findings which state that no disease-causing organisms were isolated from fingerprints on the sheep blood agar plates following contact with OCD-relevant stimuli. No potentially pathogenic organisms were isolated on either the control or the experimental task plates. The microbiological report concludes that none of the tasks involved contamination of the hand with any organisms that were other than normal commensal flora of the skin. Discussion of the results focuses on challenging patient’s previous excessive risk estimates associated with these tasks.

E. The Probability of Catastrophe

As described by Rense Hoekstra in 1989, this procedure involves comparing patient estimates of the probability of a negative outcome with an estimate derived from an analysis of the sequence of events that might lead to the feared outcome. Behaviors, such as throwing out the garbage, are broken down into the sequence of events required for contamination or illness to occur (e.g., bacteria present on garbage bin, bacterial transfer to hand, bacteria entering the body, initial immune system failure). Probability estimates for each step in the sequence are given by the participant. These are multiplied together to give a new estimate of the likelihood of illness. The therapist highlights the inconsistency between the patient’s initial elevated global estimates and those lower probability estimates obtained using the probability sequencing task. Homework consists of applying this method to novel situations.

F. Attentional Focusing

This use of this procedure, which is essentially a basic breathing meditation task, was described in detail in 1985 by Chris Clarke and Wayne Wardman. It involves a focusing task that aims to decrease the occurrence of danger-related intrusive thoughts by increasing the participant’s ability to attend to alternative cognitive targets in a rhythmic breathing exercise. Participants are taught to focus on a series of numbers while breathing in and to focus on the word “relax” while breathing out. Participants are instructed to breathe normally and not to slow or speed up the respiration rate. Participants initially train with their eyes closed in a quiet location with minimal noise and distraction. As training progresses across sessions, participants are instructed to increas-

ingly complete their daily focusing sessions in noisier environments while keeping their eyes open. Daily practice consists of two, 10-min focusing sessions.

II. THEORETICAL BASES

A number of models of anxiety propose that expectancies of danger are involved in the mediation of normal fear reactions and clinical anxiety and avoidance. Threat-expectancy accounts of the anxiety experienced by sufferers of OCD have been proposed for a number of decades. For example, in 1974 Anthony Carr argued that patients with OCD make very high subjective estimates of the probability of aversive outcomes. That is, they may more often anticipate danger or negative outcomes than nonobsessives in the same settings. The performance of compulsive behaviors is said to lead to the relief of anxiety through the reduction of the subjective threat.

Such expectancy models seem particularly relevant to OCD because researchers and clinicians have frequently identified themes of danger in the obsessional beliefs of sufferers of OCD. In addition, many patients with OCD are able to specify negative outcomes associated with not performing their rituals, for example contamination and disease for sufferers who fail to execute washing behaviors. Given this, theorists like Carr have argued that danger expectancies may mediate the anxiety and avoidance experienced by the sufferer of OCD. In two studies reported in the literature in 1997 and 1998, Jones and Menzies investigated the validity of an expectancy account of OCD with a focus on those sufferers whose dominant concerns involve contamination obsessions and washing compulsions.

In the first study, Jones and Menzies examined the potential mediating roles of danger expectancies and other cognitive variables that have been hypothesised to play a role in OCD, including responsibility, perfectionism, anticipated anxiety and self-efficacy. They obtained ratings from 27 patients with OCD before and during a Behavioural Avoidance Test (BAT) involving a compound stimulus of potting soil, animal hair, food scraps, and raw meat. Correlation and partial correlation analyses were conducted to investigate the relationships between the cognitive predictor variables and urge to wash, level of anxiety, time spent engaged in the task, and duration of washing in the posttest phase.

The researchers reported significant relationships between danger expectancies and each of the dependent measures. That is, correlations between BAT estimates of

danger and anxiety, urge to wash, and time washing were positive, significant, and moderate to high in size. Correlations between BAT estimates of danger and time in dirt were negative, significant, and moderate in size. Partial correlations were conducted between the postulated mediating variables and the four dependent variables, with alternative mediating variables held constant. Severity of disease or illness ratings were found to remain significantly related to all four dependent variables when non-danger variables were held constant. Likelihood of disease ratings remained significantly related to three of the four dependent variables when non-danger variables were held constant. The only relationship that appeared tenuous was between likelihood of disease ratings and time washing, which disappeared when self-efficacy or responsibility ratings were held constant. No alternative cognitive variable was found to be related to any of the four measures of OCD washing in partial correlation analyses when danger expectancy ratings were held constant. More important, the four dependent variables chosen covered a range of the prominent symptoms displayed by OCD washers, from subjective urges and distress to actual avoidance and excessive washing. The ability of danger expectancies to relate to all aspects of the disorder in this study was argued to provide considerable support for danger-based models of the condition.

Following this study, the BAT stimulus was utilized in a second experiment aimed at assessing the role of danger expectancies in OCD washing. In this study Jones and Menzies manipulated the perceived level of danger in the BAT by varying the pre-BAT instructions given to 18 participants. Participants were randomly allocated into a high-danger instruction condition or a low-danger instruction condition. In general, the data obtained were again consistent with a danger expectancy account of OCD washing. That is, as Jones and Menzies had hypothesized, participants in the high-danger instruction condition were found to have higher mean ratings for anxiety and urge to wash and showed greater avoidance and posttest hand washing than participants in the low-danger instruction condition. These differences were significant for time spent washing post-BAT and BAT duration. For this last variable, while all the participants in the low-danger condition were able to keep their hands in the container for the whole 5-min task, four of the nine participants in the high-danger condition withdrew their hands prematurely. Clearly, the fact that a task perceived as more likely to contaminate could lead to significantly increased washing and avoidance is supportive of disease-based models of OCD washing.

III. EMPIRICAL STUDIES

Since the development of DIRT, Jones and colleagues have carried out three studies examining its effectiveness. In the initial treatment trial, which was published in 1997, three patients with OCD whose primary concern involved contamination/washing were selected for the study after presenting at the Anxiety Disorders Clinic of the University of Sydney. At intake each patient had refused standard behavioral intervention (i.e., response prevention). Treatment consisted of between six and ten 1-hour weekly sessions. Treatment was terminated in each case when, in the judgment of the treating clinician (a) clinically significant gains were apparent with minimal symptomatology remaining, and (b) clients displayed a sound grasp of the cognitive model underpinning DIRT procedures. Substantial reductions on all four outcome measures were experienced by the three participants at posttreatment. Posttreatment scores on two of these OCD measures, the Maudsley Obsessional–Compulsive inventory (MOCI) and the Padua Inventory, were lower than typical group means for participants receiving exposure and response prevention in clinical outcome studies and were similar to scores obtained by “normal” control participants in several reports. On the basis of these results, Jones and Menzies argued that the DIRT package may prove useful in achieving and maintaining clinically significant improvements in OCD washers.

In a second study conducted by Jones and Menzies, 21 sufferers of OCD with washing/contamination concerns took part in a controlled DIRT treatment trial. Eleven of the participants received DIRT during eight, 1-hour weekly group sessions. Ten participants were placed on a wait list and did not receive DIRT or any other treatment. All participants were assessed at pretreatment, posttreatment, and 3-month follow-up using the Maudsley Obsessional–Compulsive inventory, Leyton Obsessionality inventory, Beck Depression Inventory, and a Self-Rating of Severity Scale. Participants who received DIRT showed significantly greater reductions in symptomatology from pretreatment to after treatment on all four outcome measures than participants who were in the control condition.

The researchers note that although clinical improvements were obtained in this controlled trial, these were not as large as anticipated. In particular, the posttreatment average MOCI score was higher than typical group means for participants receiving exposure and response prevention in clinical outcome studies and considerably higher than scores typically obtained by

“normal” control participants. Therefore, the findings from the second trial of DIRT were not as convincing as those found in the first DIRT trial.

Jones and Menzies suggested a number of reasons to account for the discrepancy in treatment effectiveness between the two DIRT trials. It was suggested that DIRT may be more beneficial when presented in individual sessions in which the therapist is more aware of the dysfunctional beliefs of the individual client and can then help the client identify suitable reappraisals. Also, participants may have been hesitant to discuss their concerns or ask for clarification of techniques in front of other group members. Finally, although the three participants in the first DIRT trial received treatment until clinically significant gains were apparent with minimal symptomatology remaining, this condition was not used as a guide to terminate treatment in the second trial. Instead, before the trial commenced the treatment protocol specified that treatment would involve eight sessions, regardless of clinical gains or the client’s understanding of the model underpinning DIRT procedures.

Annette Krochmalik, Mairwen K. Jones, and Ross G. Menzies conducted a recent trial of DIRT with severe, treatment-resistant cases of compulsive washing. The researchers examined the effectiveness of DIRT in five patients with OCD who satisfied *DSM-IV* criteria for OCD with Poor Insight. All patients were classified as treatment resistant, because they had failed to respond to at least two separate, 12-week drug trials using serotonergic agents and had also failed to respond to at least 15 sessions of exposure and response prevention just prior to being offered the DIRT intervention.

Unlike the previous controlled DIRT trial that involved group therapy, Krochmalik, Jones, and Menzies returned to an individual treatment format. Participants received a maximum of 14, weekly 1-hour DIRT sessions. Again, treatment was terminated earlier if clinically significant gains were apparent with minimal symptomatology remaining and clients displayed a sound grasp of the cognitive model underpinning DIRT procedures. Based on this criteria, the five participants received between 9 and 14 sessions in total.

The trial utilized four self-assessment measures (the Maudsley Obsessional–Compulsive inventory (MOCI), the Padua Inventory (PI), the Beck Depression Inventory-II (BDI-II) and the Self-Rating of Severity Scale), and one clinician-rated measure, the Global-Rating of Severity. Using the two-fold criteria of Neil Jacobson and Paula Truax, each participant was able to be classified as unchanged/deteriorated, improved but not recovered, or

recovered on three of the measures (the MOCI, PI, and BDI-II).

The researchers reported that at the post-DIRT assessment phase four of the five participants exhibited reliable decreases in scores on all measures. These improvements were maintained at 4 to 6-month follow-up. In addition four of the five cases met the criteria for recovery on the MOCI and the PI and three of the five cases met the criteria for recovery on the BDI-II at the follow-up assessment phase.

In summary, while one of the five participants did not benefit from DIRT, the other four participants did respond well to this recently developed treatment approach. Given that all four had previously been non-responsive to standard treatment interventions the authors concluded that DIRT may offer substantial promise for treatment-resistant cases of OCD washing and for individuals with OCD with Poor Insight.

IV. SUMMARY

A number of theoretical approaches concerning the nature of OCD have stressed the importance of cognitive biases. Physical danger or threat beliefs is one of the cognitive variables that has been proposed as a mediating variable in OCD. Two studies reported in the literature that have directly examined the role of danger expectancies in OCD have provided support for danger-based models of the disorder. These results reveal previously unexplored possibilities for the treatment of OCD washers. In particular, cognitive-behavioral treatments specifically designed to target and reduce danger-related cognitions appear to be both logically consistent with the findings and potentially effective. One such treatment package, Danger Ideation Reduction Therapy (DIRT), has been recently developed and empirically assessed in three small treatment trials to date. Overall, the results from these studies have provided support for the usefulness of this intervention. The importance of these findings should not be underestimated given that only moderately effective treatments are currently available for OCD, and those traditional treatments are typically associated with significant rates of patient drop-out and refusal.

On the basis of these initial studies it is too early to determine the future utility of this novel treatment approach. However, DIRT appears to have several potential advantages over behavioral and pharmacological treatments. First, unlike exposure and response prevention, DIRT does not require the patient to confront anxiety-provoking stimuli. This is particularly important because many sufferers either refuse exposure treatment or drop-out before completion because of its anxiety-provoking effects. Second, unlike clomipramine, DIRT does not produce any physical side effects. Third, DIRT is a highly structured treatment package involving films, structured reports, and exercises that are relatively inexpensive to package and administer. Fourth, DIRT appears to require relatively few sessions for its therapeutic effect. Finally, DIRT may prove beneficial for patients whose condition has not improved following standard OCD treatments and for those who manifest poor insight.

See Also the Following Articles

Attention Training Procedures ■ Breathing Retraining ■ Cognitive Behavior Therapy ■ Cognitive Behavior Group Therapy ■ Reality Therapy ■ Relaxation Training

Further Reading

- Carr, A. T. (1974). Compulsive neurosis: A review of the literature. *Psychological Bulletin*, 81, 311–318.
- Jones, M. K., & Menzies, R. G. (1997). The cognitive mediation of obsessive-compulsive handwashing. *Behaviour Research and Therapy*, 35, 843–850.
- Jones, M. K., & Menzies, R. G. (1997). Danger Ideation Reduction Therapy (DIRT): Preliminary findings with three obsessive-compulsive washers. *Behaviour Research and Therapy*, 35, 955–960.
- Jones, M. K., & Menzies, R. G. (1998). The role of perceived danger in the mediation of obsessive-compulsive washing. *Depression and Anxiety*, 8, 121–125.
- Jones, M. K., & Menzies, R. G. (1998). Danger Ideation Reduction Therapy (DIRT) for obsessive-compulsive washers. A controlled trial. *Behaviour Research and Therapy*, 36, 959–970.
- Krochmalik, A., Jones, M. K., & Menzies, R. G. (2001). Danger ideation reduction therapy (DIRT) for treatment-resistant compulsive washing. *Behaviour Research and Therapy*, 39, 897–912.

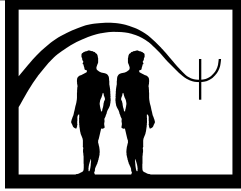

Dialectical Behavior Therapy

Sarah K. Reynolds and Marsha M. Linehan

University of Washington

- I. Introduction and Overview
 - II. Theoretical Foundation
 - III. Description of Treatment
 - IV. Empirical Evidence
 - V. Summary
- Further Reading

GLOSSARY

borderline personality disorder A psychiatric disorder characterized primarily by intense negative emotions (including depression, anger, self-loathing, and despair), disturbed interpersonal relationships, and self-damaging impulsive behaviors such as substance abuse and parasuicide.

dialectics A philosophical world-view that reality reflects an ever-changing transactional process.

parasuicide A term that refers to any intentional, acute self-injurious behavior with or without suicidal intent, including both suicide attempts and nonsuicidal self-mutilation. Considered the hallmark of borderline personality disorder.

randomized clinical trial A tightly controlled research design in which participants are randomly assigned to treatment condition. Random assignment allows one to conclude that post-treatment differences between groups are likely due to treatment effects.

Dialectical behavior therapy (DBT) is a multicomponent, cognitive-behavioral psychotherapy intended for complex, difficult-to-treat patients. Originally devel-

oped to treat the seriously and chronically suicidal patient, DBT has evolved into a treatment for suicidal patients who also meet criteria for borderline personality disorder (BPD), and it has since been adapted for BPD patients with presenting problems other than suicidal behaviors and for other disorders of emotion regulation. Treatment is based on a unique blend of behavioral psychology principles used to promote change, and Eastern mindfulness principles used to promote acceptance. This entry will describe the theoretical rationale, as well as the basic format of treatment, and will also briefly review the research on its efficacy.

I. INTRODUCTION AND OVERVIEW

Marsha Linehan and her research team at the University of Washington developed DBT during the 1980s as a treatment for the chronically suicidal patient who had a pattern of both suicide attempts and/or nonsuicidal self-injurious behaviors (i.e., parasuicidal behavior). DBT was soon extended to treat individuals meeting criteria for *borderline personality disorder (BPD)*, a disorder often characterized by parasuicidal behaviors. DBT has since been standardized in Linehan's 1993 treatment manuals, and evaluated in randomized clinical trials. The data (to be reviewed later in this article) suggest that it is more effective than usual psychotherapies offered in the community for treating women with BPD with primary presenting problems of suicidal behavior and substance abuse. DBT has also been

adapted to the treatment of eating disorders and dissociative disorders, and to families and adolescents. In addition, several large-scale mental health systems in the United States, Canada, and Europe have implemented DBT as a treatment for borderline patients across inpatient, day treatment, residential, case management, and crisis services.

DBT is rooted in standard cognitive and behavioral protocols, and it remains, first and foremost, a problem-solving, behavior therapy approach. Nonetheless, Linehan found that behavioral methods—though demonstrated to be effective with numerous other patient groups—required substantial modification when applied to a chronically suicidal population.

First, strategies that more clearly reflected the acceptance and validation of clients' current capacities were added in order to balance the behavioral emphasis on client change. That is, the “technologies of acceptance” drawn from principles of Eastern Zen and Western contemplative practices were intermingled with the “technologies of change” based on learning principles. Indeed, the balance of acceptance versus change is the overarching dialectic of treatment, hence the addition of the term “dialectical” to the name of the treatment.

Second, the complexity and severity of the patient group suggested that a comprehensive, multicomponent treatment approach was needed. Thus, therapy was divided into different modes of service delivery, with each component emphasizing one or more of the following treatment functions: (1) enhance patient motivation; (2) enhance patient capabilities; (3) ensure that new capabilities generalize to the patient's natural environment; (4) enhance therapist capabilities and motivation to treat patients effectively; and (5) structure the environment in a manner that will promote and reinforce patient and therapist capabilities.

The result is DBT in its standard format—an outpatient treatment program with four components: individual psychotherapy to address motivational enhancement and skills strengthening (most often weekly, one-hour sessions); highly structured group skills training to enhance capabilities (weekly for 2½ hours); as-needed phone consultation with the individual therapist to address application of new capabilities; a consultation meeting for DBT treatment providers intended to keep therapists motivated and to ensure that they are providing effective treatment consistent with the DBT approach (most often once weekly for 60 to 90 minutes). The fifth treatment function—structuring the environment—occurs as needed and may include case management interventions to find housing or to assist the client

in other ways to make concrete changes in his or her natural environment so that it will be as reinforcing of adaptive functioning as possible. However, attention may also need to be paid to any contingencies acting on the therapist that reinforce client dysfunctional behaviors (e.g., institutional policies that offer a greater number of low-cost services for clients who are unemployed and on disability).

Conceptualizing DBT in terms of its *functions* allows for flexibility in how the treatment is delivered. That is, DBT can be applied in any mode as long as the five treatment functions are addressed. For example, inpatient DBT programs may offer milieu and staff coaching to enhance motivation; a twice weekly skills group to address capability enhancement; staff coaching and day passes to address skills generalization; consultation meetings and continuing education classes to provide therapist support; and meetings with outpatient providers and family to structure the environment.

II. THEORETICAL FOUNDATION

Described next are Linehan's theory of the etiology and maintenance of BPD, and the theoretical perspectives that form the basis of the DBT model. Emphasis is placed on how each set of concepts impacts treatment.

A. Biosocial Theory of BPD

According to Linehan's biosocial theory, BPD behavioral patterns develop as the result of an ongoing transaction between a biological vulnerability to emotion dysregulation and an “invalidating environment.” That is, a cyclical interaction develops whereby an individual prone to intense emotional displays may elicit invalidation from those in the environment who have difficulty understanding the emotions. In turn, the experience of being persistently invalidated tends to increase emotional dysregulation and decrease learning of emotion regulation skills.

Emotional vulnerability is believed to be strongly influenced by biology, such that an individual is predisposed (perhaps due to high genetic loading for an emotional temperament) to have the following characteristics: (1) a low threshold for emotional stimuli; (2) emotional reactions that tend to be rapid and intense; and (3) a slow return to baseline, contributing to high sensitivity to the next emotional stimulus.

The primary characteristic of an invalidating environment is that the private experiences (emotions and

thoughts) and overt behaviors of the individual are often taken as invalid responses to events; are punished, or disregarded; and/or are attributed to socially unacceptable characteristics. In addition, although modulated emotional displays may be ignored or met by punishment, high-level escalation may result in attention, meeting of demands, and other types of reinforcement. Finally, an invalidating environment may oversimplify the ease of meeting life's goals and problem solving.

In addition to deficits in emotion regulation, pervasive invalidation may also lead to difficulties with accurately labeling emotions and difficulties trusting one's own experiences as valid. By oversimplifying problem solving, such an environment does not teach effective problem-solving skills, graduated goals, or distress tolerance but instead teaches perfectionistic standards and self-punishment as a strategy to try to change one's behavior. Finally, invalidation of modulated emotional displays in conjunction with reinforcement of escalated emotional displays teaches the individual to oscillate between emotional inhibition and extreme emotionality.

The transactional nature of the relationship suggests that only mild amounts of invalidation may be sufficient to result in BPD for the individual with a high vulnerability to emotional dysregulation. Conversely, a child with only moderate levels of emotional vulnerability may develop BPD with a sufficiently invalidating environment.

This model represents not only a model of etiology, but also a model of maintenance of BPD behaviors and current transactions. For example, a key theoretical assumption that guided the development of DBT is that suicidal behavior is an attempt to solve a problem—most often the problem of intense and painful emotions that the individual is unable to effectively regulate. Indeed, Linehan conceptualizes the patterns of behavior comprising the BPD diagnostic criteria either as direct consequences of dysregulated emotions or as response patterns that function to regulate out-of-control, aversive emotions. Other dysfunctional behaviors found in BPD and in other patient populations (e.g., binge eating, substance use) may also serve a similar problem-solving function. As such, the task for the DBT therapist is to target the dysfunctional behavior patterns that are functionally linked to emotional arousal.

The biosocial model also suggests that validation will be of critical importance in treating the individual with BPD. Not surprisingly, validation is one of the core

treatment strategies of DBT. The model further suggests that treatment providers, much like the rest of the patient's social environment, may also have a tendency to respond to the patient in invalidating ways. Indeed, the patient's behavior may be invalid in many respects. However, a DBT therapist must make a conscious effort to locate the "nugget of truth" in the individual's behavior so that he or she feels understood and accepted, and is thus able to move toward more skillful behavior.

B. Dialectical Philosophy

The feature most distinctive of DBT is its philosophical base in dialectics—a term that conveys two meanings. First, dialectics refers to a world-view that reality reflects an ever-changing, transactional process in which each action leads to its opposite—a reaction—the resolution of which is a synthesis of both positions. Within the therapy relationship, this suggests that multiple tensions will inevitably coexist, and must be addressed and resolved by the therapist.

The dialectical philosophy also conveys the assumption that individuals with BPD get caught between extremes of emotion and behavior, repeatedly going back and forth without ever learning a new synthesis or middle ground. Indeed, a central goal of DBT is to replace these rigid, dichotomous patterns with dialectical thinking and behavior. This overarching target guides the DBT therapist approach to all other target behaviors. That is, in all modes the therapist strives to reduce the incidence of extreme, polarized thoughts, emotions, and actions, and to increase the likelihood of balanced, integrated responses "to the moment."

C. Learning Principles and Behavioral Psychology

Consistent with other behavioral approaches, DBT assumes that all behaviors, whether adaptive or dysfunctional, are influenced by prior learning, are continually subject to environmental contingencies, and are thus situation-specific. This viewpoint has several important treatment implications. First, since all behaviors are caused, it encourages treatment providers to be nonpejorative toward patients, even in the face of aversive patient behaviors. Likewise, it may serve to reduce patients' self-blame, shame, and hopelessness regarding their behaviors and their lives.

Second, it suggests that behavior change requires careful assessment of the problem behavior and the environmental conditions under which the behavior will

occur. Attributing behavior to hypothetical constructs such as “need for approval” is not sufficient because such constructs do not specify the environmental determinants. Rather, the DBT therapist and patient work together to construct a behavioral chain analysis, which is a detailed analysis of events and situational factors before and after a particular instance (or set of instances) of the targeted behavior. The goal is to provide an accurate and reasonably complete account of behavioral and environmental events associated with the problem behavior. Close attention is paid to reciprocal interactions between environmental events and the client’s emotional, cognitive, and overt responses.

A chain analysis requires a clear definition of the problem behavior; identification of vulnerability factors (e.g., sleep deprivation or other conditions that influence emotional reactivity); and specific precipitating events that led to the problem behavior. Therapist and client then identify each link between the precipitating event and the problematic behavior to yield a detailed account of each thought, feeling, and action that moved the client from point A to point B. Finally, the reactions of the client and others that followed the behavior are identified. This detailed assessment allows the therapist to identify each point where an alternative client response might have produced positive change and averted conditions that led to problem behavior.

Reasons for the absence of a skilled response can generally be placed into one of four categories: effective behaviors are inhibited by skills deficit(s); effective behaviors are inhibited by faulty beliefs and assumptions; effective behaviors are inhibited by attempts to avoid aversive emotions; the environment is not supportive of the effective behaviors or is overly supportive of the problem behaviors. In turn, each of these problem areas is linked to a behavioral change procedure that is part of the problem-solving strategies described below.

III. DESCRIPTION OF TREATMENT

A. Levels of Disorder and Stages of Treatment

Unlike many other empirically supported, manualized psychotherapy approaches, DBT does not provide a session-by-session protocol for how treatment should proceed. Rather, DBT is designed to be a highly flexible model that can be readily applied to patients with disorders of varying severity and complexity. Linchan con-

ceptualized four levels of disorder, each level having a corresponding stage of treatment.

Level 1 disorders are characterized by behavioral dyscontrol and typically include disorders that are both severe and pervasive. The overall goal of Stage 1 treatment for Level 1 disorders is to help these patients increase control over their behavior and their lives. Standard DBT, which is the general focus of this chapter, is a Stage 1 treatment. Linehan’s treatment manual and the existing research data focus on Stage 1 DBT. Behaviors that are targeted for treatment at this stage are arranged hierarchically as follows: (1) reducing life-threatening behaviors (parasuicidal acts, including suicide attempts, high-risk suicidal ideation, plans and threats, as well as homicidal acts, plans, and threats); (2) reducing client and therapist behaviors that interfere with the therapy (e.g., missing sessions or arriving late, phoning at unreasonable hours, not returning phone calls, or pushing therapist or patient limits in any other manner); (3) reducing behavioral patterns that substantially interfere with a reasonable quality of life (e.g., severe depression, poor work behaviors, homelessness, criminal behaviors); (4) acquisition of sufficient life skills to meet client goals (emotion regulation, interpersonal effectiveness, distress tolerance, self-management, mindfulness); and (5) other goals the client wishes to address.

The second level of disorder is best described as “quiet desperation” (as opposed to the state of “loud desperation” in Level 1). The central problem at this level is avoidance of emotions and any environmental cues associated with them. A good example would be a patient with post-traumatic stress disorder. The goal of Stage 2 DBT is to increase the patient’s ability to experience emotions without trauma. Level 3 disorders are best described as problematic patterns in living that interfere with goals. Thus, treatment at this stage focuses on achieving ordinary happiness and a stable sense of self-respect. Finally, the fourth level of disorder refers to those individuals who have a lingering sense of incompleteness despite the fact that they are otherwise satisfied with their lives. The goals of Stage 4 DBT include developing the capacity for sustained joy via psychological insight, spiritual practices, and an expanded awareness of oneself.

Overall, the orientation of the treatment is first to get overt behaviors under control, then to help the patient to feel better, to resolve problems in living and residual disorder, and to find joy and, for some, a sense of transcendence. Because therapeutic change is usually not linear, progress through the foregoing hierarchy of be-

haviors is an iterative process. That is, attention is shifted away from a lower-priority target back to a higher-priority target if that behavior recurs (e.g., life-threatening behaviors).

With respect to each treatment goal, the task of the therapist is first (and many times thereafter) to elicit the client's collaboration in working on the relevant behavior and then to apply the appropriate treatment strategies as described in the following subsection. Treatment in DBT is oriented to current in-session behaviors or problems that have surfaced since the last session, with suicide attempts and all other life-threatening behaviors taking precedence over all other topics. Furthermore, the high priority that DBT places on discussing the "therapy-interfering" behaviors of the client or therapist (target 2) is also noteworthy. This direct targeting of the therapeutic relationship is typically very important in treating complex, multi-disordered clients and is unique to DBT.

B. Treatment Strategies

DBT addresses all problematic client behaviors and therapy situations in a systematic, problem-solving manner. The behavioral analyses and change procedures involved in problem solving are surrounded by validation of the client's experiences, especially as they relate to the individual's vulnerabilities and sense of desperation. Furthermore, in contrast to many behavioral approaches, DBT places great emphasis on the therapeutic relationship as a mechanism of change. In times of crisis, when all else fails, DBT uses the relationship itself to keep the client alive.

Treatment strategies in DBT are divided into four sets: (1) Dialectical strategies, (2) core strategies (problem solving and validation), (3) communication strategies (irreverence and reciprocal communication), and (4) case management strategies (consultation to the patient, environmental Intervention, and supervision/consultation with therapists). In all treatment strategies, a DBT therapist must constantly strive for a balance of acceptance and change.

There are also a number of specific behavioral treatment protocols covering suicidal behavior, crisis management, therapy-interfering behavior and compliance issues, relationship problem solving, and ancillary treatment issues, including psychotropic medication management. For additional description of these protocols, the interested reader is referred to texts listed in the Further Reading section.

1. Dialectical Strategies

Dialectical strategies are woven throughout all treatment interactions. The most fundamental dialectical strategy is the balanced therapeutic stance—the constant attention to combining acceptance with change. The goal is to bring out the opposites, both in therapy and the client's life, and to provide conditions for synthesis. Strategies include extensive use of stories, metaphor, and paradox; the therapeutic use of ambiguity; viewing therapy, and indeed all of reality, as constant change; cognitive challenging and restructuring techniques; and reinforcement for use of intuitive, non-rational knowledge bases.

2. Core Strategies

Core strategies consist of the balanced application of problem-solving and validation strategies. The problem-solving strategies are central to treatment and are drawn from behavioral psychology principles as described earlier. Included are a wide variety of behavioral assessment and behavioral therapy techniques that are used to directly target maladaptive behaviors. Problem solving is a two-stage process, involving, first, an analysis and acceptance of the current problem, and second, an attempt to generate, evaluate, and implement alternative solutions that might have been made or could be made in the future in similar problematic situations. Analysis of the client's problem behaviors, including dysfunctional actions, emotions, physiological responses, and thought processes, requires careful scrutiny of the chains of events (both responses of the individual and events in the environment) leading up to the problematic responses. This analysis was described earlier and is repeated for every instance of targeted problem behaviors until both therapist and client achieve an understanding of the response patterns involved.

The second stage, which is actually interwoven with the first, requires the generation of new, more skillful responses, as well as an analysis of the individual's capabilities and motivation to actually engage in the new behaviors. This process leads into application of change procedures, which are drawn primarily from cognitive-behavior therapy protocols and anchor the change end of the primary dialectic in DBT. They include management of contingencies in the therapeutic relationship, training in behavioral skills, exposure techniques with response prevention, and cognitive restructuring.

The acceptance pole of this dialectic is represented by the validation strategies. In essence, these strategies

involve the active acceptance of the patient by the therapist and communication of that acceptance to the client. Validation requires that the therapist search for, recognize, and reflect the current validity, or functionality, of the individual's current behaviors. Validation is used to balance and facilitate problem solving it can also promote self-validation, strengthen the therapeutic relationship, and reinforce clinical progress.

For heuristic purposes, validation can be conceptualized in six levels. The first three levels are basic therapeutic strategies for building and maintaining rapport. The second three focus on communicating accurately the valid and invalid nature of the patient's behavior and emotional responses. Level 1 validation involves listening to and observing what the client is saying, feeling, and doing, along with an active effort to understand and make sense of what is being observed. In essence, the therapist is demonstrating interest in the client and notices the nuances of both verbal and nonverbal response in the interaction. Level 2 validation is the accurate reflection, paraphrasing, and summarizing of the client's thoughts, feelings, and behaviors. At Level 2, validating statements remain relatively close to what the client said rather than adding to the client's communication. Level 3 validation refers to articulating or "mind-reading" that which is unstated, such as fears of admitting emotions or thoughts, but without pushing the interpretation on the client. The therapist conveys an intuitive understanding of the client; sometimes knowing clients better than they know themselves.

In Level 4 validation, the therapist validates the client's experience in terms of past learning or in terms of biological dysfunction (e.g., biological predisposition to emotional vulnerability). For example, during a first therapy session, a therapist might validate the client's fears that the therapist will be rejecting by saying, "It makes sense that you would have such concerns, given that you have been rejected by many important people in your life." Level 5 validation involves validating the client in terms of present and normal functioning. In the above situation, for example, a therapist might respond, "Of course you are concerned about me rejecting you; after all, this is our first therapy session and you really don't know what to expect." Finally, Level 6 validation calls for the therapist to show radical genuineness with clients. That is, the therapist must treat the client-therapist relationship as authentic and "real," wherein the therapist behaves as his/her natural self rather than acting in a role-prescribed manner. This involves not treating the client as fragile or as

unable to solve problems, but rather as a person of equal status who is capable of effective and reasonable behavior.

DBT does not specify the frequency or timing of particular types of validation. However, validation is required in every interaction, and when appropriate, it is generally preferable to use higher levels of validation over lower levels.

3. Communication Strategies

In DBT, the therapist balances two communication strategies, which represent rather different interpersonal styles. The modal style is the reciprocal strategy, which includes responsiveness to the client's agenda and wishes, warmth, and self-disclosure of personal information that might be useful to the client as well as immediate reactions to the client's behavior.

Reciprocity is balanced by an irreverent communication style that is used to promote change: a matter-of-fact or at times slightly outrageous or humorous attitude where the therapist takes the client's underlying assumptions or unnoticed implications of the client's behavior and maximizes or minimizes them, in either an unemotional or overemotional manner to make a point the client might not have considered before. Irreverence "jumps track," so to speak, from the client's current pattern of response, thought, or emotion. For example, if a client says "I am going to kill myself!," the therapist might respond, "But I thought you agreed not to drop out of therapy!" It is important that irreverence is balanced with reciprocity. Overuse of irreverence may alienate the patient, while too much reciprocal communication will result in minimal change.

4. Case Management Strategies

There are three strategies designed to guide each therapist during interactions with individuals outside the therapy dyad. First, the consultant-to-the-client strategy is the application of the principle that the DBT therapist teaches the client how to interact effectively with the client's environment rather than teaching the environment how to interact with the client. When absolutely necessary, however, the therapist invokes the environmental intervention strategy, in which he or she actively intervenes in the environment to protect the client or to modify situations that the client does not have the power to influence. The third strategy, the consultation-to-the-therapist strategy, requires that each DBT therapist meet regularly with a supervisor or consultation team. The idea here is that complex, multi-disordered clients should not be treated alone.

Furthermore, the consultant-to-the therapist strategy is used to find the synthesis or middle ground between the other case management strategies, one that argues for change via coaching the client (consultant-to-the-client) and the other that argues for acceptance by directly intervening on the client's behalf (environmental intervention).

IV. EMPIRICAL EVIDENCE

The empirical evidence in support of DBT is promising. In the original randomized clinical trial of DBT conducted by Linehan and colleagues during the treatment development phase, participants were chronically suicidal women diagnosed with BPD who had a recent history of parasuicide. Participants were randomly assigned to one year of either DBT or treatment-as-usual (TAU), a naturalistic control group in which participants receive psychotherapy as it is usually offered in the community. As hypothesized, in comparison to the TAU group, those who received DBT showed significantly greater reduction in rates of parasuicidal behavior, better treatment retention, fewer days of inpatient psychiatric hospitalization, less anger, and improved global social functioning.

Since that time, two additional randomized clinical trials have been reported comparing DBT to TAU. Linehan and her colleagues adapted standard DBT for substance abusers diagnosed with BPD and again found superior outcomes for one-year DBT as compared to one-year TAU. Furthermore, a research group independent of Linehan and colleagues found that six months of DBT produced better patient outcomes than six months of TAU in treating women with BPD.

Finally, several quasi-experimental studies from program evaluations and pilot studies have produced encouraging results, expanding the research base on the efficacy of DBT when adapted for other settings and when extended to treat different treatment populations. These include treatment on inpatient units and in forensic settings, and with suicidal adolescents, and women with binge-eating disorder. These studies do not have the scientific rigor of an experimental design, but taken together, they suggest that extensions of DBT across setting and disorder warrant further investigation.

In sum, the research evidence to date suggests that across studies, DBT reduces severe dysfunctional behaviors that are targeted for intervention (e.g., parasuicide, substance abuse, and binge eating), enhances treatment retention, and reduces psychiatric hospital-

ization. The data also suggest that, although DBT was developed for the treatment of patients with suicidal behavior, it can be adapted to treat BPD patients with comorbid substance abuse disorder and to other patient populations and settings.

Further research is needed, particularly to address the following questions: (1) Which components of DBT (e.g., specific treatment strategies) contribute to outcomes? For example, though preliminary, skills coaching seems to be a crucial ingredient in producing reductions in parasuicidal behavior. (2) Similarly, can we (and if so, *how* can we) improve the efficacy of DBT through additional treatment development? (3) To what different populations/settings can DBT be successfully adapted? (4) Is DBT effective in public health settings? The majority of studies have been conducted in controlled settings (e.g., academic environments) in which highly trained psychotherapists are delivering the treatment within a well-organized framework. However, DBT has now been adopted in a variety of "real-world" clinical settings, highlighting the need for research in this arena. (5) How long does DBT maintain its gains after treatment is over? Results are positive one-year post-treatment, but examination of additional longitudinal outcomes is needed (e.g., suicide rates at five-year followup).

Fortunately, research evaluating the efficacy of DBT is currently being conducted in several U.S. and European sites. Results from these studies should become available over the next several years, providing further information by which to evaluate the efficacy of DBT.

V. SUMMARY

Dialectical behavior therapy (DBT) is a multicomponent, cognitive-behavioral psychotherapy intended for complex, difficult-to-treat patients. Originally developed to treat the seriously and chronically suicidal patient, DBT has evolved into a treatment for suicidal patients who also meet criteria for BPD, and has since been adapted for BPD patients with presenting problems other than suicidal behaviors (e.g., substance abuse) and for other disorders of emotion regulation (e.g., binge-eating disorder). Treatment is based on a unique blend of behavioral psychology principles used to promote change and on Eastern mindfulness principles used to promote acceptance. DBT is conceptualized as occurring in stage based on severity and complexity of disorder, and thus can be applied to patients of varying degrees of severity.

As a comprehensive treatment, DBT serves five functions: (1) to enhance patient motivation; (2) to enhance patient capabilities; (3) to ensure that new capabilities generalize to the patient's natural environment; (4) to enhance therapist capabilities and motivation to treat patients effectively; and (5) to structure the environment in a manner that will promote and reinforce patient and therapist capabilities. In standard DBT, these five functions are divided up among four treatment components: weekly individual psychotherapy; weekly group skills training; as-needed phone consultation with the individual therapist; and a consultation meeting for DBT treatment providers. Other interventions (e.g., pharmacotherapy, case management) occur as needed.

Research evidence to date suggests that across studies, DBT reduces severe dysfunctional behaviors that are targeted for intervention (e.g., parasuicide, substance abuse, and binge eating), enhances treatment retention, and reduces psychiatric hospitalization. The data also suggest that, although DBT was developed for the treatment of patients with suicidal behavior, it can be adapted to treat BPD patients with comorbid substance abuse disorder and to other patient populations and settings.

Acknowledgments

The writing of this chapter was partially supported by grant MH34486 from the National Institute on Mental

Health, Bethesda, Maryland. The authors thank Katherine A. Comtois for editorial assistance.

See Also the Following Articles

Behavioral Consultation and Therapy ■ Behavioral Therapy Instructions ■ Character Pathology ■ Existential Psychotherapy ■ Gestalt Therapy

Further Reading

- Koerner, K., & Linehan, M. M. (1997). Case formulation in dialectical behavior therapy. In T. Eellst (Ed.), *Handbook of Psychotherapy Case Formulation* (pp. 340–367). New York: Guilford Press.
- Koerner, K., & Linehan, M. M. (2000). Research on dialectical behavior therapy for patients with borderline personality disorder. *The Psychiatric Clinics of North America*, 23, 151–167.
- Linehan, M. M. (1993). *Cognitive-behavioral therapy for borderline personality disorder*. New York: Guilford Press.
- Linehan, M. M. (1993). *Skills training manual for treating borderline personality disorder*. New York: Guilford Press.
- Linehan, M. M. (1997). Validation and psychotherapy. In A. Bohart, & L. Greenberg (Eds.), *Empathy reconsidered: New directions in psychotherapy* (pp. 353–392). Washington, DC: American Psychological Association.
- Linehan, M. M. (1998). An illustration of dialectical behavior therapy. *Session: Psychotherapy in Practice*, 4, 21–44.
- Scheel, K. R. (2000). The empirical basis of dialectical behavior therapy: Summary, critique, and implications. *Clinical Psychology: Science and Practice*, 7, 68–86.

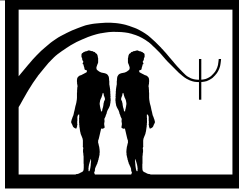

Differential Attention

Nirbhay N. Singh, Bethany A. Marcus, and Ashvind N. Singh

Virginia Commonwealth University and Central State Hospital

- I. Description of Treatment
- II. Theoretical Bases
- III. Empirical Studies
- IV. Summary
- Further Reading

GLOSSARY

attention The description of a procedure involving certain therapist behaviors that either precede or follow an individual's behavior. Attention is not *a priori* a reinforcer. Although it can be a powerful reinforcer for some individuals, for others, it can be a punishing stimulus or even a neutral event.

extinction A behavioral procedure that weakens a response by the consistent withholding of a reinforcer following the occurrence of an operant response that had previously produced that reinforcer.

functional analysis An experimental investigation that identifies the maintaining variables for a specific target behavior emitted by an individual; that is, it is based on the assessment of consequences maintaining a target behavior.

Differential attention is a procedure that helps a person to discriminate between a specific behavior and all other behaviors. The procedure can be used in a learning context for skill acquisition or in a treatment context for the reduction of a problem behavior.

I. DESCRIPTION OF TREATMENT

Differential attention involves two inextricably involved processes, reinforcement and extinction. Differential attention is a variant of generic differential reinforcement procedures that involve withholding reinforcement for a specified response from a response class and reinforcing other responses, depending on the reinforcement schedule. The typical outcome is response differentiation. In skill acquisition, there is an increase in the rate of the reinforced response relative to the rate of other members of the response class, and, in behavior reduction, there is a decrease in the rate of the problem response relative to the rate of other members of the response class.

II. THEORETICAL BASES

Contingent attention is typically used to increase responding. When used in a skill acquisition paradigm, attention is delivered following approximations to or the occurrence of a specific behavior while simultaneously withholding attention following the occurrence of all other behaviors. The basic process is one in which attention is differentially delivered only on the occurrence of a target behavior, resulting in skill acquisition or an increase in the rate of the behavior. For example, when increasing the social interaction of a socially withdrawn child, the teacher would provide at-

tention when the child was socially interacting with other children and not when the child was socially withdrawn, thus differentially reinforcing social interaction with attention.

When used in a behavior reduction paradigm, attention is delivered following the occurrence of socially acceptable behaviors while simultaneously withholding attention following the occurrence of a specific problem behavior. The basic processes involve both withholding reinforcement contingent on a target response (extinction) and delivering reinforcement contingent on other or alternative responses. For example, if a child engages in temper tantrums, his parents would withhold attention (i.e., ignore the temper tantrum) and only provide the child with attention when he is quietly playing with his toys and not engaging in the problem behavior.

Theoretically, the delivery of contingent attention can be on one of three basic schedules—continuous, ratio, and interval schedules—although in real life attention is usually delivered on a mixed schedule of reinforcement. To enhance rapidly the discrimination between a target and all other behaviors, attention is delivered on a continuous schedule; that is, attention immediately follows each occurrence of the target behavior. Continuous schedules of attention are used in the early stages of learning when a new skill or behavior is being acquired. Furthermore, continuous schedules of attention may be used for all socially acceptable behaviors, while a specific problem behavior is being ignored—that is, while the problem behavior is on an extinction schedule.

Once discrimination between the target and all other behaviors has been established, attention can be delivered on increasingly intermittent schedules, that is, on ratio and interval schedules. In skill acquisition, the target behavior is reinforced with attention after a fixed or variable number of times the behavior has been emitted (ratio schedules) or after fixed or variable intervals of time (interval schedules). In behavior reduction programs, the problem behavior is always ignored, and other behaviors may be reinforced with attention on ratio or interval schedules. For example, if attention is delivered when a specific problem behavior has not occurred for a prescribed interval, it is an instance of differential reinforcement of other behavior where attention is the reinforcement.

Theoretically, when attention is withheld from a behavior that was previously reinforced by attention, the behavior is said to be on an extinction schedule. Sometimes, putting a behavior on an extinction schedule re-

sults in an initial increase or burst of the behavior. Thus, extinction may not be a suitable procedure for reducing some behaviors, such as aggression or self-injury. Furthermore, regardless of the nature of the behavior being targeted for reduction, occasionally the extinction period is accompanied by an initial outburst of aggression by the individual. Therapists need to be prepared to deal with extinction-induced aggression should it occur. In addition, extinction is associated with a phenomenon known as spontaneous recovery, when the behavior briefly recurs spontaneously after a long period of its absence. Again, therapists need to be aware of this possibility and to be prepared to deal with it. A final consideration is that extinction requires consistency of application; that is, no instance of the target behavior must be followed by attention. Inadvertently attending to some instances of the target behavior may make the behavior more resistant to extinction and, theoretically, strengthen the behavior.

III. EMPIRICAL STUDIES

Differential attention has been used extensively in skill acquisition programs in classroom settings. In general, differential attention procedures have been used successfully to increase the academic and social skills of children with disabilities, without concomitantly decreasing other behaviors.

Differential attention has also been used to reduce problem behaviors in individuals with disabilities, especially those with developmental disabilities. The empirical literature on differential attention is limited because, by itself, it is not a very powerful procedure for decreasing severe behavior problems.

Individuals with developmental disabilities sometimes engage in aberrant behavior in specific social contexts when another person diverts their parents' attention from them. For example, Mark F. O'Reilly and colleagues assessed the motivation of aberrant behavior of two individuals with severe mental retardation. They observed that the aberrant behavior (hitting, pinching, property destruction, and self-injury) of these two individuals typically occurred when their parents interacted with someone other than them. Using a brief functional analysis methodology, the therapists established that aberrant behaviors actually did occur when parents diverted their attention from their child to a third person. Furthermore, they found that the two individuals did not engage in aberrant behavior when their parents gave them attention noncontingently—that is, when

they interacted with their children on a fixed schedule in the absence of aberrant behavior. Attention-maintained aberrant behavior was eliminated when the parents gave noncontingent attention to their children while engaging in social interaction with a third person.

Current research on attention-maintained problem behaviors indicates that not all forms of attention are functionally equivalent, suggesting that therapists may need to evaluate the effectiveness of different forms of attention as reinforcement before implementing treatment. For example, if a functional assessment indicates that aggression is maintained by verbal attention, then further analyses should be performed to examine what properties of verbal attention maintain aggression. A common finding is that response-relevant verbal attention (“Stop that! You are hurting me”) contingent on aggression maintains the aggression at higher levels than response-irrelevant statements (e.g., “You are looking good today”). This is in accord with research showing that, for about a third of the cases, attention in the form of reprimands and physical contact actually maintains destructive and aggressive behavior in individuals with developmental disabilities. Why this should be so is unclear. We suspect that, as appropriate behavior is infrequently reinforced in individuals with severe behavior disorders, these individuals engage in destructive and aggressive behavior because these behaviors result in a greater density of verbal attention, even though these are in the form of reprimands.

Differential levels of attention can be used as an establishing operation to influence the rate of occurrence of a problem behavior. An establishing operation can be defined as an antecedent condition that influences the probability of a behavior by increasing the value of consequent stimuli and the effectiveness of discriminative stimuli for a given response class. For example, changing antecedent levels of attention for attention-maintained behaviors will produce differential rates of the behavior. Thus, depriving an individual of all attention versus providing the individual noncontingent attention as establishing operations will result in high rates of the problem behavior following the former condition and low rates of the behavior following the latter condition.

Differential attention procedures are appealing for a number of reasons. First, the procedures incorporate an extinction component. That is, the relationship between the problem behavior and reinforcement is disrupted which, by definition, will result in a decrease or even an elimination of the problem behavior. Second, an individual can learn to produce responses that

are more appropriate because other, socially appropriate behaviors are differentially attended to. Third, differential attention is a portable procedure that can be used in the natural environment, and is not restricted to a facility or a clinic or for use only by professionals. Fourth, differential attention procedures have been demonstrated to be relatively effective across a wide variety of populations and mild behavior problems (e.g., children, adults, individuals with developmental disabilities, aggression, self-injury, hyperactivity, thumbsucking, noncompliance). Finally, differential attention is a reinforcement procedure, and contingent delivery of aversive stimulation is not required.

Although differential attention procedures have gained wide acceptance, several studies have reported that such procedures are relatively ineffective in comparison to other interventions. However, procedural and functional advancements have been made to enhance the effectiveness of differential attention procedures. For example, differential attention can be delivered based on the most effective time interval (i.e., inter-response time), or the “whole-interval” time period in which the individual is required not to engage in the target problem behavior.

Despite the possibility of enhancing the effectiveness of differential attention procedures, several potential limitations may remain. For example, (a) differential attention can be a cumbersome procedure to use (i.e., care providers are required to attend/observe the individual at all times either to reset an interval timer or to provide attention on a specified schedule in the absence of the target behavior), and (b) the extinction component of the procedure may produce side effects that are potentially hazardous to the individual (e.g., increased rate or magnitude of behavior, new forms of aberrant behavior, emotional responding). Moreover, the extinction component may be difficult to use consistently if the behavior is severe, potentially life threatening, or may be inadvertently attended to by well-meaning staff, peers, or visitors.

IV. SUMMARY

Differential attention is a widely used procedure in real life, especially in teaching new skills to humans and other animals. When used to decrease problem behaviors, it is often misused and problem behaviors are strengthened rather than decreased. As a treatment procedure, it involves both reinforcement (providing attention to all other socially desirable behaviors, if at-

tention has been determined to be reinforcing) and extinction (withholding attention, if attention has been determined to maintain the problem behavior). Without the extinction component, differential attention is not a very robust behavior reduction procedure. However, extinction is associated with a number of potential side effects that therapists should be aware of before instituting the procedure. For example, it may not be ethical to use extinction in cases of self-injury as the behavior may initially continue at high rates while being ignored. Generally, the rate of behavior change that results from the use of differential attention is much lower when compared to the use of more powerful primary (e.g., food) and conditioned reinforcers (e.g., tokens, money). If a rapid behavior change is desired, differential attention may need to be paired with other, more powerful procedures.

See Also the Following Articles

Attention Training Procedures ■ Differential Reinforcement of Other Behavior ■ Extinction ■ Functional Analysis of Behavior

Further Reading

- Carr, E. G., Levin, L., McConnachie, G., Carlson, J. I., Kemp, D. C., & Smith, C. E. (1994). *Communication-based intervention for problem behavior*. Baltimore, MD: Paul H. Brookes Publishing Co.
- Luiselli, J. K., & Cameron, M. J. (1998). *Antecedent control: Innovative approaches to behavioral support*. Baltimore, MD: Paul H. Brookes Publishing Co..
- O'Reilly, M. F., Lancioni, G. E., King, L., Lally, G., & Dhommnaill, O. N. (2000). Using brief assessments to evaluate aberrant behavior maintained by attention. *Journal of Applied Behavior Analysis*, 33, 109–112.
- Piazza, C. C., Bowman, L. G., Contrucci, S. A., Delia, M. D., Adelinis, J. D., & Goh, H. L. (1999). An evaluation of the properties of attention as reinforcement for destructive and appropriate behavior. *Journal of Applied Behavior Analysis*, 32, 437–448.
- Repp, A. C., & Horner, R. H. (1999). *Functional analysis of problem behavior: From effective assessment to effective support*. Belmont, CA: Wadsworth Publishing Co.
- Singh, N. N. (1997). *Prevention and treatment of severe behavior problems: Models and methods in developmental disabilities*. Pacific Grove, CA: Brooks/Cole Publishing Co.

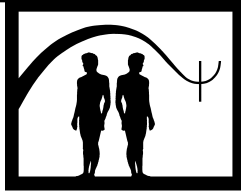

Differential Reinforcement of Other Behavior

Marc J. Tassé, Susan M. Havercamp, and Luc Lecavalier

University of North Carolina at Chapel Hill

- I. Description
 - II. Efficacy
 - III. Functional Assessment and Reinforcer Preference
 - IV. Maintaining Behavior Suppression and Generalization
 - V. Negative Effects
 - VI. Steps to Setting up a DRO Intervention
 - VII. Summary
- Further Reading

GLOSSARY

differential reinforcement of other behavior (DRO) involves the presentation of a reinforcer contingent upon the absence of the target behavior during a pre-determined interval of time. All other behavior, than the target behavior, is reinforced.

fixed momentary DRO Fixed Momentary DRO is a schedule where the interval length is held constant and reinforcement is delivered for the absence of target behavior at the end of the interval.

fixed whole-interval DRO Fixed Whole-Interval DRO is a schedule where the interval length is held constant and reinforcement is delivered for the absence of target behavior throughout the entire interval.

reinforcer A stimulus that when presented following a behavior will increase the probability of recurrence of that behavior.

target behavior Any behavior that is the focus of an intervention.

variable momentary DRO Variable Momentary DRO is a schedule where the interval lengths vary across an average value and reinforcement is delivered for the absence of target behavior at the end of the interval.

variable whole-interval DRO Variable Whole-Interval DRO is a schedule where the interval lengths vary across an aver-

age value and reinforcement is delivered for the absence of target behavior throughout the entire interval.

I. DESCRIPTION

Differential reinforcement of other behavior (DRO) was first described by Reynolds (1961). DRO is considered a behavior suppression intervention method as are positive punishment or negative punishment, extinction, and overcorrection. Differential reinforcement is unique within the category of behavior suppression strategies in that it relies on the contingent presentation of a reinforcer. DRO, also referred to as omission training is described as the presentation of a reinforcer contingent on the absence of the target behavior during a predetermined interval of time. Thus, a reinforcer is delivered if the individual does not emit the target behavior during a preset interval of time, regardless of other behaviors emitted. If the individual emits the target behavior (behavior that we wish to suppress), the delivery of the reinforcer is delayed.

The reader should know that there are several types of differential reinforcement. In addition to DRO, there is differential reinforcement of incompatible behavior (DRI), differential reinforcement of alternative behavior (DRA), and differential reinforcement of low frequency behavior (DRL). Other methods of behavior suppression are only briefly discussed in this article when comparing them to DRO. This article focuses on describing and discussing the basic elements of DRO, the different types of DRO contingencies, its efficacy

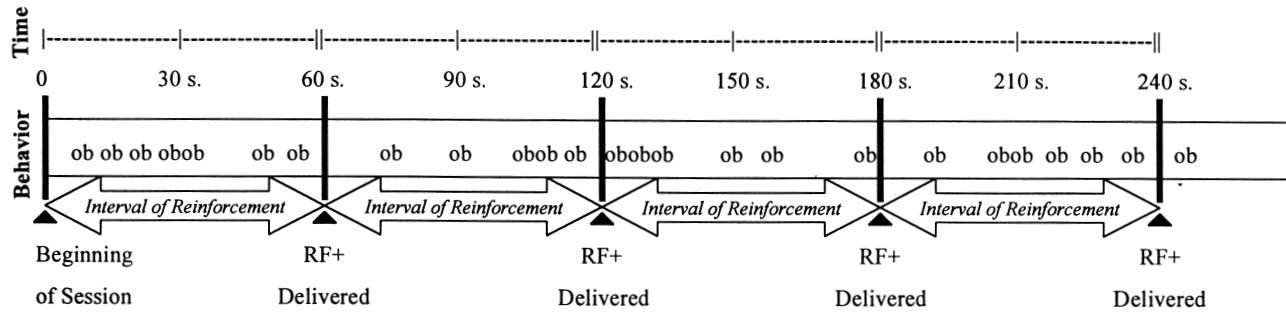

FIGURE 1 Temporal Parameter 1. *Interval of Reinforcement*: The interval of time during which the individual is expected to emit “Other Behavior” than the “Target Behavior” before a reinforcer is delivered. Interval of Reinforcement. Note: This is an example of an individual who is on a 60-s whole-interval DRO schedule. He is engaged in a variety of “Other Behavior” (ob) than the “Target Behavior” (tb) during the entire interval and thus receives his reinforcer at the end of every 60-s Interval of Reinforcement.

and generalization, positive and negative effects of DRO, and how to set-up a DRO intervention.

Although there was once concern that DRO treatment interventions were being underutilized, review papers have demonstrated consistently that DRO schedules are the most frequently used behavioral interventions for suppressing behavior. DRO procedures have also been rated as the most acceptable of the behavior suppression treatment approaches. DRO has been used to suppress a variety of problem behaviors, including: thumb sucking, stereotypies, aggression, food rumination, disruptive behavior, self-injurious behavior, inappropriate verbalizations, and “out-of-seat” behavior in the classroom.

Differential reinforcement of other behavior procedures consist of two basic behavioral elements: (a) reinforcement and (b) extinction. Reinforcement involves the presentation or removal of a stimulus immediately following a behavior that results in increased frequency of that behavior. In the case of DRO, the “behavior” is any behavior other than the target behavior. The extinction component in DRO involves the delaying or withholding of the reinforcer whenever the target behavior is emitted. Hence, we have two basic temporal parameters involved in establishing a DRO intervention: (a) the interval of time during which we expect the individual to refrain from emitting the target behavior (interval of reinforcement; see Figure 1), and (b) the interval of time during which the reinforcer will be withheld (delay interval) following the emission of the target behavior (see Figure 2). Reynolds referred to this as the resetting feature of the differential reinforcement schedule. Rieg, Smith, and Vyse demonstrated in the laboratory that it is not necessarily the absolute length of the interval of reinforcement or the delay interval that predicts the effectiveness of the DRO procedure as much as it is the relationship of these two parameters to one another. These authors concluded that the delay interval should

twice as long as the interval of reinforcement to gain maximum suppressive effect of the DRO intervention.

There are two types of DRO schedules: whole-interval DRO and momentary DRO. The distinction is based on the omission requirement. In whole-interval DRO, the reinforcer is delivered if responding has not occurred for the entire predetermined interval. Hence, the individual must be under constant observation. If the individual emits the target response at any point during the interval, the reinforcer is not delivered. In momentary DRO, the reinforcer is delivered if the individual does not emit the target behavior at the moment the interval ends. Within the momentary DRO schedule, it is possible for the individual to have emitted the target behavior at some point during the interval; however, if the target response does not occur at the precise moment the interval is elapsed, the reinforcer is given. A teacher that reinforces the absence of an undesirable behavior (e.g., physical aggression) at the very moment the bell rings to signal the end of recess is employing a momentary DRO schedule. The momentary DRO schedule is analogous to the momentary time sampling procedure described by Powell, Martindale, Kulp, Martindale, and Bauman. The momentary DRO procedure has the advantage over whole-interval DRO of being easier to implement and requiring less personnel time; whereas; Barton, Brulle, and Repp have also showed it to be as effective in maintaining behavior suppression as whole-interval DRO. These procedures are briefly presented.

In addition to the omission requirement parameter, another variant of the type of interval schedule is either fixed or variable in length. In a fixed schedule, the length of the interval is held constant. In a variable schedule, the length of the interval varies around a predetermined average value. Escalating schedules are also a third possible schedule variation. In escalating DRO schedules, a successfully completed interval results in the delivery of

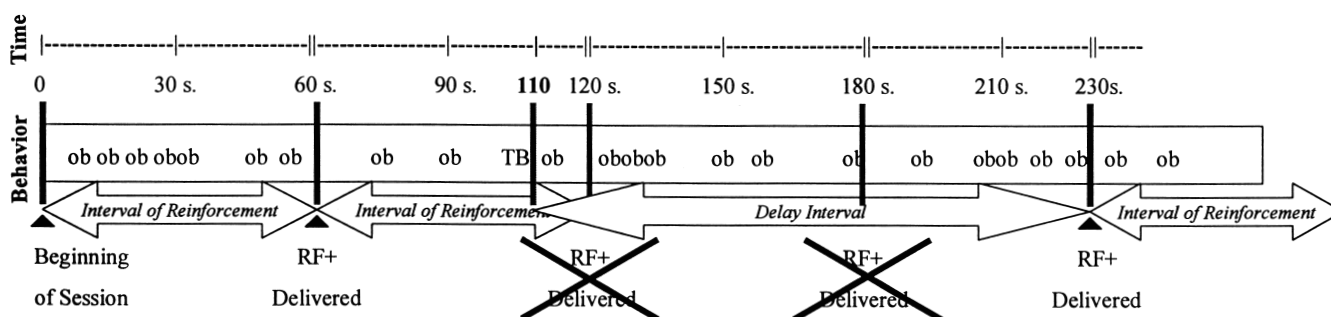

FIGURE 2 Temporal Parameter 2. *Delay Interval*: When the individual emits “Target Behavior” (tb), the time of delivery of the reinforcer is reset. The magnitude of the reset is the *Delay Interval*, which represents the time between the emitting of a “Target Behavior” and the delivery of the next reinforcer. *Delay Interval*. Note: This is an example of an individual who is on a 60-sec whole-interval DRO schedule. He is engaged in a variety of “Other Behavior” (ob) than the “Target Behavior” (tb) during the first interval and thus receives his reinforcer at the end of the first 60-sec Interval of Reinforcement. However, at the 110-sec mark of this observation session, he emits a “Target Behavior.” The next reinforcer is not delivered and the *Delay Interval* starts immediately following the emission of the “Target Behavior.” In this example, the *Delay Interval* is 120 sec. Hence, the individual does not receive a reinforcer until at least 120 sec after emitting a “Target Behavior.” In the above example, the individual did not emit a “Target Behavior” between the 110-sec and 230-sec mark, so a reinforcer was delivered at 230 sec. If he continues to emit only “Other Behavior,” he will continue to receive a reinforcer every 60-sec (*Interval of Reinforcement*).

reinforcement, but also in the increase of the length of the ensuing intervals. Repp and Slack decreased significantly various disruptive responses of students with mental retardation by using an escalating DRO schedule.

Lindberg, Iwata, Kahng, and Deleon presented a 2 × 2 diagram of the four possible DRO contingencies that can be created by alternating the omission requirement (whole-interval vs. momentary) and the type of interval schedule (fixed and variable): fixed whole-interval DRO, fixed momentary DRO, variable whole-interval DRO, and variable momentary DRO (see Table 1). Most DRO contingencies with human participants reported in the literature have been based on fixed whole-interval schedules. Furthermore, an important proportion of these studies have focused on problem behavior such as stereotypy and self-injury maintained by getting attention in people with mental retardation or other developmental disabilities. These four types of DRO schedules are now presented.

A. Fixed Whole-Interval DRO

In fixed whole-interval DRO, the interval length is held constant and reinforcement is delivered for the absence of target behavior throughout the entire interval. In his original description of DRO, Reynolds used a fixed whole-interval DRO in which pigeons had to abstain from pecking for a fixed period of time to have access to the reinforcer. Repp, Barton, and Brulle reported decreases in disruptive behaviors of young boys with

mental retardation using a fixed 5-min whole-interval DRO schedule. Reese, Sherman, and Sheldon reported a fixed whole-interval DRO schedule in combination with response cost and prompted relaxation to decrease the aggressive behaviors of a man with autism and mental retardation. For example, shorter intervals were used in this study during instructional demands versus leisure activities because the demands of the tasks were different and the contextual variables different.

B. Fixed Momentary DRO

Fixed momentary DRO is a schedule in which the interval length is held constant and reinforcement is delivered for the absence of target behavior at the end of the interval. Hence, the person is given a reinforcer if, at the end of the interval, the individual is not emitting the target behavior. All behavior that occurs during the

TABLE 1
Different Schedules of Differential Reinforcement of Other Behavior

	<i>Fixed length interval</i>	<i>Variable length interval</i>
Whole-interval	Fixed whole interval DRO	Variable whole interval DRO
Momentary	Fixed momentary DRO	Variable momentary DRO

interval is ignored and does not cause nondelivery of the reinforcer. Some researcher reported inconsistent strength of suppression of the target behavior while using a fixed momentary DRO procedure. For example, Harris and Wolchick compared the effects of a fixed momentary DRO schedule, time-out, and overcorrection on the stereotypic behavior of four young boys with autism and mental retardation. The authors reported that the DRO contingency produced a moderate decrease in the target response for only one participant; overcorrection was the only treatment that suppressed stereotypy in all four participants.

Some researchers have looked at the utility of the fixed momentary DRO schedule at maintaining the suppression of problem behavior once behavioral control has been gained. Repp, Barton, and Brulle compared the effects of fixed momentary DRO and fixed whole-interval DRO schedules. The results of the study suggested that fixed whole-interval DRO was more effective than fixed momentary DRO at suppressing responding of disruptive behaviors in four young boys with mental retardation, but that fixed momentary DRO maintained previous levels of response suppression attained with a fixed whole-interval DRO schedule. Derwas and Jones also compared fixed whole-interval DRO and fixed momentary DRO as treatments for the stereotypy of five men with severe mental retardation. In contrast to Repp et al., these authors reported that fixed momentary DRO was more effective than fixed whole-interval DRO in decreasing the target response for three of the five participants. They found that one participant responded to fixed whole-interval DRO but was maintained at a low rate in a fixed momentary DRO schedule, and that fixed momentary DRO actually increased the stereotypy of the other participant. With the exception of certain results reported by Derwas and Jones, research indicates that fixed whole-interval DRO is a more effective schedule than fixed momentary DRO to obtain initial suppression of problem behavior. One important limitation of the fixed momentary DRO schedule is its predictability. Individuals can quickly learn that they can emit any behavior during much of the interval as long as they pace themselves with the end of the interval they will receive the reinforcer, regardless of the target behavior emitted during the interval.

C. Variable Whole-Interval DRO

Variable whole-interval DRO is a schedule in which the interval lengths vary across an average value and reinforcement is delivered for the absence of target behavior throughout the entire interval. Very few studies

have examined the effects of variable DRO schedules in humans. Topping and Crowe reported that variable whole-interval DRO and fixed whole-interval DRO were equally effective (and more effective than extinction) in suppressing a key-pressing behavior in college student who had been previously trained to key press on either a fixed-interval or variable-interval schedule of reinforcement.

D. Variable Momentary DRO

Variable momentary DRO is a schedule in which the interval lengths vary across an average value and the reinforcer is delivered for the absence of the emission of the target behavior at the end of the interval. Sisson, Van Hasselt, Hersen, and Aurand reported limited effects of a variable momentary DRO schedule in decreasing disruptive and stereotypic behavior of three children. The authors reported that the 20-sec variable momentary DRO schedule decreased the stereotypy of only one of the participants, and that the addition of overcorrection was needed to ensure maintenance. Lindberg et al. compared the effects of fixed whole-interval DRO and variable whole-interval DRO schedules, and the effects of variable whole-interval DRO and variable momentary DRO schedules in three women with mental retardation who emitted self-injurious behavior maintained by attention from others. Results indicated that variable whole-interval DRO and variable momentary DRO were as effective as the more widely used fixed interval schedules. For all three participants the self-injurious behavior decreased to near zero rates. The study published by Lindberg et al. was more carefully designed than previous studies and demonstrated that variable momentary DRO schedules could be highly effective. The results are interesting because momentary schedules are easier to implement, requiring much less monitoring than fixed DRO schedules.

II. EFFICACY

Many earlier published studies used the DRO schedule in combination with other behavioral strategies when attempting to decrease a target response (e.g., the use of DRO and time out or the use of DRO and overcorrection). These earlier studies made it difficult to untangle the effects of the DRO schedule itself. A number of more recent clinical studies have examined the efficacy of DRO alone. These studies have also looked at the efficacy of DRO procedures when used alone in

suppressing serious and long-standing problem behaviors such as self-injurious behavior

A. Length of Interval

The length of the interval has been shown to contribute to the efficacy of the DRO procedures. Generally, a shorter interval length that is then extended in time will be more effective. A shorter interval offers a greater probability of successful experience (i.e., omission of target behavior) for the participant. The initial length of the DRO interval should be in relation to the mean interval length between target behaviors observed during a baseline condition. Repp et al. empirically demonstrated that a shorter interval resulted in greater suppression of the target behavior compared to an interval length that was twice the mean interval observed during baseline. However, Piazza, Fisher, Hanaley, Hilker, and Derby cautioned against an interval being so short that the person has difficulty discriminating when the target behavior resulted in nondelivery of the reinforcer. As pointed out by Mazaleski, Iwata, Vollmer, Zarcone, and Smith, withholding the reinforcer for a predetermined interval (i.e., extinction) whenever the target behavior occurs, might minimize the problems observed by Piazza et al. It has been demonstrated that DRO suppression strength is maximized when the delay interval (length of time before delivering a reinforcer following the emission of a target behavior) is greater than the interval of reinforcement (interval during which the target behavior must be suppressed before a reinforcer is delivered).

B. Functional Assessment

As noted by Vollmer & Iwata, the lack of efficacy of some DRO interventions are often due to the fact that the authors failed to conduct an a priori functional assessment of the target behavior. Thus, the selected reinforcer must be relevant to the function of the target behavior for this, or any, behavioral intervention to be optimally effective at suppressing a behavior. This is briefly explained in the next section.

III. FUNCTIONAL ASSESSMENT AND REINFORCER PREFERENCE

Despite the straightforward definition of DRO, that is the delivery of reinforcement contingent on the occurrence of any behavior other than the target behavior, many procedural and functional variations have been re-

ported in the literature. For instance, certain studies reset the time interval if the target response has been emitted, whereas others do not use the time resetting feature that was originally described by Reynolds. Certain studies use an arbitrary response-reinforcer relationship whereas others use a functional response-reinforcer relationship (i.e., certain studies conduct a functional analysis before implementing the DRO schedule). The efficacy of the DRO procedure is dependent on the congruence between the reinforcer salience as well as the reinforcer's relationship to the function of the target behavior. Emitting "other behavior" must produce consequences that are of equal or greater value to those produced by the target behavior; or else, the participant will continue emitting the target behavior. Hence, the reinforcer that is delivered for emitting "other behavior" must be able to compete with the reinforcers produced for emitting the "target behavior."

Functional assessment is a process of gathering data surrounding the emission of problem behavior. The data used to conduct a functional analysis is gathered via one or more of the following methods: direct observation, interview of individuals present when the problem behavior is emitted, direct manipulation of the antecedents and consequences, and rating scales.

Reiss and Havercamp have demonstrated that there are clear individual differences in reinforcer preference. In addition to this, Piazza et al. empirically demonstrated that the salience of one reinforcer may not necessarily be the same for two different behaviors within the same individual. Hence, it is important to clearly identify an inventory of reinforcer preferences for each individual and for different target behaviors we wish to suppress. Piazza et al. also found that a reinforcer stimulus for a simple behavior may often lose its salience to reinforce more complex behavioral chains such as the suppression of a well-ingrained problem behavior.

IV. MAINTAINING BEHAVIOR SUPPRESSION AND GENERALIZATION

As Barton et al. demonstrated, although a momentary DRO schedule may not result in as great of a change in behavior suppression as a whole-interval DRO schedule, the former has great potential in maintaining suppression of the target behavior. Barton et al. compared the suppression effects of whole-interval DRO and momentary DRO with nine school-aged students with severe to profound mental retardation and associated sensory and auditory impairments. Target behaviors for all

nine participants were observed and recorded during a baseline phase. Following the baseline phase, the nine participants were placed on a whole-interval DRO schedule to suppress their target behaviors. Then, the participants were randomly assigned to three treatment groups of three participants. The first group of three participants were maintained on the whole-interval DRO to observe its ability at maintaining suppression of the participants' target behavior (A-B treatment design). The second treatment group was moved from the whole-interval DRO to a momentary DRO schedule to study the latter's efficacy at maintaining the suppression of the target behavior (A-B-C treatment design). In the third treatment group of participants, the whole-interval DRO procedure was suspended, and the participants were returned to a baseline treatment state (A-B-A design). The purpose of this intervention was to measure the suppression maintenance effect of "no intervention" on the target behavior and allow comparison with the two other DRO procedures.

This study demonstrated that both whole-interval and momentary DRO were effective at maintaining suppression of the target behavior. The third treatment group (A-B-A) saw a rapid return to previous frequencies of target behavior when the whole-interval DRO intervention procedure was halted. The authors found that momentary DRO schedule was equally effective as a whole-interval DRO schedule in maintaining the behavior improvements. Because momentary DRO is less personnel intensive than a whole-interval DRO schedule, it may be the procedure of choice to maintain suppression of problem behavior. Because it does not demand constant eye-on supervision, the momentary DRO procedure may result in less resistance from direct-care staff and be less likely to be abandoned along the way.

V. NEGATIVE EFFECTS

Although some authors initially claimed that there were no negative effects associated to DRO procedures, this may not always be true. One concern with the use of DRO schedules is the possibility of inadvertently reinforcing a non-target behavior that could become a problem behavior. Skinner accurately described the effects of superstitious conditioning in the laboratory with pigeons. Superstitious behavior, or behavior that is irrelevant to the presentation of the reinforcer, is seen everyday (e.g., in gambling establishments). Inadvertent reinforcement within a DRO procedure might occur when the presentation of a reinforcer immedi-

ately follows a behavior that happens to occur at the end of an interval. For example, if a child is on a 10-min fixed whole-interval DRO schedule and the target behavior is being out of seat. At the end of a 10-min interval during which the child sat quietly but might have been throwing spit balls at a peer, the child will receive the reinforcer. In this situation, the child's throwing of spit balls might be accidentally reinforced.

Cowderly, Iwata, and Pace reported that their DRO procedure was associated with a intense emotional reaction on the part of the child. In their study, a 9-year-old boy with borderline intellectual functioning and severe scratching and skin-rubbing behavior became upset and cried each time he was told that he had failed to earn his reinforcer for the preceding interval because of the presence of self-injurious behavior. Some negative side effects can be avoided by conducting a systematic thorough reinforcer preference.

Generally speaking, DRO procedures are among the least restrictive procedures used to suppress problem behaviors. In addition, DRO procedures generally result in the least negative side effects and are the most accepted form of intervention.

VI. STEPS TO SETTING-UP A DRO INTERVENTION

1. Operationally define the target behavior. Use terminology that is observable and measurable and non-judgmental (i.e., yells, throws objects, and punches vs. gets angry).
2. Conduct a functional assessment of the problem behavior. Also useful may be a scatter plot.
3. Conduct a reinforcer preference inventory for the individual and identify the most salient reinforcers.
4. Establish the preferred type of schedule of reinforcement; Fixed whole-interval DRO, variable whole-interval DRO, fixed momentary DRO, variable momentary DRO. The choice of a DRO schedule may depend on the baseline frequency of the problem behavior as well as the availability of trained personnel to effectively carry out the procedure. A whole-interval procedure may work best initially to suppress the target behavior and can then be replaced by a less personnel-consuming momentary schedule. A variable interval schedule has the advantage of being more difficult to predict the time of delivery and results generally in learning (e.g., to suppress the target behavior) that is more resistant to extinction than a fixed interval schedule of reinforcement.

5. Determine the most efficient other behavior \leftrightarrow reinforcer interval (interval of reinforcement). Poling & Ryan described calculating the average interresponse time observed during a baseline condition to determine an efficient interval. A cooking timer is generally adequate, however, recording beeps at the predetermined intervals onto an audiotape can be less disruptive when an ear piece is used. The use of a handheld behavior observation system is obviously the most elegant and expensive.

6. Determine the most efficient target behavior \leftrightarrow reinforcer interval (delay interval—resetting feature). Uhl and Garcia suggested delaying the reinforcer (delay interval) for a duration that is greater than the interval of reinforcement.

7. Set up your data-recording materials.

8. Train the necessary people (e.g., direct-care staff, parents, teachers, etc.) on conducting the DRO and data recording.

9. Review behavioral data and revise DRO procedure as needed (i.e., you will want to gradually increase the interval once you've gained control of the target behavior).

VII. SUMMARY

In summary, DRO is the most commonly used procedure for suppressing problem behavior. There are several different types of DRO schedules: fixed momentary DRO, variable interval momentary DRO, fixed whole-interval DRO, and variable whole-interval DRO. There are several crucial elements to consider when selecting a DRO schedule. These elements include the function of the target behavior and the selection of an appropriate reinforcer, the frequency of the target behavior, the length of the interval of reinforcement, the use of a delay interval and its length, the choice between a whole-interval versus a momentary interval schedule, and the choice between a fixed or variable interval time. Numerous studies have shown DRO procedures to be among the most effective in suppressing problem behavior and maintaining suppression of problem behavior through the delivery of reinforcement contingent on the absence

of the target behavior. In addition to being an effective behavior suppression techniques, DRO procedures have also garnered the highest ratings of treatment acceptability from professionals and parents.

See Also the Following Articles

Conditioned Reinforcement ■ Covert Positive Reinforcement ■ Differential Attention ■ Discrimination Training ■ Habit Reversal ■ Negative Reinforcement ■ Positive Reinforcement ■ Response-Contingent Water Misting ■ Response Cost

Further Reading

- Carr, E. G., Horner, R. H., Turnbull, A. P., Marquis, J. G., McLaughlin, D. M., McAtree, M. L., Smith, C. E., Ryan, K. A., Ruef, M. B., & Doolabh, A. (1999). *Positive behavior support for people with developmental disabilities*. Washington, DC: American Association on Mental Retardation.
- Cipani, E. (1989). *The treatment of severe behavior disorders: Behavior analysis approaches*. Washington, DC: American Association on Mental Retardation.
- Homer, A. L., & Peterson, L. (1980). Differential reinforcement of other behavior: A preferred response elimination procedure. *Behavior Therapy, 11*, 449–471.
- O'Neill, R. E., Horner, R. H., Albin, R. W., Sprague, J. R., Storey, K., & Newton, J. S. (1997). *Functional assessment and program development for problem behavior: A practical handbook*. Pacific Grove, CA: Brookes/Cole Publishing Company.
- Piazza, C. C., Fisher, W. F., Hanaley, G. P., Hilker, K., & Derby, K. M. (1996). A preliminary procedure for predicting the positive and negative effects of reinforcement-based procedures. *Journal of Applied Behavior Analysis, 29*, 137–152.
- Poling, A., & Ryan, C. (1982). Differential-reinforcement-of-other-behavior schedules: Therapeutic applications. *Behavior Modification, 5*, 3–21.
- Skinner, B. F. (1953). *Science and human behavior*. New York: MacMillan.
- Singh, N. N. (Ed.). (1997). *Prevention and treatment of severe behavior problems: Models and methods in developmental disabilities*. Pacific Grove, CA: Brookes/Cole.
- Vollmer, T. R., & Iwata, B. A. (1992). Differential reinforcement as treatment for behavior disorders: Procedural and functional variations. *Research in Developmental Disabilities, 13*, 393–417.



Discrimination Training

Lisa W. Coyne and Alan M. Gross

University of Mississippi

- I. Description of Treatment
- II. Theoretical Bases
- III. Empirical Studies
- IV. Summary
- Further Reading

stimulus control Control over the occurrence of a response by a discriminative stimulus (S+).

I. DESCRIPTION OF TREATMENT

Discrimination training refers to the process by which an individual learns to perform a particular response in the presence of a designated stimulus (S+) while inhibiting this response in the presence of other stimuli (S-). A typical procedure used to train behaviors to come under discriminative control involves the presentation of two different stimuli, one that acts as a discriminative stimulus (S+), cueing the individual to respond, and one that acts as a cue for the response to stop (S-). If an individual performs the desired behavior after the correct cue, she or he will receive a reward. However, if the response occurs after the wrong cue is presented, no reward is provided. Such differential reinforcement of behavior after the presentation of different stimuli results in an increased likelihood of responding following the S+, and decreased response rates, or even an absence of responding, in the presence of other cues. For example, even people can be discriminative stimuli: A child might make a special request from mom if she appears to be in a good mood (S+). However, if mom is grouchy and stomping around the house (S-), the child is likely to keep quiet.

Stimulus discrimination can be thought of as the opposite of stimulus generalization, a process by which an

GLOSSARY

discriminative stimulus A neutral stimulus that predicts when the performance of a particular response will lead to a desired outcome.

extinction In classical conditioning, the weakening and eventual disappearance of a learned response that occurs when the conditioned stimulus (CS) is no longer paired with the unconditioned stimulus (US). In operant conditioning, the process in which a reinforcer is repeatedly left absent after the occurrence of a behavior, resulting in the inhibition of that behavior.

generalization The degree to which novel stimuli resembling the original discriminative stimulus (S+) or conditioned stimulus (CS) elicit a behavioral response.

generalization gradient A decline in the magnitude of a response with increases in the physical difference from the original stimulus (S+), or an increase in magnitude corresponding with decreases in the physical difference of the S+.

postdiscrimination gradient A term coined by Kenneth W. Spence in his 1937 paper on discrimination training. The postdiscrimination gradient is derived from the interaction of the excitation and inhibition gradients elicited by a single stimulus.

individual learns to respond the same way while in the presence of two or more similar stimuli. For example, an infant may see a dog, and be rewarded repeatedly by a parent for saying “dog.” Fairly soon, all four-legged, friendly neighborhood animals are called “dogs,” whether they be cats, goats, or guinea pigs. Of course, the more similar in appearance the new animal is to the original dog, the more likely the child is to call it a dog. This behavior demonstrates the idea of a generalization gradient, or the notion that the strength of a response to a given stimulus is a function of its similarity to the original discriminative stimulus. When an individual undergoes discrimination training, the reverse is true: Learning to respond differentially when in the presence of two stimuli is easier if those stimuli are very different. For example, it is easier for a child to learn the difference between red and blue than between red and orange.

Both the concepts of stimulus discrimination and stimulus generalization are dependent on the notion of stimulus control. When a given cue determines how likely someone is to perform a particular behavior, that behavior is said to be under stimulus control. For example, in a 1980 study, K. D. Brownell, A. J. Stunkard, and J. M. Albaum attempted to attain stimulus control over using the stairs rather than an escalator in a shopping mall, a train station, and a bus terminal. The stimulus used was a poster depicting a “healthy” heart climbing the stairs, and an “unhealthy” heart riding an escalator. The poster’s caption read: “Your heart needs exercise, here’s your chance.” Results indicated that the use of the stairs increased significantly during the time the “intervention” was posted. A reasonable conclusion of this study is that the poster exerted stimulus control over stair-climbing behavior.

Teaching an individual to respond discriminately when in the presence of different cues is a somewhat different matter. One of two methods of discrimination training typically are used. Simultaneous discrimination training is a technique in which both S+ and S– are presented at the same time. For example, suppose an individual was presented with a circle and an ellipse, and had to correctly identify which was the circle in order to earn a reward. This person has access to both stimuli at the same time, and must compare and choose between the two immediately. On the other hand, in successive discrimination training, the two stimuli are presented sequentially, or one after another. An example of this would involve presentation of a Pepsi and a Coke, which an individual would have to try one after the other, to correctly determine which was the Pepsi to get a reward.

Of these two techniques, simultaneous discrimination is most commonly used in applied settings, and is

thought to be superior to successive methods. Research comparing the two techniques has yielded comparable results; however, some studies have indicated that simultaneous presentation of stimuli leads to better generalization effects. For example, in a 1978 generalization study by Marion C. Panyan and R. Vance Hall, investigators examined the effects of both simultaneous and successive stimulus presentation in training two females with severe developmental disabilities on vocal imitation and tracing tasks. Each participant experienced both the concurrent and serial conditions. In the concurrent condition, the two women were required to practice a tracing task for 5 minutes, then a vocal imitation task for 5 minutes, and finally, to return to the tracing task for the last 5 minutes. Subsequent sessions reversed the order of task presentation. In the serial condition, the participants were required to gain mastery over either the tracing task or the imitation task first (or complete 200 trials) before moving on to the remaining task. Although no differences between serial and concurrent training methods in terms of number of trials required to gain mastery were found, concurrent presentation appeared to result in better generalization of skills to untrained items. In other words, if a participant was presented a novel consonant sound, she was more likely to demonstrate some skill in imitating it directly following a concurrent than a serial training session.

In addition to presenting cues in a simultaneous or successive manner, the schedule of reward distribution may also vary. In concurrent schedule discrimination training, an individual must choose between two response options simultaneously. For example, an individual has the option to press either a red button or green button. The red button signifies delivery of reward every 3 minutes, while the green button denotes rewards every 6 minutes. This reward schedule is likely to impact how often and when these buttons are pressed. If a multiple schedule is used, stimuli are presented successively, and reinforcement is given differentially in a sequential manner. Consider the example of a pigeon trained to peck a light that varies in color from red to green. When the light is red, the pigeon may be rewarded on an average of once per 2 responses, but when it is green, the pigeon’s pecks are rewarded on an average of once per 10 responses. If this is a smart bird, it will likely learn to peck the most efficient way to gain the most reinforcers—that is, pecking less often when the light is red, and at a higher rate when the light is green. To evaluate the degree of discriminative control, researchers look for differential response rates between the two stimuli.

In conditional discrimination, a process by which an individual is required to make a certain response during presentation of one stimulus and a second, different response, during the presence of a second stimulus, responding is said to be “conditional,” or dependent, on the stimulus presented. For example, in receptive labeling tasks, children with speech comprehension and production difficulties are required to point to or touch one of two different objects named by the teacher. First the child is presented with a cookie, which the teacher names for the child. When the child touches the cookie, she or he can have a taste of it. Next, when the child has reliably learned to reach for the cookie when the teacher says “Where’s the cookie?,” it is presented in conjunction with another item. If an apple and a cookie are presented and the instructor asks, “Where’s the cookie?,” the child must reach for the cookie. If the correct response is given, the cookie is delivered. If not, the cookie is removed for a brief period. Eventually, the child must respond correctly to randomly presented pairs of objects—this constitutes a conditional discrimination task, as either choice may be correct at a given time.

A number of factors influence the ease of discrimination training and the stability of stimulus control. Namely, these factors include degree of similarity between $S+$ and $S-$, as discussed previously. The “information value” of the stimulus is also important. If an employee is rewarded every time he or she performs a task for one supervisor but rarely when a task is performed for another supervisor, the instructions of the former boss may be more salient to that worker. Thus, the first boss may elicit a better, more consistent performance than the second. In addition, the effects of prior discrimination learning may also enhance the development of discriminative control. In 1952, the “easy to hard” effect was first described by D. H. Lawrence, who used rats to examine how well they transferred the learning of one task to a similar, but more difficult one. Results suggested that if a relatively easy task was taught first, performance was facilitated later when more difficult tasks were attempted. Finally, the differential outcome effect, which refers to the degree to which a particular response leads to a unique outcome, also plays a role in discrimination learning. That is, differential responding occurs more readily when a particular response results in a particular outcome, and when other responses lead to significantly different outcomes. Continua along which outcomes must differ include magnitude, delay of reinforcement, or quality of reward.

In the clinical realm, discrimination training is often used in a population of both adults and children with

developmental disabilities. For example, it has been used to enhance receptive and expressive speech, visual discrimination of relevant cues, the development of social skills, and to reduce problem behaviors such as aggression and pica. More diverse applications of discrimination training involve its use in biofeedback training, in marital therapy, and behavioral health.

II. THEORETICAL BASES

There are two dominant theories of discrimination learning, developed through the use of animal models. The first, conceptualized by C. L. Hull and Kenneth W. Spence in 1936, involves a few major assumptions. Simply put, Hull and Spence believed that a given stimulus had both excitatory properties (properties that would lead an individual to respond) and inhibitory properties (properties that would lead an individual to not perform a response). These properties, they argued, interacted: Whichever property predominated dictated whether an individual would respond. The $S+$, which by definition results in the performance of a particular behavior, has more excitatory than inhibitory strength. Other stimuli, especially if they are very different from the original discriminative stimulus, may have stronger inhibitory than excitatory effects. The opposite is true of cues highly similar to the discriminative stimulus. The underlying assumption of this idea is that both the excitation and inhibition to a given stimulus are thought to generalize to other, similar stimuli. This explains the generalization gradient phenomenon, as well as the fact that discrimination tasks comparing two very different stimuli are more difficult to learn than those contrasting similar cues.

In an extensive 1981 review, Werner K. Honig and Peter J. Urcuioli argue that the Hull–Spence theory of discrimination has a great deal of support from generalization studies, or experiments requiring rats or pigeons to discriminate between two stimuli. In these studies, the animal is presented with a variety of stimuli, each sharing some similarity with the $S+$. The rate of responding under each condition of the stimulus is recorded in a graph, which typically depicts the highest rate of responding (the peak of the curve). This peak is thought to correspond with the excitatory properties of a stimulus, and thus is often called an excitatory gradient. Similarly, an inhibitory gradient, or the lowest point of the curve, representing the lowest rate of responding, can be demonstrated in extinction studies, in which responses given in the presence

of different stimuli do not result in a reward. If Hull and Spence were correct in believing that each stimulus had both inhibitory and excitatory properties, this would allow an interesting prediction. Because each different stimulus evokes both excitation and inhibition, these tendencies interact to produce a gradient of responding called the postdiscrimination gradient. Further, they would result in a shift of peak responding *away* from the original discriminative stimulus. A vast number of animal studies have supported this hypothesis in their demonstration of a peak shift, or a displacement of the peak of the excitatory gradient away from the original S+. Some researchers have suggested that degree of displacement is directly related to the dissimilarity between S+ and S- cues. That is, if the S+ is vastly different than the S-, peak shift tends to be minimized. If the cues are similar, peak shift will be larger.

The first individual to demonstrate the peak-shift phenomenon was Harley Hanson, in his 1959 doctoral thesis. In the first phase, he trained pigeons to earn a food reward by pecking a key during the S+ stimulus, which was a colored light with wavelength at 550 nanometers. He then presented different groups of pigeons with a variety of cues differing along a continua of wavelengths, but continued to deliver reinforcement when they pecked a key subsequent to the presentation of the 550 nanometer light. The third phase of the experiment consisted of generalization testing, during which he presented light stimuli in varied hues (ranging from 480 to 600 nanometers). Hull-Spence theory would predict a displacement of maximum responding away from the original 550 nanometer S+ in the direction opposite that of the S-. Indeed, in discrimination groups, the maximum rate of responding did not occur at the original S+, but was shifted away, in the predicted direction. In addition, the degree of shift appeared dictated by the difference between S+ and S- cues. The more similar S+ was to S-, the greater the peak shift; the less similar, the less pronounced the displacement. Since this initial study, a number of other animal studies have also demonstrated this phenomenon, both in pigeons and rats.

In contrast to Hull-Spence theory, N. S. Sutherland and N. J. Mackintosh forwarded a competing theory in 1971. They posited the attention theory of discrimination, which they argued involved two processes. Primarily, they suggested that the attention of an individual is affected when that person is reinforced. That is, the individual's attention is drawn to salient features of stimuli around them. Secondarily, they ar-

gued that the brain comprises "analyzers" whose function is to receive and process sensory information. Each dimension of a stimulus is processed by a different analyzer. When discrimination training begins, the strength of an analyzer is correlated with the strength of an incoming signal. If a given stimulus has salient features, the individual's attention will be drawn to it. Further, if a subject attends to a particular stimulus, performs the appropriate response and is rewarded, the analyzer for that stimulus is thought to gain strength. Other analyzers corresponding to less relevant stimuli are thought to weaken. Sutherland and Mackintosh suggest that a "bond" develops between a specific response and its analyzer. This theory accounts for how the information value of a given stimulus affects the ease of discrimination learning.

A 1973 study by T. G. Waller examining consistency of reward delivery on runway performance in a rat model provided support for the attention theory of discrimination. Of four groups of rats, two groups ran an alleyway and were rewarded at the goal box on every trial. The remaining two groups received reward for this performance only 50% of the time. One group in each of the two conditions (100% reinforcement and 50% reinforcement) ran an alleyway that was gray in color, while the other group in each condition ran a vertically striped alley. In phase two of the experiment, all subjects were trained to choose between two goal boxes—one with stripes slanting to the right, and one with stripes slanting to the left—for a food reward. Attention theory would predict that of the groups originally trained to run the striped alleyway, the 50% group would learn the discrimination less readily than the 100% group, because their analyzer for this cue is weak relative to that of the 100% group. In addition, proponents of attention theory would expect that groups trained in the gray alleyway would learn the discrimination task equally well. Because these rats had no exposure to stripes, their analyzer strength for this stimulus would be about equal. Results indicated that rats trained in the gray alley learned the task at roughly the same rate, whereas of the rats that experienced the striped alley in phase 1, the 50% reinforcement group took more trials to learn the task than did the 100% reinforcement group.

III. EMPIRICAL STUDIES

A great deal of research from animal models supports the efficacy of discrimination training in a labo-

ratory setting. In addition, there is a wealth of clinical research supporting the effectiveness of discrimination training in real world settings, especially among populations that demonstrate difficulty with discrimination tasks. Discrimination training in the clinical realm has proven effective in teaching new skills, as well as modifying inappropriate behaviors such as impulsivity, either as a treatment modality in itself, or integrated in a multicomponent behavioral intervention. One way in which discrimination training is used in a clinical population was formulated in the 1960s by Ole Ivar Lovaas to teach autistic children receptive and expressive language skills. First, the child is taught receptive labeling, followed by speech imitation training. In receptive labeling, a teacher presents desired objects—such as toys or edibles—and gives a simple phrase or question, such as “cookie,” or “Where’s the cookie?” For children to earn this reward, they must perform a simple task such as pointing toward or touching the named item. If they do not complete the desired task, the teacher models the appropriate response for them, and then may physically prompt the child. However, no reward is given: acquisition of the desired item is contingent on the correct response. In this model, the teacher’s statement serves as a discriminative stimulus for the response of non-verbally indicating the object. After a child learns to indicate a given object in a reliable way without prompting, a new object is introduced, and the procedure is repeated. Finally, the two objects are presented simultaneously, and the teacher names either one, in random order, rewarding the child for correct identifications.

In addition to teaching language skills, the field is replete with studies demonstrating possible applications of discrimination training. For example, in a 1977 study, David Marholin and Warren Steinman examined the development of stimulus control in the classroom. Investigators explored reasons why children may exhibit appropriate behaviors in one classroom setting, but act inappropriately in another. Marholin and Steinman hypothesized that due to reinforcement and punishment given by a teacher, that teacher’s presence may serve as a discriminative stimulus for appropriate behavior. In the teacher’s absence, children’s behavior may devolve into disruption and off-task antics. To test this hypothesis, authors assessed the academic performance of eight children ranging in age from 10 to 12 years and demonstrating conduct problems as well as poor academic performance. The study was conducted in a typical classroom setting. Using an ABCBC design,

the first condition (A) served as a baseline, during which the children received no reinforcement, while during the second (B), the teacher reinforced appropriate behavior. The third condition (C) was characterized by reinforcement of both the rate and accuracy of on-task academic performance. Each session lasted for 30 minutes. For the final 3 sessions of each condition (A, B, and C), the teacher was absent for a 10-minute period. Two independent raters collected data on both appropriate and inappropriate behaviors, while the teacher was present and absent. Examples of appropriate behaviors included looking at books or handouts, getting out materials, writing answers, etc. Inappropriate behaviors comprised fidgeting, speaking out, or physical aggression.

Results indicated that the presence of the teacher made a big impact on children’s behavior. Specifically, the students demonstrated much higher levels of disruptive and off-task behavior while the teacher was not present, regardless of which contingency condition was in operation. Predictably, however, children engaged in more on-task behavior while they were reinforced for academic behaviors (remember, reinforcement was contingent on the teacher’s presence). On-task behavior was at peak levels when the children experienced condition C, under which they received reinforcement for rate and correctness of academic work. This differential rate of on-task behavior across teacher-present and teacher-absent conditions supports the notion that the teacher had become a discriminative stimulus for on-task behavior. Yet teachers are occasionally absent, so some attempt must be made to encourage generalization of on-task behavior to teacher-absent conditions. The authors suggested that reinforcement for the quality of a child’s work (as in condition C) rather than on-task behavior *per se* (as in condition C) may foster the transfer of discriminative control from the teacher to academic materials.

IV. SUMMARY

Discrimination training refers to the process by which a subject learns to respond differentially to two or more different stimuli. To bring a behavior under discriminative control, responses to the correct cue (S+) are rewarded, while responses to the wrong cue (S–), are not. The discriminative control of a stimulus may be assessed by an increased probability of responding to S+, and a decrease in, or absence of, responding in the presence of S–. Two dominant theories of discrimination

learning serve as underpinnings of discrimination training. Hull–Spence theory suggests that each cue has both excitatory and inhibitory properties, which summate algebraically to produce a response. Whether or not the subject responds in the presence of a particular stimulus is dependent on whether the excitatory strength of that stimulus outweighs its inhibitory properties. Hull–Spence theory draws empirical support from experiments examining the peak shift phenomenon. In contrast, Sutherland–Mackintosh attention theory of discrimination suggests that when a stimulus predicts a reward, that stimulus captures a subject’s attention. The relative salience of a stimulus is directly related to how readily a subject learns a discrimination task. A plenitude of research, typically animal studies, supports this theory. Discrimination training has been used for a variety of clinical issues, including social skills training, biofeedback training, and modification of severe behavior problems.

See Also the Following Articles

Classical Conditioning ■ Differential Reinforcement of Other Behavior ■ Extinction ■ Operant Conditioning ■ Response Cost

Further Reading

- Dinsmoor, J. A. (1995). Stimulus control: Part I. *Behavior Analyst*, 18, 51.
- Hanson, H. M. (1959). Effects of discrimination training on stimulus generalization. *Journal of Experimental Psychology*, 58, 321.
- Honig, W. K., & Urcuioli, P. J. (1981). The legacy of Guttman and Kalish (1956): 25 years of research on stimulus generalization. *Journal of Experimental Analysis of Behavior*, 36, 405.
- Lovaas, O. I. (1977). *The autistic child*. New York: Irvington Publishers.
- Marholin, D., & Steinman, W. M. (1977). Stimulus control in the classroom as a function of the behavior reinforced. *Journal of Applied Behavior Analysis*, 10, 465.
- Newsom, C. (1998). Autistic disorder. In E. J. Mash, & R. A. Barkley (Eds.), *Treatment of childhood disorders* (2nd ed.). New York: Guilford.
- Spence, K. W. (1937). The differential response in animals to stimuli varying within a single dimension. *Psychological Review*, 44, 430.
- Spiker, C. C. (1970). An extension of Hull–Spence discrimination learning theory. *Psychological Review*, 77, 496.
- Sutherland, N. S., & Mackintosh, N. J. (1971). *Mechanisms of animal discrimination learning*. New York: Academic Press.
- Tarpy, R. M. (1997). *Contemporary learning theory and research*. New York: McGraw-Hill.

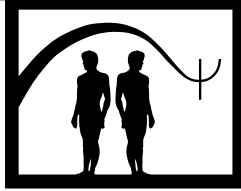

Documentation

Norman Andrew Clemens

Case Western Reserve University

- I. Principles and Purposes
 - II. Dilemmas and Controversies
 - III. Legal Requirements
 - IV. Federal Privacy Regulations
 - V. The General Clinical Record
 - VI. Protected Psychotherapy Notes
 - VII. Therapist's Personal Working Notes
 - VIII. Case Examples
 - IX. Summary
- Further Reading

GLOSSARY

general clinical record Includes the patient's name, the date, duration of time spent with the patient, nature of the service and service code, and clinician signature.

health care documentation Requires that a record be factual, complete, legible, and maintained concurrently with provision of the service being documented.

privacy rule Creates a high standard of privacy for psychotherapy notes. These are identifiable but kept in a separate part of the health care manual.

protected psychotherapy notes Establishes an absolute privilege for information disclosed in psychotherapy or counseling.

I. PRINCIPLES AND PURPOSES

Standard principles of health care documentation require that a record be factual, complete, legible, and

maintained contemporaneously with the provision of the service being documented. Documenting psychotherapy services poses special challenges because of the extremely sensitive nature of the material brought forth in a confidential atmosphere of trust. Strong legal and ethical principles underlie the confidentiality of medical services in general. The confidentiality of psychotherapy is given a special status of privilege in state courts, and this privilege was extended to federal courts in the 1996 U.S. Supreme Court decision in *Jaffee v. Redmond*. The special status of psychotherapy notes is a significant element of the federal regulations that the Department of Health and Human Services (HHS) developed at the direction of the Health Insurance Portability and Accountability Act (HIPAA) of 1997, to take effect in 2003. These regulations may bring order and consistency to what has been a heterogeneous and sometimes controversial approach to documenting psychotherapy in actual clinical practice.

The health care record has multiple purposes and many potential readers, intended and unintended. For the clinician and the patient or client, it is a record of diagnosis and treatment that serves continuity of care both by the treating clinician and any succeeding caregiver. In an organized setting such as a hospital or clinic, it may facilitate knowledgeable treatment by circulating information among a number of caregivers. The record may also benefit future patients by contributing data to research. Medical information is often requested by third-party payers to assess the validity of health care insurance claims. In the era of managed

care, this information is often demanded in advance of authorizing payment for anticipated treatment services, often with controversial implications because unknown people in the managed care organization presume to judge the medical necessity of recommended treatment without any firsthand knowledge of the patient or assurance of training equivalent to that of the patient's therapist. With self-insured employers, medical information about employees may be reported back to employers to obtain payment.

If there is contention about the care given to a patient, as in malpractice litigation or an ethics investigation, the record may provide a relatively objective, contemporaneous account of what did or did not transpire; an old legal saw is, "If it isn't in writing, it didn't happen." Medical records may also be sought if the information therein is relevant to a civil lawsuit or criminal investigation, prosecution, or defense. There are detailed legal processes that attempt to strike a balance between protecting privacy and permitting access to all relevant information in pursuit of justice.

Needless to say, in view of its importance to the patient and its legal ramifications, the record should be professional and respectful. Humorous, flippant, or demeaning remarks about a patient have no place in a clinical record.

II. DILEMMAS AND CONTROVERSIES

The information documented in a psychotherapy record is of a different nature than routine clinical or administrative data. Whereas the latter includes history as narrated by the patient or others, observations and physical or mental examination findings by the clinician, laboratory data, treatment plans, prescriptions, and side effects, and so on, psychotherapy data are much more subjective. Furthermore, as acknowledged both by the U.S. Supreme Court in *Jaffee* and in the HIPAA rules, psychotherapy material is elicited in an atmosphere of privacy, trust, and complete freedom to speak one's thoughts. It may include repetitive thought patterns, dreams, fantasies, wishes, revelations of behavior that induce shame or guilt, or details of the intimate lives of the patient and other people. The psychotherapy cannot take place unless these things are addressed, and they will not be addressed unless the patient knows that whatever is spoken will not adversely affect either the patient or other people in relationships. This incontrovertible fact necessitates a higher level of

protection for the contents of psychotherapy discourse. The privacy of one's mental life and ideas is a most cherished value.

A powerful dilemma ensues: On the one hand, documentation protects the patient and the therapist and may facilitate treatment. On the other hand, documentation of the intimate mental contents of psychotherapy could expose the patient to embarrassment and damage. Although unlikely, disclosures of contents of the record could occur involving other facility personnel, courts, attorneys, law enforcement officials, researchers, insurance carriers, managed care companies, or employers making personnel decisions.

There is a wide variation in the way psychotherapists handle this dilemma, depending on the locus of treatment, the therapist's technical and theoretical orientation, the nature of payment, and the potential risks of invasion of the record. Many therapists, especially in solo private practice, keep minimal records. Some keep none, which forestalls access to any written psychotherapy information by third parties for any reason (although it does not preclude a subpoena of the therapist for testimony). However, it also exposes the therapist to serious legal risks and may detract from the continuity and coordination of care. In hospitals or multidisciplinary, ambulatory settings a detailed record may be required by institutional standards and the exigencies of coordinating care by a variety of caregivers. In training situations detailed notes may be essential for supervision or consultation with more experienced clinicians.

Some varieties of treatments require special approaches. In group therapy, the leader may make a general note describing the process of each meeting of the group, identifying individuals only by first name if at all, and then write an individual note for each patient's chart that does not mention other patients. For psychoanalytic treatment in a high frequency of sessions, an American Psychoanalytic Association practice bulletin states a rationale that requiring daily notes may actually be detrimental to the treatment process. This is because such a focused activity interferes with the free-associative attention state of the psychoanalyst that allows processing the analytic experience at multiple levels of consciousness.

Many therapists safeguard psychotherapy information by writing a factual clinical note that gives little detail about the psychotherapy contents, and then keeping personal notes in which the identity of the patient cannot be discerned and the intimate contents of psychotherapy can be detailed. This is a common

procedure when very close examination of the process of treatment sessions is necessary for supervision, training, or research. Audio- or videotaping may achieve similar educational purposes but necessitate special editing to remove identifying material. This practice is the only way in which the psychotherapy proceedings can be recorded and closely studied without exposing the patient to damaging disclosures. However, the custom is decried by malpractice defense attorneys because it creates a “shadow” record that cannot be corrected by the patient or used in a courtroom without a fight to support a contested subpoena. Yet, prior to the protections afforded by *Jaffee v. Redmond* or the HIPAA rules, it was the only way to create a detailed record for study or supervision, despite a slight degree of risk of invasion by a legal proceeding.

III. LEGAL REQUIREMENTS

Some states require that all health care services be documented. In other situations documentation may not be specifically mandated, but failure to maintain documentation may be interpreted in legal proceedings as a lapse in meeting a generally accepted standard of care in the community. Some professional organizations require documentation as an essential component of care, whereas others do not specify this. Maintaining confidentiality of psychotherapy records receives strong emphasis in health care professional organizations’ ethical codes. Hospitals and other organized settings may establish their own requirements for documentation, and systematic record-keeping practices are essential requirements of private and public accreditation organizations.

IV. FEDERAL PRIVACY REGULATIONS

The final HIPAA privacy rule was published in the *Federal Register* in December, 2000, to take effect in April, 2003 for most health care entities and 2004 for smaller plans, barring intervention by Congress or the Bush administration. It applies to all identifiable health care information recorded in any medium, written or electronic. Crucially for the integrity of psychotherapy, it creates a higher standard of privacy for “psychotherapy notes,” which would be identifiable but must be kept in a separate part of the health care record. Whereas only a low level of blanket con-

sent is required for the use of the general medical record for treatment operations or claims payment, the patient must give specific authorization for disclosure of psychotherapy notes. Authorization must be dated with a time limit and state the recipient of the information as well as the nature of the information to be disclosed. If the patient wishes to have psychotherapy records transmitted to another professional, an insurance company, an attorney for legal proceedings, and so on, that patient must sign an authorization to do so. Authorization is not required for disclosure of records if the patient sues the therapist or the therapist is investigated by a state licensing board or other oversight authority. The therapist is permitted (not required) to disclose without authorization information “necessary to prevent or lessen a serious and imminent threat to the health or safety of a person or the public.”

The implications of the HIPAA privacy rule are far-reaching for the procedures for maintaining documentation of psychotherapy in all settings, although technically they apply only if the practitioner communicates patient information electronically in any fashion. When the rule goes into effect, there will be three potential levels of documentation of psychotherapy services.

V. THE GENERAL CLINICAL RECORD

The basic clinical record or medical record for psychotherapy is similar to that for any other medical service. Elements that frame the notation include the patient’s name, the date, the duration of time spent with the patient when time is an essential part of the service code (start and stop times in some instances), the nature of the service and the service code, and the signature of the clinician. Service codes are usually drawn from the AMA’s *Current Procedural Terminology* (CPT). The clinical substance of the note may include any or all of the following: relevant history, symptoms and signs, observations and examination findings, laboratory findings, results of other tests such as CT or MRI imaging studies, standardized symptom rating scales, psychological tests, diagnosis, functional status, the treatment plan, prognosis, and progress. If the patient is receiving medications as well as psychotherapy, notations regarding prescriptions, therapeutic effects, and side effects are also part of the general clinical note. If the service is “psychotherapy with medical evaluation and management (E&M)” conducted by a psychiatrist, the E&M

services are generally delineated in the general medical record along with documentation that psychotherapy took place. As defined by the AMA's CPT, E&M services include elements of assessment, medical decision making, and management of the patient.

At the beginning of a treatment relationship the treating clinician conducts a full evaluation of the patient according to the procedures of the clinician's discipline. An initial psychiatric examination would include a history of the present illness; past psychiatric history; family and personal histories; general medical history that includes use of tobacco, alcohol, and other drugs or chemicals whether prescribed or not; a detailed mental status examination; perhaps some elements of a physical examination; a differential diagnosis and formulation of the case; and a plan for further evaluation and treatment. This full examination becomes the cornerstone of the basic clinical record. If the patient is being transferred from another clinician and the information from past evaluation and treatment is available to the new clinician, the initial note may be less extensive. Because a psychotherapeutic relationship may begin with the very first moment with a patient, sensitive material from an evaluation session may appropriately be protected in a separate psychotherapy note.

The treatment plan is a central part of the basic clinical record which proceeds logically from the formulation of the case. Stated with varying degrees of elaboration, the formulation is a case discussion that includes a diagnosis but also an assessment of the patient's personality strengths and vulnerabilities in the context of the treatment history, current reality situation, biological variables, relationships and support systems, and any other relevant factors. The descriptive diagnosis is often less influential than the other elements in determining the selection and structure of psychotherapeutic modality. The psychotherapy treatment plan may include the treatment modality (e.g., psychodynamic, cognitive-behavioral, or interpersonal; individual or group), the frequency and duration of sessions, and estimated length of treatment. In some situations it may also state provisional goals, the means of assessing progress or determining the suitability of the psychotherapeutic approach after a trial period, and provisional prognosis. If the clinical note will be reviewed by others in a treatment facility or for managed care, it is especially important that the treatment plan make clear the rationale for selecting this mode of treatment, but such clarity would be highly desirable at all times.

Progress notes periodically update the psychotherapy treatment plan and its underlying rationale; they are

usually sufficient for review of the treatment without raising the issue of disclosing intimate personal information from the ongoing psychotherapy. Likewise, sensitive material that warrants protection may emerge during a routine medication management visit in which only minimal psychotherapy is expected to occur.

Material from the actual course of psychotherapy, once under way, may optionally be recorded in the general clinical note, but it would not then be protected under the HIPAA privacy rule. Sensitive information would be difficult to redact if the record were circulated to other treating health professionals, called into court, or otherwise opened to others under the standard consent conditions of medical records. Medicare carriers specify that the goals of psychotherapy and themes of each psychotherapy session should be stated in the basic record and available for review. It is unclear whether this required disclosure will be superceded by the HIPAA privacy rule because the rule does not permit requiring authorization of disclosure as a condition of payment. Privacy advocates from the field of psychoanalytic psychotherapy consider even this degree of disclosure to be a violation of the principles underlying the *Jaffee* privilege.

The overarching principle of the basic clinical record is that it should be able to stand alone in documenting and justifying the rationale and course of diagnosis and treatment, without need for disclosure of information from psychotherapy notes. It is the basic, self-sufficient medical record of the care of the patient.

VI. PROTECTED PSYCHOTHERAPY NOTES

The 1996 U.S. Supreme Court decision in *Jaffee v. Redmond* established an absolute privilege for information disclosed in psychotherapy or counseling—absolute because it cannot be balanced against other interests in court proceedings in individual cases. Though strictly applicable to civil cases in federal courts, the decision has been influential throughout the U.S. judicial system. The issue is how psychotherapy information can be delineated from other clinical information. Segregation of information disclosed in psychotherapy is of course much more difficult if psychotherapy notations are sprinkled throughout a clinical record containing other medical information for which there might be a legitimate reason for access by the court. Third-party payers may appropriately, with the patient's consent, request the kinds of clinical information that are entered in the general clinical record, but they would have neither in-

terest nor entitlement to explore the details of psychotherapy sessions.

For such reasons many psychotherapists have traditionally kept separate records of the contents of psychotherapy sessions. These are sometimes called “process notes” because they detail the sequential unfolding of a psychotherapy session, often with the therapist’s observations of not only the patient’s communications and emotional states but also the therapist’s reactions, associations and thinking about transference, countertransference, and the strategy of response. Such elaborate notes would have no justifiable usefulness outside of the work of therapy. They are commonly employed in training settings or consultations to allow the supervisor or consultant to understand the subtleties and nuances of a treatment, especially the transference and countertransference or other elements that the therapist might not have recognized. Therapists may use such notes themselves to reflect on the process of treatment or to develop research findings. Segregated notes also serve as a repository for important, highly sensitive factual disclosures by the patient in the course of treatment, that could potentially be injurious to the patient or other people if revealed. Less detailed notes may also serve as a reminder to the therapist of what transpired at recent sessions, to heighten continuity of contact with the material. However, separate notes have been controversial for reasons to be discussed later.

Psychoanalytic and psychodynamic psychotherapies, with their emphasis on free association, dreams, fantasies, and transference–countertransference, obviously generate the kind of material that belongs in a separate psychotherapy note. Therapists using other approaches may be less likely to write separate notes. However, in cognitive-behavioral therapy, a patient’s daily, self-observing thought records may be key to documenting the patient’s progress in treatment. If a thought record contained highly sensitive, potentially embarrassing material, a therapist would be more likely to retain it and thus keep the integrity of the treatment record if it could safely repose in a segregated record. In behavior therapy, the patient may need to work on controlling highly objectionable or embarrassing behaviors; will these behaviors be documented? Meaningful grief work or role realignments in interpersonal psychotherapy may entail working with potentially damaging information about the patient and/or close associates. If trust is established, patients bring highly troublesome aspects of their personal lives into psychotherapy, regardless of the formalities of the chosen treatment modality. If such

information is to be documented at all, there must be a safe place for it.

Under the HIPAA privacy rule, keeping identifiable psychotherapy notes as a separate part of the record of treatment may become fairly standard practice, although it remains optional at the discretion of the therapist. The rule defines psychotherapy notes as “notes recorded (in any medium) by a health care provider who is a mental health professional documenting or analyzing the contents of conversation during a private counseling session or a group, joint, or family counseling session.” The definition excludes “medication prescription and monitoring, counseling session start and stop times, the modalities and frequencies of treatment furnished, results of clinical tests, and any summary of the following items: Diagnosis, functional status, the treatment plan, symptoms, prognosis and progress.” (The material excluded from psychotherapy notes belongs in the general clinical record.) Furthermore, “to meet the definition of psychotherapy notes, the information must be separated from the rest of the individual’s medical record.” However, the information remains identified as belonging to that patient’s record, and it can be disclosed with the patient’s specific written authorization for certain purposes. There are also very limited instances in which the notes may be accessed without authorization.

Controversy exists over the added, significant administrative burden of maintaining separate psychotherapy notes within the record, especially in institutional settings. As medical records are increasingly placed in central electronic databases, psychotherapy notes will have to be kept in paper form or in special, highly secure, segregated electronic files. On the other hand, privacy advocates hail the HIPAA privacy rule as a major advance in documenting psychotherapy while preserving strong protection of confidentiality.

VII. THERAPIST’S PERSONAL WORKING NOTES

Before *Jaffee* and HIPAA, the only way a therapist could record a completely confidential account of psychotherapy information was to maintain totally isolated, separate notes in a form that was devoid of all information that could indicate the identity of the patient. Such personal working notes are the sole property of the therapist, may be in any form, are often in a shorthand that would be unintelligible to anyone else, and may include personal

information about the therapist's own mental life as it pertains to the treatment process. They may be destroyed as soon as their purpose has been served, whether for supervision, consultation, research, or day-to-day continuity in the therapist's work with the patient.

Personal working notes are surrounded by controversy. On the one hand, they are immensely useful and, for many therapists, indispensable in treating, training, and research. On the other, they create a "shadow" record of which the patient is unaware. They are not totally immune to subpoena in litigation or child custody determinations or to oversight of the therapist by licensing boards, although such intrusions may be vigorously contested. Whereas some authorities on confidentiality of psychotherapy recommend that notes on sensitive material be kept apart from the official record, malpractice defense attorneys advise strongly against keeping any separate records. If the therapist does keep personal working notes, it is advisable to destroy them as soon as they have accomplished their purpose. However, they should never be destroyed after a subpoena has been served.

Will the HIPAA privacy rule end the practice of keeping personal working notes? Will they no longer be necessary? The rule applies only to identifiable records of patient care, so that personal working notes are outside its purview. Much that was previously recorded in personal working notes might now reasonably be documented in psychotherapy notes. In discussing psychotherapy notes, commentary on the HIPAA rule states that they could be comparable to what has often been called process notes. However, the strength of the privacy rule's protection remains to be tested in actual practice. Given that under certain conditions the HIPAA-delineated psychotherapy notes may be accessed with or without patient authorization, it is likely that therapists will keep at least some material out of the identifiable record altogether. For example, this may particularly apply to raw sexual or aggressive material, notes on the therapist's own emotional reactions, or potentially damaging factual disclosures about the patient or others.

VIII. CASE EXAMPLES

Following are brief examples of the kind of material in regard to psychotherapy that might be documented in the different kinds of records described earlier.

A. Medical/Clinical Record

Cognitive-behavioral therapy, initial phase, session 3 of 20, focused on recurrent self-deprecatory thoughts. Patient to keep thought record.

Or: Psychoanalysis, 50-min session.

Or: Psychotherapy re: marital problems, self-control, and assertiveness.

B. Psychotherapy Notes

Patient described a TV show with an infant tightly wrapped in blankets in a crib that prompted memories of a very restrictive early home environment and family stories about how she actually was swaddled as an infant. Father's passivity and disinterest contrasted with mother's very active direction that conveyed an expectation that women could not advance to positions of leadership. This was followed by self-deprecatory and fearful thoughts about her presumptuousness in thinking she could actually go to law school, and a fantasy that I would laugh at her. I said that she might still be influenced by the restrictiveness she grew up with, and she expected me to react as her mother might have.

Or: After much hesitation the patient revealed that he had started an affair with his secretary and was now very worried that he would be charged with sexual harassment.

Or: In cognitive-behavioral therapy, a file of the patient's detailed thought records as well as the therapist's strategies and observations.

C. Personal Working Notes

(No identification of the patient.) She is again railing against J. for his inattentiveness. I felt vaguely attacked. (Details of an elaborate dream involving plane crashes because pilots are inattentive to their duties.) Associations to the dream led to vacation spots, empty feelings she had when her mother was away, incidents when she had been nasty and bad things had happened. I raised the question whether she might be wanting to rail against me for going away next week and being inattentive to my duty to her, and maybe she was afraid harm would come to me because of her anger. She snorted and called me a lousy bastard, what right did I have to think I mattered that much to her! ... Etc.

(This note, written for supervision, might be much longer and more detailed with undisguised specific

information about the patient's thoughts and behavior as well as the therapist's thinking, emotions, and interventions. It would also probably be in a more telegraphic style than depicted here, because it would not be read by anyone else and would be destroyed after its purpose had been served.)

IX. SUMMARY

With the advent of *Jaffee v. Redmond* and the HIPAA regulations, documentation of psychotherapy has achieved an unprecedented level of protection, although many practical questions remain unanswered about how these protections will be implemented. Most therapists prudently maintain a general clinical/medical record of treatment that is factual, legible, and complete insofar as the objective clinical status of the patient is concerned. Psychotherapy itself may be documented in abstract terms in the general clinical record without details that are personal to the patient. As an option, therapists may record more specific information about the process and content of psychotherapy in psychotherapy notes kept in a separate part of the patient's identifiable clinical record. These notes have a

considerably higher level of protection from disclosure because specific patient authorization is required for disclosure. The therapist may also elect to keep highly sensitive or personal information in personal working notes entirely outside the clinical record.

See Also the Following Articles

Bioethics ■ Confidentiality ■ Informed Consent ■ Legal Dimensions of Psychiatry ■ Supervision in Psychotherapy

Further Reading

- American Psychiatric Association. (1999). *Documenting psychotherapy by psychiatrists*. Washington, DC: Author. See <http://www.psych.org>.
- Appelbaum, P., & Gutheil, T. (Ed.). (1991). *Clinical Handbook of Psychiatry and the Law* (2nd ed.) Baltimore; Williams & Wilkins.
- Etzioni, Amitai. (1999). *The limits of privacy*. New York: Basic Books.
- Jaffee v. Redmond*, 518 U.S. 1 (1996). (Accessible, along with numerous *amicus* briefs and information about subsequent developments at www.jaffee-redmond.org.)
- U.S. Department of Health and Human Services. *Final standards of privacy for individually identifiable health information*. 65 Fed. Reg. 82, 461 (Dec. 28, 2000).

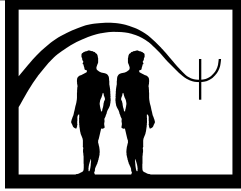

Dosage Model

S. Mark Kopta
University of Evansville

Jenny L. Lowry
Loyola College in Maryland

- I. Psychotherapy Is Beneficial
 - II. The Dosage Model: Determining How Much Is Enough
 - III. Different Methodologies of the Dosage Model
 - IV. Summary
- Further Reading

GLOSSARY

- dose** Number of psychotherapy sessions.
- dose-outcome** An extension of the dose-effect methodology that tracks psychotherapeutic progress across sessions for an individual patient.
- effect** Percentage of patients improved or probability of improvement for one patient.
- HLM** Hierarchical linear modeling. A statistical procedure that uses predictor variables to estimate the likely outcome of a criterion variable; actual outcome of the criterion may be checked against the predictions for accuracy of the model.
- log-normal transformation** A statistical procedure performed on non-normally distributed data to fit them into a normal distribution.
- meta-analysis** A methodology that statistically combines and compares the results of several studies.
- patient profiling** A statistical procedure that uses hierarchical linear modeling to predict a patient's expected course of improvement based on the patient's intake clinical characteristics.
- probit analysis** Linear regression analysis where the dependent variable is dichotomous and ordinal (e.g., improved versus unimproved). The statistical analysis used in dose-effect designs.

Mental health researchers are quantifying the effectiveness of psychotherapy to better understand its benefits and, very importantly, to justify reimbursement as a health care treatment. These scientists want to answer the following questions: How does psychotherapy work? How quickly does it work? How much works for each of the various psychological problems? The answers are especially important because third party payers (such as managed health care) want to know about the general value of psychotherapy as well as its value in comparison to psychotropic medication. This article describes the dosage model that is a guiding model being used to understand and investigate the effectiveness of psychotherapy. Methodological variations of the dosage model (i.e., dose-effect, dose-outcome, and patient profiling) are reviewed as well as findings relevant to understanding the effectiveness of psychotherapy.

I. PSYCHOTHERAPY IS BENEFICIAL

Mental health research has demonstrated that psychotherapy is a valid treatment for alleviating psychological suffering. For example, in a landmark 1977 study, Mary Smith and Gene Glass employed a meta-analysis that statistically combined and compared the effect sizes of treatment, placebo, and control groups. Based on data from 475 studies, the authors found that psychotherapy is more effective than no treatment as well as placebo therapy. Their study demonstrated that

patients receiving psychotherapy were better off than approximately 80% of those who were not in treatment. Since Smith and Glass' work, hundreds of studies have also shown that psychotherapy is beneficial beyond no treatment and placebo conditions.

Interestingly, Smith and Glass reported no significant outcome differences among the different types of psychotherapy (such as psychodynamic, behavioral, and cognitive). Although the different therapies were effective, none were more effective than the others in treating the variety of problems. Other researchers have reported the same results. This phenomenon is known as the "dodo bird verdict" after the dodo bird in *Alice in Wonderland* who proclaimed, after a race, "Everybody has won and all must have prizes."

II. THE DOSAGE MODEL: DETERMINING HOW MUCH PSYCHOTHERAPY IS ENOUGH

Today the effectiveness of psychotherapy is understood in the context of the dosage model. The dosage model proposes that the psychotherapy session is a natural quantitative unit or dose of treatment similar to a dose of medication in milliliters or milligrams. This analogy is derived from the generic model of psychotherapy. The generic model asserts that psychotherapy is comprised of nonspecific and specific factors that contain active treatment ingredients. Nonspecific factors, which are common to all psychotherapies, include interpersonal variables such as positive regard, genuineness, and empathy. There are also active ingredients unique to each specific therapy. Examples of these specific factors include empathic reflections (used by client-centered therapists), interpretations (psychodynamic therapists), and positive reinforcements (behavior therapists). The active ingredients to which patients are exposed during the course of a session produce psychological and behavioral change. Similar to taking medication, participating in psychotherapy over time exposes the patient to more active ingredients. Therefore, more psychotherapy consequently results in greater improvement. This outcomes process of the more, the better has been validated in several studies.

Two issues emanated from the aforementioned effectiveness research: What was the nature of the positive relationship between dose of psychotherapy (such as number of sessions) and benefit? How many sessions are necessary to achieve sufficient benefit?

III. DIFFERENT METHODOLOGIES OF THE DOSAGE MODEL

The Dose-Effect Relationship

In their 1986 landmark article, K. Howard, M. Kopta, M. Krause, and D. Orlinsky answered the first question and began the movement towards answering the second. The authors introduced the dosage model, using dose-effect methodology, where effect is the percentage of patients improved or probability of improvement for one patient. Employing a log-normal transformation of the data, they found that patients in psychotherapy improve in a statistically predictable manner. This recovery process follows a negatively accelerated curve; that is, the more psychotherapy, the greater the probability of improvement with diminishing returns at higher doses (see Figure 1).

Howard and his colleagues further examined the dose-effect relationship using a meta-analysis design for 15 samples of data ($N = 2,431$ patients) which spanned over 30 years of research. Traditional measures of improvement (such as patient self-report and clinician ratings) were collected at various times dur-

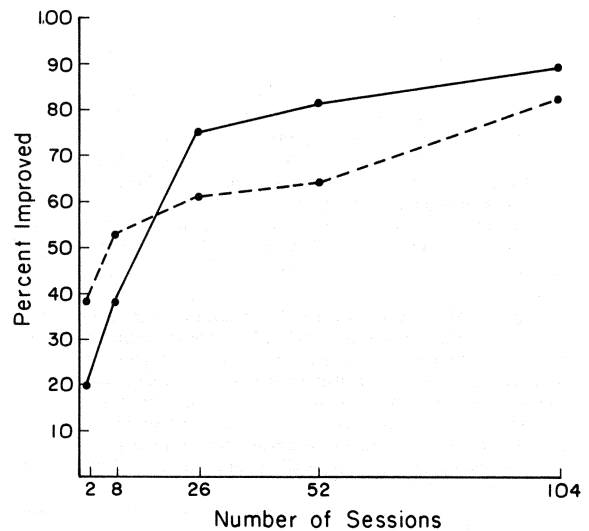

FIGURE 1 Relation of number of sessions (dose) of psychotherapy and percentage of patients improved (effect). (Objective ratings at termination are shown by the solid line, $N = 151$ patients; subjective ratings during therapy are shown by the broken line, $N = 148$.) From "The Dose-Effect Relationship in Psychotherapy," by K. I. Howard, S. M. Kopta, M. S. Krause, and D. E. Orlinsky, 1986, *American Psychologist*, 41, p. 160. Copyright 1986 by the American Psychological Association. Reprinted with permission.

TABLE I
Results of Probit Analyses of Three Diagnostic Groups for Two Outcome Criteria:
Percentage of Patients Improved Across Sessions

Diagnostic groups	N	Number of sessions								
		0	1	2	4	8	13	26	52	104
Criterion: Research ratings of closed clinical charts										
Depression	69	6	13	20	31	46	57	73	86	94
Anxiety	21	0	0	0	5	25	53	87	99	99
Borderline-psychotic	23	0	0	0	0	3	11	38	74	95
Criterion: Patient ratings after each session										
Depression	974	22	31	37	44	53	60	69	77	84
Anxiety	425	15	22	28	36	46	54	64	74	82
Borderline-psychotic	402	3	8	13	21	33	42	60	75	87

N = Number of Patients. From Howard, K. I., Kopta, S. M., Krause, M. S., and Orlinsky, D. E. (1986). The dose-effect relationship in psychotherapy. *American Psychologist* 41, 163. Copyright 1986 by the American Psychological Association. Reprinted with permission.

ing therapy for each sample. The type of psychotherapy implemented was typically psychodynamic or interpersonal; patients presented with a variety of diagnoses. Data from each of the samples were analyzed with probit analysis. The results were then aggregated across samples to establish dose-effect estimates for specific amounts of psychotherapy—approximately 15% of patients improved simply by scheduling an appointment, 50% of patients improved by session 8, 75% by session 26, and 85% after a year of once-weekly psychotherapy. These figures continue to be used by administrators, clinicians, and researchers as treatment guidelines. For example, Howard and his colleagues suggested 26 sessions as a rational time limit for treatment or as a review point for cases that have not shown measurable improvement. Eight sessions are now considered the standard for establishing a treatment group for experimental clinical trials; that is, eight sessions are the dose at which a patient has been effectively exposed to psychotherapy.

Another finding was that different diagnostic groups demonstrated different dose-effect patterns. Dose-effect relations in Table I show that depressed patients responded quickest to psychotherapy, followed by anxious patients, and with borderline-psychotic patients responding at the slowest rate.

Subsequent authors have applied the dose-effect methodology to specific psychological symptoms, clinical syndromes, and interpersonal problems. For instance, Kopta and his colleagues in 1994 demonstrated that different symptoms respond differently to psy-

chotherapy. Patient recovery (such as return to normal functioning) was assessed across sessions by self-report questionnaire for 90 psychological symptoms. Based on dose-effect relations for 854 patients, the symptoms were grouped into three distinct symptom classes—acute, chronic, and characterological. Each symptom class was found to respond to psychotherapy at varying rates (see Figure 2). For example, acute symptoms (such as temper outbursts, feeling fearful, and crying easily) were found to remit most quickly in therapy. Approximately 50% of patients recovered on these symptoms by the session 5. Chronic symptoms (such as feelings of worthlessness, worrying too much, and being low in energy) demonstrated a pattern where approximately 50% of patients had experienced recovery by session 14. Characterological symptoms were found to respond most slowly to psychotherapy; for the majority of these symptoms, more than 40 sessions were necessary for patients to achieve a 50% probability of improvement. These symptoms were related to hostility and interpersonal difficulties (such as feeling that others are to blame for your problems, frequent arguments, and being easily annoyed).

Dose-Outcome Design

In a 1995 chapter, Howard and colleagues introduced the dose-outcome method. A logical extension of the dose-effect methodology, it's of particular benefit to the practicing clinician and case manager. Whereas the dose-effect method addresses how much

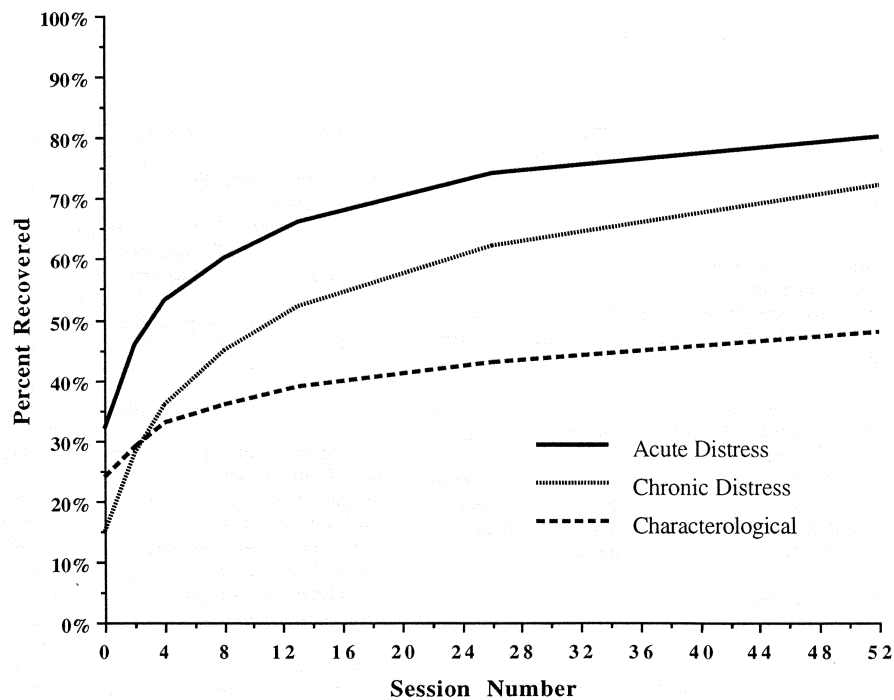

FIGURE 2 Dose-effect relations, averaged across symptoms, for acute, chronic, and characterological symptom classes. From “Patterns of Symptomatic Recovery in Psychotherapy,” by S. M. Kopta, K. I. Howard, J. L. Lowry, and L. E. Beutler, 1994, *Journal of Consulting and Clinical Psychology*, 62, p. 1014. Copyright 1994 by the American Psychological Association. Reprinted with permission.

psychotherapy is needed to benefit the “average” patient, the dose–outcome design answers the question “How is psychotherapy benefiting this specific patient?” Here, instead of percentage of patients improved plotted against dose, it’s measure of benefit for an individual patient (see Figure 3). With the dose–outcome design, the clinician monitors the patient’s progress across time using valid, reliable measures similar to monitoring blood chemistry in medicine. The clinician can use this information to make treatment adjustments over the course of therapy for individual patients.

Patient Profiling

Patient profiling extends the dose–effect and dose–outcome methodologies from tracking patients’ improvement to predicting improvement. In their 1996 article, Howard and associates introduced the strategy of using hierarchical linear modeling (HLM) to plot a patient’s expected course of improvement based on

seven intake clinical characteristics (such as level of symptomatology, duration of problem, and expectation of improvement). By giving differential weights to these characteristics, HLM produces an estimated improvement curve for each patient (see Figure 4). Actual patient progress, as measured by the self-report Mental Health Index (MHI), across sessions can be compared to predicted progress.

The dotted line in Figure 4 shows a patient’s expected Mental Health Index (MHI) score, based on the HLM procedure, while the solid line shows actual improvement. In this figure, the patient’s improvement was significantly different from the model’s predictions until session 20. The discrepancies between predicted and actual improvement were likely due to issues specific to this patient and their treatment. By tracking this patient across sessions, the therapist was able to make therapeutic adjustments to best serve the client. Impressively, the patient did achieve the expected gains by the 20th session, thus lending support to the patient profiling methodology.

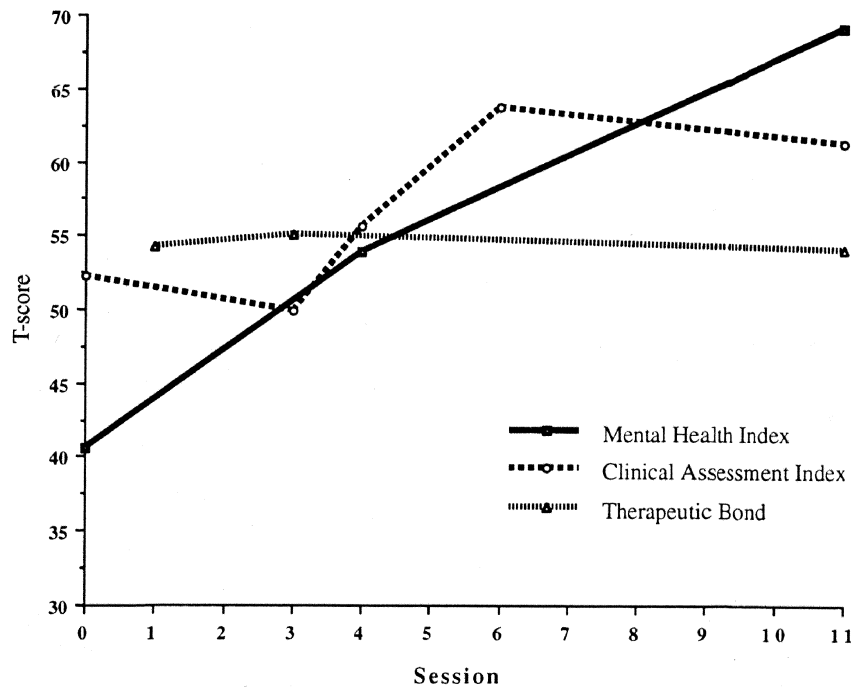

FIGURE 3 A dose-outcome design that illustrates the successful treatment of a short-term case. From "The Design of Clinically Relevant Outcome Research: Some Considerations and an Example," by K. I. Howard, D. E. Orlinsky, and R. J. Lueger. In M. Aveline & D. A. Shapiro (Eds.), *Research Foundations for Psychotherapy Practice*, 1995, p. 34. New York: John Wiley & Sons. Copyright 1995 by John Wiley and Sons. Reproduced with permission.

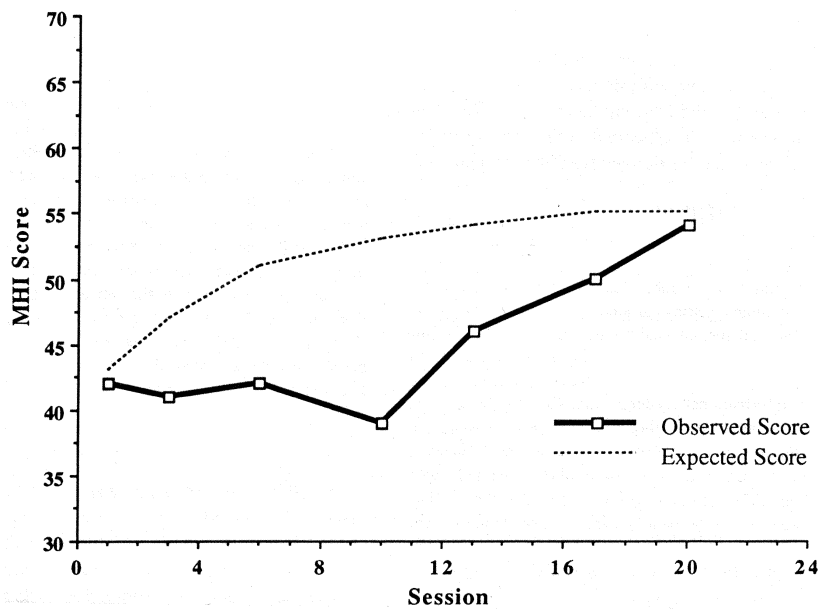

FIGURE 4 Course of the Mental Health Index (MHI): Patient responding to psychotherapy as expected after a change in treatment intervention at session 11. From "Predicting Patients' Responses to Psychotherapy: Are Some More Predictable Than Others?," by S. C. Leon., S. M. Kopta, K. I. Howard, & W. Lutz, 1999, *Journal of Consulting and Clinical Psychology*, 67, p. 699. Copyright 1999 by the American Psychological Association. Reproduced with permission.

Following the treatment of over 800 patients, Leon and colleagues reported in 1999 that patient profiling was overall 75% accurate in predicting patients' courses of therapeutic improvement, with a range of 94% for some patient types to 25% for others. Patient profiling provides information as to which patients may benefit from particular types of psychotherapy, whether therapy is progressing as expected for a given patient, and the likelihood that a patient has achieved maximum gains from therapy.

IV. SUMMARY

The dosage model has had a substantial influence on psychotherapy research. Howard and colleagues' seminal article in 1986 began a new era of naturalistic outcomes research, that is, researching psychotherapy as it's practiced in real clinical settings. We can now answer many questions that have long been proposed by professionals in the mental health field. For example, managed health care and other third party payers have information available on how much psychotherapy is enough. There are methods that allow clinicians and case managers to track patient progress across time, as well as predict how a given patient should respond to therapy based on initial clinical characteristics. Using dosage model methods, there is now the capability to answer a modified version of the compelling question asked by Gordon Paul in 1967, "How much psychotherapy is most effective for which patient with what type of problem?"

See Also the Following Articles

Cost Effectiveness ■ Effectiveness of Psychotherapy ■ Engagement ■ Objective Assessment ■ Outcome Measures ■ Relapse Prevention ■ Termination

Further Reading

- Aveline, M., & Shapiro, D. A. (Eds.). (1995). *Research foundations for psychotherapy practice*. New York: John Wiley & Sons.
- Bergin, A. E., & Garfield, S. (Eds.). (1994). *Handbook of psychotherapy and behavior change* (4th ed.). New York: John Wiley & Sons.
- Howard, K. I., Kopta, S. M., Krause, M. S., & Orlinsky, D. E. (1986). The dose-effect relationship in psychotherapy. *American Psychologist*, *41*, 159-164.
- Howard, K. I., Moras, K., Brill, P. L., Martinovich, A., & Lutz, W. (1996). Evaluation of psychotherapy: Efficacy, effectiveness and patient progress. *American Psychologist*, *51*, 1059-1064.
- Leon, S. C., Kopta, S. M., Howard, K. I., & Lutz, W. (1999). Predicting patients' responses to psychotherapy: Are some more predictable than others? *Journal of Consulting and Clinical Psychology*, *67*, 698-704.
- Kopta, S. M., Howard, K. I., Lowry, J. L., & Beutler, L. E. (1994). Patterns of symptomatic recovery in psychotherapy. *Journal of Consulting and Clinical Psychology*, *62*, 1009-1016.
- Kopta, S. M., Lueger, R. J., Saunders, S. M., & Howard, K. I. (1999). Individual psychotherapy outcome and process research: Challenges leading to greater turmoil or a positive translation. *Annual Review of Psychology*, *50*, 441-449.
- Smith, M. L., & Glass, G. V. (1977). Meta-analysis of psychotherapy outcome studies. *American Psychologist*, *32*, 752-760.

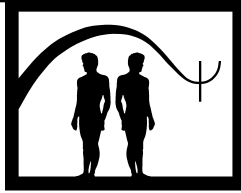

Dreams, Use in Psychotherapy

Robert C. Lane and Max Harris

Nova Southeastern University, Fort Lauderdale, Florida

- I. Introduction
 - II. The Language
 - III. The Value
 - IV. Freud
 - V. The Functions
 - VI. The Ups and Downs of the Place
 - VII. A Love–Hate Relationship
 - VIII. The Configurational Approach to the Manifest Content
 - IX. One-Person versus Two-Person Approach
 - X. Diagnostic or Prognostic Specificity
 - XI. The Initial or First Dream
 - XII. Color
 - XIII. Typical Dreams
 - XIV. Other Theories
 - XV. The Biological Challenge to Dream Theory
 - XVI. Conclusion
- Further Reading

GLOSSARY

amplification For Carl Jung, amplification is analogous to Sigmund Freud's use of free association. The patient attends to a part of the dream that is disguised and yet stands out to arrive at a deeper understanding of the dream.

archetype A personified or symbolic form of an inherited idea derived from the total experience of the human race that is present in the unconscious of all individuals.

condensation The fusion of two or more ideas or mental images that produce the composite figure found in the dream.

configuration approach An approach that combines a number of variables, including signs, overall pattern of signs, and the combination of both to describe and differentiate an individual's personality.

countertransference All unconscious feelings of a therapist toward a patient or the total feelings of the therapist toward a patient.

day residue The material from the 24 hrs preceding the dream that influences the formation of dream images.

disguise function Freud's belief that to prevent the gratification of unconscious wishes the dream content has to be changed by the dreamwork.

displacement The second essential mode of dreamwork operation. The result of the rapid transfer from one idea or image to another characteristic of primary process.

dream censorship The distortion or disguise of the dream to prevent the gratification of unconscious wishes.

dream diction The dream's use of language, especially figures of speech.

dream of Irma's injection, Irma dream, dream specimen The title Freud gave to his specimen or model dream in Chapter II in his *Interpretation of Dreams* that he used to demonstrate his dream theory.

dream instigators The external or internal stimuli that are the sources of dreams.

dream sources The elements or causes of dreams.

dream symbolism The symbols used in dreams to distort the latent content.

dream wish Freud's theory that the gratification of the unconscious wish was the function of the dream.

dreamwork The work of the dream mechanisms that disguise or distort the content of the dream in line with the dream censorship and transform the latent content into the manifest content.

exceptional or unique position The dream holds a special place in psychotherapy. It is considered the best means to the royal road to the unconscious.

first or initial dream The first dream after knowing one is entering into therapy or is in therapy.

latent content The unconscious wishes and other material that is disguised and distorted by the dreamwork to conceal its unacceptable aspects.

manifest content The dream content that is recollected.

means of representation The use of pictorial metaphors to express certain ideas.

primary process A repository of aggressive and sexual drives from all stages of development.

relationality Stress on the relationship between the patient and therapist rather than on the patient alone. Countertransference as well as transference must be analyzed.

REM Rapid eye movements, which indicate the person is dreaming.

secondary elaboration An alternative term for secondary revision.

secondary process Freud's term for the laws that regulate events in the preconscious or ego.

secondary revision A process that attempts to supply the dream with consistency and coherence. It fills in the gaps, creates order, and molds the dream into an intelligible whole.

shadow The inferior or dark side of the personality. The sum of personal and collective events, which are denied expression in life due to their incompatibility with the conscious attitude.

symbolization The universal primal language representing association between ideas having something in common, although the relationship is not easily discernible.

structural theory Freud's metapsychological theory that there are three divisions of mental functioning: the id, the ego, and the superego.

topographical theory Freud's metapsychological theory that the psyche or mind was divided into three systems: unconscious, preconscious, and conscious.

transference The displacement and projection of feelings toward early objects onto the therapist.

unconscious A reservoir for unacceptable psychic material.

UTD Undisguised transference dream in which the patient sees the therapist as the therapist appears in therapy.

Dreams have had an important place in psychotherapy since Sigmund Freud's proposal that dreams are the royal road to the unconscious in 1900. A change in the number of sessions from five to one per week and a move toward brief therapy modalities has coincided with a change in emphasis from the latent content to the manifest content of the dream. Some kind of schematic method like the configurational approach to the manifest content helps to make the use of dreams more feasible in today's world of psychotherapy. Dreams still offer a rich source for helping patients to achieve greater self-

understanding, self-control, self-expression, and a more positive self-image.

I. INTRODUCTION

From antiquity the universal phenomena of dreaming has captivated human imagination, confused human logic, and controlled human endeavors. Dreams have been regarded as exceedingly important to a person's destiny, as messages from the gods, predictive of the future, expiatory of guilt, and the voice of conscience. Shamans, seers, and saints have used dreams to discern the source of sickness, or to set the course of nations. Poets, philosophers, and playwrights have sought to plumb the depths of dreams to lure audiences or readers into the world of fantasy, to play the strings of the emotions, and to recall the unthinkable. Cognitive, information processing, and neuroscientists find in dreams brain activity that can help understand REM, memory consolidation, and the "unconscious" state. But what about psychotherapy—how do psychiatrists, psychoanalysts, and psychologists of various persuasions use dreams to inform their work with patients?

II. THE LANGUAGE

Understanding the use of dreams in psychotherapy begins with seeing how the laws of poetic diction and the laws of dream diction, or dream formation, spring from the same unconscious source and have many mechanisms in common. Whereas the poet's task is to communicate experience that is accomplished by sound, the power to evoke imagery, and the use of figures of speech such as the simile, metaphor, metonymy, and onomatopoeia, the dreamer also uses figures of speech and will often employ words in which the sound of the chosen word will reflect the sense of the word. The psyche in its memory bank has many early personal experiences to choose from in which sound was fused with meaning. Words often have more than one meaning, have a history of displacement, are often connected to our first exposure to them (often their primary meaning), and may have a secondary or even a tertiary meaning. In our storehouse of words, the specific significance of our earliest use of a word is never lost. Words that sound alike, but are spelled differently, may be substituted for each other in establishing their meaning. This may also be true of words that rhyme with each other. Verbs that are very rarely distorted and

should be taken literally tell us about the dreamer's activities and date back to early life, whereas nouns are often ambiguous, idiosyncratic, or metaphorical with multiple meanings. The names of places can have special meaning when we break down the word into its parts (syllables). When deciding on the meaning of a specific word that has several meanings, the emotional impact of each word's meaning and how early it was first introduced to the dreamer will help determine its primary meaning in the dream.

III. THE VALUE

The major Greek philosophers, Plato and Aristotle, were among the early harbingers of a psychological approach to dreams. Plato was the first to see dreams as an expression of repressed unconscious wishes. For Aristotle, dreams were seen as essential in terms of their discharge function. However it was not until the beginning of the 20th century that the contributions of both Aristotle and Plato were combined by Sigmund Freud who came to the conclusion that unconscious wishes seek an outlet for discharge, which is unacceptable to the dream censor, and that if they emerge undisguised, sleep would be interrupted. Freud saw the dream as the guardian of sleep and felt that the deprivation of psychic discharge through dreaming led to derangement.

Later theorists said dreams were a reference to what is happening in the life of the dreamer, and what emotional problems and conflicts one is struggling with, or acting out. They claimed dreams provide insight into the repressed traumas of the past, offering clues to psychological and physical breakdown and how much stress the dreamer could take. Dreams tell us what is hidden, how it is hidden, and why it is hidden. They also tell us about present-day bodily experiences, and the forgotten experiences of childhood. They can express or sway opinion, under- or overvalue material, represent resistance, and may placate, control, manipulate, or assuage the therapist and therapy. They can also tell us how correct, valid, or wide of the mark our interpretations of the patient's associations may be, confirm or elaborate themes discussed in therapy, and tell us where we are in psychotherapy.

IV. FREUD

Within the field of psychotherapy the first major work that sought to address the use of dreams was

Freud's *Interpretation of Dreams* published in 1900. The book contains the Irma dream (Chapter II), the specimen dream chosen to be analyzed by the new technique, and Chapter VII, the final chapter, which explains Freud's unconscious wish fulfillment theory. Freud lays out the sources or instigators of dreams, and that dream content may be in the present or past and concerns experiences, affects, hopes, fantasies, conflicts, and the like. When something in the day (residue) makes contact with some past wish, the connection may result in a dream.

Employing a topographical model of the mind and using clinically promising connections between dreams and psychological symptoms that he discovered mainly in his self-analysis, Freud proposed that dreams were expressions of unconsciously repressed psychic material that appeared in the psyche as wish fulfillment. The unconsciously repressed material, or the latent content, represents the primary processing activity of the mind, which consists of all parts of dreams discovered through interpretation including dynamically unconscious wishes, preconscious material, and sensory and somatic stimuli. To interpret the latent content and bring it to conscious awareness, the patient starts with the manifest content, which comes from the conscious secondary processing activity. The manifest content consists of all aspects of what the dreamer consciously remembers after waking up and is retained in any given form, whether as pictures, incongruous situations, contradictory emotions, or other forms. Then through freely associating whatever comes to mind in relation to these forms, the words of the associations bring the forms of the unconsciously repressed material into conscious awareness providing insight into the etiology of the patient's symptoms and pathology. Insight in turn helps the patient to "make sense" of symptoms and provides a mutative affect in relieving the symptoms and diminishing the pathology.

The movement from the latent dream thoughts to the manifest dream content Freud calls the dreamwork. The dreamwork utilizes a number of dream mechanisms: condensation, displacement, symbolization, visual means of representation, and secondary revision in the service of disguising or distorting the dream content for purposes of carrying out the work of the dream censor. The latent dream thoughts are disguised so the unconscious wish is blocked from conscious awareness. Condensation fuses and telescopes several images and ideas into one. With displacement the dreamer transposes, for example, a person into an object and may displace an affect that the dreamer feels toward the person onto the object. The

dreamwork may use reversal, a variant of displacement, to reverse the action, the affects, or the person thus further disguising the dream. Symbolization supplements the distorting work of condensation and displacement by making it more difficult for the dreamer to uncover the latent thoughts. Symbolization allows the dreamer to regress to the activity of the infantile unconscious mind which consistently pulls together objects that appear to have common aspects. Symbols are chosen from a large available number of objects and used with regularity. Although some dream interpreters translate the dream from symbols immediately, it should be pointed out that considerable knowledge of the dreamer should precede translation of symbols, and the accuracy of interpretation depends on the dreamer's free associations. The visual means of representation can result in distortions of latent thoughts by the use of pictorial metaphors. Relationships induced by prepositions, conjunctions, or punctuation require visual means of representation, and these words can be easily distorted. Secondary revision uses secondary process thinking and the ego in its attempts to produce coherence, order, and intelligence into the dream. In its use of secondary process thinking, and its attempt to make sense, secondary revision has many opportunities to disguise latent dream thoughts.

V. THE FUNCTIONS

The possible functions of dreams are many and varied. Freud put forward the idea that one of the most important functions of the dream is the preservation of sleep. He considered the dream to be the "guardian of sleep." Besides being viewed as guardian, other therapists propose that dreams may function to communicate important aspects of the transference to the therapist; to release secret wishes from repression in an attempt to understand, master, and gain pleasure from them; to represent the attempted fulfillment of our innermost desires; and to serve a discharge role as a release valve for repressed instinctual drives.

Some thinkers have proposed that dreams may have curative or restorative functions. They may help us (a) work through tensions and problems from the previous day, (b) restore balance lost when we feel threatened, (c) more realistically handle emotional problems, (d) recover a sense of competence, (e) insure mental health, and (f) relieve painful stimuli from traumatic experiences.

For some brain researchers, dreams form no useful human function because dreams are considered to be the

result of randomly firing neurons, or at the most only help "clean house" serving as safety valves assisting the brain as it rids itself of unnecessary information (i.e., reverse learning). Some of these writers fear attempting to remember dreams may reverse this function causing harm. Other brain researchers find the function of dreams in the consolidation of that day's memories.

Rosalind D. Cartwright in 1993 pointed to an information-processing function for dreams. She states that the more unrecognized but encoded feelings and emotions from the day are examined by the sleeping mind to see how they fit one's most interior, intimate conceptions of one's self. For her, dreams also work on how to constructively solve interpersonal and other problems raised during the day.

VI. THE UPS AND DOWNS OF THE PLACE

Up until the publication of Erik Erikson's "dream specimen" paper in 1954 that commented on Freud's Irma dream, little attention had been paid by analysts to the usefulness of the manifest content of the dream or to the important place of the Irma dream as the point of the discovery of unconscious conflict. Freud had felt the manifest content was a "mere façade," "a piece of unscientific virtuosity of very doubtful value," and he could not understand how anyone could interpret on the basis of it alone. The followers of Freud equated manifest with the external layer and the most superficial layer, not deserving of serious consideration, while the latent was equated with the deepest layer, the *sine qua non*, or the unconscious and primary process.

The passage of time has seen within psychotherapy a move to fewer therapy visitations (once a week for most therapists), a move to briefer treatment modalities due to the pressure from HMOs, PPOs, and insurance companies, and a move to a more classificatory approach (i.e., *DSM-IV*) with the results that the manifest content has taken precedence in the handling of dreams in psychotherapy, especially in the 1980s and 1990s. Most authors of dream articles now agree on the importance of the manifest content, its helpfulness, and its ability to provide valuable information about the dreamer.

As the worth of the manifest content was once questioned, now the worth of the latent content is being questioned. Some authors have even gone so far as stating the manifest content is the dream, and desire to dis-

card the disguise function of the dream (nothing is hidden or latent), and to deny that a dream is an unconscious wish. The distinction between manifest and latent content of the dream is slowly disappearing. Often associations to the manifest dream are no longer required; it being interpreted in direct symbolic terms or at its face value.

VII. A LOVE–HATE RELATIONSHIP

U.S. therapists have had a love–hate relationship with the dream. *The Interpretation of Dreams* contained Freud's self-analysis, and following the publication of the book, dream interpretation became synonymous with psychoanalysis. The controversy whether the dream holds an exceptional and unique position in psychotherapy or whether it is just one of many types of material with which therapists deal in psychotherapy still goes on. One sees many types of material in doing therapy, all of which are important, but it is also true that dreams at times can give much insight into a patient's unconscious problems. Symptoms, defenses, affect, behavior, and other dimensions of therapy are all important, but the dream is still perceived by many as the best means to the unconscious. The decline in the position of the dream in psychoanalysis has been thought to be due to the increased popularity of the relationist/interpersonal school that places much less emphasis on dreams, to the development of the structural theory, to new views on narcissism, and to new theoretical approaches that place less importance on the id, primary process, and the unconscious, and more on the secondary process, the ego, the self, and adaptation.

VIII. THE CONFIGURATIONAL APPROACH TO THE MANIFEST CONTENT

In once-a-week therapy, the patient after describing his dream has little time for exhaustive dream analysis and free association to every part of his dreams. Robert C. Lane, Marvin Daniels, and Stephen Barber, who were influenced by a number of dream researchers, particularly Erik Erikson in his analysis of the manifest content of Freud's Irma dream in his "dream specimen" paper, recommended in 1995 taking a number of the patient's consecutive dreams and subjecting them to analysis using 20 categories. This then formed the con-

figurational approach to the manifest dream content. They defined the 20 categories and then analyzed 11 dreams of a patient in analysis. Lane and Daniels independently analyzed the dreams by each category with high reliability then combined their contributions and compared them to the treating analyst's independent clinical observations about the 20 categories. The 20 categories of the configurational approach are style and quality, length, locale, nature of problems and intrapsychic conflict, activities, distortion, characters, relationship between characters, somatic or body references, sensory emphasis, spatial, temporal, affect, transference, resistance, communication to the therapist, fixation points, and diagnostic indicators and prognostic indicators. Although the configurational approach has been criticized for being like a projective technique, there is little doubt that it offers a great deal of material to the therapist using only the manifest content.

IX. ONE-PERSON VERSUS TWO-PERSON APPROACH

In the 1950s, 1960s, and 1970s, the emphasis in dream theory was on the application of the structural theory to dream analysis, the role of the growth of ego psychology in the understanding of dreams, how one affected the other, and the application of the principle of multiple functioning to dreams, what is called a one-person approach to dreams. In more recent years, the relationists (object relations, interpersonal/intersubjective theorists, self-psychology) have stressed a two-person psychology, bringing into dream analysis the role of the therapist, countertransference, the therapist's dreams, and the UTD (occurrence of the undisguised transference dream). The relationists were following the lead of Sandor Ferenczi who was the first among Freud's early disciples to stress the communicative function of the dream. Ferenczi, in 1913, the innovator who became a model to follow, emphasized "mutual therapy" or the analyst sharing his thoughts, feelings, impulses, dreams, fantasies, and traumatic memories with patients. His work served as a launching pad for a number of interpersonal and relational therapists who wrote papers on the dream. In contrast to Ferenczi who highlighted self-disclosure by the therapist, Freud, highlighting non-disclosure, felt that the therapist should remain opaque to the patient, sharing nothing but what is shown to the therapist.

The relationist movement emphasized that the patient's dreams are related to the therapist's needs,

countertransference, counterresistance, and counter-anxiety; can serve as unconscious supervision of the therapist; and help the therapist become aware of unconscious countertransference needs and other material that may be interfering with the patient's progress. Dreams are said to function as both disguisers and communicators. They are a reflection of both intrapsychic process and interpersonal communication. Dreams help therapists to gain knowledge of the patient's transference, but also of the therapist's countertransference feelings, to make the patient's unconscious conscious, but also to make the therapist's unconscious conscious; both therapist and patient serve a teaching function.

One form of countertransference occurs when the patient has an UTD. There are few papers on this subject as few therapists have the wish to have patients write about them as therapists. Therapists eschew references to countertransference as they feel it implies something wrong about the therapy. The relationists criticize the idea that the dream is a "disguise" to be penetrated, that the material contains a "hidden wish fulfillment," and dispense with the idea of "latent" content, that is, the manifest content is the dream language to be understood, "not a nut to be cracked open and discarded." They view countertransference as crucial and find it in many different situations, while claiming the traditional school (classicists) wish to deny and bury it.

The two opposing groups differ when we examine the therapist's dreams about the patient. The traditional Freudian would treat this dream as a neurotic conflict in the therapist, to be worked through internally so as not to interfere with neutrality and anonymity, while the relationist would use the dream to attempt to better understand the patient. The classicist feels all countertransference reflects unresolved problems, while the relationist feels countertransference is ubiquitous to all relationships and can be positively or negatively utilized in the service of treatment.

Many classical analysts have commented on the communication function of the dream and stressed the countertransference and supervisory aspects of the dream, as well as the psychodynamic. They feel the dreamer needs to communicate with the therapist and does it through the dream. There is both the wish to communicate with the therapist and the resistance against doing so. The desire to communicate brings about recall of the dream while resistance renders it unintelligible. Several researchers have examined how resistance results in patients' failure to report, associate to, respond to, or connect to their dreams.

Today's revisionists view the dream as a whole, rather than having the dreamer associate to its various parts, the dream organization, how adaptive and creative the dream is, its self-regulation, and communicative function are all stressed. These various approaches to the dream remind us that whatever one's metapsychological stance, dream interpretation can be enriched through openness to new ideas, whether the stance stresses the intrapsychic or the interpersonal, the transference or countertransference, or concepts such as the unconscious supervisory aspect of dreams.

X. DIAGNOSTIC OR PROGNOSTIC SPECIFICITY

The question has been raised whether dreams can be used diagnostically or prognostically. Whereas one can learn much about a person's personality by submitting a number of the person's consecutive dreams for careful study using a configurational approach (to the manifest content), there seems to be some agreement that dreams can neither diagnose a patient nor predict an accurate prognosis. Disturbed dreams can be produced by normal individuals and healthy dreams by disturbed individuals. Every type of possible dream can occur in any nosological category. Therapists shy away from risking a diagnosis on the strengths and weaknesses of a person based on a dream protocol. Those writers on specific nosological categories have pointed out some general clinical findings (e.g., fear of intimacy and sense of alienation in borderline and schizophrenic patients), but clearly distinguishable specific diagnostic signs do not seem to be recognizable.

XI. THE INITIAL OR FIRST DREAM

The initial or first dream may be very transparent and often points to the patient's problem in a nutshell. The dream may occur very early in therapy when, the patient is relatively naïve in the language of the dream, the therapeutic alliance is not firmly established, and the capacity to free associate is still not developed. The patient at this point in time is not prepared for a deep interpretation. The therapist hardly knows the patient and the wisest way of responding to the first dream is to deal with the obvious, such as the patient's anxiety about and resistance

to the new experience of therapy. On the one hand, to say too much might lead to the loss of the patient, while to say nothing might cause the patient to feel the therapist is frightened of the patient or the patient's products, and lead to loss of the patient also. We should offer something or the patient might feel we're on the side of prohibition or repression and do not wish the emergence of material. We must be concerned not to encourage dreaming as this might lead the patient to feel we overvalue the patient's production, or being gullible, the patient may keep supplying dreams in a dependent manner. We should be careful not to shock the patient causing the patient to stop dreaming or to discontinue treatment.

XII. COLOR

The percentage of dreams in which color appears varies from 14% to 83% depending on how the inquiry is handled. Color has been found to represent a complex multiple function in dreams, and the implication of color in dreams shows a tendency toward multiple meanings. It may be used by the ego for both camouflage and communication purposes. It can both conceal and reveal and has been claimed to have a defensive screening purpose, to be related to the expressed affect, and have aesthetic considerations. Still others see color as representing a manifestation of the superego, a variety of id strivings including scopophilic and exhibitionistic impulses, exposure to primal scene material, and repressed anal contents, as well as ego identifications. Colors have been said to have symbolic meanings, for example: black—death, evil, or financial stability; white—purity, chastity, virginity; green—envy, money; red—blood, financial instability; yellow—urine, cowardice; and blue—sadness.

XIII. TYPICAL DREAMS

Freud devoted part of Chapter V in his dream book to typical dreams. The most frequent dream is the pursuit or attack dream. Second most frequent are dreams in which a love object is in danger; third, dreams of embarrassment and nakedness; and fourth, dreams of falling and flying.

Freud felt that the third most frequent typical dream, embarrassment and nakedness dreams, represented the wish to be little again when one ran about without

shame, a regression and return to the happy carefree time of childhood, as well as representing infantile desires of exhibitionism. In the embarrassment dream itself though, Freud felt observers do not notice the lack of clothing or involvement of the dreamer. Other writers have denied this conjecture.

Some authors feel the embarrassment dream represents guilt, inferiority feelings, the wish to be one's natural self, and the fear of disapproval from others. Still others feel that "nakedness" and "body exposure" were only one of a number of ways embarrassment can be represented in dreams. When nakedness and embarrassment appear, both must be understood.

Today we still feel embarrassment can stem from the patient's internal impulses such as infantile exhibitionism, or from external situations such as the patient's voyeuristic inclinations. These dreams are common in psychotherapy and most often concern the therapist's felt invasion of privacy (therapist's voyeuristic component), or the patient's embarrassment about revealing certain material in therapy (patient's exhibitionistic component).

XIV. OTHER THEORIES

As with the work of any pioneer, those who followed Freud were in many ways footnotes of agreement or disagreement, of continuity or discontinuity, of accommodating Freud with new understandings of dreams or of offering alternative understandings of how to use dreams in psychotherapy. Those who followed developed numerous theories on dream interpretation, however only the most publicized dream theories believed to offer a systematic and outlined approach to dream analysis are considered. These include the existential-phenomenological, Gestalt (not discussed), and Jungian in addition to Freud. All four theories note key concepts, the principal dream themes, and state major conflicts. Where they differ is in how the dream is handled.

The existential-phenomenological view on the dream is found in Clark Moustakas' book written in 1994. Moustakas deemphasizes pathology and not viewing the dreamer as an "object"—a case, a patient, or a client—but rather as a human being whose suffering is a unique experience and who is trying to come to terms with the problems in his relationships and life. Thus in line with his philosophy, Moustakas emphasizes the positive aspects of dreams hoping to help the individual to overcome the existential angst and therefore plays down the negative aspects. He pushes to the forefront the positive side of polarities such as success

versus failure, enchantment versus disillusionment, zest for life versus neglect of self and others, and commitment versus abandonment. He wants each person to achieve a happier and healthier lifestyle through self-expression, accomplishment, realization, fulfillment, and growth. Moustakas self-discloses, and personalizes, in the belief that it humanizes the therapy process. He rejects the classical analytic understanding of dream analysis and believes the dream is not a symbolic disguise, nothing is hidden or latent, and dreams are not wishful distortions of impulses. He sticks specifically to the manifest content eschewing the wish, disguise, distortion, symbolization, latent, and unconscious functions of dreams.

Carl Jung in 1974 in his book on dreams focused on the purpose of dreams and viewed dreams as attempts to achieve further growth, self-understanding, and individuation. The goal was for the integration of the hidden and unrevealed aspects of the personality (the shadow), with the waking personality. He rejected Freud's unconscious wish fulfillment theory, felt Freud's theory to be too narrow, and that Freud asked the question, "Why," rather than, "What for." He believed too much concentration on the past neglects the present, whereas too much concentration on the present tends to neglect the past. The dream to him was not a façade behind which lies hidden unconscious wishes. He saw dreams as part of nature, with no hidden deceptions.

Like Moustakas, Jung saw the manifest content as holding the whole meaning of the dream. The dream needed the dreamer to associate to the dream images, and he referred to this process as "amplification." He thought association would lead to an underlying "archetype" rather than an unconscious wish, and this would eventually provide the principle source for the explanation and resolution of the dream. He, like Freud, believed that the dream images were tied to the day residue, except he did not limit the residue to the preceding 24 hours.

He felt the material in the dream held successive layers and, if analyzed, would lead back to our cultural history and reveal the collective unconscious as well as the personal unconscious. For Jung, the unconscious was not a storehouse of evil, but rather a natural unity that maintains a neutral and not negative position, and is not dangerous, although the more it is thought to be, the more it will be. Symbols were given no uniform meaning to Jung, who felt all dream images to be important, each having its own special significance. Dreams to him did not conceal secret material; they taught both dreamer and therapist.

He also felt dreams seek to regulate and balance, the night and dream personality and the waking personality, the conscious and unconscious, the two parts of the shadow, and therefore saw a compensatory function in the dream. To Jung, the dream was an attempt to balance the two sides of the self, to establish equilibrium, and homeostasis.

He looked to future growth and achievement toward individuation, and therefore he saw a "prospective" function in dreams. He offered a large range of dream ingredients including the whole history of the race, myths, and legends from the past, fairy tales, and the origins of archetypes in our racial unconscious.

XV. THE BIOLOGICAL CHALLENGE TO DREAM THEORY

The biggest challenge to the dream theory that dreams have psychological meaning and are the fulfillment of unconscious wishes came from the brain researchers and neuroanatomists written in 1977 by J. Allan Hobson and Robert W. McCarley. Since the discovery of REM nearly 50 years ago, many brain researchers feel that Freud's theory of dreams is no longer in tune with the laboratory findings on sleep physiology. They play down past psychological traumas as psychological meaning in favor of memory consolidation and feel that dreams are "mental nonsense," have no psychological references, and should not be taken seriously. Thus, the biological conception of dreams is at odds with the psychological, with a tendency to neglect the nonbiological explanation.

The activation-synthesis explanation of dream formation of Hobson–McCarley challenged all psychoanalytic theories of dreams stating clearly that dreams are "inherently meaningless," random mental activity occurring due to chemical changes accompanying movement from non-REM to REM sleep. They state the dreamer and therapist create meaning to what is essentially random brain static.

In views similar to Hobson–McCarley, some neuroscientists propose that dreaming occurs when the brain stem stirs up emotions, mainly anxiety, anger, and elation. Neural gateways to the external world, memory, and rational thought shut down resulting in bizarre, internal visions that "speak" to the dreamer. In contrast to the Hobson–McCarley theory, and similar to Freud's concepts, Mark Solms in 2000 and others portray dreams as products of complex frontal brain activity that seek out objects of strong interest or desire depicting deep-seated goals in veiled ways to not arouse the

dreamer. A third position considers the data as inconclusive and views the way dreams function in different societies as socially constructed.

Whatever the position taken, as Michael Gazzaniga points out in the 1990s in his split-brain research, the human brain inherently seeks to make sense of all stimuli, including dreams, through the work of what he calls the “interpreter.” The interpreting, sense-making activity of the brain helps explain why psychotherapists and patients have found dreams very rich in meaning. Many therapists believe Hobson and McCarley have overextended their findings, and that whereas the wish may not cause the dream, it does not mean that dreams do not disguise unconscious wishes, or that wishes cannot influence dreams. Suffice it to say that there is still so little understanding of the relation of brain function to dreaming that no theory conclusively invalidates Freud’s. For psychotherapy, these theories neither replace nor supercede the usefulness of understanding dreams, nor do they deny the fact that dreams will always require interpretation.

XVI. CONCLUSION

In an age of brief therapy modalities, once-a-week sessions, the pressure from HMOs to limit treatment length, and a shift in emphasis from discovering the latent content to using the manifest content of the dream, today’s therapist may wonder whether dreams continue to take their lofty position alongside other material helpful to psychotherapy. In answer to this question, it is proposed that the use of dreams can function to broaden and enhance the therapeutic value of psychotherapy by providing useful data about the patient’s life, traumas, conflicts, relationships to significant others, resistances, symptoms, defenses, affect, and behavior. Effective use of dreams in psychotherapy can augment the therapeutic process enabling the pa-

tient to acquire greater strength to inhibit, restrict, select and criticize, spend less time in defensive functioning, and more time at work, play, and love.

See Also the Following Articles

Emotive Imagery ■ History of Psychotherapy ■ Jungian Psychotherapy ■ Neurobiology ■ Psychoanalytic Psychotherapy and Psychoanalysis, Overview ■ Virtual Reality Therapy

Further Reading

- Aron, L. (1990). One-person and two-person psychologies and the method of psychoanalysis. *Psychoanalytic Psychology*, 7, 475–485.
- Blum, H. (1976). The changing use of dreams in psychoanalytic practice: Dreams and free association. *International Journal of Psychoanalysis*, 57, 315–341.
- Erikson, E. H. (1954). The dream specimen in psychoanalysis. *Journal of the American Psychoanalytic Association*, 2, 5–56.
- Freud, S. (1900). *The interpretation of dreams*. Standard edition. London: Hogarth Press.
- Greenson, R. R. (1970). The exceptional position of the dream in psychoanalytic practice. *Psychoanalytic Quarterly*, 39, 519–549.
- Hobson, J. A., & McCarley, R. W. (1977). The brain as a dream state generator: An activation-synthesis hypothesis of the dream process. *American Journal of Psychoanalysis*, 194, 1335–1348.
- Lane, R. C., Daniels, M., & Barber, S. (1995). Configurational approach to manifest dream analysis: Possible acceleration of the patient’s communication in psychoanalytic psychotherapy. *Journal of Contemporary Psychotherapy*, 25, 331–365.
- Lippmann, P. (2000). Dreams and psychoanalysis: A love-hate story. *Psychoanalytic Psychology*, 17, 627–650.
- Sharpe, E. F. (1937/1961). *Dream analysis: A practical handbook for psychoanalysis*. London: Hogarth.
- Waldhorn, H. F. (1967). *Indications for psychoanalysis: The place of the dream in clinical psychoanalysis*. (Kris Study Group, Monograph 2). New York: International Universities Press.



Eating Disorders

Joel Yager

University of New Mexico School of Medicine

- I. Description of Treatment Processes
- II. Case Examples
- III. Summary
- Further Reading

GLOSSARY

anorexia nervosa A psychological and physical condition of semistarvation in which individuals weigh 85% or less of what would ordinarily be their healthy body weight, resulting in physical impairments and, in the 90% of patients who are female, cessation of menses. This condition is due to highly restricted food intake, often accompanied by excessive exercise and sometime purging by self-induced vomiting, laxative use, or other means. These behaviors are usually related to obsessional and perfectionistic thinking that focuses on a distorted body image and undue fears of becoming fat.

binge eating disorder A condition in which individuals binge eat large quantities of food in very short periods of time, often 1000 to 2000 calories or more at a time beyond their nutritional needs, at least several times per week for months on end, and have accompanying feelings of shame, disgust, and being out of control. In contrast to individuals with bulimia nervosa, they do not purge. As a result, these individuals often tend to be obese, some severely so.

bulimia nervosa A condition in which individuals binge eat large quantities of food in very short periods of time, often 1000 to 2000 calories or more, and then purge themselves of what they have eaten, usually by forcing themselves to vomit, and sometimes by means of laxatives, diet pills, diuretic pills, or excessive exercising. These behaviors occur

at least several times per week for months on end. The condition is usually related to overconcern with one's weight and shape, and is accompanied by feelings of shame, disgust, and being out of control.

eating disorders not otherwise specified (EDNOS) A mixed group of disorders that include psychological and behavioral elements of anorexia nervosa and bulimia nervosa but that, technically speaking, do not fully meet the strict criteria set forth in the diagnostic manuals. For example, this category might include individuals who have dieted down to only 12% below healthy weight, or who may still be having scant menses, or who may be binge eating and purging only once per week.

obesity A group of medical conditions marked by being at least 20% above recommended weight for age, height, and frame. Obesity is thought to result from a combination of genetic predispositions in the presence of excessive food intake and inadequate exercise. Except for individuals with severe obesity (e.g., 100% or more than 100 pounds overweight) types and levels of psychopathology in obese individuals tend to resemble that in the rest of the community at large.

Psychotherapeutic approaches to the treatment of eating disorders are varied. Different strategies have been used to treat anorexia nervosa, bulimia nervosa, and binge eating disorder depending on the specific disorder being treated, the severity and stage of the disorder, concurrent comorbid conditions, available treatment studies that address specific problems, and the

theoretical disposition of the clinicians. Systematic clinical trials that examine the efficacy of specified, manualized psychotherapies in the treatment of eating disorders have increased in number and in quality in recent years. These studies, typically involving cognitive-behavior therapy (CBT) and interpersonal therapy (IPT) for bulimia nervosa or binge eating disorder, have generally involved treatment studies that have sometimes been relatively uncomplicated with respect to comorbid conditions. Although the results of these studies merit serious attention, in practice many clinicians favor other psychotherapeutic approaches to the treatment of eating disorders that have not yet been subject to rigorous study, but that by virtue of the accumulated clinical experiences of diligent clinicians, also deserve careful consideration. This article will examine the useful information provided by the evidence-based studies thus far available, but also integrate the clearly helpful insights from accumulated clinical approaches that have not yet been subject to systematic study.

This article will discuss only the treatment of the primary eating disorders (anorexia nervosa, bulimia nervosa, binge eating disorder, and eating disorders not otherwise specified [EDNOS]). These disorders are thought to have a significant psychological component. In contrast, garden variety obesity is considered to be a general medical condition and not to be a psychiatric disorder, since, except for some individuals with severe obesity, rates of psychological disorders are no different among obese individuals than among the population at large. Even among those with severe obesity (e.g., 100% or more overweight) the psychological problems encountered appear primarily to be the results of obesity (e.g., self-disparagement and self-loathing due to being so obese).

In addition to the primary eating disorders, several other conditions occur among individuals with psychiatric disorders that may markedly affect eating behavior and weight. To list a few, individuals with severe depression often suffer a profound loss of appetite (true medical anorexia, not anorexia nervosa) and may not uncommonly lose 10 to 30 pounds. Some patients with so-called atypical depression actually experience an increase in appetite and food cravings ("hyperphagia") and may gain 10 to 30 pounds or more. Occasionally patients with psychotic delusions due to schizophrenia or other conditions may think that their food is poisoned and refuse to eat on that basis, losing weight in the process. Some patients with particular forms of brain damage may eat huge amounts of food and seem insatiable, gaining a great deal of weight in the process.

Many patients receiving antipsychotic or mood-stabilizing medications to treat conditions such as schizophrenia or manic-depressive illness (bipolar disorder) may gain weight as a side effect of these medications. Pharmaceutical companies are actively trying to find new types of medications with fewer weight-related side effects. Beyond these psychiatric conditions, a variety of serious general medical conditions need to be considered by clinicians evaluating patients with changes in appetite and weight. These include conditions causing poor appetite and weight loss such as cancers, HIV infections, tuberculosis, and diabetes as well as conditions causing weight gain, such as hypothyroidism and other endocrine problems and conditions causing the retention of fluids. Although all of these psychiatric and medical conditions are important and merit active treatment, discussion of their psychotherapeutic management is beyond the scope of this article.

I. DESCRIPTION OF TREATMENT PROCESSES

Comprehensive treatment for eating disorders generally requires attention to four distinct features of these disorders: (1) biological aspects, particularly nutritional status and the deleterious consequences of semistarvation and undernutrition on the one hand, or serious obesity on the other; (2) eating disorders related behaviors including restrictive and idiosyncratic eating patterns, eating binges, purging, ordinarily by means of vomiting or use of laxatives, and excessive, compulsive exercise; (3) eating disorder related thoughts, attitudes, and emotions, which may include distorted self-perceptions, overvalued ideas, and self-disparagement, all related to shape and weight, diminished cognitive complexity and increased obsessionality and perfectionistic thinking accompanying malnutrition, and increased nutrition-related emotional fragility with mood and anxiety symptoms; and (4) associated psychopathological and interpersonal problems, the frequent comorbid conditions of mood, anxiety, obsessive-compulsive, trauma-spectrum, personality and substance use/abuse disorders, and sometimes difficult family, interpersonal, and social situations accompanying many clinical eating disorders.

Treatment, accordingly, varies with the age, stage, severity, and chronicity of these conditions, with the family and social context, and with the presence and severity of comorbid medical, psychiatric, and interpersonal conditions. Current considerations suggest

that the initial treatment of the undernourished patient with anorexia nervosa and bulimia nervosa must focus on nutritional rehabilitation. Once that aspect of treatment is well under way, patients are usually more agreeable to participating in psychotherapy, and psychotherapy per se is usually much more effective.

A. Theoretical Bases for Psychotherapeutic Treatment Strategies

Several theoretical streams feed contemporary thinking about psychotherapeutic strategies for patients with eating disorders. These streams include an increased appreciation for biological influences on cognition, the importance of motivational state on patient participation in psychotherapy, developmental and psychodynamic perspectives, particularly those concerning early adolescence and early adulthood in women, learning theories, and a variety of family systems theories.

There are several reasons for thinking about biological issues when planning psychotherapies for patients with eating disorders. First, studies examining semistarvation in normal volunteers demonstrated that these subjects developed significant cognitive and emotional impairments. At 25% below their healthy weights these individuals showed significant psychopathology including loss of complex thinking, obsessional thinking (mostly about food), mood disturbance, irritability, fragmented and disturbed sleep, and social withdrawal. Furthermore, even after regaining the weight they lost, their cognitive and emotional impairments persisted for many months to a year or more. These observations suggest that the malnutrition itself contributes significantly to cognitive impairment and exacerbates many psychopathological features characteristic of anorexia nervosa (and some bulimia nervosa patients) including obsessional thinking, perfectionism, and other eating-disorder related attitudes as well as symptoms of anxiety and depression. Many of these psychopathological features improve substantially simply as a result of refeeding and better nutrition. Accordingly, current views hold that the psychotherapies for anorexia nervosa and bulimia nervosa should be tailored to the patient's degree of malnutrition and cognitive functioning.

Genetic, temperamental, and development issues inform theories concerning psychotherapy for eating disorders. Individuals who develop anorexia nervosa and bulimia nervosa may be more likely than others to show certain premorbid vulnerabilities such as familial

tendencies regarding weight and energy expenditure, obsessionalism, perfectionism, and/or proneness to anxiety, depression, low self-esteem, and uncertain sense of self. In some patients the co-incident occurrence of substance abuse problems may contribute to the initial appearance of eating disorders.

The clinical observations of Hilde Bruch underscored key features seen in patients with eating disorders that demand attention in psychotherapy, particularly distorted perceptions and misconceptions of body size awareness, interoception, bodily functions, hunger and satiety, and issues regarding control of body functions. Bruch also emphasized the diversity of psychological and family features to be found in these disorders. Her observations and ideas have endured and have formed the theoretical basis for therapeutic conceptions and interventions of decades of therapists using psychodynamically oriented and cognitive-behavioral techniques. The eating disorders inventory and the influential cognitive analyses of David Garner and colleagues, which identified common examples of "all or none" thinking in eating disorders patients, was heavily influenced by Bruch's formulations. These conceptions have, in turn, influenced the systematic cognitive-behavioral psychotherapies for patients with anorexia nervosa, bulimia nervosa, and binge eating disorder developed over the past two decades by David Garner, W. Stewart Agras, Katharine Halmi, Christopher Fairburn, Hubert Lacey, James Mitchell, Janet Treasure, G. Terence Wilson, and others.

Families of eating disorders patient display great diversity in dynamics and systems issues, ranging from reasonable health to extreme dysfunction. All parents with a child displaying the self-destructive behaviors and emotional turmoils of serious eating disorders will be upset by these events and display various signs of distress and emotional reactions about and toward that child. In addition to these expected responses, certain dysfunctional patterns have been thought to further contribute to the pathogenesis and maintenance of some patients' problems. Many of these dysfunctional family patterns are not specific to eating disorders but are thought to exacerbate a wide range of psychosomatic conditions and other psychiatric disorders. Salvador Minuchin and his colleagues described some families characterized by parental enmeshment with and overprotectiveness of patients, rigidity in maintaining the status quo, and avoidance of conflict resulting in lack of conflict resolutions in these families. Other difficulties have been attributed to psychological, physical, and/or sexual abuse, high degrees of negative expressed

emotion (in which one or more family members is highly critical and blaming of the patient), teasing, the perverse influences of competitive or narcissistic parents, parental intrusiveness and lack of respect for privacy or autonomy, and colluding with or enabling pathological behaviors in a family member. These observations have led to recognition that family assessment and family education, counseling, and/or psychotherapy may be very important in treating patients with eating disorders, particularly children, adolescents, and young adult patients who may still be living at home and/or be heavily involved with their families of origin. For adults in marriages or committed relationships, issues such as those described above may merit couples therapy.

Clinicians have increasingly appreciated the importance of the patient's motivational state for engagement in treatment and recovery. These views in turn have led to the development of psychotherapeutic strategies for eating disorders based on the transtheoretical models and motivational enhancement strategies based on the work of James Prochaska and Carlo DiClemente and, more recently, of William Miller, approaches that have been primarily used with patients suffering from alcoholism and substance abuse. These strategies try to move patients from what often appears to be a precontemplative state (denial, avoidance, minimization) to contemplative states, in which they may at least acknowledge the existence of a problem, to deliberative states in which they seriously consider the need for treatment, to action states in which they actually engage in treatment. Research studies currently under way focus on the potential value of motivational enhancement strategies at the beginnings of psychotherapy for eating disorders patients. Conceivably, motivational state will be found to correlate strongly with the brain's nutritional status. Individuals with starved brains may be less capable of self-awareness or "insight" and therefore more likely to appear unmotivated than those whose brains are receiving adequate nutrition.

B. Empirical Studies and Review of Treatment Efficacy

Most authorities agree that psychotherapies work best in the context of comprehensive care. This requires that treatments first attend to restoring good nutrition, then to reducing pathological behaviors, and finally, with those aspects of treatment well under way, to dealing with the psychological and emotional aspects of care. The patient's motivation to change and

psychological experiences in relation to behavioral challenges require careful attention throughout the course of treatment.

1. Anorexia Nervosa

Few controlled trials of psychotherapy for anorexia nervosa have been published, in part due to the tremendous difficulties of conducting such trials with this population, especially during phases when the patients are seriously underweight. Consequently, recommendations regarding the role of psychotherapy in early phases of treatment rely strongly on consensus opinions of experienced clinicians and clinical researchers. Investigators increasingly appreciate just how much malnutrition in anorexia nervosa contributes significantly to cognitive impairment and to increases in many characteristic psychopathological features including obsessional thinking, perfectionism, and other eating-disorder related attitudes, as well as symptoms of anxiety, depression, and emotional lability. With nutritional rehabilitation alone, many of these psychopathological features improve significantly. Accordingly, current views suggest that the initial treatment of the undernourished patient with anorexia nervosa must focus on nutritional rehabilitation and that the psychotherapy of anorexia nervosa should be tailored to the degree of malnutrition and level of cognitive functioning of the patient.

Decades of experience showed that classic psychoanalytic approaches were often futile and even harmful for patients ravaged by semistarvation states. It appears that anorexia nervosa patients are most capable of engaging fruitfully in psychotherapeutic discussions and processes only after their severe malnutrition has been reversed. For seriously undernourished patients, those whose weights are 25 to 30% or more below their healthy weights, nutritional rehabilitation often requires skillful nursing care, usually in the setting of an inpatient or day hospital program. Staff members on these units should be psychologically empathic, informed, and sensitive. Their day to day, sometimes moment to moment, interactions with the anorexia nervosa patients are best informed by our understanding of the nature of the psychopathological processes common to patients with these conditions. However, during this initial phase, while psychodynamically and cognitively informed empathic discussions and education with the patients are useful, the value of formal psychotherapy is uncertain, as patients are often not really able to commit to or engage in psychotherapy in a meaningful manner. Furthermore, several authorities

have described that group psychotherapy for patients with anorexia nervosa during this phase may actually be counterproductive, as patients sometimes compete for who can be thinnest or sickest, and sometimes learn maladaptive tricks from one another.

Once weight gain has started, and especially after weight has been restored to a healthy level, psychotherapy appears to be very helpful to help patients make sense of their experiences, come to understand how their symptoms may constitute maladaptive efforts at emotional self-regulation, explore their prior vulnerabilities and the antecedent life circumstances that led to the illness, deal with their families and peers, and learn to cope more adaptively with developmental issues, conflicts, and emotional regulation in their futures. At this point many clinicians use psychodynamically oriented therapies individually and in group settings.

Several psychotherapy trials for anorexia nervosa patients have been undertaken at the point when patients have regained some weight and are ready to leave the hospital. One notable result of CBT studies with anorexia nervosa patients has been a high dropout rate among patients enrolled in these studies. However, recent research with weight restored anorexia nervosa patients by Kathleen Pike and colleagues has also shown that CBT-based psychotherapies can be helpful in preventing relapse. CBT-based programs developed by Thomas Cash, focusing on distortions concerning body image, may be very helpful for patients recovering from anorexia nervosa and patients with other eating disorders as well.

Gerald F. Russell, Ivan Eisler, and colleagues have conducted controlled trials of family versus individual psychotherapy, starting with patients just being discharged from hospital treatment. Their results suggest that if only family therapy or individual is to be administered, for patients who are under the age of 18, family psychotherapy is of more benefit than individual psychotherapy; for older patients individual therapy appears to be more favorable. In actual practice clinicians combine family therapy and individual psychotherapy depending on the patient's circumstances and needs. The critical point suggested by this research is that for younger patients, still living with and/or heavily involved with their families of origin, assessing the entire family and involving the family in psychotherapeutic and psychoeducational activities is essential. Incorporating strategies based on many earlier observations of family-oriented clinicians, James Lock and colleagues have developed a manual for active family treatment aimed at acutely ill children and adolescents with anorexia nervosa and are in the process of testing it empirically.

A randomized controlled trial by Christopher Dare and colleagues showed that although results were modest, a year's treatment with focal psychoanalytic therapy and family therapy were each significantly superior to low-contact "routine" treatment with respect to weight gain and other measures for outpatients with anorexia nervosa. Many of the patients in the trial remained underweight at the end, although a number no longer met strict diagnostic criteria for anorexia nervosa.

Recent research underscores the fact that although good recovery is common for younger onset anorexia nervosa patients who receive good initial and ongoing care, recovery takes a long time even for such individuals, on the order of 5 to 7 years. General clinical consensus suggests that psychotherapy during the period of recovery, particularly during the first several years, may be very helpful for enabling patients to better deal with and make sense of their current and ongoing illnesses; recognize and work through prior vulnerabilities they may have had resulting from their early temperaments and life experiences with family and peers; regulate their emotions, particularly mood and anxiety; contend with personality issues concerning perfectionism, self-confidence, and self-esteem; and anticipate how to deal successfully with future challenges with which they will be forced to cope. A variety of psychodynamic, feminist, and relational themes may be addressed in these therapies.

For difficult-to-treat patients with refractory or chronic anorexia nervosa, much more research will be necessary before we can fully assess the potential benefits of various psychotherapeutic approaches. At present, many authorities believe that a humane, compassionate, supportive psychotherapeutic approach may be most helpful for such patients. Nonverbal, experiential therapies such as art therapy and movement therapy may be of adjunctive benefit.

2. *Bulimia Nervosa*

Initial assessment of the patient with bulimia nervosa for psychotherapeutic readiness, to assess comorbid psychiatric states and attend to them, and to determine what approaches are likely to be most helpful for the given individual is of critical importance to maximize the likelihood of successful treatment. For patients with comorbid substance abuse or dependence disorder, successful treatment of bulimia nervosa ordinarily requires that the substance abuse disorder be attended to first, or at least concurrently. The odds of successfully treating bulimia nervosa in the presence of untreated substance abuse or dependence disorder are

extremely small. As with any psychotherapeutic treatment, the clinician must remain alert to resistances and negative therapeutic reactions, some of which may result from patient factors and some from therapist insensitivities or errors in assessment or judgment. Quick attention to problems as soon as they are identified may be necessary to save treatments that might otherwise end prematurely and unsuccessfully.

The fact that binge eating and purging episodes are relatively easily counted has stimulated and facilitated psychotherapy research for this disorder. Accordingly, a large number of studies have examined the efficacy of several different types of individual and group psychotherapies for bulimia nervosa. Cognitive-behavior therapy (CBT) has been most extensively researched, and is the approach for which most substantial evidence for efficacy exists. Twelve to 20 sessions of CBT treatments, often manualized to permit reliable duplication from center to center, have proven to be highly effective in reducing the number of binge eating and purging episodes and in changing dysfunctional attitudes regarding weight and shape. The treatment is usually conducted in several distinct phases. Initial sessions are usually devoted to helping patients restore healthy patterns of eating and nutrition, enabling them to consume sufficient food without purging so that periods of hunger are avoided. Because hunger pangs are thought to trigger more than 50% of eating binges, reducing hunger often reduces binge eating. The initial phases of CBT involve careful quantitative assessments and diary keeping concerning eating patterns; the types, quantity, and time-course of food consumed during the day without purging; eating binges; *purges*; exercise; and associated antecedent, concurrent, and consequent thoughts, emotions, and associated behaviors. By the very act of keeping these diaries, patients already indicate their compliance, acknowledge concern about their problems, and show sufficient motivation to invest necessary time and psychological energy into recovery. Diary keeping promotes increased awareness of symptoms, so that eating binges and purges are less likely to occur “automatically” in semidissociated states, and also signifies that patients will share their behaviors publicly (at least with their clinicians). These factors may both contribute to the therapeutic benefits derived from this simple procedure.

The middle sessions of CBT are devoted to explicating and dealing with eating disorders related thoughts and emotions—to recognize, elicit, label, examine, and counter the underlying negative and pathological cognitions concerning eating, weight, and shape in relation to

self-evaluation and self-esteem. The late phases of CBT focus on helping patients better cope with the frustrations related to interpersonal and intrapsychic events that often trigger binge eating episodes. About 60% of patients with uncomplicated bulimia nervosa obtain substantial symptomatic relief from this treatment, even without the concurrent use of medications. After the initial series of CBT sessions have concluded, booster sessions, usually scheduled on a monthly basis for a year or two, have been helpful for maintaining improvements and preventing relapse.

Research suggests that for those patients for whom CBT will be an effective intervention, clear-cut improvements should be seen within 6 to 8 weeks. The absence of improvement during that time frame suggests that the patients will require an additional or different modality, for example, the addition of medication such as selective serotonin re-uptake inhibitors (SSRIs) such as fluoxetine to obtain substantial improvement. Some research suggests that adding SSRIs to CBT results in overall better outcomes in bulimia nervosa.

The extent to which complete abstinence from binge eating and purging is achieved varies from study to study, with remission reportedly averaging about 36% for CBT-based psychotherapy alone versus 42 to 49% for studies in which CBT is combined with medication.

Bulimia nervosa has also been successfully treated with interpersonal psychotherapy (IPT), based on the approach of Gerald Klerman and colleagues. Studies have shown that initial posttreatment responses to IPT are not as robust as those to CBT, but that over longer term 2 to 5 years follow-ups, the outcomes for IPT and CBT are similar with respect to reducing binge eating symptoms. Furthermore, since the forms of IPT used in these research studies were intentionally and systematically stripped of all reference to eating problems that could confound them with CBT, they were artificially devoid of subject matter that clinicians treating these disorders would ordinarily discuss and consider with their patients. Taken as a whole, these studies suggest that although CBT principles are more effective than IPT in reducing disturbed attitudes toward shape, weight, and restrictive dieting, a proper integration of IPT strategies in treatment may also be helpful. These strategies may afford reduced emotional tension and better ways of coping with IPT-related concerns of loss, disputes, role transitions, and interpersonal deficits, and thereby contribute to sustained and enduring improvement.

After symptom remission, traditional psychodynamic psychotherapies may be helpful for exploration of long-standing issues concerning development, enduring

psychological conflicts, repetitive self-destructive patterns, and enduring maladaptive aspects of the personality.

Studies of purer forms of behavior therapy without cognitive components have yielded conflicting results. In these studies, for example, researchers have utilized exposure and response prevention techniques, in which individuals who binge eat are prevented from purging. Results are conflicted, but some studies suggest that this treatment does not add to a solid core of CBT.

Several studies have shown CBT in group settings to be moderately effective. Group CBT programs requiring diary keeping, dietary counseling, and dietary management are more effective than those without such components, and programs requiring more frequent sessions at the beginning of treatment (e.g., several times per week) and longer sessions are more effective than those meeting less extensively. In practice, many clinicians favor combining individual and group psychotherapy for bulimia nervosa.

A sizable minority of patients with uncomplicated bulimia nervosa, on the order of 20%, may achieve significant benefit from working through structured, self-guided CBT-based manuals on their own. A number of self-guided programs have been devised and are widely available. For several of these manuals accompanying guides for therapists have been written as well.

Some research suggests that for some patients with bulimia nervosa certain forms of intense psychoeducation may be as effective as CBT. Anecdotal reports hint that some patients with bulimia nervosa may benefit from 12-step oriented programs and that programs such as Overeaters Anonymous may serve as useful adjuncts. Several investigators report that 12-step programs have generally not been successful for patients with anorexia nervosa.

Because large numbers of patients with bulimia nervosa suffer from concurrent mood disorders (primarily recurrent major depressive disorders, dysthymic disorders, and bipolar II disorders), and substantial numbers suffer from anxiety disorders, personality disorders (often demonstrating cluster B and C traits and qualities), histories of psychological, physical, and sexual traumas, and substance abuse disorders, treatment planning must take the comorbid features into consideration, and psychotherapy and psychosocial treatments must be modified to deal with these problems as well. Experimental psychotherapy programs directed by Stephen Wonderlich and colleagues are being tested for difficult to treat so-called multi-impulsive bulimia nervosa patients, that is, patients who in addi-

tion to having difficulty regulating eating behaviors also exhibit difficulties regulating emotions (particularly anger, irritability, and depression) and a variety of behaviors including sleeping (chaotic), shopping (overspending and shoplifting), sex (often impulsive, sometimes promiscuous), and substance use (abuse and/or dependence is common). For such patients, in addition to using traditional eating disorder-related CBT programs and medications as indicated, treatment programs may employ elements of dialectic behavior therapy (DBT) developed by Marcia Linehan and colleagues for patients with parasuicidal behaviors and borderline personality disorder, and intensive outpatient psychotherapies in which patients may be seen even several times per week as well as on a crisis basis.

As with anorexia nervosa, at some stages of treatment incorporation into psychotherapy of more traditional psychodynamic, feminist, and relational themes may be helpful.

3. Binge Eating Disorder

Psychotherapy research involving binge eating disorder has been largely based on treatments for bulimia nervosa and, because substantial numbers of binge eating disorder patients are overweight or obese, on psychotherapy treatment research for obesity. Because obesity is a common comorbid condition, researchers have been concerned with how to relate treatments designed to reduce binge eating behavior with those designed to enhance weight loss. Based on available studies, most experts agree that initial therapeutic aims should focus on reducing binge eating episodes. Once binge eating has been controlled weight loss programs may be more effective. Nevertheless, when results are examined at 5 years after treatment the enduring impact of weight loss programs is not very impressive. For obese patients, “non-diet” approaches that stress self-acceptance, improving body image, and improving health and fitness through exercise and better nutrition, are being developed as alternatives to unsuccessful weight loss programs.

While treatment continues, CBT, behavior therapy, and IPT all reduce rates of binge eating frequency by up to two thirds; however, these improvements tend to deteriorate after treatment is concluded. Denise Wilfley and colleagues conducted a well-executed group psychotherapy study for binge eating disorder using an IPT approach and showed this intervention to rival the effectiveness of CBT in both short and long term across multiple domains. Further, effect sizes for both IPT and CBT were comparable to the best results reported for

individual treatments. As for bulimia nervosa, in practice, elements of CBT and IPT are all useful for treating binge eating disorder, and some patients achieve benefit from self-help programs using professionally developed CBT-oriented manuals. Although no systematic research exists on this point, many patients with binge eating disorder anecdotally report that they receive considerable help from 12-step model programs such as Overeaters Anonymous.

II. CASE EXAMPLES

A. Anorexia Nervosa

Patsy was a 17-year-old high school student who had been suffering from anorexia nervosa since the age of 13. She was characterized by her family as a tenacious and diligent student, and she had been an excellent athlete in middle school and earlier in high school. Starting at ages 9 and 10 she clearly excelled in track and appeared to be headed for the State championship team. However, at age 13, shortly after she first started to menstruate, she started to diet severely in response to a casual remark by a friend at practice concerning her weight. At first her parents thought little of it, but within a few months she had lost considerable weight and the family took her to her pediatrician, who diagnosed anorexia nervosa and referred her to a child psychologist. The pediatrician also thought she was depressed and obsessive and started to treat her with paroxetine (Paxil), a selective serotonin reuptake inhibitor used to treat depression and obsessive-compulsive disorder.

Patsy started weekly individual psychotherapy but her psychotherapist paid relatively little attention to her eating or weight, and within a few months her weight fell further. She minimized the seriousness of her problem, and basically tried to write it off as normal for teenagers. She was at best ambivalent about admitting that her intermittent fatigue was due to undernutrition. Patsy also minimized her interactions with her family around meals, so that they were less likely to observe her very restricted dietary choices and ritualistic food habits. At her pediatrician's insistence she was hospitalized on a medical unit where under the pediatrician's direction and the help of a nutritionist she was required to eat a set number of calories or face gastric tube feedings. With this regimen she managed to gain enough weight to pull out of the danger zone, and she resumed outpatient treatment, adding regular visits to a dietician to her weekly psychotherapy and medication program. For the next year and a half Patsy basically

maintained her status quo, still minimizing her problem and not gaining additional weight. At this point, at about age 16, she was referred to an eating disorders specialist who made the following determinations: (1) Patsy would benefit from the addition of a structured cognitive behavior therapy program; (2) since Patsy was still living at home and highly involved with her parents, and her parents were at their wits end as to how to contend with her, family therapy was necessary; (3) developmental issues concerning her earlier childhood and budding adolescence, and interpersonal issues concerning her family and social life were all pertinent and merited ongoing discussion.

To help enhance her motivation at the start of this new therapeutic push, a bone densitometry test was ordered, which revealed that the amount of calcium stored in Patsy's bones was considerably less than average for young women her age. This piece of concrete information made quite an impression on her. Her motivation to improve increased, although the fears and obsessions that governed her restricted eating patterns were relentless.

With considerable effort, Patsy agreed to keep a diary of her food intake and exercise, and to also record the related thoughts and emotions that preceded, accompanied, and followed her meals. She agreed to try to limit the amount of exercise in which she regularly engaged, although at times, especially when she felt that she overate, her urge to exercise was very strong. Individual sessions consisted of a regular review of her eating patterns and exercising, and also left room for discussion of earlier and current events in her life. In particular, developmental issues focused on her dealings with inconsistent mothering, a somewhat absent and unpredictably angry father, and a difficult and competitive older brother. Current issues concerned her pining for a boyfriend (initially in a somewhat preadolescent manner, because thoughts of physical contact and intimacy were revolting to her), and problems in dealing with a very cliquish group of girlfriends, from which she often felt excluded, in part because her anorexia nervosa resulted in her standing out as deviant in her crowd.

In addition to weekly individual sessions, Patsy was seen together with her mother every other week; occasionally her father, a busy professional, would join these sessions. When her older brother came home from his out-of-town college, he, too, would occasionally join the family meetings. During the initial family meetings Patsy and her parents were able to air and discuss a number of chronic tensions and conflicts that never seemed to get addressed at home and that often

were swept under the rug. The parents were instructed to schedule family meals at which Patsy would be expected to eat, and to lovingly and without rancor or re-primation make sure that she ate a sufficient number of calories and increased her food choices. They were carefully instructed to avoid criticizing, belittling, or blaming her for her anorexia nervosa.

These efforts resulted in a slow, modest, but steady weight gain of 12 pounds, so that by the end of 20 to 30 weeks of outpatient treatment her menstrual periods resumed, accompanied by an increase in typical teenage pimples and thoughts about boys. She still had some obsessional thoughts about food, but she found that as her weight increased, and especially after her periods resumed she was less preoccupied and found it easier to drop her eating rituals. She maintained this progress during her senior year of high school and has been able to successfully go off to an out-of-town college where she is continuing in psychotherapy, but symptomatically much better.

B. Bulimia Nervosa

Jill was a 23-year-old administrative assistant who had been binge eating and purging since the age of 16. Although her mother was slim and even glamorous, her father's side of the family tended to be obese and Jill seemed to have inherited those tendencies. Throughout Jill's teen years her mother constantly urged her to watch her weight, to avoid getting too chubby, so that she would be socially popular. Jill did everything she could to diet, and she exercised rigorously. However, all of her efforts seemed inadequate to prevent a gradual increase in her weight, and she became demoralized at the seeming futility of her battle with the scale. When she was 16, discovering that she could keep her weight down by purging seemed an easy out. Over the next few years the binge eating and purging pattern increased, and she became progressively ashamed and secretive about her eating patterns. Gradually, binge eating and purging seemed to take on a life of their own and Jill became demoralized and depressed, aware that her symptoms were causing social impairment and physical problems. She suffered constant heartburn from gastric acid bathing her esophagus and was alarmed by serious and expensive dental problems.

Jill came for treatment when she first met a man she really cared about, who seemed to care about her as well. She realized that the odds of getting into a serious relationship with him would be jeopardized by her disorder; she feared that telling him about her bulimic symptoms would result in his dropping her, and she

knew that she did not want to threaten or destroy her chances with him by continuing her disorder in secret.

Jill and her therapist started by conducting a full review of her past history and current symptoms. Together they used a cognitive-behaviorally oriented treatment manual designed for individuals with bulimia nervosa. They started with twice-weekly sessions and gradually moved to weekly sessions. Highly motivated at this point, Jill dutifully completed her homework assignments, which focused on keeping a diary of her regular meals and binge eating episodes, together with records of her associated thoughts and emotions. She discovered that she was actually restricting her food intake somewhat, and that when she increased her regular meals the hunger pangs that often triggered her eating binges diminished considerably, making it progressively easier for her to eat normal meals without overeating.

As the initial phase of treatment worked well, over a period of about 2 months, therapy focused on her negative self-concepts regarding body shape and appearance, how she had come to deal with emotional issues concerning her mother by "stuffing my face," and on suggesting other ways that she might be able to cope with negative emotions and difficult family members. Jill also brought up ongoing events with her boyfriend, hoping that the therapist would "check me out" with respect to how she was handling new interpersonal and intimate experiences.

Over the next several months Jill's binge eating and purging episodes subsided considerably, to the point where they would occur rarely, and then only in situations where family conflicts and stress would erupt, usually during visits to her parent's home. She and her therapist worked on relapse prevention techniques, learning to identify circumstances and contextual triggers to which she was still vulnerable, giving her ways of dealing more effectively with these situations. Her therapy sessions were now scheduled on a monthly basis. Over the course of the next year Jill's weight increased by about seven pounds. Although she was not happy about this, she was much better able to tolerate the weight gain than would have been the situation in the past—and since her now fiancée did not seem to mind at all, she even seemed able to laugh about it.

III. SUMMARY

Although some progress has been made in psychotherapy studies for eating disorders, particularly for bulimia nervosa, substantial work remains to be done. We know little about what forms of psychotherapy might make a

meaningful difference at what stages for which types of patients with anorexia nervosa. Much research remains to be done on improving psychotherapies for patients with complex bulimia nervosa (e.g., those with substantial concurrent personality, "trauma spectrum," and/or substance related disorders). Additional studies are required on integrating psychotherapies with other components of treatment (e.g., nutritional rehabilitation and medications among others).

Future research is likely to follow several directions. First, investigators are likely to unbundle some of the current manualized CBT, IPT, and family psychotherapies and better integrate treatment components that seem most helpful. Research on the effectiveness of psychodynamic psychotherapies for eating disorders, including supportive-expressive therapies and therapies based on various theoretical models including self-psychology, are likely to be extended. Psychotherapies based on feminist and relational principles are likely to be subject to more systematic study as well. Finally, strategies based on computer and information technologies are already being applied to the assessment and psychotherapy of eating disorders. Treatment advances will undoubtedly evolve from these modalities, including individual and group formatted e-mail and web-based communications for administering or enhancing professionally guided and self- or peer-guided psychotherapy programs; personal digital assistants (PDAs) to help record and to remind patients to perform certain behaviors; and even virtual reality-based sensory stimulation to facilitate desensitization to certain behavior-inducing cues. We have much to learn about the psychotherapeutic treatment of eating disorders, and the future promises to be very instructive.

See Also the Following Articles

Avoidance Training ■ Behavioral Weight Control Therapies ■ Cognitive Behavior Therapy ■ Controlled Drinking ■

Cultural Issues ■ Feminist Psychotherapy ■ Sports Psychotherapy ■ Substance Dependence: Psychotherapy ■ Women's Issues

Further Reading

- Agras, W. S., & Apple, R. F. (1999). *Overcoming eating disorders: Therapist workbook: A cognitive-behavioral treatment for bulimia nervosa*. New York: Academic Press. (The companion workbook for clients was written by R. F. Apple and W. S. Agras)
- Agras, W. S., Walsh, T., Fairburn, C. G., Wilson, G. T., & Kraemer, H. C. (2000). A multicenter comparison of cognitive-behavioral therapy and interpersonal psychotherapy for bulimia nervosa. *Archives of General Psychiatry*, *57*, 459–466.
- American Psychiatric Association. (2000). *Practice guideline for the treatment of patients with eating disorders*. Washington DC: American Psychiatric Association.
- Bruch, H. (1973). *Eating disorders*. New York: Basic Books.
- Dare, C., Eisler, I., Russell, G., Treasure, J., & Dodge, L. (2001). Psychological therapies for adults with anorexia nervosa: Randomised controlled trial of out-patient treatments. *British Journal of Psychiatry*, *178*, 216–221.
- Eisler, I., Dare, C., Russell, G. F., Szmulker, G., le Grange D., & Dodge, E. (1997). Family and individual therapy in anorexia nervosa. A 5-year follow-up. *Archives of General Psychiatry*, *54*, 1025–1030.
- Fairburn, C., & Wilson, G. T. (Eds.). (1993). *Binge eating: Nature, assessment and treatment*. New York: Guilford.
- Garner, D. M., & Garfinkel, P. E. (Eds.). (1997). *Handbook of treatment for anorexia nervosa and bulimia (2nd ed.)*. New York: Guilford.
- Lock, J., LeGrange, D., Agras, W. S., & Dare, C. (2000). *Treatment manual for anorexia nervosa: A family-based approach*. New York: Guilford.
- Treasure, J. L., Katzman, M., Schmidt, U., Troop, N., Todd, G., & de Silva, P. (1999). Engagement and outcome in the treatment of bulimia nervosa: First phase of a sequential design comparing motivation enhancement therapy and cognitive behavioural therapy. *Behaviour Research and Therapy*, *37*, 405–418.

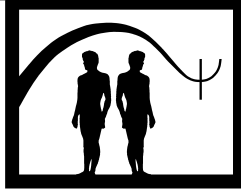

Economic and Policy Issues

Nicholas A. Cummings

University of Nevada, Reno and the Foundation for Behavioral Health

- I. A Brief History of Psychotherapy in Health Care Delivery
- II. Tools and Principles for Decision Making in Health Economics
- III. Supply and Demand in an Industrialized Health Care Environment
- IV. The New Competitive Environment: Winners and Losers
- V. Economic Pressures on Health Care, Psychotherapists, Educators, and Politicians
- VI. Summary
Further Reading

GLOSSARY

assignment A voluntary acceptance or rejection of an agreement to settle for payment by Medicare and Medicaid of 80% of a provider's customary fee. If a provider refuses assignment, he or she may bill the patient for the remainder, called *balance billing*. In 1986 Congress placed severe limitations on balance billing.

benefit design The delineation of all the covered services, procedures, and their costs that a health plan agrees to reimburse, as well as the exclusions, limitations, co-payments, and deductibles in the health plan contract. It is often used to make the health insurance more attractive than that of the competition.

capitation A type of prospective payment for health services based on the rate for each of a large number of covered lives rather than the units of service delivered. Because it is paid in advance at the beginning of each month, it is also known as the pm/pm (rate per member per month). This is

the usual method of payment to HMOs and PPOs that go at risk (guarantee to deliver the contracted services).

carve-out A contractual arrangement by a health plan (insurer) with an independent behavioral care company to assign to it the delivery and risk of all mental health/chemical dependency care. The company assuming the risk is called a carve-out.

case management The direct supervision of cases assigned to providers on a network, with final decision making over the practitioner. Usually conducted by telephone.

case rate The payment to a provider of a fixed fee to cover all services to a patient regardless of their nature or number. The case rate is sometimes fixed in relation to the severity of the patient's problem.

CPI The Consumer Price Index compiled by the Bureau of Labor Statistics (BLS) giving a value to all the goods and services. This is used as a measure of inflation. The BLS also compiles a MCPI (Medical Consumer Price Index) that is not widely used because of its inherent flaws.

deductibles First dollar amounts that the patient must assume before there is reimbursement for the covered costs by the insurer. For example, a policy may pay for a surgical procedure beyond the first \$300.

DRGs Diagnosis Related Groups, a method of payment to hospitals approved by the Congress for Medicare and Medicaid in 1983. There are almost 400 diagnostic groups, each of which has its limited length of stay in the hospital which, if exceeded, is not reimbursed by the federal government. Rapidly the DRGs were adopted by the private sector. There are no DRGs in psychiatry.

HMO Health Maintenance Organization. The major type of managed care company that may provide all the services to its subscribers directly (e.g., Kaiser Health plan), or

contract with hospitals and other providers to deliver the services (e.g., Foundation Health plan).

indemnity coverage Health insurance that reimburses the policy holder for covered services used and paid for.

NHI National Health Insurance, sometimes referring to the Canadian Plan, but more often alluding to one or more U.S. proposals for a one-payor (government) sponsored universal health care plan, the most recent of which was the ill-fated Rodham-Clinton Plan of 1993.

parity Proposals more or less mandating equality in expenditures between physical and mental health care, a number of which have been enacted into state and federal laws.

PPO Preferred Provider Organization, a group of physicians that contracts (usually with HMOs by way of an at-risk capitation) to provide comprehensive health care services.

precertification The requirement that a provider receive advance authorization before providing a health care service or admitting a patient to the hospital. This is very common in psychotherapy and psychiatric hospitalization.

provider Profiling The comparison of every provider's practices with those of his or her peers. An unfavorable comparison often has a sentinel effect, causing the provider to conform. A practitioner who does not conform may be excluded from a network.

RVS code Relative Value Scales originally designed by Dr. L. Hsiao of Harvard for Medicare and Medicaid reimbursement, but widely used in the private sector. The RVS determines how much will be reimbursed for a particular service.

service benefit Payment for covered services made directly to the hospital or other provider by the health plan. This differs from *indemnity* payments that reimburse the insured individual.

third-party payor This is an insurance term (payor, not payer) meaning the entity responsible for paying for an individual's health care bills, be it indemnity insurance, HMO, PPO, or government.

utilization review The ongoing evaluation of the practices of a provider with the intent of determining and curtailing unnecessary services.

I. A BRIEF HISTORY OF PSYCHOTHERAPY IN HEALTH CARE DELIVERY

Health policy regarding psychotherapy prior to the late 1950s was simple and straightforward: It was regarded as too economically elusive to be calculated in health insurance and was, therefore, universally excluded as a covered benefit. In fact, it was not until the mid-1960s that health insurance policies began in any noticeable number to include what was at first limited psychotherapy benefits. Prior to that time all psycho-

therapy was out-of-pocket, making the ability to pay rather than need the determining factor of who received the services of a psychotherapist. It did not matter whether it was with a psychiatrist or a psychologist, as the economic situation was the prevailing factor. But it must be remembered that medical/surgical services were not covered by health insurance until the 1930s, and then not in impressive numbers until the 1940s. How health care came to be part of an insurance benefit, and how eventually psychotherapy was included in such coverage, deserves our consideration as it is part of the evolution of public policy that continues to this day, with ongoing change extending well into the future.

A. American Health Care in the 1930s: The Robin Hood Model of Economics

This decade in history is known as the Great Depression, characterized by hunger, high unemployment, and economic stagnation. It was also the decade when medicine ascended fully to the stature of a profession, having established A and B grade medical schools, replacing the apprenticeships by which characteristically one became a physician in the 1910s and 1920s. Soon all but A grade medical schools were closed, upgrading the profession even more. The physician of the 1930s was proud, altruistic, well-educated, and dedicated. The Hippocratic Oath was taken seriously, and in spite of a shortage, the physicians saw everyone who wanted to see them, even if it meant a consistently 16-hour work day. A request for a house call was never denied. It was unthinkable to press a bill for payment, and no physician would even consider using a collection agency. Patients were seen and house calls were made even when a patient had not paid the accumulated bill for 3 or 4 years. Physicians knew people were strapped financially, and they saw themselves truly as caregivers without regard to compensation. The physicians of the period were overworked, never wealthy, and looked old before their time.

What about the patient who was financially well off? The physician simply doubled or even quadrupled the bill, depending on the patient's wealth, explaining it was up to those who could to pay for those who could not pay. This was an accepted practice, without exploitation or greed on either side. So there was remarkable availability of outpatient health care, regardless of ability to pay, whereas health insurance premiums would have been beyond the reach of most Americans in the 1930s. The system was not perfect, especially in

rural areas that required considerable travel to the nearest physician. Furthermore, some persons were too ashamed to see a physician if they owed money. What about the matter of hospitalization, however?

B. The Birth of Blue Cross and Blue Shield

For decades prior to the 1960s no one thought of a hospital as making a profit or even breaking even. Almost all were nonprofit and most were owned by religious (Catholic, Jewish, Presbyterian, Methodist, Seventh-day Adventist) and other charitable organizations, or were community sponsored. At least twice a year each hospital held a fund-raising drive to make up the shortfall. No one who needed hospitalization was turned away, regardless of ability to pay. The now ever-present insurance card demanded at the reception desk of every hospital was nonexistent.

To create a much-needed revenue stream the hospitals organized into an entity named Blue Cross. For those who could afford the monthly premium, small by today's standards, any needed hospitalization was prepaid. In defense, the physicians organized into a parallel organization named Blue Shield that paid for their services. However, "the Blues" Plans were hospital oriented and covered care only when it was hospital related. The joke of the era was that if you needed to have a hangnail removed you would first need to be hospitalized.

It was important to the policy makers that the hospital doors be kept open during the Great Depression, and a number of concessions were made to Blue Cross and Blue Shield, collectively known as "the Blues." They were separately incorporated in each state, with some states having more than one set of Blues Plans, and they were tied together by membership in the National Association of Blue Cross and Blue Shield Plans. Special legislation designated them to be medical services corporations (nonprofit) that were not only exempt from federal and state taxes, but had other competitive advantages, such as relief from the large financial reserves required of insurance companies and guaranteed discounts for their hospitalized patients. Hospitals and physicians survived, but the seeds for certain negative economic factors were sown in that era. For the first time a two-tiered system emerged in health care between those who could afford the inexpensive membership in Blue Cross and Blue Shield and those who could not and who increasingly were remanded to the county hospital. In addition, for the first time a third-party payor intruded into the previously simple Hippocratic

relationship between doctor and patient. It was the beginning of economic complexities that could not have been anticipated at the time.

C. The History of Capitation

A method of reimbursement for large populations that is based on a set amount of payment per member (enrollee) per month (known in the industry as pm/pm) also had its beginnings in the 1930s. The Ross-Loos Group in Los Angeles and Doctor Callan and Staff in the San Francisco Bay Area solicited subscribers from the general public, as employer-sponsored health insurance was still almost a decade away. This fact, with ready access to health care in spite of an inability to pay, made prepaid health care not very compelling, or even financially attractive. Consequently, the Callan plan suffered an early demise, while the better financed and more aggressively marketed Ross-Loos group survived to the present era.

Concurrently capitation was launched in a big way, but out of necessity, on the Mojave Desert. A then unknown industrialist, Henry J. Kaiser, had won the bid to build the aqueduct from Hoover Dam to Los Angeles, but he was unable to hire enough construction workers to do the job in spite of the high unemployment at the time. These workers were reluctant to take their families to the desert where only dirt roads existed and the rough terrain made the nearest health care facility 15 to 20 hours away. Just as Kaiser was about to fail, a young physician named Sidney Garfield approached him with an offer he could not refuse. For just 5 cents a worker hour he would build and staff the outpatient and inpatient facilities that would guarantee treatment for both his employees and their families.

That day in the early 1930s capitated health care, embodying both the management of care and the acceptance of financial risk, was born in a big way and for all time. While the facilities were being built Garfield launched a prevention program, spending a significant part of the capitation dollars to educate the workers and their families on the avoidance of hazards in the desert: rattlesnake and tarantula spider bites, scorpion stings, heat stroke, and heat exhaustion. He strongly believed this would pay off in reduced treatment costs in the future. He was right, of course, but by implementing this aspect he defined the concept that capitation, which allows for spending the money as the provider sees fit, includes prevention. It was not long before his ideas expanded to include wellness, an integral part of the most successful capitated programs today.

After the aqueduct was completed, Kaiser transported what was still called Sidney Garfield and Associates to Northern California to provide capitated health care to his thousands of shipyard workers during World War II. Then, following the end of that war, Kaiser invited Garfield to offer capitated health care to the general public. In 1946 the Kaiser Permanente Health System was founded as the prototype of the modern health maintenance organization (HMO), a name that was not to be coined by Paul Ellwood for another 15 years. Because capitated care did not have the deductibles, limitations, and exclusions common to health insurance at the time, the Kaiser Health Plan grew rapidly in the next few years to over five million enrollees in California, Oregon, and Hawaii.

The success of the Kaiser Health System eventually caught the attention of the policy makers in Washington, and in 1974 the Congress passed the HMO Enabling Act which provided start-up money to encourage the formation of new HMOs. Most of the new HMOs did not survive beyond the federal funds, but those that did were integral to the rapid rise of managed care in the 1980s.

D. The Rise of Employer-Sponsored Health Insurance

Once the United States plunged into World War II, a hidden enemy was inflation resulting from the overheated economy of total mobilization. The Congress quickly passed wage and price controls, inadvertently hampering the recruitment of workers from the farms to the war economy. Moving literally millions of rural workers to the large cities required incentives, and since higher wages were not permitted, offering complete health care was an acceptable alternative. Emerging from the Great Depression, these workers who flocked to the shipyards, munitions plants, and aircraft factories liked the security that employer-paid health care gave them. After the war the labor unions made it a centerpiece in their collective bargaining, and employers found the tax and other advantages preferable to granting higher wages. By 1950 employer-paid health care was a part of the fabric of our society, and the third-party payor was here to stay.

E. Outmoded Public Policy and Psychotherapy

While access to medicine and surgery was changing rapidly, making physical health care available to most

employed persons, mental health remained mired in an outmoded public policy that believed psychotherapy was not feasible under third-party payment. The development of the Blues had made available hospital care for acute mental conditions, but outpatient care continued to be excluded. For the most part mental conditions were treated in the ever-burgeoning state mental hospitals from which most persons who had been committed did not emerge.

In the meantime, the private practice of psychotherapy was growing rapidly as an out-of-pocket endeavor. The American public emerged from World War II with an insatiable interest in popularized psychotherapy, and especially psychoanalysis. New York, Boston, Chicago, San Francisco, and Los Angeles were the places where scores of psychoanalysts with heavy accents who had relocated from Europe flourished. In addition, doctoral-level psychologists who were trained under postwar government funding were flocking to private practice. This training in large measure was made possible by both V.A. stipends and National Institute of Mental Health (NIMH) training grants that graduated an increasing number of psychiatrists, psychologists, and social workers. NIMH also launched paraprofessional training, erroneously believing there would never be enough trained professionals to meet the post-World War II demand for psychotherapy. Universities took advantage of training grants and stipends and developed programs that included research in psychotherapy along with clinical training. Steadily the focus was shifted from psychoanalysis to brief psychotherapies because of a growing body of research that demonstrated the importance of behavioral and other treatment modalities. The usual arrangement for these newly trained psychologists was to affiliate with a practicing psychiatrist, add psychological testing to the services offered, and assume the psychiatrist's overload of patients. Fees were generally 10 or 15 dollars a session, and there were far more patients than there were practitioners. Eventually this had to change, and it was generally recognized that the private practice of psychotherapy would be severely limited without its inclusion in prepaid health care.

The first comprehensive prepaid psychotherapy benefit was written at the Kaiser Health System. Having discovered in the 1950s that 60% of all physician visits were by patients who either had no physical condition but were somatizing stress, or who had a physical condition exacerbated by stress or emotional factors, the physicians at Kaiser instituted a psychotherapy system in-house to which they could refer. Research on these somatizing patients revealed what has been termed the

medical cost offset phenomenon: The provision of psychological interventions interrupts the somatization cycle and reduces medical care by 65%, with a significant net saving over the cost of providing the psychotherapy. These experiments led the Kaiser system to make the courtesy physician referral-only psychotherapy a covered benefit available to all Kaiser enrollees. By the late 1960s the federal government sponsored a number of replications of the Kaiser studies, all of which led to the general acceptance that psychotherapy is feasible under third-party payment. In the passage of the HMO Enabling Act (1974) there were mandated 20 sessions of psychotherapy for federally chartered HMOs, and most private health policies had included a psychotherapy benefit. Private health plans emulated the 20-session benefit, renewable every year, while others went as high as a 50-session annual benefit. The outmoded policy had been changed, brought about by the public clamor for psychotherapy, coupled with the medical cost offset findings that such coverage was economically possible.

II. TOOLS AND PRINCIPLES FOR DECISION MAKING IN HEALTH ECONOMICS

Expenditures for health care services have risen more rapidly than expenditures on most other goods and services in our economy. In 1965 health care accounted for only \$35.6 billion, or 5% of the gross national product (GNP), which rose by 2000 to over \$1 trillion, or 12% of the GNP. Part of the increase is the result of increases in the population receiving such services, but much of it is the result of price increases for health care. The rapid and continuing increase in the amount of the nation's resources being devoted to health care raises important policy questions, especially since the government now pays over 40% of the total health care expenditure. Are these increases justified? Should the government continue spending so much on health care when there are competing needs in education, social security, and defense? If the resources were allocated differently, could a greater amount of health services be provided? These are the kinds of questions that are the subject matter of health economics.

A. Health Economic Tools

Health economics utilizes two basic tools, along with a set of criteria, for analyzing efficiency and distribu-

tion. The first tool is the use of the techniques of optimization, which seek to maximize efficiency and minimize costs in the allocation of scarce resources. Economists prefer to use the word allocation rather than rationing for obvious reasons, but the fact remains that in every society today there is a scarcity of health care resources, making rationing ubiquitous. Some economists argue that use of the term rationing would require public policy to come to grips with the realities, as has the state of Oregon. In a uniquely direct method the state listed all of the health conditions in terms of priority, from the most important (life threatening) to the least, and assigned a cost and frequency to each. In going down the list, when the cumulative costs exceeded the dollars available, the state drew a line and everything thereafter was not covered by Medicaid. Thus stroke is very high on the list, whereas anencephaly (a condition in which a child is born without a brain) is not covered. Most mental health services did not fare well beyond those needed for acute psychosis, and psychotherapy was all but eliminated. This is a very dramatic application of optimization in response to scarcity and costs, and no other government in the world has had the determination to so squarely face the issue. Economists continue to use the word allocation, with some going so far as to name as "silent rationing" such common health care optimizations as the criteria for medical necessity, waiting lists, benefit exclusions, deductibles, limitations, precertification, utilization review, provider profiling, and many other devices. In fact, managed care itself is regarded by many as a more humane form of rationing than the long waiting list for services common in the Canadian plan.

The second economic tool is the determination of equilibrium situations by which economics can predict such things as the final result in the demand for services. This is not easy to do, and health economics is replete with errors. For example, for years it was axiomatic that adding a new health profession creates new demand and increases costs. This was the argument used for many years to restrict mental health services to psychiatrists only, to the exclusion of psychologists and social workers. This axiom was true in indemnity insurance, but in HMO and other managed care settings, the appropriate replacement of physicians by nurse practitioners, orthopedic surgeons by podiatrists, ophthalmologists by optometrists, and psychiatrists by psychologists reduced costs, increased efficiency, and did not lower quality. Now, in the same vein, doctoral-level psychologists are being replaced in appropriate situations by practitioners with master's degrees.

Much of the effort in forecasting (i.e., equilibrium situations) has been the attempt to predict growth and costs in government entitlement programs, such as Medicaid and Medicare. Whether the application of the method has been less than precise, or whether politicians seek out economists who will say what the advocates want to hear, there has been a consistently large-scale underprediction of costs in every government health program. Macroanalysis, which relies on aggregate data most often derived from large-scale statistics gathered by various government agencies, is open to considerable interpretation, whereas microanalysis applied to smaller-scale outcomes research can be more precise.

B. Basic Health Care Decisions and the Criteria for Decision Making

Implicit in the use of the foregoing analytic tools is a set of criteria for evaluating the economic welfare of the patient. Health economics is driven by scarcity, so that basic choices must be made in output, production, and distribution, all toward achieving optimal health possible with limited resources.

1. Determining the Output of Health Services

The first set of health care decisions that must be made is the determination of the amount of money to be spent: How much should be allocated to, and what should be the composition of, health care services? Using a price system, what services and in what allocation would the health of the consumer be best served? For example, recently Medicare increased psychotherapy services in cases of bereavement and other conditions particularly affecting older adults, but curtailed as grossly ineffective the provision of psychotherapy to advanced Alzheimer's patients in nursing homes. Medicare has gone so far as to require the return of payments previously made for such services, resulting in millions of dollars in paybacks owed by a large number of psychotherapists.

2. Determining the Best Way to Produce Health Services

Health services can be provided (produced) in a variety of settings, from HMOs to solo practice, and in a number of financing strategies, from capitation to fee-for-service. Even within the same kind of setting there can be considerable disparity in efficiency and quality. Recently public policy has shifted toward the increasing use of HMOs and other managed care arrangements

by Medicare and Medicaid, with considerable cost savings to the government and advantages to the recipients, such as drug prescription coverage which did not exist in previous arrangements. However, a number of HMOs could not produce the required services with the capitation given them, one that resembled that of the general (employed) population rather than reflecting the higher costs for the care of the elderly or the indigent, and many have unilaterally pulled out of the program. The Health Care Financing Administration (HCFA) is in the process of adjusting the capitation rate to more realistic levels in an effort to halt the exodus of the HMOs from Medicare and Medicaid. From HCFA's point of view, these programs are a success because they have saved the government millions of dollars. On the other hand, patient satisfaction has been low. In the process of readjusting the rates, HCFA is seeking to learn from the handful of HMOs, such as Kaiser-Permanente, which consistently show strong patient satisfaction.

3. Determining the Distribution of Health Services

The third criterion is deciding on the distribution of health services. This may range from giving all persons all services, which is not possible in an environment of scarcity, or limiting services only to those who can pay, which is not in keeping with optimizing consumer health. Somewhere in between these two extremes is a wide range of options, and these run the gamut from NHI to medical savings accounts. A recent national debate has focused on the issue of *parity*, whether mental health expenditures should be equal to those for physical health. This concept, which has resulted in the enactment of a number of federal and state laws, will be more fully addressed in the discussion of supply and demand.

C. Values Inherent in Health Economics: Output versus Input

Health care can be viewed as an output of the health care industry, or it can be seen as an input to health. This is an important distinction that will determine much of public policy, but the resulting debate with its questioning of theoretical assumptions often stems from the fact that these two views are not mutually exclusive. The first of these sees health care as the output produced by physicians, hospitals, and all other providers in the industry. It is therefore important to measure how efficient is the output, and to determine

the combination of resources that will result in the best trade-off between cost and quality.

An alternative does not view health care as a final output, but as one input among many others that contribute to a final outcome termed “good health.” In this view improvements in health can be the result not only of treatment services, but also prevention programs such as health education, lifestyle change, pollution reduction, and even research and improved training of providers. There is no doubt that the good health that has resulted in the tremendous increase in longevity in the last hundred years is not only the consequence of improved medical care, but also the result of such factors as a safe food and water supply and inoculations. At the present time most poor health and disability results from lifestyles reflecting stress, poor eating habits, lack of exercise, alcohol and drug abuse, tobacco use, and automobile accidents.

The problem for the decision makers in allocating scarce resources is the difficulty in measuring cost efficiencies when expenditures are increased in an area that may or may not prove preventative. For example, money spent in health education to improve lifestyles may not appear as a saving in reduced cardiac and cancer diagnosis and treatment for years or even decades. Likewise, behavioral health programs to reduce stress require allocation of limited money now, whereas the benefit to the system in medical savings may be in the distant future.

In the present era of cost containment, with its fierce competition in managed behavioral care, the emphasis is on output rather than input. Managed behavioral care companies (MBCOs) are operating at a loss or, at best, on thin margins. It is likely there will be continued effort to reduce costs by limiting access and by reducing production costs (i.e., an ever-decreasing fee paid to providers). In a well-planned system, however, input must be balanced with output, otherwise the deficiencies of the present will be perpetuated. This is why in behavioral care the medical cost offset phenomenon, to be discussed later, is so important, as it demonstrates how output can be affected almost immediately by input.

D. The Complexity of the Health Care Market

Rather than being a single market, the health care sector is a complex of a number of interrelated, and often competing markets. The definitions of producer and consumer are not as simple as they are in the usual

economic sequence, for producers are also consumers, and vice versa. Let us take the situation found in managed care as an example. A managed care company (MCO) is at once a producer of services to its covered population, and a purchaser (consumer) of services from PPOs, hospitals, and other providers. There is, therefore, a series of health services consumers, with the patient ultimately designated the *end consumer*.

The MBCO that consumes hospital services is in competition with the hospital with which it contracts, inasmuch as the MBCO is in the business of diverting inpatient (hospital) care to outpatient care because it is more cost-effective. Nurse practitioners, as less expensive providers, replace primary care physicians (PCPs) where feasible and, in turn, many PCPs do the work of specialists. Each of these is a market, and each is competing for a market share in an environment of scarcity. Competing markets are throughout health care: orthopedic surgery versus podiatry, ophthalmology versus optometry, nurse practitioners versus physician assistants, and psychiatry versus psychology (and now psychology versus social work and other master's level practitioners). Some of these markets at times seem to resemble open warfare toward each other. But the economic trend is unmistakable: The health care sector is pushing knowledge downward, using wherever appropriate less expensive providers to do the routine diagnosis and treatment, while using the highly trained providers for the extraordinary diagnosis and treatment. This is accomplished by upgrading the less trained practitioners to recognize the limits of their training and to know when to refer upward.

There can be identified within the health care sector of our economy the education market, the research market, and the prevention market, all competing for a share of the limited dollars. The expectation that nonprofit entities will cost less than their for-profit counterparts does not hold, as many nonprofit hospitals and other providers have a different agenda than efficiency of production, and ultimately cost much more. In fact, the last decade has demonstrated that nonprofit hospitals, accustomed to the traditional Medicare and Medicaid cost-plus-two-percent reimbursement, went bankrupt when they lost this subsidy and had to compete on the open market. This is why the nonprofit hospital has all but disappeared, having been sold to its for-profit counterpart.

In recent years the pharmaceutical market, not thought by many as part of the health care sector, has emerged as a significant cost center. Newer drugs, especially in the psychiatric area, are remarkably effective

with few if any tardive side effects, but they carry a high price tag. Again it is difficult to assess immediately the eventual cost of these newer medications when weighed against potential savings in lengths-of-stay in psychiatric hospitals or duration of outpatient psychotherapy. Managed care for drug costs have emerged, with volume buying for HMOs and mail-order purchases for individuals becoming the trend.

Health economists have pointed out that the efficiency of the separate markets and their interrelationship affects the efficiency with which health care is produced, the cost at which it is produced, and the growth of expenditures. The continuing evaluation of each of these markets, therefore, is of significant concern for public policy.

III. SUPPLY AND DEMAND IN AN INDUSTRIALIZED HEALTH CARE ENVIRONMENT

Some economists would base demand solely on the need for health care, assuming that utilization of physician and hospital services reflects only the care that is actually needed. However, a number of factors determine demand, or even perceived need, and experience has shown that planning based solely on health care need is likely to result in either too few or too many resources.

A. Errors in Demand Based on Perceived Need

An example of the inaccuracy of using only need-based planning is the Hill-Burton federal legislation initiated in the late 1940s. The economists advising the Congress at that time estimated the need to be 4.5 hospital beds per one thousand population as the standard, with 5.5 beds per one thousand for rural populations where distance from home would be a factor. Federal funds were made available for building new hospitals and expanding older ones with the intent of achieving this standard thought to reflect actual need. The results were unfortunate, as this legislation inadvertently fueled a noncompetitive health economy. The hospital beds created far exceeded need, but since hospitalization is an expensive and often a lucrative procedure, the hospital industry saw to it that the beds were all utilized. The slogan of the time became, "A built bed is a filled bed," and the nation experienced its first government-induced inflationary health spiral. It was not

until the Health Reform Act of 1986, which eliminated guaranteed cost-plus reimbursement for hospitals and the DRGs that accompanied that legislation that the truth of the matter came to light: We had created literally twice as many beds as were needed. Not only that, hospitals had been routinely running up expenses since their margin was a percentage of costs: The higher the costs the greater the margin. The incentives were all in the wrong direction, a situation that is not an uncommon characteristic of well-meaning public policy.

The Hill-Burton legislation increased physician costs as well as hospital costs, although to a lesser degree. Physicians were offered various incentives by hospitals to help them fill the surplus of beds, the most frequent of which was the opportunity to have a hospital-based practice. As this was more lucrative than a solely ambulatory practice, many physicians seized the opportunity, thereby increasing overall physician costs.

During his administration President Lyndon Johnson sought to increase the number of dialysis machines in hospitals. The National Academy of Sciences, which lacks expertise in practice matters, was asked to estimate the need. Their recommendation was put into effect, and at the expense of the taxpayer, there was such duplication of available kidney dialysis machines that many were idle most of the time. But the cost of kidney dialysis did not come down, as the per-unit cost was increased to pay for the idle time.

In defense of health economists, perceived need is often different than actual need, or a perceived need may be correct but public policy creates incentives in the wrong direction. In behavioral care this became apparent shortly after the Congress enacted DRGs in medicine and surgery, leaving psychiatry without these restrictions. Almost overnight medical and surgical beds were emptied all over America. A number of hospitals, used to cost-plus reimbursement with no restrictions, went bankrupt before some astute hospital administrators saw an opportunity in the absence of DRGs in psychiatry. Empty hospital beds, as many as 50% in some general hospitals, were quickly converted to psychiatry and substance abuse treatment. These were huckstered on television, educating the public that the hospital was the appropriate place for a wide range of life's problems, and especially the usual difficulties of adolescence. Mental health/chemical dependency (MH/CD) hospitalization costs soared. Government was helpless in curbing the new inflationary spiral in MH/CD, which was now driving up overall health costs after medical/surgery costs had been tethered. Public policy shifted toward allowing the private sector to bring MH/CD costs

in line. Restrictions on the corporate practice of medicine and other laws and regulations were rendered moot, and the managed behavioral health care industry was launched in the mid- to late 1980s.

The spillover to outpatient psychotherapy, particularly in after-discharge counseling and treatment, created a new industry for psychologists who heretofore practiced on an outpatient basis. Going to the hospital to prepare a number of patients for ambulatory care often required only an hour, while billing reflected individual therapy sessions with each of a number of patients. Surveys began to reveal for the first time the existence of substantial six figure annual incomes for some privately practicing psychologists. A behavioral health boom clearly had been created, which rendered behavioral care less likely to foresee the shift in public policy that would bring severe restrictions on outpatient psychotherapy, along with those for hospitalization, by the new MBCOs.

B. The Nullification of the Supply and Demand Relationship

It has long been recognized that the “laws” of supply and demand have not operated in the health care sector as they do in the general economy. This is because the physicians (and therefore the hospitals and other providers) have traditionally controlled both the supply and demand sides of health care. It is the doctor who determines what treatment the patient needs, what procedures should be rendered, and how long the treatment should last.

On the *supply side* the government subsidized the education and training of health care practitioners not only to relieve the critical shortage of a few decades ago, but also to create a surplus of providers. It was widely believed that once there was an ample supply of doctors, costs would go down. This is true in every other industry; a glut of workers results in cheaper wages. As the number of physicians increased beyond the number needed, costs went up instead of down. And the greater the glut, the greater the costs. Physicians, being in control of both supply and demand, merely rendered more treatment, and particularly more procedures, to a declining number of available patients. In practice-building seminars physicians were taught that it is not the number of patient visits, but the number of costly procedures that these visits generate, that enhance physician incomes.

In health economics such practices are termed *demand creation*, which nullify the effects of oversupply

(i.e., too many physicians). Of all of the health professionals, behavioral care specialists (including psychiatrists, psychologists, social workers, marriage and family counselors, master's level psychologists, and substance abuse counselors) are in the greatest oversupply. It would be expected, therefore, that demand creation would be a prevalent practice among psychotherapists and others who treat behavioral disorders. Examples abound, but some of the most widely recognized include the following, although most of these have been curtailed in the new health care environment (see Section IV).

The most obvious example of demand creation is to place the declining numbers of patients available to each practitioner in increasingly longer psychotherapy. One patient seen for 3 years is equivalent to three patients seen for 1 year each. MBCOs have eliminated this practice for all but the relatively few patients willing to pay out-of-pocket.

When the American Psychiatric Association, which publishes the *Diagnostic and Statistical Manual of Mental Disorders* (DSM), changed the definitions in DSM IV of attention deficit disorder (ADD) and attention deficit hyperactivity disorder (ADHD), it quadrupled the number of patients, especially children and adolescents, who would be eligible for treatment. The widespread medication of children and adolescents with psychotropic/stimulant drugs now includes increasing numbers of preschool children, prompting two White House Conferences on the subject in the year 2000.

Another form of demand creation is to create a syndrome for which the psychotherapist already has a treatment. Until recently multiple personality disorder (MPD) seemed to be increasing exponentially. Investigations by payors revealed that the number of patients ostensibly suffering from MPD was directly related to the number of therapists specializing in the therapy of MPD. Patients who had never shown a multiple personality in previous therapies suddenly developed the same when they began seeing a therapist who likes to treat MPD. Also, patients who changed therapists in the opposite direction (from one who specializes in MPD to one who does not) no longer complained of multiple personalities. The question is not whether MPD actually exists as a syndrome, but whether it exists in the sudden explosive numbers in which it was suddenly seen. It eventually became apparent that certain kinds of impressionable patients who want to please the therapist, and especially borderline patients, are highly suggestible and respond positively to all kinds of prodding, such as those designed to elicit the symptoms of MPD.

Another instance of demand creation, which disappeared as rapidly as it had emerged, was the so-called recovery of repressed memories of childhood sexual abuse, especially when it ostensibly involved incest. Many authorities believe the recovered memory was actually created by the hypnosis and other techniques designed to elicit it. During its heyday psychotherapists treating recovered memories proliferated and a significant number of accused persons (many of them the ostensible victims' fathers) went to prison, only to be subsequently found innocent on appeal, or to have their sentences commuted. Several psychotherapists have lost their licenses, and the courts have effectively put an end to the treatment of this syndrome.

The diagnostic criteria of depression are constantly shifting toward including more and more of what has previously been regarded as usual, normal mood swings experienced by all individuals as part of daily living. Undoubtedly much of clinical depression is missed by the physician, but some estimates that at any given time 40% of individuals seeing a physician may be suffering significant clinical depression requiring psychotherapy seems high to most observers. The movement to increase the awareness of depression has gained important advocacy from the wife of the Vice President of the United States, who herself suffered a depression when her daughter was killed in an automobile accident. It has yet to be determined how much may be an important unrecognized demand for which the health care system must develop means of identification, and how much might be demand creation being fostered by providers. In either case, depression that is real and undiagnosed will reveal itself in the health care system under a different guise that will, nonetheless, increase health care costs.

Economists would stress that even though the provider may be in a conflict of interest at times with efforts to control demand, few practitioners would cynically set out to inflate costs. Their avowed intent is that the patient should receive all necessary health services. Nonetheless, one authority has referred to a process of "unconscious fiscal convenience" in describing the conflict between providers and the health system.

C. Parity

There is a movement among providers and other advocates to equate physical and mental health in importance, and to devote equal resources to each. This call for parity has resulted in a number of federal and state laws mandating an equal allocation of resources, but none has resulted in any significant reallocation in favor of mental health. The federal law would exempt

any health plan for which compliance with parity would raise the premium by more than 3%, effectively rendering the law inconsequential. State laws, too, have not had a significant change in resource allocation.

If parity were a serious consideration, either the \$1 trillion annual health budget would have to be doubled, or the existing expenditure would have to reallocate half a trillion dollars each to physical and mental health. Both are seen by health economists as very unlikely events even though legislatively the concept of parity is gaining momentum.

One of the problems is that whereas medicine and surgery are more or less measurable, mental health can encompass an ill-defined range from the vicissitudes of daily living to mute psychosis. Of what is termed "mental health" treatment in the United States, 85% is reportedly provided by primary care physicians. This includes the prescribing of psychotropic drugs and the dispensing of advice and reassurance. How much of this primary care should be credited to the mental health side of parity? Until these problems are resolved, the implementation of parity will be elusive.

D. Mutually Misperceived Demand: The Importance of Medical Cost Offset

In the mid-1950s the Kaiser-Permanente Health System in Northern California discovered that 60% of its patient visits to a physician were by patients who had no physical disease, or whose physical problem was not of sufficient severity to warrant the magnitude of patient debility or discomfort. In that era the relationship of stress to physical symptoms was not readily understood. Today we regard these patients as somatizing: the translation of emotional problems (including stress) into physical symptoms. The 60% of patients' visits to physicians were by persons who were manifesting the physical concomitants of stress, or whose stress was complicating and exacerbating an existing physical illness. This finding was verified in 1967 by testimony to Congress from the American Medical Association that set the figure at 65% to 70%. The reason this phenomenon was discovered at Kaiser-Permanente is because that early HMO did not require that a diagnosis be rendered in order for the physician to be reimbursed. The Kaiser physicians were on salary, while in indemnity insurance the physician must submit a reimbursement form that bears a diagnosis. If one is not established, the physician provides a provisional diagnosis, while in the Kaiser system no diagnosis had to be submitted when

there was none. Thus, after repeated visits yielding negative findings in spite of extensive investigation (laboratory procedures, x-rays, MRIs, and other tests repeated several times), the physician could enter in the patient's chart the finding of "no significant abnormality." The patient then characteristically seeks out another physician and repeats the cycle.

This is both a patient and provider misperception. The patient is convinced a physical disease exists and will eventually be found. With the repetition of tests the patient, rather than being reassured, is increasingly convinced that the next round of examinations will reveal the disease. This is in keeping with what would be expected under psychological reinforcement theory. The physician, who is trained to pursue physical illness until it is found, becomes an inadvertent accomplice in the somatization cycle.

Initial research at Kaiser-Permanente found that brief psychotherapy (5 to 8 sessions) reduced medical utilization by 65%, and that the patient did not resume somatizing. The National Institute of Mental Health (NIMH) has sponsored dozens of replications of this research and has found medical cost offset, more than sufficient to cover the cost of the psychotherapy, present in a variety of settings. However, the more organized the delivery system, and the more primary care and behavioral health are integrated, the greater the medical cost offset. Why, then, after 40 years of research is there not a greater implementation of psychological interventions with the somatizer?

The answer lies in the inelastic barriers found in the health care system. In most health plans data are not obtained in a way that can connect the necessary cause and effect (i.e., tracing back medical visits for those who received psychotherapy). Furthermore, most behavioral care currently is being provided by carve-outs, separate companies that do not connect at all with the computers gathering data on medical and surgical visits.

For this and other reasons, the policy makers at NIMH and the Substance Abuse and Mental Health Services Administration (SAMHSA) are actively encouraging through research and demonstration projects the integration of behavioral health within primary care, and the inclusion of medical cost offset as an economic tool.

IV. THE NEW COMPETITIVE ENVIRONMENT: WINNERS AND LOSERS

The delivery of health care services in the United States changed dramatically in the 1980s. Public policy

in the 1970s favored increased regulation, with a trend toward rate regulation of hospitals, and even the serious consideration of giving hospitals public utility status. The advocacy for national health insurance (NHI) had gained more momentum than at any time in the history of health care. Senator Edward Kennedy was chairing the U.S. Senate Subcommittee on Health that was holding highly visible hearings on a developing plan for single payor, government-sponsored universal health care termed NHI. Then suddenly the political climate did an about face, but not because of any change in the Democrats' control of the Congress. Rather, the shift was the result of an economic crisis discussed below. Senator Russell Long, chairman of the U.S. Senate Finance Committee and a fellow Democrat, replaced Senator Kennedy with Senator Herman Talmadge, a foe of NHI.

A. Why NHI Failed: The Economist's View

NHI would constitute a wide-scale, comprehensive redistribution of health care services. Because there would be no aspect of the health care sector that would not be significantly affected, its potential implementation galvanizes every stakeholder to adopt a strong pro or con position. The AMA opposed it because in the 1970s physicians held virtual monopoly status. The private health insurance industry opposed it because it was burgeoning, and it wanted no increase in a federal health bureaucracy that might impede its growth. The welfare sector favored it because it would bring universal health care to every citizen, and would guarantee the continuation of a welfare system that was already under fire and threatened with cutbacks.

Most health economists opposed NHI because the very nature in which it was proposed would ensure it would go the way of Medicare, Medicaid, and other federal health programs that from their inception were designed to be inefficient. All proposed NHI plans had the incentives in the wrong direction, encouraging higher costs, waste, and even fraud. The American public seemed to agree with the warnings of most health economists since they were seeing firsthand the inefficiencies of such government services as the post office, and hearing daily in the media how the welfare system, Medicare, and Medicaid were out of control financially. The ultimate reason was the fact that the inflationary spiral in health care was considerably higher than that of the general economy, and most authorities pointed to the federal government as the culprit causing the almost out-of-control costs increases. For these

reasons President Nixon's efforts to expand the private health sector through such initiatives as the HMO Enabling Act (1974) were enacted by Congress, while President Carter's request that the Congress enact strong government restrictions on hospitals as a way of reigning-in costs was rejected. In both cases there was clearly a bipartisan public policy in favor of private initiatives rather than government interference.

Rising inflation in the 1960s stimulated the demand for private health insurance. With inflation employees moved into higher tax brackets, and the unions began to bargain for larger health benefits as these were not taxable. The inflationary economy enabled business to pass on increased health costs to consumers. In the meantime, with sharply increased health benefits employees ceased to worry about health costs and the interest in NHI all but disappeared. During this time, however, private health insurance increased 10-fold from \$31 billion annually in 1965 to \$370 billion in 1990.

It should be noted that NHI surfaced again as a serious, but aborted consideration in the first term of the Clinton Administration. The First Lady led the widely publicized Rodham-Clinton Task Force, chaired by Ira Magaziner. It was hampered because it operated in secrecy and no one was certain what the objectives were. There was more than one published version, and a complete list of the five-hundred-plus task force members was published much later and only in response to a court subpoena. Violation of the "sunshine laws" provoked a number of lawsuits, and several of the prominent health economists who had been invited to participate eventually defected. When the courts forced a publication of the members of the Task Force, it was discovered that most were government employees. Unlike the movement for NHI during the 1970s, this most recent plan was short-lived.

B. Other Factors Encouraging a Competitive Health Care Market

From an economist's standpoint, the massive increases in medical expenditures by both the public and private sectors were equivalent to a huge redistribution of wealth, from the taxpayer to the health sector. The forces pushing events in that direction were all but out of control, and in such instances an economy will inevitably seek to tether them. The trend, as it continued to evolve, was clearly in the direction of market competition rather than government regulation.

The supply of physicians had been increasing steadily for two decades, especially since the enactment in 1963

of the Health Professions Educational Assistance Act (HPEA). New medical schools were built and existing ones were significantly expanded. This did not have an immediate effect on costs, for the virtual monopoly status of medicine continued until other factors curtailed its influence. Once this happened, the effect of supply (increased number of physicians) on demand (lower costs) became apparent.

The HMO Act of 1974 has already been discussed as a precursor to the emergence of a competitive market. At the time the Kaiser-Permanente Health system, almost alone among HMOs, was the prototype used to draft the legislation. Edgar Kaiser, the son of the late Henry J. Kaiser, decided that the Kaiser Health plan would give away the technology in the interest of creating as many HMOs as the economy would need. Kaiser physicians were assigned to mentor the fledgling HMOs, and the HMO industry was launched.

HMO hospitals were needed to service the new HMOs, and in 1979 the Congress amended the laws that were inhibiting the building of new hospitals. The existing hospitals opposed the new legislation as it would threaten their revenue. On the other hand, the HMOs needed hospitals that would operate on the new capitated health economy.

Two provisions of the HMO Act deserve mention, as these further enhanced the market effects intended in the creation of the HMOs. The first required all employers to offer as a choice to their employees at least one federally chartered HMO plan. Secondly, these HMOs were exempt from restrictive state practices. Without these two provisions the fledgling HMOs would undoubtedly have been stifled.

The elimination of "free choice" of provider in Medicaid in 1981 opened the door for the states to put their Medicaid services out to bid. Under the guise of patient sovereignty (i.e., freedom to choose a provider), the AMA bitterly opposed this legislation initiated by the Reagan administration as it threatened the core of medicine's monopoly status.

Again during the Reagan administration, in 1983 a new method of paying hospitals for Medicare was introduced. Called DRGs (diagnosis related groups, previously discussed), this had a profound effect on lengths of stay in hospitals. By the time this legislation was enacted, market competition had already advanced in the private sector, and the two initiatives (public and private) ended forever the hospital as a source of runaway health costs.

The introduction of lower-cost health care substitutes by employers enhanced market initiatives. For

the first time outpatient surgery, outpatient detoxification, partial hospitalization, and a number of other alternatives to costly hospitalization became part of the benefit package. Manufacturing had become increasingly concerned with how many dollars health insurance was adding to each unit of production. This was of particular concern to the automotive industry that had become engaged in fierce competition with Japanese car manufacturers. The addition on the average of \$800 in health insurance premiums to the cost of every automobile placed American carmakers at a disadvantage. This was only the first of a number of steps taken by American business, not the least of which was the formation around the country of “business groups on health” that educated business leaders and pressured the health care sector for financial accountability.

A necessary step to foster competition was the enforcement of antitrust laws for the first time in the health sector. Professional societies and state practice acts inhibited market competition by limiting advertising, fee splitting, corporate practice, and the delegation of tasks. Providers could engage in boycotts, essentially ending competition where they chose. Up until 1975 when the Supreme Court ruled against the American Bar Association, it was generally believed that so-called “learned societies” (which included the health professions) were exempt from antitrust laws. Encouraged by this decision, the Federal Trade Commission (FTC) began that same year to enforce the antitrust laws in the health sector, and it charged the AMA with anticompetitive practices. The courts ruled against the AMA in 1978, and on appeal in 1982 the Supreme Court upheld the lower court decision. This completed a steadily growing public policy in favor of market competition in the health sector.

C. The Jackson Hole Group

During the 1970s and early 1980s a group of health economists concerned with the inflationary spiral in health care met regularly at Jackson Hole, Wyoming. They included such notables as Alain Enthoven (Stanford), Paul Ellwood (Minnesota), Stuart Altman (Brandeis), and Uwe Rinehardt (Princeton). Their influence was largely through their writings and lectures, particularly the widely read articles by Enthoven, and their message was clear: Health care needed market competition to tame the inflationary spiral. They also believed the time was right inasmuch as the Congress, the courts, the FTC, and the business community had paved the way over the past decade and a half. It was

Enthoven who gave their concept the name of managed competition.

The influence of the Jackson Hole Group on public policy was profound, although little known by the public at large. Enthoven had been a consultant to the Kaiser-Permanente Health System in its earlier years, and Ellwood was prominent in the HMO movement in Minnesota. California and Minnesota, until recently, were the states with the greatest HMO membership concentration.

The Jackson Hole Group in various ways continued as advisors to government as well as to the emerging managed care industry. What is generally forgotten is that in the Rodham-Clinton plan for government-sponsored universal health care, the concept of managed competition was the centerpiece. Several members of the Jackson Hole Group were members, initially, of the Rodham-Clinton Task Force. They became disenchanted and left the task force after seeing the plan's determination to include market competition alongside incompatible, severe government regulations.

D. The Present Competitive Market

Managed care companies began to emerge in rapid succession alongside HMOs in the early 1980s, gained rapid momentum by 1990, and by 2000 there were 175 million Americans receiving their health care through some kind of managed care. In a little over one decade the health sector had emerged from a series of cottage industries to full industrialization. Those stunned by this unprecedented growth have asked why health care had to industrialize in the first place. Economists would point out that is not the question. Any sector of the economy that accounts for 12% of the GNP must inevitably industrialize. The real question is why it took so long, when manufacturing industrialized in the early 1900s, retail in the 1950s, and transportation in the early 1960s.

E. The Industrialization of Behavioral Care

Industrialization occurs when an economic endeavor emerges from individual, family, or small group proprietorship with limited production (known as cottage industries) to large-scale production employing large work forces and utilizing innovations in technology, organization, and consolidation resulting in increases in both productivity and its resulting lower cost to consumers. Examples of industrialization are

manufacturing (1900s), mining (1930s), transportation (1950s), and retailing (1970s). The industrialization of the automobile is illustrative. Previously hand-built in “garages” at high cost and low productivity, Henry Ford’s introduction of the assembly line resulted in the manufacture of the automobile within the affordability of most Americans. However, industrialization results in a shift of control of the product from the worker (or craftsman) to a capitalistic structure, often resulting in labor strife. When health care was the last major economic sector (14% of the GNP) to industrialize from solo practice and individual hospitals to HMOs, PPOs, and hospital chains, labor strife was revealed in the large-scale dissatisfaction on the part of providers who seemingly lost control of the dispensing of health care.

Of particular significance to psychotherapists is the industrialization of behavioral care, which occurred separately, but in parallel to the industrialization of medicine and surgery. This resulted in the carve-out, discussed earlier, and the reason for that separate entity. DRGs had tethered medical and surgical costs so drastically that hospitals experienced as much as 50% bed vacancies. They converted these to adult and adolescent psychiatric hospitalization and the seemingly ubiquitous 28-day substance abuse hospitalization. Behavioral care costs soared, and at a time DRGs reduced medicine and surgery to an 8% annual inflation rate, behavioral care was driving the entire health spiral upward with its own annual inflationary rate of 16%. With the absence of DRGs in MH/CD, third-party payors felt helpless in the face of this inflationary spiral and began dropping the MH/CD benefit. In time the MH/CD benefit might well have disappeared were it not for the emergence of carve-out managed behavioral care, which offered to increase benefits, lower costs, and cap the benefit package for 3 to 4 years.

During the rapid growth of the managed care industry in general, managed behavioral care also grew phenomenally from zero in the mid-1980s to 75% of the insured market by 2000. This was also the era of the mega-merger in American business, and the health care industry became part of what economists have termed “merger mania.” At one point in time there were literally hundreds of small MBCOs. By 2000 mergers and acquisitions had greatly reduced their number. One MBCO (Magellan) achieved a 40% market share, and when added to Value/Options and United, the top three companies accounted for 60% of market share. Even more startling is the fact that the top 10 companies account for 95% of the managed behavioral care market.

F. Who Are the Economic Winners?

Those who pay the bills for health care are the undisputed winners. This includes employers, insurers, the federal government (which is the largest purchaser of health care in the world), state governments, and ultimately the taxpayer. In 1996 both health care and behavioral care had been reduced to an acceptable annual inflation rate of 4%, the lowest it had been since 1960. Unable to design and implement DRGs for MH/CD, the government had left the problem to the private sector. It paved the way by removing outdated laws and regulations, and then stood back while the MH/CD inflationary rate was tethered by the competitive market and without government interference.

The health care system is also a prime winner, because industrialization saved the health care economy from the bankruptcy predicted by many health economists. It also preserved the MH/CD benefit when otherwise it would probably have disappeared by 1990. When revenues in medicine and surgery dropped precipitously with DRGs, hospitals substituted significant increases in MH/CD services in an effort to recapture income and avoid losses. There resulted a brief spike in the inflation rate of MH/CD to an annualized 16%, prompting a trend by insurers to drop the MH/CD benefit. This was quickly interrupted when the behavioral care carve-outs demonstrated they could go at-risk for these services, relieving the insurers from what they feared would be out of control psychological/psychiatric costs.

G. Who Are the Economic Losers?

The psychiatric hospital, which in 1985 was regarded on Wall Street as a growth industry, is undoubtedly the major loser in the new health care economy. In the mid-1980s it was experiencing a financial boom when psychiatric hospitalization increased markedly. The boom was short-lived because the MBCOs directed their immediate attention to the runaway psychiatric hospitalization rate. Draconian measures quickly brought the rate down by as much as 85 to 90%. The attempt to make up the loss of medical/surgical income through the conversion of empty beds to behavioral care, as much as 50% in a few hospitals but generally about 25%, quickly vanished. For several years thereafter hospitals, and especially psychiatric hospitals, remained in financial difficulty. Some hospitals had to close their doors, but most sought relief through consolidation and mergers with

for-profit hospital chains. This strategy was successful, in that by 1998 the hospitals were less subject to extreme price pressures previously exerted by the managed care companies. Also, by that time they had learned to be competitive.

The impact on the independent solo practice of psychotherapy took somewhat longer to be apparent, but it was no less devastating. The psychotherapist had ample time to heed the warnings, but psychology and social work practices were experiencing their greatest boom and economic hard times just ahead seemed unlikely. Psychiatry had just remedicalized, placing emphasis on biological treatments, which enabled psychologists and social workers to proffer themselves the preeminent psychotherapists. By 1997, however, the private practitioner of psychotherapy was well aware of the tenuous nature of practice following the implementation of stringent measures to tether outpatient psychotherapy costs. These included a series of reduced negotiated fees, utilization review, case management, precertification, treatment plans, and provider profiling. Therapist accountability was introduced into the system, which spurred psychology to significantly increase the empirical study in effective psychotherapies. The MBCOs had the capacity, but little inclination to initiate outcomes research. They left it to federal agencies, predominantly NIMH and SAMHSA, to fund such research that ultimately demystified psychotherapy for the buyers and to some extent the consumers. Henceforth payors, having a greater understanding of the treatment process, did not hesitate to disagree with the unsubstantiated recommendations of the provider. Furthermore, network panels were filled to capacity and were closed. By 2000 nearly 40% of those who had been in the private solo practice of psychotherapy had changed occupations because they could no longer earn their livelihoods in their chosen career.

H. A Critical Retrospective: What Went Right?

The tethering of health care inflation is undoubtedly managed care's greatest accomplishment. Managed care demonstrated that there could be unprecedented cost containment by merely introducing management into a previously undisciplined practitioner cottage industry. That there were also untoward side effects to such an industrialization will be discussed below.

The growth of managed behavioral care to the point it encompassed 75% of the insured market by 2000, in just a little over a decade, reveals an unprecedented

economic need. The managed behavioral care industry accomplished in 10 years what the auto industry required 50 years to accomplish, and the airline industry 30 years.

Accountability was introduced into psychotherapy for the first time, and the era of data-based treatment has just begun. The mechanisms for evidence-based treatment are in place, and soon there will emerge standardized treatment protocols and eventually even practice guidelines. In the meantime, psychotherapists must justify and document treatment plans and outcomes, and goal-oriented therapy has become standard.

There is for the first time a potential for a real continuum of care. It is a little recognized fact that managed behavioral care has resulted in the expansion of services as well as an appropriate substitution of services. Not only have both the numbers of persons seeking services and the number of practitioners providing services increased, but psychiatric hospitalization and private practice psychotherapy have both declined in favor of a continuum of care with expanded services. These have included increases in psychiatric rehabilitation, day treatment, consumer-run peer support, residential treatment, and crisis intervention. Since these services are cost effective when compared to full psychiatric hospitalization or long-term psychotherapy, this expansion of services has resulted in less money expended for behavioral care in 1998 than in 1988, a fact that many authorities find disturbing. Although solo practitioners of psychotherapy may experience the decline in demand for their services as painful, economists see the expansion of care into a continuum as desirable.

In contrast to the previous system, managed care has provided for the first time a nationally organized system of care. This could become the vehicle for the coordination of care on a national scale, something never before possible. So far, however, the industry has demonstrated only lip service, with no notable efforts toward coordinating such care.

The industry has made rapid strides toward self-regulation, with the National Council for Quality Assurance (NCQA) and the Joint Commission on the Accreditation of Healthcare Organizations (JCAHO) taking the lead. Voluntary regulation undoubtedly will make unnecessary some government regulation, but it will not be sufficient to deter all statutory regulation. No industry goes from zero to 75% of the market without incurring outside regulation.

Value, defined as price plus quality, has been difficult to address in health care, and particularly in behavioral care. The American people have come to believe that

more is better, permitting the system to provide too much hospitalization, too many prescriptions, unneeded surgeries, and millions of unnecessary procedures because the patient so demands, it benefits the practitioner, or it quells the fear of malpractice in a litigious world. These do not add up to value. Now that health care is organized and competitive, the buyer for the first time has the opportunity to address value pricing and the clout to defend it in the legislature, the courts, and the marketplace.

I. A Critical Retrospective: What Went Wrong?

The loss of clinical focus resulted in managing costs, not care. Managed behavioral care began as a system that managed care through efficient and effective psychotherapy and thereby contained costs through improved care. In such a clinical system the practitioners were highly trained in both short-term and long-term therapy, with the skill to know when the patient needs one or the other. Once practitioners lost their initial leadership in managed behavioral health care, it was inevitable that the baton would pass to business interests. It is not expected that business interests would appreciate and comprehend the clinical process, but it does not follow that they should be rejecting of it. Perhaps because of fierce hostility from the practitioner community, perhaps out of sheer expediency, or probably a combination of both, the industry disregarded the available techniques that contained costs through clinical effectiveness and relied instead on the familiar “bean counters,” as insurance actuaries and financial managers are known.

As competition mounted, the managed behavioral care companies gave in to pricing pressure. The companies began underbidding each other until the inevitable happened: More and more contracts were signed that were below cost, with no hope of delivering a quality service as agreed. Insurers, employers, and government, elated that inflation was curbed, joined in the frenzy to ratchet down prices even more, while the MBCOs took the public criticism for their poor access and unreasonable denials. The buyers escaped without blame for their part in the price squeeze.

Just as hospitals and practitioners began accommodating lower payments, price pressures on the MBCOs forced them to pass the losses by squeezing the providers. The timing could not have been more disastrous. Outraged providers joined with consumer groups and national anti-managed care coalitions were formed. With fees already at unprecedented lows, the practition-

ers seemingly felt they had little else to lose. The disgruntled bear was transformed into a ferocious grizzly.

Managed care lost the public relations battle. Patients are grateful and loyal to their doctors, not to the health plan. In patient satisfaction surveys the health plan often gets the halo effect from satisfaction with the doctor who is part of that health plan. In surveys where the health plan and the physicians are clearly separated on the questionnaire, doctors are rated high while health plans are rated low. So when practitioners conveyed their rage at managed care to their patients, the latter became a potent, angry constituency that put pressure on employers, legislators, and insurers. A series of television exposés followed, as well as a number of successful movies that portrayed managed care as evil (e.g., *As Good As It Gets*, starring Jack Nicholson). The loss of the public relations battle has resulted in mounting pressures on the Congress and the state legislatures to increase the regulation of the managed behavioral care industry.

J. A Critical Retrospective: What Are the Surprises?

The failure to change practice patterns is surprising in view of the profound impact managed care has had on the health sector. All kinds of practitioner behaviors have been altered, but practice remains a fragmented system where collaboration is still essentially referral from primary care to specialty care and back again. As a nationally organized system it might be expected that managed care would seize the opportunity to make behavioral health part of primary care. A few HMOs are slowly moving in that direction, with most perpetuating a system wherein psychotherapy remains essentially specialty practice. There is one notable exception to the general lack of interest in the integration of behavioral health with primary care. The Kaiser-Permanente Health Plan, with its 4.4 million enrollees in Northern California, has announced its goal that behavioral health and primary care will be integrated into teams and co-location by 2002. In the meantime, lacking the inclusion of behavioral health within primary care, prescriptions for psychotropic drugs (especially SSRIs) have skyrocketed, neutralizing the cost savings derived by ostensibly having eliminated long-term therapy.

In every series of industrialization, the industry found itself initially at odds with its own workforce. Whether it was the automobile, shipping, transportation, or retail industries, their early history was fraught with militant union movements and paralyzing strikes.

As these industries matured, characteristically there was an accommodation between management and labor. Perpetual warfare with its own workforce, the provider in the case of health care, seems to be modulating in medicine and surgery, but increasing in managed behavioral care. This is unfortunate because through the therapeutic transference relationship the psychotherapist's stated hostility toward the managed care company can have a profound impact on the patient's perception of the care received. The MBCOs have to do much more to rectify the rift that exists between themselves and their own providers.

The most surprising glitch has been the extent of the merger mania that characterizes the managed behavioral care sector. In preceding instances of industrialization there has been a period of consolidation, where the successful companies swallow up the unsuccessful. As has been discussed earlier, three companies have a 60% market share and 10 companies have a 95% market share. The merger mania has far exceeded the need to consolidate, suggesting instead an economy of scale. The competition is too fierce to allow for monopoly control, but there is a monopsony that drastically limits the product(s) available to the buyer. This will be discussed in Section V.

V. ECONOMIC PRESSURES ON HEALTH CARE, PSYCHOTHERAPISTS, EDUCATORS, AND POLITICIANS

There are indications that the next several years will result in changes in the health care sector even more dramatic than those seen in the last decade. The pressures of change are already impinging on the behavioral health care system, the psychotherapist, the education establishment that trains behavioral care providers, and the politicians who have a constituency composed of a vast health industry on one side, and the consumers of behavioral care services on the other. Each of these will have its own set of problems as it makes its particular contributions to the future health care system.

A. Economic Pressures on the Behavioral Care Industry

Quality, access and the concept of good enough treatment are all issues challenging the behavioral care

carve-out industry at a time when financial margins are thin and their stocks are in disfavor on the NASDAQ. Pricing pressures have resulted in practices that health economists have termed "low-balling," purposely below cost just to get the market share, and having no intention of providing the contracted services. Similar to this is "bottom-feeding," the seeking out of contracts with entities that provide substandard services, or merging with competitors that are known to provide substandard services. Such practices will not only have a devastating effect on the financial bottom line, but also they make the delivery of a quality product improbable or impossible. Caught in an economic vise, the carve-outs resort to more stringent definitions of what is to be treated and what constitutes sufficient treatment. Inevitably this will lead to complaints of poor quality, denial of access, and a lack of adequate treatment.

It is costly when a patient reenters a managed care system because the previous treatment has been inadequate. Savings generated by shorter treatment than had been necessary are wiped out by relapse, and especially by relapse requiring more costly treatment (e.g., failed short-term psychotherapy that now requires hospitalization of the patient). The carve-out has the right to limit therapy to that which is necessary, the concept of good enough treatment, but the industry needs better measures of determining the economics of "good enough" that go beyond mere savings per initial episode. A unit cost of production extends far into the future before it can be declared that the unit has been successfully delivered, with the desired beneficial effect on health, and at the cost anticipated.

The industry is currently too competitive to be classed as a monopoly even though a few companies control the market. However, since they are all essentially providing products indistinguishable from one another, the buyer has limited choice. Such a state where product differentiation does not exist is known in economics as a monopsony, and was seen in the auto industry when only oversized, gas-guzzling V8s were available to the buyer until the Japanese invaded the American market with budget-sized cars. Those companies that apply sound economic policy to the determination of the good enough treatment will succeed in balancing cost, quality, and access and emerge with a truly differentiated product.

The decreased behavioral health costs reflect the success of the MBHOs in bringing about cost containment, but the dollars available to MH/CD keep shrinking and they may have passed the critical level

necessary to sustain the good health of the patient (consumer). A healthy outcome at the right cost is the ultimate measure employed by most economists. It is doubtful that substantially more resources can be allocated to behavioral care in response to cries for parity without significantly raising costs. The next wave in the economic evolution of health care must be the integration of behavioral health with primary care, the anticipated “carve-in,” which can give true parity (a seamless system between the physical and the psychological) while at the same time producing medical cost offset. Where all of the fat has been taken out of the behavioral care system, the medical/surgical system still suffers an overload of patients who are somatizing. The potential savings in the health system that can be realized by treating the somatizer in an integrated setting are impressive. Most medical cost-offset studies report savings of 5 to 15%. The problem is that the present carve-out arrangement cannot address meaningfully the somatizer. The medical/surgical sector “dumps” the psychologically troubled patient on the carve-out in order to save money, while the carve-out, in turn, does not care what the somatizing costs are as these are absorbed by the medical/surgical capitation, not its own. Consider an integrated system that adequately addresses the source of medical overutilization: A 7% savings in medical care would exceed the total dollars spent annually today on all mental health and chemical dependency treatment costs.

The carve-out pays lip service to the concept of integration, but it is one of the forces opposing change. It is an entrenched industry covering 175 million lives and it is loath to enter a market for which it has lagged in developing the necessary technology. It remains for one large system, such as the current retooling at Kaiser-Permanente in Northern California, to prove successful before integration becomes attractive. At such a time as the concept proves to be both financially and medically viable, large employers and perhaps even the federal government will demand it. At the present time selling integration to the current health industry is about as difficult as selling an electric car to an automotive industry and public committed to the internal combustion engine.

The year 2000 saw again the consistent figure of 25% of Americans who do not have health insurance or have it only intermittently. This group is bimodally distributed, reflecting two distinct groups. There are those who are above the poverty line and are not eligible for Medicaid, but cannot afford private health insurance. The second group is composed of young couples and

individuals in the 25 to 45 age range who have made a decision to rely on the good health associated with younger ages and use what would be health care premiums to grow their small business. Some in the second group have reached a compromise by setting aside in a savings account a portion of what health insurance would cost. It may be a matter for public policy to address the health care needs of the group that cannot afford health insurance. However, a challenge to the managed care industry is the design and implementation of a product that would be attractive to the entrepreneurial-minded small business owners in the second group, the owners of the so-called mom and pop store.

B. Economic Pressures on the Provider (Psychotherapist)

The rage experienced by providers is understandable, but it is time they acknowledged the enduring nature of the changes that have occurred in health care, abandoned their fierce opposition in favor of constructive engagement, and became part of the solution.

This does not mean that providers, having lost their virtual monopolistic status, must abandon their drive for regulation and legislation as a way of regaining that monopoly. But while they pursue redress and restoration of some of their former prerogatives the professions cannot afford to be outside the decision-making arena of the health system upon which they rely for their livelihoods.

Continuous quality improvement underlies much of what managed care is all about. This demands evidence-based, standardized treatments evolved through ongoing outcomes research. It is up to the providers to develop the database and the feedback loop to establish what now must intuitively be accepted as good enough treatment. When the appropriate database has been developed, resulting in protocols and treatment guidelines, the industry will be on firmer economic ground with expectations of good consumer health, reduced relapse rates, and value (cost plus quality). The challenge to the provider is to set aside animosities and join the health care arena in order to improve it.

The managed behavioral care industry will continue to rely on master's-level therapists for the majority of the treatment process, especially after more protocols and manuals are in place. To justify in the future the place of the doctoral-level psychologist, there will have to be a paradigm shift from the Ph.D. psychologist as a psychotherapist to a greatly expanded role. This will include such expertise as clinical supervision

of subdoctoral therapists, outcomes and quality improvement research, program planning, and the ability to understand business from the clinical side and contribute as a provider to important economic decisions. This necessitates an *overhaul of the curriculum* in the education and training of providers, which will be discussed below under challenges for education.

The next wave in the evolution of behavioral care will be its *integration with primary care*. Behavioral care providers will have to learn to function in a primary care setting where the emphasis is on the group management and treatment of chronic diseases. The behavioral care specialist will need considerable education in health psychology, and the training to function as part of a primary care team. This will require a substantial paradigm shift, and the current education and training curriculum will have to be overhauled accordingly.

It must be noted that the profession of psychology has dedicated its resources to obtaining prescription authority for licensed psychologists. This is fiercely opposed by the medical profession, and especially by psychiatry. Practicing psychologists are hoping that the ability to prescribe medications will save their solo practices by mitigating the effects of managed behavioral care. Most health economists believe such prescription authority for psychologists will occur because it is part of the general trend in the health economy to push knowledge downward. Thus, nurse practitioners are doing much of the work of primary care physicians (PCPs), while the PCPs are doing work that traditionally was part of specialty care. When and if such prescription authority is granted to licensed psychologists is not clear at this time. But even if it occurred tomorrow, it would not obviate the necessity of the paradigm shifts necessary for the Ph.D. psychologist to become a participant in the future health system.

C. The Economic Pressures on Education and Training of Behavioral Care Providers

One of the reasons why there have not been more capitation arrangements with providers is the fact that most practitioners lack the knowledge and expertise to design, price, and implement a capitated contract. Those provider groups that have learned to do so have gained considerable freedom from intrusion into their treatment decisions. But in exchange for this autonomy they have accepted risk, and all of the responsibility that comes with that. The present curriculum trains providers for a traditional third-party indemnity insurance system that is

fast disappearing in favor of capitated arrangements. An appropriate curriculum would acquaint the psychologist with the changes in the distribution and expected frequency of modal problems to be treated in a capitated arrangement as opposed to the traditional fee-for-service system. The assumption of risk, and risk management are integral parts of this training, as are many entrepreneurial aspects integral to the new delivery system.

A significant part of the curriculum involves business training, and it will be argued that the modal graduate student in psychology may not be interested in that aspect. This may or may not be true, but the 40% drop in applications to clinical psychology doctoral programs in the 3 years of 1998 to 2000 suggests that potential students are already expressing concern with the diminishing job market in doctoral-level psychology. When the field of doctoral-level clinical psychology and its curriculum are redefined, with an attendant response by the job market, a different type of applicant will be attracted.

In the year 2000 there are two major university doctoral programs undertaking a complete curriculum overhaul, and to a greatly redefined doctorate they are adding a certificate in the business administration of health. The latter would be a postgraduate program open to psychiatrists and social workers as well as psychologists. This might well replace the discernible trend in psychiatry and doctoral-level psychology to pursue the master of business administration (MBA) degree in schools of business, as the new postdoctoral program in graduate schools of psychology would be tailored to their career needs.

D. Economic Pressures on the Political System

The political system has experienced concerted efforts by providers and other constituencies to more stringently regulate HMOs and managed care. Among the legislation under serious consideration have been parity laws, a Patients' Bill of Rights, and laws to inhibit incentives to providers for cost containment. All of these and others are under active consideration by the Congress and state legislatures, and although some laws have been passed, advocates are expressing disappointment in the progress to date. The reluctance on the part of politicians is that public policy at the present time is in favor of the free market forces that have tethered the inflation rate of health care, in general, and the costs of Medicare and Medicaid, in particular. By transferring much of the programs to managed care,

with the subsequent savings in Medicare and Medicaid, the federal budget in these government programs was balanced.

Politicians at the present time are trying to balance the complaints about HMOs and managed care with the inevitability that the industry must be part of the solution if there is to be one. Along with the professional societies exerting pressure, by 2000 the National Alliance for the Mentally Ill (NAMI) emerged as a potent force advocating the strengthening of the 1996 mental health parity law. The bill under serious consideration in the year 2000, called the Mental Health Equitable Treatment Act, would require full insurance parity for schizophrenia, bipolar disorder, major depression, obsessive-compulsive and panic disorders, posttraumatic stress syndrome, autism, anorexia nervosa, and ADD. It takes its lead from the states that have passed some kind of parity law, and cuts directly to parity only for a list of disabling disorders, eliminating the diffuse nature of much mental health diagnosis and treatment. Thirty-four states had passed some kind of parity law by 2000, suggesting the federal government would follow suit, within a reasonable time, especially since current Congressional efforts are bipartisan.

There is not as much agreement on the Patients' Bill of Rights bill. Although some form of the law seems destined for passage, absent the right of the patient to sue the HMO the law would have no teeth. Consumer groups and the trial lawyers' associations are pushing hard for the patient's right to sue, but Congress seems reluctant to turn health care over to the lawyers. Economists argue this would result in a renewed inflationary spiral, threatening to create an insurance premium too costly for most employers. They further argue that the wrong parity legislation, along with opening the system up to a plethora of lawsuits, economically might spell the end of employer-sponsored health care.

An idea currently debated is the option of creating one's own tax-free medical savings account. This puts the patient squarely in charge of her or his own health care, with complete patient choice and the restoration of the doctor-patient relationship as it was before the intrusion of the third-party payor. This idea has proved intriguing to many economists, business leaders, consumer groups, and some few members of Congress, but it still lacks widespread support. On the opposite end of the spectrum are those economists who advocate the greater involvement of the federal government, and call for the renewal of proposals for government-sponsored single-payor universal health care.

VI. SUMMARY

This century, and especially the last 15 years, have seen profound changes in the way health care, including behavioral health care, are delivered in the United States. During that time health care rapidly evolved from a cottage industry to full industrialization.

Prior to World War II diagnosis and treatment were an out-of-pocket, fee-for-service transaction between the patient and a solo practitioner. Blue Cross and Blue Shield were founded in the 1930s to create a revenue stream during the Great Depression for the beleaguered hospitals and the overworked and often not paid physicians. Hospitals were charity-owned or community-based and were never expected to come near breaking even financially. Semiannual fundraisers kept the hospitals afloat for the benefit of the citizenry. But once "the Blues" were formed, the third-party payor intruded into the doctor-patient relationship, and for the first time there was a lowered sensitivity on the part of the patient to health care costs.

World War II saw the rise of employer-sponsored health insurance as a way of attracting workers to the defense industry at a time when wages were frozen by law. After the war consumers liked the concept of the employer paying for health care, and the employers saw certain tax and financial advantages to such an arrangement. Unions made health care a prime issue in collective bargaining. Soon employer-sponsored health insurance was an accepted notion in society, with its increased erosion of the patient's sensitivity to rising costs. More became better.

In the late 1950s through the Hill-Burton hospital funding legislation, and in the 1960s with Medicare and Medicaid, the government stepped into health care in a significant manner and inadvertently began to fuel a noncompetitive medical economy. The inflationary trend in health care began to worry the government and economists. But the government's efforts to contain it seemed to only fuel the inflation further. During this time it must be noted that psychotherapy was not part of health insurance coverage, and such services continued to be out-of-pocket. The demand was still sufficient to support ever-increasing numbers of psychologists joining psychiatrists in the independent practice of psychotherapy. Patients were limited to those who could pay.

By the 1970s the government was becoming alarmed at the rapidly accelerating inflation in health care and took active steps to curtail it. At first there were strong efforts toward government-sponsored universal health

care, but this notion died because neither the practitioners nor the consumers wanted it. In 1974 the government went in the opposite direction with the HMO Enabling Act, thus signaling that it was encouraging free market solutions rather than government-sponsored universal health care. A number of economists known as the Jackson Hole Group persuaded the decision makers that managed competition could bring down inflation. This legislation was patterned after the Kaiser-Permanente Health system established on the west coast right after World War II. It had attracted a great deal of attention, but it had not been emulated up until that time. The government, therefore, launched in the mid-1970s the HMO industry not only with start-up funds, but also with legislation granting the HMOs a competitive edge.

During this same period the attitude of the health insurance industry toward psychotherapy as a covered benefit began to change. This was because of consumer pressure on the one hand, and the experiments at Kaiser-Permanente with the first comprehensive prepaid psychotherapy benefit. Their medical cost offset research discovered that brief psychological interventions could reduce medical costs with the somatizing patients, who comprised 60% of medical visits to physicians, more than sufficient to pay for the psychotherapy. Prepaid psychotherapy became a standard benefit by the end of the 1970s, resulting in large numbers of psychologists and social workers entering the independent practice of psychotherapy.

In the late 1970s to the mid-1980s the government accelerated its efforts to foster managed competition in the health field. Free choice of provider in Medicaid was eliminated in 1981, and the way Medicare paid hospitals was drastically altered in 1983. Payment was by number of days allotted to nearly 400 conditions, called diagnosis related groups (DRGs). This emptied medical surgical beds, but the government did not know how to institute DRGs in psychiatry where now the inflationary spiral existed, fostered by the transfer of empty beds to psychiatric and substance abuse hospitalization. It took the path of unleashing the private sector. It began applying the anti-restraint of trade laws against the health professions, removing prohibitions to advertising, the corporate practice of medicine, and

other impediments to the free market. The managed behavioral care industry was born in the mid-1980s and now, along with managed health care, covers 170 million Americans.

The annual rate of inflation in health care was reduced from 12 to 4% by 1993, the lowest it had been since 1960. Behavioral care had the same low rate of 4%. The winners were those who pay the bills: insurers, employers, the federal government (which is the largest purchaser of health services in the world), and the taxpayers. The losers were the psychiatric hospitals and the private solo practitioners of psychotherapy. The beleaguered professionals were understandably enraged and have adopted an aggressive posture against managed care. The Congress and state legislatures are being pressured for a change in policy from the present market economy to increased regulation of the HMOs and managed care companies. In behavioral care the lobbying is for mental health parity, already passed in 34 states, and a Patients' Bill of Rights with provisions allowing patients to sue their HMOs.

See Also the Following Articles

Alternatives to Psychotherapy ■ Bioethics ■ Collaborative Care ■ Cost Effectiveness ■ Education: Curriculum for Psychotherapy ■ Efficacy ■ Informed Consent ■ Outcome Measures ■ Supervision in Psychotherapy

Further Reading

- Cummings, N. A. (2000). A psychologist's proactive guide to managed care: New roles and opportunities. In A. J. Kent, & M. Hersen (Eds.), *A psychologist's proactive guide to managed mental health care* (pp.141–161). Mahwah, NJ: Lawrence Erlbaum.
- Cummings, N. A. (2000). The first decade of managed behavioral care: What went right and what went wrong? *Critical Strategies: Psychotherapy in Managed Care*, 1, 19.
- Feldstein, P. J. (1996). *Health care economics* (5th ed.). Albany, NY: Delmar Publishers.
- Kent, A. J., and Hersen, M. (2000). *A psychologist's proactive guide to managed mental health care*. Mahwah, NJ: Lawrence Erlbaum.
- Weitz, R. D. (Ed.) (2000). *Psycho-economics: Managed care in mental health in the new millennium*. New York: Haworth Press.

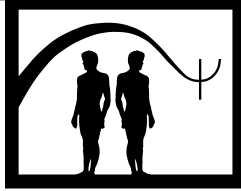

Education: Curriculum for Psychotherapy

James W. Lomax

Baylor College of Medicine

- I. Overall Curriculum Design
- II. Didactic Learning
- III. Experiential Learning and the Development of Self-Awareness
- IV. Supervised Clinical Work with Patients
- V. Role of Personal Therapy in Psychotherapy Education
- VI. Feedback and Evaluation
- VII. Summary
Further Reading

GLOSSARY

didactic learning Educational experiences that focus more on the acquisition of specific content knowledge than on the experiences or behavior of the student.

evaluation Structured assessment of a learner's knowledge, skills, and attitudes that become part of the learner's official academic record.

experiential learning Educational activities in which the learner must use the experience of the learning situation itself (in contrast to those that focus on learning specific content).

feedback Educational exchange in which the learner is presented observations about his or her performance but those observations do not become part of the learner's academic record.

I. OVERALL CURRICULUM DESIGN

The development of psychotherapeutic competence requires the same basic elements common to many

other educational processes. There must be goals and objectives that guide the overall educational plan and determine specific curricular components. Students must be provided a set of organized and sequenced learning experiences to enable progressively more sophisticated mastery of content. These experiences include didactic introduction to basic concepts, supervised experiential learning, and opportunities for progressively independent practice of psychotherapy. Along the way, steady feedback of information about the educational progress and attainments of the students enable them to make "in-flight" alterations of their professional development. An evaluation process (distinct from feedback) assures the student, institution, and public that the psychotherapist is competent to practice independently at the conclusion of the educational process.

In a way that is more quantitatively than qualitatively different from other types of professional education, the person of the psychotherapist changes dramatically during successful psychotherapy education. Even though the same is true to varying degrees in many professional and clinical educational programs, this change of the sense and use of the self as a psychotherapist is especially profound. For this reason, the development of competence in psychotherapy involves a prolonged period of personal vulnerability on the part of learners. The educational process and educational institutions involved in psychotherapy education must therefore pay attention to the potential for hurtful shame and the stifling of creativity,

which occurs if this vulnerability is not recognized and taken into account in constructing educational experiences. There are parallels between being a learner of psychotherapy and being a patient in psychotherapy. Psychotherapy educational programs must strike a balance between treating its learners as mature adults mastering the elements of a respected profession, while also providing a “safe enough” environment for students experiencing disturbances of their internal sense of themselves preceding the development of confidence and affirmation arising from the mastery of a profession.

II. DIDACTIC LEARNING

Most educational systems for psychotherapy begin with didactic learning situations in which basic concepts of psychotherapy are presented. The main mental health disciplines in which psychotherapy is practiced are psychiatry, psychology, and social work. Each of these core disciplines has a wide variety of subspecialties. Each provides subspecialty training in different conceptual models for psychotherapy, such as psychoanalysis, cognitive therapy, interpersonal therapy, and behavioral therapy. Each conceptual model informs therapy based on the constellation of participants in the therapeutic enterprise, such as individual, group, family, and marital therapy.

Psychotherapy may also become an important endeavor of individuals from other disciplines, such as family medicine or religious education. Psychotherapy-like endeavors can also be part of disciplines such as human relations (employee assistance program services) and business administration or management (group or employee relations consultants).

Based on the above diversities of pathways leading one to do psychotherapy, those with administrative responsibility for psychotherapy education (a) can have a wide variety of primary disciplines and (b) must not assume the core competency of their learners in the “basic sciences” of psychotherapy. Even the so-called basic building blocks of psychotherapy education vary depending on the educational context in which psychotherapy education takes place. For example, psychotherapy practiced by medical professionals is more likely to consider neuroscience and studies of brain function as a basic science on which psychotherapy education is built. In contrast, social work professionals are less likely to see the study of the brain as fundamental to psychotherapy and are

more likely to consider psychotherapy built on principles arising from sociology, anthropology, and other behavioral sciences.

What then can be considered basic concepts that should inform all psychotherapy education? This chapter will proceed with the basic assumption that individual psychotherapy is the fundamental cornerstone for developing broad psychotherapy competence. Other therapeutic constellations, such as group, family, or marital therapy will be considered subspecialty applications of that basic competency.

Didactic experiences in psychotherapy education should expose learners to the major conceptual models that inform approaches to understanding and helping patients. Although these very basic concepts can be described in lecture format, it is important that psychotherapy students also have interactive seminars in which basic readings are assumed to have been read by participants. The educational exchange in seminars emphasizes a discussion of abstract concepts leading learners beyond memorization of presented material towards an ability to discuss concepts (the unconscious, cognitive schemata, role conflicts, desensitization, etc.) that are of essential importance to the respective basic conceptual models. Neither lectures nor seminars give learners an in-depth appreciation of the concepts, however. A transition from book learning to experience must be accomplished in a manner that is safe for the public while providing “real” learning experiences for the developing psychotherapist.

III. EXPERIENTIAL LEARNING AND THE DEVELOPMENT OF SELF-AWARENESS

Experiential learning of basic concepts in psychotherapy education includes the use of role-playing, simulated patients, and structured experiential learning activities. In 1978, Dr. Jerry M. Lewis of the Timberlawn Foundation in Dallas, Texas, developed one of the best elaborated structured approaches to learning psychotherapy in *To Be a Therapist*. His work has influenced psychotherapy education in many psychiatric settings. In *Learning Psychotherapy*, Dr. Bernard Beitman advocated a specific evolution of the combination of structured experiential and didactic learning. Lewis focuses more on the internal experience of the learner, especially empathic understanding and patience to organize specific educational components. In contrast, Beitman focuses more on the technique of

the psychotherapist/patient interaction and utilizes educational research studies. Both of these specific models have greater influence in psychiatric education than in other mental health disciplines thus far. In general, however, psychotherapy education in psychology graduate education is more tied to research in psychotherapy outcome and process.

In addition to learning conceptual models for structuring the content of a psychotherapeutic process, the therapist must learn how to structure and use a relationship for therapeutic purposes. To a casual observer psychotherapy may seem to be like an ordinary conversation. In fact, there is nothing magical about psychotherapy. Although there are predictable and repeated elements of psychotherapeutic relationships, formalized rituals (customary in relationships between individuals involved in religious-based relationships) are generally assessed as unhelpful in psychotherapy. As rituals, they become end points instead of a means to accomplish a specific psychotherapeutic goal. In psychotherapy, the therapist does make particular and purposeful use of an interpersonal relationship.

Psychotherapeutic relationships are, therefore, both artificial and transcendent. They are artificial in that the elements of naturalistic human interactions are structured for a particular purpose of human design. They are transcendent in that the therapist abstains from the use of relationships for ordinary human purposes. His or her actions or activities are used for the purpose of helping another individual to achieve the agreed upon goals of the relationship. This does not mean that a therapist tolerates personally abusive activities from a patient. It does mean that a psychotherapist responds with equanimity and therapeutic intent to the patient's behaviors or communications, which in ordinary relationships would likely lead to retaliatory aggression or the pursuit of personal gratifications on the part of the therapist.

In didactic and experiential settings, the psychotherapist learns a type of active listening that is part of all psychotherapeutic relationships. The listening is "active" in that when the therapist is silently listening, he or she is also recording and conceptualizing the content of a patient's communications and is also steadily attempting to experience what is being described by the patient *from* the patient's perspective (empathic understanding in the psychodynamic frame of reference). This "vacillation of ego states" within the mind of the therapist, from a dispassionate scientific observer of information to intimate vicarious immersion with the

person of the patient, is fundamental for psychotherapeutic activity.

The therapist's availability at both the emotional and cognitive level also requires progressive self-awareness on the part of the therapist. That awareness involves attention to the personal, private, idiosyncratic mental contents of the therapist, *and* observation of moment-to-moment exchanges between patient and therapist. The former self-observations are important steps in empathic understanding of the patient and learning from countertransference reactions. The latter observations provide clues about the degree of engagement, genuineness, and authenticity of the therapeutic alliance. The use of audiotape or videotape recordings of interviews and therapy sessions is indispensable in developing therapist self-awareness. Actual observed interviews are helpful for learners who are not involved in the therapeutic relationship being observed, but the opportunity to review recorded therapeutic relationships of one's own therapeutic encounters is a different dimension of learning, which is essential for developing therapeutic competency.

IV. SUPERVISED CLINICAL WORK WITH PATIENTS

Very early on in psychotherapy education, supervised clinical experiences with patients are necessary to transform concepts learned from books or classrooms into actual human encounters. At least some of the aforementioned experiential learning activities in a situation without clinical responsibility should precede attempts at psychotherapeutic relationships with patients. Psychiatry residency programs take as a fundamental aspect of physician behavior the dictum *prima non nocere*, or "first do no harm." In psychiatric practice, patient care is somewhat artificially but commonly separated into general psychiatric care (providing medications and general management for a patient's psychological difficulties) and psychotherapeutic care. Videotaped encounters of interviews with patients for whom the learner is providing general psychiatric services, but not psychotherapy, are often viewed in interviewing seminars for first-year residents prior to their assuming psychotherapeutic responsibilities with patients. The videotaped interviews are subsequently viewed in a classroom setting. The emphasis in such settings includes obtaining information in order to make a diagnosis. Attention is also paid to the resident's ability to listen and to gather information in a sensitive,

tactful, and well-timed manner. These activities are seen as building blocks for learning psychotherapeutic relationships. Discussions of how the resident subjectively responds to the patient communications and observations of verbal and nonverbal communications and their consequences begin the development of therapist self-awareness. For most psychiatry training programs, these very rudimentary skills are all that is expected for first-year residents.

The student psychotherapist should also have the opportunity to observe more senior practitioners actually doing interviews and psychotherapy. Seminars often employ videotaped therapy of the senior practitioner, but one-way mirror viewing of therapy may also be useful.

Many programs offer an experiential conference to help students identify and enhance their empathic abilities and learn to listen to the way in which a patient moves from topic to topic in an unstructured interview (the associative process). These conferences were a major contribution of Dr. Lewis's model of psychotherapy education mentioned previously. Learning experiences for the psychotherapist must eventually include observed and supervised therapeutic relationships involving brief and longer-term individual psychotherapies utilizing psychodynamic, cognitive, interpersonal, and behavioral conceptual framework to organize the therapy. Analogous experiences should take place for conducting group, family, and marital therapy. The brief therapies learned should be both those that are brief because of a clinical decision to employ a focal or targeted psychotherapy and those therapies that are brief because of external limitations or constraints on the treatment relationship. These different determinants for pursuing brief therapeutic relationships involve very different issues for the therapist-patient relationship.

Individual supervision is a special learning context for psychotherapy education. This format arose out of the earliest attempts to structure learning about psychotherapy. There are several analogies between the supervisor-supervisee relationship of individual supervision to the patient-therapist relationship of psychotherapy, but there are also important differences. The notion of individual supervision came out of the Berlin Psychoanalytic Congress in 1922, when the first requirements for formalized training in psychoanalysis were developed. In individual supervision, the supervisee (psychotherapy learner) and supervisor meet on a regular basis over a defined period of time—at least a

one-year duration in most psychotherapy programs. The purpose of these meetings is to learn about both patients and the therapist. Both the therapist's self-awareness and the therapist's awareness of the therapeutic process are objects of scrutiny. The various analogies to the therapeutic relationship are most poignant when what is described as a "parallel process" emerges. This concept was well articulated by R. Ekstein and R. Wallerstein in 1972 to describe situations in which problems being reported by the patient to the therapist emerge in the relationship between the supervisee and supervisor.

A variety of theories exist about why this extraordinary process occurs. Nonetheless, it is a common occurrence in the psychodynamic psychotherapies and a source of powerful learning for the supervisee. It is also considered an indicator of the supervisor's competence to be able to identify and make use of such experiences. As with other parts of the supervisory relationship, the goal of exploring such a process is to learn how factors within the student therapist interfere with his or her therapeutic activity. This exploration and focus is different from, but analogous to, learning about experiences in the patient-therapist relationship, as indicators of a history of the patient's personal difficulties. The distinction between the therapeutic and supervisory task and focus may seem simple in concept. It is actually quite a complex issue. Supervisees predictably feel quite vulnerable when parallel processes occur or they discuss personal conflicts or inhibitions as therapists. It is important that a strong educational alliance is developed and maintained in individual supervision. That supervisory alliance enables learning during times in which the self of the therapist feels exposed and vulnerable.

V. ROLE OF PERSONAL THERAPY IN PSYCHOTHERAPY EDUCATION

Personal therapy is an even more personal step than individual supervision in learning about psychotherapy. Personal therapy in the form of psychoanalysis is required by psychoanalytic institutes and some psychotherapy programs, especially those with a psychodynamic conceptual orientation. It is difficult, however, to "require" a personal therapy experience under any circumstance, and required therapy distorts the therapeutic relationship to some degree. Much has been made in the literature about psychoanalytic educa-

tion, about how the “training analysis” of the psychoanalytic student (“candidate”) significantly influences the process of psychoanalytic education. A positive experience of personal therapy, however, greatly enriches and provides a new level of personal conviction about the therapeutic process. Personal therapy is, therefore, an important, even if elective, part of psychotherapy education.

With respect to group therapies, analogous experiential learning formats for the learning therapist also exist. A.K. Rice, or the “Tavistock” type of group learning experiences, helps individuals learn about the generic group processes that are part of any working group. In general, National Training Laboratory (NTL) groups are helpful in learning how to give and receive feedback, and A. K. Rice groups provide education about issues of power and authority, the delegation of authority, and principles of leadership effectiveness. Other types of group learning experiences are less frequently incorporated into formal psychotherapy training programs but may be encouraged by program directors as ways to broaden the student therapist’s accustomed sense of self.

VI. FEEDBACK AND EVALUATION

In each of the preceding learning experiences, an evaluation instrument must be developed to assess the progress of the future psychotherapist. The student therapist’s participation in didactic seminars is routinely evaluated by the seminar leader. Many programs use paper-and-pencil tests to assess the conceptual grasp of didactic material. The first broadly used test of cognitive knowledge was only recently developed by the psychiatry residency program at Columbia University. Videotaped diagnostic interviews and videotaped therapy sessions are an extremely important part of the evaluation process, as well as learning experiences. Such tapes are a critically important measure of the beginning therapist’s ability to have his or her first independent clinical encounter with patients.

Didactic seminars in more advanced stages of psychotherapy education usually involve presenting individual cases for discussion of how to organize treatment for the patient. It is particularly useful to have an educational conference in which a single case being treated by a psychotherapy learner is presented over time throughout a series of meetings for an entire course of treatment. This “continuous case conference” is usually supervised by a senior member of

the educational team. The conference leader helps connect the important themes and processes from one session to the other and integrates an actual therapy with a conceptual model or models. Both the primary presenter at case conferences and the learning group are evaluated with respect to their ability to observe and articulate matters about the patient and the therapist.

Again, because of the powerful sense of vulnerability in learning to become a psychotherapist, it is often helpful to structure initial feedback about their skills and weaknesses before providing a formal evaluation. This principle has also been found to be helpful in many aspects of medical education.

Reports from individual supervisors are generally considered the most important source for evaluation of psychotherapeutic competence. Such evaluations should be systematically solicited by the program director and reviewed with the student therapist on a regular basis. They should assess therapeutic competency and describe both strengths and areas for improvement to be pursued in future components of the training program.

Outcome measurements are difficult matters for psychotherapy education, but they are achieving increasing importance in measuring quality and competence. Outcome measures include both measures of patient satisfaction with the therapist and therapeutic process and the use of rating scales to measure change in signs and symptoms of patients being treated by the psychotherapy student.

VII. SUMMARY

In conclusion, a psychotherapy curriculum involves substantial immersion in a mix of educational experiences that are both personal and professional. There is much hard data to be learned and mastered. Individuals who are quite competent in some aspects of their discipline may function poorly or have to work hard to develop different aspects of themselves to become competent in psychotherapy. The experience of personal change during psychotherapy education often leads individuals to seek personal therapy for themselves as part of developing professional competence. Although mastery of concepts is an important criterion to bring to bear in judging a particular therapist, a good therapist also has to develop an extraordinary set of personal qualities to be used in their efforts to understand and attenuate human suffering.

See Also the Following Articles

Behavior Therapy: Theoretical Bases ■ Bioethics ■ Confidentiality ■ Cultural Issues ■ Economic and Policy Issues ■ History of Psychotherapy ■ Legal Dimensions of Psychiatry ■ Supervision in Psychotherapy

Further Reading

- Beitman, B., & Yue, D. (1999). *Learning psychotherapy*. New York: Norton.
- Ekstein, R., & Wallerstein, R. (1972). *The teaching and learning of psychotherapy*. New York: International Universities Press.
- Jacobs, D., David, P., & Meyer, D. (1995). *The supervisory encounter*. New Haven, CT: Yale University Press.
- Kernberg, O. (1986). Institutional problems of psychoanalytic education. *Journal of the American Psychoanalytic Association* 34.
- Lewis, J. (1978). *To be a therapist: The teaching and learning*. New York: Brunner Mazel.
- Lomax, J., & Webb, L. (1983). Differential utility of A.K. Rice and National Training Laboratory experiential conferences for psychiatry residents. *Journal of Psychiatric Education*, 7.
- Mohl, P., Lomax, J., et al. (1993). Psychotherapy training for the psychiatrist of the future. *American Journal of Psychiatry*, 147.

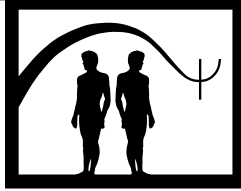

Effectiveness of Psychotherapy

Michael J. Lambert and David A. Vermeersch

Brigham Young University

- I. Effectiveness of Psychotherapy
 - II. Factors Important to Psychotherapy Outcome
 - III. Negative Effects of Psychotherapy
 - IV. Summary
- Further Reading

GLOSSARY

common factors Active ingredients that are common to all forms of psychotherapy and contribute to positive patient outcome.

patient variables Characteristics of patients related to psychotherapy outcome.

psychotherapy outcome The effects of psychotherapy on patient status.

specific intervention variables Therapeutic techniques or interventions unique to a specific form of psychotherapy.

Psychotherapy, defined within the broader context of the field of psychology, is a skilled and intentional treatment process whereby the thoughts, feelings, and behavior of a person are modified with the intention of facilitating increased functioning and life adjustment. Psychologists, psychiatrists, and clinical social workers are authorized to provide psychotherapy to children, adolescents, and adults in individual, group, couples, and family therapy sessions. Although there are hundreds of different psychotherapies that conceptualize and treat problems in different ways, most are varia-

tions of three general paradigms: psychodynamic, cognitive-behavioral, and humanistic-phenomenological. For decades researchers have assessed the positive and negative effects of psychotherapy on patients. This entry will review research that has established the effectiveness of psychotherapy within the aforementioned paradigms, review factors important to psychotherapy outcome, and discuss the negative effects associated with psychotherapy.

I. EFFECTIVENESS OF PSYCHOTHERAPY

In 1952, Hans J. Eysenck published a review of the effectiveness of psychotherapy, concluding that 74% of patients, drawn from 24 studies and diagnosed as neurotic, were found to make progress considered equivalent to a similarly diagnosed group of individuals who received no treatment over a two-year time period. Since Eysenck's review, a large body of research has been directed toward determining whether psychotherapy assists patients to solve problems, reduce symptoms, and improve interpersonal and social functioning beyond the improvements that can be expected from existing social supports and inner homeostatic mechanisms. From the early 1930s to the 1960s, this was a much debated topic. The 1970s, 1980s, and 1990s saw an increase in both the number of studies undertaken and the quality of studies used to evaluate the outcome of therapy. This research has left little doubt that pa-

tients who undergo treatment fare substantially better than untreated individuals.

One mathematical technique, meta-analysis, is used to summarize large collections of empirical data. It has been successfully used to estimate the actual size of treatment effects in terms of percentage of patients who improve under various treatments compared to untreated controls. In general, meta-analytic reviews suggest that the average person receiving a placebo treatment is better off than approximately 66% of the untreated sample, while the average person receiving psychotherapy is better off than 80% of the untreated sample. This information indicates that while clients who receive placebo treatments show more improvement than untreated individuals, this improvement falls well short of that occurring in clients who undergo a course of psychotherapy.

Not only has research on the outcome of psychotherapy clearly demonstrated the effectiveness of treatment, but this finding is enhanced by data suggesting that the road to recovery is not long and that treatment gains are maintained. For example, multiple studies have found that approximately 75% of clients can be expected to have recovered substantially after 50 sessions or nearly a year of weekly psychotherapy and that even with as few as 8 to 10 sessions about 50% of clients have shown reliable improvement. Notwithstanding these findings, the amount of therapy needed to produce effects continues to be debated. The pattern of changes during psychotherapy has also been examined, with several studies suggesting that different symptom clusters improve at different times during treatment: symptoms of poor morale respond most quickly, followed by improvement in symptoms of chronic distress, with symptoms related to the patient's character or personality traits improving at the slowest rate.

In addition to finding that the road to recovery is relatively short for many patients, researchers have discovered that improvement tends to be lasting. There is no evidence to suggest that psychotherapy will permanently safeguard a person from psychological disturbance, but many patients who undergo therapy achieve healthy adjustment for an extended period of time. Many studies, including meta-analytic reviews, have shown that the effects of psychotherapy are relatively lasting. However, there is some evidence to suggest that maintenance of treatment effects is worse in cases of substance abuse disorders, eating disorders, recurrent depression, and personality disorders. Research has also shown that the maintenance of treatment effects

can be enhanced by efforts directed at this goal in the final sessions of therapy.

II. FACTORS IMPORTANT TO PSYCHOTHERAPY OUTCOME

In addition to the research focused on supporting the effectiveness of psychotherapy, considerable emphasis has been placed on studying factors related to positive patient outcome. Findings from this research fall into three general categories: patient variables, common factors, and specific intervention variables.

A. Patient Variables

Although a number of studies have investigated the impact therapists have on psychotherapy outcome, there is surprisingly little evidence that suggests therapists or their techniques are the central and essential factors affecting patient outcome. On the contrary, it is in fact the patient who is most likely to determine successful outcome. The literature focusing on the study of patient variables is too voluminous to fully summarize here; therefore, only the most important findings are reported.

Each patient entering treatment brings a diverse array of factors when presenting to the clinician. These include, but are not limited to, a variety of psychological disorders, physical complaints, historical backgrounds, stresses, and the quality of their social support networks. Patient variables found to have a relationship with outcome are severity of disturbance, motivation and expectancy, capacity to relate, degree of integration, coherence, perfectionism, and ability to recognize and verbalize focalized problems. Therefore, patients suffering from challenging symptoms as well as relative deficits in numerous patient variable categories are likely to experience negligible improvement during treatment. For example, the borderline, alcoholic patient with suicidal tendencies who is forced into treatment, believing that most marital problems are a result of an insensitive spouse, is likely to benefit less from treatment than the depressed patient who voluntarily begins treatment, is low in perfectionism, and is determined to make personal changes that will lead to marital harmony.

Although patient variables have been conveniently categorized, the impact each has on the outcome of therapy is not equal. In general, the severity of the disturbance is generally the patient variable that is most

related to outcome. Patients with serious mental disorders, such as schizophrenia, schizoaffective disorder, and bipolar disorder, are typically treated primarily with psychotropic medications, suggesting the challenge these disturbances provide for psychotherapy alone. Personality disturbances also appear more resistant to change even in long-term treatments that last years.

B. Common Factors

Because outcome researchers have consistently failed to find sufficient evidence indicating superior effects for particular theoretical systems of psychotherapy, some researchers have concluded that psychotherapy equivalence is a result of factors common to all theories of psychotherapy. Whereas some view these beneficial ingredients as both necessary and sufficient for change, others believe that these ingredients act in coalition with techniques that are unique to particular interventions. It is important to note that regardless of the position held, factors common to all treatments are likely to account for a substantial amount of the improvement that occurs in psychotherapy.

In a review of the empirical research, Michael J. Lambert and Allen E. Bergin grouped many factors common across psychotherapies into three categories: support, learning, and action factors. Support factors that contribute to positive patient outcome include catharsis, warmth, respect, trust, empathy, therapist/client collaboration, reassurance, and decreased sense of isolation. Learning factors include insight, affective experiencing, corrective emotional experience, cognitive learning, advice, feedback, and reconceptualization of problems. Action factors include behavioral regulation, cognitive mastery, encouragement of facing fears, practice, reality testing, and success experiences. The common factors included in these categories seem to operate most actively during the in-session process of therapy. When common factors are present, they result in a client experiencing an increased sense of trust, security, and safety, along with a reduction in tension, threat, and anxiety. These conditions, in turn, promote a client's awareness of problems and his or her ability to take appropriate risks by confronting fears using new and more adaptive coping mechanisms and behaviors. With success in implementing new behaviors, clients become increasingly motivated to resolve problems related to their intrapersonal and interpersonal functioning.

Factors receiving the most attention in the literature are the common factors considered to be the core of the therapeutic relationship (e.g., empathy, respect, and

collaboration). A number of related terms such as acceptance, tolerance, therapeutic alliance, therapeutic relationship, working alliance, and support are also used to describe these ingredients. Several studies designed to explore which therapist variables distinguished most consistently between more effective and less effective therapists have found that a client's perception of empathy is important to outcome because less effective therapists have been found to demonstrate lower levels of empathy. Empathy, rather than technique, has repeatedly been shown to be the best predictor of outcome.

Related to these findings are studies investigating the therapeutic relationship, which have suggested that a positive working alliance between the patient and therapist is a necessary condition for patient improvement. Even behavior therapists, who place little theoretical emphasis on relationship variables, have repeatedly found evidence supporting the importance of the therapist–client relationship. In several studies where patients were asked about the most important factors of their therapy, they tended to endorse the personal qualities of their therapists, using adjectives such as “sensitive,” “honest,” and “gentle.” Additional evidence supporting the necessity for a strong working relationship is the positive association repeatedly found between scores on measures of early treatment alliance and psychotherapy outcome. Although a significant amount of evidence points to common factors as mediators of patient change, the notion of beneficial ingredients unique to specific therapies cannot be ruled out, as occasionally such interventions, independent of common factors, can be shown to contribute to successful outcomes.

C. Specific Intervention Variables

The drive to empirically validate the efficacy of specific interventions is due, in part, to the field of psychotherapy's commitment to theoretically based approaches, as well as the influence of political and economic forces. Collectively, these factors have led to the use of comparative outcome studies, which generally avoid the ethical and methodological problems associated with no-treatment and placebo controls, while enabling researchers to study the effectiveness of particular techniques or theories by comparison. For the most part, comparative studies have yielded equal effects for all types of psychotherapy. Some evidence suggests, however, that specific interventions are related to superior outcome in the treatment of some disorders.

Specific behavioral treatments have been found to be effective in treating patients with anxiety disorders. To date, two treatments—systematic exposure and applied relaxation techniques—have been shown to be efficacious in treating a variety of anxiety disorders. Exposure is a broad term that encompasses both interoceptive and situational exposure interventions. Interoceptive procedures attempt to reliably produce panic-type sensations, with the intent of severing or weakening the patient's associations between certain bodily cues and their respective reactions to panic. The technique of situational exposure, also known as *in vivo* exposure, refers to the patient's repeated intentional encounters with a feared stimulus. Given the focus placed on the catalyst of fear, it is not surprising that clearly identifying the stimulus that induces the patient's reactions is crucial for the success of these procedures.

Evidence suggests that the most effective treatment strategy includes identification of feared stimuli, periods of exposure to the feared stimuli sufficient in length to reduce the patient's level of anxiety, and a focus on thoughts providing self-efficacy or performance accomplishment. A general strategy employing the use of exposure techniques appears to be the most efficacious intervention for agoraphobia. Similar exposure techniques have been shown to be successful for social phobic, panic, and post-traumatic stress disorder patients as well.

The results of a form of relaxation, referred to as applied relaxation, appear to show promise in treating specific anxiety disorders. Applied relaxation entails instructing patients in the skill of progressive muscle relaxation. Patients are generally taught how to progressively relax specific muscle groups. Whereas the evidence supporting the use of applied relaxation techniques alone is mixed in the panic disorder literature, it appears there is support for treating generalized anxiety disorder with relaxation training. Additional evidence suggests that the treatment of specific disorders is most successful when particular interventions are combined with specific theory-based therapies. For instance, panic disorder is treated most effectively when a cognitive-behavioral theory of therapy is used in conjunction with behavioral techniques.

Like anxiety disorders, there is some evidence supporting the use of specific behavioral techniques in the treatment of depression. However, in the case of depression, these procedures are not more effective than cognitive, interpersonal, and psychodynamic-interpersonal therapies. For example, behavioral activa-

tion alone, which refers to a patient scheduling activities that promote mastery as well as pleasurable activities, has been found to be as effective as cognitive therapy. Whereas behavioral activation is a procedure that makes concerted efforts to involve patients in constructive and pleasurable activities, cognitive therapy emphasizes the modification of maladaptive thoughts, beliefs, attitudes, and behaviors of individuals. Although some researchers predicted the superiority of cognitive therapy's ability to successfully treat depressive patients, the results of large, well-controlled studies suggest that interpersonal and psychodynamic-interpersonal therapies are efficacious as well. In contrast to the focus that cognitive therapy places on maladaptive thoughts, beliefs, and behaviors, interpersonal theory perceives depression as the consequence of problems in the interpersonal history of the patient.

As eating disorders are generally characterized by harmful cognitions surrounding weight and physical image, cognitive and behavioral interventions have been the most extensively researched treatments. In particular, cognitive-behavioral therapy has been the focus of much research in the treatment of bulimia nervosa, showing promising results. However, it appears that interpersonal therapy provides generally equivalent results when long-term followup findings are considered.

Reviews of the treatment of substance abuse disorders suggest that various therapy modalities have been found effective in treating patients. Therapies that provide generally equivalent results are cognitive, cognitive-behavioral, and psychodynamically oriented therapies. Whereas patients abusing alcohol have been treated, with similar success, using psychodynamic, cognitive-behavioral, and psychoeducational treatment modalities, opiate-dependent patients have been treated with cognitive and supportive-expressive psychodynamic therapies with generally equivalent results.

Some caution should be applied when interpreting the above findings, however, as the results mentioned are typically based on randomized clinical trials. To date, there is little evidence suggesting that these findings generalize to the clinical setting. The question of whether one technique is comparatively unique and more effective than another is a consistent topic in the literature of psychotherapy. There is currently little evidence supporting the superiority of particular interventions, although future research may note unique contributions. For instance, there is a growing body of

evidence suggesting that the use of therapy manuals allows for the detection of discernible differences in the behavior of therapists, while at the same time enhancing the effects of specific therapy procedures. Perhaps these contributions will allow for more accurate comparisons in outcome studies. The search for specific techniques and common factors that distinguish successful treatment has proved to be difficult because of the myriad factors that likely exist in the interactions between therapists and clients.

III. NEGATIVE EFFECTS OF PSYCHOTHERAPY

Findings from study of the progress and outcome of patients undergoing psychotherapy have resulted in both expected and unexpected conclusions. Most patients receiving treatment improve, a minority of patients remain unchanged, and contrary to the intent of psychotherapy, a small percentage of patients actually worsen as a result of, or at least during, treatment. Independent reviews of the literature suggest that some patients fail to achieve beneficial gains from treatment. Although accurate estimates of patient deterioration are difficult to make because the results of such incidents are not often the focus of psychotherapy outcome studies, estimates of patient deterioration vary between 0% and 15%. Similar to patient improvement, it appears that the phenomenon of deterioration is equally prevalent across theoretical orientations. In addition, treatment failures are reported in all client populations, treatment interventions, and group and family therapies.

Despite what appears to be an equitable distribution of treatment failures, specific factors have been associated with deterioration. Consistent with the influence that patient variables often have in treatment success, patient characteristics appear closely linked to treatment failure. Severity of mental illness alone is predictive of unsuccessful outcome, and severe levels of mental illness in combination with specific interventions designed to breach, challenge, and undermine entrenched coping strategies and defense mechanisms are more likely to result in treatment failure. Consequently, psychotic, borderline, schizophrenic, and bipolar patients are those patients who most frequently experience deterioration during the course of treatment. Similar findings have been reported in the psychoanalytic literature, as patients lacking quality interpersonal relationships, low-anxiety tolerance at the inception of

treatment, and low motivation were more likely to worsen when treated with psychoanalysis and purely supportive therapies, whereas patients treated with supportive-expressive psychotherapy obtained better outcomes. Deterioration is not unique to individual therapy, however. Reviews of group psychotherapy outcome have reported a positive correlation between treatment failure and patient variables such as low participation, poor self-esteem, poor self-concept, and more significant needs for fulfillment. Additional personal characteristics associated with patient deterioration include hostility, interpersonal dysfunction, and negative expectations of treatment.

These findings suggest that it is important to consider the type of intervention most appropriate for a particular client. However, harm is not attributable to the patient and intervention alone. The results of studies investigating therapists' contributions to the phenomenon of deterioration have suggested that specific therapist behaviors can lead to treatment failure. For instance, research investigating the relationship between therapists' emotional adjustment, empathy, directiveness, support, and credibility, and patient outcome found that therapists' empathic abilities were the most predictive of patient outcome. Additional findings have suggested that effective therapists are also likely to provide more direction and support than ineffective therapists. Some researchers have also found that less effective therapists tend to emphasize values such as having a life of comfort and excitement, whereas effective therapists consider intellectual values, such as reflection, as more important.

Some research has also suggested that therapist "negative reactions," including disappointment, hostility, and irritation, are associated with patient deterioration. In addition, there is some indication that client deterioration is more prevalent when clinicians underestimate their client's illness or overestimate their client's progress in treatment. Research exploring the importance of leadership styles in group therapists suggests that confrontational and aggressive group therapists tended to have more treatment failures in their groups. These therapists were observed to be more likely to insist on immediate client disclosure, emotional expression, and change in attitude.

There is a growing body of literature which suggests that if patients who are experiencing deterioration during psychotherapy are identified early in the treatment process, then steps can be taken to assist them in obtaining a more favorable outcome. Primarily, these studies have involved providing regular feedback re-

garding patient progress to therapists so that they can make needed adjustments in their treatment of clients who are having a poor response to therapy. However, in an attempt to further improve the outcomes of patients who are experiencing deterioration, several research groups have begun to extend the practice of providing regular feedback regarding patient progress to others involved in the treatment process, such as clients and clinical supervisors. The impact of providing individuals other than therapists with feedback regarding patient progress remains unclear.

IV. SUMMARY

Years of clinical research have produced compelling evidence for the value of psychotherapy. Contrary to Hans J. Eysenck's controversial publication regarding the efficacy of psychotherapy, outcome studies have confirmed that patients benefit from treatment in a variety of domains. According to the dose-effect literature, benefits derived from therapy transpire in relatively brief periods of time. For many clinical disorders, generally one-half of all patients return to normal functioning in 5 to 20 sessions. An additional 25% of patients experience a similar level of substantial improvement when dosage levels are increased to 30 to 50 sessions. The benefits from treatment appear to be durable, as the results of followup studies suggest that the effects of treatment last at least one to two years subsequent to treatment. Although researchers have produced empirical evidence supporting the effectiveness of psychotherapy, they are just learning to understand why patients tend to improve.

Not all patients experience equal effects from treatment, and this finding has inspired the investigation of factors facilitating both positive and negative change. The results of such studies have indicated that a patient's level of disturbance is most predictive of outcome. However, desire to change, interpersonal skills, and awareness of relevant problems have all been found to be related to outcome. In addition to patient variables predictive of successful outcome, there are characteristics of a therapeutic relationship that facili-

tate a patient's sense of trust, safety, and security. According to patients' reports, therapist empathy and a strong therapeutic alliance are most predictive of treatment outcomes.

Although the use of specific interventions has shown promising results in the case of particular disorders, in general the search for superior treatment strategies has been disappointing, and according to some researchers unnecessary, given the complexity of potential interactions between therapists, clients, and modes of therapy. Regretfully, not all patients improve from treatment; in fact, some actually worsen. Although knowledge of this phenomenon is somewhat limited, there is some evidence that suggests that treatment failure is best predicted by severity of mental disorder. Furthermore, factors inhibiting the development of a strong therapeutic alliance also predict negative outcome. There is evidence to suggest that providing regular feedback regarding patient progress to therapists helps improve the outcome of patients who are experiencing deterioration during psychotherapy.

See Also the Following Articles

Efficacy ■ Objective Assessment ■ Outcome Measures ■ Research in Psychotherapy ■ Termination

Further Reading

- Bergin, A. E., & Garfield, S. L. (Eds.). (1994). *Handbook of psychotherapy and behavior change* (4th ed.). New York: John Wiley & Sons.
- Freeman, A., Simon, K. M., Beutler, L. E., & Arkowitz, H. (Eds.). (1989). *Comprehensive handbook of cognitive therapy*. New York: Plenum Press.
- Kopta, S. M., Lueger, R. J., Saunders, S. M., & Howard, K. I. (1999). Individual psychotherapy outcome and process research: Challenges leading to greater turmoil or a positive transition? *Annual Review of Psychology*, 50, 441-469.
- Roth, A., Fonagy, P., Parry, G., & Target, M. (1996). *What Works for Whom?* New York: Guilford Press.
- Wilson, D. B., & Lipsey, M. W. (1993). The efficacy of psychological, educational, and behavioral treatment: Confirmation from meta-analysis. *American Psychologist*, 48(12), 1181-1209.

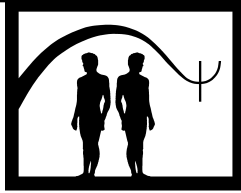

Efficacy

Michael J. Lambert and Melissa K. Goates

Brigham Young University

- I. Efficacy in Psychotherapy Research
- II. NIMH Collaborative Depression Efficacy Study
- III. Summary
Further Reading

GLOSSARY

effect size A common metric in meta-analyses that represents the magnitude of a difference between a treatment and a control group.

generalizability The ability of the results of a study to extend to other situations and patient samples.

meta-analysis A procedure to quantitatively summarize the cumulative findings of a body of literature.

therapist adherence How closely the participating therapist follows the treatment manual and techniques that have been specified.

therapist competence The ability of the therapist to conduct therapy according to the specified theory in a way that maximizes the possibility of client change.

treatment manuals Typically describes in detail the theoretical underpinning of a specific therapeutic approach, the strategies that should be used, and suggestions for dealing with specific issues in treatment.

I. EFFICACY IN PSYCHOTHERAPY RESEARCH

The efficacy of treatment is determined by a clinical trial or trials in which many variables are carefully con-

trolled to demonstrate that the relationship between the treatment and outcome are relatively unambiguous. Efficacy studies emphasize the internal validity of the experimental design through a variety of means including random assignment, blinding procedures for raters, careful selection of patients, manuals to standardize treatment delivery, training and monitoring therapist adherence to the treatment, and managing the “dose” of treatment by conducting analyses that include only patients that have received a specified amount of treatment. These and other strategies are used to enhance the ability of the investigator to make causal inferences based on the findings (e.g., is cognitive-behavioral treatment more effective in treating panic disorder than psychodynamic treatment?).

In contrast, the effectiveness of a treatment is studied in natural clinical settings when the intervention is implemented without the same level of internal validity that is present in clinical trials. Effectiveness studies emphasize the external validity of the experimental design and attempt to demonstrate that the treatment can be beneficial in a typical clinical setting in which fewer experimental variables are controlled. Typically, clients are not preselected to represent a homogeneous sample, treatment dose is not necessarily controlled, and therapist adherence to treatment guidelines is neither highly specified nor monitored. Therapists tend to be those working in clinical settings and may or may not receive the same level of prestudy training as therapists in efficacy studies.

It is only natural that some confusion between efficacy and effectiveness exist. Historically these two terms were often used interchangeably. Meta-analytic methods for estimating treatment effects have typically included both types of studies when calculating the “effect size” that represents the magnitude or size of difference between a treatment and a control group. The use of the term “effect” within the context of inferential statistics and experimental design naturally leads to descriptions of the studies as evidence for the effectiveness of treatment. As a result, even recent literature often does not incorporate the modern distinction between efficacy and effectiveness.

The study of efficacy through clinical trials has many benefits for psychotherapy research. The methodology of clinical trials allows for improved internal validity through minimizing attrition by having patients commit to prespecified treatment length prior to receiving treatment. Thus, efficacy trials are praised for their ability to determine the specific factors that contribute to therapy outcome by controlling for confounding variables. Another way that clinical trials increase internal validity is by controlling the types of patients included in the study. Prospective participants of a clinical trial are usually screened to ensure that participants meet predefined criteria. Screening for inclusion in studies often includes meeting specific criteria for diagnosis and meeting certain cutoff scores on various measures. Participants are often excluded from a study if they meet diagnostic criteria for additional disorders. This is done in an attempt to limit the number of clients with comorbid diagnoses and thus minimize between-participant variance and avoid confounding variables.

Efficacy studies also employ the use of treatment manuals to standardize treatment delivery between therapists. Treatment manuals typically describe in detail the theoretical underpinning of the therapeutic approach, the strategies that should be used, and suggestions for dealing with specific problems that arise during treatment. The use of therapy manuals and more experienced therapists presumably reduces the effects of the therapist’s contribution to outcome, allowing for more clear comparisons of treatment procedures. The use of manuals is presumed to magnify the differences between therapies by reducing the “error” that could be introduced by specific therapists.

The standardization of treatment delivery between therapists is further ensured by training therapists prior to the study, monitoring therapist adherence to the treatment during the study, and supervising therapists who deviate from the treatment protocol. Thus, therapist competence is ensured, enabling researchers

to draw appropriate conclusions regarding treatment differences. Another key element in efficacy studies is managing the “dose” of treatment by ensuring that each patient has undergone the complete treatment and thus a sufficient dose to ensure a positive response. Thus, efficacy studies are able to identify the impact of therapy from a fixed number of sessions across treatment groups.

Limitations of efficacy research are usually associated with its strengths. The main limitations are associated with the degree to which results can be generalized to routine practice. The results of these studies tend to show the maximum benefits that can be derived from treatments. In routine clinical practice, clinicians must help patients even when they have multiple disorders, are extremely disturbed, or are even subclinical. They cannot undergo extensive training, monitoring during practice, or supervision. Patients often receive multiple treatments (e.g., medication, group therapy) simultaneously with the treatment of intent.

II. NIMH COLLABORATIVE DEPRESSION EFFICACY STUDY

An exemplary study of treatment efficacy is the Collaborative Depression Study conducted by the National Institute of Mental Health (NIMH) in 1989. This study was the combined effort of investigators who were equally interested in two psychotherapy modalities as well as the pharmacological treatment of patients with depression. This approach clearly marked a change in research strategies from examining therapy as usually practiced (effectiveness) to studying “ideal” therapy as guided by manuals and competency ratings (efficacy).

In 1989, Irene Elkin and other principle investigators reported on the comparative outcomes of this study, which compared a standard reference treatment (antidepressant imipramine plus clinical management) with two psychotherapies (cognitive-behavioral therapy and interpersonal psychotherapy). These three treatments were contrasted with a drug placebo plus clinical management control group. Although each of these two psychotherapies had been shown to be specifically effective with depression, this study was the first head-to-head comparison of these two psychotherapies. Since the initial publication, a large number of papers have been published regarding various aspects of this study.

Participants in this study were referred from psychiatric outpatient services, self-referrals, and other mental health facilities. An initial 560 patients were interviewed by clinical evaluators using the Schedule for

Affective Disorders and Schizophrenia interview to eliminate participants with comorbid diagnoses. Inclusion criteria included the diagnoses of a current episode of major depressive disorder, and a score of 14 or higher on an amended version of the 17-item Hamilton Rating Scale for Depression. Remaining candidates for the trial were excluded if they had additional psychiatric disorders, two or more schizotypal features, history of schizophrenia, organic brain syndrome, mental retardation, concurrent treatment, presence of specific physical illness or other medical contraindications for the use of imipramine, and presence of a clinical state inconsistent with participating in the research protocol (e.g., high suicidality). The 250 patients who passed the clinical and medical screening gave consent to be entered into the study and were randomly assigned to a treatment condition based on a separate computer-generated random order for each of three sites: Pittsburgh, Oklahoma City, and Washington, D.C.

The 28 therapists (18 psychiatrists and 10 psychologists) were carefully selected, trained, and monitored in the specific treatment they offered. A different group of therapists conducted treatment in each of the treatment and control conditions, with the exception of the two pharmacotherapy conditions (imipramine plus clinical management and pill placebo plus clinical management), which were conducted double blind by the same therapist. Patients were assigned to therapists within treatments according to availability, and each therapist saw between 1 and 11 patients.

The treatments were carefully defined and followed manuals that spelled out theoretical issues, general strategies, major techniques, and methods of managing typical problems. Clinical management was a component of both pharmacological conditions to ensure clinical care and to maximize compliance. Because the clinical management offered patients support, encouragement, and occasionally direct advice, this condition may have approximated a "minimal supportive therapy" condition. However, because specific psychotherapeutic interventions were not used, improvement attributed to the "minimal supportive therapy" is indicative of common factors present in all conditions, and not specific therapeutic interventions.

During the training phase of the study, all therapists received additional training in their respective approaches and met competency criteria in carrying out their assigned treatment. Throughout treatment, therapists were monitored to ensure their adherence to their respective approaches and to determine whether the treatments could be differentiated from one another. The treatment approaches were observed by researchers and were

correctly classified more than 95% of the time, ensuring that differences found between treatments were indeed due to the difference in therapeutic approaches.

Psychotherapy sessions were each 40 to 50 min long, whereas the initial pharmacotherapy session was 45 to 60 min long and clinical management sessions 20 to 30 min long. Treatments were intended to last 16 to 20 weeks, however the total sample averaged 13 sessions. Those who completed therapy averaged 16.2 sessions, while early terminators averaged 6.2 sessions.

Eleven of the 250 patients dropped out of the study before the first treatment session. Of the remaining 239 patients entering treatment, 77 (32%) terminated before completion (had less than 12 sessions of treatment) either because they chose to or because they were withdrawn by the study staff. On investigation of differences between early terminators and those who completed treatment, it was determined that early terminators across all the treatments were significantly more severely depressed at intake than those who completed treatment.

Outcome was assessed on termination of treatment and follow-up intervals on measurements of depressive symptoms, overall symptoms, and general symptoms from both the perspective of a clinical evaluator and the client. Outcome was analyzed for pretreatment–post-treatment differences and predetermined levels of clinical recovery. Post hoc explanatory analyses were carried out comparing patients with different levels of depression severity.

Numerous comparisons were made, and the results of the study are very complex. Confounding variables influencing outcome included initial severity of the patient's condition, research site differences, and the attrition rate of the patients. However, each of the treatment conditions, including the control condition, evidenced significant improvement from pretreatment to posttreatment. The results for cognitive-behavioral therapy (CBT) and interpersonal therapy (IPT) fell in between the imipramine plus clinical management group (IM-CM), which was the most effective, and the placebo plus clinical treatment group (PLA-CM), which was the least effective, although the psychotherapy outcomes were closer to the more effective IM-CM condition.

The initial severity of depression proved to be a significant variable in treatment outcome. For the patients with less severe depression, there was no evidence of the effectiveness of any treatment over PLA-CM group. However, the patients who were more severely depressed and functionally impaired did extremely well with the IM-CM condition and poorly on the PLA-CM condition, with the psychotherapies falling in between.

The results suggested that the psychotherapies needed to be offered for more than 14 sessions with the patients with more disturbances, as many continued to show symptoms of depression at the end of treatment.

Among the more interesting findings were comparisons of the two psychotherapies with the PLA-CM control group. This latter condition was intended to control for the effects of regular contact with an experienced and supportive therapist, the general support of the research setting, and the effects of receiving a “drug” that was thought to be helpful, thus answering the question of whether the psychotherapies had any effects beyond what could be achieved through this rather extensive control condition.

There was limited evidence of the specific effectiveness of IPT and no evidence for the specific effectiveness of CBT. Surprisingly, there was also little evidence for superiority of either therapy in contrast to the placebo plus clinical management. The therapies were effective, but the patients who received the placebo plus clinical management also improved. These results are consistent with the common finding that the relationship that develops between therapist and patient is a potent force in enhancing treatment outcome. This positive alliance was found in the clinical management conditions (drug/placebo) as well as in the psychotherapy conditions.

In head-to-head comparisons of IPT and CBT, no significant differences were found in any of the major analyses or in comparison with patients with more and less severe disturbances. This similarity held up even on measures that were thought to be differentially sensitive to the two therapies. However, in some post hoc comparisons, modest evidence of specific effects could be found. Although all patient groups improved by the end of treatment, superior recovery rates were found for both IPT and IM-CM, when compared to the PLA-CM control group.

III. SUMMARY

Clinical trials provide evidence of the degree of effectiveness of a specific treatment compared to various control groups under rigidly controlled experimental

conditions that allow researchers to make causal inferences about the causes of improvement. Clinical trials involve taking a theoretical rationale for the disorder of interest, a hypothesized chain linking change mechanisms to specific interventions, and operationalization of interventions that promote the likelihood of replication. They also include the identification and careful selection of a target population and use of measures that are appropriate to the disorder and relevant to symptomatic recovery and daily functioning. Therapists are carefully selected, trained, monitored, supervised, and their adherence to treatment manuals and competence are ensured. The data that result are subjected to appropriate statistical analysis including the extent to which differences between treatment and control groups are probable. They attempt to delineate the mechanisms through which psychotherapy operates. Because of the rigorous design demands, clinical trials are limited in their ability to generalize to routine practice, thus they must be followed by effectiveness research paradigms.

See Also the Following Articles

Cost Effectiveness ■ Effectiveness of Psychotherapy ■ Outcome Measures ■ Relapse Prevention ■ Research in Psychotherapy ■ Termination ■ Working Alliance

Further Reading

- Elkin, I., Shea, T., Watkins, J. T., Imber, S. D., Sotsky, S. M., Collins, J. F., Glass, D. R., Pilkonis, P. A., Leber, W. R., Docherty, J. P., Fiester, S. J., & Parloff, M. B. (1989). National Institute of Mental Health Treatment of Depression Collaborative Research Program: General effectiveness of treatments. *Archives of General Psychiatry*, 46, 971–982.
- Kazdin, A. E. (1994). Methodology, design, and evaluation in psychotherapy research. In A. E. Bergin & S. L. Garfield (Eds.), *Handbook of psychotherapy and behavior change* (4th ed., pp. 19–71). New York: John Wiley & Sons.
- Lambert, M. J., & Bergin, A. E. (1994). The effectiveness of psychotherapy. In A. E. Bergin & S. L. Garfield (Eds.), *Handbook of psychotherapy and behavior change* (4th ed., pp. 143–189). New York: John Wiley & Sons.
- Seligman, M. (1995, November). Mental health: Does therapy help? *Consumer Reports*, 734–739.

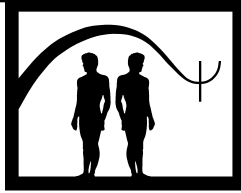

Electrical Aversion

Nathaniel McConaghy

University of New South Wales

- I. Description of Electrical Aversion
 - II. Case Illustration
 - III. Theoretical Bases and Empirical Studies
 - IV. Applications and Exclusions
 - V. Summary
- Further Reading

GLOSSARY

conditioning The term conditioning is used for the establishment of conditioned reflexes. The classical or respondent conditioned reflex first described by Pavlov is produced by regularly following a stimulus (the conditioned stimulus) by an unconditioned stimulus, that is, a stimulus that in a motivated animal or person produces an unconditioned reflex. A conditioned reflex, which is similar to the unconditioned reflex, commences to occur to the conditioned stimulus. The familiar example is the occurrence of salivation to an auditory stimulus that is regularly followed by the presentation of food. An avoidance conditioned response is one that attempts or successfully avoids an unpleasant stimulus, such as an electric shock. The attempt could be withdrawal of a limb when the shock is administered to the limb. The successful avoidance could be pressing a bar or jumping a hurdle in response to a signal that is followed by the shock if the response is not made. This form of conditioning in which a response is followed by a pleasant or unpleasant stimulus is termed operant or instrumental conditioning.

extinction Gradual failure of a previously conditioned response to occur to the conditioned stimulus when the latter has not been followed by the unconditioned stimulus on a number of occasions.

reinforcement The presentation of the unconditioned stimulus following the conditioned stimulus. Partial reinforcement is intermittent in that the unconditioned stimulus is at times omitted. Conditioned responses established by partial reinforcement are more resistant to extinction than those established by consistent reinforcement, that is, they take longer to fail to occur when reinforcement is consistently ceased.

U-scores U-scores of sexual orientation use the Mann-Whitney U-test to provide a statistical assessment of the degree to which individual men show increased penile volume responses to ten 10-second films of nude women versus ten of men. The resulting U-score approaches 100 the more their ten responses to the pictures of women were greater than the ten to the pictures of men, and approaches 0 for the reverse. When the scores are 23 or less or 77 or more the difference is statistically significant. Scores of over 77 were obtained by 90% of men identifying as heterosexual.

I. DESCRIPTION OF ELECTRICAL AVERSION

Electrical aversion is the administration of electrical shocks following exposure to cues that stimulate inappropriate urges or behaviors (respondent conditioning) or following the carrying out of the behaviors (operant conditioning). Its aim is to weaken or eliminate those urges or the motivation to carry out the behaviors, so that they are carried out less frequently or ceased. The electrical shock is usually administered to the treated subject's limbs either by attached electrodes at an intensity determined by the

subject to be painful but not unbearable and not emotionally distressing, or by devices such as a cattle prod or a remote control device at a level that is unbearably painful and emotionally distressing.

II. CASE ILLUSTRATION

At her initial consultation Ms. J. D., aged 27, reported the presence of jealous obsessions since her first emotional relationship with a man when she was 18. The thought that her boyfriend could be sexually attracted or in love with another woman preoccupied her almost continuously and was extremely distressing. It would cause her to repeatedly accuse the boyfriend of being in love with other women but only staying with her because he felt obliged to. His assurance that he was not would only briefly relieve her of the thought that as she said “the terrible things in my mind are true.” If between relationships she formed a friendship with a woman she considered attractive, when she met a new boyfriend she would cut off the relationship with the woman, for fear the boyfriend would find her attractive. Also she would put pressure on her boyfriend to limit any kind of social interactions with women she saw as attractive. This behavior had frequently caused boyfriends to whom she was strongly attracted to terminate the relationship. Ms. J. D. added that “otherwise they would never have let me go.” She said that from the time she was 18 to 22 the thought was present “24 hours a day; it was all I could think about” and frequently it would cause her to become “hysterical,” that is emotionally out of control. She said because of the continuous preoccupation she stayed in secretarial employment below her ability so that she could continue to work. When she was criticized for her behavior she said she would try and control it, although the thoughts would remain distressing. Finally she felt she would stop work and any social activities as otherwise she would attempt suicide. She said when she told her mother this, her mother said she would be sent to a mental asylum, and this caused her to continue her normal life.

Prior to the initial consultation Ms. J. D. had had psychiatric treatment for several years that included administration of the antipsychotic agent thioridazine and the antidepressant agent amitriptyline, and encouragement to accept that her thoughts were not true. However, she felt that in contrast to the behaviorally oriented psychiatrist she saw in the previous year, her initial psychiatrist would advise her but not encourage her to depend on herself. The second psychiatrist attempted to rid her of the obsessive thoughts by a satiation procedure, instruct-

ing her to write them down repeatedly. Nevertheless, although she felt very guilty about the behavior with her current partner, she could not control it. She added that a few months previously she found she had a lump in her breast and hoped it was malignant as death would relieve her of her distress concerning her obsessive thoughts. She constantly experienced headaches that she attributed to her distressing thoughts and was unable to enjoy any activities due to the constant preoccupation. When people talked to her she would answer vaguely as her mind was continuously on the thoughts.

It was not possible to clarify whether Ms. J. D. believed her boyfriend was in love with another woman or feared he was, that is phenomenologically whether the thought was a delusion or an obsession. It is commonly considered that patients with obsessive-compulsive disorder do not believe their obsessive thoughts are true, and that patients who do are suffering from a delusional disorder. However, in my experience this is not always the case, and patients who have a particular belief can have an illness that has all the features of obsessive-compulsive neurosis rather than delusional disorder in terms of the age of onset, life history, and response to cognitive behavioral treatment and selective serotonin reuptake inhibitor medication.

I considered that her illness had the features of obsessive-compulsive neurosis and I treated her initially with clomipramine, increasing the dose to 150 mg at night. This medication had been established in controlled trials to be specifically effective for this condition. My decision was also influenced by the fact that her mother had a depressive illness that responded to this medication and her brother had been diagnosed with a schizophrenic illness with obsessive features that responded to a mixture of clomipramine and a phenothiazine. However, Ms. J. D. showed little response to the introduction of clomipramine.

In view of the severity of her condition and the fact it had not responded to medication or satiation therapy, I decided to try electrical aversion in an aversion-relief procedure. Ten phrases expressing her thoughts, such as “Being upset when I see my boyfriend talking to an attractive woman,” “Being upset at the thought of my boyfriend flirting with another woman,” as well as an eleventh statement “Feeling confident of my boyfriend’s love” were each written on separate filing cards. The cards were placed upside down in front of the patient with the card with the eleventh statement after the 10 and on top of about 20 blank cards. Electrodes were attached to Ms. D.J.’s first and third right hand fingers from a device constructed to deliver an electrical shock consisting of 1 millisecond pulses every 10 milliseconds and

of 1 second duration. The voltage of the shock to be administered was decided prior to treatment, as she determined it to be unpleasant but not upsetting. In her case this was 85 volts.

She was then instructed to turn over the first card and read it aloud. Immediately when she completed reading the phrase she received a shock at the level determined. This procedure was repeated with the following cards every 10 seconds until she had read the phrases on all 10 cards. She then read the final card and did not receive a shock. The aim was that the statement on this card would be reinforced by the relief of knowing when reading it that it would not be followed by a shock. The 10 cards were then shuffled and the procedure repeated four more times. Shuffling the cards was done so that she would not realize when she was about to turn over the card with the eleventh statement so that the relief would not be experienced until she saw the phrase. She received this treatment twice a week for 4 weeks. By the fifth session she reported that the thoughts were less frequent and much less distressing, so that she was able to go out with her boyfriend and not be constantly watching him or be concerned if he talked to other women. The treatment was ceased after the tenth session when she felt her improvement was maximal. In the final session I noticed that she laughed when she read the phrase "Being upset at her boyfriend being sexually aroused at the sight of a girl in a see-through nightie." After the session I asked her again if she initially had believed the thought that her boyfriend loved another woman or just feared it. She said "Before this therapy I did believe it, now I believe he loves me. I can almost laugh about the things on the cards. I can look at other women and think my boyfriend loves me. I feel flattered when I look at them."

I continued to see her every few months for the following 2 years, during which time she obtained employment in a much more demanding position as a private secretary to a prominent politician and subsequently married the boyfriend she had been seeing at the time of her initial consultation. She said that issues of jealousy were no longer a problem in their relationship and added that in the past she would seek reassurance from other people. Now she depended on herself and felt much more secure.

III. THEORETICAL BASES AND EMPIRICAL STUDIES

Contingent shock is the administration of highly painful electrical shock to subjects immediately following their carrying out markedly injurious behavior to others or more commonly to themselves, such as eye

gouging or finger biting. Its aim is to produce immediate cessation of the behavior and prevent its future occurrence. This form of contingent shock has been accepted without question to be a form of avoidance conditioning. It had been repeatedly demonstrated to be effective in single-case studies. Duker and Seys in 1996 reported its use by a remote control device in 12 profoundly mentally retarded subjects whose behavior was resulting in life-threatening self-injuries. In a follow-up of 2 to 47 months the behavior was almost completely suppressed in 7 subjects, so that physical restraint was no longer necessary. In a further 3 it was moderately effective, but they still needed daily administration. In 1997 Diden, Duker, and Korzilius carried out a meta-analysis of over 50 predominantly single-subject studies. They found contingent shock to produce an effectiveness score that markedly exceeded that of other procedures used to treat self-injurious behaviors.

The theoretical basis of therapies using lower levels of aversive stimuli proved much more controversial when it was investigated intensively from the 1950s to the 1970s, the period this form of aversive therapies was commonly used. Although there has been no generally accepted resolution, currently little interest is shown in how these therapies produce their effects, reflecting the general decline in empirical research of cognitive-behavioral approaches.

A. Conditioning of Anxiety-Relief

In his monograph *Psychotherapy by Reciprocal Inhibition* published in 1958, which stimulated the widespread introduction of behavioral modification procedures to psychiatry and psychology, Wolpe suggested that "anxiety-relief" responses might be directly conditioned to convenient stimuli and subsequently used to counter anxiety. He based the suggestion on the observation that if a stimulus was repeatedly presented to an eating animal just before withdrawing its food, that stimulus acquired the property of inhibiting feeding even when the animal was in the middle of a meal. Wolpe argued that by analogy it might be expected that a stimulus that consistently coincided with the termination of a noxious stimulus might acquire anxiety-inhibiting effects. He pointed out the possibility was supported by experiments showing that approach responses were conditioned to a stimulus repeatedly presented at the moment of termination of an electric shock, in contrast to the avoidance that is conditioned to a stimulus that preceded an electric shock.

Wolpe investigated the validity of his suggestion by attempting to reduce patients' anxiety. Electrodes

attached to their left forearm and palm were connected to an induction coil fed by a 6-volt battery. Tests were made to determine a level of shock that each patient found very uncomfortable without being unbearable. The patients were then instructed that the shock would be repeated and they were to endure it until their desire to have it stop became very strong, at which point they were to say aloud the word "calm." The shock would then be immediately terminated. After 30 to 60 seconds the procedure was repeated 20 to 30 times at a session. Wolpe emphasized that patients were reassured they would never be shocked without warning, and that such warnings should be given every time a shock was administered, as otherwise some patients became very anxious between shocks. Wolpe reported that most patients reported a feeling of relief at the cessation of the shock, which was sometimes greatly out of proportion to the discomfort that went before. Many found that after one to three sessions using the word "calm" could diminish the intensity of anxiety evoked in the course of day-to-day experience.

B. Avoidance Conditioning

Wolpe also reported studies using electrical aversion to produce avoidance reactions to obsessional stimuli that produced intense and excessive approach responses. He stated that the essence of the method was to administer a very unpleasant electrical shock to the subject in the presence of the obsessional object, citing the successful use of the procedure in the 1930s for the treatment of both alcoholic addiction and fetishism. As used by Wolpe the shock was administered not in the presence of the stimulus, but its mental image, by asking subjects to imagine it. The subjects were instructed to signal when the image was clear, when a severe shock was administered to their forearm. This was repeated 5 to 20 times a session. Wolpe reported a case illustration of its successful use in a woman with what he termed a food obsession. She found foods with a high salt content or that were fattening irresistibly attractive. Following treatment she reported that on imagining any such food she immediately had a feeling of fear and revulsion, accompanied by an image of the shock situation. She no longer experienced the previous misery of hours debating "Should I eat; should I not?"

The reintroduction of electrical aversion by Wolpe led to the procedure being widely adopted in the 1960s using moderate levels of shock to reduce behaviors subjects found unacceptable. These included homosexual, gambling, and paraphilic behaviors and alcohol

and other substance abuse. It also stimulated the use of high levels of contingent shock to inhibit harmful behaviors in developmentally delayed subjects. Its use in the treatment of anxiety was rarely followed up.

C. Bearable Electrical Aversion in Treatment of Homosexuality

Throughout the 1960s the assumption persisted that the milder form of electrical aversion was a conditioning procedure resulting in an aversion to the stimulus or behavior that preceded administration of the electric shock. This assumption was first questioned in 1969 in relation to its use in the modification of homosexual interest or behaviors. As pointed out in a 1977 review by McConaghy, it was this use that was most subjected to empirical investigation, both in relation to its efficacy and mode of action. This was most likely because the response of homosexual men could be assessed not only by their self-report of changes in their feelings and behaviors but also by apparently objective laboratory assessment of changes in their sexual orientation. It was also this use in homosexual men that was strongly and persistently criticized, most recently by King and Bartlett in the *British Journal of Psychiatry* in 1999.

The first influential study in which an aversive procedure was employed to treat a significant number of men who identified as homosexual was reported by Freund in 1960. An emetic agent was administered to the men daily and while its effects lasted, they were shown slides of dressed and undressed men. In a second phase of treatment they were given 10 mg of testosterone propionate and 7 hours later were shown films of nude or seminude women. Freund reported only the men's subsequent heterosexual adaptation. In 10 men (15%) it was short term and in 12 (18%) it lasted at least several years. Freund termed the procedure conditioned reflex therapy. His report was published in the influential monograph *Behaviour Therapy and the Neuroses*. The editor, Eysenck, accepted that the procedure acted by conditioning but pointed out that the principles of conditioning and learning theory must be known and adhered to by practitioners if such procedures were to be effective and not harmful. He stressed the importance of exact timing of the administration of the conditioned stimulus in relation to the unconditional stimulus and that this could not be achieved in regard to the onset of the effect of emetic agents. He considered better results would be obtained with electrical shock, the onset of which could be exactly timed. Subsequently an increasing number of

studies were reported using electrical shock rather than emetic agents in the treatment of homosexuality.

1. Anticipatory Avoidance Conditioning

Following Eysenck in emphasizing their conviction that if conditioning techniques are to be employed in psychiatry, they should represent the systematic application of the methods and findings of experimental psychology, in 1964 Feldman and MacCulloch introduced anticipatory avoidance aversion therapy in the treatment of homosexuality. They concluded from a review of the literature that for the response to be most resistant to extinction a conditioned avoidance technique should be used. The training trials should be well spaced, electrical shock used rather than nausea-producing agents, and reinforcement should be partial (see Glossary). Subjects were shown a slide of a male, which they could remove with a switch provided, but were instructed to view it as long as they found it attractive. If they left it on for 8 seconds they would be given an electrical shock to the calf that was terminated when they removed the slide. The level of shock employed was that which inhibited their feeling of attraction. On two-thirds of occasions they could remove the slide before 8 seconds so avoiding the shock, the reinforcement trials. On one-third of occasions their attempts to remove the slide were unsuccessful, so they received the shock. These nonreinforced trials meant that the avoidance response was only partially reinforced. Randomly on about half the occasions when the subjects removed the slide of the male it was replaced by the slide of a female. MacCulloch and Feldman in 1967 reported the response of 41 male and 2 female subjects, concluding that 25 were significantly improved in that they showed ratings of 0 to 2 on the Kinsey 0 to 6 scale, where 0 is exclusively heterosexual, and 6 exclusively homosexual. Thirteen of the 25 were heterosexually active with no homosexual fantasy or behavior.

2. Aversion-Relief Therapy

In an alternative development in 1964, Thorpe and colleagues argued that as photographs symbolized the behaviors to be treated with aversive therapy, words might be equally effective symbols and their use would avoid the necessity of obtaining suitable photographs. They also noted that in sessions of aversive therapy when subjects recognized by a signal that administration of unpleasant stimuli had finished they experienced great relief. They decided to incorporate this relief into the treatment of homosexuality in men that they had developed, which they termed aversion-relief therapy. With

aversion-relief, as used in the case illustration reported, subjects were shown a series of words or phrases every 10 seconds. All but the last word or phrase related to the behavior being treated, for example, "homosexual" or its synonyms. The last word related to behavior to be encouraged, such as "heterosexual." Each time the subject saw a word he was to read it aloud. He received a painful shock to his feet, except when the last word was shown. Thorpe and colleagues reported subjects quickly learned that they received no shock with the last word and experienced marked relief. The series of words were shown five times in a session, which was carried out daily. The responses of three subjects were reported at 4-weeks follow-up. Two subjects reported negative feelings to homosexuals or homosexual thoughts during or following treatment and the third that he had no homosexual desires in situations where in the past he had experienced them. All three reported more heterosexual interest.

3. Contingent Electrical Shock

In 1969 Bancroft reported the use in 10 homosexual men of electric shock contingent on their showing a distinguishable penile circumference response to photographs of males. Up to four further shocks were given at 15-second intervals unless penile circumference decrease occurred. At the time it had not been recognized that as shown by McConaghy in 1974 a percentage of men in response to stimuli they find sexually arousing initially show penile circumference (but not volume) decreases. In such men their responses of arousal to pictures of males would be indexed as decreases and not followed by shock, while their reduced arousal to pictures of males would be followed by shock. This may have contributed to outcome of the subjects treated, the poorest in the literature. One year or more following treatment two and possibly a third reported reduced homosexual desire and one reported no homosexual desire.

A related contingent treatment was used in the treatment of male child molesters by Quinsey and colleagues in 1980, although evidence had by then been advanced that penile circumference decreases could paradoxically index increased sexual arousal, and vice versa. The subjects were given biofeedback of their penile circumference responses as if the responses correctly indexed their arousal to pictures of adult and child nudes. The subjects received electrical shock to the arm when they showed circumference increase to the pictures of children. The only outcome reported was change in their penile circumference responses to the pictures following treatment, although again by this time the ability of many men to consciously modify

their penile circumference responses had been reported. In their 1995 review of sexual reorientation therapy for pedophiles, Barbaree and colleagues considered this the only well-controlled study that convincingly showed the effectiveness of electrical aversion with child molesters.

4. Comparison Studies of Aversive Procedures in Homosexuality: No Conditioning Evident

The first comparison study of aversive procedures was reported by McConaghy in 1969 with a year follow-up reported in 1970. It and a subsequent series of studies reviewed by McConaghy in 1977 were designed to determine the effects of aversive therapy in male homosexuality and whether they were consistent with it acting by conditioning. In the studies, in addition to subjects' self-reports, their penile volume responses to 10-second duration moving films of male and female nudes were investigated before and after treatment and at follow-up. McConaghy in 1998 reviewed evidence showing that penile volume compared to penile circumference assessment provided a more valid assessment of individual subjects' stated ratio of heterosexual/homosexual interest and, when advantage was taken of its much shorter latency, was much more resistant to modification by the subject.

In the initial study 40 men who requested aversive therapy to reduce or eliminate homosexual interest or behaviors were randomly allocated to two procedures. Twenty received apomorphine aversive therapy to photographs of nude men and 20 received electrical shock aversion-relief therapy using phrases, with the shocks delivered to two fingers of the subjects' hands. The level of shock was that subjects found painful but not unbearable. At 1-year follow-up half the subjects considered their homosexual urges to be reduced and half, mainly the same men, that their heterosexual desire had been increased. A quarter of the subjects had had no homosexual relations since treatment and a quarter reported that the frequency of such relations was reduced. There were slight but nonsignificant trends for more men to report increased heterosexual interest following aversion-relief and more to report reduced or no homosexual relations following apomorphine aversion. Using U-scores (see Glossary) of the men's penile volume responses to the film assessment, prior to treatment 10 of the 40 showed scores of over 50, indicating predominantly heterosexual orientation, with 1 of the 10 having a score of over 77. Following treatment 15 showed scores of over 50, with 2 having scores of over 77.

McConaghy pointed out that the conditioned response to a stimulus reinforced by a painful electrical shock to

the fingers was hand withdrawal, and to a stimulus reinforced with apomorphine is nausea. Following treatment no subjects reported these responses, despite their reporting reduction in homosexual desire. It was suggested that this reduction could not be produced by conditioning in view of the absence of the expected conditioned responses. Workers including MacCulloch and Feldman and Thorpe and colleagues in 1964, and Solyom and Miller and Schmidt and colleagues in 1965 had reported reduction in homosexual feelings following aversive procedures in homosexuality. They did not report the presence of expected conditioned responses, but did not appear to have attached any significance to this.

In the follow-up reported in 1970, McConaghy pointed out that although only seven subjects considered their sexual orientation had changed from predominantly homosexual to predominantly heterosexual, other criteria of evaluating responses were also important. Some men who remained exclusively homosexual and continued homosexual behaviors they found acceptable, reported they were no longer continuously preoccupied with homosexual thoughts and felt more emotionally stable and able to live and work more effectively. A number of these men were able to control compulsions to make homosexual contacts in public lavatories, which had caused them to be arrested one or more times previously. Six of the nine married men at follow-up stated their marital relationship had markedly improved, including two who had ceased having intercourse with their wives some years prior to treatment.

Although there were no statistically significant differences in outcome between aversion-relief and apomorphine aversion, it was considered that the trends toward slight differences required investigation by replication. A further 40 men seeking treatment for homosexuality were randomly allocated, 20 to receive apomorphine therapy as in the first study and 20 to receive the anticipatory avoidance treatment developed by Feldman and MacCulloch. The latter treatment was used as being theoretically the most effective, if it did act by conditioning. At follow-up there were no consistent trends for the outcome of the two procedures to differ, both producing results comparable with those of the first study. Changes in subjects' penile volume responses to the films of men and women following the two procedures were also similar and comparable to those found in the first study. The two studies had therefore demonstrated that three markedly different aversive procedures produced comparable outcomes, yet as conditioning techniques one, apomorphine therapy, could be expected to be poorly effective and one, anticipatory avoidance, maximally effective.

5. Backward Conditioning and Forward Conditioning Equally Effective

A third study further replicating the findings concerning the outcome of electrical aversive therapy in homosexuality and strengthening the argument that the procedure does not act by conditioning was reported by McConaghy and Barr in 1973. Forty-six men seeking to control unacceptable homosexual interest or behaviors were randomly allocated to receive either anticipatory avoidance, classical conditioning, or backward conditioning. Anticipatory avoidance was carried out as in the previous study. With classical conditioning subjects were shown for 10 seconds at 4-minute intervals slides of males they had selected as attractive. For the final second of exposure of the slide and for 1 second following its removal they received a painful electrical shock to two fingers of one hand. The backward conditioning approximated the avoidance procedure in terms of frequency and duration of the presentation of the slides of males and females but with the electrical shocks preceding rather than following the presentation of the slides of males. There were no consistent trends at 1-year follow-up for one therapy to be more effective than another. The proportion of men reporting decreased homosexual interest and increased heterosexual interest was similar to that in the previous two studies. The change in the sexual orientation of the men as determined by penile volume assessment was also similar.

As backward conditioning is accepted to be a relatively ineffective conditioning procedure, the finding that it produced a similar outcome to forms of conditioning accepted to be effective, strongly supported the conclusion that the outcome of electrical shock aversive procedures in homosexuality is not the result of conditioning. In addition, if conditioning played a role in the outcome of aversive procedures it would be expected from conditioning research that the outcome would be greater if more intense shocks were employed. In the 1973 study no relationship was found between outcome and the intensity of voltage selected by the subjects.

6. Positive Conditioning Ineffective: Electrical Aversive Therapy Superior to Placebo

In the early 1970s studies were reported in which a small number of homosexual men were treated by having them view slides of women in association with those of men with the aim of increasing their sexual arousal to women by positive conditioning. McConaghy in 1975 reported a fourth study comparing this treatment with aversive classical conditioning. Thirty-one homosexual men were randomly allocated to one or other of the procedures, half of which were

presented in forward and half in backward conditioning paradigms. Subjects' penile volume responses were recorded throughout all procedures. No penile response conditioning occurred to the slides of women in the positive conditioning procedure although unconditioned penile responses continued to occur to the slides of males throughout treatment. Also there was no difference in the changes in sexual interest or behaviors reported by the men who had received the positive conditioning in a forward as compared with a backward paradigm. It was concluded that the positive conditioning procedure had no specific therapeutic effect but acted as a placebo therapy.

At 3 weeks and 1-year follow-up, more subjects who received the electrical aversive treatment as compared with positive conditioning reported reduction in homosexual interest and behaviors. The differences were statistically significant for reduction in homosexual interest at 3 weeks and reduction in homosexual behavior at 1 year. The outcome following aversive therapy given in forward and backward forms did not differ. At 3 weeks following both the aversive therapy and positive conditioning a similar number of subjects reported increased heterosexual interest and behaviors, but at 1 year there was a trend for more subjects to report this following aversive therapy. It was concluded that the aversive therapy produced specific reduction of homosexual interest and behaviors in contrast to the placebo effects of positive conditioning.

7. Aversive Therapy Does Not Produce Specific Change in Penile Volume Assessed Sexual Orientation

The changes in subjects' penile volume response assessment to the 10-second films of men and women from before to after all treatments in the fourth study were similar to the changes in the heterosexual direction that followed the aversive therapies in the three previous studies by McConaghy and colleagues. If these changes were a specific effect of treatment they should have been greater following the aversive as compared to the positive conditioning placebo procedure, since the reduction in homosexual interest produced by the aversive therapy was significantly greater than that following the placebo. As the penile volume changes were comparable, it was concluded they were nonspecific and unrelated to the treatment effect, but resulted from subjects consciously or unconsciously modifying their penile volume responses to appear more heterosexual. Freund had shown in 1971 that 5 (20%) of 15 homosexual men were able to do so without treatment. In the four studies, of the men assessed

prior to treatment 117 showed predominantly homosexual and 33 predominantly heterosexual orientation. Following treatment 53 showed predominantly heterosexual orientation. This change in 17% was within the range of the men Freund showed could produce in their penile volume responses voluntarily.

It was concluded that the specific reduction in homosexual interest and behaviors produced by electrical aversive therapies was not accompanied by any change in the subjects' sexual orientation as determined by physiological assessment of their sexual arousal to films of males and females. This conclusion was based on the only series of studies in the literature that used a highly valid measure of sexual orientation to measure the influence of aversive therapy on sexual preference. It casts strong doubt on the value of the continued use of aversive procedures to change the sexual preference of rapists and pedophiles. These changes have never been investigated using subjects' penile volume responses, but only their penile circumference responses. As pointed out by McConaghy in his 1998 review, these responses are of much lower validity and more open to voluntary influence.

D. Electrical Aversive Therapies Produce neither Aversion nor Indifference but Control

In the discussion of the previous study in 1975 McConaghy pointed out the rarity with which homosexual subjects reported negative feelings to homosexual stimuli following treatments that associated these stimuli with aversive experiences. Presumably it was the expectation of such aversions that prevented therapists from initially paying attention to their absence. McConaghy suggested that the procedures be termed aversive rather than aversion therapies. Apart from being more accurate it seemed the negative publicity given aversive therapies resulted in part from the incorrect belief that they produced aversions and hence reduced treated subjects' ability to carry out behaviors they considered acceptable. This publicity was reinforced by the widely acclaimed film of Anthony Burgess's 1972 novel *A Clockwork Orange*, which demonstrated the forced use of an extreme aversive procedure to produce a disabling aversion to violence in the protagonist.

When it was generally accepted that aversive procedures did not produce aversion, their outcome was widely accepted to be one of indifference. Wolpe in 1986 argued that this indifference was due to classical conditioning, even though no conditioned response was observed. He did not refer to the findings of the equal

effectiveness of backward and forward conditioning reported above, which would exclude the treatment response being due to conditioning. Also the finding of McConaghy's 1975 study that there was no specific change in the penile volume responses of homosexual men to films of men and women following aversive electrical shock therapy made it clear that the subjects were not indifferent to homosexual stimuli. As early as 1972 McConaghy had referred to subjects treated with aversive therapies being able to cease potentially harmful homosexual acts they had previously experienced as compulsive such as making contacts in public lavatories, while continuing acceptable homosexual behaviors in private. In a 1990 review McConaghy pointed out that superficial questioning could lead to the conclusion from successfully treated subjects' self-reports that they experienced indifference to those stimuli that caused them to carry out behaviors or experience feelings beyond their control prior to treatment. Careful questioning of such subjects elicits the information that, when confronted with such stimuli, they still experience attraction to them. However, the urge to respond behaviorally, or to become preoccupied with fantasies concerning the stimuli is much reduced or absent. He referred to the 1967 finding of MacCulloch and Feldman that six subjects who responded well to aversive therapy for compulsive homosexuality still displayed an occasional and very slight degree of homosexual interest in directly observing males, without, however, any subsequent fantasy.

1. Electrical Aversive Therapy Equivalent to Covert Sensitization

As early as 1965 Gold and Neufeld pointed out that some therapists have ethical and aesthetic objections to the use of physically unpleasant stimuli in aversive therapy. They recommended an alternative procedure later termed covert sensitization. Instead of a physically aversive stimuli being used, a homosexual subject while relaxed was instructed to visualize a psychologically aversive fantasy, such as while engaged in homosexual activity seeing a policeman standing nearby. In later developments the subject was instructed to visualize approaching an attractive male and then seeing he was covered with scabs and gave off a terrible stench, making the subject feel sick and vomit. He turned away and started to feel better. In 1980 Lichstein and Hung reviewed studies employing covert sensitization, pointing out the paucity of controlled studies evaluating the procedure. They considered that only one study controlled for expectancy effects. The control procedure was for subjects to visualize deviant images repeatedly without nauseating images after having been told that

this would be therapeutic, whereas visualizing them with nauseating images as in covert sensitization would increase their deviant behavior. This seemed to be so opposed to common sense it would seem unlikely the subjects would have an expectancy of success with the control procedure. In fact, the authors reported one did not and continued to use the covert sensitization procedure against instructions. Also the study discounted subjects' self-reports of improvement and relied totally on their penile circumference responses as measures of outcome. From the findings of this methodologically faulty study, Lichstein and Hung concluded that the addition of nauseating aversive images increased the therapeutic effect of desensitization to the deviant images.

In a subsequent randomized controlled study reported in 1981, McConaghy and colleagues found covert sensitization to be as effective as electrical aversive therapy. Twenty men seeking treatment for homosexual urges and/or behaviors they experienced as compulsive were randomly allocated, 10 to each procedure. As it had been demonstrated there was no specific change in the penile volume assessment of sexual orientation in homosexual subjects treated with electrical aversion, it could not provide an objective evaluation of treated subjects' outcomes. Reliance could be placed only on their self-reports. These reports therefore were obtained in interview by an assessor who took no other part in the study and was blind to the nature of the treatment the subjects received. Subjects were followed-up for 1 year. The response to both procedures was similar to that to the aversive procedures in the previous studies.

2. Behavioral Completion Model of Electrical Aversive Therapy

Evidence reviewed by McConaghy in 1977 indicated that the outcome of aversive therapy in homosexuality was similar to that of systematic desensitization. It had been observed clinically that many subjects seeking treatment reported they had tried to control homosexual or paraphilic urges in situations where they had expressed such urges previously. However, when attempting this control they experienced increasing tension that they found so aversive as to force them to act upon the urges. It was theorized that a neurophysiological behavior completion mechanism existed that produced heightened arousal, experienced as tension, if subjects did not complete a habitual behavior, when they were exposed to cues to carry out the behavior, such as situations where they had carried out the behavior previously. The association of excitatory and inhibitory stimuli in aversive procedures was considered to reduce or inhibit this arousal. Evidence that conflict-

ing stimuli produced activity in forebrain structures in cats with resultant reduction in anxiety and fear was provided by a 1977 study of Thomas and De Wald.

On the basis of this theory McConaghy developed as a possible replacement for aversive therapies, an alternative behavior completion procedure, initially termed imaginal desensitization. The subjects was first trained to relax and then while relaxed were instructed to visualize being in situations where they had previously carried out the behavior they wished to control. When they signalled they were visualizing this while remaining relaxed they were then instructed to visualize not completing the behavior but carrying out an alternative such as leaving the situation until they signalled they were doing so and were remaining relaxed. Electrical aversive therapy had been reported in uncontrolled studies to be effective in gambling.

E. Alternative Behavior Completion Superior to Aversion-Relief in Compulsive Gambling

Alternative behavior completion was evaluated in relation to an aversive procedure in compulsive gamblers rather than subjects with compulsive sexual urges, because the outcome in most gamblers could be checked with their partners independently of their self-reports. Their self-reports were obtained in interview by an assessor blind to the nature of the treatment. McConaghy, Armstrong, Blaszczyński, and Allcock in 1983 reported the outcome of 20 gamblers randomly allocated, 10 to alternative behavior completion and 10 to aversion-relief. At 1-year follow-up significantly more subjects (7 of 10) receiving the former treatment showed reduction of gambling urges and behavior than did those (1 of 10) who received aversion relief. A 2- to 9-year follow-up of these and additional gamblers was subsequently reported in 1991. Their outcome was also checked with partners when possible, as well as in interview by an assessor blind to the nature of the treatment. Again a significantly better response was found in 33 gamblers randomly allocated to alternative behavior completion compared to 30 allocated to other behavioral procedures including aversion-relief. Twenty-six of the former showed cessation or control of gambling compared with 16 of the latter.

F. Electrical Aversion in the Treatment of Alcoholism

As compared with its use in homosexuality, empirical studies of electrical aversive therapy for alcoholism were

limited in number and methodological adequacy. A probable contributing factor was the report by Garcia and Koelling in 1966 that in animals aversions to tastes were much more easily established to malaise produced by ionizing radiation than to electrical shock, whereas the reverse was true for aversions to visual and auditory stimuli. In his 1977 review pointing out the lack of randomized controlled studies evaluating electrical aversion in treatment of alcoholism, Lovibond recommended that to develop aversive control of excessive drinking, illness and malaise may be a more appropriate stimulus than electric shock. However, Smith, Frawley, and Polissar in 1997 reported a slightly superior abstinence at 6 and 12 months in patients treated for alcoholism with electrical as compared to chemical aversion.

IV. APPLICATIONS AND EXCLUSIONS

In 1978 Marshall cited reports from 1965 that use of aversive stimuli on occasions resulted in an increase in aggression, so that satiation could be more suitable in treating rapists many of whom have a significant aggressive component. I am unaware of therapists since 1965 reporting increased aggression resulting from use of aversive procedures, despite their increased use in the following decade. I have never noted its occurrence in the well over 200 subjects in whom I have used electrical aversive therapies. King and Bartlett in their 1999 criticism of the use of electrical aversive therapies in the treatment of homosexuality stated that the damage they wrought was not considered and that anecdotal evidence suggested it was considerable. The anecdotal evidence was of course post hoc, requiring the illogical assumption that any negative experiences subsequent to an event are a result of that event. No similar criticism appears to have been made of the use of aversive procedures employing levels of electrical shock selected by the subjects to treat other conditions.

In the first two studies by McConaghy and colleagues using electrical aversive procedures, the homosexual subjects showed no evidence of disturbed behavior at follow-up 6 months or 1 year later. In the first study four subjects who felt they had not responded adequately requested further therapy. In the third study one subject lost all sexual feelings following treatment, but at follow-up stated they had returned. In the year following treatment two subjects experienced fairly severe depression, and four others had episodes of milder depression. All six had had many similar episodes prior to

therapy and it was considered only the first subject's response could be attributed to the treatment. In the fourth study four subjects were admitted to psychiatric units for periods of up to 6 weeks in the year following treatment. All had received psychiatric treatment prior to the aversive therapy. Three who had received positive conditioning (i.e., without aversive stimuli) were admitting following drug overdose, for depression, and for a schizophrenic reaction, respectively. The fourth, admitted following a drug overdose, had received aversive therapy. This finding indicated that if aversive procedures produce negative consequences they were less likely to do so than nonaversive placebo procedures.

As opposed to the post hoc evidence of resulting harm, a 1985 study by McConaghy and colleagues comparing alternative behavior completion with covert sensitization aversive therapy provided prospective evidence that the two procedures had positive rather than negative effects on the psychological state of most subjects treated. Their state and trait anxiety as assessed by the Spielberger scale was significantly lower at the year follow-up than prior to treatment. Further prospective evidence concerning aversive therapies was provided in the 2- to 9-year follow-up of compulsive gamblers treated either with alternative behavior completion desensitization or aversive procedures including electrical shock. Subjects' mean state and trait anxiety, neuroticism, psychoticism, and depression scores prior to treatment were in the psychiatrically ill range. At follow-up the scores of those who showed cessation or control of gambling were in the range of the healthy population. The scores of those whose gambling remained uncontrolled were virtually unchanged.

It would seem established that aversive procedures are effective and appear to have no specific negative consequences compared to placebo. However, therapies not using aversive stimuli are clearly preferable if they have been shown to be equally or more effective than aversive procedures. In fact, due to the negative reaction of many therapists to aversive procedures using electrical shock, they appear to have been largely replaced by alternative procedures, although, unlike electrical aversive therapy, few have been demonstrated in methodologically adequate studies to be more effective than placebo therapy. Kilmann and colleagues in their 1982 review of studies of treatment of paraphilias found that covert sensitization was used in about one-tenth of these studies until 1974 and one-half of those published from 1975 to 1980. In 1983 Marshall and colleagues concluded it was the preferred form of aversive therapy in the United States. In his 1996 review of

the management of sex offenders over the previous 20 years, Marshall referred to his development of satiation and masturbatory reconditioning as alternatives to aversive therapy because the latter did not appear always to be effective and typically, and "quite properly," generated bad press. These alternative procedures as well as covert sensitization were offered to all offenders he treated, although he stated the evidence in support of their value was not remarkable. He added that at times olfactory aversion was used also. In 1973 Maletzky described the addition of an aversive odor, for example of decaying tissue, when aversive images were suggested to the subject following the instruction that they visualize carrying out unwanted behaviors. He termed the procedure assisted covert sensitization.

Alternative behavior completion does not appear to be used in North America despite the evidence from randomized control trials that it reduces the strength of compulsive urges to a significantly greater extent than electrical aversive therapy and covert sensitization. The latter finding was reported in 1985 by McConaghy and colleagues in the randomized controlled study of 20 subjects with compulsive sexual urges. In opposition to the methodologically faulty conclusion reported by Lichstein and Hung, addition of nauseating aversive images did not increase the therapeutic effect of desensitization. The need for replication of the study was suggested on the basis that effective therapies not using nauseating images could be less damaging to the self-esteem of subjects treated. This has not been done and use of such imagery remains the preferred option outside Australia. The 1987 review by the Council on Scientific Affairs of the American Medical Association, which retained the term aversion, emphasized the lack of controlled research in its evaluation. It made no reference to the extensive series of randomized studies of McConaghy and colleagues that led to the development and evaluation of alternative behavior completion as superior to covert sensitization. In regard to the use of aversive procedures in unwanted sexual behaviors, the Council decided that the literature contained predominantly uncontrolled multifactorial studies, and concluded that the most positive results were reported with covert sensitization.

In relation to the treatment of obesity, the Council pointed out the findings of early uncontrolled studies reporting that weight loss with covert sensitization were not replicated by later controlled studies. They considered that the successes in the earlier studies were due to placebo and expectancy effects. They further concluded that controlled studies showed either no or a temporary effect from covert sensitization for smok-

ing, and the evidence supporting the efficacy of electrical aversive procedures in alcoholism was weak. Lawson and Boudin in their 1985 review also concluded that the use of electrical aversion in the treatment of alcoholism was associated with a high degree of attrition and was relatively ineffective. They considered that there was a growing consensus that its use for this condition could no longer be justified. In their 1996 review of 339 alcoholism treatment outcome studies reported between 1980 and 1992, Floyd, Monahan, Finney, and Morley found electrical aversion therapy to be used in only one study. However, in their 1997 study, Smith, Frawley, and Polissar found that patients treated with electrical or chemical aversion had a significantly superior outcome to matched inpatients from a treatment registry. Landabaso and colleagues in 1999 concluded from a 2-year follow-up of 30 patients treated for alcoholism that combining electrical aversion with naltrexone was effective when the aversive therapy alone had proved ineffective. The AMA Council considered in view of the inadequacy and contradictory findings of studies, that no conclusions could be drawn concerning the effectiveness of aversive procedures in drug abuse. Occasional case studies of a few subjects, such as that by Garcia Losa in 1999, have reported positive results with electrical aversion.

The Council concluded the best accepted use of aversive techniques is for the reduction of self-injurious behavior in mentally handicapped subjects, citing evidence that they were successful in 25% of those in whom such behavior is severe. They quoted the conclusion of a national task force convened in 1982 that when behavior is dangerous and has not improved with less intrusive procedures, increasingly aversive techniques up to electrical shock for the most severe, are appropriate. Understandably, as pointed out by Van Duser and Phelan in 1993, its use is of significant concern to treated subjects' relatives.

Apart from this use of markedly painful stimuli, it would appear that aversive therapy using moderately painful electrical stimuli remains used only rarely in conditions that have failed to respond to more conventional therapies. It was this form of treatment that historically was extensively researched in homosexual subjects and gamblers to elucidate its mode of action. This research provided the major findings that it did not act by conditioning and that although not producing aversion or indifference, and not changing the sexual preference of the homosexual subjects, it gave both groups of subjects control over urges they previously had experienced as compulsive. The demonstration

that this was possible led to the development of equally or more effective procedures to achieve the same outcome and hence have largely replaced this form of aversive therapy. Unfortunately, the interpretation has persisted as evidenced by the statement of King and Bartlett in 1999 that such aversive therapy was used only to sexually reorient homosexuals rather than to enable them to cease unacceptable while continuing acceptable homosexual behaviors. This has resulted in widespread failure to utilize the procedures developed from its use that would enable homosexual men to maintain safer sexual practices who wish to do so but are unable due to lack of control.

V. SUMMARY

A brief description of electrical aversion is provided followed by an illustration of its use in a woman with severe obsessional jealousy who had failed to respond to medication and other behavioral techniques. Electrical aversion was introduced as "anxiety-relief" to reduce anxiety by cues associated with termination of a painful shock, and as avoidance conditioning to inhibit excessive approach responses to stimuli by following them with painful shocks. Electrical aversion became widely adopted in the 1960s in two forms. One used high levels of contingent shock in developmentally delayed subjects to inhibit their severely harmful behaviors. The other form used levels of shock determined by the subjects to reduce behaviors they found unacceptable, such as compulsive homosexual behaviors, gambling, paraphilic behaviors and use of alcohol and other substances. A series of randomized controlled trials of its use to reduce men's unwanted homosexual feelings or behaviors provided evidence that it achieved this aim in comparison to a placebo procedure. It did so not by producing aversion or indifference but by increasing their control. The studies further showed that the procedure did not act by conditioning, nor did it alter the men's physiologically assessed sexual orientation. It was suggested it acted by inhibiting a neurophysiological behavior completion mechanism that compelled subjects to complete habitual behaviors against their will. This theory led to the development of alternative behavior completion as a therapy not involving aversive stimuli, which was shown in further randomized control trials to be more effective than

electric aversion in reducing compulsive sexual and gambling urges. Alternative behavior completion was also shown to be more effective in reducing such urges than covert sensitization, an aversive procedure developed to avoid use of physical aversive stimuli, replacing them with imagined aversive consequences. In the treatment of sex offenders in the United States it would appear covert sensitization has largely replaced electrical aversive procedures. The expectation persists there that all aversive procedures modify the sexual preference of the subjects treated despite valid evidence to the contrary. High levels of contingent electrical shock are still used in developmentally delayed subjects. The historical importance of the research evaluating electrical shock aversive therapies in the development of the theory concerning compulsive behaviors is pointed out.

See Also the Following Articles

Assisted Covert Sensitization ■ Aversion Relief ■ Avoidance Training ■ Bioethics ■ Extinction ■ Informed Consent ■ Negative Punishment ■ Negative Reinforcement ■ Orgasmic Reconditioning ■ Resistance

Further Reading

- Didden, R., Duker, P. C., & Korzilius, H. (1997). Meta-analytic study on treatment effectiveness for problem behaviors with individuals who have mental retardation. *American Journal of Mental Retardation*, 101, 387-399.
- Floyd, A. S., Monahan, S. C., Finnery, J. W., & Morley, J. A. (1996). Alcoholism treatment outcome studies, 1980-1992: The nature of the research. *Addictive Behaviors* 21, 413-428.
- Freund, K. (1960). Some problems in the treatment of homosexuality. In H. J. Eysenck (Ed.), *Behavior therapy and the neuroses* (pp. 312-326). Oxford: Pergamon.
- McConaghy, N. (1977). Behavioral treatment in homosexuality. In M. Hersen, R. M. Eisler, & P. M. Miller (Eds.), *Progress in behavior modification* (pp. 309-380). New York: Academic Press.
- McConaghy, N. (1993). *Sexual behavior: Problems and management*. New York: Plenum Press.
- McConaghy, N. (1998). Assessment of sexual dysfunction and deviation. In A. S. Bellack & M. Hersen (Eds.), *Behavioral assessment: A practical handbook* (4th ed.) (pp. 315-41), Boston: Allyn & Bacon.
- Wolpe, J. (1958). *Psychotherapy by reciprocal inhibition*. Stanford, CA: Stanford University Press.

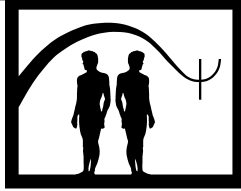

Emotive Imagery

Arnold A. Lazarus

Rutgers University and Center for Multimodal Psychological Services

- I. Description of Treatment
 - II. Theoretical Bases
 - III. Empirical Studies
 - IV. Summary
- Further Reading

GLOSSARY

in vivo desensitization Instead of just imagining feared situations, *in vivo* desensitization gradually and systematically presents the actual feared stimuli or events. For example, a client who fears dogs would be encouraged to approach the animal closer and closer, and eventually be willing to touch it and pet it and thus conquer the fear.

reciprocal inhibition Based on C.S. Sherrington's observation that certain nerve impulses cease firing when others are elicited, J. Wolpe proposed a model of psychotherapy wherein anxiety is diminished or extinguished when paired with more powerful anti-anxiety responses.

systematic desensitization A counterconditioning procedure in which unpleasant (anxiety-provoking) stimuli are presented when clients are pleasantly relaxed. Less threatening events are presented first, and gradually, more frightening circumstances are introduced. Treatment continues until the most anxiety-generating event on the hierarchy no longer elicits anxiety.

I. DESCRIPTION OF TREATMENT

Emotive imagery is the use of positive emotion-arousing mental pictures (imagery) to counterbalance

fear or anxiety. Thus, an exciting, pleasant, enjoyable image is introduced to offset the negative feelings generated by disturbing events. Repeated pairings of this kind may completely neutralize the anxiety.

Children's phobias had been treated mainly by exposure (gradually feared objects or situations would be introduced to the child) or by feeding (the child would be given ice cream or candy while the feared items were brought closer and closer—as in the famous case by Mary Cover Jones in 1924 wherein a child overcame his fears of rabbits and furry objects). The search for clinically effective anxiety-inhibiting responses added deep muscle relaxation to the aggregation, but it proved time-consuming and difficult or impossible to achieve with many children. Feeding has obvious disadvantages in routine therapy. Consequently, Arnold Lazarus and Arnold Abramovitz explored the possibility of inducing anxiety-inhibiting emotive images in place of relaxation and published a report in 1962. Emotive images refer to those classes of “mental pictures” that are assumed to arouse feelings of self-assertion, affection, pride, mirth, and similar anxiety-inhibiting emotions. Although Lazarus and Abramovitz first used the procedure with children, it was subsequently found to be equally applicable to adults.

With children, the technique of emotive imagery covers the following steps: (a) The range, circumstances, and intensity of the child's fears are established, and a graduated hierarchy is drawn up, from the least feared to the most feared situation. (b) The therapist establishes the nature of the child's hero-images

(usually derived from television, movies, and fiction). (c) The child is asked to imagine a sequence of events, within which a story is interwoven concerning his or her favorite hero or alter ego. (d) As a natural part of the narrative, the least anxiety-provoking items are first introduced. The child is instructed to signal by raising a finger if he or she feels afraid or unhappy or uncomfortable. In response to a raised finger, the phobic stimulus is withdrawn from the narrative and the child's anxiety-inhibiting emotions are aroused once again. The procedure is repeated, usually over several sessions, until the highest item on the hierarchy is tolerated without distress.

A case in point concerns a 9-year-old boy who became afraid of going to school. A sadistic teacher had subjected him to unfair criticism, and although this teacher had left the school, the boy nevertheless developed a full-blown school phobia. The lad was tested and scored very high in intelligence: his mental imagery pertaining to the school environment revealed pictures of receiving unfair punishment at the hands of nasty teachers. His negative images persisted despite the fact that his present teachers were kind and understanding.

The boy's favorite heroes were Batman and Robin. Emotive imagery was woven into the following story:

"Please sit back, get comfortable, take in a deep breath, hold it, and now exhale. Just breathe normally in and out. Now I want you to imagine that Batman and Robin have asked you to help them catch a criminal. Can you imagine that?" The child nodded affirmatively, and judging by his overall demeanor and facial expression, he was fully invested in the drama. The narrative was continued. "Robin hands you a special wrist radio so that he and Batman can contact you whenever necessary. Nobody must know the secret, that you are going to help Batman and Robin solve a crime right in your own school. Then Batman tells you that he has put a secret message in your school locker. He says: 'When you get to school tomorrow morning, go to your locker as soon as possible and read the message. Then destroy it!' Of course you don't want to tell Batman and Robin about your fears. You go to school the next morning and head straight for your locker. Picture yourself going to school. As you ride to school in the bus, you are wondering what the message will say. The bus drives into the schoolyard. The bus stops, you get out and walk slowly to your locker. You don't want to rush there because you don't want to make anyone suspicious."

At this juncture, the boy was asked to describe what was happening—how he was feeling and where he was heading. He described the school building, the hallway along which he was walking, the other children, open-

ing his locker. When asked how he was feeling, he made no mention of fear or anxiety. In place of the fear was the curiosity, the fun, the excitement, and the drama—what would the message say? The emotive imagery was continued.

"You open your locker and there you see a slip of green paper. It has the emblem of a bat on it and you know who the sender is. You slip it into your pocket, and some of your friends come up to talk to you. As soon as you manage to do so without being seen, you read the message from Batman and Robin. It says: 'We will signal you on your wrist radio during your first recess. Over and out!' You go to class. The teacher gives you some work to do. You are sitting at your desk. You wonder what Batman and Robin will want you to do next. You continue with your work. The nasty teacher who left the school walks into the classroom. You look at him, but you can't let that bother you. Bigger things are at stake. What will Batman and Robin ask you to do?"

The nasty teacher was then made the focus of attention with the aim of changing the boy's fear to feelings of indifference. The image of the particular teacher who had supposedly engendered the boy's phobic reactions was now being revamped and revised. The fact that he had no need to be afraid of this teacher was explicitly woven into the tapestry of the narrative. Of course, when Batman and Robin finally contacted him on the wrist radio they stressed that the "nasty teacher" was in fact the person they were after. The boy was asked to keep the nasty teacher under surveillance. Robin said: "That man may get to be very nasty, but just ignore him."

At this point, the boy, verbalizing his own pent-up aggressions, insisted on finishing the story himself. He described how he would help Batman and Robin lure the nasty teacher into a trap so that they could capture him and remove him to the nearest jail. At the end of the session, the boy was asked if he would try out his own Batman and Robin fantasy in school the next day. Observe that he was not asked whether he would go to school the next day. The "demand characteristics" of the situation placed the emphasis on how the boy would carry out his own fantasy projection *in school*. This boy was highly motivated, very responsive, and most receptive to emotive imagery. Thus, it took only a single emotive imagery session for him to return to school and to experience no further problems in that regard.

Some people may be concerned that the emotive imagery procedure plays tricks with a child's mind and encourages him or her to daydream and to dwell on fantasy rather than reality. No negative side effects have

ever been observed in a wide range of children treated by this method.

Although emotive imagery was first conceived as a rapid way of overcoming many children's phobias, its use with adults is also worth emphasizing. For example, a 22-year-old man who feared rejection was extremely reluctant to ask a woman out on a date. Yet he complained how lonely he felt and how much he wished to establish a good male–female relationship. Consequently, he was asked to form an image in which he approaches an attractive woman, asks her out, and is flatly turned down. The therapist said, "Try to picture this scene without feeling upset." After trying this out for a few days the client reported: "The only way I can visualize this without becoming upset is by firmly believing that the only reason she said 'no' to me was because she had a jealous boyfriend whom, she feared." He was told to take the risk of actually approaching women and asking them for dates while keeping the image and thought of the jealous boyfriend firmly in mind.

He followed this suggestion and took the emotional risk of approaching a woman he had long admired. "As I looked at her I went into my mind game, my mental act. I convinced myself that due to her jealous boyfriend she would have to turn down anyone who asked her out. Once I had established this in my own mind, I simply asked her if she would like to have dinner with me and perhaps go to a movie. I was ready for her 'no thanks' and almost fell over when she said, 'Thank you, I'd like to.' I did similar things with four other women and only struck out once—and it really didn't bother me because I 'knew' about the 'jealous boyfriend.'" As this young man discovered, people who acquire proficiency in the use of imagery have a remarkable built-in tool.

II. THEORETICAL BASES

As originally presented, emotive imagery was regarded as a reciprocal inhibition technique. Wolpe's formulation of the Reciprocal Inhibition Principle stated that:

If a response antagonistic to anxiety can be made to occur in the presence of anxiety-evoking stimuli so that it is accompanied by a complete or partial suppression of the anxiety responses, the bond between these stimuli and the anxiety responses will be weakened.

Whereas Wolpe regarded reciprocal inhibition as a master key to the cure of neurosis, the limitations of

this single principle were spelled out during the 1960s when a broad-based social and cognitive learning theory came into being. At the same time, many differing schools of thought incorporated a diverse range of imagery procedures into their repertoires. Thus, the contemporary view is that imagery techniques are not simple one-on-one "pictures in the mind" that exert therapeutic properties. Instead, without delving into complex neurophysiological processes that underlie all behaviors, images are tied to various cognitions, affective reactions, and sensory responses that have behavioral and interpersonal properties and consequences. The modern social cognitive perspective draws on direct and observational experiences and places emphasis on symbolization, self-regulation, forethought, and communication.

Those who wish to study in full the theoretical bases of any form of imagery will need to explore such diverse areas as verbal coding, observational learning, structure versus function, pictorial metaphors, and many other complex mental operations. For practical purposes, it is unnecessary to comprehend these nuances, and it is sufficient to conclude that a mental image should not be likened to a photograph in the mind but should be portrayed as a motion picture with many dramatic undertones.

III. EMPIRICAL STUDIES

Although an extremely rich clinical array of imagery techniques has been described, of which emotive imagery is but one of perhaps hundreds, there are no proper empirical studies to support the efficacy of this domain. There are no replicated studies, no measures of validity or reliability, and no operational definitions. Purists may contend that treatment techniques should be held in abeyance until such time as there are data to support them. From a practical perspective, it is necessary and advisable to proceed on the basis of clinical reports. It has been pointed out that many medical procedures were put to good use before scientific studies elucidated their precise mechanisms of action. Clinicians can point to cause-and-effect sequences which suggest that emotive imagery is a robust method that transcends mere suggestion, placebo, and the like.

IV. SUMMARY

Clinically, it has been shown that by conjuring up positive emotion-generating mental images, children's

fears and phobias can often be overcome quite rapidly. Adults may also benefit from the use of this procedure. The theoretical underpinnings are rather diffuse and tenuous, and there are no hard data to substantiate its effects. Nevertheless, from a purely clinical standpoint, the use of emotive imagery is worthy of note.

See Also the Following Articles

Cinema and Psychotherapy ■ Exposure *in Vivo* Therapy ■ Rational Emotive Behavior Therapy ■ Self-Control Desensitization ■ Systematic Desensitization ■ Therapeutic Storytelling with Children and Adolescents

Further Reading

- Bandura, A. (1986). *Social foundations of thought and action: A social cognitive theory*. Englewood Cliffs, NJ: Prentice-Hall.
- Jones, M. C. (1924). Elimination of children's fears. *Journal of Experimental Psychology*, 7, 382–390.
- Lazarus, A. A. (1999). A multimodal framework for clinical hypnosis. In I. Kirsch, A. Capafons, E. Cardena-Buelna, & S. Amigo (Eds.), *Clinical hypnosis and self-regulation: Cognitive-behavioral perspectives* (pp. 181–210). Washington, DC: American Psychological Association.
- Lazarus, A. A., & Abramovitz, A. (1962). The use of "emotive imagery" in the treatment of children's phobias. *Journal of Mental Science*, 108, 191–195.
- Wolpe, J. (1958). *Psychotherapy by Reciprocal Inhibition*. Stanford, CA: Stanford University Press.

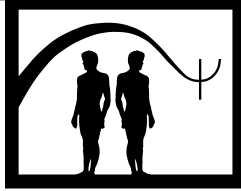

Engagement

Georgiana Shick Tryon

City University of New York Graduate School and University Center

- I. Overview of Engagement
 - II. Conceptual Underpinnings of Engagement
 - III. Empirical Studies
 - IV. Summary
- Further Reading

GLOSSARY

common factors Procedures that occur in all types of therapies regardless of the theoretical orientation of the therapist.

engagement Involvement in therapy assessed by client return for therapy after the initial, or intake, interview.

EQ An acronym signifying engagement quotient that is calculated by dividing the number of clients a therapist sees for more than one session by the total number of clients seen by that therapist.

HCVRCS An acronym for the Hill Counselor Verbal Response Category System that enables grouping of therapist verbalizations into 12 divisions.

session evaluation questionnaire An instrument that allows clients and therapists to judge a session according to its depth, smoothness, arousal, and positivity.

Engagement in therapy is a process whereby client and therapist become involved in the therapeutic endeavor. This article will present engagement as a basic therapeutic task that must occur for any type of treatment to be effective.

I. OVERVIEW OF ENGAGEMENT

Many clients seek help, and after an initial or intake session, they do not return for further therapy. These clients are frequently more troubled than clients who continue in treatment. Client nonreturn after intake is not a minor problem. At some agencies, nonreturn rates run as high as 50% or greater. Sometimes clients report that they received sufficient help in just one session, but this is not the case for most clients. At other times, clients are prevented from returning for treatment by physical or financial barriers. Most nonreturning clients continue to have concerns that go unresolved and prove costly to them and to those with whom they interact. Clearly, these clients, and their therapists, did not become involved, or engaged, in the treatment process. If they had, the clients would most likely have returned for further treatment after intake.

There are many effective treatments for use with a wide variety of problems. But even the most efficacious treatment will not work if the client does not attend scheduled sessions. Regardless of the type of therapy being practiced, for therapy to proceed, and ultimately succeed, engagement must occur in the first session. Thus, engagement is a common factor across therapies.

II. CONCEPTUAL UNDERPINNINGS OF ENGAGEMENT

The concept of initial engagement in therapy originated from some observation that I made in 1985 at a

university counseling center I directed. In an attempt to determine why some therapists in the setting were very busy while others were not, I charted the number of clients seen by each therapist for varying numbers of sessions. Some therapists saw a large number of clients for only one session. Other therapists saw few clients for just one session, but saw many clients for more than 10 sessions. In addition to seeing fewer clients for one session, these therapists also saw fewer clients for intermediate (2 to 9) sessions. Because treatment at the center was short term (10 to 15 sessions in duration), these data showed that some therapists were engaging their clients at intake in an ongoing therapeutic process.

I calculated an engagement quotient (EQ) for each therapist. EQ is the number of clients seen for more than one session divided by the total number of clients seen. It can be considered a fielding percentage for therapists. Therapists get chances (total number of clients seen) to field (engage) clients, and their EQ is the percentage of clients who return to see them after the first session. I found that higher EQ therapists had more positive supervisory ratings. I also found that EQ correlated significantly and positively with number of clients seen for more than 10 sessions, but did not correlate with number of clients seen for intermediate numbers of sessions. This latter finding provided statistical confirmation of my suspicions that therapists with higher EQs were engaging their clients at intake in an ongoing therapeutic process.

My initial conceptualizations about engagement were that certain client and therapist characteristics, such as severity of clients' problems, motivation for therapy, and therapists' experience, would relate to engagement. Because therapy is a verbal process, I also believed that therapists' ability to shed light on problems and formulate a treatment plan in a manner that is understandable to clients would facilitate client engagement in the therapeutic process. To do this, I believed that therapists who were skilled diagnosticians and possessed verbal abilities that enabled them to communicate relatively complex problem and treatment conceptualizations clearly to clients would be better engagers. Empirical studies have investigated these conceptualizations.

III. EMPIRICAL STUDIES

A number of engagement studies have been conducted to determine the factors associated with engagement and how engagement occurs. This section presents a brief review of these studies.

A. Waiting Lists

Many clinics and agencies have postintake waiting lists, because they are unable to continue seeing clients immediately for ongoing treatment. Although in 1980 C. Folkins and colleagues found that length of the waiting list was a factor in client postintake return for treatment, studies by James Archer in 1984 and by T. R. Anderson and colleagues in 1987 found that longer waiting list length was not a deterrent to engagement. Although the results of waiting list research are equivocal, it does not seem advisable for agencies to place impediments, such as long waiting lists, in the way of clients' timely continuation in treatment.

B. Client Factors

Investigators have sought to determine if some types of clients are more likely to become initially engaged in therapy than others. In 1992, Raymond Richmond found that clients who were younger, less educated, and members of minority groups were more difficult to engage. He also found that very disturbed clients who had been diagnosed as psychotic or who were prone to unusual thoughts, mannerisms, and hallucinations were more difficult to engage. Clients with suicidal intent were also less likely to return after their initial session. These difficult to engage clients were also less likely to have been self-referred. In 1998, Mark Hilsenroth and his colleagues found that clients diagnosed with antisocial or borderline personality disorders were also less likely than were other clients to return for therapy following the first session. In another study done in 1995 Hilsenroth and colleagues observed that clients who had uncooperative, hostile relationships outside of therapy were less likely to become engaged. These types of clients seem to be those who most need treatment, yet they are the most difficult to engage. The investigators speculated that the difficulties that these clients have interacting with others interfere with the development of good working relationships with their therapists.

Research by me in 1986 and in 1992 and by Larkin Phillips in 1985 has shown that clients who are perceived by their therapists to be more motivated, psychologically minded, and generally better candidates for therapy are more likely to be engaged than clients viewed as poorer candidates for therapy. I also found that clients who had previously been in therapy were more likely to become engaged than clients who had not. In line with these findings, Alfred Heilbrun in 1972 and Daniele Longo and colleagues in 1992 found that clients who rated themselves as more ready

for counseling were more likely to become engaged. In 1995, Kevin Smith and colleagues found that clients who had already started to address their problems on their own were more likely to become engaged in therapy than were clients who had not. Similar findings have led some authors, such as Alfred Heilbrun in 1972 and Charles Lawe and colleagues in 1983, to try to increase client motivation and readiness for therapy with some type of pretraining using written, audio, or video descriptions of what to expect in therapy. Although client pretraining has generally been successful in increasing engagement, studies have not specified precisely what this pretraining entailed; therefore others would not be able to replicate their procedures.

To summarize, it appears that clients who are harder to engage initially in therapy are those who were referred to therapy by others, are not ready to participate in the therapy process, have personal characteristics that interfere with successful interpersonal relationships, and are frequently more disturbed than clients who are easier to engage. Therapists cannot change these clients' behaviors unless they attend therapy sessions. Thus, the burden of engagement of these clients falls to therapists.

C. Therapist Factors

Because some therapists are able to engage a higher percentage of clients than others (i.e., have higher EQs than other therapists), several researchers have sought to determine what characteristics these therapists possess that are associated with engagement. Several authors have examined therapist gender as it relates to engagement with equivocal results. For instance, in 1979, Nancy Betz and Sandra Shullman found that women therapists engaged better than did men. In 1983, Douglas Epperson and colleagues found that men therapists were better engagers, and in 1984, I found that therapist gender did not relate to engagement. Whereas I found that more experienced therapists were more likely to have higher EQs, several studies including the ones by Betz and Shullman, Epperson and colleagues, and Longo and colleagues have found that inexperienced therapists engage their clients at the same rates as experienced ones.

Several studies have investigated whether or not higher engaging therapists are those perceived by clients as having higher levels of the interpersonal influence characteristics such as attractiveness, trustworthiness, and expertness. This has not proved to be the case. Studies by Glen Martin and colleagues in 1988, Kathy Zamosny and colleagues in 1981, and me in 1989

found no relationships between these therapist characteristics and client engagement. In 1986, I also found that therapist characteristics such as empathy, warmth, and genuineness, which in 1957 were posited by Carl Rogers to influence client change, do not relate directly to client engagement. However, I also found that therapists with higher EQs were rated by all clients, not just those they engaged, as more understanding than therapists with lower EQs.

In line with conceptualizations that therapists' verbal and diagnostic skills might influence engagement, in 1986 Warren Tryon and I investigated these skills using psychotherapy practicum trainee therapists' scores from the Graduate Record Examination (GRE) and Millers Analogies Test (MAT) as well as their grades in a clinical diagnostic course sequence. Verbal scores on the GRE, verbal-quantitative GRE discrepancy scores, MAT scores, grade in clinical diagnosis, and grade in advanced clinical diagnosis all correlated significantly and positively with therapist EQ. Therapist age also correlated highly and positively with EQ. We concluded that higher-EQ therapists' greater diagnostic skills combined with their greater verbal facility enabled them to identify client problems and clarify client problems. (We also believed that older therapists might use their own life experiences to understand clients' problems.) Superior verbal ability would also enable therapists to conceptualize and communicate treatment plans. As indicated above, a relationship between empathy and engagement has not been found. It may be that therapists' use of verbal skills to identify and define problems is an indication of therapist empathy. There have been, however, no studies of this possible relationship.

To summarize, few therapist characteristics have been consistently associated with engagement of clients in therapy. Engagement may depend less on who therapists are than on what they do. In this regard, the finding that therapists who are more verbally proficient and who have better diagnostic skills are better engagers suggests that they are using their verbal facility to involve clients in therapy.

D. Characteristics of the Engagement Interview

The best way to determine what therapists are doing in an engagement interview is to investigate the initial interview itself. Most studies have queried client and therapist about the interview immediately after it is finished. Thomas Greenfield in 1983 and Anna Kokotovic and Terence Tracey in 1987 found that clients who were more satisfied with the initial interview were more likely

to return for further therapy. In 1990, I asked clients and therapists to rate their experience of the intake interview using William Styles' Session Evaluation Questionnaire (SEQ), which was developed in 1980. Both clients and therapists rated engagement interviews as significantly deeper than nonengagement interviews. Thus, both participants in engaged therapy dyads felt the intake was deeper, more full, more powerful, more valuable, and more special (the SEQ depth items) than did nonengaged participants.

These deeper, more satisfying engagement interviews also consume more time than do nonengagement interviews. In four different studies (two in 1989, one in 1990, and one in 1992). I found that engagement interviews averaged about 55 minutes, but initial interviews after which the client did not return for further treatment averaged only about 43 minutes.

Thus, client and therapist are involved in time-consuming activities during an engagement interview. What are they doing? From my own clinical experience, I know that clients frequently come to intake with vaguely defined problems. During the intake interview, therapists help them to clarify these problems and focus on how to work on them. In 1986, I conceptualized that this clarification process might even seem to clients as if therapists were identifying concerns for them. Clients who gave stronger endorsement to an item stating this were significantly more likely to return for a second appointment after intake than were clients who agreed less with this item.

In 1989, I hypothesized that this problem identification process involved teaching clients about their concerns. I developed a three-item scale for both clients and therapists that asked to what extent the therapist identified client concerns, provided the client with new ways of understanding himself or herself, and taught the client about himself or herself. Items were rated on five-point scales with higher ratings indicating more teaching about concerns. Higher ratings of these items by therapists related significantly and positively to engagement. Clients rated therapists who had higher EQs as teaching them significantly more than lower EQ therapists. Thus, providing clients with new perspectives on their problems is positively related to engagement in the counseling process and may be what is consuming time in an engagement interview. The results of these studies dovetail nicely with the research that showed higher engaging therapists to be more verbally and diagnostically proficient. Teaching requires the ability to communicate well verbally. Diagnostic skills would enable the therapist to know what to teach.

In my 2002 article, I discuss how I recorded a psychodynamically oriented therapist's intake interviews with 11 of her clients. I used Clara Hill's Counselor Verbal Response Category System (HCVRCS), developed in 1993, to organize the therapist's verbalizations into 12 categories. Seven of the 11 clients returned for a second interview (i.e., became engaged). To explore the pattern of therapist verbalizations during the interviews, I examined the use of the most frequently employed verbal responses (i.e., numbers of minimal encouragers, closed questions, and information) for the first third, second third, and final third of engagement and nonengagement interviews.

In engagement interviews, the therapist's number of closed questions and minimal encouragers started high and steadily decreased during the course of the interviews, and the therapist's number of information verbalizations started low and steadily increased during the interviews. These verbal patterns suggested that in engagement interviews the therapist used questions and minimal encouragers to clarify client problems, and once clarified for the therapist, the therapist provided clients with diagnostic information about their problems and how therapist and client could work together to ameliorate them. Review of the transcripts showed this to be the case.

In nonengagement interviews, therapist use of closed questions and minimal encouragers started low, increased from the first to the second third of the interviews, and then fell in the final third. Information verbalizations fell from the first to second third of the interviews and increased again in the final third of the interviews. This suggested that in nonengagement interviews, there was less initial problem clarification, and perhaps as a result of this, less information was given to the clients later in the session. The clients then did not return to the therapist for further therapy.

The pattern of therapist verbalizations associated with client engagement in the study cited above may be one of several possible patterns. In 1979, William Stiles found that use of verbal categories depended on therapists' theoretical orientations. Thus a psychodynamic therapist may use different types of verbalizations to clarify problems and suggest a treatment plan than a cognitive-behavioral therapist, but both may successfully engage clients.

To summarize, an engagement interview is longer, deeper, and more satisfying than an initial interview after which the client does not return. Therapist verbalizations during an engagement interview are consistent with a pattern that suggests that the therapist is teaching the

client about the client's problems and how they will be addressed in therapy.

IV. SUMMARY

Engagement is a common factor in all types of therapy. To have their problems addressed effectively, most clients must stay in therapy for several sessions. To do this, clients must be involved, or engaged, in the therapy process. If they are not engaged, they will leave therapy before it has really begun.

Most clients have sought help from other sources prior to entering therapy. These other people may have been supportive, genuine, and understanding, but they did not provide sufficient help to ameliorate clients' problems. Clients expect more help from a professional psychotherapist than what they have received from family and friends. If therapists do not demonstrate to clients that they will be able to provide this help, clients have no reason to spend their time and money getting therapy. The research presented earlier indicates that engagement occurs when therapists listen to and reformulate clients' problems to make them clearer to clients and thereby set the stage for addressing them in therapy.

Some types of clients are easier to engage. Those who have had therapy before, have fewer interpersonal difficulties, are self-referred, and have already begun addressing their problems are more likely to become involved in the therapy process. The harder task is for therapists to engage more difficult clients who are usually more disturbed.

Some therapists are better engagers than others. These therapists tend to have better verbal and diagnostic skills than less engaging therapists. It appears that they use these skills to clarify client problems and to teach clients about their problems and how to address them. One way to do this is for therapists to question clients a lot at the beginning of the initial session and to gradually provide clients with more information about problems as the session progresses.

Engagement needs much further study. Future research should investigate the effects of client and therapist race and ethnicity on engagement. Client verbalizations relative to engagement need to be studied as do the effects of therapist theoretical orientation on therapist verbalizations associated with engagement. As with most areas of research, the engagement studies raise as many questions as they answer.

See Also the Following Articles

Cost Effectiveness ■ Effectiveness of Psychotherapy
 ■ Relapse Prevention ■ Resistance ■ Single Session Therapy
 ■ Termination ■ Working Alliance

Further Reading

- Tryon, G. S. (1985). The engagement quotient: One index of a basic counseling task. *Journal of College Student Personnel*, 26, 351–354.
- Tryon, G. S. (2002). Engagement in counseling. In G. S. Tryon (Ed.), *Counseling based on process research: Applying what we know*. Boston: Allyn & Bacon.



Existential Psychotherapy

Paul B. Lieberman Leston L. Havens

Brown University

Harvard University

- I. Theoretical Bases
- II. Description of the Treatment
- III. Applications and Exclusions
- IV. Empirical Studies
- V. Case Illustrations
- VI. Summary
- Further Reading

GLOSSARY

affectedness One of the three basic aspects of dasein's way of relating to the world. It involves "being found in a situation where things already matter." This is the affective coloration or tone in which we find ourselves, when we encounter a situation. It can be collective (as in the sensibility of an age or the culture of an institution) or individual (when it is referred to as a mood).

dasein ("being-there") Heidegger's term for human being: the way of being characteristic of all peoples or a single human being. Dasein, being-there, or being-in-the-world implies an involvement in the world. The world and the human being are co-constituted. The world itself consists of relationships among entities which, in turn, are only defined by their interrelationships.

existence Heidegger's name for dasein's way of being, namely, as the kind of being that embodies an understanding and that manifests in its actions (ways of perceiving, thinking, doing) an implicit interpretation of what it is to be the kind of being it is. This understanding is not fundamentally conceptual or even conscious but is shown in the acts and practices that an individual undertakes. Thus, em-

bodiment an understanding of oneself is to act and be ready to act (comport oneself) in certain characteristic ways. It is a self-understanding and a reaching forward into the world and into the future.

facticity Heidegger's term for the elements found by dasein already present in its world. These are the elements out of which dasein constructs an understanding or interpretation of itself. Although these entities are created by each culture, they are perceived as existing independently of culture.

falling A basic aspect of dasein's way of being in the world. Although dasein is always being-in-the-world, that is, absorbed in and defined by its involvement with the world, falling implies excessive fascination with and self-definition in terms of the world, to the exclusion of an appropriate awareness of one's true nature (the characteristics of being-in-the-world). Thus, in falling, the being of man as embodying a self-interpretation is forgotten.

mitsein ("being-with") A term intended to convey that dasein is always in a shared, public world. The elements of that world with which it is familiar, which it understands and which matter to it, are shared with (and, Heidegger would say, created by) other people. Since these elements are constitutive of dasein, dasein is necessarily always relating to other people through a shared world.

understanding A basic aspect of dasein's way of relating to the world, equivalent to "knowing how" or being capable of doing something in a particular situation. It is understanding of what is possible in a given circumstance (for example, by knowing how a piece of equipment is used), at the level of a skill rather than a conscious set of beliefs.

“Existential psychotherapy” initially referred to the work of a group of therapists who wrote and practiced in the 1940s, 1950s, and 1960s. Trained as psychoanalysts, they believed that many of Freud’s central concepts failed to capture the reality of everyday life and treatment. They objected to what they saw as the mechanistic quality of Freud’s theories and the speculative, nonempirical nature of its key elements. These characteristics of Freudianism were felt to be untrue to actual clinical phenomena and appeared to be barriers to effective treatment. These therapists never denied their debt to Freud, but they also found, in the work of the existentialist philosopher, Martin Heidegger, alternative formulations of the nature of man which seemed to provide what was missing in analysis, namely, an approach and set of concepts for thinking about clinical work which allowed therapists to understand therapeutic processes more immediately and accurately, and to relate to patients as they really were.

Existential psychotherapy is rarely taught systematically, and there are relatively few published English accounts of how it is practiced. At its most “extreme,” existential therapy may seem risky or dangerous, since it appears to require and encourage strong, spontaneous emotional relationships between patient and therapist, and to tolerate, if not foster, regression. In an already complicated and bewildering field of psychotherapies, existentialists introduce a new vocabulary and a new set of concerns (“death anxiety,” “responsibility,” “authenticity,” “existence”) that few practitioners will welcome. Yet many clinical features of existential work have become important parts of psychodynamic, supportive, and, even, cognitive-behavioral therapies. The innovations of the existential therapists overlap considerably with psychoanalytic advances of recent decades. Knowledge of existential ideas and their influence, as well as familiarity with the analysis of man on which they depend, have largely faded from the scene of modern psychiatry and psychotherapy. Yet those ideas bear reexamining. They offer therapeutic approaches that are true to life as it is actually experienced, even though its methods, indications, limitations, and effectiveness have yet to be fully defined.

I. THEORETICAL BASES

A. Heidegger’s Analysis of Human Being

The guiding ideas of existential psychotherapy are found in Heidegger’s *Being and Time*, published in 1927

and translated into English in 1962. The appropriation and application of this work by clinicians, most prominently Eugene Minkowski, Ludwig Binswanger, Erwin Straus, V.E. von Gebattel, Roland Kuhn, and Medard Boss, comprise the founding, classical works of existential therapy. Subsequent workers in the existential tradition have included Viktor Frankl, Martin Buber, Paul Tillich, Edith Weigert, R.D. Laing, Rollo May, Carl Rogers, Irvin Yalom, and Leslie Farber. To understand these clinical works requires some familiarity with Heidegger. A summary of some Heideggerian concepts that have been most important to therapists is therefore necessary.

1. *Being-in-the-World* (“*Dasein*”)

In *Being and Time*, Heidegger’s objective was to describe the essential features of human life. In the philosophic tradition, man as subject or knower was distinguished from an independent, separate, but knowable, reality. Heidegger, by contrast, begins with the observation that there is no subject or knower in our experience and no independent world apart from what is experienced by us. What there is, rather, is a single, unified knower-known. Put differently, in experiencing, feeling, or thinking, we are absorbed by or into what it is we are experiencing, feeling, or thinking about. For example, when we relate to another person in conversation, we are absorbed in our dialogue. We usually do not pay any attention to the specifics of word choice, syntax, gesture, posture, prosody, appearance, and so on which comprise the interaction. We are involved in the dialogue itself and among the entities which the dialogue is about. This being already among the things of the world is captured by Heidegger’s term for human nature, being-in-the-world, or *dasein*.

Usually, our involvement with the world is preconscious and automatic. The mechanics of what we do, whether relating to another person or to things, are out of awareness. When, to take another example, we use “equipment” in the world, we do not think about or rehearse what we do (except perhaps when learning). We *understand* how to use things, and they already matter to us (they have a valence or affective tone; Heidegger called this feature affectedness), even as we are using them, automatically. Heidegger suggests that such knowing-how should not be thought of primarily as internal mental states or events: they are shown or displayed in our acts. We can, at least sometimes, analyze our actions as if we were following explicit rules or beliefs, but, Heidegger emphasizes, this is not what we usually do. In many cases, no conscious reconstruction is even possible. Conscious, thematic, formulated

thoughts, when they do exist, are only possible because of these preexisting, nonverbal skills.

2. *Existence*

People are constituted by and discovered in the actions they pursue in order to achieve short- and long-term goals. They are thus inherently temporal: coming from the past and proceeding into the future. Human nature shows itself through future-directed acts. Actions, including how we use things, how we comport ourselves, and how we relate to other people, embody interpretations of self and world. Actions show what matters to us and what we want, as well as what we believe to be possible (given our appraisals of ourselves and the situations in which we find ourselves). It is not only that we betray ourselves by minor movements or habits, as Freud said, but that, most fundamentally, our natures appear through our comportment (actions). This forward-moving, embodied expression of our self-interpretation Heidegger called existence. In Heideggerian terms, *dasein* exists.

3. *Being-with ("Mitsein")*

When we look more closely at what is inherent in human nature (constitutive of *dasein*), we find that not only are we defined by our actions among the things of the world (our comportment among physical objects), but that we are already, whenever we do or think something, with other people. The entities of the world, what Heidegger called facticity (this book, that chair, the sky, rain), are already shared with others. What I can relate to, others can, too. A chair, for example, was made by someone else and can be sat in by anyone; these features are given along with the physical appearance of the chair itself. What is more, when an individual thinks of the chair as a chair, a piece of wood, or furniture, she is using a family of concepts that have been passed down and learned from other people. Thus, since the world and the individual are co-determined, and since the world is a public, shared world, the individual is constituted or inhabited by other people, even in the contents of his mind.

4. *Authenticity and Falling*

For Freud, it may be said, the essence of neurotic functioning is failure to acknowledge and appropriately express one's feelings, wishes, or impulses, for example, those relating to sexuality or aggression. By contrast, the acknowledgment of one's constitutional or socially created drives or wishes is the key to psychological health. Failure to do this condemns an individual to live in a pale "safety mode" of self-deception.

Heidegger has a similar, and at the same time different, understanding of how life should be lived. For him, the distinction is not between normal and neurotic, but authentic and inauthentic. And just as Freud's normality requires an appropriation of one's previously given, inner reality, so Heidegger's authenticity requires an understanding of what is essential about oneself. But there are two significant differences. First, for Heidegger, because understanding, as a fundamental characteristic of being-in-the-world, is shown in our acts and practices (not in having true inner beliefs), authenticity is shown in styles of behavior or comportment in the world. The second difference is that authenticity is not acknowledgment of sexual or aggressive wishes or drives but an appreciation of *dasein* or being-in-the-world itself, since that is what human nature fundamentally is. In other words, authenticity requires understanding of being-in-the-world: its absorption in things that are factual (entities constituted by our culture, which are nevertheless perceived as necessary and universal). Authenticity is shown by acting with commitment, absorption, and affectedness, despite full awareness of the contingency of the world and our interpretations. Everything, as Wittgenstein says, might have been different. This authenticity resembles love. When an individual loves, it is only a particular individual person who can be the object of her love. Without the loved person the lover feels lost and empty. And yet, she also realizes that no one person could be that special: everyone who loves has her own loved one, and to every lover that loved one is unique. To continue to love, aware of this paradox, is an example of authenticity.

If authenticity is Heidegger's counterpart to psychological health in psychoanalysis, his counterpart to neurosis is falling. It is part of being-in-the-world that individuals are absorbed in their involvement with people and things. But it is always possible for such "thrownness" to lead to inauthentic "falling." In falling, an individual is so absorbed in particular things or relationships that she loses the appropriate appreciation of human nature as being-in-the-world (as Heidegger defines it, in such terms as skillful absorption and facticity). In falling, an individual becomes overly committed to her current situation without acknowledging its contingency, the possibility of alternatives, the impossibility of proof, and the need for commitment and resolute action, despite these features. If authenticity means acting with commitment while also accepting anxiety in the face of human being, falling is trying to avoid anxiety by disregarding what we should appreciate fully, namely, the various aspects of being-in-the-world.

II. DESCRIPTION OF THE TREATMENT

A. From Philosophy to Psychotherapy

In Heidegger, existential psychiatrists found organizing ideas for their clinical work. Their clinical extensions may be grouped under three headings: (1) being-in-the-world and the goals of psychiatric treatment; (2) a model of therapeutic action; and (3) methodological implications of human nature as being-in-the-world. It is apparent that these headings are broad and rather grand. But the philosophical tradition (or Cartesianism) with which the existential approach contrasts has a similar very broad range of clinical implications involving the nature of man and the clinical enterprise (for example, man as a biological object and clinical work as composed of observation, diagnosis, and treatment).

1. *The Goals of Therapy*

The main goal of psychotherapy is to foster human flourishing, and this means, for existential psychotherapy, living authentically. As we have noted, living authentically means absorbed activity in the world, with awareness of its being or nature. The two parts of this definition (absorbed activity and awareness) may be examined separately.

Absorbed, intentional activity involves striving to realize one's goals and to actualize what one values. Thus, a first step in therapy is careful understanding of the "for-the-sake-of-which" an individual acts. This slight change from the traditional emphasis on behavior as arising from instincts, drives, or early patterned experience to behavior as the striving to realize goals and ideals has direct clinical implications. For, from the outset, the clinician asks himself, "What is this patient trying to do? What does she value?" And as the clinician asks himself these questions, the patient becomes more understandable, sympathetic, and human.

Absorbed activity bears a complex relationship to insight. Existentialists emphasize that insight is not the primary goal of therapy. In fact, existential therapists identify excessive self-reflection as an impediment to or avoidance of absorbed involvement, just as the conceptual, conscious mode of contemplating objects derives from and is "inferior" to more basic, skillful absorption.

Absorbed, skillful activity that furthers an individual's goals and realizes her values must, however, involve accurate appraisal of the self and world, if it is to be successful. Such an accurate appraisal requires seeing clearly and moving comfortably within the objects that compose the world. Such accuracy derives, in turn, from focused attention to and involvement with the world—in other words, from being-in-the-world itself. The opposite of such attentiveness and involvement is detached observation, conceptualization, and overgeneralization. Thus, the additional goal of existential therapy is the ability to recognize, appreciate, and use the particular in the service of bringing about one's aims and values.

Accurate appreciation of the nature of being-in-the-world, as such, is the second great goal of existential therapy, the second component of living authentically. Authentic being-in-the-world embodies an appreciation of its own nature, which has several immediate consequences for therapy. First, the goal of therapy is not to eliminate "negative" feelings, such as anxiety or guilt. Anxiety, for example, is an ineliminable part of human nature because, according to Heidegger, any understanding or interpretation we have of human nature is ungrounded and most fundamentally, unjustifiable by reference to an external, eternal, and universal truth. Reasons for whatever we think and do come to an end, and can come to an end fairly quickly, at which point anxiety intervenes.

From another perspective, all our beliefs and what we understand to be our possibilities are taken from a larger set that is given to us by our culture, which constitutes us (factually). Not only are such beliefs and possibilities never subject to ultimate grounding, but they are never, ultimately, mine. Contra Descartes, certainty does not arise from the inside. What is inside has come from outside, and there is no certainty or necessity out there. To limit anxiety, rather than abolish it, we must involve ourselves in absorbed activity, in the living stream, while recognizing that such anxiety is always a lurking possibility.

Guilt is also an ineliminable part of our nature, for similar reasons. Guilt, like anxiety, arises from the fact that we are constituted by the entities that human culture presents to us factually. Because our being comprises these elements, we are indebted to our culture and our forebears, for our entire selves. Of course, despite this dependency, we are still required to act on the basis of the understanding we have.

Our being, then, is not under our own control, in two senses: (1) we do not choose the possibilities or

categories that are presented to us—these are provided by the culture (or world) out of which we are constituted; and (2) as being-in-the-world, we are thrown into absorbed activity but cannot choose which activities (moods, commitments, values) among our possibilities actually absorb us. This unchosen thrownness into absorbed activity is our most basic way of being; yet we nevertheless need to appropriate and acknowledge it as our own.

Existential guilt or indebtedness is connected to guilt as it is experienced everyday. Our ordinary sense of guilt includes the belief or feeling that we have transgressed ethical norms and have neglected our responsibilities to other people, animals, the environment, or God. In guilt, we feel we have been cut loose from the moorings of ethical standards and have behaved irresponsibly. The feeling of guilt reflects the wish to reestablish connection with such ethical norms and standards. But if we understand existential guilt, we realize that we cannot determine ourselves. We are fundamentally determined by our larger culture or world. As Heidegger says, “The self, which as such has to lay the basis for itself, can never get that basis into its power.” Put differently, neurotic guilt is the questing after what is impossible: control in situations where one has no control, achieving perfection one cannot achieve. Wanting the impossible (self-determination) is the basis of guilt.

Living authentically (absorbed, skillful participation and an accurate appreciation of one’s nature as being-in-the-world) bears a close relationship to the correct use of our language. Authentic living implies authentic speaking. Language used correctly is a mode of skillful absorption in the world. But language can also hide or blind us to our real intents and purposes, or the real natures of others. The contrasts here are with speech that is inaccurate, unfelicitous, or distorted by denial, overgeneralization, misplaced emphasis, lack of appropriate nuance, disowning of responsibility, vagueness, and so on. Clinical situations are replete with instances of this—times when a patient speaks in an empty or incomprehensible fashion that leaves the therapist “at a loss for words” and thoughts. In such situations, the patient may not yet be speaking meaningfully at all, not using words as parts of actions that make sense; then the therapist’s goal may be to point out the emptiness of what appears to be meaningful (for example, when guilt presupposes an impossible perfectionism), or give the patient meaningful words to capture his situation. Alternatively, of course, the patient may be speaking meaningfully, but the therapist may fail to recognize it.

In this case, the therapist’s goal is to “get with” (understand) the patient so her truly meaningful act, in speaking, can be completed by the therapist’s comprehension. Existential psychotherapists are particularly inclined to pay careful attention to the specifics of the patient’s language, asking, “What could he mean?” “What is she trying to say or do?” “What do her words imply?” The objective of such close attention is a genuine, active engagement of patient and therapist.

2. A Model of Therapy

The existential approach includes elements that are distinct from those of psychoanalytic or cognitive-behavioral treatments, which emphasize careful, detached observation, diagnosis or formulation by comparison of data to a predetermined set of criteria, and the prescription or administration of treatment. According to Heidegger, such observation and diagnosis do not reveal phenomena; they obscure them. True understanding occurs only through and during active, lived participation. Understanding another person, then, takes place through and during empathic, emotional exchange. The key test of the accuracy or “correctness” of such interplay is its effectiveness in strengthening the connection and emotional resonance between patient and therapist. For the patient, there will be a deepening and amplification of feeling. For the therapist, a similar or complementary reverberation occurs. For both people, success will be experienced as sharing and warmth (in either its positive or negative senses).

The objective of therapy with respect to self-understanding is not to discover or accurately diagnose what is hidden and only known by inference (such as a repressed wish or a hypothesized brain process). Rather, the objective is to enable the patient to see himself more clearly and, therefore, to respond more fully to what is already present in his behavior, but not adequately appreciated. It should be noted that this represents a radical departure from centuries of tradition, often associated with Descartes. In contrast to this tradition, existential therapy emphasizes that what is fundamentally mental is not “subjective” or “in” the head (such as inner images, thoughts, or propositions) but, rather, styles of comportment and patterns of behavior. Fuller appreciation of what is already, immediately present usually includes becoming more aware both of the formative influence of one’s past (facticity) and one’s defining goals, values, and interests (“for-the-sake-of-whichs”). This idea is captured by Wittgenstein in his statement that “If one sees the behavior of a living thing, one sees its soul.” It is also expressed by

Henry James, as noted by Martha Nussbaum: “The effort to really see and really to represent is no idle business in face of the constant force that makes for muddlement.” Our goal is to make ourselves people “on whom nothing is lost.”

Thus, both the methods and the goals of existential therapy are vivid, emotional immersion in the world, particularly the shared world of patient and therapist. How to do this, and how to structure such interactive encounters so they preserve vigorous interchange and still work to the patient’s benefit, need to be discussed.

3. *Methods of Therapy*

So far, our discussion has been highly abstract. But that is precisely the opposite of where existential psychotherapy would like either the patient or therapist to end up. It is in its specific therapeutic methods that existential psychotherapy most clearly shows its adherence to phenomenology, to the aim of disclosing being as it actually is, undistorted by theoretical formulations. The following six characteristics of existential therapy are frequently emphasized: (1) the phenomenological reduction; (2) affective involvement between patient and therapist; (3) exploration of the surface of meaning; (4) the meaningfulness of all behavior; (5) attention to the uses of language; and (6) temporality or life history. All six are derived from the understanding of human nature as being-in-the-world, although some are consistent with other models as well, including psychoanalysis most prominently.

a. Phenomenological Reduction The phenomenological reduction was developed as a philosophical technique by Heidegger’s teacher, Edmund Husserl. It directs philosophers or psychotherapists to focus initially on phenomena—for example, the experiences described by patients—simply as they present themselves to the listener or viewer. The observer is supposed to “bracket,” or put out of consideration, her theoretical knowledge of *what* something is (a hallucination, for example, or a manifestation of schizophrenia). Instead, she is to examine the phenomenon as it presents itself, as it were, without category.

Despite the apparent simplicity of this proposal, at least two fundamental objections should be raised to it. First, according to Heidegger himself, the observer is always already in a world that is constituted by her culture and that includes, not isolated data or category-less entities, but things that are known as particular items (a hammer, a hallucination). In other words,

there is no possibility of approaching phenomena as they are in themselves, free of presuppositions. To do that would contradict the fundamental nature of being-in-the-world; the phenomenological reduction is an empty proposal. The second objection, also based on Heidegger’s analysis of being-in-the-world, is that the attitude of detached, suppositionless observation—what Heidegger called “fascination”—is not the fundamental or basic way of understanding things. Quite the contrary, since the most fundamental and spontaneous way of understanding something is being familiar with it through using it in purposeful activity, detached reflection is artificial and no guarantee of a more authentic relationship to entities.

Yet, beginning with Karl Jaspers, existential psychiatrists made the careful study of phenomenology the foundation of their clinical approach and provided extensive detailed accounts of patients’ subjective experience. Perhaps the resolution of this apparent paradox is that what is to be bracketed is theoretical knowledge, while what is retained and relied on is everyday or ordinary knowledge. Although it is impossible to approach another person with one’s mind emptied of its categories, it may be possible to limit oneself to using only those categories that are widely available in the culture, including to the patient herself.

Phenomenological reduction was not originally used as a therapy; rather, it was a method of investigation that would lead to more accurate generalization and classification. This was how Jaspers, Binswanger, and Minkowski used it in their carefully rendered and detailed case reports. But phenomenological reduction may also have therapeutic effects; there are several ways these might be produced. First, naming an experience often changes it, a point Heidegger emphasized. He said, for example, that “language makes manifest.” Language picks things out and sharpens our focus. One may, for example, think of examples of child abuse or other torture: knowing and naming each part in detail may produce a stronger impact than do more general descriptions. In addition, language brings an experience out of the inner world and into the public world of our common language. Two people may share the same experience through words. Careful reporting and wording of phenomenology is an important tool for placing the therapist where he can share the patient’s experience, minute by minute.

Moreover, phenomenological reduction, though it cannot be totally suppositionless, does remain true to a central Heideggerian theme, namely, the primacy of direct experience and absorption in things themselves,

over abstract, conceptual thought. Heidegger believed, in fact, that it was distance from concrete involvement with life which was the basis of all psychopathology. Thus, a closer approach to or absorption in the details of living can be inherently therapeutic.

b. Affective Involvement Being-in-the-world is active coping with a world of entities that matter to us. Practical, purposeful activity in which entities have emotional valences precedes and is presupposed by all formal, conceptual understanding. If the existential therapist's goal is to form an accurate understanding of what it is like to be his patient, he must develop the same concrete and emotional responses as the patient. Empathy is not a relationship of observing therapist to observed patient. It is sharing the same psychological experience: the therapist must not only understand the patient in terms of diagnostic or other categories, but he must feel what the patient does. This requires affective engagement with the patient.

Although Heidegger included affect among his necessary and constitutive features of being-in-the-world, existential therapists also discovered its importance directly through their work with individual patients. As Eugene Minkowski lived with a delusional depressed man and tried to enter and understand his delusional world, he began to develop intense feelings toward the patient. These were not, however, only the same feelings as the patient's. The patient experienced fear, since he feared his own execution each day. In response to the patient's intractable fear, Minkowski, who was trying to help him, got angry. Other existential therapists have emphasized the importance of genuine respect, fondness, and appreciation which arise in therapists as they work at gaining access to their patients' worlds. Binswanger referred to the curative aspect of love, a position that Edith Weigert also developed. Unlike the dispassionate listener of classical psychoanalytic theory, the existential therapist expects to become emotionally involved with his patient, and he welcomes it.

There are, at least, two ways in which a genuine, emotional relationship may be helpful. First, as in Minkowski's example, people can only influence one another when they matter to one another. In expressing his frustration, Minkowski implicitly challenges the patient's rigidity and challenges him to change. Intense confrontation within an important relationship must lead to change in one or both individuals, or rupture of the relationship.

A second way in which a genuine emotionship may be therapeutic is through love. Through love, the ther-

apist warmly appreciates and values the patient (especially features that she herself undervalues, ignores, or fails to recognize). Thus, the therapist enjoys and applauds the patient's skills, principles, and objectives; the therapist also can see in a positive light aspects of the patient which she insufficiently appreciates (for example, inhibited aggression or "negative," shameful feelings such as anxiety or guilt). The therapist is able to do this because of her genuine liking for the patient, as well as her understanding of the nature of being-in-the-world (which includes thrownness [and, therefore, anxiety], as well as indebtedness [and, therefore, guilt]).

c. Exploring Surface Meanings The existential therapist starts by sharing the patient's experience and then proceeds to explore the surface implications of the meanings of such experiences. In this process, the clinician takes the patient's words, examines them carefully, and tries to form generalizations about them to make manifest their latent (but not hidden!) structure. In this way, she reveals basic characteristics of the patient's thinking.

Minkowski provided the classical example of this procedure. In his close work with a patient with delusional depression, he observed that the patient continued to expect his "final execution" every night, although, of course, this never occurred. Minkowski concluded from this that the patient suffered from "a serious disorder in the general attitude toward the future" and that "The complex idea of time and of life disintegrates, and the patient regresses to a lower level that is potentially in all of us." Minkowski explored *among* the phenomena of the patient's psychosis, searching for the unifying, more general disturbance at the core of the disorder. He did not look for or postulate unconscious processes.

Medard Boss (1963) applied the same procedure in a variety of clinical situations. He took directly observed clinical phenomena at face value and accepted them. The next question for him was not what they revealed about unconscious mental mechanisms or the repressed past. Rather, clinical phenomena were examined as understandable and frequently even admirable behaviors that embodied and displayed aspects of the patient's way of being in the world (which thereby revealed his self-understanding).

Consider Boss's discussion of transference. According to Boss, the existential therapist does not consider "transference" to be a projection or transfer of feelings from one person to another. Nor does treatment involve

working through such a distortion, so that its roots in the past can be clearly separated from the present relationship. Rather, the therapist “admits ‘transference love or hate’ as the genuine interpersonal relationship to the analyst” experienced by the patient. The existential therapist does recognize that the relationship will be “infantile” and that the patient will misperceive the therapist in ways that arose during the patient’s childhood. Yet the therapist still accepts the relationship as genuine and as an important mode of being for the patient. This understanding acceptance, rather than working through of transference distortions, is the mechanism of emotional growth in therapy.

Boss described a similar approach to understanding dreams. He first accepted their surface truth and then looked for more general modes of behavior or self-understanding that they displayed. He recounted a patient’s dream in which lions and tigers escape from their cages in the zoo. The dreamer is frightened and begins to run away. From this dream, Boss extracted a general theme: the patient’s inability to tolerate without fear life’s “vitality,” including danger and aggression. Boss emphasized that the patient’s fearful attitude is shown directly in the dream. To the existential therapist, dreams reveal more vividly aspects of patients’ lives of which they themselves are not usually “adequately and fully aware.” But no unconscious content or mechanisms are invoked. Dreams are an “*uncovering*, an *unveiling*, and never a covering up or a veiling of psychic content.”

d. The Meaningfulness of Behavior Existential analysis of the surface meanings implied by delusions, transference, and dreams is an instance of the more general existentialist principle, shared with psychoanalysis, that all behaviors are meaningful. Meaningful behavior, according to Heidegger, does not require and, in fact, usually lacks, deliberation or even conscious awareness of judgments, motives, or plans. Thus, even acts that appear automatic, reflexive, stereotyped, or driven may be meaningful and reflect a person’s self-understanding. In most ordinary situations, the meaning of behavior can be easily understood: we read the meaning from the behavior in its context. In psychopathology, the task is to decipher and find the general disturbance of existence presented by behavior which is not ordinary.

Boss, for example, observed that the behavior of obsessional patients is constricted: only “‘pure,’ objective and conceptual thinking” is acknowledged and allowed into the patient’s awareness. Intimate contact and emotional involvement are avoided. True involvement (a

truly absorbed and spontaneous being-in-the-world) would expose the obsessional person to “realms of being” which he experiences as filthy, nauseating, dirty, disgusting, or animalistic. Again, the therapist understands such inhibition as arising from childhood experience, but this conceptual understanding is not brought into the therapy and does not form the background for the therapist’s interventions. Rather, the therapist focuses on the patient’s inhibited way of being, the style of comportment that it involves.

Because they assume the meaningfulness of many behaviors that others would not, existential therapists accept and tolerate a range of behavior that is unacceptable to ordinary social convention. Thus, in the case reports of many existentialists, including Minkowski and Boss, we find descriptions of extended periods of time in which the patient was “regressed,” and “childlike.” These therapists accepted such behavior and even participated in it; they believed the behavior reflected a meaningful, though inhibited, mode of being-in-the-world. Such acceptance seemed to have therapeutic effect. One patient told Boss that what was important to her was, “your understanding of my paranoid delusions and hallucinations, your taking them seriously. Your knowledge of their genuine value and meaning enabled me to realize the wholeness of my own self and the oneness of myself and the world.”

e. Uses of Language When a therapist is able to help her patient toward more authentic living, she does so primarily by her use of language. Language can facilitate the active, self-aware, and skillful absorption of being-in-the-world. It may, however, also interfere and distance an individual from the skillful, energetic coping she seeks. In the latter case, language can replace an active life among things and people with a “solipsistic” withdrawal into a world of merely conceptual thinking—a world of thoughts that have no use in one’s life. Similarly, language may strongly encourage or hinder an individual’s empathic attunement and emotional involvement with other people.

The existential therapists’ emphasis on being-in-the-world, including empathic attunement, thus led them to explore how language may be *used* in treatment, which is perhaps unique among psychotherapists. Language is not only a tool for conveying information. It is also a mechanism for expressing one’s feelings or eliciting feeling in another, communicating a value judgment, sharing anxieties or pleasures, demonstrating concern, proving one’s accurate empathic understanding, venting frustration, and accomplishing many other

personal and interpersonal objectives. Sensitivity to and comfortable use of many different ways of speaking are parts of existential therapy, as documented in the writings of Minkowski, Boss, Yalom, Fromm-Reichmann, and others.

Brief, exclamatory remarks (“How awful!” “My God!”) may express an immediate emotional reaction that approaches or complements the patient’s. Impartial and impersonal statements may “translate” patients’ private feelings into feelings that are public, universal, and shareable (“It’s infuriating.” “No one could stand it.”) The use of specific, emotionally charged words (“God,” “peace,” “safety,” the names of important people in a patient’s life) may immediately intensify and deepen a patient’s feeling, as well as her connection to the therapist.

The existentialists did not organize their uses of language or combine them with other treatment elements (such as exploration of surface meanings) into a coherent therapeutic system. Although it seems existential therapists would agree that, as Wittgenstein said, “Uttering a word is like striking a note on the keyboard of the imagination,” only case reports document the therapeutic effects of particular uses of language in existentially oriented work.

f. Life history Human being is temporal: people, in their active, directed being-in-the-world, are always coming from their past experiences and going toward their future goals. Because an individual must adopt her interpretation of herself and her world from the possibilities that are presented factually by her culture (or world), she must always embody an historical dimension that refers, through her behavior, to the past. And because actions are always already understandable as doing something for-the-sake-of-which, she also always manifests her orientation toward the future. In fact, past and future are coordinated: the values and goals that an individual has have been created from elements in the past. To understand someone fully, we therefore usually must know about their past, an insight shared with psychoanalysis but understood somewhat differently by existentialists.

There are many examples of the interplay of appreciating a life history and existential therapeutic practice; some overlap psychoanalytic therapy. First, detailed, comprehensive knowledge of an individual’s past experiences will facilitate the work of empathy—what Martin Buber called “imagining the real.” Second, accurate empathic expressions are more likely to arise from such vivid, vicarious experiences of the patient’s life. Third,

some verbal and nonverbal behaviors may only be understood against the background of the past. Actions may be reenactments, and sometimes only knowledge of the patient’s past will permit the therapist to develop reasonable, intelligible explanations for behaviors that would otherwise seem to be mere symptoms without rational justification. These three examples are familiar to psychoanalytic practitioners.

Perhaps more specific to existential therapy is its emphasis on man’s inherently temporal nature as such. If the goal of therapy is living authentically, and if living authentically comprises an understanding of oneself as being-in-the-world, then it seems that such authentic living must include a clearer and more active appreciation of one’s temporality (one’s being constituted by the past and always projected into the future). Yet despite the importance of temporality as a component of being-in-the-world, existential therapists for the most part have not developed this idea. Keener awareness of the pervasiveness of the past might modify, and perhaps heighten, feelings of anxiety and guilt, which arise inherently from the past and form a structure of being-in-the-world. A therapist’s image of her patient as directed toward future goals and seeking to realize important values may significantly inform her approach to treatment.

III. APPLICATIONS AND EXCLUSIONS

The clinical indications and contraindications for existential approaches have not been systematically established. Historically, existential therapy was developed in work with psychotic patients. Binswanger, Minkowski, and Boss, in their seminal descriptions of existential work, presented patients who suffered from persistent and very troubling delusions and hallucinations. Recent writers in the existentialist tradition have tended to agree that such empathic, “presuppositionless” approaches are particularly suited to engaging and helping patients who are psychotic. If so, it may be because emotional involvement and expression by the therapist can help her to connect with patients who are emotionally withdrawn or who fear and avoid such contact.

Yet there is also evidence that existentialist approaches may have much broader application. Yalom (1980), for example, has described in detail his work with a wide variety of patients who were not psychotic, but who suffered from severe feelings of isolation, loss

of meaning, impairments of the will, or confrontation with death.

The contraindications to these methods have also been based largely on clinical impression, not rigorous study. Patients who may be unable to tolerate strong feelings toward the therapist—for example, individuals who tend to escalate their hopes and expectations for help and care from the therapist, or who become excessively angry when such expectations are disappointed—may find existential approaches countertherapeutic. Such patients may show better outcomes when therapists are less emotionally expressive and involved. However, modifications in technique (for example, “counterprojection” of exaggerated demands or aggressive reactions) may improve the response of such individuals to existential approaches.

IV. EMPIRICAL STUDIES

Empirical outcome studies of existential psychotherapy are lacking. Treatment effectiveness has instead been documented in individual case reports, which are thus not systematically controlled for bias in the selection of reported cases, variations in the treatment provided as “existential” by different practitioners, nonspecific or “placebo” effects, lack of rigorously defined or carefully measured outcomes, and so on. Moreover, the line between specifically existentialist approaches and what might be considered “nonspecific” treatment factors is not easy to draw.

In assessing the evidence in support of existential psychotherapy, it may be helpful to begin with the appreciation that existential treatment elements—including empathy and respect for the patient’s point of view, emotional, expressive relationships between patients and therapists (which will, at times, involve conflict) and attention to degrees of attachment and of separation—are parts of any therapeutic or healing relationship. Of course, other therapies emphasize additional elements as well (for example, transference interpretation in psychoanalysis or skill-building in cognitive-behavioral therapy). But the extensive outcome literatures of these other therapies have documented the importance of such common components within multiple forms of therapy in promoting positive outcomes and, therefore, support indirectly but strongly the importance of existential elements.

Existential therapy seeks to enter and explore the patient’s world from within it, beginning with the phenomenological reduction. The therapist seeks to develop her

understanding of the patient in terms that the patient would agree to and accept—terms that are available not only to the “specialist” with expert training but that are inherent in the very words the patient speaks. This is, in effect, the attempt to share the patient’s perspective, to see it her way, and to share her reactions.

The value of this approach is strongly supported by the extensive literature on the importance of a strong and positive therapeutic alliance. One defining element of the therapeutic alliance, which is associated with improvement in psychotherapy, is agreement on goals and tasks—in other words, a shared perspective on what is “wrong,” what should change, and how. This element has been shown to be crucial across therapeutic modalities and settings: measured at the start of therapy, it is associated with positive outcome. Such agreement between patient and therapist—a true working together and not merely patient “compliance”—must require the therapist to enter the patient’s world, to indicate that she understands what is troubling her and why she seeks help. This working together on shared tasks for common purposes is the essence of both the therapeutic alliance and the phenomenological reduction, as it is applied therapeutically.

In addition, existential psychotherapy emphasizes the therapeutic force of the emotional involvement of patient and therapist. The therapist’s genuine interest in the patient, as well as her respect and valuing of her patient, are key treatment elements. Moreover, the therapist will have and express feelings of liking or affection for the patient, as well as feelings of anger and frustration. These expressions are made in the service of developing an emotional attachment between patient and therapist. The value of this element as well is supported by the literature on the therapeutic alliance. That literature strongly indicates the importance of the patient’s positive regard for the therapist—her perception that the therapist cares and wishes to help—in promoting successful treatment outcome.

These two elements of the existential therapist’s relationship with her patient—sharing common perspectives and the open expression of feeling—have been shown to be important in nontherapeutic relationships as well. For example, the marital and family literature strongly documents the importance of such “healing relationships” marked by respect for individual experience, high levels of connection, tolerance for and ability to resolve conflict, equality, and sharing of responsibility. Such relationships can “treat” the effects of earlier, less facilitating interpersonal interactions on self-esteem and adaptive functioning and can help to prevent the

development of psychopathology. The documented value of such nontherapeutic relationships lends additional empirical support to the existentialist focus on fostering such relationships in the treatment setting.

Recent developments in the neurosciences also support important tenets of existential approaches. For example, much recent work in lower animals and in humans suggests the importance of subcortical and cortical-subcortical brain pathways that subserve the processing of emotional information, automatically and out of conscious awareness. These findings are strongly consistent with the emphasis of existentialist workers that being-in-the-world includes an affective relationship with situations—and other people—which is automatic and which precedes any conscious or cognitive appraisals. The implications of this understanding for psychotherapy have not been systematically worked out. Yet the importance of strong affective exchanges between patient and therapist—both of connection and of conflict—as crucial components of treatment are consistent with the notion that affective interaction, not merely conceptual understanding, is an essential component of treatment. The patient must come to feel situations differently if she is to appraise them and act within them in new, more authentic, and vivid ways.

V. CASE ILLUSTRATIONS

These cases illustrate the central existential task: to apprehend the other's being in the world and by a shared engagement to render such a being in the world both understandable and livable. The basic assumption of this task is the possibility of one person's imagining the real of another, that is, a relatively full acknowledgment of another's experience of individual existence. The aim of existential exactness is this fidelity to the other's existence, which faces within the existential method the problem of reaching what is unconscious to that experience. The therapeutic assumption of such attempts is that a rendering into mutually understandable language reduces the other's isolation and opens the way to productive discourse. Throughout we will have to address whether an existential approach to the conscious, shared, individual elements of experience takes into account not only unconscious factors, but both biology and the larger social context within which experience occurs. Any presentation of one psychotherapeutic approach cannot go forward productively without attention to what may be sidelined or altogether neglected.

The first and most readily usable illustration is engagement with paranoid states. A man of 35 was hospitalized for threatening behavior and persecutory convictions. He refused to take medications or permit access to his family or employer. The initial interviews were centered on making his experience of persecution mutually understandable. The interviewer at first expressed indignation at the behavior the patient reported he had received; further, the interviewer gave examples of similar persecutory behavior he himself had observed. No attempt was made to interpret or "reality test" the patient's statements. Instead, the interviewer wanted to plumb the depth of the patient's experience, and to that end, the interviewer expressed increasing indignation and gave further examples of the injustices of the world. The patient visibly relaxed and in response to the interviewer's growing indignation and examples cautioned the interviewer against becoming paranoid. The two had arrived at some mutuality of concern.

The interviewer, however, did not retreat from his "paranoid" position, remarking that he was older than the patient and had perhaps seen more of the world's injustice. The patient, in turn, did not retreat from his almost anti-paranoid position, speaking of his continuing surprise at injustice and his strong expectations that the world should be a better place. ("Naivete" has often been reported among paranoid cases.) The interviewer expressed admiration for the patient's idealism and also expressed the interviewer's own hopes that such idealism should someday be implemented. They seem to be approaching a position in which they could agree to mildly disagree. Essentially, the interviewer was warning the patient that disappointments in his ideals might throw him into an alienating paranoia. The patient was warning the interviewer that his greater experience might render him disillusioned and cynical.

The patient then began to discuss the events preceding the persecutory experience, even suggesting a behavior of his own that may have contributed to that experience. The paranoid behavior stopped, and the discussions continued and deepened.

Note that the engagement between patient and interviewer quickly encompassed the social context of the patient's immediate experience and later the still earlier experience with family. What had happened was a toning down of each person's position and a new experience for both parties of a common ground in which the whole problem of both paranoid attitudes and their now acceptable disagreements could be explored and discussed out of that common experience.

Much has been left out of this discussion—for example, the usefulness of medication in controlling psychotic phenomena (medication was used in the present case) and, as important, the unconscious sources of both their beliefs: many therapeutic factors operate to bring about positive change. And there are certainly important similarities between, for example, psychoanalytic and existential conceptions of what is helpful. The analytic emphasis on deciphering the meaning inherent in behavior is comparable to the existential appreciation of existence as embodied self-interpretation. But there are also important differences in emphasis. Existential therapy, in particular, emphasizes the affective connections between patient and therapist, and the joining in or sharing of common perceptions and feelings, rather than understanding at a conceptual level, as crucial therapeutic factors.

This emphasis is also illustrated in the second case, a 25-year-old woman who entered treatment because of long and unsuccessful efforts to contain what were difficulties of a different sort. For much of her life she had been regarded as “strange” and came into the therapy when she refused medication and efforts to reach her by other means.

The patient repeatedly writhed. The psychopathological temptation was to see the writhing as diagnostic of catatonia and the patient as a victim of schizophrenia. Instead, an existential approach suggested that writhing might be a form of being-in-the-world, a statement about the patient’s place in the world. (An analytic observer might see the same action as infantile regression, perhaps a conflict between demands on the mother and inhibitions about making those demands). One reason the therapist took an existential approach was his memory of an anecdote about Einstein. Early in the physicist’s career he had found himself writhing when he contemplated Newtonian mechanics. Something discomforted him in that theoretical construction. It has been suggested that it took Einstein almost 20 years to translate those writhings into the differential equations of general relativity. Was the patient, too, experiencing a conflict between what she had been taught to believe and what she herself experienced in the world?

When the patient recited poetry and when she discussed poetry with children, the writhing stopped. The therapist wondered if conventional speech, as opposed to spontaneous remarks or speech close to particular feelings, might prompt the writhing. He therefore tried to avoid conventional speech with the patient and to wait upon spontaneous utterances. The writhing stopped.

It appeared that her yearning for heart-felt contact was of many years’ duration and was only matched by her hesitation to discomfort others by calling attention to artificiality. It also seemed that her desire for honest observations and speech had not always been well received in her family, the parents being divided in their practice and counsel. When the therapist was with the parents, he observed that the father, like the patient, was reluctant to confront the mother’s artificiality.

The existential therapeutic task was therefore to acknowledge and share both the patient’s wish for honesty and her sensitivity to others’ discomfort with honesty, and to do both these tasks in such a way that the therapeutic behavior modeled a comfortable dealing with this familiar conflict. It may be that this last was something that the two parents could not do for one another.

This clinical incident illustrates, and might be seen as, the existential “putting the world between brackets,” that is, approaching the patient without preconceptions, especially pathological preconceptions, whether descriptive or analytic. Yet this fundamental rule of existential work may not be quite right. In fact, the therapist found a useful preconception in the Einstein anecdote. Such a preconception illustrates what may be still more fundamental to the existential task, that is, finding what can be termed thwarted or conflicted modes of being-in-the-world; the last two illustrations are of conflict over idealism and honesty. This points to what are perhaps the central features of existential work—its tendency to depathologize clinical situations and to address patients’ strengths.

The final illustration concerns a woman of 65 who felt her existence had largely ended with the death of her husband. Happily, it had not altogether ended because she sought help in finding what she could not really believe in, an existence of her own. She had been a successful wife and mother to a world-famously successful husband, but she found little in those successes that she felt was her own. Long ago in her adolescence she had heard herself saying “I can write as well as Eudora Welty.” Later this seemed like the memory of a nearly forgotten dream.

It was easy to celebrate what she had done. The children had completed their educations and had careers, marriages, and children of their own. In the case of one son, these goals had been achieved despite appalling difficulties, which called on the patient to guide the young man amidst terrible dangers, to an existence and set of purposes that seemed, of all her children, the most his own. The husband had been revered by these

children and by almost everyone except the patient. She knew how severely anxious he had always been and how much he required her judgment and steadiness to maintain both his face and his fame. She remained overshadowed throughout; only a very few knew what she had done.

She had given herself away, also to a charismatic mother who was the cynosure of all family eyes, to whom the patient had early subordinated herself. Even then she had been the mainstay of the large group of younger children enthralled by the exciting mother. She felt like a shadow in a world for which she was actually central.

It was easy to feel great admiration for what she had always done. It also would have been easy to go on celebrating what she had done and to rest on those laurels. How this challenged all the sexist biases of her male therapist! Why was she not content to have helped such a famous man? By chance, this therapist had seen enough of women's lives to know how extraordinary they often are.

It is the lesson of existential work that the dream of her early life could still be found. The treatment was like a long, quiet argument. The therapist took the part of the faint dream but also shared the almost overwhelming despair, against so many celebrations of the husband and the children's awed memories. The patient found the beginnings of her own rescue in the care of other sick and often dying old people. She began to write about them, all the while reflecting on the dying days of the husband and what felt like her own near demise. The accounts were remarkable, showing forth strong psychological gifts and a capacity for expression that belied the deadly themes. She was making something out of what had felt like almost nothing.

It recalled Proust. At the end of *In Search of Lost Time*, Proust, too, had seen the bankruptcy of his own purposes, his nearly fatal ambition to be part of the itself dying, empty French aristocracy he had worked so hard and long to join. He then made out of the wreckage of those hopes a book which was his own.

It was not enough to do what often rescues an existential despair—to welcome the despair into the therapeutic room, to give the despairing person perhaps the patient's first experience of having desperation welcomed and thereby partly left in that room. It is true the patient had not felt entitled to let her feelings be heard. The job she had was to hear others' despair and support them; she was most unsure that anyone would welcome any other part of her. Yet the need to share de-

spair and honor the other, dependent part of herself sat side by side with a need to have the mother honored, so deeply was she in the mother's thrall, and most of all to have her own independence honored, in the emerging creative sphere.

A turning point seemed to be the obvious pleasure the therapist took in the dawning creativity. For a considerable period the therapist took more pleasure in it than she could. At first she doubted his sincerity—it might all be a therapeutic ploy. Then she wondered how anyone could take her seriously. At this point, she was like a brilliant lawyer giving the jury reason after reason for disbelieving the credibility of a witness. Wisely, the therapist read her early writing efforts with an appreciation for detail that, more than any general support, helped convince her of what she doubted. Deep doubt gave way to a tentative curiosity, and the curiosity to a growing enthusiasm that spread not only to her work but to the person who produced it. Yes, the work was hers, and being hers she might love a little the person who produced it.

The work of apprehending another's being-in-the-world had moved from appreciating what she had done to nurturing what she had not done, what she had long postponed. This meant fidelity to a dream almost forgotten and the capacities that were not so much neglected as pressed into the life of service she had been thrown into. The dream was rendered into mutually understandable language first in therapeutic discourse and then in exacting detail in the writings she made out of that long-deferred dream. The work went not from the manifest to the latent so much as from the latent to the manifest—in the language of analysis from being dreamlike and barely conscious to becoming the largest occupant of her consciousness.

VI. SUMMARY

The central objective of existential therapy is to enable the patient to live authentically: actively absorbed and involved with other people and things, while appreciating and accepting his nature as being-in-the-world. Appreciation of being-in-the-world as the fundamental structure of human being also informs the methods of existential treatment. Existential psychotherapy begins with the therapist seeking to enter the patient's world as it is experienced. This is accomplished by careful attention to the patient's experiential reports, suspension of theoretical presuppositions, and the development and expression of

affective involvement. Surface meanings, rather than unconscious depths, are explored and discussed. Behaviors, even those that appear symptomatic, are assumed to represent important aspects of the patient's past, as well as her values and goals for the future. The use of temporal perspectives—taking account both of the patient's past and the hoped-for future—informs the therapist's overall orientation in treatment.

See Also the Following Articles

Gestalt Therapy ■ History of Psychotherapy ■ Humanistic Psychotherapy ■ Jungian Psychotherapy ■ Language in Psychotherapy ■ Transference ■ Transitional Objects and Transitional Phenomena

Further Reading

- Boss, M. (1963). *Psychoanalysis and daseinsanalysis*. L. B. Lefebvre, (translator). New York: Basic Books.
- Dreyfus, H. L. (1991). *Being-in-the-world: A commentary on Heidegger's being and time, Division I*. Cambridge, MA: MIT Press.
- Havens, L. (1986). *Making contact: Uses of language in psychotherapy*. Cambridge, MA: Harvard University Press.
- May, R. Angel, E. & Ellenberger, H. F. (Eds.) (1958). *Existence: A new dimension in psychiatry and psychology*. New York: Simon and Schuster.
- Orlinsky, D. E. (1994). Research-based knowledge as the emergent foundation for clinical practice in psychotherapy. In P. F. Talley, H. H. Strupp, & S. F. Butler (Eds.), *Psychotherapy, research and practice*. New York: Basic Books.
- Yalom, I D. (1980). *Existential psychotherapy*. New York: Basic Books.

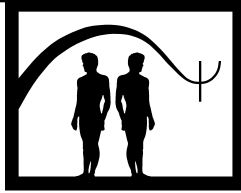

Exposure

Steven Taylor

University of British Columbia

- I. Description of Treatment
 - II. Case Illustration
 - III. Theoretical Bases
 - IV. Applications and Exclusions
 - V. Empirical Studies
 - VI. Summary
- Further Reading

GLOSSARY

flooding Controlled, prolonged exposure to an intensely fear-evoking stimulus until fear reduces in magnitude.

graded *in vivo* exposure Reduction of fears by working up a hierarchy of fear-evoking stimuli.

implosion Imagining an intensely frightening stimulus until it no longer evokes fear. Implosion often involves embellishing the stimulus by exaggerating its fear-evoking properties.

systematic desensitization A form of imaginal exposure that involves gradually working up a hierarchy of fear-evoking stimuli. Typically combined with relaxation training.

Exposure is a form of therapy commonly used in treating phobias and other anxiety disorders. It involves presenting the person with a harmless but fear-evoking stimuli until the stimuli no longer elicit fear.

I. DESCRIPTION OF TREATMENT

Exposure is used in the treatment of a variety of psychological problems. Most commonly, it is used to treat

excessive fears, which are a central component of many anxiety disorders, such as specific phobia, social phobia, panic disorder and agoraphobia, obsessive–compulsive disorder, and posttraumatic stress disorder. During exposure therapy, the person is presented with a fear-evoking stimuli in a controlled, prolonged fashion, until the fear diminishes. Treatment is collaborative, with the patient and therapist working together to decide how and when exposure will take place. Exposure duration depends on many factors, including the type of feared stimuli and the severity of the person's fears. Typically, an exposure session lasts 20 to 90 minutes, and sessions are repeated until the fear is eliminated. Sessions may be either therapist-assisted or may be completed by the patient as a form of homework assignment.

There are several ways that exposure can be conducted. The person may be exposed to real stimuli or may simply imagine the stimuli. Exposure may be to intensely fear-evoking stimuli, or may be gradual, working up a hierarchy of feared stimuli. These two dimensions—real versus imaginal and intense versus gradual—combine to form the four basic exposure techniques: flooding, implosion, graded *in vivo* exposure, and systematic desensitization.

Flooding involves intense exposure to real stimuli. A person with a dog phobia might be exposed to a large boisterous dog until the person is no longer afraid. The advantage of flooding is that it rapidly reduces phobias; four 2-hour sessions are often all that is required. However, there are several disadvantages. First, flooding requires the person to tolerate a great deal of distress.

Some people, particularly those with severe phobias, are unable to do this. Second, flooding can produce temporary but intense side effects such as irritability and nightmares. Third, flooding is often too difficult for patients to conduct alone, and so this form of treatment does not teach patients a skill that they can readily use on their own. When used, flooding is typically implemented with the support and encouragement of a therapist. It is most often used when there is some pressing need for the person to rapidly overcome his or her fears. If a person had a phobia of hospitals and medical staff, for example, flooding would be used if the person was to be soon admitted to hospital for an urgent operation.

Implosion similarly involves exposing the person to intensely fear-evoking stimuli, but in this case the stimuli are imagined. Often exposure is embellished by having the patient imagine an extremely terrifying form of the stimuli. Implosion is often used in the treatment of posttraumatic stress disorder, where the goal is to reduce the fear and associated distress associated with traumatic memories. A person who developed posttraumatic stress disorder as a result of being held hostage in an airplane hijacking, for example, would be asked to repeatedly imagine the traumatic experience, typically for 30 to 45 minutes per treatment session over several sessions. The narrative of the experience might be spoken into a tape recorder or written down, and the person would be encouraged to repeatedly go over the tape or transcript until the memory of the traumatic event no longer evokes distress.

The advantage of implosion is that by reducing the distress associated with traumatic memories the other symptoms of posttraumatic stress disorder also may abate. Thus, implosion can lead to reductions in reexperiencing symptoms (e.g., nightmares, flashbacks), hyperarousal symptoms (e.g., irritability, increased startle response), and avoidance and numbing symptoms (e.g., avoidance of reminders of the traumatic event). A further advantage is that implosion enables the patient to overcome fears for which live exposure is impossible or impractical. Fear of thunderstorms, for example, can be reduced by having the patient repeatedly imagine such events.

The disadvantages of implosion are the same as those of flooding. Even if a patient is able to complete a course of implosion, it is often necessary to add some form of real-life exposure in order to completely reduce the fear. A hijacking survivor might need to resume traveling on airplanes in order to fully reduce the distress associated with the traumatic memories.

Graded *in vivo* exposure is the method most commonly used to reduce fear. It has two components.

TABLE 1
Graded *in Vivo* Exposure: Hierarchy
for Treating Fear of Public Speaking

<i>Stimulus</i>	<i>SUDS</i> ^a
1. Reading a 1-min prepared speech to a friend.	25
2. Reading a 1-min prepared speech to two colleagues at a business meeting.	35
3. Reading a 3-min prepared speech to two colleagues at a business meeting.	45
4. Reading a 3-min prepared speech to six colleagues at weekly staff meeting.	55
5. Presenting a 3-min prepared speech to two colleagues at a business meeting, relying only on rough notes.	60
6. Presenting a 3-min prepared speech to two colleagues at a business meeting, using no notes.	70
7. Presenting a 3-min prepared speech to six colleagues at weekly staff meeting, relying only on rough notes.	80
8. Presenting a 3-min prepared speech to six colleagues at weekly staff meeting, using no notes.	90

^a Subjective Units of Distress Scale, ranging from 0 (no fear or distress) to 100 (extreme fear or distress).

First, the patient is instructed how to rate his or her fear using a Subjective Units of Distress Scale (SUDS). This measure of fear and distress ranges from 0 to 100, where 0 = none, 50 = moderate, and 100 = extreme. Second, the therapist and patient devise a hierarchy of real fear-evoking stimuli, ranging from stimuli that evoke little or no fear or distress, through to extremely frightening or upsetting stimuli. Table 1 shows an example of a hierarchy used in the treatment of intense public speaking fears, which are a common feature of social phobia. This hierarchy was used to help the patient attain the goal of being able to present a short report at a weekly staff meeting.

Typically there are 8 to 10 stimuli in the hierarchy, separated by SUDS increments of approximately 10 points, so that the stimuli are not too discrepant in the levels of fear or distress they evoke. Patients begin by exposing themselves to items lowest on the hierarchy. Exposure to a given stimulus is repeated until the fear or distress abates. Once fear of this stimuli is reduced, the other stimuli on the hierarchy also become less fear evoking. The patient gradually works up the hierarchy; once the fear associated with one stimuli is diminished, then exposure to the next stimulus is attempted. This continues until all the stimuli on the hierarchy no longer evoke fear or distress.

Sometimes it is necessary to develop more than one hierarchy to reduce all the patient's fears. For a person with generalized social phobia, a patient might work through a public speaking hierarchy, a hierarchy of situations involving one-to-one conversations with a person of the opposite sex, and a hierarchy involving asserting oneself to authority figures. The disadvantage of graded *in vivo* exposure is that it is slower than flooding. The advantage is that it teaches patients a skill for overcoming their phobias in a simple, step-by-step fashion. By progressively working up a hierarchy patients can overcome their phobias gradually, without enduring extreme fear or distress.

Systematic desensitization consists of gradual, imaginal exposure to stimuli organized on a hierarchy. The stimuli in Table 1, for example, could be used in systematic desensitization by having the patient imagine each stimulus. Typically, systematic desensitization is combined with some form of relaxation training. The patient is asked to sit back in a comfortable chair and practice a relaxation exercise. Once a state of deep relaxation is attained, the patient is asked to imagine the least upsetting stimulus on the hierarchy. Exposure duration might be only for a few minutes, alternating relaxation with imaginal exposure until the stimulus image no longer evokes fear or distress. The procedure is then repeated with the next stimulus on the hierarchy. The disadvantages of systematic desensitization are that it is slow, and that it is often necessary to eventually implement some form of live exposure in order to fully reduce the fears. The advantage of systematic desensitization is that it is easily tolerated and is therefore a good place to start with reducing extremely severe fears.

II. CASE ILLUSTRATION

Joseph K. was a 27-year-old man with a 5-year history of panic disorder and agoraphobia. He experienced recurrent, unexpected panic attacks. These typically occurred whenever he experienced cardiac sensations (e.g., rapid heartbeat), which he misinterpreted as a sign of impending heart attack. His catastrophic misinterpretations of these sensations increased his autonomic arousal, thereby escalating the feared symptoms to the point that he panicked. Joseph's agoraphobia was characterized by intense fear of traveling far from home, fear of driving over bridges and through tunnels, and fear of entering supermarkets and shopping malls. A detailed medical evaluation revealed no physical problems, including no cardiac abnormalities.

In order to select the exposure methods to be used in treating Joseph's problems, it was necessary to develop

a formulation or working hypothesis about the causes of his difficulties. The therapist hypothesized that Joseph's primary problem was his fear of cardiac sensations, which arose from the patient's belief that these sensations meant that he was having a heart attack. As a result, Joseph feared and avoided situations in which he had experienced these sensations (e.g., while driving over bridges or standing in supermarket lines), and also feared and avoided situations in which it might be difficult to gain speedy medical attention if he actually had a heart attack (e.g., while traveling far from home). Thus, Joseph's agoraphobic fear and avoidance was hypothesized to be a consequence of his fear of arousal-related sensations.

The therapist shared this formulation with Joseph, who agreed that it was a plausible explanation of his problems. The next step was to use the formulation to select the most appropriate exposure interventions. Interoceptive exposure was selected as the method for reducing Joseph's fear of arousal-related sensations. This involves having the patient deliberately bring on the feared sensations (e.g., running up and down stairs to induce rapid heartbeat). Joseph was very frightened of these sensations, so interoceptive exposure was implemented as a form of graded *in vivo* exposure. A hierarchy of fear-evoking activities was constructed, beginning with mildly feared activities (e.g., walking quickly) through to very frightening activities (e.g., running up a long flight of steps). As Joseph worked up the hierarchy he gradually became less frightened of cardiac sensations, and came to see that the sensations would not cause him to have a heart attack. As this fear abated, he became less disturbed by naturally occurring cardiac sensations, and was less likely to panic when those sensations occurred. Four 60-minute sessions of graded interoceptive exposure were required to eliminate his cardiac fears and panic attacks.

Joseph's agoraphobic fear and avoidance slightly abated as a result of interoceptive exposure, although his agoraphobia was still in need of treatment. In particular, he was still extremely frightened of driving through tunnels, to the point that he was too frightened to attempt any form of real-life exposure to tunnels. As a result, the therapist began with systematic desensitization to treat this problem. Joseph was instructed to repeatedly imagine driving through tunnels. Such exposure went on for 30 minutes in the therapist's office. An audiotape was made of the imagined scenes, where Joseph described in detail the experience driving through various tunnels, including a description of all sensations involved (e.g., sights, sounds, smells, bodily sensations) and thoughts he might have (e.g., catastrophic thoughts). Joseph was

asked to listen to the tape once each day for the following week. During his next treatment session his fear of tunnels had abated to the point that he was ready to commence a course of graded *in vivo* exposure. A hierarchy was constructed. The least fear-evoking stimulus involved driving four times through a short, well-lit tunnel during a time when there would be little traffic on the road. Joseph completed this exercise as a homework assignment until his fear abated. He then gradually worked through more challenging assignments, such as driving through longer tunnels until his fear had abated. His other agoraphobic fears, such as fear of entering shopping malls, were similarly treated with a combination of systematic desensitization and graded *in vivo* exposure.

In all, Joseph received 16 weekly 60-minute sessions of therapy. At the end of therapy he was almost free of symptoms of panic disorder and agoraphobia. He was instructed to use the methods learned during therapy to overcome any other fears that might arise. A series of check-up appointments were scheduled, so that Joseph's progress could be monitored. At the 3- and 6-month check-ups he was symptom-free. However, at the 12-month check-up he reported a return of panic attacks, which arose after his grandfather had suddenly died of a heart attack. The death renewed Joseph's fears of cardiac sensations, thereby leading to the reoccurrence of panic. Three booster sessions of interoceptive exposure were sufficient to reduce the fears and panics.

III. THEORETICAL BASES

The rationale for exposure therapies was originally based on the conditioning models of fear acquisition. An early influential account was O. H. Mowrer's 1960 *two-factor model*, which proposed that fears are acquired by classical conditioning and maintained by operant conditioning. Classical conditioning involves one or more learning experiences that teach the person to associate a particular stimulus (e.g., riding in a car) with an aversive outcome (e.g., a road traffic collision). Clinically, the most important form of operant conditioning is negative reinforcement, where avoidance or escape from fear-evoking stimuli is reinforced by the avoidance or escape from unpleasant states of fear or distress. In turn, avoidance and escape prevent classically conditioned fears from being unlearned.

With subsequent research it became apparent that beliefs and expectations play an important role in both operant and classical conditioning, and theories of fear became correspondingly more complex. According to later models, fear was not directly determined by a

stimulus (e.g., driving in the rain), but by the person's expectation of what the stimulus would lead to (e.g., a road traffic fatality). Expectations are strengthened by full or partial confirmation of one's expectations (e.g., a "near miss" while driving).

The major contemporary theory of fears is E. B. Foa and M. J. Kozak's 1986 emotional processing model. Here, fears are represented in networks (fear structures) stored in long-term memory. The networks contain representations of feared stimuli (e.g., oncoming trucks, driving at night), response information (e.g., palpitations, trembling, subjective fear, escape behaviors), and meaning information (e.g., the concept of danger). In the network the three types of information are linked (e.g., links between oncoming trucks, danger, and fear). Links can be innate or learned. Fear structures are activated by incoming information that matches information stored in the network. Activation of the network evokes fear and motivates avoidance or escape behavior. According to this model, fears are reduced by modifying the fear structure through the incorporation of corrective information (e.g., safety information acquired during behavioral exposure exercises). Although the emotional processing model is considerably more sophisticated than the original two-factor model, both models predict that fears—including phobias—are reduced by the various exposure interventions described in this article.

IV. APPLICATIONS AND EXCLUSIONS

Exposure therapies have been applied to all kinds of disorders in which excessive fears play an important role. Apart from the disorders discussed earlier, exposure therapies have been successfully used in treating obsessive-compulsive disorder. Here, the treatment consists of exposure and response prevention. A person with contamination obsessions and cleaning compulsions, for example, would be exposed to a "dirty" object such as a doorknob, and then asked to refrain from engaging in handwashing compulsions. In this way, the contamination-related distress gradually diminishes, and the obsessions about contamination and associated compulsions similarly abate. Exposure and response prevention are most often used in the form of graded *in vivo* exposure, although flooding is sometimes used.

Other anxiety disorders can be similarly treated with exposure methods. Acute stress disorder, which is in many ways similar to posttraumatic stress disorder, can be successfully treated with implosion or systematic desensitization. Generalized anxiety disorder, for

which excessive worry is a central feature, can be treated by exposing the person, in a prolonged fashion, to their worries. The person might spend 20 minutes each day writing out his or her main worries. The distress associated with the worries gradually abates, and the person correspondingly learns to dismiss the unrealistic concerns.

Exposure therapies should only be implemented by a suitably trained therapist. The therapist should not only be skilled in exposure therapy, but should have a good understanding of psychopathology and psychiatric diagnosis, and should be skilled in the psychotherapeutic interventions commonly used in conjunction with exposure therapy (e.g., cognitive therapy, social skills training, relaxation training). If the patient experiences intense anger or guilt during exposure, as sometimes happens when treating patients with posttraumatic stress disorder, it is often necessary to combine exposure with cognitive therapy. The latter is used to address any dysfunctional beliefs associated with anger or guilt.

The patient should be a willing participant in the process of exposure therapy, with complete control over the nature and timing of any exposure exercises. Exposure may be traumatizing if it is forced on an unwilling patient. Exposure should be used only if the patient is able to tolerate some degree of distress, and is sufficiently motivated to overcome his or her fears. Patients should be told about the side effects of exposure treatment (e.g., transient increases in irritability), so that they can make an informed choice about whether or not to participate in treatment. The therapist needs to consider the patient's other problems before initiating a course of exposure. If a patient had social phobia and alcohol abuse, then one would need to consider whether the distress caused by exposure therapy would cause an increase in alcohol abuse. If this is likely, then the alcohol problem would need to be treated first.

V. EMPIRICAL STUDIES

There have been hundreds of clinical studies of the use of exposure therapy in treating the fears associated with anxiety disorders. Exposure therapies are among

the most effective treatment for fears, with success rates typically ranging from 60 to 80%, depending on the severity and complexity of the disorder. Treatment-related gains have been shown to be maintained at follow-up intervals ranging from 1 to 5 years. Patients who do not fully benefit from exposure may be successfully treated by other psychotherapeutic interventions, such as cognitive therapy.

VI. SUMMARY

Exposure methods are used to help people overcome excessive fears or phobias. Exposure therapy is the treatment of choice for specific phobias, and is an important intervention for use in treating other anxiety disorders. It involves having the person repeatedly expose himself or herself to a feared stimulus until fear abates. Patients play an active role in choosing what they will be exposed to, and when the exposure will occur. For patients who are extremely phobic, the least demanding form of exposure (systematic desensitization) is typically the exposure intervention to be used first. Exposure therapies are often used in combination with other interventions, such as cognitive therapy, social skills training, or relaxation training.

See Also the Following Articles

Anxiety Disorders ■ Classical Conditioning ■ Emotive Imagery ■ Flooding ■ Logotherapy ■ Systematic Desensitization

Further Reading

- Foa, E. B., & Kozak, M. J. (1986). Emotional processing of fear: Exposure to corrective information. *Psychological Bulletin*, 99, 20–35.
- Marks, I. M. (1987). *Fears, phobias, and rituals*. New York: Oxford University Press.
- Masters, J. C., Burish, T. G., Hollon, S. D., & Rimm, D. C. (1987). *Behavior therapy: Techniques and empirical findings* (3rd ed.). New York: Harcourt Brace Jovanovich.
- Taylor, S. (2000). *Understanding and treating panic disorder: Cognitive-behavioural approaches*. New York: Wiley.

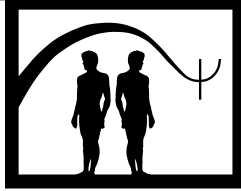

Exposure *in Vivo* Therapy

Wiljo J. P. J. van Hout

University of Groningen

Paul M. G. Emmelkamp

University of Amsterdam

- I. Description of Exposure *in Vivo*
 - II. Theoretical Bases of Exposure *in Vivo*
 - III. Empirical Studies
 - IV. Summary
- Further Reading

GLOSSARY

- exposure *in vivo*** Behavioral procedure based on confrontations with anxiety-provoking stimuli in real life.
- exposure *in vitro*** Behavioral procedure based on confrontations with anxiety-provoking stimuli in the imagination.
- extinction** Decrements in responding through repetition of unreinforced responding.
- flooding** Exposure to high fear-provoking stimuli.
- habituation** Decline of a response over repeated exposures to fear-provoking stimuli.
- hierarchy** List of fearful situations ranging from no fear (0) to extremely anxious or panicky (100).
- interoceptive stimuli** Bodily sensations such as increased heart rate.
- return of fear** Reappearance of fear after the end of treatment.
- sensitization** Increase in fear responding after repeated exposures to fear-provoking stimuli.

I. DESCRIPTION OF EXPOSURE *IN VIVO*

Exposure *in vivo* therapy is a common behavioral procedure used in many treatments. The purpose of ex-

posure *in vivo* therapy is to diminish avoidance behavior and decrease subjective anxiety. This article will present an overview of the current status of exposure *in vivo* in patients with anxiety disorders. Exposure *in vivo* has also been used in patients with substance abuse disorders and eating disorders, but this so-called cue exposure will not be discussed here.

In 1958 Joseph Wolpe developed a behavioral procedure named systematic desensitization. This was presumably the first behavioral procedure, which entailed systematic and repeated confrontation to anxiety-provoking stimuli. During this procedure, patients were first trained in muscular relaxation. After that, patients were encouraged to move gradually up a hierarchy of anxiety-arousing situations, while remaining relaxed. Systematic desensitization may be applied either *in vitro* (in the imagination) or *in vivo* (in real life), but given the fact that it most often was used *in vitro*, systematic desensitization will not be discussed here.

Traditionally, exposure *in vivo* was limited to external circumscribed situations, objects, or animals. Specific phobics were confronted with, for example, snakes or spiders, heights, or small spaces; social phobics with social encounters; agoraphobics with busy or crowded places away from home; and obsessive-compulsive patients were confronted with dirt. However, exposure can also be applied to feared internal (interoceptive) stimuli such as increased heart rate in the case of panic disorder. Examples of interoceptive stimuli are bodily sensations such as trembling or shaking and dizziness. The bodily sensations can be elicited by climbing up

the stairs (increased heart rate), by pushing against a wall (trembling of the muscles of the arms) and by turning around on a chair (dizziness), or by hyperventilation provocation. Specific bodily sensations related to social anxiety can also be evoked in social phobics who fear that others see that they are trembling, sweating, or blushing. In this case, the primary fear is not the sensation itself—as is the case in panic disorder—but the fear of negative evaluation of the physiological responses by others.

The selection of the exposure stimuli depends on the primary focus of concern of the specific patient with his or her specific complaints. It is of central importance to select those stimuli that are most relevant for the individual patient, that is, those situations or objects that are avoided and elicit anxiety or distress.

The rate at which the exposure can be conducted varies from massed schedules (e.g., treatment sessions within 1 day or 1 week) to spaced schedules (e.g., treatment sessions once a week for several months). A promising new schedule is the expanding-spaced exposure (ESE) sessions, in which the intertrial intervals double between sessions. Exposure according to an expanding-spaced schedule is conducted at day 1, day 2, day 4, day 8, day 16, day 32, and so on.

Another central parameter is the optimal duration of exposure to the phobic stimulus during an exposure session. The usual recommendation for clinical practice is to continue exposure until a marked reduction of fear is established. Mostly, exposure duration of one-and-a-half hours to two hours for one hierarchy item is recommended. Sometimes it is difficult or impossible to realize exposure *in vivo* for such a prolonged period of time (e.g., social encounters usually have a shorter time span). In those cases, repeated exposures (i.e., re-exposures) have shown to be effective.

Escape during exposure therapy is assumed to reduce anxiety and to strengthen avoidance, because the reduction of anxiety reinforces the avoidance behavior. Therefore, patients are instructed to remain in a fearful situation until the fear has been reduced. It seems, however, that escape behavior is not necessarily followed by increases of fear and avoidance. The amount of control patients experience during the exposure probably plays an important role in the reduction of fear and avoidance.

Exposure can be performed in a gradual manner (starting at the bottom of the hierarchy), or very steep in the form of flooding (starting at the top of the hierarchy). It should be noted, however, that flooding could lead to noncompliance and dropping out. On the

other hand, if progress is slow during gradual exposure patients may become disheartened. Despite the relative effectiveness of flooding *in vivo* techniques, exposure tasks are mostly performed using a hierarchy of progressively more anxiety-provoking situations (i.e., graded exposure).

Distraction is expected to interfere with fear reduction. It would impede long-term fear reduction, although it may have a positive effect on short-term reductions of fear because it limits the salience of the feared stimulus. The usual recommendation for clinical practice is to avoid distraction during exposure, if possible. This kind of distraction is also referred to as subtle avoidance behavior, and can include behaviors such as counting, deliberately thinking of something else, or talking to other people in order to distract oneself.

Exposure can be conducted with the aid of a therapist, with the aid of the partner of the patient (spouse-aided therapy), or in a self-directed manner. The therapist is most active in guided mastery treatment. Guided mastery treatment encompasses a range of mastery techniques (e.g., therapist-assisted performance, modeling, graduated tasks, proximal goals, physical support, and mechanical aids).

During self-exposure instructions can be given via a self-help manual, via a computer program (or internet), or via videotapes, or self-exposure can be telephone guided. Finally, an exposure program can also be conducted in a group of patients.

II. THEORETICAL BASES OF EXPOSURE *IN VIVO*

Exposure is not a theory, but merely a description of a common behavioral procedure used in many treatments. Several theories of fear and anxiety reduction explaining therapeutic change in exposure *in vivo* therapy have been formulated and empirically tested. The most important theories will be reviewed.

A. Habituation and Extinction Models

Processes often cited as explanation for the effects of exposure are habituation and extinction.

Habituation refers to a decline in fear responses, particularly the physiological responses, over repeated exposures to fear-provoking stimuli. Habituation is regarded as an unlearned temporary reaction. Habituation is supposed not to be affected by cognitions. The

classical habituation theory predicts that habituation would not occur if (baseline) arousal were high. Then, arousal would further increase and lead to sensitization (i.e., increase in fear responding after repeated exposures to fear-provoking stimuli). However, the literature revealed that, for instance, during exposure to high fear-provoking stimuli (e.g., flooding therapy), a reduction instead of a further increase in psychophysiological and subjective anxiety could be expected. Recent habituation theories have been extended to accommodate these findings. These dual-process theories describe complex interactions between habituation and sensitization, in which habituation can eventually occur after exposure to high fear-provoking stimuli.

Several studies have provided supportive evidence for a role of habituation in exposure therapy. First, in several studies self-reported fear and physiological arousal show a declining trend across exposures consistent with habituation. Second, findings in specific phobias have revealed that physiological habituation is related to improvement, whereas nonhabituation is not. Third, variables independent of habituation (e.g., level of arousal, rate of stimulation, and regularity of presentation) seem to affect habituation and fear reduction in a similar manner.

A major difficulty in the habituation theories is the presumed short-term effect of habituation. The habituation theory would predict a return of fear after a certain time interval without stimulus exposure. Studies, however, show that a considerable proportion of patients report to be free of anxiety during long-lasting periods of time. To account for the long-term effects of exposure, several theorists have made a distinction between short-term and long-term habituation. For example, it was suggested that long-term habituation depends on higher cognitive processes, whereas short-term habituation represents mostly autonomic damping. There are more limitations to the habituation theory. For example, the habituation model cannot adequately explain the persistence of some fearful responding despite repeated exposures.

Extinction refers to decrements in responding through repetition of unreinforced responding. Thus, extinction-based theories suggest that anxiety reduction results from repeated encounters with anxiety-provoking situations without aversive consequences. Unlike habituation, extinction is supposed to be affected by cognitions. In other words, it is assumed to be an active instead of a passive process. The extinction theory presupposes that phobic behavior has been learned and therefore can be unlearned. Several cognitive explanations have been put

forward to explain what is learned during extinction of phobic behavior. For example, it is postulated that what is learned is disconfirmation of outcome expectations, or enhanced self-efficacy, or the fact that the arousal associated with exposure is not dangerous. These cognitive-oriented theories will be discussed in more detail in the following paragraphs.

Still another explanation is that the context determines which meaning a situation becomes. It has been suggested that the joint presence of the stimulus (e.g., palpitations) and the context (e.g., far from home) determine the meaning (e.g., heart attack). The latter theory is in line with evidence that return of fear may be minimized with prolonged exposure sessions to a variety of contexts.

Evidence that is in conflict with the extinction theory in explaining fear and anxiety reduction during exposure comes from “escape” studies. According to the extinction theory, patients have to remain in the fear-provoking situation until anxiety decreases substantially in order to learn that nothing bad happens. Several studies have demonstrated, however, that anxiety reduction can occur, even though patients were allowed to escape from the feared situation before reaching maximum anxiety. In these studies, it is unclear what is learned. The patients did not seem to have the time and chance to learn about the possible feared consequences associated with the feared situation.

B. Cognitive Change Models

In 1993 Jack Rachman explained the success of exposure *in vivo* by the acquisition of fresh, disconfirmatory evidence (e.g. “no heart attack,” “did not lose control”), which weakens the catastrophic cognitions. From this perspective, exposure is viewed as a critical intervention through which catastrophic cognitions may be tested. This is in line with the cognitive-behavioral therapy (CBT) based on the perceived danger theory according to Aaron Beck and colleagues. Within this model exposure (i.e., behavioral experiments) is generally regarded as a necessity for testing the validity of dysfunctional thoughts next to other strategies such as Socratic questioning of probabilities.

So far, it remains to be shown whether exposure changes cognitions and thereby lessens anxiety, or whether cognitions are less likely to arise when anxiety diminishes. The traditional outcome (pre- versus post-test) studies do not reveal whether cognitive change occurs as a function of exposure therapy. To answer these questions, process-oriented studies are required. Process

studies require repeated measurements of relevant variables during the treatment process.

Several process studies have been performed into the cognitive processes of exposure *in vivo*. In these process studies, thoughts are generally collected by means of *in vivo* assessment (e.g., thoughts are reported into a tape recorder) during exposure, or using thought-listings (i.e., free report of all thoughts on paper) directly following exposure. In general, inconsistent findings are reported in these process studies designed to measure the relationship between cognitive change and improvement during *in vivo* exposure in phobic patients. However, the production techniques used to measure cognitive change show some flaws, for example, the inability to recall all thoughts (thought-listings), and social discomfort with publicly talking to themselves (*in vivo* assessment). Furthermore, the *in vivo* assessment may distract the patients from being engaged in the exposure situation with possible consequences for treatment outcome. Finally, the thought-listing procedure is, generally, utilized following the exposure sessions, and therefore cannot reveal the process during treatment.

More consistent results were found in a process study using a short self-report questionnaire to measure the frequency of thoughts during exposure *in vivo*. Results showed that cognitive change (decrease in frequency of negative self-statements) was achieved by exposure *in vivo* therapy. However, cognitive change per se was not related to a positive treatment outcome. The results suggested that the magnitude of the frequency ratings of negative self-statements at the start, during, and at the end of exposure therapy was the most critical factor. The most improved patients reported overall less negative thoughts.

C. The Self-Efficacy Theory

According to the self-efficacy theory of Albert Bandura, published in 1977, therapeutic change can be brought about by experiences of mastery arising from successful performance. Bandura has proposed that phobic behavior is influenced more by self-efficacy judgments than by outcome expectations. He argues that a person's self-efficacy can be improved by those psychological procedures, which enhance the level and the strength of the self-efficacy. Implicitly, he states that an exposure procedure is not a necessary condition to obtain therapeutic change. Self-efficacy can be improved by various treatment procedures. Field mastery experiences are, however, considered a critical ingredient of treatment of phobic disorders. Thus, in the self-

efficacy theory, the psychological mechanism of change is a cognitive one, whereas the most effective psychological procedure is a behavioral one (performance-based). According to Bandura, perceived self-efficacy through performance successes depend on various personal and situational factors, for example, difficulty of the task, amount of effort subjects expend, and the temporal pattern of their successes and failures. The model posits a central role to information processing. It states that subjects process, weight, and integrate information about their capabilities, and they regulate their behavior and effort accordingly. Strong relationships have been found between perceptions of self-efficacy and changes in phobic behavior by different treatments (including exposure therapy) for various phobias. On the other hand, there is also some evidence that seems in conflict with the self-efficacy theory. Some studies found that although self-efficacy predicted self-reported change, it did not have a significant relationship with behavioral or physiological change.

More recently, Bandura extended the self-efficacy theory by stating that phobic anxiety derives from both low self-efficacy for performing overtly, and from low self-efficacy for exercising control over scary thoughts. Overall, self-efficacy seems a powerful measure in predicting dysfunctional behavior. The self-efficacy mechanism has received considerable support from research in describing the relationship between what subjects think they can manage and what they can manage both before and after treatments for phobic complaints.

D. The Match–Mismatch Model

Rachman and colleagues have suggested that anxiety expectancies might play a mediating role in exposure therapy. They found that phobics typically overpredict the amount of fear they expect to experience in a threatening situation.

A number of researchers investigated the overprediction of fear in a series of laboratory studies, in which they asked the subjects to rate their predicted fear before they were exposed to a threatening situation, and to indicate their reported fear just after the exposure trial. Subjects overpredicted their fear when the predicted fear was higher than the reported fear. On the other hand, subjects underpredicted their fear when the predicted fear was lower than the reported fear. A match was defined as no discrepancy or a very small discrepancy between predicted and reported fear. Subjects participated in several trials to observe whether their predictions changed over time. Accord-

ing to Rachman, fearful subjects tend to overpredict their fear during exposure to a fearful situation. Further, the match–mismatch model states that inaccurate fear predictions are followed by adjustments of these predictions. For example, when a subject underpredicts a fearful event, it is likely that he or she adapts his or her prediction in the form of an increase of predicted fear for future events. On the other hand, when overpredictions are followed by disconfirmations, future predictions will be lowered. The model also states that other variables, like anticipatory fear and avoidance behavior, are influenced by inaccurate predictions. Increases in these variables are expected after underpredictions, and decreases are expected after overpredictions of fear. Furthermore, it is assumed that underpredictions have stronger and more long-lasting effects on fear expectations, avoidance, and anticipatory anxiety than overpredictions, which are assumed to have moderate effects on reductions of these variables. For example, one underprediction of fear can lead to a substantial rise in fear expectations. Overpredictions, on the other hand, need several disconfirmations to become more accurate, but have a less dramatic influence on the decrease of expectations. In addition, it is assumed that predictions of fear become more accurate with practice. Lastly, during exposure, it is assumed that the fear reduction process is not influenced by inaccurate predictions; reports of fear tend to decrease, regardless of the accuracy of earlier predictions. Thus, the model assumes that a second process is responsible for the process of habituation/extinction.

Reviewing the empirical evidence for the match–mismatch model it can be concluded that the studies report strong relations between inaccurate predictions and future predictions in subclinical and clinical patients. So far, it is unclear whether mismatches of fear influence the habituation or extinction process. In sum, overpredictions of fear lead to avoidance behavior and anticipatory anxiety because subjects expect to be more fearful during exposure than should actually be the case. Subjects, thereby, reduce the chance of disconfirmation of the predictions. The effects of exposure are assumed to be due to repeated disconfirmations, because predictions become more accurate with repeated exposures. During exposure, it is expected that underpredictions have far more influence than overpredictions. The underlying mechanisms of overpredictions are as yet not clear.

Most support for the match–mismatch model derives from studies performed in a laboratory setting with relatively mild phobic subjects. A recent study investigated whether the results of the laboratory studies

could be replicated in a clinically relevant situation, namely exposure *in vivo* therapy, with a clinical group of agoraphobic patients. Many of the findings of the laboratory studies were replicated. However, although patients tended to overpredict their fear, they did not show a tendency to become more accurate in the course of exposure therapy.

E. Emotional Processing

Emotional processing is defined as the modification of memory structures that underlie emotions. This model of anxiety reduction is partly based on Peter Lang's model of bioinformational processing and Jack Rachman's work on the concept of emotional processing.

According to Lang emotion is represented in memory structures as action tendencies that contain (1) information about the feared stimulus situation; (2) information about verbal, physiological, and overt behavioral responses; and (3) interpretative information about the meaning of the stimulus and response elements of the structure. Treatment should aim at activating all aspects of the prototype fear image stored in memory, so that the information can be processed and a new prototype can be formed that contains less fearful or nonfearful response to the stimulus information. Because emotion is considered an action set, it is assumed that it generates physiological output.

Rachman suggested indices of satisfactory and unsatisfactory emotional processing, and concrete factors that are expected to impede and promote emotional processing. In his view, satisfactory emotional processing leads to evidence that subjective distress and disturbed behavior decline, and to evidence of a return of normal (routine) behavior.

Foa and Kozak offered a framework about the mechanisms of therapeutic change and specified indicators of emotional processing. They suggested that the fear structure is a program to escape from danger. The fear structure is distinguished from a normal information structure by excessive response elements (e.g., avoidance and physiological arousal), and by the meaning of the stimuli and responses. The fear structures can be modified during exposure therapy when two conditions are satisfied: (1) the fear structure must be activated; and (2) new information must be incorporated. Exposure to information consistent with the fear structure would be expected to strengthen fear, whereas information incompatible with the fear structure would reduce fear.

It is assumed that measurable physiological activity and self-reports reflect the fear structure during fear

evocation. Especially, physiological activity is considered as an index that information is processed: Fear activation cannot occur without preparatory changes in physiological activity. That is, within a fear structure defined as a program to escape or avoid, fear will produce physiological activity regardless of whether one actually avoids the fearful object or not. The following responses occurring in patients who improve with exposure-based treatments are seen as indicators of emotional processing: (1) activation of psychophysiological responses and subjective fear responses during exposure, (2) decrease of these responses within exposure sessions (within-sessions habituation), and (3) decrease in initial reactions to feared stimuli across sessions (across-sessions habituation). Activation of the fear structure can be complicated by, for example, cognitive avoidance or other distractions, as was also mentioned by Rachman. Incomplete emotional processing can occur when the duration of exposure is not long enough for habituation to occur. Finally, initial high arousal would interfere with anxiety reduction (habituation).

This model is generally supported by research findings. It should be noted, however, that the model also faces several difficulties. For example, the emotional processing theory cannot explain controlled escape exposure.

III. EMPIRICAL STUDIES

Empirical outcome studies have proved that exposure *in vivo* is an effective treatment in reducing phobic complaints in specific phobias, in social phobias, in agoraphobia with or without panic disorder, and in hypochondriasis. Studies have shown that exposure to anxiety-provoking situations also has a positive effect on frequency and intensity of panic attacks in agoraphobics. Obsessive–compulsive disorder patients benefit from exposure *in vivo* treatment with the addition of response prevention (i.e., the prevention of behaviors that reduce fear).

A. Parameters of Exposure *in Vivo*

Wolpe explained the relative effectiveness of systematic desensitization by the fact that it would be impossible to feel anxious and relaxed at the same time; he called this reciprocal inhibition. Research, however, has demonstrated that the addition of relaxation to the exposure element is not essential for improvement. In the eighties, Lars Göran Öst introduced “applied relax-

ation”. The purpose of applied relaxation is to teach the patients to monitor and recognize the early signs of tension and to apply a relaxation technique when confronted *in vivo* with phobic situations. It has not been proven that the addition of applied relaxation enhances the effects of mere exposure *in vivo*.

Massed exposure sessions are expected to be related to higher dropout rates, more return of fear, and more stressfulness in comparison to spaced sessions. However, research into the optimal format of exposure does not provide firm evidence to justify this expectation. For example, in agoraphobics massed exposure was generally more or as effective as spaced exposure in reducing avoidance behavior and self-reported anxiety. Furthermore, the dropout rate, relapse rate, and stressfulness were comparable for patients who received spaced or massed sessions. In addition, for specific phobics and for obsessive–compulsive patients, no differential effect was found between spaced and massed exposure in relapse rate or dropout rate. As to the ESE sessions, in which the intertrial intervals double between sessions, research showed that the ESE sessions led to no clear return of fear, whereas a massed condition (four exposure trials within 1 day) did lead to return of fear 1 month after the end of treatment.

Another central parameter is the optimal duration of exposure to the phobic stimulus during an exposure session. Several studies have consistently indicated that long continuous sessions (prolonged exposure) are more effective than shorter or interrupted sessions. However, some studies on escape behavior during exposure have shed a different light on this issue.

Several studies compared endurance conditions with escape conditions. During the endurance condition, patients stayed in the fearful situations until the anxiety markedly decreased, whereas in the escape condition patients were allowed to leave the exposure situation at high fear levels. In general, results revealed no differences in effectiveness between the treatment conditions on measures of fear and avoidance. It is assumed that the option of escaping during exposure may serve to increase the patients’ sense of control, which would in return lead to a reduction of their fears. This form of escape is also referred to as controlled escape. Thus, the amount of control patients experience during the exposure probably plays an important role in the reduction of fear and avoidance.

Another parameter is the amount of arousal patients experience in relation to improvement by exposure. Some studies indicate that patients who were most aroused before treatment (mostly measured by heart

rate) were also most likely to be improved after exposure therapy. Other studies showed that patients with relatively high heart rate demonstrated the most return of fear at follow-up as compared to patients with relatively low heart rate levels. Still other studies found no relationship between heart rate and return of fear or found inconsistent results.

The results with respect to distraction versus attention-focused exposure on fear reduction and improvement are inconclusive. Either no differences are found in the amount of fear reduction between distracted and focused exposure, or the fear levels during distracted exposure remained stable whereas during focused exposure fear ratings increased. With respect to return of fear, results showed that distracted exposure led to return of fear, or the distracted exposure condition experienced more fear reduction at follow-up compared to the focused exposure condition.

The results of the studies on agoraphobia and obsessive-compulsive disorder indicated that the participation of the spouse in the exposure treatment did not enhance the treatment effects. Further, results with respect to the comparative effectiveness of therapist controlled versus self-exposure are inconclusive. However, in six out of eight studies, guided mastery was substantially and significantly more effective than mere exposure. In all these studies the duration of the treatment conditions was equal, and both conditions were therapist-assisted.

B. Long-Term Efficacy of Exposure *in Vivo* Therapy

Despite the effectiveness of exposure therapies on group level, the results show that not all patients benefit equally at posttreatment from exposure therapy or maintain their gains at follow-up. A proportion of phobic patients, about 25 to 30%, either fail to respond, or show only modest improvement after a standard exposure treatment and therefore need more treatment, or do not maintain their gains in the long run. The efficacy figures, however, tend to differ somewhat among the studies on the same disorders and also among the same phobic disorders over studies.

In general, exposure techniques have led to long-term improvement in about 75% of obsessive-compulsives. Also, the long-term efficacy of exposure treatment for agoraphobics has been well established. About 75 to 80% of the patients are rated as “improved” or “much improved” at the end of treatment. Furthermore, posttreatment effects of exposure therapy are maintained during the follow-up period in panic and agoraphobic patients.

Results from a recent study investigating the long-term effectiveness of exposure *in vivo* revealed that of the 93 treated panic disorder patients with agoraphobia, 67.4% continued remission up to 7 years.

The efficacy figures of *in vivo* exposure therapy for social phobic patients are less encouraging. For example, one study reported that 47% of the social phobics needed more treatment at the end of exposure treatment.

In sum, although, exposure *in vivo* therapy is effective for most patients, the efficacy is limited; some patients show only moderate clinical improvement or do not maintain their gains. It is not clear why some patient(s) (groups) benefit more from *in vivo* exposure than others.

C. Exposure *in Vivo* Therapy versus Cognitive Therapy

One of the theoretical problems in the comparison of the effectiveness of exposure *in vivo* therapy and cognitive therapy is that cognitive restructuring without any form of exposure is rare in cognitive therapy. The use of exposure exercises called “behavioral experiments” or “hypothesis testing” is seen as clinically important aspects to test the validity of the beliefs.

In specific phobias, cognitive therapy was generally less effective than *in vivo* exposure. Several studies found cognitive therapy and exposure *in vivo* therapy with the addition of response prevention about equally effective in obsessive-compulsives. Similarly, cognitive therapy is as effective as exposure *in vivo* therapy alone for social phobic complaints. In general, studies find that cognitive therapy alone is of limited value for agoraphobia as compared to exposure *in vivo*. More recently developed cognitive approaches focusing on catastrophic cognitions are effective with respect to reduction of panic attacks in patients with panic disorder with no or limited avoidance, but less effective than exposure *in vivo* in severe agoraphobic patients. However, these cognitive restructuring packages contain an “exposure” component (i.e., behavioral experiments). Finally, exposure *in vivo* was as effective as cognitive therapy in hypochondriasis.

Overall, the literature suggests that cognitive therapy does not enhance the effects of exposure *in vivo*. For example, results of several studies showed that exposure with and without cognitive modification was equally effective in social phobia. Similarly, studies with acrophobics revealed that exposure with self-statement training was as effective as exposure alone. Further, a number of studies found cognitive-behavioral packages not more effective than exposure *in vivo* for panic disorder with agoraphobia. In addition, in obsessive-compulsive disorder,

cognitive therapy did not enhance the effects of exposure *in vivo*. Possibly these findings can be explained by the fact that cognitive changes also naturally accompany exposure *in vivo*.

IV. SUMMARY

Exposure *in vivo* therapy is a behavioral procedure in which patients are confronted in real life with those situations or objects that they fear and/or avoid. The purpose of *in vivo* exposure is to reduce subjective anxiety and avoidance behavior. There are many variations in the way exposure is conducted. The efficacy of these varied procedures differs somewhat between the disorders. Research has shown that exposure *in vivo* therapy is an effective strategy for most phobic patients. About 70 to 80% of the phobic and obsessive-compulsive patients who complete treatment benefit from exposure *in vivo* therapy and maintain their gains in the long run. On the basis of the efficacy studies that have been conducted, a task force of experts in the field judged exposure *in vivo* as one of the few well-established psychotherapies.

Several theories on fear and anxiety reduction during exposure *in vivo* therapy have been formulated and empirically tested. Most theories assume that some kind of cognitive change is essential for improvement by exposure. However, it is still unknown what is exactly modified. Are dysfunctional thoughts modified as suggested by several cognitive models? Does the confidence of the ability to perform successfully change as suggested by the self-efficacy theory? Are the fear predictions becoming more accurate as suggested by the match-mismatch model? Or does the fear memory alter as suggested by the emotional processing theory? It is un-

likely that one process can explain fear reduction during exposure therapy. Different processes may change different responses in different patients.

Acknowledgment

This article is partly based on the introductory chapter "Exposure *in vivo*: Efficacy, Procedure and Theory" in the Ph.D. thesis "Cognitive Processes During Exposure *in vivo* Therapy in Agoraphobia" by W. J. P. J. van Hout, conducted under the direction of P. M. G. Emmelkamp.

See Also the Following Articles

Avoidance Training ■ Extinction ■ Implosive Therapy

Further Reading

- Barlow, D. H. (1988). *Anxiety and its disorders*. New York: Guilford.
- Craske, M. G. (1999). *Anxiety disorders: Psychological approaches to theory and treatment*. Boulder, CO: Westview.
- Emmelkamp, P. M. G. (2001). Behavior therapy with adults. In L. Beutler (Ed.), *Bergin and Garfield's handbook of psychotherapy and behavior change* (5th ed.). New York: Wiley.
- Emmelkamp, P. M. G., Bouman, T. K., & Scholing, A. (1992). *Anxiety disorders: A practitioners guide*. Chichester: Wiley.
- Foa, E. B., & Kozak, M. J. (1986). Emotional processing of fear: Exposure to corrective information. *Psychological Bulletin*, 99, 20–35.
- Hout, W. J. P. J. van, & Emmelkamp, P. M. G. (1994). Overprediction of fear in panic disorder patients with agoraphobia: Does the (mis)match model generalize to exposure *in vivo* therapy? *Behaviour Research and Therapy*, 32, 723–734.
- Marks, I. M. (1987). *Fears, phobias, and rituals*. New York: Oxford University Press.
- Rachman, S. (1990). *Fear and courage*. New York: W. H. Freeman.

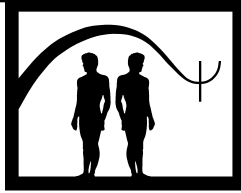

Extinction

Alan Poling, Kristal E. Ehrhardt, and R. Lanai Jennings

Western Michigan University

- I. Description of Treatment
 - II. Theoretical Bases
 - III. Applications and Exclusions
 - IV. Empirical Studies
 - V. Case Illustration
 - VI. Summary
- Further Reading

GLOSSARY

extinction burst A temporary increase in the rate or intensity of a behavior on extinction.

extinction-induced aggression Aggressive behaviors that occur following the introduction of extinction to a target behavior. These behaviors have no other identifiable causes.

intermittent schedule of reinforcement An arrangement under which not every occurrence of a behavior is reinforced, although some occurrences are reinforced.

planned ignoring Deliberate withholding of attention, including verbal exchanges and physical interaction, for a brief period following inappropriate behavior.

respondent extinction A procedure in which respondent conditioned behaviors are weakened by breaking the pairing between a conditional stimulus (CS) and an unconditional stimulus (US), either by presenting the CS alone or by presenting the CS and US independently of one another.

resurgence The appearance of behaviors that were previously extinguished when extinction is introduced for a more recently reinforced response.

spontaneous recovery The reappearance of behavior substantially weakened by extinction following a period of time despite no resumption of reinforcement.

The term extinction is used to refer to two different kinds of response-weakening operations, respondent extinction and operant extinction. In one, respondent conditioned behaviors are weakened by breaking the pairing between a conditional stimulus (CS) and an unconditional stimulus (US), either by presenting the CS alone or by presenting the CS and US independently of one another. Although respondent extinction can be a component of the treatment of some behavioral problems (e.g., phobias, sexual fetishes), operant extinction is a more widely used procedure and only it will be covered further here.

I. DESCRIPTION OF TREATMENT

Operant extinction is a procedure in which reinforcement of a previously reinforced behavior is discontinued. Reinforcement occurs when a behavior is strengthened by its consequences. When such consequences no longer occur, the behavior eventually weakens and occurs rarely, if at all. This is operant extinction (hereafter called "extinction"). During extinction, emission or omission of the response in question produces neither a negative nor a positive reinforcer.

Therapeutic applications of extinction involve four steps:

1. The behavior to be reduced must be defined and a system for accurately quantifying the behavior must be

selected. This step is a prerequisite to treating any behavioral problem.

2. The events that follow and maintain the behavior, that is, its reinforcing consequences, must be determined. Isolating the consequences that reinforce a behavior, and the situations under which those consequences are evident, is termed functional assessment. Functional assessment is often, although not necessarily, accomplished through direct observation and interviews with care providers. It must be done prior to the use of extinction.

3. Conditions must be arranged so that the consequences that previously served as reinforcers no longer follow the inappropriate behavior. Moreover, the behavior must not be followed by new reinforcing consequences. The exact procedures required to arrange extinction depend on the nature of the reinforcing consequences and the situations in which they occur.

4. As with any treatment, the effects of extinction must be evaluated carefully. If necessary, the procedure should be modified to produce the desired effects. Although extinction is simple in principle, in practice it often is difficult to arrange and initial attempts frequently are unsuccessful. Moreover, extinction sometimes produces undesired and unacceptable changes in behavior that may require termination of the procedure.

The most common application of extinction is to behaviors that are maintained by positively reinforcing consequences that are delivered by other people, such as social attention. By definition, positively reinforcing consequences (or positive reinforcers) are stimuli that strengthen a behavior by being added to an individual's environment. That is, they are not present in the absence of a particular behavior, but are produced (or increased in intensity) by its occurrence. For example, the self-injurious behavior of some people with developmental disabilities is maintained, although unintentionally, by the attention of caregivers. That is, when the person hurts himself or herself, attention is immediately forthcoming, and this is why the behavior occurs. If it is possible for a therapist, or some other invested party, to determine that this is the mechanism responsible for the self-injury, and to convince caregivers to stop attending to the self-injury, then extinction would be arranged and the behavior should eventually disappear. Because responding may persist for a substantial period when extinction is arranged, and may even increase in intensity, the procedure would be used in such a case only if the self-injurious behaviors did not pose significant risk to the client.

Planned ignoring is a procedure related to extinction that is often used as an intervention for reducing inap-

propriate behavior in children. Planned ignoring involves the deliberate withholding of attention, including verbal exchanges and physical contact, for a brief period (typically no more than 1 or 2 minutes) following inappropriate behavior. This procedure involves extinction if the inappropriate behavior historically was maintained by events that are withheld during the period of planned ignoring and the behavior actually occurs during this period.

Arranging conditions such that the event that previously served as the positive reinforcer is presented independently of the previously reinforced behavior is another procedure for arranging extinction. If, for example, a baby's screaming is positively reinforced by parental attention—the parents attend to the baby only when it screams—extinction could be arranged by having the parents attend to the baby regardless of whether or not it was screaming. Although this procedure might be effective in reducing screaming, it probably would be less effective than simply ignoring the behavior.

Presenting the reinforcer independently of responding is rarely used clinically to reduce responding maintained by positive reinforcement. An exception is a procedure commonly (but inaccurately) termed noncontingent reinforcement (NCR), which has recently generated researchers' interest as a treatment for high-rate problem behaviors maintained by positive reinforcement (e.g., attention) in people with developmental disabilities. NCR usually involves presenting the stimulus that historically maintained a troublesome behavior under a fixed-time (FT) schedule. Under an FT schedule, something is done to an individual every time a specified time passes, regardless of the individual's behavior during that period. When NCR is arranged, the interval initially is very short (e.g., 5 seconds) and is gradually increased over time, typically to a terminal value of around 5 minutes. For example, if functional assessment reveals that a client's self-injurious behavior is maintained by caregivers' attention, NCR might involve having caregivers attend to the client almost continuously, regardless of whether or not self-injury occurred. Over time, the frequency of attending to the client would be gradually reduced, perhaps to a brief interval of attention every 5 minutes. Such procedures have been demonstrated to be effective in reducing troublesome behaviors in controlled settings for relatively short periods, but their value in the long-term management of inappropriate responding in everyday settings is unknown. When NCR is effective, extinction and satiation (a reduction in the reinforcing effectiveness of a stimulus because of repeated exposure to that stimulus) appear to be its mechanisms of action.

In some cases, troublesome behaviors are maintained by automatic and positively reinforcing sensory consequences. It may appear that extinction cannot be arranged when this occurs, but that is not necessarily so. A procedure called sensory extinction, in which sensory consequences are altered or removed, may be effective in reducing inappropriate behaviors maintained by automatic reinforcement. For example, in the first published study in which this procedure was used, Arnold Rincover successfully reduced plate spinning in a client with developmental disabilities. Rincover proposed that the behavior, which occupied a great deal of the client's time and was disruptive, was maintained by the auditory stimulation produced by the moving plate contacting the top of the client's desk. Covering the top of the desk with carpeting eliminated the noise produced by spinning the plate and, over time, virtually eliminated the behavior.

Extinction can be arranged for behaviors maintained by negative, as well as positive, reinforcement. Behaviors maintained by negative reinforcement are strengthened because they eliminate a stimulus (or reduce its intensity), in which case they are escape responses, or because they prevent the occurrence of an otherwise forthcoming stimulus, in which case they are avoidance responses. A child who has tantrums soon after being placed in a bathtub because, historically, doing so ended baths is engaging in escape responding. A child who pleads to a sympathetic grandparent at bedtime "I'm too tired for a bath, Gram, can I just sleep now?" because, historically, doing so prevented the parents from bathing the child, is engaging in avoidance responding.

Effective extinction for escape responding can be arranged by maintaining the stimulus once escaped regardless of whether the behavior that once controlled that stimulus occurs or not. The child in our example will eventually stop having tantrums in the tub if such behavior is ineffective in terminating baths.

Extinction often is not a useful strategy for reducing avoidance responding. In this case, extinction can be construed as failing to present the stimulus that once was avoided, regardless of whether or not the avoidance response occurs. In our example, the parents might decide simply to forgo bathing their child when the grandparent was present, regardless of the child's behavior. Under such conditions, the historical avoidance response, although no longer effective in controlling baths, might persist indefinitely. In large part, this is because it would be difficult for the child to ascertain that conditions have changed. Successful avoidance responses prevent something from happening—the child did not have to take a bath after pleading with Gram—and that same some-

thing does not happen when extinction is arranged in this way—the child still does not have to take a bath, although this is not because of pleading.

Arranging extinction in a different way, that is, by presenting the once-avoided object or event regardless of whether or not the historical avoidance response occurs, makes extinction easy to discern and is likely to weaken the response rather quickly. In our example, forcing the child to take a bath regardless of whether or not pleading occurred probably would eliminate the behavior fairly quickly.

In general, extinction is likely to be effective in reducing troublesome behavior if five conditions are met:

1. Reinforcers that historically strengthened the behavior are accurately identified.
2. Reinforcement of the troublesome behavior never occurs.
3. Extinction is arranged for a sufficient period to reduce the behavior to acceptable levels, probably indefinitely.
4. Conditions of extinction are explained clearly and accurately to verbal individuals who are exposed to those conditions.
5. Arrangements are made so that the reinforcers that once maintained inappropriate behavior are available dependent on appropriate behavior, unless the reinforcers themselves pose problems.

II. THEORETICAL BASES

Like punishment and reinforcement, extinction is a term that describes a particular relation among behavior and other environmental events. There is no "theory" of extinction as the term is commonly used. As discussed in the article "Operant Conditioning," it may eventually be possible to disclose the physiological changes responsible for the behavioral effects of extinction. For the most part, however, behavior analysts have been content to describe relations among behavior and other environmental events and to ascertain the variables that modulate those relations.

From the beginning of his career early in the 20th century to his death in 1992, the eminent psychologist B. F. Skinner claimed that the effects of consequences on behavior are not permanent. If the reinforcers that initially established and maintained an operant response no longer follow such behavior, then the behavior eventually weakens and rarely occurs. Skinner used the term

“extinction” to refer to the discontinuation of reinforcement for a previously reinforced response, and the term has persisted. Many laboratory studies of nonhumans, and a smaller number of basic (i.e., not clinical) studies with humans have investigated the effects of extinction and documented the general effectiveness of the procedure in reducing operant responding. Those studies also have isolated the variables that influence responding during extinction.

Early clinical applications of extinction involved procedures that were close parallels of those used in basic laboratory studies and, like those laboratory procedures, were effective in reducing behavior. Over the years, extinction has been arranged in various ways in clinical settings, but all of these variations share a common feature: Reinforcement is no longer available for a response that historically was reinforced. It is consistent with the principles of operant conditioning that responding will decline when this occurs, and theoreticians expect this to happen. Moreover, as explained in the following section, it characteristically does.

III. APPLICATIONS AND EXCLUSIONS

Operant behavior in any human being is sensitive to extinction; therefore, the procedure may be appropriate for reducing a given behavior in clients regardless of their diagnosis or presenting problems. Extinction is appropriate for reducing specific target behaviors—it is not sufficient for dealing with the confluence of signs and symptoms that commonly occur in people with psychiatric labels. For instance, extinction might be useful in reducing a particular operant behavior in a person diagnosed as schizophrenic, but it would not be appropriate for dealing with the full spectrum of problems characteristic of the disorder (e.g., hallucinations, flat affect, thought disorders). Therefore, extinction often is part of a treatment package, not a stand-alone treatment, for people with psychiatric disorders.

In the literature, extinction has been used most often with children or persons with developmental disabilities. This is not because the procedure is effective only in such individuals. Instead, behaviors that are good candidates for treatment with extinction probably appear especially often in these populations, and it is often relatively easy to control their environments so that troublesome behaviors are extinguished.

There is nothing intrinsic to extinction that makes it unacceptable to particular ethnic or racial groups, al-

though cultural practices and personal preferences should be considered in considering a specific extinction procedure. For example, some parents will object to ever withholding attention from their child, even if the goal is to reduce an inappropriate behavior. Obviously, such parents would not be good candidates for using extinction. There also are factors that limit the use of extinction in general; these factors are discussed in the next section.

IV. EMPIRICAL STUDIES

In principle, extinction can be applied to any operant behavior over which control of its consequences can be arranged. Published studies have documented the use of extinction to control a wide variety of undesired behavior, including crying, whining, tantrums, food refusal, stealing, night waking, self-injurious behavior, self-stimulatory behavior, and disruptive classroom behavior. The effects of extinction are long-lasting and use of the procedure typically is not constrained by the legal and ethical considerations raised by punishment. These are points in its favor.

Even though extinction can be used to reduce a variety of behaviors in a wide range of individuals, extinction has characteristics that limit its utility. One limitation is that it may not be possible to arrange conditions so that the consequences that historically reinforced an inappropriate behavior are no longer available. For example, a middle-school student's swearing may be maintained by the laughter of peers. Trying to arrange the world so that the peers stopped laughing following jokes would be, at best, difficult. More likely, it would be impossible. Similarly, nicotine is a powerful positive reinforcer that plays a major role in the maintenance of cigarette smoking. There is presently no way to eliminate nicotine as a consequence of smoking, although some pharmacological technique for producing such an effect may eventually be developed. Drugs such as naltrexone block the physiological, subjective, and positively reinforcing effects of heroin, and have potential for the treatment of heroin abusers. Their primary mechanism of action is extinction. Scientists eventually may develop drugs that block the reinforcing effects of nicotine. The problem with such drugs, of course, is that cigarette smokers may refuse to take them. Escape from or avoidance of extinction is not unusual.

The most common reason that attempts to reduce behavior with extinction fails is inconsistent application of the procedure. That is, reinforcement typically is not available, but occasionally it does occur. The result is that

the troublesome behavior is maintained under an intermittent schedule. For instance, parents taking away a toddler's bottle may ignore requests for the bottle on many occasions, then give in to a midnight crying fit and provide a bottle "just this one time so we can sleep." The result is that asking for the bottle has been reinforced under an intermittent schedule and, therefore, has become more resistant to extinction. The rate and pattern of responding in extinction is strongly influenced by how reinforcement was arranged prior to extinction. As a rule, the more intermittently reinforcement occurred prior to extinction, the longer behavior persists when extinction is arranged. Inconsistent use of extinction is apt to constitute an intermittent schedule that reduces the effectiveness of subsequent, consistently arranged, extinction. Effective clinicians recommend the use of extinction only when they are relatively sure that the procedure can be implemented consistently over long periods.

Keeping extinction in effect over long periods sometimes is rendered difficult by a behavioral phenomenon known as extinction-induced bursting. Extinction-induced bursting refers to a transient increase in the rate of responding that often occurs soon after extinction is implemented. For instance, a child whose requests for a bottle are unsuccessful is apt to increase the rate of asking over the short run. This may be intolerable for the parents, who eventually "give in." The intensity as well as the rate of behavior may increase briefly during extinction, which can also cause problems. So, too, can the increase in variability of responding that characteristically occurs during responding. For instance, an increase in the intensity of self-injurious behavior, or a change in its form, might pose an unacceptable risk of serious harm to the client. Although such effects rarely limit the use of extinction, they can occur and therapists must be alert for them. Therapists must also understand that extinction also often induces negative emotional responding and may induce aggressive responding. Such behaviors may be unacceptable in some circumstances.

Resurgence, which refers to the reappearance of behaviors that have been previously extinguished when extinction is arranged for a current behavior, potentially could cause problems in therapeutic settings. For example, a preschool student may have historically gained attention from teachers by crying, which was successfully treated by extinction. At a later date, "whining" produced the same reinforcer, and was treated successfully in the same way. Most recently, the child has begun to secure attention by making "animal sounds." Extinction has been introduced for this latest problem behavior,

which has begun to decrease in frequency. As it does so, however, it is possible that whining, and subsequently crying, will occur more often than before extinction was arranged for making animal sounds. If so, resurgence has occurred.

Although resurgence conceivably could create problems in therapeutic settings, this is unlikely to occur. Perhaps the primary significance of resurgence is that its existence emphasizes that responses weakened by extinction are not absent from an individual's repertoire, even though those responses have not been observed for a substantial period. A change in stimulus conditions, a substantial increase in motivation for the reinforcer in question, or verbal mediation may lead to the reappearance of an extinguished response. In fact, the passage of a substantial period of time during which the response that is undergoing extinction is not emitted may be sufficient for the response to recur. This phenomenon sometimes is called spontaneous recovery. If a response that has been exposed to extinction is reinforced, the troublesome behavior can rapidly be reestablished. In essence, extinction controls troublesome behavior only so long as the procedure is consistently in effect.

Verbal mediation is another variable that may also limit an individual's sensitivity to ongoing extinction. Human behavior can be controlled by rules, which are descriptions of relations among responses and stimuli (objects and events). If a rule describes a relation between a particular kind of behavior and its consequences that is contrary to the relation that actually obtains in a person's world, then following that rule will limit the sensitivity of the person's behavior to actual environmental events. As an example, consider a college student participating in an experiment who is told before the experiment begins to "press the e key fast to earn points exchangeable for money." This individual is likely to do so, even if pressing the key slowly produces far more points and, in the absence of the verbal instruction, the student would readily learn to press slowly. The verbal rule probably would also reduce the student's sensitivity to extinction. That is, if conditions were first arranged so that pressing the "e" fast produced points (reinforcement), then they were changed so that no points were available (extinction), substantially more responding would occur during extinction if the person were given the rule at the start of the experiment than if this were not done.

Like people in contrived experimental settings, people exposed to therapeutic applications of extinction can generate, or be given, rules that reduce their sensi-

tivity to the procedure. Therapists need to be aware of this possibility and to take steps to ensure that the extinction procedure is adequately explained, which would tend to foster rules and rule-governed behavior consistent with therapeutic objectives. Therapists also need to be aware that inappropriate rules can interfere with the effectiveness of extinction, and take steps to prevent this from occurring.

V. CASE ILLUSTRATION

Extinction is an easy procedure to understand, although it is often a difficult procedure to implement consistently. As a case in point, consider the parents of a preschooler who sought help in dealing with their child's persistent demands for attention at bedtime. During consultation with a psychologist, it became apparent that each night after his father or mother took the boy to bed at 9, he made repeated requests that, if granted, increased the time spent with his parents.

For example, he might ask to go to the bathroom, to have a drink of water, or to have another story read. Many such requests occurred in sequence, and it was not unusual for the parents to spend over 2 hours in attempting to get the child asleep. Typically he fell asleep while listening to the last in a long sequence of stories. Occasionally, when his parents were very tired, they allowed the boy to sleep in their bed. On these occasions, few demands were made and everyone got a longer night's sleep. This arrangement did not suit the parents, however. Neither did the lengthy bedtime routine, which left them frustrated and exhausted.

The psychologist asked the couple to record how long it took them to get the child into bed and asleep each night for a week, then suggested a simple intervention using extinction combined with some environmental arrangements. Specifically, a modified bedtime routine was recommended, in which the parents were instructed to approach the child each night at 8:30 and say, "It's getting time for bed; go to the potty and have a drink, then we'll go to your bed and read two stories. After that, we'll all go to sleep." The psychologist recommended that the parents guide the child through these activities, using verbal or physical redirection as necessary, to minimize dawdling (i.e., avoidance of the undesired activity of going to bed). After story reading was over, the parents were to tell the child goodnight,

to remind him to remain in his bed, and then to kiss him and leave the room and not return. The psychologist cautioned the parents to expect temper tantrums (e.g., yelling out or throwing toys) and other misbehaviors. In the event the child left his room, the parents were to return him to his bed with little discussion. The parents were instructed to ignore crying and demands by the child for attention, and were warned that such behaviors could occur for relatively long time periods (e.g., 2 hours). The psychologist also warned the parents that the boy might engage in some aggressive behaviors during the procedure. Again, they were instructed to minimize interactions with the boy when dealing with such behaviors, and to return him to bed with as little interaction as possible.

The parents, somewhat discouraged, returned to the psychologist after 1 week. Each night the child had cried himself to sleep, and on the third night the boy began throwing toys around his room. On the fourth evening, he had torn the ear of his favorite cuddly bunny and had cried and screamed for 3 hours before sleeping. On a positive note, on the evening before returning to the therapist's office, the boy had cried for only 30 minutes before sleeping. And, according to the parents, the crying was less intense. The psychologist praised the parents for their diligence and consistency, and encouraged them to try the intervention for another week.

When the parents visited the psychologist the following week, the boy was following the bedtime routine without protest. The parents reported satisfaction with the outcome of the intervention, but indicated that implementation of the procedure was emotionally and physically draining and that they often were tempted to abandon it and give in to the child's demands. Had they done so on even a single occasion, their subsequent task would have become considerably harder. For extinction to work, it must be implemented with utter consistency.

VI. SUMMARY

Operant extinction is a procedure in which reinforcement of a previously reinforced behavior is discontinued. Published studies have demonstrated that the procedure, which is conceptually sound and logically simple, is effective in reducing a wide range of troublesome operant behaviors in a variety of clients. Although extinction is a useful and generally accepted response-

reduction procedure, it can be difficult to arrange consistently. Moreover, troublesome behavior may persist for a substantial time, and even briefly increase in rate and intensity, under extinction. These and other considerations occasionally preclude the use of extinction to deal with particular behavioral problems.

See Also the Following Articles

Avoidance Training ■ Fading ■ Negative Punishment ■ Negative Reinforcement ■ Operant Conditioning ■ Positive Punishment ■ Positive Reinforcement

Further Reading

- Ducharme, J. M., & Van Houten, R. (1994). Operant extinction in the treatment of severe maladaptive behavior. *Behavior Modification, 18*, 139–170.
- Iwata, B. A., Pace, G. M., Cowdery, G. E., & Miltenberger, R. G. (1994). What makes extinction work: Analysis of procedural form and function. *Journal of Applied Behavior Analysis, 27*, 131–144.
- Lerman, D. C., & Iwata, B. A. (1996). Developing a technology for the use of operant extinction in clinical settings: An examination of basic and applied research. *Journal of Applied Behavior Analysis, 29*, 345–382.

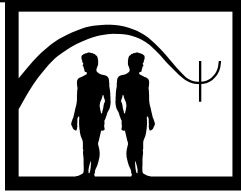

Eye Movement Desensitization and Reprocessing

Francine Shapiro

Mental Research Institute,
Palo Alto, California

Louise Maxfield

Lakehead University, Ontario, Canada

- I. Description of Treatment
 - II. Theoretical Bases
 - III. Empirical Studies
 - IV. Summary
- Further Reading

GLOSSARY

adaptive resolution A state that occurs as a result of complete information processing; learning takes place, information is stored with appropriate affect and is available to guide future action.

desensitization Elimination or reduction of anxiety elicited by specific environmental or internal stimuli.

dysfunctionally stored information A situation that occurs as a result of incomplete processing; information is stored in a memory network with a highly negative emotional charge and isolated from more adaptive information.

information processing The process by which new perceptual information is sorted, connected with associated memory networks, encoded, and stored in memory.

information processing system A physiologically based system that is geared to process information to a state of adaptive resolution.

memory networks Neurobiological associations of related memories, thoughts, images, emotions, and sensations.

post-traumatic stress disorder An anxiety disorder that can occur following exposure to a traumatic event. Symptom criteria include intrusive memories, avoidance of reminders, emotional numbing, physiological hyperarousal, and functional impairment.

reprocessing The process of forging new associative links between dysfunctionally stored information and adaptive in-

formation, resulting in complete information processing and adaptive resolution.

stabilization State of equilibrium maintained by the client prior to reprocessing of distressing events; includes safety, affect regulation, and impulse control.

state-dependent learning Information that is learned in a specific physiological state and is most accurately recalled when the individual is in the same or similar physiological state and is most accurately recalled when the individual is in the same or similar physiological state.

Eye Movement Desensitization and Reprocessing (EMDR) is an eight-phase treatment approach that facilitates resolution of distressing historical events, desensitization of present triggering stimuli, and acquisition of desired behaviors. While originally designed to alleviate the distress associated with traumatic memories, EMDR is now implemented within comprehensive treatment plans to address a range of experientially based complaints. This entry provides an overview of the treatment process, its conceptual underpinnings, the studies of treatment efficacy, and EMDR's various clinical applications.

I. DESCRIPTION OF TREATMENT

Eye Movement Desensitization and Reprocessing (EMDR) is an integrative psychotherapy treatment that synthesizes elements of many orientations, in-

cluding psychodynamic, cognitive-behavioral, body-based, person-centered, and interactional therapies, and that incorporates several unique elements, including eye movements or other bilateral stimulation. EMDR appears to expedite the accessing and processing of disturbing memories and an attendant learning process. It focuses directly on all the perceptual components of memory (cognitive, affective, somatic) and creates new links with the adaptive information contained in other memory networks. This reprocessing results in an adaptive resolution, as indicated by the desensitization of triggers, elimination of emotional distress, elicitation of insight, reformulation of associated beliefs, relief of accompanying physiological arousal, and enhancement of personal growth and functional behaviors.

A. The Information Processing System

The physiologically based information processing system can be compared to other body systems such as digestion in which the body extracts nutrients for health and survival. The information processing system sorts perceptions of experience and stores memories in an accessible and useful form. Information processing is essential for learning and involves the forging of associations with experiences previously stored in memory. The strong negative affect or dissociation induced by a traumatic event may impair information processing, inhibiting associative links with adaptive information in other memory networks. The memory is then dysfunctionally stored without appropriate associative connections and with negative emotion and physical sensations intact. When triggered by similar situations the memory is reexperienced, rather than simply recalled as an historical event. A prime example involves the intrusive thoughts, emotional disturbance, and negative self-referencing cognitions of post-traumatic stress disorder (PTSD).

B. The Eight Phases of Treatment

During EMDR, the unprocessed dysfunctionally stored material is linked to more adaptive material, and new associations are made. The client attends to emotionally disturbing material in multiple brief doses while simultaneously focusing on an external stimulus (e.g., therapist-directed eye movements, hand-tapping, bilateral tones). EMDR's three-pronged protocol ensures that all past, present, and future aspects of the problem are

thoroughly addressed. Current conditions that elicit distress are processed to eliminate sensitivity, and a template for appropriate future action is incorporated to enhance positive behaviors and skill acquisition.

Contrary to a common misconception, EMDR is not a simple by-the-book procedure dominated by the use of repeated eye movements, but rather an integrated therapy incorporating aspects of many traditional psychotherapeutic orientations. EMDR structures these elements in a unique combination to enhance information processing. It utilizes an eight-phase approach, with each phase augmenting and consolidating positive treatment effects. In addition, specific protocols guide the application of EMDR to a variety of clinical complaints.

1. Phase One: Client History and Treatment Planning

During Phase One the therapist takes a full history, assesses the client's readiness for EMDR, and develops a treatment plan. The therapist evaluates aspects such as diagnosis, comorbidity, suicidality, dissociation, existing support system, life stability, presence of current stressors, physical health, secondary gain issues, and substance use. Although acquisition of a full history and evaluation of the overall clinical picture are standard psychotherapy procedures, they have an additional purpose in EMDR and are used to identify suitable targets for treatment.

Targets are chosen according to theories about information processing. It is assumed that (a) processing may be accompanied by intense emotions; (b) processing of memory networks may activate related prior incidents; (c) if related early events are not processed, treatment may be incomplete and possibly ineffective; (d) treatment effects are likely to generalize to similar events, but not to unrelated incidents; and (e) processing should include a focus on past events, present stimuli, and future situations or behaviors. Therefore, treatment targets can include affect management resources, recent distressing events, current situations that stimulate emotional disturbance, historical incidents, and the development of specific skills and behaviors.

Targets are prioritized for sequential processing and evaluated according to patterns of generalization within memory networks. Treatment effects tend to generalize from memory to memory when features are similar. Only one representative event from a cluster of similar experiences (e.g., several related instances of molestation by the same perpetrator) may need to be treated. Such generalization of treatment effects should not be expected if the client reports a variety of dissim-

ilar events and triggers, necessitating that each of these be reprocessed separately.

When appropriate, events are selected for processing in chronological order, beginning with the earliest. It is assumed that a later related event will contain elements that are connected to the earlier incident and that it will not be adequately processed until such elements are resolved. For example, “Trina” was the first person on the scene after a car had crashed on a deserted road and rolled into a river. She rescued the passengers who were still alive. Afterward, she blamed herself for the deaths of those who had not survived. While processing this with EMDR, she realized how similar this was to the drowning death of a younger sibling when she was 5 years old: Her parents had blamed her for the tragedy. The emotional content of the childhood event was fueling her emotional response to the current incident. After EMDR was used to target the issues of responsibility for her sibling’s death, the distress related to the current accident resolved rapidly. (*Note:* Trina’s story and subsequent clinical vignettes are based on actual clients, with names and minor details changed to protect confidentiality.)

2. Phase Two: Preparation

Phase Two involves establishing the therapeutic relationship, setting reasonable levels of expectation, educating the client about his or her symptoms and about EMDR, and ensuring that the client demonstrates adequate stabilization. Stabilization is a state of equilibrium achieved prior to the processing of distressing material and includes safety, affect management skills, and self-control. Clients with histories of childhood trauma/neglect often have deficits in affect regulation and impulse control and may require substantial preparation. Similarly, avoidance behavior exhibited by anxiety-disordered clients must be addressed before serious attempts at reprocessing can begin.

Client strengths are developed by combining relaxation, imagery, and EMDR in interventions that assist the client in acquiring new skills and resources. For example, EMDR is commonly used to enhance “safe place” visualizations. Such self-calming techniques are an important element of treatment and are used to “close” incomplete sessions, as well as to maintain client stability between and during sessions. During Phase Two, the client is prepared to “just notice whatever happens” and to maintain a balanced observation/participation position. This is encouraged by the use of helpful metaphors (e.g., to imagine being on a

train and to think of the disturbance they may be experiencing as merely passing scenery).

Many of the procedural elements in subsequent phases of EMDR treatment incorporate elements to enhance stabilization. For example, during the desensitization phase, frequent brief exposures to the distressing experience encourage a sense of psychological mastery and stability and may counter the avoidance reaction that accompanies and maintains the pathology. The client receives supportive statements from the clinician in a safe context, fostering positive counterconditioning.

3. Phase Three: Assessment

In the third phase, the client and therapist select a specific memory to address during the session and identify the associated mental image, beliefs, emotions, and physical sensation, taking baseline response measures. The assessment phase contains steps designed to fully activate the dysfunctional memory network. First, the representative and/or most salient mental image of the event is identified. Next, the therapist helps the client to identify the current negative belief about him/herself that is related to the target memory (e.g., “I’m powerless” or “I am worthless”). It is formulated in the present tense to activate the disturbing information and to assist clients in recognizing the impact of the past event on current self-concept. This is the first step in recognizing the irrationality of their cognitive interpretation of themselves in relation to the event. While the words “I was powerless” may be an appropriate description of the past event, the words “I *am* powerless” are considered an irrational cognition because the person is not *currently* powerless. The words verbalize the current belief and affect experienced by the client when the dysfunctionally stored memory is accessed.

After this, the therapist helps the client to identify a desired positive belief that expresses a sense of empowerment or value in relation to the past event, such as “I’m competent” or “I’m lovable.” The client rates how accurate this positive belief feels on the Validity of Cognition Scale (VOC), where 1 represents “completely false” and 7 represents “completely true.” This is not an intellectual assessment of accuracy but rather a felt sense of how true the cognition feels when paired with the target incident. The VOC rating provides both client and clinician with a baseline with which to assess a given session’s progress, thereby further promoting client treatment adherence. It also increases clients’ awareness of their cognitive distortion and offers a “light at the end of the tunnel,” thereby encouraging

and motivating them to stick with the treatment. This process forges preliminary associative links between the state-dependent memories and the emotionally corrective information contained in the positive cognition and may expedite information processing.

In the fourth step, the image and the negative belief are paired to facilitate access to the stored memory of the trauma. The client identifies the emotions that are elicited by the memory and rates his or her level of distress on the Subjective Unit of Disturbance (SUD) Scale, where 0 is “calm” and 10 is “the worst possible distress.” Explicitly labeling the emotion allows the clinician to (a) offer the appropriate verbal support, (b) anticipate any beliefs about emotions that might block processing and that therefore need to be addressed, and (c) establish a response baseline. It also allows both client and therapist to recognize changes in the type of emotion experienced during the session. Next, the client identifies and locates the body sensations that accompany the disturbance. During EMDR, clients are encouraged to concentrate for prescribed periods of time on the physical sensations associated with their traumatic imagery. This focus may allow them to identify the purely sensory effects (e.g., physical pain) of the trauma and to separate them from the cognitively laden affective interpretations (e.g., I am helpless) of these sensations.

4. Phase Four: Desensitization

During the desensitization phase of EMDR, adaptive processing (i.e., learning) takes place. The client is instructed to focus on the visual image, the identified negative belief, and body sensations, and then to “Let whatever happens, happen.” He or she maintains this internal focus while simultaneously moving the eyes from side to side for 20 or more seconds (depending on nonverbal cues), following the therapist’s fingers as they move across the visual field. Other bilateral stimuli (e.g., hand-tapping, aural stimulation) can be used instead of eye movements. After the set of eye movements, the client is told “Blank out (or “Let go of”) the material, and take a deep breath,” and then is asked “What do you get now?” Depending on what emerges (image, thought, sensation, or emotion), the clinician then directs the client’s attention to the appropriate target for the next set of eye movements. This cycle of alternating focused attention and client feedback is repeated many times according to specified procedural guidelines that address various aspects of the memory network and is typically accompanied by shifts in affect, physiological states, and cognitive insights.

Because EMDR uses a nondirective free association method, some clients spend very little time being exposed to the details of the presenting problem. They may rapidly and spontaneously access a succession of related thoughts, images, emotions, sensations, and memories. These associations to the various components of the targeted memory network and other related networks are indicative of the active reprocessing of dysfunctionally stored material. For example, having started with a memory of his mother beating him, “John” recalled many incidents of his mother’s cruelty, her vicious criticisms, humiliating him in front of his friends, laughing at him. He progressed through a range of intense emotions (anger, fear, sadness, shame), with accompanying physiological shifts. John experienced a number of insights, including the realization that he frequently repeated his mother’s harsh criticisms in his own internal dialogue. Throughout the session the therapist remained almost entirely silent, gently asking, “What do you get now” and encouraging John to “Just notice” and to “Stay with that.” If John’s processing had stalled, the therapist would have used specialized interventions worded and timed in a specific manner to reactivate processing.

5. Phase Five: Cognitive Installation

As negative imagery, beliefs, and emotions become diffuse and less valid, positive ones become stronger and more salient. This transformation appears to result from a shift in how the memory is stored with new associations to more adaptive information. The fifth phase occurs after the targeted issue is resolved and the accessed memory spontaneously arises without distress. This phase allows for the expression and consolidation of the client’s cognitive insights. For many clients it is characterized by a profound change in self-concept that entails an integration of self-acceptance and new positive and realistic self-perceptions. In this phase, the original target is paired with the most enhancing positive cognition during sets of eye movements. This could be the belief designated to replace the original negative self-belief or a more therapeutically beneficial belief that emerged during the desensitization phase. The focus is on incorporating and increasing the strength of the positive cognition until strong confidence in the belief is apparent (e.g., VOC of 6 or 7). For example, while a rape victim may enter therapy “knowing” that she is not to blame, the installation phase is not considered complete until she truly “feels” the truth of this self-evaluation.

6. Phase Six: Body Scan

In Phase Six, the clinician asks clients, while focusing on the image and positive cognition, to notice if there is any tension or unusual sensation in the body. Because dysfunctionally stored information is experienced physiologically, processing is not considered complete until the client can bring the previously disturbing memory into consciousness without feeling any significant body tension. Any residual negative sensations detected by the body scan are targeted with eye movements until the tension is relieved. Such body sensations can be linked to unprocessed aspects of the memory network. For instance: After an apparently complete EMDR session targeting a car accident, "Sam" reported a strange feeling in his foot during the body scan phase. This sensation was targeted with EMDR and resulted in him recollecting a forgotten aspect of the accident. His foot had been stuck for a brief period after the collision, and he had felt trapped and frightened. After processing this with EMDR, the foot sensation disappeared, and SUD and VOC ratings were consolidated at optimal levels.

7. Phase Seven: Closure

In this phase, the therapist determines whether the psychological material has been adequately processed and, if not, assists clients with the self-calming interventions developed in Phase Two. The client is told by the therapist that other material might emerge after the session and is asked to maintain a journal to record any disturbance that arises, such as nightmares or flashbacks, or related material such as insights, memories, emotions, and dreams. The form that this journal takes parallels the assessment stage of treatment (Phase Three) and identifies possible targets for future sessions. This process of recognizing and recording patterns of reaction extends treatment effects to real-life disturbing events and encourages a sense of self-mastery and observation, thus facilitating between-session stabilization.

8. Phase Eight: Reevaluation

Reevaluation takes place at the beginning of every EMDR session following the first. In this phase, the therapist determines whether the treatment gains from the previous session have been maintained by eliciting the previously processed targets and assessing the current emotional, cognitive, and physiological responses. The clinician reviews the client's journal to evaluate the degree to which treatment effects have generalized or need further attention, and to identify new issues that

need to be addressed. For example, after processing the molestation by her grandfather, "Lisa" began thinking about her grandmother who had refused to believe that he was an offender. This new material became a treatment target.

In addition to relying on behavioral reports, the therapist is encouraged to use various standardized self-report measures, such as the Impact of Event Scale or the Beck Depression Inventory, to monitor changes in specific symptoms. The goal of EMDR therapy is to produce the most substantial treatment effects possible in the shortest period of time, while simultaneously maintaining client function and preventing emotional overload. Therefore, thorough ongoing evaluation of reprocessing, stability, behavioral change, and integration within the larger social system is essential. The eight phases of treatment may be completed in a few sessions or over a period of months, depending on the needs of the client and/or the seriousness of the pathology.

II. THEORETICAL BASES

A. The Adaptive Information Processing Model

The Adaptive (or Accelerated) Information Processing (AIP) model which guides EMDR practice assumes that humans possess a physiologically based information processing system, which, under normal circumstances, naturally responds to and resolves everyday minor disturbances. Information is normally processed to an adaptive state where connections to appropriate associations are made, emotional distress is relieved, experiences are used constructively, and learning takes place. Information is understood to be stored in a system of memory networks, which are neurobiological structures containing related memories, thoughts, images, emotions, and sensations. For example, "George" was shocked and angry when his employer criticized him and his work product. George mentally reviewed this interaction by accessing stored information about the quality of his work, his employer's stressors, and his own competence. This allowed him to assess the situation and to make decisions about his course of action. He dismissed the personal negative comments because they were discordant with information about his abilities. Such connections are made during waking state and perhaps through the information processing mechanisms of rapid eye movement (REM) sleep.

After a traumatic event, persons who were high functioning prior to the incident generally assimilate the perceptual experience and reestablish themselves. For others, an incident of sufficiently high negative valence can result in little integration with existing positive or more adaptive information stored in networks. The AIP model proposes that pathology results when experiences are not adequately processed and the memories are dysfunctionally stored with the perceived distressing affects and physical sensations. The traumatic memory network becomes effectively isolated, and no new learning takes place.

PTSD is not the only mental disorder known to have an etiological event; phobias, panic disorders, depression, dissociation, and personality disorders are sometimes related to precipitating incidents. Deficit experiences, such as neglect, rejection, or humiliation, that occur during developmental windows can function as “small-t traumas.” With frequent repetition of such events, the memory network becomes predominant, organizing similar experiences in associated channels of information and precipitating a continued pattern of behavior, cognition, and related identity structures. Such persons often develop rigid defenses, a limited sense of self, impaired interpersonal function, and affect dysregulation.

Because of the lack of adequate assimilation of these events into the larger associative network, similar experiences in the present, including a variety of triggers implicit in the memory network, can elicit these dysfunctional affects and negative appraisals. It is further hypothesized that the inadequately processed information is stored in a “state-dependent” fashion. The information is easily activated when the individual experiences affect or a physiological state similar to that of the memory network. Feeling afraid, for example, activates fear-related information, while feeling depressed activates information about hopelessness and helplessness. The flashbacks of PTSD often contain immediate sensory information: the smell of the rapist’s breath, the feel of his rough hands on bare skin. Sometimes the material that is activated is primarily affective, such as fear or shame.

B. Reprocessing Information

The AIP model proposes that pathology arises when the information associated with seminal events is inadequately processed. Consequently, these disorders should respond to treatment that enhances reprocessing of the dysfunctionally stored information. The goal

of EMDR therapy is to stimulate information processing by accessing the dysfunctionally held information and forging new connections with more adaptive information. It is assumed that when appropriately stimulated and maintained in dynamic form, the inherent healing processes of the information processing system will result in a positive resolution, manifest in affective, cognitive, and behavioral changes and comprehensive learning.

The AIP model has four principles that describe and predict the effects of adaptive processing.

1. Direct, Nonintrusive, Physiological Engagement with the Stored Pathological Elements Is Possible

The dysfunctional storage of disturbing memory elements is viewed as the physiological basis of the pathology. Rather than targeting the client’s reaction to the earlier event, EMDR focuses on the memory components (image, affect, cognition, sensations). The treatment protocol is designed to specifically access components of the memory in such a fashion that the material is available for complete reprocessing.

2. The Information Processing System Is Intrinsic and Adaptive

The system appears to be configured to process information and restore mental health analogous to the way the body frequently recovers from physical injuries. This belief is the basis of EMDR’s client-centered model, which assumes that if the information processing system is appropriately stimulated, the client’s cognitions and affect will move to an adaptive level with minimal therapist intrusion.

3. As the Embedded Information Is Processed, Identity Constructs Change

Pathological personality characteristics are understood to be entrenched in dysfunctionally stored information. Therefore, it is assumed that when this information is adequately processed, there is a concomitant shift in clients’ sense of self-worth and efficacy, with structural alterations in related personality characteristics, evident in changes in self concept, interactions with others, and behaviors.

4. Reprocessing Results in Rapid Changes

EMDR facilitates therapeutic effects through the adaptive connection of associated neurophysiological networks in the information processing system. Recent findings in neurobiology support the notion that treat-

ment outcomes can be rapid, regardless of the amount of time since the original distressing event.

C. Mechanisms of Action

Although it is apparent that EMDR expedites information processing, the exact mechanisms by which this occurs are unknown. Speculation about the role of eye movements abounds. A wide variety of primary research studies dating from the 1960s through the present have indicated a correlation between eye movements and shifts in cognitive content and attribution. Several hypotheses attempt to explain how they may contribute to information processing within the EMDR procedures: (1) eye movements disrupt the function of the visuospatial sketchpad and interfere with working memory; (2) they elicit an orienting response that stimulates an instinctive interest–excitement affect creating new associative links with the dysfunctionally stored information; (3) they evoke a relaxation response, or a new set of physiological states and responses, creating new associative links with the dysfunctionally stored information; (4) they activate neurological processes that mimic REM sleep-type function and its information processing mechanisms; and (5) they act as a distractor that titrates the emotional overload and encourages client engagement.

Although it is assumed that all aspects of the EMDR structured procedures and protocols contribute to its effect, two other possible mechanisms of action currently under investigation are its use of repeated brief client-directed exposure and free association. In addition to the primary research on physiological mechanisms, clinical observations have contributed to the present treatment structure. For instance, it appears that developing the ability to mentally delimit and control disturbing internal stimuli may provide clients with a sense of mastery and decrease distress about their symptoms. Use of short doses may also counter the avoidance reaction that is likely to accompany and maintain the pathology. Most importantly, information processing appears to be facilitated by repeatedly eliciting related information after each exposure. The free association component appears to activate the entire memory network and to forge connections with other associated networks. This results in the complete reprocessing of the dysfunctionally stored information. The nondirective free association method used in EMDR allows for the therapeutic focus to shift from the original targeted event to other related past experiences and is very different from exposure therapies that em-

ploy a chronological, concentrated focus on the traumatic event.

The findings of dismantling research are limited by methodological problems. Although component studies with clinically diagnosed PTSD subjects provide preliminary indications that an eye movement condition is more effective than control conditions, such studies have typically used small samples (e.g., 7 to 9 persons per condition) with inadequate power, and selected inappropriate controls. Truncated procedures are common; one study for example, provided only 145 seconds of treatment. The results of such studies are inconclusive and comprehensive research is required.

III. EMPIRICAL STUDIES

A. Posttraumatic Stress Disorder

Because of its claims of rapid effective treatment, EMDR has been subjected to many empirical tests and to much scientific scrutiny. It has been extensively researched in the treatment of PTSD. All but one of the research studies that used civilian participants found EMDR to be efficacious in the treatment of PTSD, and the one combat veteran study that provided a full course of treatment also revealed EMDR to be efficacious. Generally, these studies found substantial clinical effectiveness, reporting a decrease in PTSD diagnosis for 70 to 90% of the civilian participants after three or four sessions and in 78% of combat veteran participants after 12 sessions. There have been several other combat veteran EMDR studies, but these addressed only one or two memories in this multiply traumatized population, and thus their findings regarding efficacy are equivocal. Nevertheless, the effect sizes achieved in these studies were similar to those achieved in cognitive-behavioral therapy (CBT) studies with combat veterans.

In all but one controlled study, EMDR appeared to be equivalent in treatment outcome to CBT comparison conditions and was reported to require fewer direct treatment and/or homework hours. There are reports that EMDR may be better tolerated by clients than traditional exposure, perhaps because it typically results in a rapid in-session decrease in anxiety (as measured by SUD ratings). When EMDR was compared to other treatments such as relaxation therapy, standard mental health treatment in an HMO, and active listening, it was found to be superior on numerous measures. Two of these studies compared EMDR in actual field settings

to treatments that are commonly provided, and thus maximized the external validity of the results.

In future studies with PTSD populations, it is recommended that exposure therapy, cognitive therapy, Selective Serotonin Reuptake Inhibitors, and EMDR be compared with one another, with special attention paid to efficacy, effectiveness, efficiency, attrition, as well as clinician and client preference (e.g., tolerance and comfort) for the type of therapy being used.

B. Diverse Clinical Applications

In large-scale studies of EMDR treatment with trauma populations, direct internal comparisons were made for those with and without PTSD diagnosis. The equivalent findings on numerous affective and cognitive measures lend credence to the notion that EMDR can be effectively used to process disturbing experiences that may contribute to a variety of clinical complaints. Although positive reports have been published on the application of EMDR to the treatment of (1) personality disorders, (2) dissociative disorders, (3) various anxiety disorders, and (4) somatoform disorders, controlled research is needed to confirm the efficacy of these applications. Some of the findings are promising. For example, although body dysmorphic disorder is known to be relatively intractable to treatment, researchers in one case series study reported that five of seven patients treated with EMDR no longer met diagnostic criteria after one to three sessions.

The evidence for the effectiveness of EMDR with phobias and panic disorder is inconclusive. Many of the research studies investigating the use of EMDR with these disorders have been compromised by the incomplete application of the eight-phase approach. An analysis of procedural fidelity in the phobia studies determined that low adherence to EMDR protocol was associated with poor clinical outcome.

IV. SUMMARY

EMDR is an integrative psychotherapy approach implemented within comprehensive treatment plans to address a range of experientially based complaints. It is formulated to expedite the accessing and processing of disturbing memories by forging new links between the perceptual components of memory and adaptive information contained in other memory networks. Complete reprocessing is evident in the desensitization of

triggers, elimination of emotional distress, elicitation of insight, reformulation of associated beliefs, relief of accompanying physiological arousal, and acquisition of desired behaviors.

During EMDR the client focuses on an external stimulus (e.g., therapist-directed eye movements, hand-tapping, aural stimulation) while simultaneously attending, in brief sequential doses, to emotionally disturbing material that is elicited through free association. Structured procedures based on memory association patterns enhance information processing and are embedded in a comprehensive eight-phase approach. Specific protocols ensure that all past, present, and future aspects of the clinical picture are thoroughly addressed.

The Adaptive Information Processing model posits a physiologically based information processing system that has a tendency to move toward health by processing information to a state of adaptive resolution. Various mental disorders are viewed as caused by information from traumatic events which are inadequately processed. The negative affects and cognitions contained in the memory network are frequently elicited by current life stimuli, thus precipitating maladaptive behaviors and self-concepts. Consequently, such characteristics and disorders should respond to treatment that enhances reprocessing of the dysfunctionally stored information.

Currently, EMDR has been found efficacious in the treatment of PTSD. Civilian participants have shown a 70 to 90% decrease in PTSD diagnosis and a substantial improvement in reported symptoms after three or four sessions. The only combat veteran study that provided a full course of treatment also revealed EMDR to be efficacious with a 78% decrease in PTSD diagnosis after 12 sessions. In all but one controlled study, EMDR appeared to be equivalent in treatment outcome to CBT comparison conditions and was reported to require fewer direct treatment and/or homework hours. Although there are numerous anecdotal and case study reports documenting EMDR's effectiveness in the treatment of other disorders, controlled studies are lacking or inconclusive, and future research is required to establish the parameters of EMDR's usefulness with these populations.

See Also the Following Articles

Post-Traumatic Stress Disorder ■ Self-Control Desensitization
■ Systematic Desensitization

Further Reading

- Chemtob, C. M., Tolin, D. F., van der Kolk, B. A., & Pitman, R. K. (2000). Eye movement desensitization and reprocessing. In E. A. Foa, T. M. Keane, & M. J. Friedman (Eds.), *Effective treatments for PTSD: Practice guidelines from the international society for traumatic stress studies* (pp. 139–155, 333–335). New York: Guilford Press.
- Greenwald, R. (1999). *Eye movement desensitization reprocessing (EMDR) in child and adolescent psychotherapy*. New York: Jason Aronson.
- Lipke, H. (1999). *EMDR and psychotherapy integration*. Boca Raton, FL: CRC Press.
- Lovett, J. (2000). *Small wonders: Healing childhood traumas with EMDR*. New York: Simon and Schuster.
- Manfield, P. (Ed.). (1998). *Extending EMDR: A casebook of innovative applications*. New York: Norton.
- Shapiro, F. (1999). Eye movement desensitization and reprocessing (EMDR): Clinical and research implications of an integrated psychotherapy treatment. *Journal of Anxiety Disorders, 13*, 35–67.
- Shapiro, F. (2001). *Eye movement desensitization and reprocessing: Basic principles, protocols and procedures*. New York: Guilford Press.
- Shapiro, F. (Ed.). (2002). *EMDR as an integrative psychotherapy approach*. Washington, DC: American Psychological Association Press.
- Shapiro, F., & Forrest, M. (1997). *EMDR*. New York: Basic Books.
- Tinker, R., and Wilson, S. (1999). *Through the eyes of a child: EMDR with children*. New York: Norton.



Fading

Cynthia M. Anderson

West Virginia University

- I. Description of Fading
- II. Theoretical Bases
- III. Using Fading
- IV. Empirical Studies
Further Reading

GLOSSARY

fading Systematic process of removing prompts.

prompt Stimulus used to increase the likelihood the target response will occur at the appropriate time.

stimulus prompt Antecedent stimulus added, removed, or otherwise altered to increase the likelihood the target response will occur.

response prompt Response emitted by the individual conducting training to increase the likelihood the target response will occur.

I. DESCRIPTION OF FADING

Interventions used in applied practice take a variety of forms depending on such variables as the presenting problem and the theoretical orientation of the practitioner. One strategy that is used for a variety of presenting problems and across orientations is teaching the client a new skill or behavior. For example, a practitioner working with a client who is “shy” might teach the client to maintain eye contact with others and to initiate conversations. Initially the practitioner likely will have to remind the client to emit these new behav-

iors, however the hope is that, over time, the client will need less frequent reminders and will begin to emit the newly learned skills in a variety of situations. The process of gradually decreasing reminders—often referred to as prompts—such that the client emits the target response independently is called fading. Several fading procedures exist, and the specific procedure used depends on the strategy of prompting that was used to teach a new behavior. Thus, this article begins with a discussion of prompting strategies. Next, specific fading strategies are presented. Examples are used throughout to facilitate understanding of fading procedures in applied settings.

Individuals typically are taught new responses through the use of prompts. For example, when a person who is not proficient in computer use purchases a computer, that person might ask a colleague to help assemble the computer. The colleague might verbally prompt the individual through the steps of assembly. Alternatively, the individual might simply follow the instructions included with the computer. Such prompts—behaviors emitted by the trainer to guide specific responses—are called response prompts. The second type of prompt that might be used is a stimulus prompt. Stimulus prompts involve changing some aspect of the situation that should evoke the desired behavior. Continuing with the computer example, computer companies often color code connections such that connector cables are the same color as the relevant computer port. In this case, the company is adding something—color codes—to the existing items—connection cables and ports—to increase the likelihood

the user will correctly assemble the machine. Regardless of the type of prompting used, response prompts or stimulus prompts, the eventual goal of most instructional programs is to have individuals emit the correct response without the use of prompts. To accomplish this goal, the prompts must be gradually faded. Fading involves systematically removing prompts over time.

II. THEORETICAL BASES

The process of fading is derived from the behavior analytic literature. Fading procedures have been used with nonhumans as well as humans however it most often is seen in programs designed to teach individual's new skills. Fading incorporates several principles of operant conditioning including the use of reinforcement and stimulus control. Reinforcement is defined as the response-contingent delivery (or removal) of a stimulus that increases the likelihood the behavior will occur again in the future. As is discussed later, reinforcement must continue to occur following correct responding throughout all steps of a fading procedure. Stimulus control also is relevant to fading procedures. Stimulus control develops when a response is more likely to occur in the presence of a particular stimulus (e.g., a prompt) than in its absence because the response has been followed by reinforcement most often in the presence—but not absence—of that stimulus. The ultimate goal of a fading procedure is to bring the target response under stimulus control of the naturally occurring cue—the event that the instructor hopes will naturally evoke the target response.

III. USING FADING

Teaching a new behavior is most often accomplished through the use of response prompts. When using response prompts, the practitioner uses some sort of cue to evoke a behavior. Cues might be relatively simple, such as looking in a certain direction, or making a gesture, or more invasive, such as touching the learner's shoulder or physically guiding the learner to move in a certain way.

A. Fading Response Prompts

When a new response is taught through the use of response prompts, fading is accomplished through one of three procedures: time delay, least-to-most prompts, and

most-to-least prompts. Time delay involves allowing the natural cue to occur, and then waiting several seconds before prompting. For example, when teaching deep breathing to an individual with anxiety, the natural cue to use deep breathing would be the occurrence of any anxiety producing stimuli, perhaps the approach of an individual of the opposite gender. In training sessions, when such a person approached the client, the practitioner would wait for several seconds before prompting the individual to begin deep breathing—the goal being to see if the client would initiate deep breathing independently. Over time, the practitioner would gradually delay the prompt for even longer durations.

Like time delay, least-to-most prompt fading is a procedure that provides the learner with an opportunity to independently emit the correct response prior to prompting. The difference between the two concerns is the variety of prompts that might be used in training: time delay typically involves only using one type of prompt (e.g., a verbal prompt), least-to-most prompting allows the trainer to use the most intensive level of prompting needed to help the learner exhibit the correct behavior. When using least-to-most prompting, the trainer begins with the least intrusive type of prompt possible and gradually increases the intrusiveness of the prompt until the learner emits the correct response. Consider again the individual learning deep breathing. The natural cue to use deep breathing is the occurrence of an anxiety-producing event (e.g., approach of an individual of the opposite gender). If the anxiety-producing stimulus has been present for certain amount of time (e.g., 5 sec), and the client has not initiated deep breathing, the practitioner would prompt the client using the least intrusive level of prompting (e.g., a gesture, such as holding up the hand). If this prompt does not result in deep breathing, the practitioner would use a more intrusive prompt, such as verbally reminding the client to use deep breathing. If the client still did not begin to use the breathing exercise, the practitioner might place a hand on the client's shoulder—using a still more intrusive level of prompting.

The third commonly used prompt fading procedure is graduated guidance. Graduated guidance involves using the most intrusive level of prompting needed to prompt a response to occur, and then immediately removing the prompt when the individual is responding independently. For example, when teaching a child to ride a bicycle, a parent might walk closely behind the child, steadying the child whenever necessary. The parent might steady the child by placing a hand on the child's shoulder or, if needed, by actually holding the

handlebars and steering the bike for the child. Foxx and Azrin discuss in their 1973 work two procedures to be used in graduated guidance: shadowing and spatial fading. Shadowing involves closely following the learner's physical movements with your own body. For example, a parent teaching a child to ride a bicycle might walk next to the child and hold the child's hands directly above the child's shoulders, ready to steady the child if need be. Over time, the parent gradually moves the hands and body further away from the child. Spatial fading is used when the trainer gradually moves a physical prompt. Continuing the bicycle example, the parent might begin teaching the child by holding onto the handlebars with one hand to steer the bike, and steadying the child with the other hand. Over time, the parent might have the child steer the bicycle but continue to steady the child. Gradually the parent would provide the child with less and less physical support until the parent was walking beside the child, but not providing any support unless necessary. The parent would then move further away from the child, until the child was riding independently.

In contrast to the other types of prompt fading, most-to-least prompt fading does not initially provide the learner with an opportunity to respond independently. Most-to-least prompt fading is often used with individuals with severe cognitive disabilities. This type of prompt fading involves using the most intrusive level of prompting initially and then gradually reducing the level of guidance provided. For example, if an individual was being taught to make the bed, the trainer might initially use hand-over-hand guidance to have the individual make the bed. The trainer would gradually fade the physical prompt by decreasing the amount of physical pressure used to have the person make the bed. Over time, the trainer might fade to gestural prompts (e.g., pointing toward the pillows), and then to verbal prompts. Eventually, the sight of the unmade bed alone should evoke the response of making the bed.

B. Fading Stimulus Prompts

When the natural cue was changed to evoke behavior, stimulus prompts must gradually be faded. For example, if the behavior being trained is recycling, the natural cues should include items to be recycled (e.g., paper, pop can). Stimulus prompts that might be used in such a situation include signs telling people to recycle or placing multiple recycling vesicles in the building. The eventual goal is to transfer control of the response—recycling—from the prompt (e.g., signs) to the natural cue (e.g., used paper), such that individuals

Z	s
s	Z
s	Z
z	s
Z	s
s	Z

FIGURE 1 Example of stimulus fading procedure to teach an individual to discriminate between the letters “Z” and “S.”

will search for and use a recycling container on coming in contact with an item that can be recycled. Fading stimulus prompts involves either stimulus fading or stimulus shaping.

Stimulus fading often is used to teach an individual to discriminate between similar items. Consider the example of teaching students to discriminate between two similarly shaped letters, Z and S. One way that the discrimination might be taught is by increasing the size of one letter relative to the other. An example is shown in the top line of Figure 1. In this example, the correct response (stating, Z) is more likely to occur because the letter Z is much larger than S. Over time, the difference in size between the letters would be reduced until both letters were the same height (see Figure 1). Another use of stimulus fading occurs when additional prompts were added. For example, when children are learning addition or subtraction, teachers often use objects to represent the numbers the children are to add or subtract. To illustrate: if a worksheet instructs a child to add “4 + 3,” the worksheet might have a group of four apples next to a group of three apples (see Figure 2). Over time, the teacher could reduce the salience of the additional objects (e.g., apples) by making them smaller in size (see Figure 2).

The second method of fading stimulus prompts is stimulus shaping. Stimulus shaping is the procedure used when the shape of the prompt is changed and then is gradually made to look like the prompt the trainer wants to evoke behavior. Such a training procedure might be used to teach an individual who does not read to recognize the word “walk” (as might be seen on a pedestrian crossing traffic signal). The initial prompt used should be something that the learner recognizes,







5 + 2 = _____	
5 + 2 = _____	
5 + 2 = _____	
5 + 2 = _____	
5 + 2 = _____	
5 + 2 = _____	

FIGURE 2 Example of stimulus fading by decreasing the size of the additional prompt.

in this case a picture of a person walking with a line through it. Over time, the prompt is gradually be changed to the natural prompt (in this case, the word “walk”). More important, the shape of the prompt must be changed slowly, so that the learner is likely to continue to respond correctly. Parents often use stimulus shaping when teaching a child to independently ride a bicycle. The child typically begins to ride with the assistance of training wheels. When the parent sees that the child is able to maintain balance relatively well, the parent may remove one training wheel, leaving the other in place. Eventually the parent removes that training wheel as well, and the child is riding a bicycle without the assistance of any additional prompts.

C. Considerations in the Use of Fading

When individuals are learning a new response, prompting is most often used. Over time, the learner must come to emit the correct response without prompting. The removal of prompts is called fading and can involve either fading response prompts or fading stimulus prompts, and the specific type of fading depends on the prompting strategy used to teach new behaviors.

Regardless of the prompting (and hence fading) strategy used, several caveats are in order. Considerations include the criterion for completion of training, selection of a reinforcer, the starting point for training, and the steps of fading. First, the instructor must determine what the goal of training is. That is, what is the stimulus that will evoke behavior when fading is completed. Ideally,

the stimulus will occur naturally in the environment, so that responding will be maintained. For example, for a “shy” individual learning to maintain eye contact, fading might be considered complete if eye contact was maintained only after initiated by another person. However, if the majority of people the individual came in contact with did not initiate eye contact, the client’s newly learned skill would likely not maintain. In this case, the final cue for eye contact might be simply the presence of another person within 3 ft of the client (with the exception of certain situations, such as in elevators).

Once the goal of training is determined, it is important to select a reinforcer. The reinforcer must be something that the individual enjoys and that will serve to reward and maintain responding. When working with adults who are typically developing the reinforcer often is simply the ability to emit the target response. For example, for a “shy person,” simply maintaining eye contact for some duration may be reinforcing in and of itself. When working with children, individuals with disabilities, nonhumans, or adults for whom the target behavior is not likely to be especially rewarding in and of itself (e.g., coming to work on time, calculating a tip rapidly, without the use of a pencil and paper), it is critical to determine an effective reinforcer. Ideally the reinforcer should be one that is likely to occur in the individual’s natural environment. For example, a natural reinforcer for rapid calculations of a tip might be admiration from others, or avoidance of “odd looks” from restaurant staff. Once a reinforcer is identified, it should be used consistently in the training program. The reinforcer should be delivered following each instance of the target response, throughout training and fading.

The third step to complete prior to beginning a prompting and fading procedure is identification of a starting point. The stimulus used for initiation of training should be something that will reliably evoke the target behavior. Continuing with the “shy” individual, the initial prompt might be a verbal cue such as “look at me.” Alternatively, it may be necessary to use several types of prompts to ensure the behavior will occur when training begins. For example, a parent teaching a child to clean the child’s bedroom might make a chart with pictures showing what needs to be done and in what order. The parent also might need to remain in the room and verbally prompt the child through each step. Regardless of the level of prompting or number of prompts used initially, it is critical that the initial prompts reliably occasion the target behavior. Once the behavior occurs immediately following the initial prompt for several consecutive trials, prompt fading can commence.

The fourth consideration prior to beginning a prompting and fading procedure is to determine when fading will begin and how rapidly fading will progress, based on the learner's performance. For example, the instructor might determine that fading will begin when the learner has correctly emitted the target response following prompt presentation for three consecutive trials. Further, prompts will be successively removed when the learner has correctly emitted the target response following that level of prompting for three consecutive trials. Second, the instructor should measure the learner's response in some way, so as to ensure that the fading procedure is working effectively and efficiently. The goal is to enable the learner to respond without prompts, however if fading is too rapid, the learner may cease to respond. Alternatively, if fading is conducted too slowly, the individual may become "prompt dependent." That is, the learner may not learn to exhibit the desired behavior without the prompt. Careful evaluation of the learner's progress will ensure that fading is accomplished at the desired rate. More important, as fading progresses, the goal is for removal of cues to be gradual enough that few errors occur. If an error occurs, it may be necessary to back up to the previous prompting level for several training sessions. Alternatively, frequent errors might signal two potential problems, either fading is occurring too rapidly, or the reinforcer for correct performance is no longer effective. In the case of the first problem, the instructor should return to the level of prompting at which no or very few errors occurred. Once the individual is again reliably emitting the correct response, fading should again commence, however the steps of fading need to be smaller or occur more gradually. In the case of the second problem, an ineffective reinforcer, the instructor must identify another reward that will increase the likelihood of correct responding.

IV. EMPIRICAL STUDIES

Fading has been used to decrease the use of prompts for a variety of behaviors. In 1990, Mary Ann Demchak

published a comprehensive review of the use of stimulus and response prompt-fading procedures when providing instructions to individuals with severe disabilities. Both types of prompt fading also have been used to facilitate language acquisition, as evidenced by a review published by Sebastian Striefel and Charles Owens in 1980. Response prompts have been used to teach many behaviors including social skills and reading comprehension. In 1988, Phillip Moore provided a comprehensive review of the utility of fading procedures in teaching reading comprehension.

Fading of stimulus prompts also has been widely used. To illustrate, in 1984 Elsie Labbe and Donald Williamson published a comprehensive review of interventions using stimulus fading to treat elective mutism. Also, Rebecca Kneedler and Daniel Hallihan published a review of studies using fading to increase on-task behavior of children in academic settings in 1981.

See Also the Following Article

- Extinction

Further Reading

- Demchak, M. (1990). Response prompting and fading methods: A review. *American Journal on Mental Retardation*, 94, 603–615.
- Kneedler, R. D., & Hallihan, D. P. (1981). Self-monitoring of on-task behavior with learning-disabled children: Current studies and directions. *Exceptional Education Quarterly*, 2, 73–82.
- Labbe, E. E., & Williamson, D. A. (1984). Behavioral treatment of elective mutism: A review of the literature. *Clinical Psychology Review*, 4, 273–292.
- Miltenberger, R. (2001). *Behavior modification: Principles and procedures*. Belmont, CA: Wadsworth/Thomson Publishing.
- Moore, P. (1988). Reciprocal teaching and reading comprehension: A review. *Journal of Research in Reading*, 11, 3–14.
- Striefel, S., & Owens, C. R. (1980). Transfer of stimulus control procedures: Applications to language acquisition training with the developmentally handicapped. *Behavior Research of Severe Developmental Disabilities*, 1, 307–331.

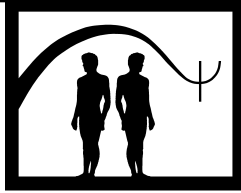

Family Therapy

William A. Griffin

Arizona State University

- I. Description of Treatment
 - II. Theoretical Basis
 - III. Applications and Exclusions
 - IV. Empirical Studies
 - V. Case Illustration
 - VI. Summary
- Further Reading

GLOSSARY

reframe Changing the conceptual and emotional perspective of a problem such that the meanings of the behaviors associated with the problem are viewed in a way that allows modifying the behavior easier for the client.

task A therapeutic directive that forces the entire family or selected family members to interact differently from the pattern thought to be associated with the presenting problem. Tasks occur in-session or as homework to be done between sessions.

Family therapy is a perspective of interpreting and modifying behavior. This perspective is implemented as psychotherapy in several diverse ways each according to a different set of theoretical tenets, where each tenet or cluster of tenets forms a separate model of family therapy. Although implementation varies, the multiple methods of doing family therapy derive from a single assumption: Presenting problems originate from inadequate, inappropriate, or dysfunctional interper-

sonal relationships, and therefore should be subsequently altered using techniques that in some manner modify interpersonal relationships. The various approaches of family therapy can be trichotomized based on their respective therapeutic assumptions and techniques; they are ahistorical, historical, or experiential. Each classification approach represents a general orientation toward ameliorating the problem, and within each type, various models reside.

Models within the ahistorical classification attempt to remove the presenting problem by altering family interaction sequences. Advocates of this orientation assume that current interaction processes may be unrelated to the etiology of the presenting problem, but certainly contribute to its maintenance. In general, the goal of therapy is to remove the presenting problem by changing attribution or behavioral patterns. Models within this group include strategic, structural, Mental Research Institute (MRI) narrative, behavioral, solution focused, and psychoeducational.

Historical models have psychoanalytic psychodynamic roots. Therapy tends to be longer and the therapist is generally less active in the session than in either of the other two classifications. Emphasis is on early family dynamics as templates that influence all subsequent intimate relationships. Also important is individual growth and individuation within the family. Models within this group include object relations and Bowenian.

Experiential models emphasize personal growth, experiencing and monitoring internal processes, and the development of self within the context of the

family. In addition, therapists are encouraged to share their internal processes in response to the session. Therapy within this classification is usually associated with a person (e.g., Carl Whitaker) rather than a model. Of the three types, the ahistorical approach probably best describes how contemporary family therapy is practiced and forms the basis for this article.

I. DESCRIPTION OF TREATMENT

Family therapy is any attempt to modify salient environmental features, most importantly interpersonal contacts or beliefs about those contacts, which alter interaction patterns, allowing the presenting problem to be unnecessary. Notice that family therapy does not necessarily exclude nonfamily members, nor does it necessitate that all family members be present in therapy. Problems are assumed to be embedded in behavioral patterns, and patterns are determined by context. Family therapy, then, exists to alter context. From this viewpoint, the job of the therapist is to alter the context driven behavior.

A. Initial Contact and First Session

Like other forms of psychotherapy, during the first session the objective is to join with the client and assess the problem. However, unlike other forms of psychotherapy, family therapy also begins by attempting to alter the family's perspective. Almost immediately an effort is made to dilute the idea that the presenting problem associated with an individual is encased within that person; instead an attempt is made to modify beliefs so that the problem is perceived to be a by-product of the situation that characterizes the system (i.e., environment) housing the individual. In effect, an initial objective is to have the problem viewed differently by the family. Family therapy then, especially initially, occurs through social negotiation. It involves determining what the family wants, how they see the problem, how they want it fixed relative to the assumptions and orientation of the family therapist, and how well the therapist can pull the problem away from an individual and distribute it to the system. Once this has commenced, the therapist then allows the presenting problem to be unnecessary by altering the family structure, which simultaneously alters interaction patterns, relationships, and beliefs about the family. Alternatively, the therapist modifies the beliefs about the relationship, which simultaneously alters patterns of interaction, and the family structure. Simply said, the

therapist enters the family at the relationship level, not at the level of a particular individual, and alters interaction associated with the various relationships.

1. Initial Contact

Everyone relevant to the presenting problem is asked to attend the initial session. This includes all adults in the household, and all siblings. Each individual brings unique information about the family beliefs and the presenting problem. Subsequent sessions require various combinations of family members as dictated by the therapist needs.

In the interpersonal model, therapy is directed toward the relevant behavioral pattern, not the person. As such, only those family members (or relevant members of the system) are needed that provide the leverage to alter the interactions that require changing. Stated differently, the therapist needs in therapy those subsystems that have the ability to change the relationship. This needed configuration changes from moment to moment within a session, and across sessions. It is not unusual to shuffle people in and out of the therapy room if doing so generates leverage, or if the act of excluding someone mimics metaphorically the desired changes.

Conversely, sometimes the needed individuals will not, or cannot attend therapy. Although not optimal, since therapy is with the relationship, it is assumed that the intervention will ripple through the system.

2. First Session

In family therapy at least three features about the presenting problem are examined: (1) timing, (2) function, and (3) who. Each provides an important clue to discerning relevant contextual information associated with the problem.

a. Timing. General timing questions provide a timeline for understanding the evolution of the problem. The therapist seeks answers to the following questions. Why is this problem occurring now? What has occurred recently, or if not recently, how long ago? What was going on in the family when this started? Why was the behavior not present yesterday or last week? What is occurring now that makes the behavior necessary for the individual? Were there changes in the family or larger environment when the problems started? Were there job changes, separations, fights, and so on before the onset? These questions can be asked directly or indirectly. An indirect question would be something like, "Give me a picture of the family, and how it has changed over the past year," or "Describe the family's everyday routine for the past 6 months."

b. Function. General function questions provide a framework that examines the utility of the behavior associated with the problem. The therapist, asking each individual to describe the presenting problem, wants to know, “What is the result of the behavior?” Similarly, the therapist is curious about, “What gets accomplished, and what does not get accomplished when the behavior occurs?” Accomplished here means any personal or interpersonal activity that should occur in a functional family. These include, for example, developmental changes, relationships, work, or individual activities.

c. Who. These questions provide necessary information about the people involved with the problem. For example, when the problem occurs, who directly reacts to the behavior, and then what happens? Reaction means attention, action, or general response. Consider John, the biter. When John bites Jane (the sister), who reacts, how do they react, does John get more or less attention (than before the bite), do bites occur most often when mom and dad are fighting, or have they increased since mom and dad separated? This is the type of sequence information necessary to conceptualize how the presenting problem ripples among the network of family members.

Although this example illustrates a short-term (hours or minutes) behavioral sequence, the thinking is equally applicable to sequences that cycle over a period of days. The child who regularly threatens suicide illustrates this extended perspective. For example, the child threatens suicide, mom calls the crisis unit, everyone converges to the scene, and mom and child have a very different relationship for some extended, yet temporary, period. “Who” questions generate information about which people are needed in therapy or else, at minimum, who must be considered relevant when tasks are assigned.

B. Belief Structure

Depending on the specific model of family therapy, each emphasizes to a lesser or greater extent the role of beliefs and cognitions in maintaining the behavior patterns associated with the presenting problems. Consequently, the therapist seeks to simultaneously change the presenting problem, either directly or indirectly, and the cognitive perspective that necessitates the dysfunctional interactions within the environment. In family therapy, this cognitive perspective is a belief structure maintained by the family, with slight variations held among the individual family members. This family level cognitive perspective acts as a filter, determining the meaning of events, which in turn, dictate reactions to the events. De-

pending on the family's history and culture, events are interpreted according to beliefs held by the family. The beliefs, or myths, may be functional or dysfunctional. They may be functional in their ability to keep the family intact, and yet to the world outside the family, be dysfunctional in the type of behavior that the beliefs produce. Treating an individual within the interactional perspective assumes that he or she has a cognitive perspective that influences the perception of environmental input, and determines that individual's behavioral reaction. Consequently, family therapy seeks to alter the belief as well as the behavior. However, depending on the family therapy orientation used, the therapist may seek to change the belief either directly, or through a change in the presenting problem. In other words, it is held that you can change the behavior and assume that it will allow the belief to be less valid, and subsequently unnecessary; or you can attempt to change both simultaneously. Either way, the presenting problem must change, and its underlying belief structure must be altered enough to allow the dysfunctional behavior to be unnecessary.

C. Implementing Treatment: Dimensions of Family Therapy

It is assumed that the therapeutic process begins at first contact, and from that moment on, the distinction between assessment and prescribed change is blurred as these interdependent features continuously address the presenting problem. Instead of thinking of therapy changing over time (e.g., phases), it is better to think of therapy as containing three interdependent dimensions occurring simultaneously over the period of treatment. These dimensions are assessment, instilling doubt, and pattern change.

1. Assessment

Assessment includes determining relevant behavioral patterns and belief systems in the family. Assessment occurs throughout treatment; the therapist's concept of the problem is continuously updated using information gathered via questions and responses to tasks. Assessment is in two areas: interaction patterns and belief structures. Assessing behavioral interaction patterns include questions about who does what and when, and who responds to whom, when, and how?

Assessing the family belief structure involves the following types of questions:

1. How does the family think, in the sense of a singular unit; what themes are present?

2. Where are the family alignments and coalitions?
3. What is the language of the family, and how does it reflect their beliefs?

The therapist also examines the family beliefs and myths about causality; these usually have one or more of the following themes: genetic influence (i.e., bad seed), vaguely defined biochemical imbalance, some supernatural influence (e.g., god, devil), influence of peers, or a bad parent (typically the one not present in therapy). These beliefs are typically associated with an assumed cure; for example, if the assumed problem is peer influence, then new friends would alleviate the problem. Finally, part of the assessment includes appraising the development stage of the family. This includes considering the age of the children and their parent(s). Parents of a young child face a very different set of problems than do parents of a preadolescent, an adolescent, or a young adult living at home. At each stage of development, individuals within the family have expectations that influence their behavior. Collectively, these expectations influence the expression of the presenting problem. Each stage of the parenting process is made more complex by the impact of the marital relationship. Single parents handle parenting situations differently than married parents, and happily married couples handle parenting problems differently than unhappily married couples.

In family therapy, the therapist should be cognizant of how the family arrangement and stage influence the patterns that maintain the presenting problem, and how each can affect treatment success or failure. No single recommendation can be made for each possible combination of family stage by family composition by marital status by parenting skill, and so on. Instead it is much better to examine each family as a unique composite, having its own history and belief system. By observing this belief system as expressed through behavioral patterns, the proper therapeutic intervention becomes evident for each particular family, irrespective of developmental stage.

2. *Instilling Doubt*

Simultaneous to assessment, the therapist begins the process of subtly casting doubt on the validity of the family's current belief system about the presenting problem. Seldom will the family acknowledge that marital or family interaction patterns produce the presenting problem, or even that the problem lies outside of the identified patient. Typically, the therapist addresses the interactional and contextual dynamics surrounding the presenting problem. This occurs in several ways; for ex-

ample, perspective altering questions, reframes, and directives for in-session interaction.

This process begins immediately in the first session and continues unabated throughout the treatment period. Initially it serves to alter the presenting perspective to allow change in dysfunctional patterns, and later serves to concretize the new ideas about how behavior occurs.

3. *Pattern Change*

Implicit or explicit requests for change in the behavior patterns that are associated with the presenting problem characterize this dimension of therapy. Using the removal of the presenting problem as the goal, decisions are made about what needs to be changed, and how to shift the belief structure to allow the desired behavior to occur. Although the presenting problem is the defining reason for being in therapy, short-term goals for smaller, less volatile behavior coax the individual or family toward more desirable behavioral patterns along with an altered family belief structure. This implies that as assessment is occurring and doubt is cast upon the existing beliefs, opportunities are offered for behavior change.

These opportunities occur both in and out of session. In-session opportunities occur when verbal statements by the therapist prompt a slightly different perspective (e.g., using a reframe) or when requested tasks force the family to interact differently. Out-of-session opportunities occur when behavior tasks are implemented. These requested tasks may include parents negotiating curfew times, or having the parents decide on consequences for misbehavior. The requested task forces new interactions around the presenting problem. When any task is, or is not completed, the response to the task by each individual provides additional information used by the assessment dimension.

a. Tasks: In-Session versus Out-of-Session. Requesting change via tasks is a hallmark of family therapy. Tasks, or requests for specific behaviors, can occur either in- or out-of-session. In-session tasks consist of directing the interaction among family members. This can consist of interaction between family subunits, or among members as a whole. Out-of-session tasks usually are thought of as homework assignments. Irrespective of family therapy orientation, most therapists use both types.

In-session task. The in-session task has three functions: (1) It allows the therapist to see relevant interaction, (2) it allows the therapist to alter relevant interaction, and (3) it allows the family to experience new patterns of interaction. Observing interaction in a session is extremely

beneficial in determining what is occurring in the family and how it needs to be changed. Assuming that the in-session behavior is isomorphic to the out-of-session behavior, the therapist is confident that what is seen reflects what happens in the home.

These tasks can be as simple as asking the husband and wife to talk about relevant issues, or as complex as having a family meeting on some topic. Each task, irrespective of complexity, generates relevant interaction needed for continuous assessment.

Another value of the in-session task is that it provides the therapist with the opportunity for the intended family interaction pattern to fail. For the therapist, there are therapeutic benefits in observing the family fail at the assigned task. Specifically, observing a failed task provides information about the pattern structure, provides immediate opportunity for therapist to comment on the process, and provides an opportunity to challenge the belief system.

Some families benefit more than other families from in-session compared to out-of-session tasks. Because in-session tasks generate new interactions among the family during the session, they are especially useful with families characterized as chaotic, that is, where most family members have infrequent, or volatile contact with other family members. This also includes families in which the lifestyle increases the likelihood that the family will come for only one or two sessions. Finally, in-session tasks may be necessary for families that fail, for whatever reason, to complete out-of-session tasks. These families should be given in-session tasks to determine what interactional components contribute to out-of-session failures.

Out-of-session tasks. Tasks that request specific changes in behavioral interactions outside of therapy have the singular function of altering, however slightly, familial interactions that are consistent with removing the presenting problem. Out-of-session tasks require interactions that need time, opportunity, or situations that are outside of the therapy session. These might include positive interaction opportunities (e.g., trip to the park), or need several days or weeks to complete (e.g., parent monitoring of child behavior). Moreover, if the task fails, the out-of-session task allows the therapist to determine the sequencing of behaviors associated with failure.

Like in-session tasks, failure to complete out-of-session tasks is seen as a source of information within the assessment dimension of therapy. In turn, the failure information is used to devise and re-assign another, slightly modified task. This next task accounts for the previous failure by modifying important ingredients in the interaction, which if successful, takes the pattern

closer to the objective. If the task again fails, even with the modifications, then the therapist has more information about what is interfering with change. When successful, tasks simply allow the perspective shift to manifest itself behaviorally. The task, in effect, demonstrates that behaviors can change in accordance with the precepts of therapy. In some cases, no tasks need to be given, and in others, the therapist gives a task at each session. Whether or not to assign a task depends on what the therapist determines the family needs, and since the needs of families vary, so should task assignment.

D. Subsequent Sessions

Subsequent sessions build on the initial session—shifting perspective and changing behavior. Each therapeutic maneuver either sets up or implements small changes that are consistent with eliminating the presenting problem. These small behaviors are, in fact, short-term goals; in turn, success in these short-term goals inexorably lead to changes in the presenting problem. Changes, as defined here, refer to not only interaction patterns, but also shifts in the client belief structure. Remember, the shift in perspective refers to a method of allowing the individual or family to see behavior in a slightly different way. Specifically, efforts are directed toward changing the behavior via interactional tasks while concomitantly asking questions about, or indirectly making reference to, the beliefs that underlie those interactions.

In general, there are no precepts about what to do in any given session other than always to guide the client to change. Each therapeutic maneuver should be goal directed; each should attempt to alter pattern, perspective, or both in relation to short-term goals. In turn, each short-term goal must be directly related to the long-term goal of removing the presenting problem. For example, a short-term goal might be getting the mother and father to view the son in a slightly different way; to view the child, not as a “sick” kid, but as a son reacting to a chaotic home life. A series of small moves such as this eventually allow the parents to take more responsibility for the environment that shapes the child’s behavior.

E. Termination

Because the object of all ahistorical family therapy models is to remove the presenting problem, once that objective has been met therapy ends. By maintaining a very specific objective, such as removing the presenting problem, all parties involved work toward a common goal, and everyone is aware of the changes that have

been made, or need to be made, in order for therapy to be successful. Therapy should be as brief as possible, typically lasting from 6 to 20 sessions.

II. THEORETICAL BASIS

A clear and consistent message implicit in traditional psychotherapy is that the individual with the presenting problem has a core deficit. The identified client may be lacking social skills, has aberrant thinking, is developmentally arrested or unable to resolve internal conflicts, or has some flawed biochemical process. Irrespective of etiology, the problem is within the individual and all effort focuses on treating the assumed structural deficit within the individual. Conversely, family therapy is an interpersonal model of psychotherapy; it focuses on treating the relationships between members of a delimited environment. Unlike the individual deficit model, family therapy assumes that a presenting problem reflects the inadequate quality or inappropriate structure of interpersonal relationships in which the individual resides. Moreover, family therapy assumes, *a priori*, that the individual expressing a symptom for the system is no more or less likely than any other family member to be psychologically vulnerable. Simply put, the identified patient is fulfilling a role within the larger system.

Each model in family therapy posits different theoretical tenets for the processes that generate the problematic behavior. Some assume a dysfunctional multigenerational process (e.g., lack of individuation), while others assume that psychological remnants from early attachment figures stifle the ability to maintain later relationships, and still others assume that inappropriate reinforcement or punishment creates a chaotic environment that produces aberrant behavior in children. Although each model has different assumptions about the presenting problem, a single conceptual thread binds them together—the identified patient represents the cumulative inability of the immediate environment, usually the family, to functionally adapt to exogenous or endogenous changes that naturally occur as a system evolves over time. Furthermore, although the family produces the symptom, the identified patient is simply selected as the carrier; this implies that any sibling could do just as good a job if drafted for duty.

Most of the assumptions held by family therapists derive from global theories that have no direct link to psychotherapy but instead focus on natural or biological systems. Many of the central ideas draw from general system theory, initially forward by the biologist Ludwig von

Bertalanffy in the early 1930s. Lesser known theories (at least in the social sciences), such as information theory and cybernetics, also influenced the seminal writers in this area. Given the fluidity inherent in these dynamic systems models, it is not surprising that family therapists assume that, unlike many traditional psychotherapy models, change can occur spontaneously, that etiology is impossible to know, or that defense mechanisms and client resistance have no conceptual foundations. In effect, families are evolving systems, embedded in other systems and that the function of the therapist is to perturb the system enough to alter the processes that characterize the system. Exactly how the therapist induces this perturbation forms the unique underpinnings of each of the various models of family therapy.

III. APPLICATIONS AND EXCLUSIONS

Because family therapy does not attempt to modify a person but rather the behaviors exhibited by a system, it is generally applicable to most of the problems seen by mental health practitioners. With children and adolescents, it has been applied to problems ranging from conduct disorder to anxiety and depression. In adults, it has been applied to relationship problems, as an adjunct to the treatment for schizophrenia, depression and anxiety, modifying family reactions to medical illness, and drug and alcohol abuse.

Most of the couples and families treated with family therapy, at least as described in the scientific literature, have been predominantly upper-lower and middle class, and white. In the past decade, greater emphasis has been made to apply these techniques to more diverse groups such as Asian and Hispanic populations. Because family therapy did not evolve from a psychological perspective but rather from a general systems orientation, most of the assumptions that form family therapy are equally applicable across family types and cultures. For example, Salvador Minuchin developed structural family therapy in the early 1960s at a facility that dealt with young delinquents, mostly black and Puerto Rican.

IV. EMPIRICAL STUDIES

A number of studies provide evidence that family therapy is generally as effective as other forms of psychotherapy for the types of problems noted in the previous section. It is clearly the treatment of choice for relationship problems; this was established almost two

decades ago and has subsequently been confirmed through multiple studies. William Pinsof and Lyman Wynn edited a book in 1995 that provides an excellent overview of family therapy outcome studies.

V. CASE ILLUSTRATION

This synopsis reviews the case of a 10-year-old girl that presented with uncontrollable head shaking and humming. The condition had been occurring for about 1 year, and the parents were told that the disorder was caused by a biochemical imbalance in the brain. The child and her family were referred to the Marriage and Family Therapy Clinic after several thorough neurological examinations found no physical reason for the condition. The humming and head shaking, although reported to be uncontrollable, did not occur at school, during therapy sessions, or in situations that the child enjoyed. It occurred primarily at night, starting within minutes after the child went to bed. The humming usually increased slowly until it got the attention of the parents, who would then check on the girl, reassure her, and then leave the bedroom. This cycle continued until the child fell asleep. This case was assigned to an M.S.-level family therapist, and I was the supervisor.

After reviewing the videotape of the initial session, and assuming no physical disorder could explain the selective head shaking and humming, I further assumed that the family was inadvertently reinforcing the behavior of the child, and the child was unable to engage the parents with less drastic measures. I decided to discourage this reinforcement without focusing on the child or blaming parents. I used an MRI-type approach that involved having the parents "evaluate" the behavior without explanation. The intent was to simply reorganize the patterns of interaction between the girl and the response of her parents to her behavior. The therapist was instructed to commence the second session by asking about the symptoms during the previous week, what the parents did in response, and so on; most of emphasis was on getting the child to talk about the uncontrollability of the behavior. Near the end of the session, the therapist asked the following questions (these had been developed prior to the session) to the girl (with the parents present):

1. "Do you shake your head from left to right or from right to left?"
2. "Do you hum a low note, a high note, or a medium note?"
3. "Do you shake your head faster as the note gets higher?"

After each question, the therapist allowed the girl to respond, but typically, the girl would look puzzled and simply waited for the therapist to talk again. Finally, the therapist made the following statement: "I looked up biochemical imbalances in some books and I found out there are two types: the controllable type and the uncontrollable type. If, in fact, you do have a biochemical imbalance, you have the controllable type." And then the therapist said, "Ask me how I know that (pause). I know because you choose when you do it. You don't do it at school and you don't do it when I'm here. And I bet there are many, many other times when you don't shake your head and hum, right? Let's check that out right now. Shake your head and hum right now." (Note: It did not matter whether she moved her head or not, either behavior showed control.) After a long pause, the therapist said, "That confirms everything I've read. In your case it's very controllable."

The therapist then asked the young girl to step out to the waiting area and gave the following instructions to the parents. "Do you want to get rid of the head-shaking and humming, which she can control?" Of course, the parents said yes, and then the therapist gave each parent a set of 10 (3 × 5) cards, numbered consecutively from 1 to 10. The therapist then said, "Each of you has a card, numbered from 1 to 10, with 10 being high. Before I tell you what to do with these cards, I need your complete assurance that you will do exactly what I say. Are you willing?" The parents nodded affirmatively. Next the therapist said, "If you do this every single time it's appropriate, she will stop, very soon." After more assurances by the parents, the therapist said, "One thing about this type of behavior is that kids can sometimes do it better and sometimes do it worse. Since it's controllable, we've found by using this method, it effectively reduces the incidence—if it's used correctly. Many parents are distressed enough by the behavior to follow through. Do you think you are?"

After repeated assurances by the parents, the therapist then gave the following instructions: "Every time she does the behavior, it's your job to evaluate how well she does it. Go to where she is; turning the light on if she's in bed. Watch for 5 to 10 seconds to evaluate. Dad holds up his card with his rating. Mom then rates. Finally, dad adds the two ratings up, then divides by two, to get a single rating. Dad, in his very best fatherly tone, tells (child's name) her rating on this episode of the behavior. Then both parents calmly turn around and walk away, saying nothing more about the behavior. Do this every single time, but only one time per episode." Mom was assigned to keep track of the number of times they forget to do this.

At the following session (1 week later), the parents reported that during the first rating (while the child was in her bed) the girl stopped the head shaking and humming after several seconds of the parents observing and asked the parents what they were doing. They did not respond but simply completed the task as directed. During the second and third episodes, she stopped when the parents walked into the room. The fourth episode occurred in public; when the girl began her head movement and humming, the mom pulled out her set of cards and the girl stopped immediately. The following week no episodes occurred, and again at a 1-month follow-up, no additional episodes had occurred. The family was seen for a total of four sessions.

This case illustrates the use of an out-of-session task assigned to alter interaction around a problem behavior expressed by the child. The task and assignment method (i.e., specific oral instructions) allowed the family to view the distressful behavior as controllable. Each parent was assigned a unique part of the task, and as a unit, they engaged in behavior that modified the typical response to the presenting problem, thereby forcing new interaction patterns for the family.

VI. SUMMARY

Although multiple, disparate models of family therapy exist, all presuppose that the presenting problem is embedded and maintained in behavioral patterns that originated from inadequate, inappropriate, or dysfunctional interpersonal relationships. Consequently, the psychotherapy techniques used by a family therapist attempt to modify salient environmental features, most

importantly interpersonal contacts or beliefs about those contacts, which alter interaction patterns, allowing the presenting problem to be unnecessary. These techniques include in-task and out-of-session behavioral tasks, reframes, and perspective-altering questions. Therapy is typically brief (less than 20 sessions) and ends when the presenting problem or behavior has stopped or is no longer considered distressful.

See Also the Following Articles

Behavioral Marital Therapy ■ Couples Therapy: Insight Oriented ■ Home-Based Reinforcement ■ Psychodynamic Couples Therapy ■ Spouse-Aided Therapy

Further Reading

- Dattilio, F. M. (1998). *Case studies in couples and family therapy: Systemic and cognitive perspectives*. New York: Guilford.
- Goldenberg, I., & Goldenberg, H. (1996). *Family therapy: An overview* (4th ed.). Pacific Grove, CA: Brooks Cole.
- Griffin, W. A. (1993). *Family therapy: Fundamentals of theory and practice*. New York: Brunner/Mazel.
- Griffin, W. A., & Greene, S. M. (2000). *Models of family therapy: The essential guide*. New York: Brunner/Mazel.
- Nichols, M. P., & Schwartz, R. C. (1995). *Family therapy: Concepts and methods* (3rd ed.). Boston: Allyn & Bacon.
- Piercy, F. P., Sprenkle, D. H., & Wetcher, J. L. (1996). *Family therapy sourcebook*. New York: Guilford.
- Pinsof, W., & Wynne, L. (Eds.). (1995). Family therapy effectiveness [Special issue]. *Journal of Marital and Family Therapy*, 21(4). Washington, DC: JMFT Press.
- Shadish, W. R., Montgomery, L. M., Wilson, P., Wilson, M. R., Bright, I., & Okwumabua, T. (1993). The effects of family and marital psychotherapies: A meta-analysis. *Journal of Consulting and Clinical Psychology*, 59, 883–893.



Feminist Psychotherapy

Carolyn Zerbe Enns

Cornell College

- I. Description of Treatment
 - II. Theoretical Bases
 - III. Applications
 - IV. Empirical Studies
 - V. Case Illustration
 - VI. Summary
- Further Reading

(2) a commitment to equality and social justice for all people; and (3) the assumption that both personal and social change are necessary to support feminist therapy goals.

GLOSSARY

consciousness-raising Activities that increase awareness about how oppressions such as sexism, racism, heterosexism, and ageism influence the lives of individuals.

feminist analysis and gender role analysis Techniques used to examine how inequality, injustice, and power imbalances may limit individual potential. Gender analysis involves examining restrictive gender role beliefs and behaviors, weighing their costs and benefits, and constructing alternatives to prescriptive gender roles.

the personal is political Personal issues are not individual concerns alone, but are shaped by cultural forces and have implications for political and social change.

Feminist therapy integrates feminist analysis with a variety of psychotherapy systems to support egalitarian psychotherapy practice and goals as well as social change. Of central importance to this approach are (1) efforts to address the connections between variables such as race, culture, class, sexual orientation, and gender;

I. DESCRIPTION OF TREATMENT

Psychotherapy was first described as “feminist” during the early 1970s. Feminist therapy was not founded by or connected to any specific person, theoretical position, or set of techniques; its origins are embedded in the diverse social change goals and activities of the women’s movement. Feminist practitioners integrate knowledge about psychotherapy methods, social structures, multiple intersecting oppressions, activism, feminism, multiculturalism, and the diversity of women’s and men’s lives. Feminist therapy can be best defined as an umbrella or philosophical framework for organizing a therapist’s assumptions and psychotherapy techniques. Important features include emphases on (1) consciousness-raising and activism; (2) egalitarian therapist–client relationships and goals; (3) diversity and the multiple meanings of gender; and (4) a sociocultural perspective that addresses relationships among the personal problems, social forces, and various “isms” (e.g., racism, heterosexism, sexism, ageism). Feminist therapists are informed by a wide range of personality and psychotherapy theories, eschewing only those techniques that support inequality or narrow life options.

In contrast to traditional psychological approaches that may emphasize internal attributes and pathologies, feminist therapists view problems from a complex biopsychosocial framework, highlighting the ways in which social realities shape, constrict, and limit choices. Intrapyschic explanations of distress may decontextualize problems, promote narrow thinking, or support victim blaming. If therapists define problems primarily as a set of symptoms, they may also tend to emphasize symptom removal, which may not result in genuine change or renewal, but may merely call on individuals to resolve issues by accepting the very circumstances that contributed to their problems.

From a feminist perspective, many psychological symptoms represent efforts to cope with negative conditions, and thus, reflect communication and survival mechanisms. These behaviors, which frequently play important short-term adaptive roles, often become increasingly uncomfortable and counterproductive over time, and may eventually exhaust a person's resources. The feminist therapist helps the client understand how these forms of coping, such as anxiety and depression, can be redirected in productive and empowering ways. The therapist's frame of reference is not how symptoms are signs of pathology that must be removed but rather, what symptoms convey about a person's circumstances, strengths, and coping skills.

The feminist therapist emphasizes egalitarian practice and shared responsibility, and views the client as competent and as an expert on his or her own life and circumstances. Due to the training of therapists, however, the relationship may approach equality but is not likely to be fully equal. From a feminist perspective, open therapist–client discussions of power and the positive and negative uses of power facilitate the client's ability to deal with unequal power both within and outside of psychotherapy. Believing that all human interactions are infused with values, feminist therapists often make their values explicit, and encourage clients to take an active role in clarifying their own values and preferences.

During the 1970s, feminist therapists provided leadership within mental health professions by promoting informed consent and highlighting the value of clearly negotiated, collaborative therapeutic contracts. Informed consent assists therapists and clients in evaluating progress regularly, minimizes the risk that therapists will abuse power or manipulate clients, and enables clients to assume optimal levels of responsibility for their own direction in psychotherapy.

The goals of feminist therapy emphasize personal awareness of biological, personal, relational, cultural,

and sociocultural factors. Clients are encouraged to consider the role of both internal and external contributors to their problems and explore denied or distorted aspects of their experiences in order to discover hidden or submerged sources of strength. This consciousness-raising and clarification process may decrease clients' self-blame and help clients transform indirect forms of influence (e.g., symptoms) into direct, constructive, assertive expressions that support health. Clients may also explore ways in which restrictive environments may limit their freedom or may punish them for stepping outside of prescribed roles. In order to help clients deal with external and internal resistance to creative change, therapists often encourage clients to weigh the costs and benefits of change, and to consider how they may cope with negative reactions to their positive change efforts. Feminist therapists, recognizing that individual change alone will not lead to extensive systemic change, also attempt to devote some time to social action and advocacy. When appropriate, clients are also encouraged to become involved in social change or volunteer work that contributes to social justice.

As feminist therapists pursue the goals outlined above, they incorporate techniques from a variety of psychotherapy approaches. Some techniques are identified as hallmarks of feminist therapy, such as gender-role analysis, feminist analysis, self-disclosure, group work, and social change activities. Gender-role analysis, a component of assessment, involves exploring the impact of gender and related identity statuses (e.g., age, sexual orientation, race) on psychological well-being, and using this information to make new decisions about gender roles. Laura Brown summarized comprehensive gender role analysis as including the (1) exploration of gender in light of personal values, family dynamics, life stage, cultural/ethnic background, and current environment; (2) discussion of the rewards and penalties for gender role conformity or noncompliance in the past and present; (3) clarification of how the client–therapist relationship mirrors gender issues or provides insight about the client's gender roles; and (4) exploration of the client's history related to victimization and oppression. A victimization history may include information about interpersonal violence, sexual harassment, assault and abuse, racism, sexism, heterosexism, and other related injustices that have contributed to the person's gender-related rules. The goals are to clarify how gender-related messages were absorbed by the individual, what functional and negative forces they have played in the individual's life, and how the client can use this information to choose emotional,

cognitive, and behavioral responses that enhance health.

Feminist analysis and power analysis refer to various methods for helping clients understand how unequal access to power and resources can influence personal choices and distress. Therapists and clients explore how inequities or institutional and cultural barriers may limit or complicate self-definitions, achievements, and well-being. To facilitate this process, therapists may provide information about dynamics or statistics associated with problems related to the unequal distribution of power (e.g., family violence, divorce, traditional marriage, sexual abuse). They also use open-ended questions to explore these dynamics and how clients can develop positive, personal approaches to power and relationships that empower themselves and others. Bibliotherapy, therapist self-disclosure, and psychoeducational groups may also be incorporated into feminist analysis.

Both gender-role and feminist analysis help clients reframe problems and develop new lenses for understanding issues, which often lead to renewed self-esteem. Rather than viewing themselves as deficient and needy individuals who must experience psychological overhaul, clients learn to define themselves as capable individuals who will benefit by redirecting their energy toward new goals.

Self-disclosure and group work are sometimes used to build connections between diverse groups of women, demystify the psychotherapy process, and decrease power differentials in psychotherapy. Therapist self-disclosure may decrease a client's feelings of isolation, and help the client connect abstract concepts about social structure and gender role conflicts to real-life issues. Through carefully timed and appropriate self-disclosure, the feminist therapist may serve as a coping model whose human qualities facilitate client empowerment. As noted by the Feminist Therapy Institute "Ethical Guidelines for Feminist Therapists," all self-disclosure must be used "with purpose and discretion and in the interest of the client." Group work, including consciousness-raising, support and therapy groups, psychoeducational groups, and seminars may also decrease feelings of isolation between clients and foster self-trust and social support. The sharing of life stories supports the mutual disclosure of gender role conflicts and everyday inequities, and often facilitates increased awareness of gender issues and solidarity among members. Members learn to use power effectively by providing support to each other, practicing new skills, and taking interpersonal risks in a safe environment. Groups also decrease

power imbalances between therapists and clients because members are not only receiving, but also giving emotional and practical support.

II. THEORETICAL BASES

During the first decade of feminist therapy practice, practitioners tended to be most concerned with responding effectively and immediately to the extensive gender-related problems that had been ignored, marginalized, or distorted by the lenses of mental health professions that had been dominated by androcentric theories and practices. The feminist critique of the mental health professions focused primarily on four overlapping issues: (1) personality theories and research that supported biased models of therapy; (2) double standards of mental health that overvalued attributes described as "masculine" and devalued attributes labeled as "feminine"; (3) diagnostic practices that contributed to labeling clients without regard to contextual, situational contributors to distress; and (4) psychotherapy relationships in which an all-powerful therapist defined reality for the client.

In the late 1960s, Naomi Weisstein declared that "psychology has nothing to say about what women are really like, what they need and what they want, essentially, because psychology does not know." A study conducted by Inge Broverman and colleagues during the early 1970s also revealed that mental health professionals' views of healthy men and women were influenced by gender stereotypes. In addition, Phyllis Chesler's influential book, *Women and Madness*, compared the therapy relationship to that of a patriarch and patient, noting that this relationship mirrored women's roles in patriarchal families where women were rewarded for submitting to an all-knowing father figure. Chesler argued that the band of "normal" behavior for women was extremely narrow and that women were diagnosed for both underconforming and overconforming to limiting mandates.

These powerful critiques, along with the activism of the women's movement, contributed to an initial emphasis on providing immediate, practical, respectful therapeutic options to women, as well as changing the systems in which therapy occurs. Following the establishment of basic principles, feminist therapists focused on developing theory that supports ethical practice, and one outcome was the Feminist Therapy Institute's "Ethical Guidelines for Feminist Therapists." These principles are not designed to replace other codes, but

to enhance feminist practice by enumerating positive, proactive responsibilities regarding cultural diversities and oppressions, power differentials, overlapping relationships, therapist accountability, and social change responsibilities of feminist therapists.

Rather than articulating one feminist theory of practice, feminist therapists have tended to propose criteria for evaluating theories applied to women's lives. For example, Hannah Lerman indicated that feminist personality theories should (1) view women positively and centrally, (2) avoid confining concepts, (3) encompass the diversity and complexity of women's lives, and (4) attend to the inextricable connections between the internal and external worlds. The feminist theory working group of the 1993 National Conference on Education and Training in Feminist Practice proposed that feminist theories should (1) support social transformation and the development of feminist consciousness; (2) emerge from and speak to the lived experiences of clients who exist in changing social worlds; (3) address power imbalances related to gender and diversity; (4) give voice to and authorize the world views of oppressed persons; (5) recognize that psychological constructs, including feminist constructs, are not based on universal "truths," but vary across time and culture; and (6) de-center the experiences of dominant groups, whose behaviors are often defined as healthy, correct, or normal. Several feminist psychological theories have also provided important foundations for the work of many feminist therapists. These include Sandra Bem's gender schema theory, Carol Gilligan's work on the relational qualities of women's ethics, and the self-in-relation model of Jean Baker Miller and colleagues at the Stone Center at Wellesley College.

The work of feminist therapists is informed by a wide range of sociological, philosophical, political, feminist, and psychological theories, and these feminist philosophical theories posit a variety of overlapping and sometimes competing views of the meanings and nature of sex and gender, the causes and consequences of gender oppression, the implications of gender-related inequity, and solutions to gender-related oppression. Feminist theories bear diverse labels such as liberal feminism, cultural feminism, radical feminism, women of color feminisms, lesbian feminism, global feminism, socialist feminism, postmodern feminism, and third wave feminism. Although feminist therapists generally agree on basic principles of practice, their unique orientations to feminism may have profound impacts on their interpretation of feminist therapy principles and choice of psychological and social interventions. One's feminist theoretical perspective influ-

ences the degree to which the therapist believes that (1) gender is socially constructed or an aspect of one's essential nature; (2) self-disclosure serves as a useful support for empowerment; (3) traditional diagnosis can or cannot be integrated with an egalitarian stance with clients; and (4) social change activity is an essential role of feminist therapists.

Judith Worell and Pam Remer developed a five-step decision-making model to help feminist therapists assess the compatibility of specific psychological theories and feminist therapy principles and, when necessary, transform incomplete or biased theories. The decision-making sequence starts with the identification of a theory's historical development and theoretical concepts, its views of clients' problems, its use of language and labels, the functions and roles of diagnosis and assessment, the role of clients and therapists, and techniques. Therapists then identify limitations, consider ways to restructure the theory, and incorporate aspects of other theories to construct more inclusive, egalitarian approaches.

III. APPLICATIONS

As a philosophical approach that can be integrated with a wide range of psychological theories, feminist therapy is applied to a broad range of psychological problems, including those problems that are often defined as "feminist" (e.g., sexual and domestic violence, sexual harassment), as well as problems that are influenced by biological factors (e.g., bipolar disorder, schizophrenia, anxiety, depression). Approaches to dealing with the following issues have received the most extensive attention in the feminist therapy literature: achievement and career issues, eating disorders, addictions, relationship issues, sexual assault and abuse, sexual harassment, family and domestic violence, trauma-related problems, depression, anxiety, and dissociative disorders.

Some early feminist therapists opposed the use of prescription medications because some practitioners' indiscriminate and singular use of some biological interventions represented forms of superficial treatment, social control, or led to addiction (e.g., the prescription of valium to homemakers in order to ease anxieties related to dissatisfying roles). At present, however, most contemporary feminist therapists operate from a biopsychosocial model that highlights social contributions to distress but also recognizes multiple contributions to psychological problems, including biochemical imbalances. Feminist psychopharmacology, an aspect of feminist psychiatry and therapy, is characterized by

the integration of feminist principles with attention to biases in medical diagnosis and research, vigilance about gendered prescribing practices, rejection of mind-body dualisms, and respect for the client's choices and treatment preferences. Phyllis Chesler, an early critic of the medical control of women through biological interventions, has recently argued that although clients are still often overmedicated or wrongfully medicated, medical advances have increased the quality of life of many. A sociocultural framework remains crucial for ensuring that clients experience an integrated approach that addresses the full range of internal and external contributors to distress.

Feminist therapy was originally developed by, practiced by, and applied to work with women. However, there has been increased recognition of the ways in which men's traditional roles and socialization can also be restrictive. Feminist therapy may be used to help men redefine masculinity according to values other than power, prestige, and privilege. Feminist therapy may also help men integrate relationship and achievement needs; increase men's capacity for intimacy, emotional expression, and self-disclosure; create mutually rewarding and collaborative relationships; and learn noncoercive problem-solving methods. In order to affirm men's contributions to justice and egalitarianism while also preserving the uniqueness of women's experiences as therapists and clients, some feminist therapists refer to the feminist activities of male therapists as profeminist therapy. Profeminist approaches are applicable to a wide range of men's problems including depression, anger management, interpersonal violence, anxiety issues, addiction, achievement concerns, and relationship and family problems.

Feminist therapy is appropriate for working with a variety of diversities, such as ethnicity, multicultural themes, class issues, life stage issues, sexual orientation, and physical disability. A substantial feminist therapy literature has emerged on the counseling needs of women of color, lesbians, and bisexual women. Authors such as Oliva Espin, Lillian Comas-Diaz, Beverly Greene, and Karen Wyche have also articulated feminist therapy approaches relevant to diverse groups of women of color, including immigrant women and lesbians of color.

IV. EMPIRICAL STUDIES

Some of the earliest studies relevant to feminist therapy examined the impact of consciousness-raising groups on participants, and in general, found that participation in these groups was associated with increased

endorsement of feminist attitudes and expanded concepts about women's potential. During the late 1970s, Marilyn Johnson's comparison of a small sample of clients who participated in feminist or conventional therapy found that these two groups reported similar types of problems, similar levels of satisfaction, and similar levels of change. Diane Kravetz, Steven Finn, and Jeanne Marecek compared the experiences of consciousness-raising group members who had sought feminist or conventional therapy and found that women who defined themselves as feminist reported higher levels of satisfaction when the therapist was feminist.

Another group of studies examined reactions of potential clients to videotaped, audiotaped, or written depictions of nonsexist, liberal feminist, and radical feminist therapy. Gail Hackett and Carolyn Zerbe Enns found that feminist respondents, including male participants with profeminist values, showed more positive reactions to all versions of counseling than individuals who did not endorse feminist values. Research participants were able to accurately identify counselors with a feminist orientation and generally expressed positive attitudes toward feminist therapists. Respondents also rated liberal and radical feminist counselors as emphasizing similar goals, but viewed radical feminist counselors as communicating these goals more strongly than liberal feminist therapists.

Recent survey studies have explored shared values and perspectives of feminist therapists and how these values may differentiate their work from therapists who do not define themselves as feminist. Judith Worell, Redonna Chandler, and colleagues found that self-identified feminist or woman-centered therapists were significantly more likely than nonfeminist therapists to endorse the following behaviors: affirming the client, adopting a gender-role perspective, valuing woman-centered activism, using therapist self-disclosure, and displaying an egalitarian stance. In 2000, Bonnie Moradi and colleagues compared the reported behaviors of feminist therapists and those who did not identify themselves as feminist. A factor analysis of feminist therapy behaviors revealed three major themes: (1) an emphasis on gender role analysis and the personal is political, (2) empowerment through respecting individual differences and focusing on strengths, and (3) valuing behaviors such as assertiveness and autonomy. When examining the five top-ranked behaviors of feminist therapists, this study found no significant differences between feminist therapists and other therapists with regard to displaying empathy and unconditional positive regard toward clients. However, feminist therapists were significantly more likely to describe their top

five behaviors with both male and female clients as consistent with the following: (1) paying attention to clients' experiences of discrimination, (2) adopting a collaborative role with clients, (3) reframing problems to include an emphasis on socialization, and (4) enhancing self-esteem by emphasizing clients' unique and positive qualities. Marcia Hill and Mary Ballou's 1998 survey of 35 feminist therapists also revealed the following themes: (1) attention to power differences, overlapping relationships, and therapist accountability; (2) an emphasis on the sociocultural causes of distress; (3) the valuing of women's experience; (4) application of an integrated analysis of the multifaceted and interlocking aspects of oppression; and (5) an emphasis on social change. These findings show the repeated endorsement of two key groupings of feminist therapy principles: the personal is political, and egalitarianism.

A final group of studies examined whether actual clients have viewed their therapists as displaying feminist therapy behaviors. Studies conducted by Judith Worell, Redonna Chandler, Anne Cummings, Niva Piran, and colleagues showed that clients view feminist therapists as displaying the qualities and behaviors that feminist therapists endorse (e.g., empowerment, reducing power differentials, exploring gender-role issues). Noting that traditional measures of symptom reduction are not consistent with feminist therapy outcomes, this group of researchers has also developed measures of feminist empowerment and have found that feminist therapy clients report outcomes consistent with feminist empowerment (e.g., resilience, developing coping skills for dealing with barriers).

Given the fact that feminist therapy is usually defined as a philosophical approach rather than as a highly standardized, technique-oriented approach to therapy, the examination of the processes and outcomes of feminist therapy is complex. Nevertheless, it is essential for researchers to study the process and outcome variables associated with distinctive techniques such as gender-role analysis, feminist social and power analysis, and feminist self-disclosure. It is also important to examine outcomes related to feminist therapy for specific types of problems (e.g., sexual assault, career counseling) as well as how the theoretical diversity of feminist therapists is reflected in actual feminist therapy behaviors.

V. CASE ILLUSTRATION

Briana, a 21-year-old college student, reported difficulty concentrating on courses, conflicts with her boyfriend and parents, depressed feelings, anxiety, and

nightmares. Other issues included difficulties trusting others, feelings of inadequacy, dysfunctional eating, and alcohol use. During initial sessions, Briana's therapist also asked questions about family and relationship interaction patterns, paying special attention to "shoulds" and beliefs that appeared related to gender dynamics in her family, friendships, and school experiences. When the therapist (Jean) inquired about the presence of past trauma or victimization, which is one aspect of gender-role analysis, Briana reluctantly revealed being the target of sexualized comments during her high school and college years and an unwanted sexual experience during her second year in college. After inquiring further about these experiences, Jean hypothesized that Briana coped with these unresolved events by minimizing the significance of these events. Her use of alcohol, eating issues, and her anxieties represented survival skills related to Briana's efforts to cope with events that might be too overwhelming to acknowledge. Although Briana's descriptions of unwanted sexual encounters were consistent with legal definitions of sexual harassment and rape, she did not label these experiences with these terms. She merely noted that she had been stupid and gullible, and that in accordance with her family's subtle "shoulds," she had learned to avoid thinking about these issues in order to "get over it and move on." After focusing briefly on the costs and benefits of this belief, Briana stated that she did not want to think about these experiences while she was trying to cope with pressing everyday demands.

Respecting Briana's ability to assess her most immediate needs, subsequent sessions focused on helping her deal more effectively and assertively with interpersonal and academic tasks. Jean and Briana identified and practiced concrete strategies for negotiating conflicts with her boyfriend and parents, dealing with anxiety and concentration problems, and decreasing her use of alcohol. Briana developed new communication skills, cognitive behavioral tools, coping imagery, and relaxation to deal with the immediate problems. Although Briana became more confident about everyday coping, she admitted that she continued to have nightmares, did not enjoy physically intimate contact with her boyfriend, and still used alcohol or food to submerge depressed feelings.

In response to the therapist's tentative hypothesis that her negative sexual experiences might be related to these issues, Briana expressed willingness to explore this material. The therapist briefly disclosed that her own sexual assault as a college student had drained her energy and productivity for some time, but that working through her reactions had freed her to deal more

effectively with life tasks and direct her anger in productive directions. While acknowledging that Briana's experience was unique, she noted that the research literature reveals that many women have long-term reactions to unwanted sexual behavior, and proposed that exploring this material might be a constructive experience.

Before talking specifically about her unwanted sexual experiences, Jean and Briana identified how she might use the new skills she had learned to deal with uncomfortable emotions that could emerge during their next phase of exploration. Briana described her memories about the painful sexual experience of the past year, which had involved a friend forcing her to have sex following an evening at a party and a bar. She had coped by defining it as a bad experience, and had stifled painful emotions because she believed that family and friends would not believe her or would blame her for being "seductive." As Briana described the assault, she cried and expressed feelings of sadness and anger. Jean supported her expression, framing it as a new type of response-ability and a chance to refocus her intense feelings from depression to more direct expression of her feelings.

Building on earlier gender-role analysis activities, Jean encouraged Briana to draw potential connections between her thoughts about the sexual violation and messages and myths she had learned from family, media, and friends. These included (1) "It was my fault because I was dressed in a sexy outfit"; (2) "It was my fault because I had two beers and could not resist like I should have"; (3) "He was a good friend and wouldn't do anything to hurt me, so I must have sent the wrong signals"; and (4) "It's a sign of weakness to be overwhelmed by this." An exploration of the myths that supported these beliefs (feminist analysis) helped Briana understand how the cultural "smog" she had been exposed to had affected her self-statements. Further examination also focused on how her status as an African-American woman contributed to her realistic fears about how others would react to potential disclosure about harassment and sexual violation. They discussed how myths associated with confining images of African-American women's sexuality as Sapphires and Jezebels contribute to beliefs that Black women are promiscuous, sexually voracious, dominant, and incapable of being raped. Thus, Briana may have been affected by these beliefs, perhaps nonconsciously, and did not believe she could expect empathy from others. Paying attention to personal trauma is not unique to feminist therapy; however, efforts to place victimization within a larger social context by exploring myths and social attitudes, as well as efforts to redirect self-

blame associated with these myths are important features of feminist therapy.

Jean also recommended several books that (1) identify the dynamics of acquaintance rape and gender harassment on college campuses (*I Never Called It Rape*, by Robin Warshaw), (2) discuss the acquaintance rape of women of color as well as cultural beliefs that support acquaintance rape in American culture (*A Woman Scorned*, by Peggy Sanday), and (3) describe healing after rape (*After Silence*, an autobiographical account by Nancy Venable Raine). After writing about her experience for a homework assignment and reading these materials, Briana developed a new framework for conceptualizing the personal violations, and began to use the terms rape and sexual harassment to describe her victimization. The books affirmed and validated her experience, and provided additional permission to deal more specifically with the consequences of harassment and rape.

Counseling sessions also focused on (1) finding effective ways of expressing feelings related to personal violation and anger, and translating this anger into positive directions; (2) talking with intimate others about her experiences of violation; and (3) learning to initiate intimate contact on her own terms. Briana's therapist referred her to a support group for sexual assault survivors, and in this setting she was able to work through additional feelings in a supportive environment, overcome feelings of isolation, and experience empowerment through connections with others. She also became more aware of the many ways in which media promote rape and how fears about rape often constrict women's lives. Briana enrolled in a psychology of women course in order to gain more understanding of gender dynamics, and as an extension of her emerging interest in activism and supporting others, she enrolled in crisis training at a rape crisis hotline. She also joined several student activist groups on campus, including Sisters for Sisters, a group designed to provide support for women of color on campus.

VI. SUMMARY

Some form of unequal power, victimization, or abuse often underlies the concerns that clients bring to therapy. Many clients have experienced abuse or unequal power over an extended period of time, and may enter therapy with intense feelings of guilt, isolation, and self-denigration. These clients often use denial or minimization as methods for coping with the long-term, insidious effects of unequal power and abuse and may have difficulty

identifying and naming the problems they are experiencing. As clients disclose personal information, the therapist and client examine how these issues are influenced by the contexts in which they live, confront personal myths that support internalization, and identify ways in which symptoms serve as survival mechanisms. Working through these problems is often difficult because they have become entrenched and solidified by many years of restrictive socialization and unequal power.

As clients experience new levels of awareness, they often express previously suppressed feelings of anger, pain, grief, or disappointment. Clients also explore sources of strength, capacity, and personal power, which help them develop new coping and behavioral skills for caring for themselves and interacting with others. Finally, creating new support systems that support individual changes reinforces positive progress and also helps individuals think more globally about the implications of their experience for social change in general.

See Also the Following Articles

Cultural Issues ■ History of Psychotherapy ■ Multicultural Therapy ■ Oedipus Complex ■ Race and Human Diversity ■ Women's Issues

Further Reading

- Brown, L. S. (1994). *Subversive dialogues: Theory in feminist therapy*. New York: Basic Books.
- Comas-Diaz, L., & Greene, B. (Eds.). (1994). *Women of color: Integrating ethnic and gender identities in psychotherapy*. New York: Guilford Press.
- Enns, C. Z. (1997). *Feminist theories and feminist psychotherapies: Origins, themes, and variations*. New York: Harrington Park Press.
- Herman, J. S. (1992). *Trauma and recovery*. New York: Basic Books.
- Mirkin, M. P. (Ed.). (1994). *Women in context: Toward a feminist reconstruction of psychotherapy*. New York: Guilford Press.
- Rave, E. S., & Larsen, C. C. (Eds.). (1995). *Ethical decision making in therapy: Feminist perspectives*. New York: Guilford Press.
- Unger, R. K. (Ed.). (2001). *Handbook of the psychology of women and gender*. New York: Wiley.
- Walker, L. E. A. (1994). *Abused women and survivor therapy*. Washington DC: American Psychological Association.
- Worell, J., & Johnson, N. G. (Eds.). (1997). *Shaping the future of feminist psychology: Education, research, and practice*. Washington DC: American Psychological Association.
- Worell, J., & Remer, P. (1992). *Feminist perspectives in therapy: An empowerment model for women*. New York: Wiley.

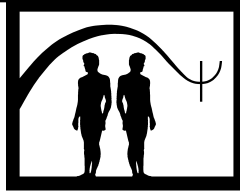

Flooding

Catherine Miller

Pacific University

- I. Description
 - II. Theoretical Bases
 - III. Empirical Support
 - IV. Summary
- Further Reading

main variations of flooding and the theoretical basis for the intervention. Finally, a review of the effectiveness of this intervention with anxiety symptoms as well as a discussion of contraindications are provided.

GLOSSARY

- conditioned response** Response to conditioned stimulus; similar to response to unconditioned stimulus.
- conditioned stimulus** Stimulus that elicits similar response as unconditioned stimulus after repeated pairings.
- exposure** General term for many therapeutic techniques in which clients are presented with feared stimuli or situations in order to reduce anxiety symptoms.
- neutral stimulus** Stimulus that produces no response prior to repeated pairings with unconditioned stimulus; becomes conditioned stimulus.
- operant conditioning** Type of learning; responses that are reinforced will be repeated, whereas responses that are punished will not be repeated.
- respondent conditioning** Type of learning; repeated pairing of unconditioned and neutral stimuli will result in neutral stimulus becoming conditioned stimulus and eliciting conditioned response.
- unconditioned stimulus** Stimulus that elicits response without training.

Flooding is an intervention developed for the treatment of anxiety symptoms. This article will discuss the

I. DESCRIPTION

Due to the many variations of flooding, it is difficult to provide a concise and universal definition of the technique. Traditionally, flooding has been defined as a technique that involves prolonged exposure to feared stimuli or situations at full intensity, in an attempt to extinguish anxious responses. In other words, from the beginning of treatment, the client is exposed to stimuli that evoke maximal anxiety. In addition, the client is exposed to these stimuli for prolonged periods of time, until anxiety has begun to dissipate. Flooding typically is conducted *in vivo*, with live presentation of anxiety-provoking stimuli. The duration of each session varies depending on the client's presentation, with a typical session lasting anywhere from 90 to 180 minutes. The length of the session is not predetermined but instead is dictated by the client's level of anxiety. In addition, the number of sessions is not fixed but instead is based on the client's anxiety level. Research suggests that significant symptom reduction generally occurs following 10 to 15 hours of exposure. Throughout the flooding procedure, anxiety symptoms should be consistently monitored via physiological assessment or client subjective

ratings of distress. Sessions typically are spaced close in time (e.g., daily or several times per week) rather than scheduled at weekly intervals.

This general definition of flooding belies the many variations of the technique that have been reported in the literature. Overall, many central features, including the method and intensity of stimuli presentation, as well as the use of response prevention techniques, may vary while still being considered flooding. Rather than consider flooding one technique, it may more properly be considered a collection of techniques that are designed to expose clients to anxiety-inducing stimuli with the purpose of reducing anxious responses. A description of the variations of flooding is required to fully understand this collection of techniques.

A. *In Vivo* versus Imaginal Flooding

Clients may be exposed to actual feared stimuli (*in vivo* flooding) or may be asked to picture feared stimuli (imaginal flooding). Deciding which procedure to employ requires clinicians to consider practical matters as well as prior research. Overall, studies have found that *in vivo* exposure is superior to imaginal exposure in reducing anxiety symptoms. In particular, for simple phobias, anxiety reduction is clearly enhanced with *in vivo* exposure. However, *in vivo* stimuli presentation has been found only marginally superior to imaginal exposure for obsessive-compulsive symptoms.

Logistically, setting up *in vivo* exposure situations may be difficult when the fear involves remote or unpredictable stimuli (e.g., fear of earthquakes). Further, it may be impossible to arrange *in vivo* exposure to existential fears (e.g., fear of dying). Finally, due to the anxiety-inducing nature of treatment, clients may be more reluctant to engage in live exposure situations, at least initially. However, imaginal exposure also has its difficulties. First, not all clients are capable of evoking anxiety-inducing images in sufficient detail or for sufficient periods of time, which may necessitate time-consuming imagery training. Second, clinicians never will be able to fully ensure treatment adherence with imaginal exposure, as such procedures are assessed only via self-report. In other words, it is impossible for clinicians to accurately assess the clarity and duration of imagery, as well as whether the client is avoiding focusing on the anxiety-invoking image.

B. Graduated versus Intensive Stimuli Presentation

Clients may be exposed to stimuli in a graduated fashion, beginning with a stimulus that induces little

anxiety, or in an intensive fashion, beginning with a stimulus that is maximally anxiety-provoking. The decision on which format to follow should be based on prior research and practical concerns. Research has demonstrated that either format is effective in reducing overall anxiety symptoms, both immediately following treatment and after a short interval. However, one study found that intensive exposure appears more effective in the long run: 5 years posttreatment, 76% of the intensive exposure group and 35% of the graduated exposure group remained free of anxiety symptoms for the treated stimulus. Surprisingly, in comparison to reports from the intensive exposure group, clients who received graduated exposure reported that the procedure was more distressing overall.

Despite research supporting effectiveness of the intensive approach, a decision to utilize this format must be tempered by the acceptability of the approach to clients. Studies have found that the graduated approach produces fewer clients leaving treatment prematurely. The intensive approach, due to its high anxiety-provoking format, may be intimidating to clients, at least initially.

C. Response Prevention versus Exposure Alone

Typically, flooding involves both exposure to a feared stimulus and a response prevention component. In other words, once exposed to the stimulus, clients are prevented from responding with escape or avoidance behaviors. It was believed that allowing clients to avoid focusing on the anxiety or to escape the flooding situation prior to anxiety reduction would only increase anxiety symptoms. Prevention of escape or avoidance behaviors was once considered the hallmark of flooding procedures. However, more recent research has suggested that exposure alone may be as effective as exposure with response prevention.

Studies on the role of avoidance behaviors have examined the use of distraction techniques (e.g., playing video games, spelling tasks) or medications (e.g., anxiolytics) during flooding procedures. Cognitive distraction techniques allow clients to avoid focusing on their feelings of anxiety. Anxiolytics, which are designed to reduce anxiety symptoms, may prevent anxiety induction and allow clients to avoid focusing on feelings of anxiety during flooding. Research has found that distraction provides more rapid decrease in both subjective reports of anxiety and in avoidance responses immediately following treatment and at short-term follow-up. In addition, research has found that concurrent use of anxiolytic medications and flooding was effective in reducing

subjective reports of anxiety symptoms, particularly early in treatment.

Studies on the role of escape behavior have found that flooding is effective in reducing overall levels of anxiety even if clients are allowed to terminate flooding sessions when their anxiety reaches unduly high levels. In other words, research has found that keeping a client in the session until anxiety decreases (within-session reduction of anxiety) is not necessary for successful treatment outcomes. In addition, clients allowed to escape the anxiety-inducing situation reported more perceived control and less overall fear during the flooding session than clients who were told to remain in the situation.

Taken together, these studies suggest that long periods of unavoidable or inescapable anxiety are not essential for anxiety reduction. In addition, it appears that clients may find exposure alone without a response prevention component to be more acceptable and less distressing.

D. Summary of Variations

Given the many variations of flooding, clinicians must, in collaboration with clients, make difficult decisions as to which method to employ. Research has not provided a clear answer regarding which variation works best with which client. In general, *in vivo* flooding with intensive presentations of stimuli appears to be most effective with the majority of clients. Requiring clients to remain in high-anxiety situations for long periods of time, once considered the hallmark of flooding, no longer appears necessary.

Once a clinician and client agree on the preferred flooding method, many unanswered questions remain regarding the optimal presentation of the technique. Although most researchers agree that massed sessions are more effective than spaced sessions, optimal frequency of sessions has not been determined. In addition, debates are ongoing over the necessity of clinician-directed individual sessions. Research supports the idea that flooding is as effective with group sessions as it is with individual sessions. In addition, research has found that self-directed flooding may be as effective as therapist-directed flooding, albeit somewhat less rapid.

II. THEORETICAL BASES

To understand how flooding is believed to work, acquisition and maintenance of fear or anxiety first must be considered. Orval H. Mowrer developed a two-factor theory that incorporates both respondent and operant

conditioning principles. He posited that fear originally is learned through respondent conditioning but maintained through operant conditioning. A person learns to fear a previously neutral stimulus when it is paired over time with an aversive unconditioned stimulus. Once this conditioned stimulus elicits fear, the person will engage in escape or avoidance behavior in an attempt to reduce fear or anxiety. Successful reduction in fear or anxiety reinforces escape or avoidance behaviors, increasing the likelihood that they will be repeated in the future.

Based on the two-factor model, flooding is believed to work to reduce anxiety by the process of extinction. Extinction is defined as repeatedly presenting a conditioned stimulus without an unconditioned stimulus; over time, the conditioned response will diminish. During flooding, the person experiences no aversive event with the presentation of the feared stimulus. Repeated and continual presentation of the conditioned stimulus without the unconditioned stimulus results in extinction of the fear response over time.

Traditionally, theorists have touted the necessity for both within-session and between-session extinction for flooding to be effective. In other words, it was believed that successful flooding entailed diminishment of anxiety both within a single flooding session and across several sessions. As previously indicated, research has not consistently supported this belief, as some studies have found that within-session reduction of anxiety is not necessary for successful outcomes. However, it should be noted that the majority of studies support the view that the combination of within- and between-session extinction increases the likelihood of positive treatment outcomes.

Although extinction is the predominant theory regarding the mechanisms of flooding, Edna Foa and Michael Kozak offered an alternative view based on emotional processing theory. Briefly, this theory stated that anxiety-provoking stimuli reactivate a fear memory from some earlier trauma. During treatment, incompatible information is presented to the client, in that the client is exposed to feared stimuli without negative outcomes. This information is incorporated into the fear memory, so that a new memory is formed. In other words, Foa and Kozak posited that it is the processing and incorporation of corrective information that is the mechanism for reducing anxiety or fear during flooding, rather than simple extinction. Their model includes a cognitive component that is not discussed in the extinction literature.

One final issue should be noted regarding the theoretical bases of flooding. Flooding frequently has been confused with other anxiety-reduction techniques, such as

systematic desensitization and implosion. Although there is much procedural overlap among these techniques, there are some significant theoretical differences.

Systematic desensitization is a behavioral technique that involves short periods of exposure to feared stimuli, which are presented in a graduated or hierarchical fashion. As previously discussed, flooding may utilize either a graduated or intensive presentation of anxiety-inducing stimuli. Therefore, the major difference between flooding and systematic desensitization lies not in procedural differences but in the theoretical mechanisms believed to underlie the techniques' effectiveness. In systematic desensitization, clients are taught a competing response (i.e., progressive muscle relaxation), so that feelings of anxiety experienced while undergoing treatment may be minimized. Joseph Wolpe, the developer of systematic desensitization, advocated the theory of reciprocal inhibition, the idea that it is impossible for a person to feel both anxious and relaxed at the same time. He concluded that anxiety could be reduced by inducing a relaxed state and then slowly introducing anxiety-invoking stimuli; due to reciprocal inhibition, the relaxed state would inhibit the anxious responses. As previously discussed, flooding is presumed to operate due to extinction processes rather than reciprocal inhibition.

Implosion is a technique developed by Thomas Stampfl and Donald Levis, based on psychodynamic theory. In flooding, no attempt is made by the clinician to construct scenarios that elaborate or expand on the situations described by the client. Implosion, on the other hand, involves exploring clients' childhood memories and developing hypothesized cues based on repressed childhood trauma. Hypothesized cues may involve Oedipal situations, death wish impulses, and fears of castration, to name a few. Implosion imaginably exposes clients to horrific situations, including bodily injury, world annihilation, universal condemnation, and abandonment, in an attempt to induce maximal levels of anxiety. Psychodynamic theory underlying implosion requires use of hypothesized cues, whereas the behavioral theory behind flooding generally eschews these hypothesized cues for cues based on current symptom presentation.

III. EMPIRICAL SUPPORT

Flooding was introduced to the psychological literature via animal studies. In one early study, rats were conditioned to avoid electric shock in one half of a cage

by moving to the other side of the cage when a buzzer sounded. After conditioning, the buzzer was continually sounded while the rats were prevented from emitting the avoidance response by the presence of a barrier in the middle of the cage. After several long trials of continuous stimulus presentation along with response prevention, the rats no longer exhibited the avoidance response in the presence of the buzzer when the barrier was removed. Human studies quickly followed, including numerous case reports in which adult subjects were successfully treated via flooding for examination panic, snake phobia, and spider phobia.

Since that time, many studies have been done establishing the effectiveness of flooding for the treatment of anxiety symptoms. Flooding has been found effective in treating adults with the following anxiety disorders: obsessive-compulsive disorder, simple phobias, social phobia, agoraphobia, posttraumatic stress disorder, and panic disorder. For example, in a 1993 meta-analysis, George Clum, Gretchen Clum, and Rebecca Surls found that flooding was the treatment of choice for panic disorder, showing better results than other psychological techniques (such as systematic desensitization) or medications. In a 1995 review, Melinda Stanley and Samuel Turner concluded that flooding was the treatment of choice for obsessive-compulsive disorder, resulting in greater reduction of anxiety symptoms, decreased drop-out rates, and decreased relapse rates over time than other psychological techniques or pharmacological treatments. Across all anxiety disorders, flooding has been found to be effective in the 60 to 75% range. Longitudinal studies have reported that symptom improvement may last up to 9 years.

There have been few studies examining efficacy of flooding with children. Research that has been conducted has demonstrated that flooding is effective in treating childhood obsessive-compulsive disorder, posttraumatic stress disorder, specific phobias, and panic attacks. Results should be interpreted with caution, as prior research has focused solely on case studies. To date, no large-scale group study examining long-term outcome has been conducted with children.

Research has not supported a common belief among clinicians that flooding inevitably retraumatizes clients or further exacerbates problems. It is true that brief exacerbation of anxiety symptoms may occur throughout treatment as the client is exposed to feared stimuli or situations. Overall, however, studies have found that negative side effects of flooding are extremely rare. In one survey of practitioners, only 9 out of 3493 clients undergoing flooding techniques experienced any negative

effects. The complications that did occur were serious, however, and included exacerbation of vegetative depressive symptoms, increased suicidal ideation, relapse of alcoholism, and precipitation of panic disorder. It is likely that comorbidity with other Axis I disorders increases the risk of negative outcome of flooding. Therefore, flooding may not be the treatment of choice if, in addition to anxiety symptoms, the client is diagnosed with Major Depressive Disorder or Substance Abuse/Dependence. There are no known studies that have demonstrated an increased risk of physical problems due to flooding. However, it is possible that intense exposure to anxiety-inducing stimuli may aggravate medical conditions such as high blood pressure and asthma. Therefore, clinicians should require clients with physical ailments or on medications to obtain medical clearance prior to implementing flooding techniques.

IV. SUMMARY

Overall, flooding has been found effective in reducing anxiety symptoms with both children and adults. In addition, flooding techniques are relatively brief and results may be long lasting, making flooding an extremely cost-effective treatment. As previously reported, flooding has been found to be effective in the 60 to 75% range across all anxiety disorders.

Although flooding is the treatment of choice for many anxiety symptoms, it should not be the first treatment employed when anxiety is due to a skill deficit. In that case, the deficit should be remedied by skill-building techniques prior to assessing the need for anxiety-reducing therapies. Flooding may not be successful in cases where the client is in the process of seeking compensation for trauma (e.g., via a lawsuit, worker's compensation). In a case where compensation is dependent on continued demonstration of symptoms, the client may sabotage treatment efforts, making it unlikely that any therapy technique would be effective.

Despite positive research results, flooding may not be frequently employed by clinicians for two main reasons. First, there is a widely held belief that flooding results in negative side effects. Although rare, it is true that serious negative side effects have occurred during flooding, including the exacerbation of existing Axis I symptoms. To prevent this, clinicians should not employ flooding as a first-line treatment with clients with comorbid Major Depression or Substance Abuse/Dependence diagnoses.

In addition, clinicians should carefully monitor clients throughout treatment to assess for exacerbation of any comorbid symptoms.

A second reason that flooding may not be frequently employed is the belief that the technique is not acceptable to clients. To address client concerns, all reasonable treatment options as well as the research supporting each option should be presented to clients prior to implementing a treatment plan. The theoretical rationale for flooding should be clearly explained to clients, and clients should be warned that brief exacerbation of anxiety symptoms is to be expected. Clinicians should debunk myths about flooding and reassure clients that they will be allowed to leave the situation if needed. Not only is it unethical to prevent clients from withdrawing from treatment, research has not supported the idea that preventing escape or avoidance responses is necessary for successful outcomes. Finally, clinicians should fully inform clients about the many variations of flooding. It is likely that the options of imaginal and graduated presentations of stimuli would be more acceptable to clients, at least initially. When employed with informed and cooperative clients, flooding may be one of the most effective techniques a clinician has to treat anxiety symptoms.

See Also the Following Articles

Classical Conditioning ■ Danger Ideation Reduction Therapy ■ Exposure ■ Informed Consent ■ Panic Disorder and Agoraphobia

Further Reading

- Craske, M. G., & Barlow, D. H. (1993). Panic disorder and agoraphobia. In D. H. Barlow (Ed.), *Clinical handbook of psychological disorders* (2nd ed., pp. 1–47). New York: Guilford Press.
- Emmelkamp, P. M. G. (1990). Anxiety and fear. In A. S. Bellack, M. Hersen, & A. E. Kazdin (Eds.), *International handbook of behavior modification and therapy* (2nd ed., pp. 283–305). New York: Plenum Press.
- Masters, J. C., Burish, T. G., Hollon, S. D., & Rimm, D. C. (1987). *Behavior therapy: Techniques and empirical findings* (3rd ed.). New York: Harcourt Brace Jovanovich.
- Michelson, L. (1985). Flooding. In A. S. Bellack & M. Hersen (Eds.), *Dictionary of behavior therapy techniques* (pp. 126–131). New York: Pergamon Press.
- Miltenberger, R. G. (2001). *Behavior modification: Principles and procedures* (2nd ed.). Belmont, CA: Wadsworth/Thomson Learning.
- Mowrer, O. H. (1960). *Learning theory and behavior*. New York: John Wiley & Sons.

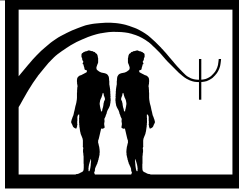

Formulation

Tracy D. Eells

University of Louisville

- I. Description
 - II. History and Influences
 - III. Structured Formulation Methods
 - IV. Summary
- Further Reading

I. DESCRIPTION

A psychotherapy formulation links descriptive diagnosis to treatment. It contains inferences representing the therapist's best explanation of the causes, triggers, and maintaining influences of a patient's problems. As the result of two trends, formulation has become more important in recent years. First, the predominance of brief psychotherapy has required therapists to determine a treatment focus early. Second, the current nosology of mental disorders is almost exclusively descriptive rather than etiological in nature, leaving a gap between diagnosis and treatment that formulation is meant to fill. A formulation is a "work in progress" that changes as it is tested and as more information about a patient is revealed. As an organizational tool, a formulation helps the therapist categorize information about a patient; in particular, it can bring disparate pieces of information into a coherent whole. The specific categories used will depend on the formulation approach of the therapist, but may include symptoms and problems; events that precipitate symptom or problem onset; concepts of self and others; maladaptive interpersonal behavior patterns; methods for controlling ideas and affect; strengths and resources, wishes and fears; biological or constitutional influences; environmental circumstances; and developmental factors.

A formulation is useful to the extent that it accurately guides the therapist's interventions and facilitates a favorable outcome. A well-developed formulation enables the therapist to maintain a focus in treatment, to

GLOSSARY

- central relationship pattern* Repeated and maladaptive ways of initiating and maintaining important interpersonal relationships, presumed to be based on early interpersonal experiences and innate dispositions.
- core beliefs* Organizing beliefs or schemas about the self, others, and the world that are presumed to precipitate and maintain psychological problems.
- functional analysis* Causal relationships among a patient's problematic behavior, goals, affects, and cognition.
- states of mind* Recurrent and distinct complexes of affect, cognition, experience, and behavioral propensities.

Case formulation is a core psychotherapy skill that posits hypotheses about the causes, precipitants, and maintaining influences of a person's psychological, interpersonal, and behavioral problems. A formulation helps organize information about a person. It serves as a blueprint guiding treatment, as a marker and predictor of change, and as a structure facilitating the therapist's understanding of and empathy for the patient's intrapsychic, interpersonal, cultural, and behavioral world.

construct language effectively, and to anticipate events in therapy so as to respond more effectively if those events occur. Therapy goals are embedded explicitly or implicitly in a formulation. Therefore, the formulation enables the patient and therapist to track progress and to identify and correct missteps. A key advantage of a formulation is that it helps the therapist to understand and therefore to empathize with a patient.

Ideally, a clinician should aspire to four goals when constructing a case formulation. First, the formulation should paint a distinct portrait of a unique individual; it should not describe a person or a patient in general. At the same time, it should remain consistent with current scientific knowledge about personality, psychopathology, development, and interpersonal relationships. Second, as a fundamentally practical tool, a formulation should be parsimonious and just comprehensive enough to explain the patient adequately for the purposes of the therapy. The formulation should not contain excessive or extraneous information or be so complicated that it fails as a practical guide to treatment. Utility is a key objective. Third, a formulation should strike the right balance between observation and inference. Low-level inferences are usually best for effective therapy. These are inferences that are tightly linked to readily observable behavior, but go beyond those observations to a construction of their meaning and consequences. Inferences that go “too deep” may lack sufficient empirical foundation and may not be meaningful or helpful to patients. A fourth characteristic of an ideal formulation is objectivity. A formulation should be about the patient and not the therapist. Psychologists have documented many biases in clinical judgment that therapists are prone to commit. For example, a therapist may assume that a patient is either too much like the therapist or too different. Psychoanalysts have long cautioned about the risk of therapists imposing their own psychological needs, characteristics, or problems on patients rather than seeing those patients more objectively.

A few practical details about case formulation may be helpful. First, a formulation should be written down, referred to during treatment, and revised when necessary; otherwise, the therapist is like a builder without the benefit of blueprints. Second, a case formulation should be constructed systematically early in therapy. Typically, a formulation can be constructed after the first one or two sessions, and certainly within the first five sessions. Research suggests that formulations constructed early in therapy predict topics discussed much later in long-term therapy. With practice, a formulation can be constructed within a matter of a

few minutes using notes and memories from early sessions. Efficient and high-quality work is facilitated by having an *a priori* set of formulation categories or “bins” in mind that one “fills in” based on information provided by the patient and others. The formulation systems described later in this article provide examples. Research has shown that a formulation is more likely to be reliable and accurate when the therapist is guided by a structured and systematic formulation method.

Some therapists avoid formulations for fear that they may limit the therapist’s openness to new experiences of the patient, may lead to a rigid view of the patient, or may place the therapist in an unsalutary dominant, powerful role. On the contrary, a well-constructed and well-implemented formulation should facilitate openness to the patient, and should help the therapist develop and communicate empathic understanding in the context of a collaborative, mutually respectful relationship. As an expert in interpersonal communication and psychological problem solving, the psychotherapist should avail himself or herself of the “tools of the trade” to facilitate the work.

Therapists sometimes wonder whether and how a formulation should be shared with patients. In a sense, the entire therapy can be viewed as the construction, revision, and imparting of the formulation. Yet the question remains as to how explicitly the written formulation should be shared in a single session or intervention. Opinions are divided on this question. Some, such as Anthony Ryle who developed cognitive analytic therapy, recommend that the entire formulation be shared with the patient and serve as an explicit center point guiding the therapy. Others believe that sharing the entire formulation in one intervention is unwise because it may overwhelm a patient, may be too much to assimilate at once, may be used by the patient in nontherapeutic ways, or may be less therapeutic than letting the patient arrive at the formulation on his or her own terms. Instead, these practitioners advise that the therapist select portions of the formulation and offer them in succinct interventions that are timed to match the current topic under discussion and the emotional state of the patient. Whichever approach one chooses, the intervention should enhance the therapeutic alliance rather than detract from it. Further, one should not offer the entire formulation until one is reasonably confident of its accuracy.

II. HISTORY AND INFLUENCES

The modern psychotherapy case formulation can be traced to the medical examination and case history,

which are rooted in Hippocratic and Galenic medicine. Hippocratic physicians emphasized viewing the individual as a whole in arriving at a diagnosis, and encouraged the patient's active involvement in his or her cure. In contrast to their forebearers' beliefs in polytheism and mythological causes of disease, they based conclusions on observation, reason, and the belief that only natural forces are at play in disease. Hippocratic case reports provided many observable details about physical functioning, then drew inferences from these observations before prescribing treatment. Galen's contribution to modern medicine was his emphasis on experimentation and a focus on physical structure and function as the foundation of disease.

Consistent with the tradition of Hippocrates and Galen, psychotherapy case formulations depend on close observation as a basis for inference. In accord with the holistic ethos of Hippocrates, a formulation should consider the patient from multiple dimensions, including the biological, psychological, and social. Also consistent with the Hippocratic view, psychotherapists view active patient involvement in treatment as essential for success. Galenic influences are seen in inferences about psychological structure, including concepts such as the id, ego, and superego, and more cognitive concepts such as self-representations, faulty reasoning processes, and maladaptive core beliefs about the self, others, and the world.

The content of a case formulation is influenced by multiple factors. Chief among these is the therapist's world view, that is, the basic axiomatic tenets that guide the therapist's assumptions about people, the world, and the future. The therapist's world view, in turn, influences and is influenced by the therapist's opinions on the nature of psychopathology, and his or her approach to psychotherapy and how it works. A third influence is recent case formulation research. It is to these three influences that I now turn.

A. Nature of Psychopathology

What the therapist defines as adaptive or maladaptive behavior will affect how problems are defined and conceptualized in a case formulation. Views of psychopathology fall into two general classes: categorical and dimensional. Those favoring the categorical view believe that mental disorders are syndromal and are qualitatively distinct from each other and from nonpsychopathological states. The dimensionalist view is that psychopathology lies along a set of continua from normal to abnormal. The difference between normal and abnormal behavior is viewed as one of degree rather than of quality.

The therapist's stance on the categorical–dimensional debate can affect the formulation in a number of ways. First, it may affect the terminology appearing in the formulation. Dimensionalists tend to think in terms of a relatively small set of dimensions, such as the five-factor model of personality. The categoricalists use a broader range of terms, including those in the *Diagnostic and Statistical Manual of Mental Disorders, 4th edition (DSM-IV)*, which is categorical in nature. On the other hand, categoricalists may be more prone to stigmatize patients by reifying what is actually a theoretical construct. For example, being told one “has” a personality disorder may inadvertently damage self-esteem and confirm pathogenic beliefs rather than be therapeutic. Finally, some argue that the categorical approach is easier to use than the dimensional approach because many clinical decisions are categorical in nature (e.g., treat or not, use intervention A or B). Ease of use is an important consideration because a case formulation must often be developed quickly.

A therapist's criteria for defining normality are also central to the task of case formulation. Common criteria include personal distress, behavior that causes distress in others, capacity to adapt to stress, deviation from an ideal of normality, personality inflexibility, and irrationality. These criteria provide a context and reference point for understanding patients and for setting therapy goals.

B. The Therapist's Approach to Psychotherapy and How It Works

One's approach to psychotherapy provides a framework for conceptualizing patients. Psychoanalysis has had a pervasive effect on views of personality and psychopathology, as well as on our understanding of the psychiatric interview. Before Freud, the psychiatric interview was viewed simply as an opportunity for the patient to report his or her symptoms. Now, we recognize the interview as a vehicle through which the patient's problems express themselves; that is, interpersonal problems outside of therapy may be enacted within the therapy.

Like psychoanalysis, cognitive therapy has provided a lexicon for case formulation, and sets of standardized formulations of psychopathology, particularly for depression, anxiety, substance abuse, and personality disorders. These formulations emphasize cognitive patterns, schemas, faulty reasoning processes, and core beliefs, each specific to particular disorders.

Behavior therapy has typically not emphasized diagnosis or formulation, but nevertheless has affected the case formulation process through its emphasis on

symptoms, a skepticism toward mental representations, and a focus on empiricism. Behaviorists strive to understand the topography of symptomatology, including stimulus-response connections, behavioral chains, and contingencies of reinforcement. Behaviorists have also focused on the role that environmental conditions play in maladaptive behavior. Consequently, behavioral formulations include analyses of the environment and how it might be changed to help an individual.

Phenomenological and humanistic psychotherapies have also influenced the case formulation process. Like behavior therapy, they traditionally have rejected case formulation, although on grounds that it can position the therapist in a superior, more knowing relation to the patient and foster an unhealthy dependency. The contributions of humanistic thought to case formulation are an emphasis on the person instead of a disorder, a focus on the here-and-now experiencing of the therapist and patient, and the view of the patient and therapist as equals, both focused on enabling the patient to achieve greater self-awareness and congruence within the self. Humanistic psychology's holistic approach to the person, following from the Hippocratic tradition mentioned earlier, is also an influence.

C. Case Formulation Research

A final influence on the case formulation process is that it has come under much greater scientific scrutiny in the last several decades. The key questions asked are the following: Can case formulations be constructed reliably and validly? To what extent do formulation-based interventions predict psychotherapy outcome and processes? What does the formulation add to outcome? Can a formulation be used to understand psychopathological states?

In 1966 Philip F. Seitz, a Chicago psychoanalyst, reported a 3-year effort to study the extent to which analysts agree in formulating the same clinical material. Each of six analysts independently reviewed either detailed process notes or a set of dreams from a single case. Each analyst wrote an essay-style narrative addressing the precipitating situation, focal conflict, and defense mechanisms at play in the case. The group distributed the formulations, giving each member the opportunity to revise his work based on the formulation of others, then met weekly to review their findings. The results were largely disappointing in that consensus was reached on relatively few cases.

The primary contribution of Seitz and his colleagues' work is that it has alerted the community of psy-

chotherapy researchers to the "consensus problem." If psychotherapy research aspired to be a scientific enterprise, progress had to be made in the consistency with which clinicians describe a patient's problems and way of managing them. Another contribution of Seitz was his delineation of why the clinicians failed to agree. One key problem was that group members made inferences at overly deep levels that seemed to stray too far from the clinical material, for example, making references to "phallic-Oedipal rivalry" and "castration fears." Seitz also noted that the group relied too much on intuitive impressions and did not systematically and critically check their interpretations.

Seitz's paper achieved its stated goal and sparked research efforts to improve methods of case formulation. In the following decades, at least 15 formal methods for constructing case formulations were developed and empirically tested. Most of these methods share several characteristics: They focus on relationship interactions expressed in psychotherapy sessions; they identify core relationship conflicts based on the frequency with which patterns are conveyed in therapy; they rely on clinical judgment rather than rating scales; they include provisions for testing the reliability and validity of the method; they emphasize relatively low-level inferences; the formulation task is broken down into components; and they reveal a trend toward psychotherapy integration. The following section describes some of these methods.

III. STRUCTURED FORMULATION METHODS

A. Core Conflictual Relationship Theme

The first of the structured formulation methods, the Core Conflictual Relationship Theme (CCRT), was introduced by Lester Luborsky in 1976. The CCRT is based on Freud's concept of transference, which states that innate characteristics and early interpersonal experiences predispose a person to initiate and conduct close relationships in particular ways and in repeated fashion later in life. The goal of the CCRT is to reliably and accurately identify a patient's central relationship pattern. The CCRT focuses on narratives a patient tells in therapy, identifying three key components within those narratives: an individual's wishes, expected responses of others, and responses of the self. The CCRT is applicable in everyday clinical use as well as in research. In day-to-day clinical use, therapists may note the relationship

components as they arise in therapy, then infer a CCRT later. In the research context, trained judges first extract relationship episodes from therapy transcripts; a second set of judges then identifies each of the three key relationship components just mentioned. The CCRT is operationally defined as the most frequently observed wish, response of other, and response of self, regardless of whether these components occur sequentially in the separate narratives. Based on a mixed group of patients in multiple studies, the most frequent CCRT is a wish to be close and accepting, a response from others of rejection and opposition, and a response of the self marked by disappointment, depression, and anger. Due to its complexity, Luborsky does not recommend that therapists offer patients the entire CCRT in a single intervention, but rather select portions that are most likely to be accepted by patients in the current context of the therapy. He also recommends that therapists link the CCRT to symptoms; focus primarily on wishes and responses from others because these are the most reliably identified components; and focus on negative components of the CCRT but in a manner that enhances the therapeutic alliance.

The CCRT is the most frequently researched of the structured case formulation methods. Luborsky and his colleagues found adequate to good reliability in identifying the three components, but particularly the wish of self and response of other. Other CCRT-related research findings are that about four narratives are typically told in a therapy session; interventions based on a patient's CCRT predict psychotherapy outcome; gaining mastery of the CCRT is associated with successful outcome in therapy; CCRTs derived from dreams are similar to those derived from waking life; narratives told outside of a session are similar to those told in sessions; CCRTs show consistency across the life span and across the course of psychotherapy, although successful treatment is correlated with a decrease in the pervasiveness of the CCRT (i.e., the extent to which it characterizes multiple relationships); greater pervasiveness of the CCRT is associated with greater psychopathology; and symptom onset seems closely related to central interpersonal conflicts of patients as measured by the CCRT.

B. Configurational Analysis

Configurational Analysis (CA), developed by Mardi J. Horowitz, is similar to the CCRT in its focus on identifying a central relationship pattern, but adds important elements. These are inferences about a patient's states of mind; the assumption of multiple rather than single relationship patterns; and defensive control processes.

States of mind are recurrent and distinct complexes of affect, cognition, experience, and behavioral propensities. They can be described in simple adjectival terms, such as "depressed and helpless" or "angry and bitter"; in motivational terms (a wished-for or feared state); or according to the degree of affect modulation characterizing the state. According to Horowitz, states of mind are organized by mental representations that guide interpersonal relationships and concepts about the self and others. These representations can be depicted in configurations of role relationship models that describe wished-for, "dreaded," and either adaptive or maladaptive compromise relationship patterns, views of self and others, and states of mind. CA also includes a system for formulating an individual's defensive control processes, which are habitual ways of controlling ideas and affect so as to maintain a well-modulated state of mind.

The formulation steps in CA move from description to increasing degrees of inference. They are to (1) describe clinically relevant phenomena; (2) identify the patient's repertoire of states of mind; (3) identify self, other, and relationship schemas; and (4) identify defensive control processes. Finally, the therapist plans goals and interventions specific to each of these categories.

Research on CA has shown a similar level of reliability as that shown by the CCRT, although the studies are fewer as are subjects per study. Convergent validity for CA as well as for CCRT is suggested by the high level of similarity between formulations independently constructed with each system. Horowitz and colleagues have also provided evidence that states of mind can be reliably coded. In a series of quantitative single-case studies of individuals responding to psychosocial trauma, Horowitz and colleagues found evidence of recurring emotionally significant states; showed that state shifts are related to whether or not a patient is discussing a conflict-laden topic; and showed that increased signs of defensive control processes occur when conflictual or unresolved themes are being discussed in therapy. A series of single-case studies have also shown convergences between clinically derived case formulations and quantitatively derived formulations.

C. Plan Formulation Method

The Plan Formulation Method (PFM), developed by John Curtis and George Silberschatz, follows earlier formulation work by Joseph Caston and is based on Joseph Weiss's control mastery theory of psychotherapy. Control mastery theory assumes that psychopathology results from pathogenic beliefs stemming from traumatic

events that are usually experienced in childhood. Weiss believes that patients develop an unconscious plan to disconfirm these beliefs. The plan may involve testing the therapist through behavioral or verbal challenges or expressions of anger. The therapist must understand the purpose of these events in order to best help the patient.

The goal of PFM is to identify, categorize, and test the key elements of control mastery theory. Five components comprise a plan formulation: the patient's goals for therapy; the obstructions (pathogenic beliefs) that may interfere with achieving the goals; the traumas that produced the pathogenic beliefs; insights necessary to help the patient achieve the goals; and tests the therapist might expect from the patient as the patient attempts to disconfirm a set of pathogenic beliefs. For regular clinical use, these components can be inferred from the early sessions of psychotherapy. For research purposes, coders follow a five-step process. First, three or four judges who are versed in control mastery theory review transcripts from early psychotherapy hours and create a list of "real" and plausible "alternative" items for each formulation component. Second, a master list of goals, obstructions, traumas, insights, and tests is compiled and randomly ordered within each component. Third, the judges review the master list and rank order each item according to its relevance to the patient. Fourth, mean ratings are obtained and rank ordered; those items ranking below the median are discarded. Fifth, the group meets and consensually finalizes the most relevant items for each formulation category. The final formulation contains a description of the patient and his or her current life circumstances followed by the patient's presenting symptoms and problems. Then, the goals, obstructions, tests, insights, and traumas are listed.

The reliability of the PFM is excellent, although adherence among the clinical judges to an explicit conception of psychotherapy appears essential. One interesting study showed that two independent research teams, one working from the control master perspective and the other working from an object relations standpoint, independently developed highly reliable plan formulations, but the two formulations correlated poorly with each other. Several studies have been published showing that the degree of therapist's adherence to the plan formulation predicts patient progress and outcome in psychotherapy. Patients appear to deepen their level of experiencing subsequent to plan-compatible interventions as compared to plan-incompatible interventions. Other studies show that achieving goals and insights, as listed in the formulation, correlates with standard psychotherapy outcome measures.

D. Other Primarily Dynamic or Integrative Methods

The CCRT, CA, and PFM are representatives of psychodynamic-based structured formulation methods. Another in this class is Thomas Schacht and colleagues' Cyclical Maladaptive Patterns (CMP) approach, which helps organize interpersonal information about a patient. This method has four major components: acts of self, expectancies of others' responses, acts of others toward the self, and acts of the self toward the self. Recently, the CMP has been integrated with Lorna Benjamin's Structural Analysis of Social Behavior, a system for organizing interpersonal behaviors.

Another dynamic formulation method is J. Christopher Perry's Idiographic Conflict Formulation Method, which draws from Erik Erikson's psychosocial model of development. It places a particular emphasis on a patient's defensive structure. In addition, Anthony Ryle has developed a formulation method based on his cognitive analytic therapy, which integrates dynamic and cognitive therapy. Franz Caspar's Plan Analysis is atheoretical in nature and can be applied to behavioral, dynamic, cognitive, or other forms of psychotherapy. Case formulation methods have also been developed for cognitive-behavioral therapy and behavior therapy. Two examples are now described.

E. Cognitive-Behavioral Case Formulation

Jacqueline Persons is one of several cognitive-behavioral (CB) therapists who have developed case formulation methods, but hers may be the best known. The method draws extensively from Aaron Beck's cognitive therapy, which holds that psychological symptoms and problems result from the activation of maladaptive core beliefs under conditions of stressful life events. The CB case formulation approach also draws from behavior therapy, which emphasizes measurement to track change and the identification of causal, functional relationships among behaviors that lead to problematic behaviors. According to Persons, a CB formulation must contribute to treatment outcome for it to be valuable.

Persons identifies seven steps in CB case formulation. First, the therapist compiles a problem list. She recommends 5 to 10 items that should include psychological symptoms, problems in adaptation, and other problems in living. Second, the formulation should include hypotheses about the patient's core beliefs about the self, others, and the world. These beliefs are assumed to

maintain the patient's problems. Third, the formulation includes precipitants and activating situations that trigger a maladaptive core belief. Next, the therapist formulates a working hypothesis. It is the heart of the formulation and links the preceding components. Step five of the CB formulation states the origins of the maladaptive core beliefs. This section could include two or three key incidents in the individual's past. Step six states a treatment plan. Finally, the CB case formulation includes predicted obstacles to treatment. These may include statements regarding how the patient's core beliefs may undermine the therapy.

Persons has reported data showing average to good levels of agreement among clinicians independently constructing CBT-based formulations. The utility of CBT formulations has been preliminarily assessed by exploring the contribution that individualized formulations have on treatment outcome. Early evidence is equivocal. A study by Persons found that a group of depressed patients treated by her with individualized CBT guided by a CBT case formulation had similar outcomes to patients treated in a much larger study in which similar patients were treated with a standardized CBT protocol. Persons noted, however, that many of her patients had comorbid diagnoses that would have ruled them out for the comparative study.

F. Behavioral Case Formulation

As noted, behavior therapists emphasize a detailed analysis and evaluation of behavior. They use the term "functional analysis" to describe the clinician's assessment of causal relationships among a patient's problematic behavior, goals, affect, and cognition. Although the emphasis is on readily observable behavior including how the environment affects behavior, many behavior therapists also attend to an individual's thoughts and affect, considering these to be important mediating variables leading to behavior problems or solutions. Behavior therapists distinguish between ultimate outcomes and instrumental outcomes. The former reflect global, multidimensional, end-point solutions, such as resolution of a depressive episode. The latter refers to sets of tools that can facilitate achieving the ultimate outcome. For example, a depressive episode may be resolved through increasing social contacts, improving social skills so as to increase social reinforcements, exercise, changing self-beliefs, or decreasing negative automatic thoughts.

Many behaviorists view their work fundamentally as a problem-solving endeavor, and the role of the case formulation is to delineate problems, then generate, imple-

ment, and evaluate solutions. Arthur Nezu and colleagues have articulated a four-step case formulation process centering on a problem-solving approach. Step one is to identify the problem. Nezu advocates a comprehensive, systematic approach in order to reduce clinical judgment error. Problems may occur either within the individual or the environment. Within the person, problems may occur in the behavioral, cognitive, affective, or biological realms. Problem behaviors reflect deficits (e.g., lack of social skills) or excesses (e.g., obsessive-compulsivity). Problematic cognition may reflect deficiencies (e.g., failure to appreciate the responses of others to one's actions) or distortions (e.g., arbitrarily inferring lack of self-worth based on a single mistake). Environmentally, problems may be identified in the physical realm (e.g., housing, financial) or social realm (e.g., dangerous neighborhood, nature of social support). A behavior therapist may also view problems from a temporal standpoint (present to past) and with regard to the source of information (factual and well-substantiated versus the perceptions and assessments of a patient). Step two is to generate solution alternatives. Here, the clinician may encourage brainstorming for solutions. This involves producing numerous possible solutions and suspending judgment as to their quality until after the list is completed. Step three is to plan treatment. The key question the clinician tries to answer is, "What treatment strategies and tactics will best implement the solution alternatives selected in step two?" The clinician must determine how amenable the target problem is to treatment; whether the therapist is capable of providing the treatment and if not, whether the treatment is available elsewhere; and whether reaching the selected instrumental objective to solve a target problem will achieve the ultimate objective. Step four is solution implementation and verification. This step involves putting the planned solution into effect, assessing the consequences of the plan, and evaluating its effectiveness.

To date, no studies have been published showing the reliability of the method just described or similar methods, although they have been called for. Some behaviorists assert that a hypothesis-testing approach in which early interventions and their outcomes are assessed, and altered as needed, is more important than initial agreement.

IV. SUMMARY

Formulation is a basic psychotherapy skill that involves generating and testing hypotheses about the

causes of and factors perpetuating a patient's problems. The formulation guides treatment and is revised as necessary. Several reliable, structured methods of case formulation have been developed and empirically tested.

See Also the Following Articles

Applied Behavior Analysis ■ Behavioral Assessment
 ■ Behavioral Case Formulation ■ Configurational Analysis
 ■ Contingency Management ■ Functional Analysis of Behavior
 ■ Functional Analytic Psychotherapy ■ Objective Assessment ■ Projective Testing in Psychotherapeutics

Further Reading

- Caspar, F. (1995). *Plan analysis: Toward optimizing psychotherapy*. Seattle, WA: Hogrefe & Huber.
- Eells, T. D. (Ed.). (1997). *Handbook of psychotherapy case formulation*. New York: Guilford Press.
- Horowitz, M. (1997). *Formulation as a basis for planning psychotherapy treatment*. Washington DC: American Psychiatric Press.
- Luborsky, L., & Crits-Christoph, P. (1998). *Understanding transference: The CCRT method* (Rev. ed.). Washington, DC: APA Books.
- McWilliams, N. (1999). *Psychoanalytic case formulation*. New York: Guilford Press.
- Nezu, A. M., & Nezu, C. M. (Eds.). (1989). *Clinical decision making in behavior therapy: A problem-solving perspective*. Champaign, IL: Research Press.
- Persons, J. B. (1989). *Cognitive therapy in practice: A case formulation approach*. New York: W. W. Norton.
- Ryle, A. (1990). *Cognitive analytic therapy: Active participation in change*. Chichester, England: John Wiley & Sons.

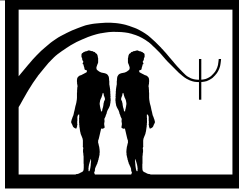

Forward Chaining

Raymond G. Miltenberger

North Dakota State University

- I. Description of Treatment
 - II. Theoretical Bases
 - III. Empirical Studies
 - IV. Summary
- Further Reading

each behavior in the chain, there is a discriminative stimulus and a response. Also called a behavioral chain or a chain of behaviors.

GLOSSARY

- conditioned reinforcer** A previously neutral stimulus that becomes a reinforcer after it is paired a number of times with an established reinforcer.
- continuous reinforcement** A schedule of reinforcement in which the reinforcer is delivered after every response.
- discriminative stimulus** A stimulus that is present when a particular response is followed by a reinforcer.
- fading** Gradual removal of a prompt as the behavior occurs in the presence of the discriminative stimulus.
- intermittent reinforcement** A schedule of reinforcement in which the reinforcer is not delivered after every response.
- prompt** A stimulus delivered by the trainer following the discriminative stimulus that increases the likelihood that a person will engage in the correct behavior in the presence of the discriminative stimulus.
- reinforcer** A stimulus that increases the future probability of a behavior when it is delivered contingent on the occurrence of the behavior.
- response** One instance of a particular behavior.
- stimulus control** A behavior is under the stimulus control of a particular discriminative stimulus when it occurs in the presence of that discriminative stimulus.
- stimulus-response chain** A behavior that consists of two or more component behaviors that occur in sequence. For

I. DESCRIPTION OF TREATMENT

Forward chaining is a procedure that is used to teach a chain of behaviors (a stimulus-response chain). In forward chaining, you first conduct a task analysis to identify each component of the stimulus-response chain. Then you use prompting and fading to teach the first component of the chain. Once the learner can engage in the first component behavior without prompts, you teach the second component behavior in conjunction with the first component. Once the learner can engage in the first two components of the chain of behaviors without prompts, you teach the third component in conjunction with the first two components. This process continues until the learner can engage in the entire chain of behaviors at the appropriate time without prompts.

Forward chaining, similar to backward chaining, is used with beginning learners (young children) or learners with limited repertoires (for example, individuals with mental retardation). Forward chaining is used when more efficient training strategies, such as instructions or modeling, cannot be used with learners with limited intellectual abilities.

A common example of forward chaining involves teaching a young child to recite the alphabet. A parent typically divides the alphabet into four strings of letters

and uses verbal prompts to teach the child to recite the first string of letters (ABCDEFGH). The child recites the string of letters after the parent's prompt, and the parent provides praise. Once the child can recite this first string of letters without help, the parent adds the second string of letters (HIJKLMN), and the child repeats the first two strings together with praise from the parent. When the child can recite the first two strings of letters without help, the parent adds the third string of letters (OPQRSTU) and the child repeats the first three strings together with praise from the parent. Finally, when the child can recite the first three strings of letters without any help, the parent adds the fourth string (VWXYZ), and the child recites the entire alphabet with praise from the parent. In this case, each of the four strings of letters is a response and the four responses are chained together until the child recites the whole alphabet.

The process of conducting forward chaining is described next.

A. Conduct a Task Analysis

Because each component behavior in a behavioral chain is taught in sequence, the first step in conducting forward chaining is to conduct a task analysis to identify each component behavior. A task analysis identifies each discriminative stimulus (S^D) and response (R) in the chain of behavior from start to finish. Consider the following task analysis of a four-component behavioral chain in which a person with mental retardation stuffs brochures into envelopes as part of her job in a sheltered workshop. In this chain of behaviors, the person (1) first picks up a brochure from a pile of brochures on the table, (2) then picks up an envelope from a pile of envelopes on the table, (3) then stuffs the brochure in the envelope, and finally, (4) puts the envelope containing the brochure into a bin. In a task analysis, each of the stimulus and response components would be identified as follows.

S^D_1 : Pile of envelopes, pile of brochures, and a bin on the table in front of the learner

R₁: Pick up a brochure

S^D_2 : Brochure in hand and pile of envelopes and bin on the table

R₂: Pick up envelope

S^D_3 : Brochure in one hand, envelope in the other hand, and bin on the table

R₃: Insert brochure into the envelope

S^D_4 : Envelope containing a brochure in hand and bin on the table

R₄: Put the envelope containing the brochure into the bin

As can be seen in this task analysis of a stimulus-response chain, the chain of behaviors is initiated when the first S^D (S^D_1) is present, and each response in the chain creates the S^D for the next response in the chain. For example, the first response (R₁-pick up envelope) creates the second S^D (S^D_2 -envelope in hand), the second response (pick up envelope) creates the third S^D (envelope in hand), and so on. The learner cannot engage in each subsequent response until the previous response has occurred and created the S^D for the subsequent response.

A task analysis can be conducted in three different ways. First, you can observe a competent person engaging in the chain of behaviors and write down the sequence of stimulus-response components. Second, you can ask an expert who performs the behavior competently to identify all of the stimulus-response components. Finally, you can engage in the behavior yourself and write down all of the stimulus-response components.

Once you have conducted the task analysis, you can then conduct the forward chaining procedure.

B. Conduct Forward Chaining

To begin forward chaining, you present the first S^D , prompt the first response, and provide a reinforcer such as praise. You then fade the prompts over trials until the learner can engage in the first response without any prompts when the first S^D is present.

From the previous example, you have the learner sit at a table containing a pile of envelopes, a pile of brochures, and a bin (the first S^D), prompt the learner to pick up a brochure (first response), and provide praise (a reinforcer). The prompt might involve physically guiding the learner's hand to pick up the brochure (physical prompt), showing the learner how to pick up the brochure (modeling prompt), pointing to a brochure on the pile of brochures (gestural prompt), or telling the learner to pick up a brochure (verbal prompt). You repeat the trial a number of times and gradually remove the prompt (fade the prompt) until the learner engages in the first response in the presence of the first S^D without prompting.

S^D_1 ----> R₁----> praise

After the learner consistently engages in the first response when the first S^D is present, you add the second component of the chain. To do this, you present the first S^D and the client will engage in the first response (because the first response is under the stimulus control of the first S^D). The first response creates the second S^D . At

this time, you then prompt the second response and provide a reinforcer. In this way, the learner is engaging in the first two component responses in sequence; the first is unprompted because it was previously learned, and the second is prompted after the first response creates the S^D for the second response. Over trials, you fade the prompts until the learner is engaging in the first and second responses in the chain without any prompts.

From this example, you have the learner sit at a table with a pile of brochures, a pile of envelopes, and a bin (first S^D) and the learner will pick up a brochure (first response). Once the brochure is in hand (second S^D), you prompt the learner to pick up the envelope (second response) and provide praise (a reinforcer). Over trials you will fade the prompts until the learner can engage in the first two components of the chain without any prompts.

$$\begin{array}{l} S^D_1 \text{----} \rightarrow R_1 \\ S^D_2 \text{----} \rightarrow R_2 \text{----} \rightarrow \text{praise} \end{array}$$

At this point, you use prompting and fading to teach the third component of the chain. To teach the third component of the chain you present the first S^D (every trial starts with the presentation of the first S^D), and the client will engage in the first two responses in the chain without prompts. The second response creates the third S^D . Following the second response, you prompt the third response and provide praise. Over trials, fade the prompts for the third response until the learner makes the first three responses in the chain without any prompts.

From this example, have the learner sit at the table with the pile of brochures, envelopes, and a bin (first S^D). The learner will then pick up a brochure (first response) and pick up an envelope (second response) without any prompts. Once the learner has engaged in the first two responses and has a brochure and envelope in hand (third S^D), prompt the learner to insert the brochure into the envelope (third response) and provide praise. Fade the prompts over trials until the learner is engaging in the first three responses without any prompting.

$$\begin{array}{l} S^D_1 \text{----} \rightarrow R_1 \\ S^D_2 \text{----} \rightarrow R_2 \\ S^D_3 \text{----} \rightarrow R_3 \text{----} \rightarrow \text{praise} \end{array}$$

Now the first three components of the chain have been learned and it is time to teach the last component of the chain. To teach the fourth response in the chain, have the learner sit at the table with the piles of brochures and envelopes and a bin (first S^D) and the learner will engage in the first three responses without

any prompts. The third response creates the fourth S^D . After the third response, prompt the learner to engage in the fourth response and provide praise. Over trials fade the prompts until the learner is engaging in all four responses without any prompts.

From this example, have the learner sit at the table with the piles of brochures, envelopes, and the bin (first S^D) and the learner will pick up a brochure, pick up an envelope, and insert the brochure in the envelope (first three responses). When the envelope containing the brochure is in the learner's hand (fourth S^D), prompt the learner to put it into the bin (fourth response) and provide praise. Over trials, gradually withdraw the prompts until the learner is engaging in all four responses without any prompts. The learner has now learned the entire chain of behaviors.

$$\begin{array}{l} S^D_1 \text{----} \rightarrow R_1 \\ S^D_2 \text{----} \rightarrow R_2 \\ S^D_3 \text{----} \rightarrow R_3 \\ S^D_4 \text{----} \rightarrow R_4 \text{----} \rightarrow \text{praise} \end{array}$$

Following forward chaining (or any other chaining procedure), the learner should engage in the complete chain of behaviors without any prompts when the first S^D is present. Although the learner can now engage in the chain of behaviors without assistance, it is important to continue providing a reinforcer, at least intermittently, following the completion of the chain of behaviors. During training, a continuous reinforcement schedule is used, and every response is followed by a reinforcer. Once the learner is engaging in the chain of behaviors without any prompts, the schedule of reinforcement can be thinned so that the behavior is maintained with intermittent reinforcement.

In the previous example, the learner gets praised for every correct response during training. Once the learner can complete the entire chain of behaviors without prompts, the trainer continues to provide praise every time the learner completes the chain of behaviors. After the learner successfully completes the chain of behaviors a number of times without any prompts, the trainer can start to use an intermittent reinforcement schedule and provide praise after the learner completes the chain every second time, then every third time, and so on until many responses are required for reinforcement.

II. THEORETICAL BASES

Forward chaining is based on the behavioral principles of stimulus control and conditioned reinforcement.

Stimulus control is present when a response occurs in the presence of an S^D . Stimulus control develops because the response has been reinforced in the presence of the S^D in the past. In forward chaining, you prompt the first response in the presence of the first S^D and reinforce the response. As a result, over a number of trials, the first response is then more likely to occur without prompting when the first S^D is present. The first S^D now has stimulus control over the first response. Next you prompt the second response in the presence of the second S^D and reinforce the response. Over a number of trials the second response will occur when the second S^D is present without any prompts. The second S^D now has stimulus control over the second response, and the first two responses in the chain will occur together. This process continues in forward chaining until each S^D develops stimulus control over each response in the chain of behaviors and all of the responses in the chain occur in sequence.

The second principle involved in forward chaining is conditioned reinforcement. In conditioned reinforcement, a neutral stimulus becomes a conditioned reinforcer when it is paired a number of times with an established reinforcer. In forward chaining, the S^D that is produced by each response becomes a conditioned reinforcer because each response is followed by the delivery of praise from the trainer. As a result, the outcome of each response in the chain (the S^D produced by each response) becomes a conditioned reinforcer and serves to maintain each of the individual responses in the chain of behaviors. This is particularly important in a long chain of behaviors where the reinforcer may occur a long time after the occurrence of the early responses in the chain. Conditioned reinforcement for each response in the chain is also important after the learner has learned the chain of behaviors and intermittent reinforcement is used to maintain the chain of behaviors.

III. EMPIRICAL STUDIES

Forward chaining is one of the three chaining procedures (along with backward chaining and total task presentation) described in major behavior modification textbooks, applied behavior analysis textbooks, and learning textbooks.

A number of studies have evaluated forward chaining procedures for teaching chains of behaviors to individuals with developmental disabilities. For example, Wilson and his colleagues in 1984 used forward chaining procedures to teach family-style dining skills to individuals with profound mental retardation living in an

institution. The authors first conducted a task analysis of the chain of behaviors involved in family-style dining. The components of the chain of behaviors involved in family style dining included the following:

1. Hold bowl with both hands
2. Place bowl within 1 in, from plate
3. Grasp serving spoon
4. Grasp bowl with one hand without hand in food while spoon is in bowl
5. Serve food to plate
6. Replace spoon
7. Grasp bowl with both hands
8. Pick up bowl
9. Place in neighbor's hand or place within 6 in. of neighbor's plate.

After developing the task analysis of the behavioral chain, the authors used forward chaining procedures to teach the mealtime behaviors. Starting with the first response in the chain, the authors used prompting and fading until the learner engaged in the response without prompts. Then they taught the second response in conjunction with the first using prompting and fading procedures. The authors proceeded in this fashion until the learner could engage in the entire chain of behaviors without any assistance.

Another example of the use of forward chaining is the 1982 study by Tom Thompson and colleagues in which the authors taught laundry skills to individuals with developmental disabilities. The authors first conducted a task analysis of the chain of behavior involved in doing laundry and identified 47 responses that they grouped into seven major components. The authors then used prompting and fading to teach the first of the seven laundry components, then the first and second, then the first three, and so on until the individuals were engaging in all seven components without any prompts.

IV. SUMMARY

Forward chaining is one of three procedures used to teach a chain of behaviors. A chain of behaviors involves individual stimulus and response components that occur together in a sequence. Forward chaining is a procedure that is typically used with individuals with disabilities or extremely limited abilities. The first step in forward chaining is to conduct a task analysis that identifies each S^D and response in the chain of behaviors. To conduct forward chaining you use prompting and fading to teach the first component behavior in the

chain. Once the learner engages in the first response without prompts, you teach the second response in conjunction with the first using prompting and fading. Once the learner engages in the first two responses in the chain without assistance, you use prompting and fading to teach the third response in conjunction with the first two. This process continues until the learner can engage in the entire chain of behaviors without assistance. Praise or other reinforcers are delivered on a continuous reinforcement schedule for every correct response during training. Once the learner competently engages in the chain of behaviors without assistance, an intermittent schedule of reinforcement can be used to maintain the behavior.

See Also the Following Articles

Backward Chaining ■ Child and Adolescent Psychotherapy
■ Competing Response Training ■ Fading ■ Habit

Reversal ■ Home-Based Reinforcement ■ Parent–Child Interaction Therapy

Further Reading

- Catania, A. C. (1998). *Learning* (4th ed.). Upper Saddle River, NJ: Prentice Hall.
- Cooper, J. O., Heron, T. E., & Heward, W. L. (1987). *Applied behavior analysis*. Columbus, OH: Merrill.
- Miltenberger, R. G. (2001). *Behavior modification: Principles and procedures*. Pacific Grove, CA: Wadsworth.
- Thompson, T. J., Braam, S. J., & Fuqua, R. W. (1982). Training and generalization of laundry skills: A multiple probe evaluation with handicapped persons. *Journal of Applied Behavior Analysis, 15*, 177–182.
- Wilson, P. G., Reid, D. H., Phillips, J. F., & Burgio, L. D. (1984). Normalization of institutional mealtimes for profoundly retarded persons: Effects and noneffects of teaching family style dining. *Journal of Applied Behavior Analysis, 17*, 189–201.

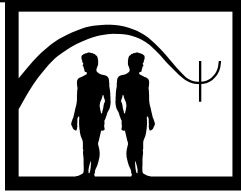

Free Association

Anton O. Kris

Boston Psychoanalytic Society and Institute and Harvard University

- I. Historical Background
- II. Description
- III. Conclusion
- Further Reading

events, structures, and motivations in which there is an active and motivated effort to keep from consciousness certain material.

GLOSSARY

countertransference The feelings and responses that the therapist has towards the patient.

discontinuities A momentary impairment or sudden modification of thought, affect, memory, sensation, self-control, etc., in which unconscious motivations may or may not be expressed.

free association The effort to speak the contents of one's mind free of conscious control, aimed towards social appropriateness, coherence, etc.

fundamental rule The requirements that the patient report or, in the more modern iteration, attempt to report all of his or her associations without editing them and without an effort to make them socially appropriate to express a certain idea or to conform to conventions of coherence and reasonableness.

parapraxis Unintentional lapses in behavior or thinking which are believed to be compromise formations resulting from a conflict between the actor's conscious goals and intentions and unconscious urges seeking expression.

transference The tendency to unwittingly construct and create, through an active but unconscious process, the pattern of imagined and real past relationships with an important person in the present.

unconscious The quality of a mental structure not being available for conscious examination and a system of mental

I. HISTORICAL BACKGROUND

“The technique of free association, considered by many people the most important contribution made by psychoanalysis, the methodological key to its results” as Sigmund Freud stated in 1931, remains central to psychoanalysis and psychoanalytic psychotherapy. Although it has a history in literature and philosophy dating to classical antiquity, free association as an investigative and psychotherapeutic method was Freud's invention in the 1890s. It derived from the cathartic “chimney sweeping” use of unrestricted speech, under hypnosis, by one of the patients of Freud's senior colleague, Josef Breuer. Freud gradually modified the method of free association, discarding massage and hypnosis that were its earlier companions, eventually following the patient's lead rather than introducing a subject of his own. Focusing on the patient's introspections, with the requirement that the patient speak without critical judgment, he created a systematic means to infer unconscious thoughts and feelings. The approach was consonant with his general conviction about the determinism of mental life and the importance of unconscious influences. Going far beyond the original aim of reducing traumatic experiences by abreaction, he turned the new method into a vehicle

for deciphering the language of dreams, parapraxes (Freudian slips), and symptoms and for elucidating inferred unconscious conflicts and the history of their development in the patient's life.

II. DESCRIPTION

An important difference between the method of free association and a directed discussion of problems, is that the free associations provide a basis for inferences of unconscious aspects of the patient's mental life. Discontinuities in the patient's mental functions—impairments of thought, affect, memory, sensation, desire, sense of self, self-control, and personal relationships—can be accounted for in large part by unconscious influences. The free associations are “understood” by recognition of sequences, patterns, and a variety of attributes and characteristics that permit them to be “interpreted.”

Here is an example of free association. A young man, wondering about his own psychoanalytic treatment, thought: What good is a treatment that only uses words? Not taking the question seriously, he went about his business (actually, some early spring work in the garden) and found himself, a few minutes later recalling the well-known lines from “Daffodills”:

*For oft when on my couch I lie,
In vacant or in pensive mood,
They flash upon that inward eye,
Which is the bliss of solitude.*

At that point he recognized that he had returned to his original thought. He was pleased to see that the poet's name, Wordsworth, repeated his original question, and he took the sequence as something of an answer. He was not then aware that the couch in the poem had eliminated the problematic analyst and afforded him the privacy of solitude, which likely reflected some less friendly feelings about psychoanalysis. Both the young man's understanding of “Wordsworth” and the added idea that there was a hostile side to his unconscious thoughts about psychoanalysis constitute inferences about his unconscious motivations.

The term “free association” is used in a number of different ways. In all of these the word “free” connotes a relative freedom from conscious control. So, the activity of free association (i.e., the expression of a sequence of thoughts, feelings, wishes, sensations, images, fantasies, and memories) produces the free as-

sociations (or, more simply, the associations). The method of free association involves two persons, patient and analyst (or therapist). It is an integral part of the psychoanalytic situation. The analyst's first aim is to promote greater freedom of association, that is, relatively greater autonomy from unconscious interferences (resistances) to expression. Together patient and analyst engage in an attempt to understand and modify the patient's mental life, through the consequent process of free association (or analytic process, therapeutic process). Accordingly, the concept of free association touches on all the concepts that are implied in therapeutic process. Transference and countertransference, for example, can be recognized as patterns of association. Their unconscious existence can be inferred from those patterns.

The “fundamental rule” of psychoanalysis was originally stated as the requirement that the patient report all of his or her associations, without editing them, saying whatever came to mind. In his original work on free association, Freud used the associations to interpret to the patient the nature of his or her unconscious motivations, which sometimes brought dramatic relief to patients. This approach led to his study of dreams, which he published in 1900. Inevitably, in the interests of expanded treatment potential, modifications in the analyst's aims have brought about a more complex concept of the analyst's role and activity.

The fundamental rule is now usually presented in a somewhat less authoritarian way. The patient is expected to try to say whatever comes to mind, and part of the attention of the analytic pair is directed toward an understanding of the difficulties in following the rule. To make sense of this “rule” and of the psychoanalytic method, one must understand that the activity of free association is interspersed with an attempt to recognize meaning in the associations, through the interpretive efforts of both the analyst and the patient. The therapeutic method, whose central feature is the understanding of the associations, goes beyond the study of the patient's words to the interpretation of actions and interactions within the psychoanalytic (psychotherapeutic) situation, that is, between the analyst (therapist) and the patient. The analyst's associations and actions (principally, the action of words) are now seen as an integral part of the analytic method.

The stance of the analyst or therapist—his or her attitude to the task and to the patient—is an essential part of the method of free association. A fundamental component of that stance is a commitment on the analyst's part to provide a setting of safety for the patient's free as-

sociation and to channel his or her energies, as much as possible, into understanding the associations and the interactions of the analytic process. Necessarily, the analyst's stance must be a blend of subjectivity and objectivity, of compassion and dispassion, involvement and separateness, although what may be an ideal mixture, for any analyst or for any patient, at any particular time, remains a matter of uncertainty and debate. Variations among analysts on these matters continue to provide fruitful avenues of research into therapeutic effectiveness. Savo Spacal, for example, in 1990, demonstrated differences between Freud's use of free association and that of the relational schools, which, as he saw it, had reduced the introspective emphasis and substituted interpretation of interaction. In practice, the two forms operate together, variably, in most psychoanalytic work.

III. CONCLUSION

These considerations make it hard to define limits for the method of free association. To attempt to distinguish associations from dreams and transferences, for example, seems wholly arbitrary. But even interpretations, whether made by the analyst or by the patient, cannot be reliably distinguished from the associative

flow. It is sufficient to know that the data of free association and the events of the therapeutic process can be understood from a variety of useful perspectives, some of which may pay little regard to associative sequences and patterns, while others attend closely to them.

See Also the Following Articles

Interpretation ■ Psychoanalysis and Psychoanalytic Psychotherapy: Technique ■ Self Psychology ■ Unconscious, The

Further Reading

- Adler E., & Bachant, J. L. (1996). Free association and analytic neutrality: The basic structure of the psychoanalytic situation. *Journal of the American Psychoanalytic Association, 44*, 1021–1046.
- Busch, F. (1994). Free association and technique. *Journal of the American Psychoanalytic Association, 42*, 363–384.
- Kris, A. O. (1982). *Free association: Method and process*. (Revised ed., 1996). Hillsdale, NJ: The Analytic Press.
- Mahoney, P. (1979). The boundaries of free association. *Psychoanalysis and Contemporary Thought, 2*, 151–198.
- Spacal, S. (1990). Free association as a method of self-observation in relation to other methodological principles of psychoanalysis. *Psychoanalytic Quarterly, 59*, 420–436.

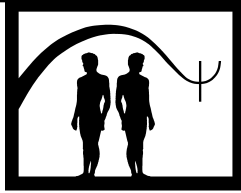

Functional Analysis of Behavior

Kelly G. Wilson and Amy R. Murrell

University of Mississippi

- I. Description of Treatment
- II. Theoretical Bases
- III. Empirical Studies
- IV. Summary
- Further Reading

Functional analysis is an approach that guides treatment decisions. This article provides information about the approach, focusing on the theory from which it developed, and its clinical application. This article also introduces some of the well-validated treatments that make use of functional analysis and provides a clinical example of the process.

GLOSSARY

conditioned stimulus A stimulus that acquires some aversive or appetitive psychological functions as a result of respondent conditioning processes.

discriminative stimulus (S^D) A stimulus (or context) that increases the probability of a given response as a result of a history of reinforcement in the presence of that stimulus and extinction in its absence.

establishing operations (EOs) Operations that have two primary effects on operant responding. First, EOs make a given response more probable. Second, EOs make a reinforcer associated with that response more effective. For example, if a rat has been reinforced for lever pressing with food, food deprivation would be an EO. The establishing operation has sometimes been referred to as a fourth term in the three-term contingency analysis.

reinforcing stimulus (S^R) A stimulus that follows a response and alters the future probability of that response. Reinforcing stimuli increase the probability of response, and punishing stimuli decrease the future probability of response.

three-term contingency A description of the functional relationship between (1) antecedent stimulation, (2) responding, and (3) the consequences produced by that response.

I. DESCRIPTION OF TREATMENT

Functional analysis is not a treatment per se. Rather, it is an analytic strategy that directs intervention. In the most abstract sense, the term functional analysis is borrowed from mathematics and describes some relationship between variables in which changes in one variable alter the value of another variable. In psychology, functional analysis refers to the exploration of how certain stimuli and responses mutually fluctuate. The process includes monitoring a target behavior over time and manipulating antecedents and consequences methodically to determine the features of the environment that predict and influence the behavior of interest. Although functional analysis has historically been most identified with operant conditioning, operant and respondent conditioning processes do not occur in isolation of one another. Rather, these are densely interrelated conditioning processes. Especially in attempting to understand complex clinical phenomena, functional analysis must include an assessment of both respondent and operant contingencies and their interactions.

Functional analysis in psychotherapy is the link between pretreatment assessment data and the design of individualized treatment plans. Elements of the analysis affect decisions about which variables should be targeted in treatment. Such treatment focuses on the variable or variables whose modification is likely to cause the greatest reduction in the problem behavior and/or increases in behaviors that enhance the client's quality of life. Because certain behaviors are reasonably well correlated, research may guide the functional analysis. For example, if someone reported a fear of panic attacks, research suggests a variety of situations that are likely to be avoided (e.g., shopping malls, buses), and those would be assessed directly. However, because functional analysis is linked to a tradition of examining the effects of antecedent and consequent events on the patterns of behavior in individual subjects, the focus has been on individualized assessment of these variables.

Functional analysis used for treatment purposes involves several steps:

- A. Assessment of problem behaviors, including intensity, frequency, duration, and variability
- B. Assessment of relevant antecedents, including establishing operations, discriminative stimuli, and conditioned and unconditioned aversive and appetitive stimuli
- C. Assessment of consequences, including reinforcing and punishing consequences
- D. Treatment by intervening on identified antecedents and/or consequences.

A. Assessment of Problem Behavior

Where direct observation of problem behaviors is possible, it is preferable to indirect assessment. However, in the treatment of adult outpatient cases, such direct observation is often impossible or impractical. In such instances, assessment of the problem behavior is accomplished through questions like, "What is going on in your life that concerns you?" Details about the range of the problem can be obtained through questions about affect, overt behaviors, somatic sensations, and thoughts that are related to the problem. Questions that illuminate duration, intensity, and variability might include: "On a scale of 1 to 10, how depressed did you feel?" "How long did that continue?" or "Can you tell me about the worst your problem has ever been and also times when it seemed to improve?" Terms like anxious and depressed are used very loosely in lay vocabulary. For treatment purposes, we want a more particular description of the

problem behavior. We may obtain this by asking questions such as "When you say you feel depressed, what, in particular, does that mean to you?" Examples may be provided based on research demonstrating the co-occurrence of some behaviors. For example, in an interview with a client complaining of depression, we might ask about sleep, mood, and appetite concerns.

B. Assessment of Antecedents

Questions such as "Has this ever happened at any other time in your life?," "What else is going on when this occurs?," and "Does this same thing happen in different places or at other times?" can be used to assess the antecedents influencing behavior. It may also be useful to ask about situations in which the client's difficulty is least likely to occur, or is least severe. In summary, it is necessary to ask questions that provide the therapist with some sense of the variability in the problem behavior. Identification of most and least problematic contexts can form the basis for hypotheses about relevant discriminative stimuli as well as conditioned appetitive and aversive stimuli.

For example, a client might describe anxiety in social situations that is exacerbated by an evaluative component in the social interaction. In this example, social interaction is the context (S^D) in which escape is reinforced by the termination of the aversive stimulus (e.g., the social interaction, aversive thoughts, emotional, and bodily states associated with such interactions). Adding an evaluative component to such an interaction would constitute an establishing operation (EO), because it would alter the probability of escape and the reinforcing value of that escape.

C. Identification of Consequences

Consequences can sometimes be identified by asking questions such as "What happens after this?" and "How do you feel when this is over?" Sometimes there are social consequences for symptoms. For example, others in the household may pay more attention to the client when the client show signs of depression, or they may temporarily take over household tasks. This sort of consequence can be assessed through questions like "What are the reactions of other people when you get depressed?" Whenever possible behavior, antecedents, and consequences should be assessed using direct observation. When direct observation is not possible, using multiple sources of information, such as family, friends, and co-workers, can be helpful.

D. Treatment Process

An intervention is devised based on the functional analysis. Appropriate interventions could be aimed at a variety of components identified in the analysis. Some interventions aim at altering the presence of the actual antecedent and consequent stimuli that maintain the behavior. For example, a heroin addict might be relocated to a setting that had few or no drug dealers. This would result in the removal of both S^Ds (drug dealers) for drug seeking, and heroin, which is the reinforcer for drug seeking. Other interventions are aimed at altering the psychological functions of the antecedents and consequences, rather than their actual presence. The same addict might be given methadone to eliminate the reinforcing properties of the opiates. Opiate deprivation is an EO for drug seeking, because it makes drug seeking more probable and increases the reinforcing properties of opiates. Because methadone blocks abstinence syndrome, it also alters the motivational (EO) effects of opiate deprivation and therefore alters the probability of drug seeking.

Other means of altering the psychological functions of antecedent stimuli might be to reduce or eliminate the effects of appetitive or aversive conditioning. In the earlier social anxiety example, this might involve systematic exposure to social interactions, which would result in lessened fear and avoidance in the presence of social situations. In the addiction example, we might systematically expose the addict to drug cues, thereby reducing the conditioned appetitive functions.

Finally, the problem behavior can be targeted directly by, for example, increasing the probability of some incompatible behavior. Often, these interventions are combined. Thus, in the social anxiety example, the therapist would likely give considerable social reinforcement to the client as the client approached feared social situations. This intervention might result in both strengthening of the approach operant and extinction of conditioned fear. Having been conceptualized in terms of basic behavioral principles, the treatment is implemented, and an assessment of change is made. If the outcome is acceptable, the process is complete. If the outcome is unacceptable, the next step is to recycle to conceptualization stages. More assessment may be needed, or other controlling variables may be manipulated.

These cases consist of relatively simple examples; however, functional analysis need not be limited to a narrow range of behaviors, antecedents, or consequences. Extraordinarily complex human problems can be examined without violating the fundamental pre-

ises of functional analysis. Some of the process will be illustrated with the following case.

E. Case Example

Mary is a 20-year-old African-American female who was seven months pregnant with her third child at the time of the interview. She was referred for psychological treatment by her gynecologist, who described her as “difficult,” “angry,” and “indifferent.” His immediate concern was her drug use. Excerpts from the initial interview with Mary are used to illustrate assessment components in a functional analysis in an outpatient clinic setting.

Therapist directly assesses problem behavior: Mary, your doctor referred you here, because he was worried about you and your children. It would be good to take a few minutes to talk about this. Help me understand what is going on. First, tell me about the drug use and then we can talk about anything that you think will help me understand what it is like for you. Your doctor tells me that you have been smoking marijuana about once a week, drinking alcohol several times a month; and that you have smoked crack cocaine twice since becoming pregnant.

Client: Yeah, that's about right. So what?

Therapist attempts to get the client to discuss range of the drug problem: So what? You tell me. What does that mean to you?

Client: I don't care.

Therapist continues to assess range: You don't care about your health, or your baby's?

Client: Not really.

Therapist attempting to elicit other problems and prioritize: Wow, that is a pretty powerful statement. Things must be really bad.

Client: Not any different than usual. I have never had a happy day in my whole life. Never. There is nothing for me to live for. I am sad all day.

Therapist attempting to find out about duration and variability: You have never had a happy day, what about a happy moment?

Client: I guess that I have had a few short minutes but I don't really remember them.

Therapist assesses problem severity: Have you ever thought about ending it all, about suicide?

Client: Every day. I think of it every day. I've tried twice by taking a bunch of pills, but it didn't work. My boyfriend killed himself.

Therapist asking about boyfriend's suicide as potentially important antecedent: When did that happen?

Client: Three months ago. His family blames me. We were fighting and talking about breaking up. He told me that he was going to do it. I didn't believe him. I hung up on him, and two hours later I found out he was dead.

Therapist: How did you find out?

Client: His friend walked over to my apartment and told me.

Therapist assesses response to painful antecedent: What did you do?

Client: I took my kids to my mom's and went to get high.

Therapist attempting to clarify response: You got high, how?

Client: I smoked a blunt (marijuana). I drank some beer too, just two. I don't like the taste of alcohol.

Therapist attempting to assess consequences: You don't like the taste but you drink anyway. What does it do for you?

Client: Same thing it does for everybody, helps keep my mind off things.

Therapist assessing consequences: Did it help you keep your mind off your boyfriend's suicide?

Client: For a little while.

Therapist asking about other antecedents: When you are getting high what other things are you trying not to think about?

Client: Men. I hate men.

Therapist clarifying range and context: All men?

Client: All men. My boyfriend was the only halfway decent one that I ever met. They think differently than women. They think backwards. I hate them.

Therapist assessing variability: You say that you hate men; do you feel anything else?

Client: My cousin starting molesting me when I was six. He kept doing it until I moved out. I told my uncle but he did not believe me. I told my stepdad and he didn't believe me. You cannot trust a man. Do we have to talk about them? I wanted a female to talk to so we wouldn't have to talk about them.

Therapist eliciting other problems: I understand that it is very hard to talk about these things. I am only trying to figure out what all of your concerns are. What do you think is the hardest thing for you right now?

Client: Being depressed. I just watch TV all day long. Usually I watch game shows but I am not very good at them.

Therapist asking about context: Is there anytime when you do not feel depressed?

Client: Not really.

Therapist assessing antecedents: Is anyone else around?

Client: My baby. He will be one next week. He is wild sometimes.

Therapist assessing social environment as relevant context: One year olds aren't great to talk to. Do you have any friends?

Client: My mama. That's it. She is the only one who cares about me.

Therapist assessing consequences: Is there anything, besides getting high, that seems to make things better?

Client: Watching television helps a little. Sometimes I clean the house, even if it does not need it. It keeps my mind off stuff.

Therapist asking about context and consequences: What about doing something out of the house, like work or school?

Client: I can't get a job. I can't pay a babysitter. Besides, nobody wants to hire me. I went to college for one semester, after my baby was born. I got mostly A's. I got twelve credits, but I cannot go back because it would be too hard with three babies. People tell me that I can't do it.

Therapist clarifying nature of problem: Do you think that you can't do it? You had good grades before and you already had two kids.

Client: I don't know, someday. I have to get them to school first.

Therapist assessing consequences: Sounds frustrating. It sounds like you want to go to school but feel like you can't. What about a job?

Client: I really don't want that.

Therapist clarifying consequences: So, you get out of having to work because you have kids and are pregnant. Is there anything else that these problems get you?

Client: I don't know, maybe.

Therapist assessing consequences: Like what?

Client: My mom helps me out. I like that. I am still a kid, you know.

Therapist: Is there anything else that you have to say that will help me understand things better?

Client: No.

Therapist reasserts interest in understanding client's problems and the need for more assessment: Ok, see you next week. I will keep asking more of these questions to try and get it. Thanks for talking with me.

In this excerpt from an intake interview several potentially important components of the client's problem and its context were revealed (see Table 1). From them a tentative case conceptualization can be formulated. As identified by the client's physician, drug use during

TABLE 1
Components and Treatment Implications of Functional Analysis of Behavior

<i>Antecedents</i>	<i>Behaviors</i>	<i>Consequences</i>
Social isolation	Drug use during pregnancy	Drugs produce positive intoxicating effects
Low levels of physical activity	Depressed mood	Drug use makes temporary avoidance
Hx of sexual abuse & other negative experiences with men	Hopeless thought patterns	of negative cognition and mood possible
Death of boyfriend	Avoidance of negative mood and cognitions using unproductive activity such as drug use, TV	Drug use reduces social isolation
Social punishment for boyfriend's suicide	Generalized avoidance of men	
<i>Potential intervention on antecedents</i>		<i>Potential intervention of consequences</i>
Increase general and especially social activity		Reinforce any increases in general and especially social activity
Exposure-based treatment to cues related to loss of boyfriend, including both external cues as well as associated cognition, emotion, and bodily states		Reinforce client's willingness to engage in exposure-based treatment efforts
Exposure-based treatment with respect to sexual-abuse cues, including both external and interoceptive cues		Antidipsotropic medications to replace reinforcing effects of alcohol with punishing effects (poor choice given client circumstances and problem severity)
Antidepressant medication to alter negative mood states that precipitate maladaptive avoidance		

pregnancy is this young woman's most pressing behavior problem. Relevant antecedents appear to be depressed mood, guilt, boredom, and perhaps relief from decidedly fatalistic thinking. Given the client's circumstances, these are not unexpected reactions. In behavior analytic terms, drug use is maintained by negative reinforcement. That is, aversive mood and thinking are removed as consequences of drug use. In another part of the interview, the client revealed that the instances of drug use were also some of her only social interactions apart from interactions with her mother and children. This further bolsters the notion that drug use is maintained by negative reinforcement. Drug use not only reduces aversive mood and cognition, it also reduces social isolation and increases a general low level of activity.

Intervention on the consequences of drug use is unlikely to be helpful. The reinforcing effects of alcohol could be eliminated by administering an antidipsotropic drug, like antabuse, that would produce a potent punisher for drinking. Given the pregnancy, however, this would be unacceptable. No such pharmacological interventions are available for marijuana or cocaine. In addition, the client would be left with no good alternative strategies to cope with her rather bleak existence and resulting aversive mood states. Intervention on problematic antecedent mood states might include antidepressant drugs, although this pharmacological intervention might

reduce aversive mood states, it would not address the clients impoverished life circumstances.

A more hopeful intervention could focus on increasing the client's general activity level, with a special emphasis on healthy social interactions. Because this client grew up in a very active religious community, the possibility of becoming engaged in social, worship, and volunteer activities with her church could be explored. Reentry into school could also be examined as a possibility. Initially, any increase in physical and/or appropriate social activity ought to be reinforced. Behavioral activation has several advantages. First, behavioral activation has been repeatedly demonstrated to have a positive impact on negative mood and cognition. Second, these activities would be incompatible with drug use. Third, the young woman would likely broaden her social support system. And finally, the resulting social support system might provide reinforcement that could maintain this ongoing stream of healthy behavior.

This client revealed a variety of other difficulties that may bear further exploration and direct treatment. For example, her history of sexual abuse may have precipitated a host of potential difficulties. She may have difficulties with intimate relations and issues of trust with men. Although not revealed in this interview, possible posttraumatic stress disorder symptoms, like sleep disturbance, flashbacks, and hypervigilance are possible

and ought to be directly assessed. The same functional analytic strategy would be applied to these difficulties.

II. THEORETICAL BASES

Although the concept of functional analysis can be identified with a variety of schools of thought, it is most commonly associated with the behavioral tradition. The core position suggests that if we want to understand behavior, we must understand the context, both historical and current, that produced and maintain the behavior of interest. Advocates of this position have sometimes maintained that environmental events are the real determinants of behavior. A somewhat softer position, called functional contextualism, holds that behavior may be understood in terms of its functional relation to environmental events and that such a method of understanding leads quite naturally to effective interventions, because the analysis points to manipulable aspects of context. Stated in this way, the position does not exclude other methods of understanding behavior, it simply claims this one as an effective strategy for the prediction and influence of behavior.

III. EMPIRICAL STUDIES

As previously stated, functional analysis is not a treatment, instead it is an analytic strategy that provides a basis for treatment. As such, there are not studies of functional analysis per se. However, functional analyses are components of many well-validated treatments. Functional analysis as a component in treatment development is most clearly and explicitly described in journals such as the *Journal of Applied Behavior Analysis* and *Behavior Modification* that tend to have a behavior analytic focus. Within them, one may find hundreds of studies treating a diversity of behavior problems, such as tic disorders, infant feeding problems, trichotillomania, and self-injurious behavior, as well as a wide variety of behavior deficits among populations with both developmental disabilities and normal development such as daily living skills, job skills, communication skills, academic skills, and social skills, among others.

Although less explicit in the published journal articles, functional analysis exists as a key component in a wide variety of empirically supported behavioral and cognitive-behavioral treatments. For example Michael Kozak and Edna Foa's treatment manual for obses-

sive-compulsive disorder, David Barlow and Michelle Craske's anxiety and panic manual, and Stewart Agras and Robin Apple's eating disorders manual all contain careful assessment of antecedents, behaviors, and the outcomes of those behaviors. Although early behavioral treatments were focused on external antecedents and consequences, more recent advances such as Barlow and Craske's panic treatment include a wide variety of interoceptive antecedents that are directly targeted in treatment. In these instances, negative mood, cognition, and bodily states can be thought of as both problematic behavior and as antecedents for other problematic behaviors. Using panic disorder as an example, someone may have a panic attack at a shopping mall and begin avoiding shopping malls. Panic as a response pattern is problematic and can be analyzed in terms of its functional relation to external events, such as the shopping mall. However, individuals with panic also begin to avoid activities that will precipitate early indicants of autonomic arousal, such as avoiding exercise to avoid increased heart rate. Thus, avoiding exercise can be understood distally in terms of the shopping mall, but more proximally in terms of bodily states associated with panic attacks at the mall.

IV. SUMMARY

Functional analysis is a theory-driven approach to understanding behavior in terms of its context. It involves the organization of our understanding of behavior into three primary categories, including (1) antecedents, both remote and proximal, and also including internal and external cues; (2) the behavior of interest; and (3) consequences of that behavior. The analysis proceeds on the assumption that manipulation of antecedents and/or consequences can produce changes in relevant patterns of behavior. Identification of antecedents includes both discriminative stimuli and conditioned aversive and appetitive stimuli. Assessment of the behavior of interest involves examination of frequency, intensity, duration, and variability in the problem behavior. Identification of consequences includes assessment of potentially reinforcing and punishing consequences for the behavior of interest. Having gathered this information, a case formulation is made in terms of the well-established behavioral principles of operant and respondent conditioning and the interaction of these two conditioning processes. A wide variety of interventions have emerged from this functional perspective on behavior, including very

straightforward interventions involving reinforcement of appropriate classroom behaviors to the treatment of complex adult clinical problems like panic disorder with agoraphobia.

See Also the Following Articles

Applied Behavior Analysis ■ Behavioral Assessment ■ Behavioral Case Formulation ■ Configurational Analysis ■ Contingency Management ■ Functional Analytic Psychotherapy ■ Objective Assessment

Further Reading

Cone, J. D. (1997). Issues in functional analysis in behavioral assessment. *Behaviour Research and Therapy*, 35, 259–275.

Hayes, S. C., & Follette, W. C. (1992). Can functional analysis provide a substitute for syndromal classification? *Behavioral Assessment*, 14, 345–365.

Haynes, S. N., & O'Brien, W. H. (1990). Functional analysis in behavior therapy. *Clinical Psychology Review*, 10, 649–668.

Iwata, B. (1994). Functional analysis methodology: Some closing comments. *Journal of Applied Behavior Analysis*, 27, 413–418.

Nelson, R. O. (1988). Relationships between assessment and treatment within a behavioral perspective. *Journal of Psychopathology and Assessment*, 10, 155–170.

Vollmer, T. R., & Smith, R. G. (1996). Some current themes in functional analysis research. *Research in Developmental Disabilities*, 17, 229–249.

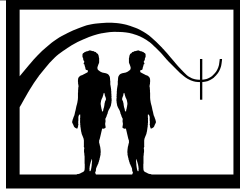

Functional Analytic Psychotherapy

Robert J. Kohlenberg

University of Washington

Mavis Tsai

Seattle, Washington

- I. Description of Treatment
- II. Theoretical Bases
- III. Empirical Studies
- IV. Summary
- Further Reading

perception, language, and even truth and reality vary according to our past.

therapy rationale An explanation given to clients about the causes and cures for their problems. The rationale reflects the theory and types of techniques used during treatment and varies with the type of therapy being done.

GLOSSARY

Beck Depression Inventory A standardized measure of depression that is used to assess a client's progress during treatment.

behavior therapy A type of psychotherapy that is based on learning principles, is usually time limited, and is symptom focused.

cognitive-behavior therapy A variety of behavior therapy aimed at detecting and changing faulty beliefs, attitudes, or thoughts that are hypothesized to be responsible for the symptoms.

internal validity Refers to whether an outcome of a therapy treatment can be confidently attributed to the treatment itself and not some extraneous factor.

major depressive disorder A mood disorder characterized by sadness, despair, loss of energy, sleep and appetite disturbance.

radical behaviorism The psychology of B. F. Skinner that accounts for our external actions, private feelings, and beliefs in terms of the types of past experiences that shape us. The most fundamental type of past experience involves the contingencies of reinforcement (nontechnically referred to as rewards and punishments) that we experienced throughout our life span. This historical account of behavior leads to a contextual approach in which meaning,

Functional analytic psychotherapy (FAP) is a form of behavior therapy that emphasizes use of the therapist–client relationship for providing powerful *in vivo* learning opportunities. Based on the radical behaviorism of B. F. Skinner, FAP produces change through the natural and curative contingencies of reinforcement that occur within a close, emotional, and involving therapist–client relationship.

I. DESCRIPTION OF TREATMENT

Psychologists Robert J. Kohlenberg and Mavis Tsai noticed that some of their clients treated with conventional cognitive-behavior therapy techniques showed dramatic and pervasive improvements that far exceeded treatment goals. In their search for an explanation as to why this happened with some clients, they noticed that the dramatic improvements occurred in those clients with whom they had particularly intense and involved therapist–client relationships. These intense relationships were not created purposely as part

of the therapy but seemed to emerge spontaneously from time to time. As a result of these observations, Kohlenberg and Tsai used behavioral concepts (a) to theoretically account for the hypothesized connection between dramatic improvement and an intense therapist–client relationship, and (b) to delineate the steps therapists can take to facilitate intense and curative relationships. The result was FAP, a new type of behavioral therapy in which the therapist–client relationship is at the core of the change process. In particular, the FAP therapist focuses on the special opportunities for therapeutic change that occur when the client's daily life problems are manifested within the therapeutic relationship.

In 1994, Kohlenberg and Tsai detailed how FAP, a powerful treatment by itself, is also an integrative approach that can be combined with almost any other type of therapy to improve outcome. It should also be pointed out that FAP emphasis on the therapist–client relationship, based on behavioral theory, has some unexpected similarities to the Freudian concept of transference.

A. *In Vivo* Learning Opportunities

Functional analytic psychotherapy underscores the importance of *in vivo* learning opportunities—the actual occurrences of the client's daily life problems in interactions with the therapist. The well-accepted notion that learning is accelerated when done *in vivo* can be illustrated by the accelerated learning that occurs when learning to drive a car while actually driving with an instructor, as opposed to classroom instruction.

In vivo occurrences of the client's problems are “real” and are distinguished from the “role playing” or “behavioral rehearsal” that are sometimes used in behavior therapy. Examples include: (a) A woman, depressed mainly because she has no friends, avoids eye contact during the therapy session, answers questions by talking at length in an unfocused and tangential manner, has one “crisis” after another, and gets angry at the therapist for not having all the answers; (b) An unhappy man whose main problem is that he avoids getting into love relationships, always decides ahead of time what he is going to talk about during the therapy hour, watches the clock during the session so he can end precisely on time, states that he only can come to therapy every other week because of tight finances (he makes a relatively large income), and cancels the next session after making an important self-disclosure.

In these examples, the client is seeking treatment for certain daily life problems and then acts in the same

problematic way within the therapist–client relationship. In FAP, these *in vivo* occurrences of the client's problems are referred to as clinically relevant behaviors, type 1 (CRB1s). On the other hand, clinically relevant behaviors, type 2 (CRB2s) are actual improvements that occur in-session. For example, if the woman in the earlier example subsequently increases her eye contact with the therapist and is more accepting of the therapist's limitations, these are CRB2s. In order to do FAP, it is crucial that the therapist has an understanding of CRBs, be able to recognize them when they occur, and know how to nurture the development of CRB2s.

B. Doing FAP

Functional analytic psychotherapy employs several therapeutic strategies. The three primary ones are: (a) watch for CRBs, (b) evoke CRBs, and (c) reinforce CRB2s.

Strategy 1: *Watch for CRBs*. This strategy is the most important one because it alone will lead to more intense and effective treatment. A therapist who is skilled at observing instances of clinically relevant behavior also is more likely to naturally encourage clients to give up self-defeating patterns in the here and now, and foster more productive approaches to life.

Strategy 2: *Evoke CRBs*. Because the occurrence of CRBs are required to do FAP, how can this be facilitated by a therapist? Client problems reenacted during role playing, as pointed out earlier, are not the same as naturally occurring CRBs. Further, feigning evocative situations, such as coming late to a session or getting angry at the client, are not recommended. Such disingenuous behaviors are incongruent with the close and honest relationship called for in FAP.

As it turns out, the structure of most therapy sessions naturally evokes CRB. For example, all therapists set appointments and require fees for treatment. These procedures can evoke CRBs relating to the client making and keeping commitments, being punctual or being too compulsive, feeling like they are so worthless that they need to pay someone to listen to them, and so on. Similarly, the universal therapist request to the client to be open and to express both positive and negative feelings could evoke the client's problems in forming close relationships. CRBs are ubiquitous in all therapies but frequently are overlooked by therapists who are not trained to see them.

Strategy 3: *Reinforce CRB2s*. Reinforcement is the technical term that means the therapist should nurture and strengthen in-session improvements. It is best to rely on the therapist's natural reactions for this process rather

then to gratuitously use phrases such as “that’s terrific” or “great,” which may be viewed by the client as insincere. Therapists who are skilled in FAP are aware of CRB2s as they occur and are genuinely and spontaneously reinforcing. One way that therapists can become more naturally reinforcing of improvements in their clients is by doing good deeds for others in their own personal lives.

On the other hand, therapists who are not aware of CRBs may inadvertently punish CRB2s (improvements). For example, consider a case in which a woman was seeking help for depression that was related to her lack of assertiveness with her husband. The therapist attempted to teach her to be assertive by using role playing, a common behavior therapy procedure. The client expressed discomfort with role playing and asked if there were another way to approach the problem. The therapist then suggested to the client that by resisting the role playing she was being avoidant, and he pressured her to do the role playing anyway. The FAP analysis of this incident is that the client’s expression of her reluctance to do the role play was a CRB2 because she was being assertive with the therapist—the very real-life skill that the therapist was attempting to teach. The therapist, on the other hand, did not nurture and strengthen this assertiveness and may even have unintentionally punished it by accusing her of being avoidant and insisting that she do the role play. If the therapist had been aware that a CRB2 were occurring (as called for in Strategy 1), he would have recognized the *in vivo* therapeutic opportunity and nurtured the assertiveness by pointing out to the client how useful it is for her to express her feelings, and to find other ways to approach the problem besides role playing.

C. Using FAP to Improve Cognitive Therapy for Depression

Cognitive-behavior therapy (CBT) for depression, developed in 1979 by Dr. Aaron Beck and his colleagues, has been shown to be an effective treatment for major depression. As with any treatment for depression, however, there is room for improvement. In particular, some clients are resistant to the methods and rationale of cognitive therapy, and outcome is endangered by what is known as a rationale–client mismatch. Examples of mismatches include clients who experience that their feelings rule no matter what thoughts they have, who are looking for a more intense and interpersonal therapy, and those that want to understand how their problems are related to their family histories. In an attempt to more effectively address the diverse

needs of clients, reduce mismatches, and yet retain the value that cognitive therapy has for many clients, a combined FAP and cognitive therapy (CT) treatment was developed. The new treatment is referred to as FAP enhanced cognitive therapy (FECT).

FECT contains two enhancements to standard CBT. The first is an expanded rationale for the causes and treatment of depression. The expanded rationale includes several possible causes for depression in addition to the cognitive therapy hypothesis that depression results from dysfunctional thoughts and beliefs. For example, clients are told that depression can be related to losses that need to be grieved, to family of origin or historical issues, to a dearth of experiences that bring a sense of mastery and pleasure, to anger turned inward, to not having intimacy skills. This expanded rationale allows for better treatment–client matching.

The second enhancement is using the therapy–client relationship as an *in vivo* opportunity to learn new patterns in thinking and to create better relationships. Clients are told that.

It will be helpful for us to focus on our interaction if you have issues or difficulties that come up with me which also come up with other people in your life (such as co-workers, acquaintances, supervisors, friends, spouses). When one expresses one’s thoughts, feelings, and desires in an authentic, caring and assertive way, one is less likely to be depressed.

II. THEORETICAL BASES

FAP stems from the psychology known as radical behaviorism proposed by Psychologist B. F. Skinner. Many readers may erroneously associate Skinner with a narrow theory used for explaining lever pressing by rats in experimental chambers. In fact, Skinner attempted to show how contingencies of reinforcement enter into the understanding of fundamental human processes such as perception, sense of self, identity, beliefs, language, poetry, happiness, personality, love, and creativity.

As a means of illustrating how radical behaviorism works, consider how it views thoughts, beliefs, or cognition. Cognitive theory (often considered the nemesis of radical behaviorism) posits that a person’s thoughts, beliefs, or attitudes determine how they react to events in the world. Known as the A->B->C paradigm, it is shown in Figure 1 (a). The radical behavioral position, in contrast, posits that one’s thoughts in some cases may determine a person’s subsequent reactions as shown in

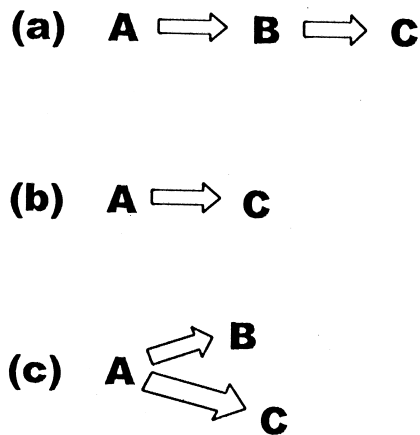

FIGURE 1 Some cognition-behavior relationships according to the FECT expanded rationale. A = Antecedent Event; B = Belief/Cognition; C = Consequence (emotional reaction). Figure (a) represents the standard cognitive model; (b) represents a situation in which there is no cognition; (c) represents a situation in which cognition precedes but is not causally related to the reaction.

Figure 1 (a), but in other cases thoughts may occur that have no influence on reactions (Figure 1 [c]). In fact, one may even have reactions without any preceding thoughts (Figure 1 [b]). The radical behavioral position is that different paradigms apply depending on our history of reinforcement. Using an example from our daily lives, we all have had thoughts in the form of a self-promise, such as “I will not eat that fattening cream pie” when offered a piece. At times we will confirm paradigm 1 (a), the cognitive hypothesis, by not eating the pie. At other times, however, we will have the thought but eat the pie anyways (paradigm 1 (c)), thus disconfirming cognitive theory. Then, of course, at times we will have the experience of just eating the pie without any preceding thoughts (Figure 1 [b]) which is also inconsistent with cognitive theory. An advantage to the radical behavioral view is that it accommodates all these possibilities. Because the radical behavioral view accommodates a wider range of how people experience the relationship between their thoughts and subsequent actions, it was used as part of the expanded rationale to enhance cognitive therapy.

Another implication of radical behaviorism as applied to therapy is that people act the way they do because of the contingencies of reinforcement they have experienced in past relationships, and more broadly, in our culture. Based on this theory, it follows that clinical improvements or psychotherapeutic change also involve contingencies of reinforcement that occur in

the relationship between client and therapist. A well-known aspect of reinforcement is that the closer in time and place the behavior is to its consequences, the greater the effect of those consequences. Treatment effects will be stronger, therefore, if clients’ problem behaviors and improvements occur during the session, where they are closest in time and place to the available reinforcement. In other words, FAP places great emphasis on the therapist being aware of the therapist–client interaction and on client CRBs because the most significant therapeutic change results from contingencies that occur during the session within the therapist–client relationship.

Functional analytic psychotherapy theory does not say that other types of interventions (e.g., giving advice, using homework, cognitive therapy, social skills training) are not effective. Rather, the FAP position is simply that *in vivo* interventions are more powerful and increase the likelihood of positive therapy outcome.

III. EMPIRICAL STUDIES

Kohlenberg and Tsai present a number of case studies in their 1991 book, *Functional Analytic Psychotherapy*, that supports their hypothesis that an *in vivo* focus during therapy leads to significant clinical improvement. In 1994, they published a case study of a 35-year-old depressed man who started a course of standard cognitive therapy. Although he showed an initial improvement as measured by the Beck Depression Inventory, he failed to make further progress until the therapist began using FAP Enhanced Cognitive Therapy (FECT) in Session 7 of the 13-week treatment. The patient also reported that his interpersonal relationships improved as a result of FECT. In another case study published in 1999, R. H. Paul and associates reported benefits of using FAP as an addition to other treatment for a pedophile. In a group therapy for depressed adolescents, Scott Lawrence and Scott Gaynor at the University of South Carolina, Greensboro, reported at the annual meeting of the Association for Behavior Analysis in 2000 that FAP improved treatment outcome.

Also in 2000, Robert Kohlenberg, Mavis Tsai, Chauncey Parker, Jonathan Kanter, and Madelon Bolling completed a National Institute of Mental Health treatment development study using FECT for clients with major depression. The study demonstrated that experienced cognitive therapists could learn how to competently do FECT. The results also showed that FECT improved treatment outcomes and interpersonal

relationships. Other studies using FAP are currently underway—at the University of Nevada-Reno, William Follette is studying patients who are dependent on tranquilizers, and Steve Hayes, Elizabeth Gifford, and Barbara Kohlenberg are studying the treatment of nicotine dependence.

Although the empirical findings are favorable, FAP is a new treatment, and the types of empirical studies conducted thus far reflect its early stage in the treatment development process. Threats to internal validity have not been dealt with unequivocally. To advance to the next stage of empirical support, Robert Kohlenberg and colleagues are conducting a randomized clinical trial in which patients are randomly assigned to receive either CT or FECT for major depression. The outcome of this study will add important evidence that will be useful in assessing the utility of FAP.

IV. SUMMARY

Functional analytic psychotherapy posits that the therapist–client relationship is a social environment with the potential to evoke and change actual instances of the client's problematic behavior. FAP underscores the importance of *in vivo* learning opportunities, the actual occurrences of the client's daily life problems in therapist–client interactions. Change is produced through the natural and curative contingencies of rein-

forcement that occur within a close, intense, and emotional therapeutic relationship.

See Also the Following Articles

Behavior Therapy: Historical Perspective and Overview ■
 Behavior Therapy: Theoretical Bases ■ Cognitive Behavior Therapy ■ Exposure *in Vivo* Therapy ■ Functional Analysis of Behavior ■ Functional Communication Training ■ Working Alliance

Further Reading

- Follette, W. C., Naugle, A. E., & Callaghan, G. M. (1996). A radical behavioral understanding of the therapeutic relationship in effecting change. *Behavior Therapy, 27*, 623–641.
- Kohlenberg, R. J., Kanter, J., Bolling, M., Parker, C., & Tsai, M. (in press). Enhancing cognitive therapy for depression with functional analytic psychotherapy: Treatment guidelines and empirical findings. *Cognitive and Behavioral Practice*.
- Kohlenberg, R. J., & Tsai, M. (1991). *Functional analytic psychotherapy: A guide for creating intense and curative therapeutic relationships*. New York: Plenum.
- Kohlenberg, R. J., & Tsai, M. (1994). Functional analytic psychotherapy: A behavioral approach to treatment and integration. *Journal of Psychotherapy Integration, 4*, 175–201.
- Kohlenberg, R. J., & Tsai, M. (1994). Improving cognitive therapy for depression with functional analytic psychotherapy: Theory and case study. *The Behavior Analyst, 17*, 305–320.
- Skinner, B. F. (1974). *About behaviorism*. New York: Knopf.

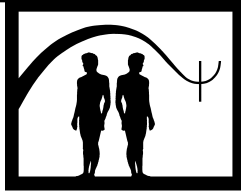

Functional Communication Training

Cynthia R. Johnson

University of Pittsburgh School of Medicine

- I. Description of Treatment
 - II. Theoretical Bases
 - III. Empirical Studies
 - IV. Summary
- Further Reading

GLOSSARY

antecedent The preceding factor or stimulus that may cue the occurrence of the observable behaviors (an antecedent for tantrums in young children is being told “no”).

applied behavior analysis Field of inquiry that studies variables influencing observable behaviors by use of a systematic experimental design. This term is oftentimes used interchangeably with behavior therapy and behavior modification.

augmentative communication system An alternative communication designed for those impaired in verbal communication. Systems may vary from simple photographs, to picture symbols, to computerized devices programmed specifically for an individual.

consequence The event or stimulus, occurring after a behavior, that influences the future likelihood of the behavior. A consequence may be a reinforcer (thus increase the likelihood of the behavior to occur) or a punisher (decrease the likelihood of the behavior).

extinction Commonly called systematic ignoring; a behavior procedure by which reinforcement of an earlier reinforced behavior is withheld with the goal of reducing the behavior.

punisher A consequence presented contingent on a particular behavior that results in the decrease of the behavior.

reinforcement A process in which the consequence of a behavior results in an increased frequency of the behavior.

reinforcers A contingent consequence of a behavior that results in an increased frequency and long-term maintenance of that behavior.

self-injurious behaviors Behaviors self-inflicted by an individual that have the potential to be harmful (hand biting, head banging, face slapping).

single-subject design A research design often utilized in behavior treatment whereby measurements of a behavior are repeated under same and different conditions to determine the effects. Studies using this research design may have one to a handful of subjects.

stereotypical behaviors Repetitive, seemingly nonpurposeful movements, also often referred to as self-stimulatory behavior (hand flapping, body rocking, finger posturing).

Functional communication training (FCT) is a treatment approach often implemented to attenuate challenging behaviors, most often in individuals with developmental and communication disabilities. The specific FCT procedures for an individual are determined by the findings of a functional assessment and analysis of the challenging behaviors to be treated. FCT is typically one component of a multicomponent treatment package. This article provides a description of this treatment approach, the theoretical underpinning, and a summary of empirical findings to date.

I. DESCRIPTION OF TREATMENT

The premise for the treatments that fall under this domain is that challenging, problematic behaviors may act as an unconventional but effective form of communication. Hence, the goal of FCT is to teach an alternative, more adaptive behavior that will serve the same function or purpose for the individual with the assumption this will in turn attenuate the occurrence of the challenging behavior. This treatment is a popular approach as one component to addressing the often-occurring challenging behaviors in individuals with developmental disabilities, communication delays, and other groups whose ability to communicate effectively is thwarted (hearing impaired, traumatic brain injury). FCT has been successfully implemented in treatment of such behaviors such as aggression, self-injurious behaviors, disruption, severe tantrums, and stereotypical behaviors. Common communicative functions these challenging behaviors have typically found to serve are (a) to escape or avoid a situation, (b) to gain attention or comfort, (c) to obtain access to a preferred tangible item or reinforcer, (d) and to gain sensory reinforcement. There are likely many more communicative purposes behaviors serve, but

these are the ones most researched. Determining first what communicative functions challenging behaviors serve is critical to the implementation of FCT. Hence, a specific type of assessment precedes successful FCT. A functional assessment and analysis is conducted during which the function or purpose of the behavior is hypothesized. Subsequent to the functional assessment, the type of communicative behavior to be taught may be chosen (to end an activity, to obtain assistance, to request a preferred activity, to gain sensory input). Based on developmental and communication levels of the individual, the communicative behavior may be verbal, a manual sign, use of pictures, or other augmentative communication systems (electronic devices). To be effective, the alternative behavior response to replace the challenging behavior needs to be less effortful, more efficient, and consistent in obtaining the same end or the same need met for the individual. Steps in using treatments based on this paradigm are outlined below

1. Following a functional assessment and a determination of the function of the problem behavior, a replacement behavior is chosen. Table 1 provides examples of responses that might be taught based on

TABLE 1
Examples of Responses That Might Be Taught

<i>Challenging behavior maintained by</i>	<i>Teach</i>	<i>Examples</i>
Escape—to get out of or avoid a situation	Appropriate escape responses	<ol style="list-style-type: none"> 1. Verbalize “I need a break.” 2. Manual sign “Finish.” 3. Push some items away
Attention—to gain someone’s attention	Appropriate attention gaining response	<ol style="list-style-type: none"> 1. Raise hand 2. Ring a bell 3. Press communication device programmed to say “Hey look at me.” 4. Shake a rattle
Tangibles	Appropriate request for tangibles	<ol style="list-style-type: none"> 1. Verbalization of “I want...” 2. Use of picture communication symbols to show an adult what is wanted 3. To lead an adult to what is wanted. 4. To manually sign “toy” if that is what is wanted.
Sensory feedback	Appropriate requests for sensory activities	<ol style="list-style-type: none"> 1. Teach child to point to a bin of tactile, sensory items.

the hypothesized purpose or function of the challenging behavior.

2. The training of these replacement behaviors may initially take place out of the setting where the challenging behavior is likely to occur.

3. Once the individual has the chosen behavior in his repertoire, he is prompted to use that communication while often ignoring or interrupting the challenging behavior. For example, if an individual hits himself when given a difficult task, he may be prompted to request a break.

4. When individuals are consistently using the communication, replacement behavior in lieu of the challenging behavior, the addition of requests (in the case of escape situation) or increasing the delay for a response (in the case of receiving assistance) are typically systematically added. Differential reinforcement is often part of this step whereby the individual receives additional reinforcement for complying with requests and for the absences of the challenging behavior.

The replacement communication behavior chosen is dependent on findings from the functional assessment conducted prior to treatment planning. If it is determined the individual is attempting to escape or avoid a situation, then a likely communication to be taught would involve an indication of wanting a break, asking to leave, or of simply disliking an aspect of the situation. The communication behavior chosen to be taught depends on a number of variables. First, the skills of the individual obviously have to be determined. For individuals with no verbal skills, a non-verbal mode of communication will need to be chosen. Again, based on the developmental level of the individuals, the communication behavior could range from a sign, to pointing to a picture, or to using some other augmentative communication device. Augmentative communication devices now available include an array of sophisticated electronic devices that are individually programmed to support an individual in his or her communication needs. For example, the device may be programmed to “verbalize” the individual’s favorite cereal when the key with a picture of that cereal box is pressed. Although the goal may be for the individual to use verbal communication, for purposes of FCT in decreasing a challenging behavior, a lower-level communication behavior is typically chosen. To illustrate this point, a child may have recently begun using phrases and short, simple sentences to make requests. This child however, when upset, uses no words. Hence, a possible replacement

communication behavior may be a single word such as “help” to signal the child needs assistance from an adult in the setting.

A major advantage of this treatment is that a new, appropriate behavior is being taught versus the simple suppression of the challenging behavior. It may also be considered a more proactive approach instead of simply reacting when a challenging behavior is observed. Further, for individuals with limited skills to be independent and exert control and make choices, this approach builds more independence and choice making. Also of great importance is the increased likelihood of the effects of this treatment to maintain over time and to generalize to new situations. That is, the treatment will be effective over time and in new settings where not initially trained. For example, the individual will communicate the need to get out of a situation or to gain attention in a new classroom.

II. THEORETICAL BASES

Functional communication training is a set of treatment procedures borne out of the applied behavior analysis tradition. Numerous treatments for behavior and emotional problems have emerged from this field. Functional communication training as well as functional assessment and functional analysis share the basic principles of operant learning theory. The shared tenets based on this theory include the “ABC” model that assumes overt, observable behavior (the B) depends on the antecedents (the A) and the consequences (the C) of the behavior. Behaviors such as aggression, self-injury, tantrums, and disruptions are certainly challenging; however, for the individual engaging in them, they may not be maladaptive at all. The consequences for these behaviors may be positive reinforcement or negative reinforcement. In the case of positive reinforcement, the individual is given a reinforcer contingent on the behaviors. For example, a child may be given a preferred toy or adult attention. An example of the challenging behavior being negatively reinforced is the behavior results in the individual being allowed to get out of doing something (i.e., escaping, avoiding, or delaying a situation or task that is aversive). In other words, problematic behaviors may result in the individual obtaining attention or comfort from another, being allowed out of a situation they find uncomfortable or stressful, or acquiring a favorite item. Hence, on the contrary, these behaviors labeled as problematic or challenging may be quite

adaptive for individuals, effectively providing them control over their environment and access to desired reinforcers or outcomes. FCT is based on what has been described as the “communication hypothesis” of challenging behaviors. Carr and Durand in a 1985 seminal article first hypothesized that behaviors serve to communicate for an individual that may have limited effective means to communicate his or her needs or preferences. The individual may in fact have language, but for many possible reasons, the challenging behaviors may have been reinforced more often than language or communication efforts. For example, in young children, a child biting certainly will gain more immediate attention than a soft, poorly articulated request. Hence, the essence of this treatment approach is to teach or strengthen alternative communication skills to serve as a replacement for the challenging behavior.

A. Functional Assessment and Functional Analysis

Essential to the FCT approach is the first conducting a functional assessment and functional analysis. It is universally accepted in the field of applied behavior analysis that a functional assessment is quintessential to appropriately design behavior treatments. In a 1999 edited book, by Alan Repp and Robert Horner, the importance of effectively conducting a functional analysis to then develop effective behavior treatments of all types is stressed. In the case of FCT, the comprehensive assessment informs the choice of specific FCT procedures for a particular individual. As with FCT, functional assessment practices have been the focus of tremendous investigative efforts in the past two decades. Functional assessments are intended to identify the relative “functions” of the identified challenging behavior for a particular individual. Since Brian Iwata and his colleagues published their 1982 article on the functional analysis of self-injury, the importance of conducting functional assessments and analyses to appropriately design functionally derived interventions is widely acknowledged.

Functional assessments may include a range of indirect and direct assessment practices. Indirect assessments may include structured interviews with individuals knowledgeable about the identified client and a behavior motivation checklist developed to ascertain the possible function or purpose of a target behavior for a specific individual. Direct assessment may

include naturalistic observations or analogue observations. With naturalistic observations, the individual is observed in a typical setting (school, home, and other community setting) with the intent of observing the challenging behavior, and thus infer the function for that individual given the consequences the behavior rendered. As illustrative, did the child gain the teacher’s attention by hitting a classmate? Alternatively, was the child allowed to “escape” the situation for the same behavior by being sent out of the room (and away from the stack of worksheets)? The term functional analysis is typically reserved to describe specific analogue observations, which are often employed as part of a functional assessment. Analogue, meaning analogous to a situation, observations are intended to simulate likely real-life scenarios in which the challenging behaviors likely occur. Hence the goal of a functional analysis is to identify environmental variables that may be maintaining or controlling certain challenging behaviors. In the functional analysis observations, the systematic manipulation of variables in an analogue setting allow for data-based development of hypotheses regarding the function of a particular observed behavior.

To get an idea of what a functional analysis entails, commonly used functional analysis conditions and procedures first published by Brian Iwata are briefly described.

B. Social Attention

This condition is designed to approximate a common type of reinforcement contingency that may maintain a challenging behavior. In the natural environment, many challenging behaviors may in turn result in attention from caregivers, teachers, and peers. Verbal attention, nurturance, and comfort may be the consequence of an individual engaging in a challenging behavior, thus inadvertently maintaining the behavior as a form of positive reinforcement. In this analogue observation, attention is delivered contingent on the challenging behavior.

C. Demand

This session is designed to assess whether a challenging behavior is maintained by negative reinforcement as a result of being allowed to escape or avoid demanding or stressful situations. In this condition, demands or requests are issued, and the individual is

allowed to escape contingent on the challenging behavior under assessment.

D. Preferred Tangible Removal

This session serves to determine if the challenging behavior is a means to gain access to preferred activities or items. In this condition, preferred items may be removed and then returned contingent on the identified challenging behavior.

E. Alone

This analogue condition assesses whether a behavior is maintained by sensory reinforcement. The individual is observed without stimulation/activities and receives no attention.

These types of observations usually are conducted after other earlier described assessment procedures have been completed. The functional analysis observations are the most controlled observations and may be thought of as “testing out” the hypothesized purpose of challenging behaviors for an individual. The approach may not always be feasible in all settings. Nonetheless, gathering as much precise data about the function of a problematic behavior is of great importance. Accurate hypotheses about the purpose or function of a particular challenging behavior are essential in the design of effect in FCT procedures.

III. EMPIRICAL STUDIES

Since the first FCT studies were published in the mid-1980s, there has been much enthusiasm surrounding this promising approach. This enthusiasm was generated for several reasons. The treatment approach moved away from the reliance of consequence and earlier punishment procedures that had evoked controversy in the field. The treatment also resulted in often dramatic decreases in challenging behaviors and had more inherent likelihood of being maintained over time. Edward Carr and V. Mark Durand first reported in 1985 on four individuals with developmental disabilities. Aggression, self-injurious behavior, and tantrums were successfully treated with FCT. Subsequent to this first report, a plethora of investigations emerged very quickly in the behavior treatment literature. Most commonly, functional communication training has been implemented to decrease excessive

behaviors. In the research literature, behaviors studied have included most commonly aggression, self-injurious behaviors, tantrums, and disruptive behaviors such as throwing. The studies have been almost entirely single-subject design, hence each study includes only a small number of subjects. Thus, the generalization of the application of specific FCT procedures to populations different than the specific characteristics of the subject studies is yet to be understood.

In recent years, there has been considerable FCT research designed to examine the underlying behavioral mechanisms to explain the powerful effects of the treatment. It appears that FCT is only useful in combination with components. That is, FCT is only effective when the problematic behavior is simultaneously placed on extinction or even perhaps punished. FCT is also more likely to be effective if there are more opportunities for the new replacement behavior to be evoked and then reinforced.

IV. SUMMARY

The past 15 years have seen a truly remarkable impact of the functional communication or functional equivalence training approach to the amelioration of challenging, interfering behaviors. This approach has been primarily applied to individuals with developmental disorders and those with noted limitations in communication skills (young children). Since the introduction of this treatment approach, a plethora of empirical reports in the literature have supported the efficacy of this approach as one component in a multi-component treatment package. This approach is not only widely accepted in intensive treatment settings but has been instituted as an intervention in children's behavior support plan as part of their individual education plan in the special education system.

See Also the Following Articles

Behavioral Assessment ■ Communication Skills Training ■ Extinction ■ Functional Analysis of Behavior ■ Neuropsychological Assessment

Further Reading

Carr, E. G., & Durand, V. M. (1985). Reducing behavior problems through functional communication training. *Journal of Applied Behavior Analysis, 18*, 111–126.

- Carr, E. G., Levin, L., McConnachie, G., Carlson, J., Kemp, D., & Smith, C. (1994). *Communication-based intervention for problem behavior: A user's guide for producing positive change*. Baltimore: Paul H. Brookes.
- Durand, V. M. (1990). *Severe behavior problems: A functional communication training approach*. New York: Guilford Press.
- Dyer, K., & Larsson, E. V. (1997). Developing functional communication skills: Alternatives to severe behavior. In N. Singh et al. (eds.), *Prevention and treatment of severe behavior problems I: Models and methods in developmental disabilities* (pp. 121–148). Pacific Grove, CA: Brookes/Cole.
- Iwata, B. A., Dorsey, M. F., Slifer, K. J., Bauman, K. E., & Richman, G. S. (1982). Toward a functional analysis of self-injury. *Analysis and Intervention in Developmental Disabilities*, 2, 3–20.
- Koegel, L. K., Koegel, R. L., & Dunlap, G. (1996). *Positive behavior support: Including people with difficult behavior in the community*. Baltimore: Paul H. Brookes.
- Reiche, J., & Wacker, D. (1993). *Communicative alternatives to challenging behaviors: Integrating functional assessment and intervention strategies*. Baltimore: Paul H. Brookes.
- Repp, A. C., & Horner, R. H. (1999). *Functional analysis of problem behaviors*. Belmont, CA: Wadsworth.



Gambling: Behavior and Cognitive Approaches

Robert Ladouceur, Claude Boutin, Caroline Sylvain, and Stella Lachance

Université Laval

- I. Description of Treatment
 - II. Theoretical Basis
 - III. Empirical Studies
 - IV. Summary
- Further Reading

GLOSSARY

core cognitive error Relates to gamblers' erroneous cognitions related to randomness and predictability.

pathological gambling Individuals gamble because they maintain the unrealistic hope that they will recover their losses if they continue to gamble.

randomness No event can influence another, thus resulting in the unpredictability of events.

I. DESCRIPTION OF TREATMENT

The legalization of new forms of gambling is increasing in most Western countries. This trend has created a situation in which more and more people will develop serious gambling problems, for which they will need to seek professional help. Pathological gambling was officially recognized in 1980 with the publication of the *DSM-III*. It is now acknowledged that the prevalence of pathological gambling is related to the availability of gambling opportunities, legal or illegal. Current prevalence rates of this disorder

vary from 1 to 2% in the United States and Canada.

The cognitive approach to the treatment of pathological gambling is based on experimental work demonstrating a wide range of cognitive errors made by gamblers in relation to gambling. The core cognitive error lies in the gamblers' notions concerning randomness and predictability. Essentially, gamblers fail to recognize the random nature of games of chance and believe that they can predict the outcome of the game and win through the use of skills or strategies. This misconception of randomness leads gamblers to develop what has been referred to as the "illusion of control," and false beliefs in their ability to predict the outcome of a game. The basic assumption of cognitive theories is that gamblers will dramatically decrease their gambling activity if their erroneous perceptions about randomness can be corrected.

Our treatment program focuses on erroneous perceptions about randomness and makes it the most important target for change. Two components are crucial in this treatment: the cognitive correction of erroneous perceptions and relapse prevention. Because cognitive therapy usually integrates behavioral as well as cognitive strategies for change, specific behavioral interventions are included in the treatment package. This specific treatment is administered on an individual basis, over an average of 12 weekly sessions lasting 60 min each.

A. Evaluation of Pathological Gamblers

A thorough evaluation of each individual's gambling problem must be conducted to determine how best to implement the therapeutic intervention. Before treatment begins, therefore, the nature and severity of the gambling problems must be evaluated. Although the South Oaks Gambling Screen (SOGS) is not made for diagnosis, this brief questionnaire developed by Henry Lesieur and Sheila Blume is a pertinent, easy to use, and widely recognized evaluative instrument. This instrument is frequently administered over the phone, before the first treatment session takes place. To date, the *DSM-IV* criteria for pathological gambling remain the most accepted instrument for the diagnosis of pathological gambling. Thus, to achieve a complete and comprehensive evaluation, our group developed a semistructured interview that includes the *DSM-IV* criteria and obtains additional information about historical gambling habits, social functioning, suicidal thoughts, concomitant excessive behaviors, and so on.

Ambivalence toward abstinence or controlled gambling is the gambler's worst enemy and must be addressed during the first stage of evaluation. The motivational level of individuals with a gambling problem should therefore be assessed before they undertake any treatment. Our team of therapists have made use of a motivational scale allowing them to decide which treatment target should be prioritized. A high level of motivation, such as 7 out of 10, could indicate a lower level of denial from the client, and a better likelihood of treatment adherence. In contrast, a low score on the motivational scale indicates that treatment adherence may be a problem and should be addressed first. Ambivalence about conquering the desire to gamble must necessarily be dealt with if the treatment is to succeed. Thus, addressing motivational issues is the very first step, before even considering targeting erroneous perceptions about gambling.

To further test the gambler's motivation to cease gambling, the therapist and client also engage in discussion about the positive and negative aspects of gambling during this evaluation phase. A better consciousness of the positive and negative aspects of ceasing gambling is also an issue. During this discussion, the therapist obtains information about the client's gambling behavior and identifies the client's goals regarding treatment.

To keep track of their gambling activities, clients are asked to complete a daily monitoring sheet. With the help of this monitoring sheet, the therapist can start

every clinical session with a discussion about the client's progress or relapse throughout the course of the therapy.

The next treatment target involves the correction of the client's erroneous perceptions about the role of randomness in games of chance. Most gamblers are either not aware that their perception of these games is inaccurate, or they simply deny that they believe these games can be predicted, controlled, and won. Increasing awareness of their gambling activities and the erroneous perceptions associated with them is an essential first step if gamblers are to overcome their urge to gamble and work their way toward abstinence. Given that relapse rates among gamblers are high, and that gamblers tend to be ambivalent about conquering their habit, or deny that they even have a problem, abstinence is the ultimate goal in therapy. A study currently underway at Laval University is evaluating the efficacy of controlled gambling versus abstinence, with the gambler's characteristics as predictors of success for either goal; until these results are known, however, abstinence should remain the main goal of therapy.

Cognitive treatment for pathological gambling is not based on simply providing information concerning actual probabilities and the true random nature of games of chance. Rather, the main goal of this treatment is to enable gamblers to become aware of their own misconceptions about gambling and challenge their unrealistic beliefs about the predictability of games of chance. Thus, an evaluation of the gambler's misconceptions is a crucial step that must be taken before therapy can be initiated. To do this, clients are invited to describe the evolution of their gambling habits. As mentioned previously, the main cognitive error of the pathological gambler is to make links between events that are in reality absolutely random. Gamblers will perceive patterns and signs about the patterns of numbers in a game that they believe allow them to predict the outcome. The basic misconception, which is specific to gambling, is expressed through a number of erroneous perceptions about gambling and games of chance. Examples of such misconceptions are: "I won three times in a row, that's my lucky day today," "Since I won yesterday and the day before, I can't lose today," "After winning the jackpot, I must continue gambling because I don't want to break my lucky streak," "When little numbers come up on the wheel, it means that a big one is coming." To identify these erroneous perceptions and to increase gamblers' awareness of them, a careful analysis of a gambling episode is carried out.

B. Detailed Analysis of a Gambling Session

An innovative way of assessing the gamblers' erroneous thoughts is through a detailed analysis of a gambling session. For this analysis, clients are invited to describe in detail what they were thinking about before, during, and after a gambling session. By asking gamblers what they were doing and thinking at each stage of a memorable gambling session, the therapist will gain access to the illusions and cognitive errors of clients. The following questions are examples of what the therapist may ask the client:

Before: "What were you doing when the idea of gambling popped into your head? What were you thinking at that precise moment, or what were you saying to yourself?" "Once you decided to go, what did you do? What was going through your mind?" "On your way to the casino, what were you thinking?" "Once you arrived there, what did you do and why? How did you choose your slot machine or roulette wheel? Did you start gambling right away? What were you thinking then?"

During: "What was your first bet? Why?" "Because gamblers have their own specific ways of gambling, how were you playing? What were you thinking at that precise moment? Why?" "Tell me more about what you were doing and thinking while you were playing the game." "Pretend I don't know the game, what would you recommend if I were to play? Why?" "Do you pay attention to what is happening on your slot machine or bingo table? Why?" "Once you lost the \$60, what did you do? What were you saying to yourself? Why didn't you quit at that time?" "When you went to the bank machine, what were you saying to yourself?" "When you came back to the game, what did you do? Why?" "Do you sometimes change your slot machine for another? Why?"

After: "Once you lost everything, what did you do? and why?" "On your way home, what were you thinking? What did you do after?"

The information gathered at the "during" phase of the analysis will identify the gambler's obvious misconceptions about randomness. This process also allows clients to discover some of their own errors in perception. Gamblers will often spontaneously describe strategies that assume that there is more predictability present than is in fact the case. Inevitably, gamblers wrongly use information to predict an event that is independent of all other

events, and is essentially unpredictable beyond its chance probability. The therapist's attitude during this analysis should be one of curiosity and a certain naiveté concerning gambling, rather than a confrontational or challenging approach. This will usually lead to cognitive dissonance within clients, as they attempt to clarify and justify their beliefs and behaviors; this dissonance can be useful in the therapeutic phase. The ultimate goal of this procedure is to make clients doubt the validity and reliability of the predictors they rely on while gambling (behavior, feelings, thoughts). Progressively, clients will learn to free themselves of their erroneous thoughts and regain control over their choices and lives.

C. Cognitive Treatment

In the next phase of therapy, clients are invited to give their definition of the concept of chance or randomness. At this point, games of skill are discussed in contrast to games of chance, as gamblers often mistakenly believe that games of chance can be influenced by the application of skills that will improve their chances of winning. This example of the illusion of control explains why people tend to bet more money as they become more familiar with a game, firmly believing that they have developed specific skills that can be used profitably. During this stage of treatment, information is provided to highlight the fact that games of chance essentially exist for business reasons, and that therefore the sole purpose of these games is to make a profit. At this point, clients may become ready to discuss their misconceptions about randomness and all the pitfalls that surround this misconception. Literature detailing the frequent misconceptions about gambling may then be provided to the gamblers.

D. Increasing Awareness toward the Notion of Randomness

The crucial concept of randomness, or independence between events, is addressed as a priority in the treatment. The explanation and demonstration of the fundamental concept of randomness is the heart of the treatment program. The concept of randomness is essentially that no event can influence another, which results in the absolute unpredictability of events. Because games of chance are random, the events they involve cannot be influenced, and in reality no strategy has the capacity to control the outcome of the game. The therapist will illustrate the concept of randomness by referring to the client's own gambling strategies, helping

them to realize that these strategies arise from the mistaken linking of independent events. The therapist should always remain focused on any verbalizations made by the client relating to the attempt to predict the outcome of a game by linking unrelated events. Clients will gradually realize that their beliefs are erroneous, and more importantly that these beliefs are based on the association of irrelevant events, that are actually unrelated to their chances of winning.

A useful way to illustrate how erroneous links can be made between unrelated events is to toss a coin. First, therapists might ask the gambler to predict whether the next toss will result in heads or tails and to explain their choice. Most gamblers will say that their choice is based on a 50/50 probability of each possible outcome, which is indeed correct. This exercise is carried out a few times to demonstrate that predicting heads or tails is simple, and that the outcome of each toss is independent from every previous toss. At this point, clients will generally agree with the therapist. Then, to demonstrate the presence of erroneous perceptions during gambling, a simple test can be performed. The therapist tosses a coin six times without showing the results to the client. The therapist then writes down six consecutive heads, no matter what really happened, and covers these results with a piece of paper. Once again, the gambler is asked to predict the outcome of the next toss. After the choice has been made, the six "previous" outcomes are revealed, and the gambler is asked if he or she would like to change his or her prediction before the coin is tossed again. Whether the gambler changes the prediction or not, he or she will certainly examine the series of previous outcomes. The therapist can then point out that although the client knew that every outcome of a coin toss would be independent, the gambler examined past outcomes even though they were perfectly useless in the prediction of the next result. This simple exercise has proven to be very helpful for demonstrating how this tendency to link irrelevant events is very powerful. The concept of randomness is then explained in detail and illustrated by examples of specific types of games the client has played.

E. Cognitive Restructuring Exercise Sheet

In the next part of treatment, clients are asked to identify their own erroneous perceptions about gambling and to write them down. This can be achieved through an additional analysis of a specific gambling session, or through a variety of methods, that is, asking

gamblers to describe what they typically say to themselves when they gamble; by simulating a game and having clients describe how they choose their bets; or by asking them to imagine a gambling session and describing out loud what they are thinking using the "thinking out loud" method for gambling.

During the therapy program, pathological gamblers will monitor their own verbalizations when they are thinking about gambling, when they have the urge to gamble, or when they actually gamble, if they are not able to remain abstinent. The client's tasks are to (a) to identify erroneous perceptions, (b) to evaluate and challenge the adequacy of these perceptions, (c) to replace these inadequate perceptions by adequate verbalizations, and (d) to assess the strength of their beliefs in their new, realistic perceptions. The following is an example of how such cognitive restructuring might be achieved with clients who have just relapsed and lost a large sum of money:

Therapist: "What happened before you decided to gamble?"

Gambler: "I had just received an unexpected amount of money."

Therapist: "What did that mean to you at that moment?"

Gambler: "I saw it as an opportunity to make it grow a little."

Therapist: "To make it grow..."

Gambler: "Yes, since I had lost so many times recently, I felt it was going to be my turn to win."

Therapist: "Do you usually listen to such a feeling?"

Gambler: "Yes, all the time!"

Therapist: "Does it ever happen that you lose, even when you have this feeling?"

Gambler: "I understand what you mean by that question..."

Therapist: "This feeling seems to get you into a lot of trouble. Since you listen to it, would you rate this feeling as a good or bad predictor of winning?"

Gambler: "I never thought of being critical about my feelings. I guess I should be..."

The successful resolution of this phase is normally required before further issues can be addressed. If the illusion of predictability in gambling events remains, relapse is likely to occur. This is the most important target of the treatment. Of course, other erroneous thoughts, superstitions, or intuitions also stem from the basic error of linking independent events. The belief that a specific watch can bring luck and that a specific feeling can predict the outcome of a game are good examples of this phenome-

non. However, other erroneous thoughts must also be addressed even if they are not linked to misconception about randomness. For example, many gamblers will say to themselves that “I have nothing to lose by continuing to gamble” or “This time, I will control myself,” or “I will gamble only \$20.00, that won’t do me any harm,” or “I want to win a last time before I quit gambling. I must not quit as a loser.” Obviously, all these thoughts must be addressed if a treatment is to be maximized.

When they are in the process of modifying their habits, gamblers usually find it helpful to use a cognitive restructuring exercise sheet. When they are confronted with a high-risk situation, clients must ask themselves what they are thinking, identify what their misconceptions are, and correct them with realistic thoughts. Finally, clients must choose what they want to do. Gambling is a choice as long as the gamblers are fully aware of their thoughts, beliefs, and misconceptions. Furthermore, our clinical experience and empirical data support the proposal that other therapeutic components such as behavioral strategies can be helpful within such a cognitive therapy to diminish the risk of a relapse. However, these behavioral interventions must follow, not precede, the cognitive correction of erroneous perceptions if therapeutic gains are to be maintained.

F. Behavioral Strategies and Relapse Prevention

Clients undergoing treatment for pathological gambling often struggle with many high-risk situations that may reduce their resistance to gambling. Cognitive correction will help clients to develop a more realistic perception of gambling that will help them to refrain from participating in these activities. However, social, professional, or financial difficulties may compromise their abstinence goal and put them in a state of vulnerability. Behavioral interventions can forestall many problems and raise the efficiency of a cognitive treatment.

A basic relapse prevention strategy is to ask clients to list the high-risk situations that may confront them following treatment. The purpose of this exercise is to make clients aware of what triggers their desire to gamble. There are five main categories of high-risk situations: (a) exposure to gambling situations, (b) financial problems, (c) emotional or relational problems, (d) lack of employment, and (e) alcohol and drug consumption. These difficulties can be prioritized, and strategies for dealing with these situations can then be generated through the use of problem-solving training or social skills training.

1. *Exposure to gambling situations:* Exposure to a gambling situation is by far the most difficult test of the gambler’s ability to remain abstinent, and the one in which relapse is most likely to occur. Thus, therapist and client must discuss the possible consequences associated with high-risk gambling situations. Avoiding these situations becomes an alternative, and clients are strongly encouraged to find strategies that will enable them to avoid exposure to gambling. For example, on their way home from work, clients may choose alternatives route that do not require them to drive past a gambling establishment. Or, a client may choose only to frequent bars that do not have video lottery terminals.

2. *Financial problems:* Because excessive gambling involves important financial loss, gamblers must find ways to stabilize their financial situation. It will therefore be useful for the therapist to know how much money has been lost in gambling activities, what the client’s weekly earnings and expenses are, as well as the amount of the client’s gambling-related debts. Given this information, the therapist can help clients find money-managing strategies such as asking a family member to take care of their finances for a period of time. During the high-risk period immediately following therapy, many gamblers find it helpful to carry a small amount of money or no money at all on their person. This behavioral strategy serves to restrict access to money and discourage excessive gambling behavior. Along with cognitive therapy, some clients may benefit from the advice of a financial counselor, to help resolve financial problems and maintain their motivation to abstain from gambling.

3. *Emotional and relational problems:* If needed, the therapist might explain how emotional or relational difficulties are linked to gambling problems and discuss ways in which the client can resolve these difficulties. Social skills training is useful, for example, when gamblers have difficulty saying “no” to an invitation to gamble. Social skills training can teach clients how to refuse such invitations. For others, gambling activities might conceal difficulties with establishing social contacts or maintaining friendships. Learning how to develop new, mutually rewarding social ties might in these cases aid clients in abstaining from gambling.

4. *Lack of occupation:* Gamblers are encouraged to look for new activities to occupy the time they formerly spent gambling. Activities they enjoyed prior to the onset of their gambling problem are often the key to safely occupying their new spare time. Scheduling specific activities is a good way to avoid the feelings of emptiness and boredom that are so frequently associated with relapse. Behaviors that improve the quality and closeness of

clients' relationships are emphasized. In fact, because pathological gamblers tend to isolate themselves, they often abandon activities involving their spouses or children. Simply encouraging clients to go to the park and play with the people they love can be very beneficial.

5. *Alcohol and drug consumption:* For many gamblers, alcohol or drug consumption contributes to losing control and leads to excessive gambling. If this appears to be an issue, it should be evaluated immediately. Even if there is no substance dependency, but some substance abuse is occurring, the client will have to address this issue because it can contribute to the maintenance of excessive gambling.

G. Relapse Prevention

Relapse prevention is a major theme throughout therapy. When clients have successfully modified their cognitive errors and gambling behaviors, the therapist introduces a relapse prevention strategy. First, the therapist asks clients to describe what a relapse would mean to them, and then to outline the events, thoughts, or situations that could trigger such a relapse. A discussion about past relapses can be helpful. The therapist employs other strategies to prevent relapse such as a gradual tapering-off of therapy or increasing time between consultations. This tapering-off strategy encourages clients to perform their cognitive exercises after the end of the therapy, to use available resources, and to promote the idea of participating in self-help groups such as Gamblers Anonymous. Finally, the therapist outlines what clients can do in emergency situations, or when they experience the overwhelming urge to gamble. They are instructed to: (a) stay calm, (b) remember their commitment, (c) carefully analyze the situation that has produced the relapse or increased their desire to gamble, and (d) ask for help.

II. THEORETICAL BASIS

The central assumption of cognitive approaches to the treatment of pathological gambling is that individuals gamble because they maintain the unrealistic hope that they will recover their losses if they continue to gamble. It is assumed that their erroneous beliefs about gambling, the nature of predictability, and their own special skills and knowledge concerning the prediction of gambling outcomes conspire to maintain the gambling far beyond any reasonable limits. It follows that the correction of these erroneous perceptions weakens the belief that gambling losses can be recouped.

Gambling takes place when an item of value, usually money, is staked on the outcome of an event that is entirely unpredictable. In gambling, the primary task of gamblers is to use available information at their disposal to try and predict the outcome of an event that is essentially unpredictable. Most gamblers behave as if the act of gambling actually involves some element of personal skill, the exercise of which might influence the outcome of the game. In the mind of the gambler, skill can be superimposed on chance. This phenomenon, described as an illusion of control, refers to the belief that the outcome of a chance event can be influenced or controlled to some degree by one's skill or ability.

Most gamblers fail to correctly perceive or understand that there is no relationship between their behavior and the outcome of a chance event, and that no matter how hard they try, they have no ability to exert any influence or control over the final outcome. There is an abundance of experimental and anecdotal evidence demonstrating the existence of this illusion of control among gamblers.

James Henslin conducted an observational study of gamblers in the casinos of Las Vegas. He described a characteristic behavior displayed by some gamblers: when "craps" players wished to obtain a high number on the roll of a dice, they threw the dice rapidly and forcefully, while when they desired a low number, they threw them slowly and lightly. In this case, the illusion of control can be seen through the player's attempt to "control" which numbers come up through the use of a specific type of wrist motion when throwing the dice.

In our laboratories, we have verified the central role that illusions of control and erroneous perceptions have in the overall process of gambling. In one experiment, we invited two groups of gamblers to participate in a session of roulette. The two groups were exposed to the same conditions as those found in a casino, with one exception: the "active gamblers" were allocated the responsibility of throwing the roulette ball themselves, while for the "passive gamblers" in another group, the dealer performed this task. In reality, the numbered slot where the ball finally came to rest was left to chance regardless of whether the gambler or the dealer threw the ball onto the roulette wheel. However, the results of the experiment clearly demonstrated that participants who threw the ball themselves placed higher bets and overestimated their chances of winning to a greater extent than did the passive gamblers.

As intelligent beings, we like to impose order and causality on the events that happen around us. We are not used to, and feel a degree of discomfort in, relying

on chance as an accurate and plausible explanation for events. Chance is a concept we are most likely to invoke when confronted with events that are totally unusual, unpredictable, coincidental, or unexpected. However, scientific studies have convincingly revealed that few people fully understand the concept of randomness. People do poorly in generating a random sequence of numbers. People have an excessive tendency to avoid repetition, and because of this, when asked to produce something random, they produce too many variations in sequences or patterns. For example, few individuals will believe that the following sequence of heads (H) and tails (T) was randomly generated: H-T-H-T-H-T-H-T. The same is true when playing the 6/49 lottery. Few will have the courage to select 20, 21, 22, 23, 24, and 25 as their choice of numbers despite this series having the same probability of coming up as any other combination.

We have noted that this cognitive tendency reflects the fact that people in general find it difficult to take into account the independence of events. This cognitive tendency or trap is, in our opinion, one of the most important elements in understanding the psychology of the gambler, and ultimately, the pathological gambler. Let's take another example. When we ask gamblers to generate sequences of "heads and tails," we observe that more than 70 to 80% of people rely on the outcome of past events in predicting the next one. Yet, we also know very well that in each toss of the coin, "heads" or "tails" has, and will always have, a one in two chance of appearing. How does this error in thinking often manifest itself? A detailed analysis indicates that the principal error committed is in the desire to have an equal proportion of "heads" and "tails" in a sequence; the gambler attempts to move away from any form of apparent pattern and avoids long sequences of the same event. This has been shown empirically by the tendency of people to prefer a selection of "heads" after a run of six or seven "tails." The outcome of the next toss is still one in two for heads independent of whatever pattern or sequence of heads or tails came before it.

What happens in the minds of problem gamblers when they are in the midst of gambling? How do gamblers interpret the probabilities and outcomes of a game to conclude that, despite the presence of repeated losses, taking continued greater financial risks is justifiable? Several observations made in our experimental and clinical work leads us to the conclusion that gamblers' cognitive activity is distorted in many respects, and that these distortions bias the individual's perception of reality. To understand and solve the puzzle of cognitive dis-

tortions, we must examine the cognitive activity of gamblers during play; for this purpose, the "thinking out loud" method is extremely useful. In this method, gamblers are requested to clearly verbalize all the thoughts that go through their minds about the game itself, even if these statements seem unimportant or irrelevant to them. This verbalization of internal dialogue is recorded onto audiocassette and then analyzed by an experienced psychologist. The researcher then evaluates and categorizes the cognitive content of the audiocassette into two classifications: "rational and adequate" or "irrational and erroneous," according to whether the elements verbalized seem to consider accurately chance as the primary determinant of the outcome. With the assistance of the thinking out loud method, we studied slot machine players. The results showed that more than 75% of the verbalizations made by the players were irrational, inadequate, or erroneous; that is, they did not reflect reality in that they clearly ignored or denied chance as the determining element of the game. It should be noted that this is a particularly large percentage considering that slot machines involve little subtlety and no opportunities to apply personal skill of any kind.

These results have been independently confirmed in several other studies carried out around the world, among different types of gamblers, using various types of games. In addition, we have observed that the erroneous perceptions of gamblers share a common factor: Gamblers consistently commit the error of associating previous independent events in predicting the outcome of the game.

III. EMPIRICAL STUDIES

Although the prevalence estimates of pathological gambling range between 1 and 2% of the population, the number of gamblers who will seek professional treatment is only a small percentage of the population. Relatively few effective interventions have been developed and validated. Most published papers dealing with the treatment of pathological gamblers have either been uncontrolled case studies, or consisted of small samples, thus making it difficult to reach any conclusions about the efficacy of the interventions in question. Their most useful function might be as a source of valuable hypotheses concerning treatment efficacy that can then be evaluated more rigorously. This article is based on studies that have employed a randomization procedure to allocate gamblers to treatment and control groups. A review of the literature reveals that few studies appear to

exist, originating in Australia, Canada, and Spain. We review these studies, according to the countries where the interventions were developed and evaluated.

A. Australia

Nathaniel McConaghy, Alex Blaszczynski, and their colleagues, in Sydney, have conducted several controlled studies of imaginal desensitization (ID), which is based on a conceptual model of compulsive behavior. According to their theory, if an individual does not perform a given compulsive behavior when in the presence of conditioned stimuli (which could be environmental or cognitive), tension and arousal will increase and will be relieved only when the compulsive behavior is carried out. Imaginal desensitization (ID) was developed as a means of giving individuals control over their compulsive behavior by reducing their level of arousal and tension in the presence of the conditioned stimuli, so that the urge to complete the behavior sequence is no longer experienced.

In 1983, these researchers compared the efficacy of ID for pathological gambling to electric aversion therapy. ID consisted of inducing a relaxed state in the presence of several imaginal gambling-related episodes. Electric aversion therapy consisted of delivering an aversive stimulus to inhibit the excitation produced by undesired gambling stimuli and interrupt the compulsion to gamble, which otherwise would be acted on. The key findings were a significant difference in the number of ID participants attaining cessation or a marked reduction of their gambling and urges, compared to participants in the electric aversion condition. They further conducted an additional trial to evaluate the efficacy of ID. Twenty pathological gamblers were randomly allocated to ID and imaginal relaxation, a treatment similar to ID but that does not instruct the individual to visualize gambling situations but rather being in the presence of relaxing situations. Results indicated no differences at either follow-up assessment point, with 30% of both groups reporting either abstinence or controlled gambling. Similar results were reported for gambling urges.

B. Spain

Enrique Echeburua and his colleagues compared three different active treatments for pathological gambling to a wait-list control group. The active treatments consisted of exposure–response prevention, group cognitive restructuring, and a combination of these two types of treatment. Exposure–response prevention is a behavioral treatment in which participants are trained to

manage money, avoid gambling situations, and encouraged to remain present in high-risk gambling situations but refrain from gambling. The cognitive treatment challenged the “illusion of control” and other memory biases within a group format. The combined treatment included both treatments. These three treatments differ from each other that one half of the participants in each type of treatment received it in a group format, and the other one half received it in an individual format. Although the three treatment groups showed higher rates of abstinence at 6-month posttreatment than did the control group, there was no difference between the combined group and the control group. The individual treatment was found to be superior to the group or combined treatment at the 12-month posttreatment assessment, but there were no group differences between the active treatments for any of the other dependent variables at 12 months. The control group, however, did show considerable improvement at 6 months on most of the gambling-dependent variables, which suggests that natural recovery or spontaneous remission played an important role in the outcome of this study. This finding underscores the need for including non-active control groups in gambling research studies.

In a follow-up to this study, 69 problem slot machine gamblers were treated with stimulus control and *in vivo* exposure with response prevention and then randomly assigned participants to one of three treatments: individual relapse prevention (RP), group RP, and no treatment control. The RP conditions trained participants to identify high-risk gambling situations and to develop effective coping strategies for these situations. Exposure to gambling-related stimuli was also included as a component of RP. All 69 participants stopped gambling following the exposure–response prevention phase of the study, a precondition to enter the relapse prevention phase. The results showed no significant differences between the two RP groups and the no-treatment control group until 3 months posttreatment. At that point, and continuing until the 12-month follow-up point, the two active RP groups were achieving significantly higher rates of abstinence than the control group.

C. Canada

A treatment developed by Robert Ladouceur and his team was among the first to target cognitive errors, such as the independence of events, in the treatment of pathological gambling. Assuming that this fundamental error is the basis of the progression of nonproblematic to problematic gambling behavior, the target of the treatment was to help gamblers realize this cognitive

error and provide them with the means of correcting their perceptions. Using a single-case experimental design, this treatment program included four components. The combination of cognitive correction, problem-solving training, social skills training, and relapse prevention resulted in positive treatment outcomes. Following treatment, participants no longer met *DSM-III-R* criteria for pathological gambling. These results were maintained at a 9-month follow-up.

Three ensuing studies further investigated the efficacy of this procedure through the use of controlled designs. The efficacy of cognitive-behavioral treatment was compared to a wait-list control group. Participants were randomly assigned to a control group or to an individual treatment consisting of cognitive correction of core erroneous gambling cognitions, problem-solving training, social skills training if indicated (about one half of the sample) and relapse prevention. The treated group was found to improve on all key dependent variables compared to the control group, as well as on measures of gambling behavior (frequency, hours spent gambling, and amount of money spent gambling). Clinically significant changes indicated that the majority of the treated participants no longer met the *DSM-III-R* criteria neither at the end of treatment nor at the 12-month follow-up.

Because the cognitive correction was accompanied by two behavioral procedures (problem solving and social skills training), these positive outcomes may not have solely been the result of the cognitive intervention but may also have been due to the positive effects of the behavioral intervention. To investigate this possibility, a preliminary study of the treatment of five pathological gamblers was examined using a multiple-baseline, across-participants design. Cognitive correction targeted gamblers' erroneous perceptions of randomness was the only therapeutic intervention used. Following treatment, four participants reported a clinically significant decrease in their desire to gamble, an increase in their perception of control, and no longer met *DSM-IV* criteria for pathological gambling. Therapeutic gains were maintained at a 6-month follow-up assessment. These results suggest that a cognitive therapy targeting misconceptions about randomness is a promising treatment for pathological gambling.

In a related study, Ladouceur and his colleagues compared the efficacy of this purely cognitive treatment to a wait-list control group. Patients (mainly video lottery players) were randomly assigned to an individual treatment consisting of the cognitive correction of core erroneous gambling cognitions, followed by relapse prevention. The treated group was found to improve on all key dependent variables compared to the control group,

as well as on measures of gambling behavior (frequency, hours spent gambling, and amount of money spent gambling). Thirty of the 35 treated participants (85.7%) attained the criteria for clinically significant change compared to 4 of 29 participants (13.8%) in the control group. More important, all 35 treated participants scored 4 or less on *DSM-IV* criteria for pathological gambling. These therapeutic gains were maintained at a 6- and 12-month follow-ups.

This latter study was recently replicated, but therapy was delivered in a group rather than an individual format (4–5 individuals per group). Results from this study confirmed previous results: Over 85% of the treated gamblers were no longer considered pathological gamblers (*DSM-IV*) at the end of treatment. In addition, participants had a greater perception of control over their gambling problem, as well as an increased self-efficacy in high-risk gambling situations.

These studies show that the central component of the treatment was highly specific, and based on a theoretical understanding of cognition in gambling, which may explain the magnitude of therapeutic gains. Research on the psychology of gambling suggests that gamblers' core cognitive error lies within their beliefs about randomness, and in their belief that they can control the outcome of random events (the illusion of control). It follows that if the gambler's erroneous perceptions and understanding of randomness can be corrected, then the motivation to gamble decreases dramatically.

IV. SUMMARY

Effective treatments are now available to help pathological gamblers. The rationale of the interventions is grounded in empirical studies that have clarified the psychology of gambling. Clinical research should now address the important issue of which patients should receive which treatment.

See Also the Following Articles

Addictions in Special Populations ■ Controlled Drinking ■ Matching Patients to Alcoholism Treatment ■ Relapse Prevention ■ Substance Dependence: Psychotherapy

Further Reading

Bujold, A., Ladouceur, R., Sylvain, C., & Boisvert, J. M. (1994). Treatment of pathological gamblers: An experimental study. *Journal of Behavior Therapy and Experimental Psychiatry*, 25, 275–282.

- Echeburua, E., Baez, C., Fernandez-Montalvo, J. (1996). Comparative effectiveness of three therapeutic modalities in the psychological treatment of pathological gambling: Long term outcome. *Behavioural and Cognitive Psychotherapy*, 24, 51–72.
- Echeburua, E., & Fernandez-Montalvo, J., & Baez, C. (2000). Prevention in the treatment of slot-machine pathological gambling: Long-term outcome. *Behavior Therapy*, 31, 351–364.
- Ladouceur, R., Sylvain, C., Boutin, C., & Doucet, C. (2002). *Understanding and treating pathological gamblers*. New York: John Wiley & Sons.
- Ladouceur, R., Sylvain, C., Boutin, C., Lachance, S., Doucet, C., Leblond, J., & Jacques, C. (2001). Cognitive treatment of pathological gambling. *The Journal of Nervous and Mental Disease*, 189, 766–773.
- Ladouceur, R., Sylvain, C., Letarte, H., Giroux, I., & Jacques, C. (1998). Cognitive treatment of pathological gamblers. *Behavior Research and Therapy*, 36, 1111–1120.
- Ladouceur, R., & Walker, M. (1996). A cognitive perspective on gambling. In P. M. Salkovskis (Ed.), *Trends in cognitive therapy* (pp. 89–120). Oxford: Wiley.
- McConaghy, N., Armstrong, M. S., Blaszczynski, A., & Allcock, C. (1983). Controlled comparison of aversive therapy and imaginal desensitization in compulsive gambling. *British Journal of Psychiatry*, 142, 366–372.
- McConaghy, N., Armstrong, M., Blaszczynski, A., Allcock, C. (1998). Behavioural completion versus stimulus control in compulsive gambling. *Behavioural Modification*, 12, 371–384.
- McConaghy, N., Blaszczynski, A., Frankova, A. (1991). Comparison of imaginal desensitisation with other behavioural treatments of pathological gambling. A two to nine year follow up. *British Journal of Psychiatry*, 159, 390–393.
- Shaffer, H. J., Hall, M. N., & Vander Bilt, J. (1997). *Estimating the prevalence of disordered gambling in the United States and Canada: A meta-analysis*. Boston: Harvard Medical School Division of Addictions.
- Sylvain C., Ladouceur R., & Boisvert, J-M. (1997). Cognitive and behavioral treatment of pathological gambling: A controlled study. *Journal of Consulting and Clinical Psychology*, 65, 727–732.

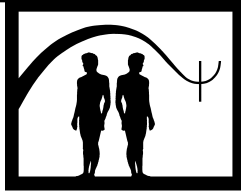

Gestalt Therapy

Stephen G. Zahm and Eva K. Gold

Pacific University School of Professional Psychology and Gestalt Therapy Training Center–Northwest

- I. Description of Treatment
 - II. Theoretical Bases
 - III. Applications and Exclusions
 - IV. Empirical Studies
 - V. Case Illustration
 - VI. Summary
- Further Reading

foreground As distinguished from background, that aspect of experience that is the focus of attention at any given point.
Gestalt A German word that has no direct translation in English. “Configuration,” “structure,” and “whole” are used as translations, but none of these capture the complete meaning. “Figure” and “Gestalt” are often used interchangeably.
organismic self-regulation The process whereby homeostasis is maintained via the figure formation/destruction process.

GLOSSARY

background As distinguished from figure or foreground, that which is not uppermost in awareness. Provides the context and is the source from which figures emerge and become prominent in awareness.

closure The result of the natural movement toward the completion of perceptual or experiential units.

contact The experience at the self/environment boundary that leads to assimilation and growth. Good quality contact involves awareness and excitement.

contact boundary The dynamic relationship at the meeting point of self/other, or self/environment. Where experience occurs, and the focus of therapeutic intervention.

creative adjustment A person’s best adaptation to dealing with feelings and needs in response to environmental inadequacy in meeting the needs, or competing environmental requirements.

figure What stands out from the background as a focus of interest and attention. Generally related to a need or desire.

figure formation/destruction process The process whereby a figure of interest emerges, becomes a focus of attention and is acted upon, resulting in the dissolving of that figure.

Gestalt therapy has roots in psychoanalysis, Gestalt psychology, Reichian character analysis, and the work of the early phenomenologists. It was developed in the 1940s primarily by Frederick Perls, Laura Perls, and Paul Goodman. Gestalt therapy is humanistic, holistic, and experiential. It is a process-oriented and relational approach based on a theory of healthy functioning. The focus in therapy is on disruption of the natural process of self-regulation. The goal of treatment is the restoration of awareness, which allows for increased choice and flexibility in all aspects of living.

I. DESCRIPTION OF TREATMENT

A. Philosophical Foundations

Gestalt therapy method is guided by three philosophical foundations. The first of these is field theory, a concept that comes from physics. The “field” is a dy-

namic interrelated system, each part of which influences every other part. Nothing exists in isolation. Gestalt therapy is a field theoretical and process-oriented approach, which means the therapist attends to the total field including content and subject matter, as well as the here-and-now process occurring in the moment. This involves things such as the patient's tone of voice, style of communication and interaction, facial expression, physical gestures, posture, breathing, sensation, and affect. The therapeutic field also includes the patient's history and current situation, the therapeutic relationship, feelings experienced by the patient and the therapist, and their mutual impact on one another.

The second philosophical foundation is phenomenology. The Gestalt therapist attempts to bracket off preconceived biases, beliefs, theories, and interpretations, and attend as much as possible to what is actually understandable through the senses, with the focus on the patient's subjective experience. The therapeutic stance is one of meeting the patient where he is, and the therapist describing what she observes, rather than explaining or interpreting. The patient is encouraged to do the same. The therapist also brings her own feelings, sensations, and awareness into the interaction with the patient when useful for the treatment.

The third philosophical foundation is dialogue. A dialogic stance requires that the therapist be "present," confirm the patient, and be available for an I-Thou way of relating. Presence is the therapist bringing all of himself to the encounter in the here and now. Confirmation involves seeing and accepting patients for all they are and all they are capable of being. The I-Thou mode of relating has the qualities of immediacy, directness, presence, and mutuality. These qualities create a therapeutic relationship that is not hierarchical, and a meeting between patient and therapist that is in and of itself healing.

B. Goal of Treatment/Theory of Change

In Gestalt therapy, the goal is increased awareness. Although the patient presents specific symptoms such as anxiety, depression, stress-related physical complaints, relationship difficulties, or character/personality issues, the Gestalt therapist does not focus only on symptoms or behavior change. Rather, Gestalt therapy provides a holistic perspective where symptoms and problematic behaviors are seen as the person's best attempt to deal with conflicting needs, or needs conflict-

ing with environmental requirements. Psychological problems, symptoms, and difficulties in interpersonal relationships result from what were originally creative adjustments that have become rigid, reflexive, and unaware, restricting the experience of self, and possibilities. By focusing on moment-to-moment process in the therapy session, the Gestalt therapist works with how the person creates and maintains her particular experience of self and other, and how this experience impacts the current situation.

Change then occurs spontaneously, as a result of this increased awareness. Gestalt therapy's change theory is paradoxical in the sense that change occurs not as a result of attempting to change (one part of the self trying to control and dominate another part) but as a result of the patient attending to, investing more fully in, and living more completely the actual current experience—what is. Doing this enables new responses to emerge that better fit current needs. Increased awareness leads to choice and opens up new options for behavior and interaction.

As aspects of the personality that have been disowned are re-identified with, an expanded sense of self is also restored. For example, the patient increases her capacity to experience and express grief, anger, or tenderness, which expands her ability to live authentically, and to connect more with other people. Gestalt therapy does not focus directly on problem solving, but rather on what limits the patient's capacity for creative solutions. As the saying goes "Give a person a fish and he eats for a day; teach a person to fish and he eats for a lifetime." A Gestalt therapist is interested primarily in the latter.

C. Therapy Method

By attending to observable behaviors that indicate blocked awareness and interruptions to acting on needs, desires, or interests, Gestalt therapy captures the essence of a person's existential position in the world, which impacts all aspects of self-experience and relationships. For example, the patient speaks softly, apologizes frequently, becomes slightly tearful but cannot cry, changes the subject, or shuts down if strong feelings threaten to emerge. Can she become aware of how she clamps down on herself? What makes this shutting down necessary? How might holding back, or not allowing herself to take up space be a theme in this patient's life? How many areas of her experience and relationships are impacted by it? How is it related to her presenting symptoms of anxiety or depression, or the dissatisfactions in her life?

The therapy process enables increased awareness of these blocks and how they are maintained, and also looks at why they were initially developed. For example, if the experience or expression of sadness has been criticized, punished, or even ignored by the parent, the child learns to cut off either the feeling, or its expression to others, or both. If a child's needs have been met with resentment, criticism, or disgust, the child's creative adjustment is to learn to block awareness of needs, or to learn to avoid showing or expressing them to others.

Through focused attention, the patient can become aware of how he blocks feelings/expression, for example, tightening muscles to hold back tears, internal messages such as "Don't be weak," or "Men don't cry." And the patient will discover the etiology—what made this necessary in his development. Symptoms then resolve as the patient reconnects with his authentic self and experience. For example, anxiety may result from a fear that certain "unacceptable" needs or feelings will surface in a particular situation. Depression may result from holding in anger or grief, poor self-esteem from directing frustration or criticism toward the self that needs to be expressed to another. Relationship problems may result from an inability to open up and reveal feelings, or difficulty needing another person.

Gestalt therapy's method is experimental and experiential. Experiments can be diagnostic as well as serving to highlight current experience and uncover new possibilities. For example, an unassuming person who does not make eye contact and qualifies most of what she says, complains that people do not listen to her or take her seriously. In therapy she might be asked to experiment with lecturing the therapist on the proper way to do something that is in her area of expertise. She might then show and experience the side of herself that is a knowledgeable expert. She may begin to speak more directly and forcefully. In this process she can get more in touch with this aspect of herself, as well as increasing her awareness of her reluctance to show this aspect of herself to others, or her anxiety in doing so. Conversely, the patient may speak to the therapist as if she is not an expert, when in fact she is. Her language might be filled with reflexive use of qualifying phrases. She might speak without conviction. In either scenario, the patient can see and understand how she contributes to others not giving her the respect she desires.

The patient also learns what made this way of being necessary. She could have been told "Children should be seen and not heard," or one of her parents might have become angry or silently disapproving if she ex-

pressed an opinion of her own. She might have been told she was stupid or wrong. Prior to therapy, she may not have remembered these incidents, she may have dismissed them, or minimized their impact. She may not even have been aware that she presented herself as timid and unsure of herself, or why it was important to do so. With the new awareness, she regains the possibility of a wider range in experience and behavior.

Gestalt therapy uses experimentation to increase awareness. Meaning for the patient then comes from experienced awareness rather than being imposed by the therapist's interpretation. The therapist tries to have no goal, agenda, or desired outcome in proposing an experiment, other than to observe and work with what happens next. An experiment can also be used to highlight an aspect of the patient's way of communicating. For example, a person who qualifies much of what he says by use of words like "Maybe," "Possibly," or "I guess," could experiment with either exaggerating the use of qualifying words, or cutting them out entirely and adding after every sentence "and I mean that." The therapist encourages the patient to pay attention to his experience as he does an experiment, and to express any reluctance in doing it.

Experiments can also enrich what a person is saying, and transform it from "talking about" to a lively present encounter. For example, the patient might imagine the person she is talking about is present in the room, and express her feelings directly to that person. This use of the empty chair or two chair experiment can also be effective in highlighting an internal conflict. The patient might imagine a part of herself in the empty chair and create a dialogue between the conflicting aspects of herself, such as the part that wants to be more creative and take more risks and the part that is more logical and conservative. This type of experiment can also explore an area of impasse or stuckness, for example, suggesting the patient develop a dialogue between the part of herself that wants to leave her marriage and the part that wants to stay.

To give an example of some of the above concepts, a patient who learned to stifle her feelings and needs, and to nurture herself with food comes to treatment depressed, with a poor self-concept, complaining that she has "tried everything" to control her eating and has been unsuccessful. Turning to food to meet emotional needs was at one time her creative adjustment, the best option available given the needs she had and the lack of available gratification possibilities—in this case a mother who was stern and unaffectionate and sent the patient to her room if she was "too emotional."

The Gestalt therapist observes this patient's responses in the moment, and helps to facilitate her awareness of them. For example, the therapist notices that the patient speaks more quietly and holds her breath when she talks about a hurtful or frustrating experience. The therapist can either make an observation ("It looks like you're tightening your jaw" or "I notice you holding your breath") or ask the patient to attend to what she is currently aware of ("What is your experience right now as you tell me this?"). The patient becomes aware that she is trying to control herself. The therapist attends to her need to control herself. He also attends to what she is controlling—verbalizing feelings, showing anger or tears. Through this process the patient becomes aware that there is also a part of her that would like to express itself and feels held back. Both aspects are explored.

The working through process involves the patient becoming aware of the importance of holding back feelings to prevent reexperiencing the rejection she felt from her mother, or the anger she felt toward her mother when she had feelings or needs. She might remember a forgotten traumatic experience. She might also discover that she expects the therapist to have a similar response. This patient learned over time to identify with her "nonfeeling, nonneeding" self. Her eating behavior may be one of the only remaining vestiges of her "feeling, needing" self. In therapy, she can also experiment with giving voice to the part of her that wants to eat, and re-identify with her needs and desires, instead of only wanting to suppress these needs. For example, she might realize that while part of her wants to stop overeating, part of her—out of her awareness—also wants to continue eating as a way to take care of feelings and to comfort herself. This part might say something like "Don't take food away from me, it's all I have." Change becomes possible as she invests more fully in being where she is—feeling those needs she translates into a desire for food—and may take the form of learning to nurture herself in other ways, or to get her needs met in relationship with others.

II. THEORETICAL BASES

Many central concepts of Gestalt therapy theory are based on laws of perception discovered and studied by Gestalt psychologists in the early 1900s. Gestalt therapy applies these laws more broadly to all aspects of experience and psychological functioning. Importantly, these Gestalt psychologists discovered that we are not simply passive recipients of perceptual stimuli, but that

we are active in organizing our perceptual field. Laws discovered by the Gestalt psychologists include the natural tendency to perceive a figure against a background as a way of organizing experience, and a natural tendency toward completion or closure.

Gestalt therapy takes its theory of healthy functioning from a biological concept called organismic self-regulation. This describes the organism's process of taking in from the environment what is needed (food, oxygen) and expelling into the environment that which is not required (waste products, carbon dioxide) in order to maintain balance or homeostasis. Applied to psychological functioning, this theory says that in health, people will naturally go to the environment to get emotional and psychological needs met—the need to be listened to, need for support, sex, physical comfort, social contact—and will discharge as needed by talking, expressing feelings, crying, touching, doing, and creating. Gestalt therapy theory does not see the individual as separate from the environment but rather considers the individual/environment field.

According to Gestalt therapy theory, such self-regulation occurs via the figure formation/destruction process. This process is central to any human functioning and as such is a core characteristic of people. In all functioning there is an ongoing process of the formation of a figure of interest and the eventual gratification and dissolution of this need or interest. This cycle has several stages: (1) awareness, (2) clarification of need/interest (3) scanning self-environment, (4) action, (5) contacting, (6) assimilating, and (7) withdrawing. For example, I am on my way to my favorite restaurant for lunch and see an old friend across the street. I become aware of sensations of excitement and increased energy (stage 1). I recognize my interest in talking to my friend (stage 2). I understand that walking across the street will facilitate meeting this need (stage 3). I walk across the street (stage 4). I say hello, and give my friend a hug, and we talk (stage 5). As we say goodbye I tell my friend and acknowledge to myself what this meeting meant to me (stage 6). I walk back across the street with a feeling of satisfaction, resolve to see my old friend more often, and my focus shifts to what I want to eat for lunch (stage 7).

In healthy functioning, a person will maintain balance by intake and discharge as required for the satisfaction of emotional and psychological needs by this continuous process of figure formation/destruction. Assuming there is no interference in this process (a disruption that causes the person to misperceive her needs, or an environment that is hostile to the needs, or both) what becomes figural or foreground is based on

the most pressing need at any given moment. After a need is met, this figure recedes (closure) and is replaced by whatever is next in the hierarchy of needs.

When there is a disjuncture between needs and what is available in (or required by) the environment, a person adapts. A creative adjustment is the best possible accommodation she can make at the time, given her experience, perceptions, and limitations. Over time, these creative adjustments may become obsolete, rigid, and maintained out of awareness, limiting a person's potential for satisfaction and growth. Psychotherapy involves looking at and understanding how the natural self-regulatory process has become disrupted, preventing closure on units of experience.

Disruption can occur at any stage of the figure formation/destruction process, and diminish a person's experience of himself and his ability for contact. A person who is experiencing disruption interferes with his own development of a strong and clear figure (stage 1 and 2) or with the ability to maintain the excitement and energy necessary for action (stages 3 and 4) or to move into satisfying contact (stage 5), which allows for assimilation (stage 6) and closure (stage 7). Either the interference with the development of a strong figure, or the blocking of excitement and action can interfere with good-quality contact. A Gestalt therapist is trained to observe both where in the cycle the disruption occurs and how it occurs. Often the focus is on how the disruption dilutes or distorts interpersonal contact.

In health, a person will perceive, experience, identify with, and act on needs and desires. Healthy functioning requires the ability to readily identify "This is me" or "This is for me," versus "This is not me" or "This is not for me." When disturbances exist in perceiving, experiencing, identifying with, and acting on needs, this loss of functioning is observable by the trained therapist at the contact boundary, which refers to the dynamic relationship at the point where the person and environment meet and interact.

The following five processes are the "how" of any disruption of contact. These processes can occur at any stage of the figure formation/destruction process. It is via these processes, maintained rigidly and out of the person's awareness, that the experience of self and the ability for contact that includes satisfaction of needs and closure is diminished.

Introjecting is experiencing something in the environment as if it is part of the self. An introject is an idea that has been "swallowed whole" without the "chewing" necessary to assimilate it and make it truly a part of the self. Introjecting is particularly problematic if it is a person's primary way of dealing with the world and

relationships (such as doing things for others and ignoring one's own needs out of a sense of duty or obligation) or when the introject is destructive (such as a parental introject "You're good for nothing").

Projecting is disowning a feeling, behavior, attitude, or trait of one's own and attributing it to another, or the environment. For example, a person who is not able to be angry—due to an introject—may inaccurately perceive another person as angry at him.

Retroreflecting is when energy or action that could be directed toward the environment circles back and is directed at oneself. Retroreflecting is of two types. In the first type a person directs toward herself a feeling or action meant for someone or something in the environment. For example, the person who is unable to experience anger toward another person—again due to an introject—might end up blaming herself. Any unaware suppression or shutting down is also accomplished by this type of retroreflecting. The second type of retroreflecting is doing for/to oneself what you would like another person to do for/to you. For example, a person might soothe herself, buy herself gifts, or hug herself instead of getting this need met by interacting with another.

Confluence is the attempt to deny the existence of a self/environment boundary. Confluence requires a lack of discrimination and articulation of points of difference or otherness. While there is the possibility of a "healthy" confluence during which two people feel so joined that they seem "as one" (such as at the moment of orgasm) and there is momentary dissolving of the boundary, prolonged attempts to maintain confluence prevent satisfying contact.

Deflecting is behavior that dilutes or reduces the intensity of contact. Examples are avoiding eye contact, laughing off what one says, circumlocution, and understating one's true feelings. There is disagreement among Gestalt therapy theorists as to whether this is to be considered a separate self-regulatory boundary process, or whether it is the behavioral manifestation of the others—that is a result of introjects, retroreflection, projection, or desire to maintain confluence.

III. APPLICATIONS AND EXCLUSIONS

Because Gestalt therapy is not an adjustment therapy and strives to be value-free, with a focus on understanding each unique individual and the individual's subjective experience as opposed to an "objective" standard for psychological health, there is no popula-

tion that would be excluded from treatment. The phenomenological and field theoretical stance, whereby the therapist is striving to understand the patient's subjective experience rather than impose his own, make this orientation valuable for different cultures and minority groups. The Gestalt therapist does not claim to know what is right for the patient, nor does he desire any particular outcome, as the only goal is increased awareness for the patient that leads to more choice.

Gestalt therapy can be used with all patient populations (children, adolescent, adult, geriatric, physically/mentally challenged, prison inmates, inpatient and outpatient psychiatric patients) as well as in a variety of modalities (individual, couples, family, group, and organization). It is applicable for a wide array of problems (such as eating disorders, substance abuse, affective disorders, personality disorders, PTSD, adjustment disorders, loss, and grief). It is an approach that can be used in both long- and short-term therapeutic work. Of course not every therapist is equally effective with all patient populations, modalities, and diagnoses. The experienced and well-trained Gestalt therapist would be aware of personal limitations and areas of expertise and refer those patients who fall outside of these limits to other practitioners, just as a responsible therapist of any orientation would.

IV. EMPIRICAL STUDIES

Research on the effectiveness of Gestalt therapy is scant, and primarily confined to specific aspects of the approach. Most research has been focused on one technique that comes from Gestalt therapy method—the empty chair (or two chair) experiment. It is important to note that use of this or any other single technique does not actually constitute a Gestalt therapy approach, without application of the three philosophical principles described in the treatment section. Although no single technique can be said to represent the essence of the Gestalt therapy approach, a technique has the advantage of being easily defined and thus accessible to the manipulations of empirical research.

The majority of research used the empty chair technique. Subjects were asked to have a dialogue with either a part of themselves, or with someone else relevant to the issues they were grappling with. Most of the studies that used the empty chair technique found it to be more effective than other forms of therapy or control groups. It was also found to be more effective in reducing anger and producing positive attitudes than either

intellectual analysis or emotional discharge. It was more effective than empathic reflection or focusing for creating a greater depth of experience. For resolving “unfinished business,” it was more effective than an attention-placebo condition.

In one study, K.M. Clark and L.S. Greenberg found the empty chair technique to be more effective than either a cognitive decision-making task or a waiting list control group for resolving decisional conflict. During the process of using this technique, the original decision the person had wished to make often unfolded into a deeper related decision.

In summary, studies have shown this technique to result in an increase in affect, depth of experience, and the resolution of related emotional issues. Results have included a decreased sense of decisional conflict, reduced anger, increased positive attitude, lower systolic blood pressure, and the resolution of “unfinished business.”

Two studies found no benefit in using the empty chair technique for resolving grief issues or dealing with mild depression. In a study conducted by N.P. Field and M.J. Horowitz, the intervention consisted of placing subjects in a room alone and asking them to talk to their deceased spouses for 5 minutes through the direction of a taped recording. Nothing like this would ever be done in an actual Gestalt psychotherapy, which requires a focus on moment-to-moment process and the presence of the therapist. This technique was not found to be effective in reducing symptomatology 6 months later. Another study found the empty chair technique to be no more effective than time for decreasing mild depression. The researchers stated that the lack of positive results may have been due to the short duration of treatment, gravitation toward the mean over time, or experimenter bias.

Focused expressive therapy (FEP) was used in several research studies. FEP borrows from Gestalt therapy method and uses such procedures as directed fantasy, two chair dialogues, and awareness exercises. It emphasizes the importance of emotional insight and the magnification of internal experiences, but it also includes a high level of authoritative guidance and confrontation that is inconsistent with a Gestalt therapy approach. FEP was not found to be as effective as either cognitive group therapy or self-directed therapy. However, the description given for self-directed therapy was actually more similar to Gestalt therapy as it is practiced, than the more authoritarian FEP method used to represent Gestalt therapy in this study.

Few studies looked at a more complete Gestalt therapy approach. Most of these yielded positive results

such as an increase in levels of self-actualization, and more positive attitudes toward body image. Gestalt therapy was found to increase internal locus of control and the assumption of personal responsibility in prison inmates. A Gestalt therapy approach resulted in more behavior change than empathic reflection. Gestalt therapy was found to help Vietnam veterans with symptoms of PTSD. In couples therapy it was effective in replacing power struggles with self-definition, limit setting, and intimacy, resulting in greater clarity, acceptance, and understanding.

V. CASE ILLUSTRATION

The following case example will illustrate the treatment process and application of the theoretical concepts that have been presented. The therapist in this case was Stephen Zahm.

Kim, a 44-year-old successful professional woman was referred by her physician due to recurrent periods of depression. She had been depressed off and on for much of her life. The bouts of depression had worsened recently in both duration and severity. She had not been able to tolerate antidepressant medications, and two previous experiences with therapy, both brief, had not yielded lasting improvement.

Kim presented as a smart, attractive, stylishly dressed woman. Her wit and humor were evident in spite of her somewhat depressed affect. Her facility with language, keen observations, and easy manner made it clear why she had achieved success professionally. During the initial session Kim asked perceptive questions about my experience, my therapy orientation, and how I thought therapy could help her. She had been disappointed in her previous therapy experiences. When asked what she hoped to get from therapy she answered "Not just a Band-Aid, I'd like to get to the bottom of what this depression is about."

Kim described herself as "an overeducated over-achiever," who had been successful in school and in her profession. She worked long hours, but wondered what the point of all her hard work was, as she took little enjoyment from her accomplishments. Kim saw her life as lacking in meaning, with little that gave her pleasure. She said she felt "down" a lot, woke up in the morning dreading the day ahead, and said she was just "going through the motions" of social interaction.

Kim described her relationship with her husband Bill as "pleasant enough" but lacking a sense of emotional connection or passion. She reported little inter-

est in sex herself, and stated that their infrequent lovemaking was "more for him." She said "it's like I'm dead inside, or just numb." Kim reported that most of her friends were work acquaintances, and that she had only one "good friend," but didn't really confide in her. Kim and her husband had no children. Kim and I agreed to meet for weekly individual psychotherapy sessions, and to track whether she felt the sessions were useful and whether she was getting what she needed.

In describing her history, Kim reported that her parents had divorced when she was eight. Her father abandoned the family, moving to another state to avoid paying child support. Kim, the oldest of three, became responsible for helping her mother with her younger siblings and doing household chores so that her mother could go back to work to support the family. Kim also became her mother's confidant, and emotional support. She reported that she never really "got to be a kid" after that, and that her mother "never had time" for her. Kim's mother had died about 8 months prior to our first meeting. She minimized her feelings about her mother's death, saying she thought she had "dealt with it."

Kim's therapy themes emerged right away in her relationship with me. In our initial sessions, her fear of showing or revealing vulnerable feelings to me stood out. For example, when Kim talked about her mother's death she would reflexively shut down. I noticed her retroreflections and deflections including choking back tears, changing the topic, and looking away. I pointed these out in an attempt to sharpen this figure, to clarify what was most important to her at that point. I observed that while she had strong feelings about this loss, it was also important to her not to show these feelings or talk about them to me right then.

This process helped Kim focus on her reluctance to open up and share vulnerable feelings. The theme of having a variety of "softer" feelings (sadness, loss, emptiness) and the reluctance to express them to me was something we worked with over the course of the therapy. The essential components involved introjects such as "Be strong" and "Don't show weakness," and the belief that no one would be interested in her feelings.

Within the first few months of therapy, Kim became more aware of these internal mandates and saw how they were connected to her relationship with her mother. Kim had learned not to reveal her feelings and emotional needs, but rather to focus on taking care of her mother and siblings, and deal with any of her needs by herself. Initially it was a big step for Kim to identify

that she felt a need and to also feel her difficulty and discomfort in expressing it to me.

I suggested Kim experiment with looking at me and imagining allowing herself to let down and cry with me. She imagined me having a critical and rejecting response. As she worked with her reluctance over a period of weeks, and felt supported by me in doing only what she was comfortable with, her reluctance moved into the background and her organismic desire and need to experience and express her feelings became more figural. At that point she was able to let down into her feelings of loss and grief, thus beginning the process of getting the closure she needed around her mother's death.

Afterwards, Kim was surprised to discover that this felt OK. It was still difficult for her to ask me how I now felt toward her. Her strong pull was to be satisfied with not knowing how I felt, and what my reaction had been to her crying. I pointed out how not asking me about that left her with a blank space that might then be filled with her own fears. She decided to ask the question "How do you feel about me now?" I was touched by her courage in asking the question and told her so, along with my honest response to her openness. This was a pivotal moment in the therapy as Kim could take in and assimilate my genuine caring for her.

As we did this work and Kim opened up to deeper levels of feeling, another theme became apparent to both of us. Kim became fearful of relying on me, and afraid that I would leave her if she needed me. She had a first class radar system that detected the slightest sign of my lack of interest, lack of energy, or attention wandering. For example, if I looked at the clock she became silent, and withdrew. When I told her of planned vacations her response was to joke that she wondered if I'd want to come back. When we explored this, it became clear that my going away evoked fear that I would abandon her or lose interest in her.

We worked with this theme in a number of ways. As Kim focused on feelings and sensations, she was able to remember particular events with her father, such as his leaving the house in a flurry of loud words and emotion, and yelling things like "I never get any peace in this house!" One time Kim tried holding on to him to keep him from leaving and he pushed her away saying something like "Why can't you kids leave me alone?" The meaning Kim extracted from these experiences and his ultimate abandonment of the family was that it was her fault that her father had left and that she must have been unlovable and "too much" for him.

As we worked with these awarenesses, Kim could feel a little girl part of her that "had always been there" that she tried to ignore. I asked Kim to focus on this sense of herself and to talk to me as the little girl. What emerged from this was that she felt shameful, and desperately wanted to hide or disappear. She went back to her adult perspective and told me she wished that little girl would disappear or at least "grow up." I suggested a dialogue between the adult Kim and the little girl. As the dialogue developed, the adult Kim began to feel sad and realized that rather than wanting the little girl to disappear, she wanted to hold and comfort her. She didn't see her as "unlovable" or "too much," but instead felt compassion for her loss and pain, and was able to tell her so. This newfound ability to experience compassion toward herself was a key in helping Kim integrate her softer "little girl" feelings with her "adult." This occurred over a number of months as she continued to work with these aspects of herself.

When we worked directly with Kim's father she was able to, in fantasy, tell him she was hurt and angry that he hadn't loved her enough to stay in her life even if he had to leave her mother. She finished her tearful dialogue with him by saying "It wasn't my fault you left. You failed me, not the other way around." She also became aware that she had never been able to grieve the loss of her father, that her mother would not tolerate her tears and told her she had to be strong and that crying "wouldn't do any good." At that point she was able to grieve the loss of her dad with me and have more of a sense of closure.

In our sessions Kim came to see how the belief "I'm too much" affected major aspects of her emotional and interpersonal existence. This was especially evident in how she experienced her relationships with men and the type of contact she could have with them. She saw that with her husband, she made no demands, rarely got angry, and focused her attention on his needs to the exclusion of hers. Our work included Kim experimenting with new ways of interacting with her husband such as being more assertive with her needs. Initially this made her anxious. As we worked with the anxiety and she realized the responses she feared were not likely ways that Bill would respond to her, she became less anxious and more excited and playful with the possibilities of being bolder about asking for things she wanted. This affected all aspects of their relationship including their sexual relationship.

A little over a year into the treatment, Kim reported that she "couldn't remember the last time" she had felt depressed. She said she felt better about herself, her re-

relationships, and the possibilities for her life than she ever had. She began to spend less time working and signed up for a beginning ballet class, which was something she had “always wanted to do.” She developed closer relationships with a few women friends, revealing more personal things and accepting support from them.

I asked Kim to reflect on where she was now and where she had been when she entered treatment. Kim reported that she felt more at peace with her parents, even though she still felt sad about her childhood. She said that it had been “life changing” to risk opening up to another person and allowing herself to need and depend on me. Kim saw the connection between her process of shutting down on her feelings—her self-criticalness, rejecting the little girl part of herself, avoiding feeling her anger and grief, and not allowing herself to need anything from others—and the depression she had experienced for so long.

Kim and I agreed that she was ready to terminate therapy and we allowed a month for this process. Given Kim's issues of abandonment and loss, it was important to set an ending date and not dilute the fact that we were ending by meeting less frequently. In this way Kim had sufficient support and a structure for dealing directly with the loss of her relationship with me. We celebrated her gains together, and cried together. At our last session we said goodbye in a complete way that Kim said she had never had the opportunity to do with anyone else.

A. Outcome

Growing up, Kim experienced a lack of awareness of and responsiveness to her emotional needs from both of her parents. Her father abandoned Kim completely, and her mother was unavailable for Kim's needs, requiring Kim to attend to her needs instead. Kim's creative adjustments involved both the awareness stages and the action/expression stages of the figure formation/destruction process. She learned to cut off the experience of certain feelings and to avoid showing and expressing them. The meaning she made of her father's leaving (“I'm unlovable” and “I'm too much”,) and introjects like “Be strong” created her retroflective process of cutting off and alienating aspects of herself, focusing on the needs of others, and not showing or expressing her own feelings and needs. This process resulted in unfinished emotional situations in which she had not been able to get closure. It resulted in the sense of emptiness, lack of meaning and numbness that she

described at the beginning of treatment, as well as in unsatisfying interpersonal relationships that lacked depth. It also contributed to her career success, which was in part based on her skill in attending to the needs of others and her willingness to work hard so that she would not be rejected or abandoned.

All of these issues emerged and were worked in the context of the therapy relationship. As Kim's awareness increased, she was able to work through her fears and reluctance, and to feel the need to express and show her authentic feelings. She came to feel compassion for a part of herself she had previously cut off and wanted to be rid of, and through this experience of compassion she was able to re-identify with and integrate this part of her that included needs and softer feelings. She was able to redirect her self-criticism and see that it was not her being “too much” that caused her father to abandon her and her mother to be unable to attend to her needs. She came to feel that her “little girl” had deserved to be better taken care of.

In Kim's relationship with me she could experience my genuine caring and also see that when I was not there for her, for example when I went on vacation, it was not because she was “unlovable” or “too much.” She learned to express disappointment with my limitations, or anger at me for leaving, in a way that she had never had the opportunity to do with her parents.

The therapy carried over to and influenced every aspect of Kim's life and interactions. Her relationship with her husband deepened, and she began to consider what she wanted to do in her life besides working. However, it was Kim's relationship with herself that changed most dramatically. Kim no longer criticized herself or felt she was weak if she had feelings and needs. She no longer cut off and numbed a major part of who she was. She had greater range of emotional experience and expression. Kim understood that her lifelong depression was the result of ignoring, denying, and cutting off her feelings, which led to an inability to identify and act on her needs. This resulted in a lack of closure on difficult emotional situations as well as unresolved issues of grief and loss.

VI. SUMMARY

The practice of Gestalt therapy is based on the philosophical foundations of field theory, phenomenology, and dialogue. Gestalt therapy is a process-oriented approach that focuses on the person/environment field. The goal in Gestalt therapy is increased awareness, and

change occurs through focused attention on “what is” not by attempting to achieve a particular goal or agenda. As the therapist brings himself or herself to the meeting with the patient, a type of contact that is in itself healing becomes possible. Gestalt therapy is based on a theory of health, and the focus is on how the patient interrupts his natural self-regulation process. The method is experiential and experimental, relying on meaning emerging from experience rather than interpretation. Gestalt therapy has wide applicability with a variety of patient populations, problems, and treatment modalities. Research, while limited, indicates its usefulness for a variety of populations and issues.

See Also the Following Articles

Dialectical Behavior Therapy ■ Existential Psychotherapy
 ■ History of Psychotherapy ■ Humanistic Psychotherapy

Further Reading

- Beisser, A. (1970). The Paradoxical Theory of Change. In J. Fagan, & I. Shepherd (Eds.), *Gestalt therapy now*. Palo Alto, CA: Science and Behavior Books, Inc.
- Breshgold, E. (1989). Resistance in Gestalt therapy: An historical/theoretical perspective. *The Gestalt Journal*, 12.
- Jacobs, L. (1989). Dialogue in Gestalt theory and therapy. *The Gestalt Journal*, 12.
- Kepner, J. (1993). *Body Process*. San Francisco, CA: Jossey-Bass.
- Latner, J. (1988). *The Gestalt therapy book*. Highland, NY: Gestalt Journal Press.
- Polster, E., & Polster, M. (1993). *Gestalt therapy integrated*. New York: Brunner/Mazel.
- Wheeler, G. (1991). *Gestalt reconsidered*. New York: Gardner Press.
- Yontef, G. (1993). *Awareness dialogue and process: Essays on Gestalt therapy*. Highland, NY: Gestalt Journal Press.
- Zinker, J. (1997). *Creative process in Gestalt therapy*. New York: Brunner/Mazel.

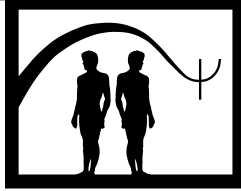

Gifted Youth

Douglas Schave

University of California, Los Angeles

- I. Introduction
 - II. Description of Treatment
 - III. Theoretical Basis
 - IV. Empirical Data
 - V. Summary
- Further Reading

GLOSSARY

assumptive reality The newly acquired ability of early adolescents to detect flaws and errors in adults' thinking.

cognitive conceit Once early adolescents detect a singular flaw in an adult's thinking, they automatically assume that adults are wrong in most other areas of logic.

cognitive disequilibrium During a transition from one cognitive level of another, chaos reigns as the old system is discarded before the new system is fully implemented.

concrete operational thinking Children, ages 6 to 12, view everything from what they see, hear, or experience. They are unable to go beyond the facts or immediacy of their experience.

entitlement An exaggerated feeling, from infancy, that the individual desires special treatment. This covers up the infant's, or is a projection of the parent's own, poor self-esteem.

formal operational thinking The defining quality of early adolescence. Early adolescents gain the ability to build ideas, abstract theories, or concepts without regard to whether they have been previously experienced. Early adolescents now think about the future, what "could be," rather than just the past or present.

imaginary audience The belief early adolescents have that everyone is as preoccupied with their thoughts, behaviors,

and feelings as they are. This dynamic causes them to feel judged as defective and, hence, shamed in front of others.

narcissist, hypervigilant Hypervigilant to the slightest rejection, yearn to connect, extremely shy and inhibited, shun attention, yet a hidden omnipotence, underlying sense of defectiveness and shame, responds to an empathic approach in therapy.

narcissist, oblivious The classical narcissist, oblivious to the reactions of others, arrogant and aggressive, self-absorbed and seeks attention, impervious to hurt feelings of others, a more confrontational approach works better in therapy.

personal fable Exaggerated sense of self that allows early adolescents to believe that their parents could never have experienced feelings or thoughts the same way they do.

psychic structure An unconscious mental function that allows an individual to interact with the world. When the system does not function well, the person is not able to smoothly modulate feelings and interactions with the world.

right brain The earliest, non-verbal part of the brain, the amygdala, in particular. Includes the old limbic system. It is active at birth. Functions include: facial recognition, response to vocalization, and the startle response, that is, the autonomic nervous system.

I. INTRODUCTION

Early adolescence, ages 12 to 14, is one of the most creative and yet, most challenging times of one's life. A cognitive shift into abstract thinking, starting around 11 or 12, stimulates a disequilibrium that creates an

internal chaos characterized by an extreme egocentrism, as well as intense affect states. This internal chaos often causes early adolescents, especially males, to emotionally disconnect from their feelings by disavowal, dissociation, denial, or acting out.

This article focuses on a select group of early adolescents, the exceptionally gifted, who typically have I.Q.'s of 140 or higher. In later years, they often score 700, or more, in each of the SAT subsets.

I first summarize several cases that illustrate the issues that I frequently encounter with this age group. I then present an overview of my psychoanalytic approach to working with this most fascinating group of young teenagers. Following a section on Empirical Data, I conclude with a summary of my work, with this group of highly gifted youths. Understanding the characteristics, dynamics, and psychotherapeutic approach of this highly gifted group has helped my work with the overall population of early adolescents.

II. DESCRIPTION OF TREATMENT

Early adolescence is perhaps the most creative, yet volatile time of one's life. With the intense disequilibrium stimulated by not only the cognitive changes, but physical, hormonal, sexual, and social changes, early adolescents feel out of control; feeling out of control precipitates struggles with affect and self-esteem regulation. This, in turn, stimulates early adolescents disconnecting, emotionally, to avoid feelings of defectiveness, shame, as well as a rage from being chronically misunderstood. An additional component of this internal chaos is the struggle early adolescents have, especially gifted ones, with fitting into their family system. Extremely sensitive to the internal life of their parents, gifted early adolescents struggle with the inability of their parents to come to terms with struggles in their own lives. Because of these conflicts, gifted early adolescents live in a state of suppressed, or often not so suppressed, rage, as they struggle to find a niche within their family and society.

Although I occasionally have a gifted teenager who openly talks to me and shares emotional struggles, most, especially males, refuse to share intimate details of their lives. Feeling totally vulnerable and wondering whether I, too, will force them to continue to accept the fallacies they see in their lives, walking into my office is a "life and death struggle." With this state of mind, my therapeutic goal with early adolescents is quite simple—to help them and their families get through early adolescence with the minimal amount of emotional and physical damage.

I often work with early adolescents identified as, "lazy." Often, these individuals are actually exceptionally gifted adolescents who are totally overwhelmed. They struggle with intense perfectionism, a terror of failure, a rage over chronic misattunements, as well as feeling responsible for everything. These youths are hypervigilant narcissists, who yearn to connect with their parents. As they are not overwhelmed by intense rage, or shame as oblivious narcissists are, and have not given up their connection to adults, they are more responsive to "talk" therapy, than oblivious narcissists. Such was the case with my first female adolescent, a 13 year old, who presented with behavioral problems at home and academic problems at school. She was barely achieving "C's," at her prestigious high school. Early in therapy, she said,

If I try harder and get an "A" on a test, then someone who used to get an "A" will get a "B," then someone who used to get a "B" will get a "C," then someone who used to get a "C" will get a "D," then someone who used to get a "D" will get a "F" and then someone who used to get a "F" will get kicked out of school, and it will all be my fault!

Working through her perfectionism, fear of failing, as well as her feeling responsible for everything that happened around her, she began to work harder. Unfortunately, a teacher did not acknowledge her increased effort, which devastated her. Later, she connected with an English teacher who recognized her increased efforts. Although she became a honor student, she continued to struggle with a series of disappointments due to her perfectionism.

Many early adolescents begin psychotherapy already battling their parents over communication. Not wanting to recreate these power struggles, I have successfully treated numerous teenagers nonverbally. One example is a 14-year-old male, I treated by playing double solitaire. The "golden boy" in elementary school and a straight "A" student in junior high school, his arrogance, in 9th grade, alienated his classmates. One day a row of gym lockers "mysteriously" fell over on top of him. He stopped attending high school, his grades dropped, and he became combative at home. During our first meeting, with his parents present, he refused to talk, answering everyone of my questions with, "Everything is fine!" Refusing to talk, double solitaire became a non-threatening form of interaction. Initially playing hesitantly and noncompetitively, I matched his playing skill, allowing him to win. These wins gave him a renewed sense of being in control. Playing cards also

helped him to become more assertive, while slowly delinking his assertiveness from his aggressiveness, which he experienced as destructive.

As most early adolescents respond better to actions than to words, I fed him, gave him presents for his birthday, took him for walks, and joked around with him. Over time, as he became less perfectionistic, he became increasingly competitive. The more he relished beating me, the more comfortable he became with his intense feelings, including his rage. As he gained greater confidence, he slowly returned to doing well academically. In addition, his relationships with his peers and family improved. As family sessions, early in therapy, were too volatile, his parents were seen separately. I helped his parents to acknowledge and to support his unique talents and future dreams. After 18 months of twice a week psychotherapy, one day he announced that, "Everything was fine," and quit. Unexpectedly, two years later, he returned to therapy. During his last semester of high school, he talked, nonstop, openly dealing with sensitive issues that he had desperately fought to avoid talking about during our earlier work.

Early adolescents, whom I view as oblivious narcissists, are even less able to self-regulate their feelings, due to their intense rage toward and disconnection from their parents. This was evident in one of my highly gifted 13-year-old males, who, by junior high school, was already involved with drugs, including cocaine. He arrived, with his devoted parents, for his first session, wearing Birkenstocks, a t-shirt with very provocative lettering, shorts, and a mohawk haircut. He was noncommunicative, other than to express, "There's nothing wrong with me!" "I'm fine!"

Working out of my house, he noticed my dog, a very friendly, 65-pound Samoyed. Surprisingly, he asked me, very politely, if my dog, Bushski, could come into our sessions. Although totally disconnected, emotionally, from adults, he could not resist Bushski giving him his total, undivided attention. Slowly, with the help of Bushski, Prozac, and our work together, he slowly emerged from his depression. However, unable to view his chronic drug usage as destructive, this issue remained "off limits." Immediately on graduating from high school, he terminated, as he knew that his father would not force him to continue. Although doing well in college, his poor self-esteem, unresolved rage, and use of drugs left him emotionally vulnerable to setbacks.

A frequent problem I encounter, especially with brilliant early adolescents, is "school phobia." Many of these early adolescents are also hypervigilant narcissists. They are more worried about leaving their mothers, than a fear of being at school. Most have, from a

very early age, assumed responsibility for their mother's emotional well-being. In addition, they have difficulties regulating their affects, which makes being away from their mothers difficult. For example, one 13-year-old female had to be forcefully removed from her mother's care for 6 months. Immediately after leaving her daughter, the mother would call me for support of "what she had just done to her daughter." Her daughter also slept in her parents' bedroom at night, as she needed her mother's physical presence to emotionally soothe herself. A combination of talking with this gifted early adolescent, Prozac, and playing double solitaire, competitively, helped this teenager to feel more comfortable with her feelings. Slowly, she gave up feeling responsible for her mother's emotional needs and learned that her anger, at her mother, would not cause her mother harm. Weekly family sessions helped both parents to allow their daughter to express more intense feelings and to facilitate her individuation.

III. THEORETICAL BASIS

A. Cognitive Changes in Early Adolescence

There is a dramatic shift in cognitive functioning from the "here and now" concrete operational thinking of latency to the "future oriented" formal operational thinking of early adolescence. As a result, early adolescents, even more so brilliant ones, are confronted with a developmental milestone in cognitive functioning that is very similar to the toddler. They must grapple with the excitement of being exposed to a rapidly expanding world of information and ideas, while also struggling with the terror of becoming insignificant and lost in the sudden and massive expansion of their universe.

This cognitive shift stimulates a tremendous creative spurt, as well as a massive disequilibrium. This disequilibrium is further intensified by the physical, hormonal, sexual, and social changes that bombard them. Under such an assault, early adolescents are suddenly unable to easily assimilate the massive influx of information that is pouring in around them. This creates a "softening" of their psychic structure, that is, issues having an emotional component, even if a minor one, create massive changes in how they react or accommodate to a situation. As a result, this "softening" of the psychic structure of early adolescents, particularly gifted ones, often disrupts their maintaining a solid sense of self. This "softening" intensifies their reliance on external sources to maintain a sense of well-being. Unfortunately, with early

adolescents struggling for increased freedom from their parents, early adolescents often reach outside the family, toward peers, for their primary emotional support.

In addition, the resulting volatility of early adolescents manifests itself in a dialectic of creative expansiveness, moodiness, impulsiveness, self-centeredness, and a terror or intolerance for things that are different. This volatility causes self-esteem problems, which again draws early adolescents even closer to their peers who are also drowning in their own shame. Often, they hide their struggles, rage, and depression through the use of drugs, as well as antiauthority and sexual activities.

B. Characteristics of Early Adolescents

Characteristics that are stimulated by the cognitive shift, in early adolescence, include the “imaginary audience,” where they feel that others are always watching and judging them; the “personal fable,” in which they feel that no adult has ever emotionally experienced anything like they’ve experienced before; “assumptive reality,” where they realize that they now know more than their parents; and “cognitive conceit,” where they now believe that because they know more than adults in one area, adults are dumb. This combination, along with brilliant early adolescents’ struggling with either pleasing their parents or openly challenging the pathological “family illusions,” leaves early adolescents feeling emotionally vulnerable and isolated from their parents. In turn, this vulnerability stimulates much of the early adolescent’s egocentrism, narcissism, and volatile moods and behaviors. As a consequence, many early adolescents, especially gifted early adolescents, use a heightened sense of entitlement, as well as omnipotence to protect themselves from feeling so vulnerable, especially from counterattacks by their overwhelmed parents.

C. The Infant Morality System

While early adolescence can be an exceptionally fascinating and creative time, it is also a very difficult time. This is particularly true for gifted teenagers. The more brilliant they are as toddlers, the earlier they begin to judge their world. Hence, the more primitive their judgments are. This intense primitiveness creates an inner world that is very “black and white,” “all or nothing,” perfectionistic, rigid, cruel, unrelenting, and unforgiving. Trying to make sense of the bewildering world around them, infants also take responsibility for every-

thing that happens around them. This system, which I refer to as the infant morality system (IMS), occurs by 3 years of age. Soon thereafter, these now brilliant children must also struggle with the illusions within their family system. Hypervigilant narcissists, who are hypersensitive to the slightest emotional withdrawal by their parents, must often give up many of their own feelings and perceptions to remain connected. Those who become oblivious narcissists are devastated by intense chronic misattunements. Their protective rage against their parents often prevents them from experiencing intimate connections later in life.

Years later, when the dynamics of “the infant morality system” are added to the early adolescent’s cognitive disequilibrium, life becomes overwhelming. Internally, gifted early adolescents are further overwhelmed by an even greater intensity of perfectionism, criticalness, and rigidity, as well as intense struggles with defectiveness and shame. Externally, they struggle with whether to accept what they see as the hypocrisy of the parental system, or to fight it. These conflicts often devastate parents, as they experience their early adolescents explosively projecting all of their struggles onto the rest of the world.

D. Protective Mechanisms

Terrified of their own emotional regression, feeling defective, overwhelmed by shame, and struggling with a blind rage, early adolescents often protect themselves by emotionally regressing to earlier protective mechanisms including: disavowal, dissociation, and denial. This disconnection helps foster the volatility and rigid nature of the regulatory systems of this age group.

E. Affect and Self-Esteem Regulation

As the cognitive disequilibrium intensifies, affect regulation becomes tenuous. The “softening” of their psychic structure makes it difficult for early adolescents to modulate intense feelings, whether positive or negative. Constantly feeling overstimulated, early adolescents struggle to “hold on to” whatever unconscious sense they have, from infancy, that “Everything will be okay.” This intense unsettledness leaves early adolescents at the mercy of external sources to help them modulate their feelings. Once again, fighting for independence, early adolescents frequently shut out their parents. The result is that an important external source for the maintenance, repair, and integration of the self is unavailable, at a time of greatest need. This leaves

early adolescents depending almost exclusively on their peers to help them to modulate their feelings. Unfortunately, their peers are just as destabilized, as they endure the same stress and struggles.

The same cognitive disequilibrium also creates a tenuousness in their self-esteem regulatory system. Continually struggling with perfectionism, feeling defective, drowning in shame, as well as flooded with rage, brilliant young teenagers tend to hear and react mostly to negative comments. Fearful of being attacked, creative ideas, exciting events, or anything that feels vulnerable to criticism is hidden from their parents. Once again, the ensuing vulnerability creates an intense need for external supports. As with affect self-regulation, young teenagers, in particular brilliant ones, gravitate toward their peers. These peers are often breaking away from parental authority, through drug usage, delinquency, and sexual acting out.

F. Consolidation of Formal Operational Thinking

A major milestone signifying that early adolescence has ended is the lessening of their internal chaos. This lessening of the internal chaos is due to the consolidation of formal operational thinking, as well as to the diminishing of their physical growth spurts, surging hormones, changes from sexual maturation, and social changes at school.

As a result, the psychic structure of midadolescents once more becomes "solid." With this consolidation, midadolescents have a growing ability to self-reflect; they can think before they act. This calmness, facilitated by a diminishing of their rage, allows for more stable affect and self-esteem regulatory systems. Consequently, mature adolescents can deal with more emotionally complex issues, with far less internal chaos and disruption of their psychic structure. Teenagers who are still experiencing difficulties at home, with peers, or in school, by 11th grade, are still lost in the ongoing struggles of early adolescence. Without a "solid" psychic structure, they are at risk for failure in their impending entrance into the "adult world."

IV. EMPIRICAL DATA

The few studies that deal with the value of psychoanalytic psychotherapy often show that different theoretical orientations have similar results. Thus, it is the interactions between the patient and therapist and not

one's orientation that facilitates meaningful psychic change. My focus, for years, has been an intersubjective model, which focuses on the importance of the dyadic interaction. This interest in dyadic interactions has also led me to study the right brain (the old limbic system), where affects, vocal timing, and facial recognition are part of an early, unconscious, action-oriented process. The closer we can recreate these nonverbal right brain interactions between mother and infant in our work, the deeper and more meaningful the psychic changes will be in our patients. This has particular relevance when working with gifted early adolescents. As most early adolescents, in treatment, are depressed, of equal importance is the use of SSRIs. Studies show the value of combining psychotherapy, with medication, to prevent a relapse of their depression.

V. SUMMARY

In summary, early adolescence, is a time of great excitement, enormous creativity, as well as tremendous volatility. The leap into formal operational thinking creates a disequilibrium that overwhelms early adolescents, especially gifted ones. The ensuing chaos stimulates not only a creativity, often unsurpassed in one's life, but also an emotional volatility and regression. This volatility creates a "softening" of their psychic structure, which leaves the well-being of early adolescents susceptible to external sources, including parents and peers. However, this "softening" also presents an important opportunity for "correcting" past negative unconscious expectations. Healthier interactions, whether by peers, parents, therapists, teachers, or others, allow for the layering of new unconscious patterns about relationships and the world. This potential for layering new expectations is even more crucial for gifted youths, as they tend to be so negativistic about their world. This negativity is not only due to their perfectionism and criticalness, but also to their struggle of whether they adapt to, or reject, the family illusions.

Psychotherapy with this age group is often extremely difficult, especially with gifted early adolescents. They experience overwhelming stress over perfectionism and a fear of failure. In addition, their sense of defectiveness, overwhelming shame, and intense rage causes even the most brilliant youths to use their incredible intellectual talents to avoid their inner chaos and feelings, through disavowal, dissociation, denial, or through acting out.

Working with families is crucial, as the therapist of adolescents must recognize the impact of their validating their patient's perceptions and feelings

about their family, friends, and even themselves. Although needing to support their patients, premature unleashing of their hurt and rage, from chronic misattunements by their parents, can leave long-lasting emotional scars.

The consolidation of formal operational thinking coincides with the lessening of the physical, hormonal, sexual, and social changes. With the lessening of their rage contributing to a calmer internal world, midadolescents now have a more solid psychic structure, which facilitates their exciting adventure into the world outside their family.

See Also the Following Articles

Child and Adolescent Psychotherapy: Psychoanalytic Principles ■ Parent–Child Interaction Therapy

Further Reading

- Beebe, B., & Lachmann, F. (1994). Representation and internalization in infancy: Three principles of salience. *Psychoanalytic Psychology, 11*, 127–165.
- Davies, Jody Messler. (1999). Getting cold feet, defining “safe-enough” borders: Dissociation, multiplicity, and integration in the analyst’s experience. *Psychoanalytic Quarterly, 68*, 184–208.
- Gabbard, Glen O. (1989). Two subtypes of narcissistic personality Disorder. *Bulletin of the Menninger Clinic, 53*(6), 527–532.
- Lyons-Ruth, Karlen. (1998). Implicit relational knowing: Its role in development and psychoanalytic treatment process of change study group, Boston, Massachusetts. *Infant Mental Health Journal, 19*(3), 282–289.
- Reckling, Anne, & Buirski, Peter (1996). Child abuse, self-development, and affect regulation. *Psychoanalytic Psychology, 13*(1), 81–99.
- Renik, Owen. (1999). Playing one’s cards face up in analysis: An approach to the problem of self-disclosure. *Psychoanalytic Quarterly, 68*, 521–539.
- Schave, Douglas, & Schave, Barbara. (1989). *Early adolescence and the search for self: A developmental perspective*. New York: Praeger.
- Schore, Allan. (in press) Clinical implications of a psychoneurobiological model of projective identification,” In S. Alhanati (Ed.), *Primitive Mental States: Pre- and Perinatal Influences on Personality Development* (Vol. III). London: Karnac Books.
- Stern, Daniel N., Sander, Louis W., Nahum, Jeremy P., Harrison, Alexander M., Lyons-Ruth, Karlen, Morgan, Alec C., Bruschiweiler-Stern, Nadia, & Tronick, Edward Z. (1998). Non-interpretive mechanisms in psychoanalytic therapy: The “Something More” than interpretation. *International Journal of Psycho-Analysis, 79*, 903–921.
- Ulman, Richard, B., & Brothers, Doris. (1988). *The shattered self: A psychoanalytic study of trauma*. Hillsdale, NJ: Analytic Press.

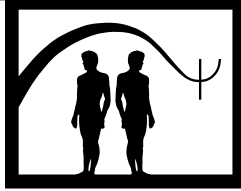

Good Behavior Game

Daniel H. Tingstrom

The University of Southern Mississippi

- I. Description of Treatment
- II. Theoretical Bases
- III. Empirical Studies
- IV. Summary
- Further Reading

procedure rather than extraneous factors by comparing performance under different conditions applied to the same individual or group of individuals over time.

GLOSSARY

ABAB design A type of single-case design that evaluates the effects of intervention through the repeated alternation of baseline (A) and intervention (B) phases.

differential reinforcement of low rates of behavior A schedule of reinforcement in which individuals receive reinforcement if their behavior or responses during a particular time period are kept below or equal to some specified criterion level.

group-oriented contingency A contingency in which some behavior is required of a group of individuals and the presentation, or loss, of a reinforcer is based (i.e., contingent) on the performance of a subset of or the entire group.

interdependent group-oriented contingency A group-oriented contingency, such as the Good Behavior Game, that requires some collective level of group behavior or performance in order for the group to receive reinforcement.

internal validity The extent to which the results of an experiment can be attributed to the independent variable or treatment only.

multiple baseline design A type of single-case design in which intervention is introduced sequentially across different individuals or groups, behaviors, or settings at different points in time.

single-case experimental design A methodology used to make inferences that an observed change in behavior is causally related to the implementation of an intervention

The Good Behavior Game (GBG) is a type of interdependent group-oriented contingency management procedure used primarily for behavior management in classrooms and school-related settings. This article describes the game's components, theoretical underpinnings, as well as the variety of adaptations and applications that have been used since its inception.

I. DESCRIPTION OF TREATMENT

As initially reported in 1969 by Harriet H. Barrish, Muriel Saunders, and Montrose M. Wolf in their seminal article in the *Journal of Applied Behavior Analysis*, the GBG is a group-oriented contingency management procedure that has been used primarily to control the disruptive behavior of students in classrooms and other academic settings. In its original and most basic form the GBG includes only a few integral components that have been used with various modifications in numerous empirical investigations since its initial introduction.

In the game, the class is divided into two or more teams, and team names are posted on the blackboard. Target behaviors (rules) are established and defined that must be followed (or existing classroom rules may be

used). The teacher places marks on the blackboard under a team name whenever a child on that team violates one of the rules. At the end of a period of time (e.g., end of class period, morning, afternoon, end of day) the team with the fewest marks wins the game and receives an agreed on reward(s) (e.g., extra free time, special privileges, victory tags, etc.). Further, any and all teams can “win” if they keep below a preestablished criterion number of marks.

In Barrish, Saunders, and Wolf’s original study, a fourth-grade class was divided into two teams. The class was informed that they would play a game in which team members would earn marks (placed on the blackboard) against their team for talking out or being out-of-seat. The team with the fewest marks, or both teams if neither team received more than five marks, would win the game and receive special privileges (e.g., wearing victory tags, stars on a winner’s chart, lining up first for lunch, 30 min. of free time at end of the day). The game reduced talking and out-of-seat behavior and was popular with students and school officials. Systematic analysis of the game’s major components by others have found that the effective components include dividing the class into teams, setting criteria for winning, and reinforcement for the winning team.

Although most applications of the GBG have been for the management of disruptive classroom behavior and typically teams must avoid the accumulation of points, another variation has also been used effectively in which teams earn points for appropriate, prosocial behaviors. The game has also been used successfully for academic behaviors such as assignment and work completion, active participation, attention to task, and even written expression. In addition to daily rewards, weekly rewards are also frequently used. The game can be designed to be as simple (i.e., following the above-minimum components only), or as complex as desired. The simpler and more basic the game is kept, the better. Otherwise, teacher monitoring and implementation become overly cumbersome and unwieldy, thus defeating the purposes and attendant advantages of the game. At least two teams are needed to capitalize on team competition, although more than three teams can result in monitoring difficulties.

II. THEORETICAL BASES

A. Differential Reinforcement of Low Rates

The GBG is based on a particular schedule of reinforcement referred to as differential reinforcement of low rates (DRL). In such an arrangement the group or

team receives reinforcement if their behavior or responses during a particular time period are kept below or equal to some specified criterion level. Because the GBG is a type of interdependent group-oriented contingency, it also utilizes features of group competition and conformity (discussed further later).

B. Group-Oriented Contingencies

Group-oriented contingencies have been classified into three types: (1) independent, (2) dependent, and (3) interdependent. Independent group-oriented contingencies require the same response requirements from all members of the group, but access to reinforcement for each individual is based solely on that member’s own behavior (e.g., “whoever turns in a rough draft of their project by Friday morning can have extra free time Friday afternoon”). Dependent group-oriented contingencies make the group’s access to reinforcement dependent on the performance of a selected individual or individuals (“On Friday morning’s spelling quiz, if Erin and Andrew can improve their spelling grade by 10% above their scores from last week, we’ll all have extra recess time Friday afternoon”). Interdependent group-oriented contingencies, such as the GBG, require some collective level of group behavior or performance in order for the group to receive reinforcement (“If the class average is 80% or higher on our spelling quiz, we’ll all have extra recess time Friday afternoon”). In this latter arrangement, although some individual students may not meet the criterion, all students are reinforced as long as the group meets the criterion.

Contingencies that are applied individually in classrooms to manage disruptive and/or appropriate behavior can be impractical for teachers and generally difficult to manage. Group-oriented contingencies on the other hand, particularly the interdependent variety like the GBG, have several advantages in that they tend to be easier to manage, more efficient, and require less teacher time because individual contingencies do not need to be monitored; less time is required when the same reinforcer is used with all students. In addition, group-oriented contingencies avoid common concerns of teachers that a particular student will be singled out and treated differently. They may also increase prosocial and cooperative behaviors among students. Group-oriented contingencies have been found to be at least as effective as individual contingencies, if not more so.

The GBG also capitalizes on team competition and issues related to group conformity and peer influence. The peer group is essentially used to assist in managing behavior. Quite typically, attention from one’s peers often works against the classroom teacher by reinforcing and

maintaining disruptive behavior. However, in interdependent group-oriented contingencies like the GBG, students either withhold their social attention (e.g., laughs, snickers, smiles) for disruptive behavior by peers, or substitute disapproval for this social attention.

Although the peer influence that operates in the GBG can be an advantage, researchers have also noted potential disadvantages of this influence. Some, for example, have cautioned that this peer influence can become undue peer pressure verging on harassment toward the individual(s) who may not be capable of performing the necessary behavior. Students may complain about a lack of fairness of the system when others cause the loss of privileges or rewards and may direct their frustrations (which can escalate into aggression) at the offending student(s). Direct proactive measures taken in one study by the teacher to guard against potential excessive group pressure consisted of her warning that such pressure toward an offending student would not be tolerated and would result in a meeting with the teacher for corrective action.

Finally, some children may find it reinforcing to “sabotage” a program or refuse to conform to the classroom rules, thus continually causing the group or team to lose rewards as found in several studies. In such instances the offending student may be temporarily or permanently dropped from the game, their points not counted against a team, or a separate team may be formed with those offenders so as to not penalize other team members. Some investigators have used a combination of individual and group-oriented contingencies, which others have suggested may ultimately be optimal, to overcome this potential problem of sabotage. Others suggest the randomization of components (reinforcers, target behaviors and criteria, contingency, and students) in interdependent group-oriented contingencies like the GBG to overcome many of these problems associated with undue peer pressure and sabotage.

III. EMPIRICAL STUDIES

Empirical investigations of the GBG have found it effective in its original form and in a number of modifications and adaptations in a variety of settings for numerous target behaviors (both academic and social) and age groups.

A. Single-Case Experimental Designs

Researchers have typically employed some type of single-case experimental design methodology in evalu-

ating the effects of the GBG. Single-case designs derive their power to rule out alternative explanations of treatment effects (i.e., internal validity) by comparing performance under different conditions applied to the same individual or group of individuals (as in the GBG) over time. In most investigations of the GBG, performance or behavioral data from the group or class is aggregated and evaluated as would be done with data from a single individual.

The most commonly employed single-case experimental designs in studies of the GBG have been either one of the types of phase change designs (e.g., ABAB, etc.), the multiple baseline design, or combinations of the two. In an ABAB design, the first A phase usually consists of baseline observations and measurements prior to implementation of the intervention (e.g., the GBG). The first B phase usually comprises the implementation of the game. After observing the effects of the game on the teams' or class' behavior (e.g., a reduction of disruptive behavior) for a period of time, it is withdrawn during the second A phase (i.e., second “baseline”). Finally, the game is reintroduced in the second B phase. When the teams' behavior changes reliably and in predictable directions during this sequence of phases, it can then be concluded that the game accounts for these effects. A multiple baseline design begins with baseline observations collected on two or more classes, settings (e.g., math versus reading instruction), or behaviors at the same time. The game is then introduced at different points in time across the groups, settings, or behaviors. If the game produces beneficial results on behavior when and only when it is introduced, it can be concluded that the game only is responsible for the change rather than other alternative factors. A few studies also gradually have made the criterion number of points allowable more stringent during treatment phase(s). All the studies that have manipulated the criterion number of points have found that teams adjusted their behavior to coincide with the changing number of allowable points.

B. Target Behaviors

Most applications of the GBG have targeted primarily disruptive forms of behavior such as talking, being out-of-seat, name calling, cursing, and verbal/physical aggression. In these studies teams usually must avoid the accumulation of points.

Some researchers have expressed concerns regarding the GBG's overemphasis on disruptive behavior and negatively stated rules. To address these concerns, for example, one study allowed merits to be earned for work completion and active class participation that would

negate some of the already earned negative marks against second-grade teams. In another study, other investigators stated rules positively and included student input into rule formation for fourth graders. Other modifications in which teams have earned points for appropriate, prosocial behaviors have likewise found the game effective. One investigation used The Principal Game in which teams in a disruptive fourth-grade class earned points and teacher praise for being on-task, and the winning team(s) was visited and praised by the principal. The game was somewhat more effective than individual contingencies in increasing on-task behavior. Another study implemented the Astronaut Game in which first graders were divided into astronaut teams and earned tokens for completed seatwork and good astronaut behavior. The game was successful in decreasing inattentiveness in a target student and increasing completed seatwork for the class. In the first application of the GBG with preschoolers, researchers increased compliance using only positive procedures (accumulation of smiley faces or dinosaurs, prizes, praise). Teams consisted of two-member pairs only; noncompliance was ignored. The game was successful in increasing compliance in both pairs of preschoolers. In a unique application of the GBG in a physical education class, the GBG was successful in reducing inappropriate social behaviors and increasing appropriate social behaviors but was not successful in appreciably affecting the quality of fourth-, fifth-, and sixth-graders' volleyball skills.

Probably one of the unique applications of the game targeting non-school-related behavior was the Good Toothbrushing Game in which the oral hygiene skills of first- and second graders were targeted. Two teams were formed in each class, and the object of the game was to be the team with the cleanest teeth. Four children from each team were randomly selected each day, and the team with the lowest score on an oral hygiene index won. The winning team had their names posted on a winners' poster and received a "scratch n' sniff" sticker. Children were also praised for low scores and received feedback regarding areas of their teeth not brushed well. The game was effective in improving students' hygiene scores.

A "no tattling" rule was added in one study to overcome problems of students raising their hands to tell the teacher of students breaking rules. In addition to talking, out-of-seat, and following directions, another group of researchers also targeted tattling as well as "bothering one's neighbor" with their second-grade participants.

Another series of studies found first graders who participated in the GBG were rated lower in aggression

and shyness by their teachers at the end of the year compared to their beginning-of-year ratings. These researchers later reported that the first-grade males who were initially rated high in aggression at the beginning of first grade, and who participated in the GBG throughout first and second grades, had lower teacher ratings of aggression in fourth and fifth grades, and into middle school. Thus, the GBG may serve a preventive function for aggressive young boys.

In addition to its applications with social behaviors, the game has also been used successfully with academic behaviors. One study that included a merit component in the GBG, in which teams could have negative marks erased for merits earned for assignment completion and for active class participation, produced increased rates of completed math assignments with 75% accuracy for the entire class, and even more so for two target children with histories of behavioral difficulties. First-grade students in another study showed an increase in work completion as a result of the game. Other researchers employed the Good Writing Game, a modification of the GBG in which fourth-, fifth-, and sixth graders attending a nonremedial summer school session earned points for usage of various parts of speech in written stories. The game resulted in an increase in compositional variables as well as ratings of creativity of written stories. Finally, although not a direct target of the GBG, another study found slight increases in math accuracy in fifth-grade participants.

C. Participants

Participants in a majority of the studies conducted with the GBG have consisted primarily of elementary-age students (first through sixth grades). Also, although not always specified, most studies have been conducted either with regular education students or students who have had some history of behavior management difficulties. Only a few investigations of the GBG have been conducted with students with disabilities. One study employed a modified version of the game to effectively reduce class levels of disruptive behavior with 6- to 10-year-old students with mild mental retardation. Another study that combined self-management and peer-monitoring procedures in a variation of the GBG successfully reduced uncontrolled verbalizations in third-grade students with Attention Deficit Hyperactivity Disorder. Researchers have also individualized the GBG across types and frequencies of a variety of inappropriate behaviors for three classes of 15- to 17-year-old students with emotional disturbance. The individualized GBG was success-

ful in decreasing inappropriate behaviors for these adolescents. Two studies successfully used the game with a wide age range of students with disabilities, from 9 to 20 years of age and from 12 to 23 years of age.

The youngest students with whom the GBG has been used thus far has been preschoolers. The researchers increased compliance in two pairs of preschoolers using only positive procedures. The GBG has also been used in a hospital setting with adults. In this study, the Good Productivity Game was used with four hospital residents who were trainees at a rehabilitation industry to increase their work output for a task for which they were paid a wage.

Last, the only cross-cultural application of the GBG used the game with Sudanese second graders. The game, patterned very closely after the original version, was successful in reducing talking and out-of-seat behavior, as well as aggression.

D. Reinforcers

One advantage of the GBG is that teachers can use those reinforcers that naturally exist in most elementary classrooms. For example, a common group of reinforcers used in many studies has been some form of free time, extra recess, or activity time. Other rather commonly available reinforcers also used have included various edible treats (e.g., candy, cookies, etc.). Still other privileges available that have been used consist of lining up first for lunch, public posting of results, going to library, helping the teacher, reading, playing games, working on special projects, viewing film strips, listening to records, serving as a tutor, and going outside to talk or read.

Unique and less commonly used rewards have consisted of leaving school 10 min. early at the end of the day, a special visit from the school principal, early work termination, a party and pencils, a weekly commendation letter or a positive note to a dorm counselor, or lunch with a staff member. Even many of these less commonly used reinforcers are often available or could be available in many or most classroom settings with a bit of planning and forethought.

E. Consumer Acceptance

In studies that have reported consumer (i.e., students, parents, teachers) attitudes and reactions to the GBG, most reports suggest that the GBG has been generally found to be popular and acceptable. The very first investigation of the procedure reported that the GBG was popular with teachers and school officials. Sudanese stu-

dents, teachers, parents, and the principal were pleased with the game in the one cross-cultural investigation of the game. Other studies have likewise reported that the game was acceptable or even highly acceptable to participating students and teachers. One study that used a variation of the GBG but without team formation or immediate feedback to students on rule violations reported that students and teachers preferred the individual contingency compared to the interdependent group-oriented contingency (modified GBG). In general, it appears that the GBG is usually popular and acceptable with students and teachers. For students it can be exciting (group solidarity and cooperation) and provides reinforcers for work and self-control that may not have been present previously; for teachers, in addition to its demonstrated effectiveness, the GBG can be an efficient, easy to manage, time-saving procedure. Finally, an additional feature of the GBG that may contribute to its utility and popularity is that at least one study has reported that the game did not require rigorous compliance to be effective. These researchers concluded that the system may be robust enough such that complete adherence is not necessary to achieve meaningful behavior change.

IV. SUMMARY

The GBG is a form of interdependent group-oriented contingency management procedure that is used for the management of behavior primarily in classrooms and other academic settings. The game is designed to be time efficient and easy to manage for teachers and is usually used with an entire classroom in which two or more teams are formed, criteria are set for winning the game, and reinforcement is provided to the winning team. It capitalizes on team competition and peer influence in that the peer group assists in managing behavior, although some care must be taken to ensure that this peer pressure does not become excessive. The GBG is usually popular with students and teachers and has wide applicability and versatility; its efficacy has been demonstrated with many social and academic behaviors in a variety of settings with a number of modifications and adaptations for many age groups.

See Also the Following Articles

Behavioral Contracting ■ Contingency Management ■ Home-Based Reinforcement ■ Negative Reinforcement ■ Positive Reinforcement ■ Punishment ■ Time-Out ■ Token Economy

Further Reading

- Alberto, P. A., & Troutman, A. C. (1999). *Applied behavior analysis for teachers* (5th ed.). Upper Saddle River, NJ: Prentice Hall.
- Barrish, H. H., Saunders, M., & Wolf, M. W. (1969). Good behavior game: Effects of individual contingencies for group consequences on disruptive behavior in a classroom. *Journal of Applied Behavior Analysis*, 2, 119–124.
- Cooper, J. O., Heron, T. E., & Heward, W. L. (1987). *Applied behavior analysis*. Upper Saddle River, NJ: Prentice Hall.
- Harris, V. W., & Sherman, J. A. (1973). Use and analysis of the “good behavior game” to reduce disruptive classroom behavior. *Journal of Applied Behavior Analysis*, 6, 405–417.
- Hayes, L. A. (1976). The use of group contingencies for behavioral control: A review. *Psychological Bulletin*, 83, 628–648.
- Litow, L., & Pumroy, D. K. (1975). A brief review of classroom group-oriented contingencies. *Journal of Applied Behavior Analysis*, 8, 341–347.
- Nelson, C. M. (1981). Classroom management. In J. M. Kauffman & D. P. Hallahan (Eds.), *Handbook of special education* (pp. 663–687). Englewood Cliffs, NJ: Prentice Hall.
- Tankersley, M. (1995). A group-oriented contingency management program: A review of research on the good behavior game and implications for teachers. *Preventing School Failure*, 40, 19–24.

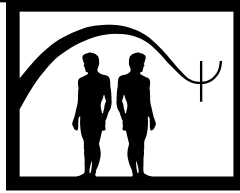

Grief Therapy

Rostyslaw W. Robak

Pace University

- I. Four Tasks of Mourning
 - II. Meaning Reconstruction with Grieving Persons
 - III. Theoretical Bases
 - IV. Outcome Research
 - V. Summary
- Further Reading

Most people experience the loss of a loved one as a painful, confusing, and disruptive event. Several approaches to therapy with grieving persons have been widely applied. The two most well-known models of grief therapy are J. William Worden's "tasks of mourning" and Robert Neimeyer's "meaning reconstruction." Both of these approaches offer valuable specific therapeutic interventions. When applied well, they allow for the expression of feelings and provide bereaved persons with important opportunities to make sense of their grief experiences. Perhaps most significant, such grief therapies provide grieving persons with an important opportunity for self-perception and self-definition. Although grief therapy may be done in either individual or group contexts, group settings usually offer the advantages of support from others, of engaging in altruistic behaviors toward others, and of the recognition of some degree of universality in one's experiences.

I. FOUR TASKS OF MOURNING

There are four tasks in the mourning process, according to William Worden. The first task is to accept

the reality of the loss (death). On one level, this is straightforward: the facts of the loss need to be recognized. On another level, there are two other, more subtle, aspects of the loss—the meaning of the loss and its irreversibility. To accept the meaning of the loss means to recognize its significance. When a bereaved individual gets rid of all reminders of the deceased, or engages in forgetting the lost person, or denies the intimacy, impact, or importance of that person then it is likely that he or she has not engaged in the task of accepting the reality of the loss. Thus, the first principle of grief therapy is to help the survivor actualize the loss. This is accomplished primarily by facilitating the survivor's talking about his or her experience of the loss.

The second task of mourning is to acknowledge and work through the pain of grief. This is a particularly difficult task because no one wishes to feel such pain.

First, grieving persons may actively seek to avoid painful feelings and thoughts. They may, for example, use thought stopping, they may idealize the deceased to allow themselves only fond memories, they may use alcohol or other drugs, or they may even try a "geographic cure" (e.g., selling the house and moving away). Second, friends may prefer to avoid the pain of the grieving person's experiences. This leaves the griever isolated. Finally, therapists themselves may avoid the griever's pain in therapy. In conceptualizing a case, therapists may reduce the pain of grief to a concept with which they may be more comfortable within their theoretical framework. Above all, therapists may give in to an impulse to help. For some, this may mean

wanting to take away the pain. It is extremely important for therapists to recognize their inability to take away the other person's pain. The therapist's role is to both sit with the person's painful feelings and to help him or her express these.

A particular set of feelings should be noted at this point. Anger is commonly experienced but not always readily expressed by bereaved persons. They often harbor anger toward the deceased and toward God, fate, or life in general. It is usually a fruitful therapeutic exercise to ask "In what ways have you been angry with ... (God, etc.)?" Permission to express such anger usually results in a sense of relief at a burden lifted and at not being alone in having such feelings.

The third task of mourning is to adapt to an environment in which the deceased is missing. A deceased person has often played many roles in the survivor's life. Sometimes these roles do not become apparent until some time after the death when the survivor is coping with the everyday tasks he or she must now take over. At this time, it is usually therapeutic to problem solve in concrete ways.

In some cases, the survivor's self-definition has depended heavily on his or her relationship with the deceased person. In such cases it is often helpful to engage the survivor in an active process of self-perception. Group therapy is an especially powerful venue toward this end.

Self-perception theory, as first articulated by Daryl Bem in 1972, asserts that we come to know ourselves in the same way that we come to know others: by observing our own behaviors in various situations. In a bereavement group, members can have many opportunities to engage in altruistic, supportive, and empathetic behaviors toward other members. The group leader points out and labels these kinds of behaviors as they occur and encourages the group member to notice what sort of person would do these things. Under such conditions members can begin to see themselves not as confused and grieving but as active and engaged with others.

According to Worden, the fourth task of mourning is "to emotionally relocate the deceased and to move on with life." It is unclear from his writings if this is intended to be a resolution of the grieving process. In therapy, it is often more useful to facilitate the grieving person's recognition that the lost person is never really forgotten and in that sense that the grieving process never ends. Nevertheless, it is possible to go on with other loving relationships. Such recognitions on the part of the client represent a valid therapeutic goal.

This model has several strengths. It places a strong explicit emphasis on the feeling experiences of grieving

persons. It is relatively easily understood and applied without necessarily relying on its psychodynamic underpinnings. Perhaps most significant, by presenting "tasks" it provides a structure for the grieving person as well as for the therapist. In the face of the intrinsically confusing experiences of grief, a set of tasks can provide grieving persons with a sense of order, self-control, and self-determination in their lives.

The main criticism of this approach is its implicit stagelike quality. It is very tempting to fit all grieving individuals into a mold of "working through the stages" (tasks) of grieving. Nothing could be less therapeutic.

II. MEANING RECONSTRUCTION WITH GRIEVING PERSONS

Another widely accepted approach to grief therapy is a reconstruction of meaning model. Robert Neimeyer, the editor of the journal *Death Studies*, has most effectively articulated this highly idiographic model. This approach emphasizes the uniqueness of individuals' experiences of grieving. The basic premise is that the revision of one's life story in response to a loss is the central process in grieving. Grief therapy is, therefore, primarily an opportunity for grieving persons to tell their stories in ways that will help them to make sense of loss and of life.

This approach views life itself as a story-telling process. People "write" and rewrite their stories and thus develop a sense of meaning, purpose, and identity. Losses, particularly through death, disrupt our stories. They may invalidate or threaten beliefs and assumptions that have lent meaning and order to our lives. Significant losses often trigger a search for meaning. Consequently, grief therapy is focused on a retelling or reconstruction of the grieving person's narrative. This work is done in a way that will allow the survivor to once again find meaning in life in the context of a new reality.

Such grief therapy often consists of a variety of activities, all intended to facilitate self-reflection, a search for meaning, and ultimately a new story about oneself. Writing letters to the deceased may help the grieving person not only to express feelings but also to place the deceased into the context of a new reality (without the deceased person). Keeping a journal can help grievers to label their own experiences during a loss and afterward. Putting together a book of memories can help to affirm the importance of the lost person for the griever. It can also underscore both those aspects of the griever's self that he or she chooses to hold on to after the loss and those aspects that he or she chooses to change. For

some, writing poetry can serve all of these functions but in metaphorical, indirect, and subtle ways.

For others, less verbal techniques can be more productive. Such activities include drawing stories of events in one's life, including a drawing about the loss. Compiling a book of photographs (perhaps mixed in with drawings) can be effective for some. These less verbal activities can become small rituals. Indeed, many personal rituals can symbolically express grievers' feelings and help them to put their experiences into the context of their life narratives.

Authoring an autobiography has been considered a good opportunity to redefine oneself. However, writing an autobiography can be a daunting exercise, even for the best writers among us and even without the pain of grieving. One specific format, sometimes employed in addictions counseling, that lends itself to telling one's story is an exercise known as "lifeline."

Constructing a lifeline consists of drawing a line graph of the experiences of one's life along a horizontal axis that can be divided into 10-year increments. The line goes up or down as it traces events through the years, to reflect one's feelings during those events. The vertical axis can be described as a feeling meter. Thus, the drawn line goes upward when feelings were happy and downward when one's feelings were sad.

A lifeline completed in a group therapy context can be very powerful. Each group member narrates his or her own life using the lifeline as an anchor. (It may be used as a visual aid while telling one's story, but this isn't necessary.) Saying one's story to others is important because it allows others to accept and validate one's experiences.

Saying one's story aloud allows narrators to hear themselves. Hearing one's own story is an instance of self-perception. One learns about oneself by observing one's own behavior and constructions. Thus, the therapist's role is to draw the narrator into an active process of recognizing who he or she is. In this way, grief therapy can be a process of self-perception and self-definition.

There are several strengths of the meaning reconstruction approach. First, this is ultimately an existentially oriented approach to a peculiarly existential dilemma of human life. It begins with people's search for meaning in the face of loss. Second, it encompasses a variety of techniques with the goal of helping grieving persons to make sense of their lives again. Third, serious research efforts have been made within this school of thought to validate the approach and to examine such issues as the applicability of treatments to different types of losses and grievers.

On the other hand, this approach might be criticized as placing too much emphasis on the cognitive and voli-

tional aspects of the person. Such emphasis might be done at the expense of affective, feeling aspects.

III. THEORETICAL BASES

Grief therapy, whether utilizing the tasks of mourning or focusing on the reconstruction of one's meanings, can be understood as an opportunity for heightened self-perception. Recent studies have indicated that at least 70% to 85% of bereaved persons typically engage in a search for meaning in their lives following a death. This means that for most people bereavement holds the potential to be a time when they are looking at such existential questions as "What is the purpose of my life?" and the corollary "Who am I, after all?"

While completing the many therapeutic experiences described earlier, grieving persons observe their own responses to the urgent experience of death and loss. With the therapist's aid, they can examine their own answers to existential questions and learn who they are. If therapists explicitly foster such self-perception, grieving persons have unique opportunities to redefine themselves.

Both a grief therapy centered on the tasks of mourning and one focused on a reconstruction of one's personal meaning allow the person to redefine oneself through observing one's responses to the existential questions posed by the urgent experience of death and loss. However, the two approaches have very different theoretical roots. William Worden's scheme of the four tasks of mourning is firmly grounded in psychodynamic theory. This is most evident in his emphasis on the importance of "working through" the tasks. It seems clear that working through is meant in the psychoanalytic tradition of repetition, elaboration, and amplification.

The meaning reconstruction approach, on the other hand, is rooted in George Kelly's constructive alternativism. Kelly emphasized that everyone construes events in his or her own way. Indeed, we construe ourselves. Constructive alternativism is an existential theory in the sense it assumes no special motivational force in people and no essential human nature. Rather, we are what we do. Humans are self-determining; we are nothing more than what we make of ourselves. Our responses to loss are special instances of such reconstruction of ourselves and of the meaning of our lives.

A search for meaning typically addresses two questions. An early question in this process seems to be "Why? What is the meaning of this death (loss)?" A somewhat later question is "What can I learn from this experience?" or "What is the meaning of this experience in my life?" In 1998, Davis, Nolen-Hoeksema, and

Larson studied over 200 people who had lost loved ones to a slow, progressive death (mainly by cancer). Their work indicates that a search for meaning is really two separate processes: an earlier making sense of the loss and a later finding benefits from the loss. Thus, a search for meaning may be developmental. A shift from making sense of the loss to finding some benefit from it should be a goal in a course of grief therapy.

Neimeyer has defined the reconstruction of one's meanings following a loss to include six elements. First, it is an attempt by the grieving person to find new meanings both in one's own life and in the death of the loved one. Second, these new meanings are integrated into the grieving person's overall scheme of things. Third, any construction of meaning is an interpersonal (and personal) process. Therefore, group therapy with grieving persons can be very fruitful. Fourth, meaning is always found within a cultural context. Finding meaning after a loss must include cultural traditions and rituals of bereavement and grieving. Next, personal meanings are tacit and preverbal as well as explicit and articulated. Simplistic assumptions of therapy as a rational and verbal process may not be particularly applicable to grief therapy. Finally, meaning is not a cognitive "product," it is a process.

The process of grieving had, in the past, been conceptualized as having an ending. Several theorists proposed that following a set of "stages," grieving persons could be expected to reach some sort of resolution. John Bowlby called such a resolution "reorganization." Colin Murray Parkes referred to it as recovery. It was thought by some (notably George Engel) that after having gone through the cycle of a full year following a death the "normal" grief process would end. Contemporary views of grieving do not emphasize such time-delineated resolutions. Catherine Sanders has strongly argued that the bereavement process does not have clear-cut starting and stopping points but is a free-flowing process. She has proposed that the process is best described as consisting of permeable phases rather than fixed stages. Neimeyer has likewise proposed that there are three phases in a typical grieving process: avoidance, assimilation, and accommodation. Such a grief cycle lasts a lifetime.

IV. OUTCOME RESEARCH

Since 1975, when the first controlled research of such therapy appeared, there have been at least 23 empirically based outcome studies of grief therapy. A significant caveat must be underscored before a

discussion of this body of literature can be described. Many of the controlled investigations of grief therapy have not described the theoretical models of the therapy being reported. This stands in stark contrast to the vast body of psychotherapy outcome studies in general. Psychotherapy outcome research usually describes the effectiveness of, for example, a behavioral, a client-centered, or other specific approach to a given problem. The lack of such specificity limits the evaluation of grief therapy.

Barry Former and Robert Neimeyer completed a meta-analytic review in 1999 of 23 controlled outcome studies. Their findings showed that grief therapy outcomes have been better when clients are younger (rather than older) and when clients' grieving has gone on for a longer period of time and is complicated (as opposed to therapy soon after the death). Perhaps the most robust finding is that grief therapy for traumatic death is highly effective. That is, a person who has lost someone to a violent, accidental, or otherwise unexpected death may be the most likely candidate for a positive outcome of a course of grief therapy.

Therapy outcome research in the future may be improved by focusing on several specific issues. First, outcome measurement may be more accurate if it is done after some time has passed as well as immediately after therapy. Very often clients report an increase in their discomfort at the end of a series of grief therapy group sessions. Perhaps a consolidation of learning about oneself needs to occur. Likewise, a course of therapy may serve as the beginning of a search for meaning whose outcome does not occur until some time has passed.

In addition, outcome measures may need to be more specific than they generally have been. The majority of studies to date have used global indicators of improvement such as depression, anxiety, and physical symptoms. It may be more valid to measure specific indicators of grief that are grounded in contemporary theoretical models and empirical research.

V. SUMMARY

The experience of loss, particularly through death, is usually a confusing experience that triggers a search for meaning in the majority of bereaved persons. Grief therapy, especially in a group context, can provide grievers with a scheme of mourning and recovery such as the one provided by working through the four tasks of mourning. These are accepting the reality of the loss, acknowledging

the pain of the loss, adapting to an environment in which the deceased is missing, and emotionally relocating the deceased and moving on with life. Grief therapy can also aid the griever in reconstructing the meaning of one's life. This can be done with several techniques. One such technique is to review one's life with a special emphasis on placing the meaning of the loss into one's lifeline and defining oneself following the loss.

See Also the Following Articles

Self-Control Therapy ■ Self-Help Groups ■ Trauma Management Therapy

Further Reading

- Neimeyer, R. A. (1998). *Lessons of loss: A guide to coping*. New York: McGraw Hill.
- Neimeyer, R. A. (2000). Searching for the meaning of meaning: Grief therapy and the process of reconstruction. *Death Studies*, 24(6), 541–558.
- Robak, R. W. (1999). *Loss and bereavement counseling*. South Orange, NJ: Hemlock Falls Press.
- Sanders, C. M. (1998). *Grief: The mourning after – dealing with adult bereavement*. New York: Wiley.
- Worden, J. W. (1991). *Grief counseling and grief therapy: A handbook for the mental health practitioner* (2nd ed.). New York: Springer.

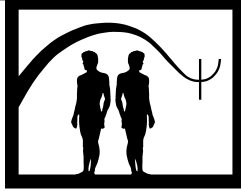

Group Psychotherapy

K. Roy MacKenzie

University of British Columbia

- I. Description of Treatment
 - II. Theoretical Bases
 - III. Application
 - IV. Designing Programs
 - V. Summary
- Further Reading

- d. Developing a sense of hope that change is possible
3. Self-revelation factors:
 - a. Self-disclosure
 - b. Catharsis
4. Learning factors
 - a. Modeling on others
 - b. Vicarious learning through watching others
 - c. Guidance through suggestions from others
 - d. Education from the experiences of others
5. Psychological work factors
 - a. Interpersonal learning from group interaction
 - b. Insight into one's own patterns

GLOSSARY

general systems theory The basic theory of understanding groups; groups are seen as “organized complexities,” or “systems” that are the product of the dynamic interaction among their parts rather than the sum of their absolute characteristics. Neither the resultant whole nor its new characteristics can be fully explained by the nature of the parts themselves.

group dynamics This refers to the interactional patterns within groups. This includes group-level experiences such as group cohesion based on seeing the group as attractive and helpful and that provides an important supportive function. Group norms evolve from the group interaction with guidance from the leader that give stability and safety within the group. Members will also adopt group roles based on their own outside behaviors that will provide important learning experiences in the group interaction.

1. Group dynamics also embraces the concept of therapeutic factors. These provide supportive and motivating experiences that create a powerful change environment.
2. Supportive factors:
 - a. Universality by understanding that others have had similar experiences
 - b. Feeling acceptance by the group
 - c. Experiencing altruism by helping each other

psychodynamics This is a broad concept referring to the psychological operations that govern thoughts and behaviors and of which the individual may not be consciously aware. In particular, from a therapeutic perspective, the psychodynamic tradition described the presence of wishes in the context of relationships (for example to be more assertive) that may lead to fears of the response of others (for example being rejected) or of response of self (for example, remaining passively silent). These patterns are seen as arising from early experiences.

All these features of the group dynamics develop from within the membership as they relate to each other. The therapist's principle function is to create a positive and safe group culture in which these therapeutic experiences can take place. Therapy then truly takes place, not from the wisdom of the therapist, but from the interpersonal learning among the members. These processes will be

found in all groups to a greater or lesser extent. They will be used in various ways depending on the group model that is being used. In psychoeducational treatment models there is a class room-like atmosphere to learn a skill such as assertiveness, or to become informed about a diagnostic syndrome such as the symptoms and problems associated with bulimia nervosa. The group dynamics will be operating more or less in the background. Cognitive-behavioral models make more use of the group process through active discussion and challenge around the efforts to address negative thoughts about self or address behaviors such as obsessive-compulsive patterns. Interpersonal and psychodynamic group models make extensive use of group-based learning among the members. This spectrum of group models, each with its own set of unique techniques may give the group literature a scattered feeling. However, the important common base is the power of group interaction to support and promote change for a wide range of conditions.

I. DESCRIPTION OF TREATMENT

Group psychotherapy is a widely used treatment modality. However, there are many types of groups for different conditions and often several models of groups for a particular condition. This makes a description of the field somewhat complex, and even the term “group therapy” relatively lacking in meaning except that several people are meeting together. Group psychotherapy is widely used as an intensive treatment modality to address psychological issues especially those involving unsatisfactory interpersonal patterns. Group therapy is also used in a more structured manner to address negative cognitions, to learn skills such as assertiveness, and for psychoeducational purposes. This wide range of group applications involves the use of groups that are conducted in quite different ways.

This article begins with an overview of the effectiveness of group therapy and the sorts of problems that can be treated in groups. This includes the question of how many group sessions are needed to be helpful. Then an overview of basic group theory is provided emphasizing the importance of considering the whole group as the vehicle for treatment. This is followed by a discussion of the generic processes that occur as a group develops. Different types of group models are then reviewed and what problems each is designed to address. Finally, there is a description of how group programs can be developed for use in larger systems of health care.

Group therapy has been studied extensively and in particular there have been a number of large and com-

prehensive studies over the last decade. A recent survey of 23 high-quality randomized outcome studies found effect sizes (a statistical measure of change) in a range of 0.76 to 0.90. This means that treated patients were doing significantly better than 78 to 82% of control patients who did not receive active treatment. The clinical literature derived from regular treatment settings suggests similar outcome changes. A number of studies have directly compared the results of group therapy and individual therapy for a similar patient population and using the same theoretical treatment model. With very few exceptions, both modalities have about the same clinical outcome across a wide range of clinical applications.

The list of conditions treated in groups is extensive. Virtually all models of individual therapies have been used in group therapy. The highest use of intensive group models is with the more common conditions of depression, anxiety states, eating disorders, and personality disorders. Groups of a more supportive nature are widely used as an adjunctive treatment for more severe and chronic conditions such as bipolar disorder and schizophrenia.

II. THEORETICAL BASES

There is a clearly articulated theoretical basis for group therapy based on general systems theory. The major difference between individual therapy and group therapy from a process viewpoint is the presence in groups of a range of relationships rather than the single relationship of individual therapy. This makes groups a more complex treatment system and has led to the idea of therapy through the group process as opposed to therapy of the individual in the group or therapy provided solely by the leader. The role of leader in a group is quite a different task than the role of the individual therapist. The leader must be monitoring each member as well as the general climate of the group.

A group becomes an entity when there are identifiable patterns of connections among the members. Before that occurs the group is simply a number of people more or less together. Systems theory provides a model for describing the properties of a group. Organized complexities, or “systems,” are the product of the dynamic interaction among their parts rather than the sum of their absolute characteristics. The whole group and its characteristics cannot be explained by the nature of the parts (the leader and the members) but by how they interact. This dynamic interaction can be understood as the flow of factual and emotional information across a series of boundaries.

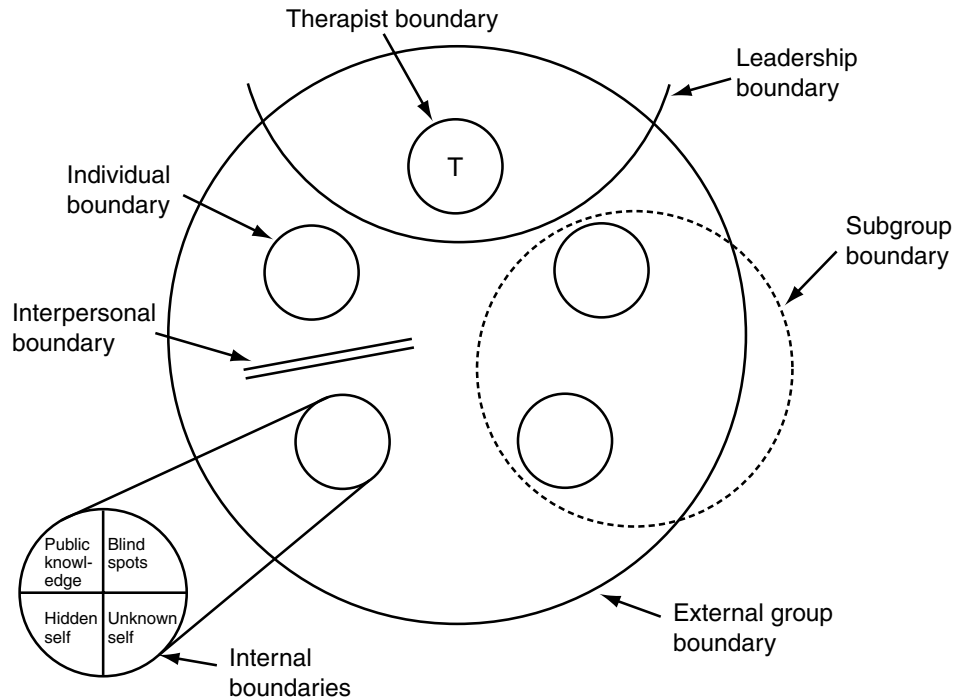

FIGURE 1 The group system. A schema of important boundary structures in groups. From MacKenzie, K. R. (1997). *Time-managed group psychotherapy: Effective clinical applications*. Washington, D.C.: American Psychiatric Press, Inc. Reproduced by permission.

The term “boundary” is being used in a double sense. Boundaries can be conceptualized in physical terms: Closing the door of the group for the first session is a powerful message that a group has been created; the number of members in a group will have an influence on its process. However, of greater interest to an understanding of the group process is the idea of the boundary being created by an awareness of transactions across the boundary and particularly of differences on either side of the boundary. For example, an early phenomenon in therapy groups is the awareness of universality, as the members understand that they share many common symptoms, experiences, or emotions. Technically this could be seen as the development of an external boundary to the group: “We in this room are a special category of people who can understand each other,” as opposed perhaps, to the perceived lack of understanding of spouses or friends outside the group. The nature of boundary regulation is expected to vary over time as the group proceeds. The format of a time-limited closed group provides an ideal model for application of group systems concepts.

The concept of group psychotherapy as treatment through the group process does not mean that a psychodynamic model must necessarily be used. If several members are participating together, the nature of their

interaction cannot be ignored in trying to understand the effectiveness of the treatment. It is useful to distinguish the difference between the psychodynamics of the internal processes going on inside the individual and the group dynamics that are going on among the members and leader.

The boundary structures form a hierarchy of levels: A minimum list includes the whole group as a unit in its external context, interactional phenomena occurring between members including the leader(s), and the internal psychological processes within each member. Many group therapy research reports confuse or ignore these levels in their analyses. They may provide a full discussion of the technical strategies and outcome but no information regarding the group process through which it occurred. Figure 1 gives a visual portrayal of the most important boundaries.

1. *The whole group external boundary*: This defines the properties of the whole group that must be dealt with as collective in nature. This perspective of the whole group has direct application to pregroup decisions. For example, a group composed of all members experiencing the same disorder is likely to have an experience of early cohesion. The whole group focus also

includes stability of membership and attendance patterns including closed or open group models. Behaviors such as extragroup socializing and breeches of confidentiality transgress the external boundary and may have an important influence on outcome. The external boundary also includes a consideration of the properties of the whole group such as cohesion, group climate/atmosphere, or group development that are derived from the overall membership.

The idea of group roles is also a group-level conceptualization because the role designation is based on a process of negotiation between the individual and the collectivity. The same person might behave quite differently in a different group. There are four basic roles.

a. *Sociable role*: Someone who assumes this role tends to be friendly and supportive, seeking to keep relationships on a positive tone. They are eager to help others sometimes to their own disadvantage. They play an important function in promoting cohesion and engagement and are comfortable with emotions, especially positive emotions. Their role is particularly important as the group forms.

b. *Structural role*: These are members who are active in organizing the group. They tend to emphasize cognitive ideas and the need for the group to stay on-task and may be seen as controlling. They are of value to the group in keeping a focus on therapeutic work.

c. *Divergent role*: These members are challenging and questioning and often take an oppositional stance. They play an important function of making the group address important issues. They are comfortable with negative emotion that promotes interaction but are in danger of being isolated by the group. Their involvement is particularly important in the differentiation stage of the group described later.

d. *Cautionary role*: These group members are reluctant to participate and are anxious about revealing much of themselves. They are in danger of being ignored by the group or being subtly criticized for not participating. They may highlight for the group the dangers of becoming overinvolved.

2. *The subgroup boundary*: It may be useful to understand the role of subgroups. These may consist of clusters of members who create helpful or hindering effects on a group. Subgroups within the same group may respond quite differently to specific therapeutic models according to characterologic features. These considerations may have an important bearing on composition decisions. For example, a group with quite diverse levels of symptomatic dysfunction among the members may have trouble developing cohesion because of the disparity in the sorts of issues they bring to the group.

3. *The leadership boundary*: Leadership involves both the choice of a particular theoretical model to be used and the technical style used to deliver that model. The role of leader plays an important function in groups but with different implications than in individual therapy. The leader may be seen as a director or authority and more remote because the leader's activity must be shared with all members. The more complex situation of co-leadership offers the opportunity for collaboration or competition around theoretical beliefs or technical strategies. Different theoretical models will bring with them implications for group leadership. For example, group behavioral therapy may have quite high levels of process control through the use of structured procedures and review of homework, whereas group psychodynamic therapy is likely to have quite low levels. The theoretical model may be given credit for effectiveness that is actually due primarily to the nature of the process component.

4. *Therapist boundary*: The therapist is also present as a person with personal characteristics that may have an important impact on the group or some of its members just as in individual therapy. In the case of co-therapists, the leakage of subtle messages between them will be closely watched by the members, especially if there is a female-male pair. Self-disclosure by the therapist(s) may go beyond that prescribed by the technical model being implemented but driven by the interactional pressures of the group.

5. *The interpersonal boundary*: Most of the action in groups occurs between the members. Later in this chapter there is a discussion of the impact of group composition and size on interpersonal patterns in a group. An interpersonal learning cycle that is based on disclosure and feedback among the members is also described. All groups develop norms, general ideas about how the group should function. Often the leader is active in specifically discussing how the group can most effectively operate, an issue discussed later under the heading of Group Development. However, groups also develop their own set of norms; one clear example is how a group for adolescents will carry on the group with their own agendas in parallel with those of the therapist. Addressing these differences may provide most of the therapeutic learning. Once established, norms tend to persist even if there is a major turnover of membership.

The role adapted by the leader has a major impact on the nature of group interaction. Skill-based groups, such as some forms of cognitive training for challenging negative cognitions, may be conducted with a classroom atmosphere and little discussion. At the other end of the

spectrum, process-oriented groups may pay less attention to outcome application and focus primarily on the meaning of group process. The research literature suggests that neither extreme is optimum. The group process can provide non-specific support and motivation that enhances group goals. Application to real-life situations forces the need to address resistance to change. The group therapist must be aware that group process is always going on whether overtly or covertly and will have a positive or inhibiting effect on outcome.

6. *Internal member boundaries*: Therapists vary considerably regarding the level of attention to enacted interpersonal behaviors versus internal processes depending on the theoretical model being used. But of course there is much going on inside each group member that may or may not be revealed. Tapping such internal phenomena may provide useful information for understanding both the individual and the impact of group events on each member. The importance of such findings is not restricted to psychodynamic models.

III. APPLICATION

A. Group Development

There is substantial evidence from the group process literature for the phenomena of group development. Indeed, research findings indicate that those groups that follow a developmental sequence produce better outcome for the members. The most basic description of group development consists of a four-stage model of engagement, conflict, interpersonal work and termination. Additional stages have been described that would fit either as subunits under the broad heading of interpersonal work or as identifying issues regarding greater independence from the leader. The group development perspective is a powerful metaposition from which to understand group-level events. In the following description of group development, strategically helpful interventions that augment the characteristics of each stage are described. Although the specific applications must be adapted for any particular group, the basic positioning of therapeutic intent will help to maximize the outcome.

Group development is most evident in closed time-limited groups of 3 to 6 months duration. This format is widely used, making an understanding of group development a particularly helpful theoretical perspective for the clinician. The stage descriptions that follow are based on this type of group format, and important therapist tasks for each stage are described.

Open-ended groups will go through minidevelopmental stages when membership is altered. This is most evident in regard to the new member(s) but the entire group also participates because group roles may be lost or challenged by the changes. Some groups, such as acute crisis groups, may change membership with each session but compensate for this with a higher level of group structure.

Assessment and preparation tasks are discussed first for, although they are not formally part of the group development sequence, they are part of the early tasks that the leader must address.

1. Assessment

The first set of tasks in assessment is to identify the predominant diagnostic difficulties. The purpose of this is to establish what treatment approach will be most likely to be effective in this specific clinical setting. A closely related task is to match to the extent possible what type of group (or other treatment) is likely to be most effective. The goal is to maximize the accuracy of prediction of who will benefit from what type of treatment.

The second set of assessment objectives is to develop a focus for treatment. This will begin with a review of the most troublesome symptoms. Going through these in some detail is helpful because the discussion serves as an acknowledgement of the reality of symptoms. Often patients will feel that previous caregivers or family members have not understood what they are experiencing. It is particularly helpful to go through a careful chronology in relation to life events or other stress-precipitating triggers.

Most patients present for treatment in the context of some type of stress. This is most frequently in relationship to interpersonal events. A review of an interpersonal inventory of important people may reveal associations that even the patient is only vaguely aware of. The principle focus will be on current spouse/partner, current extended family, and current friendship circle. Past significant intimate relationships, nuclear family of origin, and extended family of origin will help to understand the quality and patterning of interactions over time. Major themes can be elicited by inquiring about three relationship dimensions: the overall tone of a relationship in terms of affection versus negativity/anger, the status of control versus submission of both participants, and whether relationships tend to be overinvolved versus underinvolved in nature. An understanding of the management of the spectrum of emotions will be important. Finally, an effort to identify chronic stresses, the nature of living arrangements, finances, friendship circle,

and involvement in community activities provides an assessment of the social context.

Because groups by their very nature involve interpersonal functioning, it is useful to go beyond syndrome diagnosis by applying the interpersonal inventory to identify basic interactional patterns and triggering events. The use of brief questionnaires may provide useful information, especially in regard to interpersonal patterns. From this database it is possible to develop target goals to provide a focus for clinical work. This task should be addressed from a position of neutrality and cognitive clarity about issues that have emerged during the assessment. It is helpful to elicit real-life examples and the role the patient plays in these. A direct approach to this sensitive task ensures the patient that he or she is being understood but also that the important issues will not be avoided. It is helpful to specifically connect symptoms to triggering circumstances. The overall goal is to establish a serious working engagement at an early point with initiative coming from the patient, not just the clinician.

Following one or two individual assessment interviews, a final decision is required regarding the suitability of the patient for the type of group being planned. It would be better to delay treatment for a more suitable type of group than begin the patient in a group where integration might be difficult. From the other perspective, the clinician needs to consider the impact of the member on the group. Groups are generally able to absorb quite a range of problems. However, particular care should be taken to identify potential outriders, especially patients with a strong negative and autonomous controlling style. They are able to shut down group process, and the therapist has a double responsibility, to the individual and to the group. Some studies suggest that such patients do better in individual therapy.

2. Preparation

The empirical literature is clear that careful preparation leads to early group cohesion and therefore to fewer early dropouts and better eventual outcome. A systematic introduction to the nature of group therapy is indicated. This can be done verbally or preferably with the assistance of a brief handout. This might include mention of the research basis for group therapy and a brief description of how to get the most out of the experience. Some of the myths about groups may be discussed. For example the notion that it is a second-rate treatment, that people will be put on the hot seat, that talking with people who have similar problems will make everyone worse, and that the group will get out of control as sometimes portrayed in the media.

Frankly discussing these issues along with any questions the patient might have will be reassuring.

There are multiple tasks for the therapist before the group commences. These include a careful description of the proposed treatment and clearly setting a time frame, including the date of the final session. This has the added advantage of uncovering problems in attendance that might preclude a patient joining this particular group. It is useful to emphasize the patient's role in defining patterns concerning issues to be addressed and in participating in the group interaction. If the group is to be process oriented the importance of working with other group members should be emphasized and the less active role of the leader in facilitating group interaction. If the group is of a structured nature, the pattern of sessions should be described as well as the role of specific homework tasks.

3. Developing a Focus for Treatment

The choice of issues to focus on is a central task in the pregroup interviews. The therapist can function as a helpful technical resource always trying to cite the patient's own words in describing issues. The use of descriptive language rather than interpretive comments makes it more palatable to discuss dysfunctional patterns. Being direct about this task brings relief at being understood and often clarifies the patient's own partial awareness of difficulties. If questionnaires are used it is helpful to give the patient copies of the results. Various treatment models will emphasize specific types of goals as described later.

Effective goals should be seen as important and relevant to the patient. They should be realistically achievable for the treatment model offered and the time frame of treatment. They should emphasize changes the patient can make, not that others have to make. It is important to elicit collaborative discussion and to state clearly that the goal of treatment is to address these issues. The past may be used as a template, but application must be addressed in the present both in the group and outside.

Group rules or expectations should be addressed specifically. These include the importance of regular and punctual attendance and tardiness. A full and clear discussion about the absolute necessity of confidentiality is essential, as any member joining a group will be concerned about this. There needs to be a clear guideline in regard to extragroup socializing. This will be stringent for most groups but on the other hand may be encouraged in groups that are largely supportive in nature. The important task is to be very clear about the

expectations in this regard. Some mention that the members must not come under the influence of alcohol or non-prescription drugs is useful for the rare occasion when such events happen. It is also wise to clarify whether or not active concurrent individual psychotherapy is to be allowed.

Careful pretherapy preparation promotes early cohesion and reduces chances of early dropouts. It establishes a bond with the therapist that provides motivation in early sessions and a sense of security that the leader is in control though not controlling.

4. Engagement Stage

The initial task when starting a new group is to create a sense of membership in the group. The members of successful groups report an increasing feeling of belongingness over the first few sessions. The leader should take a modestly active stance particularly directed at stimulating intermember communication patterns. This can be done in an unobtrusive manner by brief interventions such as "Have others had this sort of experience," "John, you look as if you understand what Mary is talking about," and so on.

This simple strategy will facilitate interaction between members and away from the leader. This promotes the emergence in the group of important supportive therapeutic factors. The first of these is the experience of universality, that others have similar problems, ideas, and experiences. This process is enhanced when the group has been composed according to some common theme, such as a specific diagnosis, or an experience such as having trouble dealing with a death. The second therapeutic factor is that of experiencing acceptance. Many people seeking psychological help feel blocked in some way with interpersonal difficulties and real or feared concerns about not being adequate or being rejected. In a beginning group there is a strong need to be understood which is why similarities need to be stressed. The experience of feeling understood and becoming part of the group forms a foundation for self-acceptance and enhanced self-esteem. This process inevitably involves acts of altruism, of people helping each other. This allows the individual to feel appreciated and valued. These three mechanisms converge to produce the generation of hope that change is possible.

The initial group environment will be to some extent a reflection of the care taken in the assessment and preparation procedures described earlier. One method of enhancing these connections is for the leader to suggest at the beginning of the first session that people introduce themselves in terms of what they want to focus

on in the group. This automatically links a working focus with the engagement task.

Initial factual self-disclosures are important, not so much for their content, as for the process of participating and for the recognition of common issues and problems. This creates a sense of safety and acceptance that will be reflected in increasing group cohesion. The sense of groupness consolidates the group external boundary and can be reinforced by comparisons between events within the group and with those outside. A common theme is the uniqueness of sharing personal issues and the difficulty of doing this outside. At an internal level, participation in the developing group system is accompanied by an early sense of well-being at finding that one is accepted and understood which has the effect of encouraging greater self-disclosure as well as improving a sense of self-esteem.

The tasks of the engagement stage have been met when all members have demonstrated a firm sense of commitment and have participated to some extent with important self-disclosure. This is usually accomplished in the first three or four sessions. Within the process development, there will also be a content focus on revealing problems. The leader can encourage this but primarily in terms of increasing information, not solutions. The group needs to have a sense of consolidation before addressing issues more deeply. Attention to these initial engagement functions is important in all groups. They provide a powerful set of common factors that have been demonstrated to predict better outcome in highly structured groups as well as in process-focused groups.

Most group dropouts occur in the first four sessions. This is primarily linked to whether or not the patient feels engaged in the group. Measures of the therapeutic alliance to the group, of the alliance with the leader, and of group cohesion are important predictors of dropouts. The sequence of careful assessment, preparation of the member for the group, and the management of the first few sessions are key to reducing dropout rates. This is particularly important because a group that begins to lose members also becomes demoralized, and this may initiate a process of continuing attrition.

5. Conflict Stage

The positive collaboration of the engagement stage then shifts to an atmosphere of interpersonal tension that is characterized by a more confronting and challenging quality that may have an angry or resentful component. The essential task is to develop patterns for conflict resolution and tolerance of a more negative atmosphere. This stage is a necessary component for the

developing group. The term “differentiation” has been used to emphasize the importance of self-assertion and self-definition that underlie the process. The interactional themes tend to shift from ones of commonalities to those of differences. This addresses the potential liability that the engagement stage group may have of avoiding difficult but important issues. The challenge within the group is accompanied by a parallel internal challenge regarding negative or shameful feelings about self. Generally, the confrontive style is also demonstrated toward the therapist as the collective group seeks to differentiate itself from the leader. This includes a reworking of group norms that now become the “property” of the group, not just the leader. This stage often has a somewhat adolescent quality of challenge for challenge’s sake.

The leader can assist this stage by showing interest in the issues arising and endorsing the importance of addressing them. Explicit acknowledgement may be made that tensions in the group are a positive sign that important topics are being addressed. Almost inevitably some of the negative atmosphere will be directed at the leader. This often takes the form of not getting enough guidance (in process-oriented groups), or of too much focus on tasks and not enough on process (in highly structured groups). The principle task of the leader is to acknowledge the issues being presented and encourage open discussion about them. A defensive response will tend to shut down the group and result in a demoralized atmosphere.

The therapist needs to appreciate that this is a normal group phenomenon, not an individual member issue. The energy within this stage of the group can be channeled into expanding an understanding of the details concerning the difficulties that members are addressing. The therapist may use this stage to increase the expectation of applied work in the group. This may be of an introspective or interpersonal nature or of expectations in terms of applying behavioral or cognitive strategies. The member is thus encouraged to challenge self as well as other group members. This lays the basis for greater self-introspection later. A group that is not demonstrating the features of the conflict stage by the sixth session is falling behind the expected curve and is in need of examination.

The first two stages of engagement and conflict provide the experiences required to develop a deepened sense of group membership and participation. The group is able to provide support and acceptance, while also able to confront issues. In terms of group development, these are early phenomena, but they also begin

to address core difficulties regarding trust and acceptance and with difficulties surrounding assertive behaviors that are commonly found in people experiencing psychological distress. Self-esteem is often improved, and symptoms begin to ease. Early response is a strong predictor of later outcome. Group members who are not beginning to respond during the first 6 weeks in a closed weekly format need special attention. Helpful strategies would be to maintain a consistent focus on their comfort in the group, further exploration of the nature of the issues they are addressing and efforts to keep them actively involved in group discourse. Often approaches by other group members may be as useful as those directly from the therapist. The leader may use techniques such as “What do others make of the issues Henry is raising,” or “Can anyone help Marilyn sort out the tensions she is describing in her marriage.” It is not helpful to assume that the situation will improve in the later part of the group.

6. Interpersonal Work

The group is now equipped to address individual problematic matters in a more vigorous manner. The focus tends to shift to greater introspection and personal challenge. This promotes increased closeness among the members as they align in the exploration of more difficult common issues. This stage of the group is likely to stimulate themes central to interpersonal functioning such as tolerance of intimacy, management of control–dependency in relationships and fears of becoming overinvolved in relationships and losing a sense of self.

The importance of the therapeutic alliance and cohesion has been discussed earlier with the supportive working factors that are operative. A supportive group environment promotes a sense of safety that allows more challenging interactions. As the group moves into the interpersonal work stage these factors begin to give way in importance to the working alliance factors that place greater demands on the members to deepen the level of participation in the group.

A practical way of conceptualizing the interpersonal work stage of the group is based on recent detailed process research. As the sense of security in the group grows there is an increase in personal self-disclosure and catharsis. This elicits feedback from other members regarding this new information. Tolerating discrepant feedback is correlated with change in maladaptive patterns and promotes a process of interpersonal learning. This occurs on two levels. The actual interchanges in the group help to clarify interpersonal patterns and thus lead

to modification of those aspects that produce difficulty. This process leads to enactment within the group of a change of style. At the same time, an internal process of self-examination is triggered that results in changes in real life outside relationships. Success in these relationships provides a reinforcing cycle of positive experiences that serves to diminish symptom distress.

7. Termination

This stage may occur at varying points in the development of a group depending on the circumstances promoting or impeding development. It will have greater salience in groups that have developed a strong interactive milieu, that have met at least for several months or in an intensive format, and that end together. Endings are often a problematic area for people seeking psychotherapy. It is common for complicated grief issues to emerge; some members may experience acute anxiety around themes of abandonment or rejection, or of not getting enough. Termination confronts the members with the issue of assuming responsibility for managing one's self. These termination themes incorporate basic maturational tasks that are central to the human condition.

Paradoxically, the imposition of a time limit creates an arena in which such lifelong issues can be directly experienced and addressed. Termination issues are often avoided in psychotherapy. A systematic approach to managing termination will ensure that all members participate in the process. The ending of a closed time-limited group offers an opportunity to systematically maximize an exploration of the important issues related to loss.

The leader should make it clear as a patient enters a group exactly what the time line is expected to be. If it is a closed time-limited group the ending date should be clearly identified at the beginning. About 4 weeks from the end the topic of termination needs to be introduced and discussed. The theme of termination will be lurking throughout all subsequent sessions, and the therapist can be active in identifying it and encouraging further discussion. The final session is best focused primarily on termination reactions. This may be woven in with other termination matters such as relapse prevention material. An ending set of go-arounds with each member saying something by way of good-bye to all other members evokes many supportive and validating comments. A follow-up visit in a few months time is useful and provides an incentive to continue with personal therapeutic work. It should be on an individual basis, not a group meeting.

The description of the change process in psychotherapy groups described earlier applies to all types of groups,

not just those using an interpersonal model. In individual therapy, the interactional process is not as complex and under greater control by the therapist. The distinction between a cognitive and a psychodynamic individual session is obvious. In group therapy, there is a large informal interactional process that has been shown to have a significant impact on output. Therapy through the group process is not just a theoretical concept; it is enacted inevitably in any group treatment. A recent survey of process research in behavioral and cognitive groups has provided provocative findings. Some studies specifically found no correlation between a change in negative cognitions and outcome. Others found that characteristics of the group process, mainly cohesion/alliance measures, or patient characteristics accounted for as much or more predictive power regarding outcome than technical strategies. These findings suggest that clinicians employing a more highly structured treatment model need to be alert to the implications of selection and process impacts on outcome. Group process dynamics provide a supportive and motivational component quite apart from the impact of technical strategies.

8. External Structural Factors

Clinical experience suggests that numerous external factors will have a significant impact on the process of group development. The number of sessions available will in part determine how far the group can progress. For example, a group restricted to six or eight sessions is unlikely to move beyond engagement tasks because it will shift directly from engagement to preparing for termination. Inpatient groups or crisis intervention groups that have changing membership almost every session will not be able to progress beyond the engagement stage. Highly structured groups that are designed for psychoeducational purposes, or for specific skill training such as assertiveness, may be limited in the amount of interaction that occurs and will therefore show weak developmental progress.

The therapist for such brief groups may need to be relatively active to keep the group at the appropriate level. The leader needs to calibrate interventions therefore toward encouraging early-stage tasks that make full use of the supportive cluster of therapeutic factors that encourage group interaction and promote cohesion around addressing problems or topics that are external to the group itself. Trying to push such groups forward into more conflictual or introspective work will inhibit achievement of the goals of the group and may lead to dropouts.

The interactional capacity of the members chosen for the group will also have an impact on the speed at which it can develop. For example, groups for schizophrenic patients generally show a developmental process measured in months or years. Groups operating in a corrections environment where there are high levels of control and distrust will have difficulties developing an initial cohesive group. Groups for more difficult populations such as personality disorders are often treated in a brief group format but usually with a behavioral or cognitive model in which group interaction is contained in the service of information or skill focus.

A traditional format for group psychotherapy has been the longer-term slow/open group format in which members are added only when an opening becomes available. In such groups, the working atmosphere of the group is maintained with fluctuations related to tension and resistance as important issues are addressed. Any change of group membership will force the group to address engagement issues, but in such an ongoing working group with a small membership change there is not usually a major shift in atmosphere. This process might be more realistically understood as one in which the new member goes through the stage processes to rise to the level of interactional work of the ongoing group.

9. Role of the Group Therapist

The therapist is in a position to manage group development by selecting a particular theoretical model or group format, and by virtue of intervention techniques strategically selected to promote group development. The therapist should consider, before the group begins, the extent to which the more challenging atmosphere of the differentiation stage is best managed. For time-limited groups this is the most critical period.

Groups that follow a highly structured psychoeducational or behavioral format generally choose to stay in a classroom or seminar atmosphere throughout their course and make less use of interaction among the members. Group interaction would be noted and managed to maintain a working atmosphere but not explored. The focus needs to stay on the material being presented with encouragement of active group discussion around the material and elicitation of examples but not intimate personal self-disclosure. Leaders need to beware of slipping into a more intimate therapeutic mode.

Cognitive-behavioral models more commonly use engagement stage interaction actively to reinforce learning through the interpersonal process while managing differentiation issues without exploring them in

detail. The goals of such groups will be addressed primarily through application to outside circumstances, and the group may be used to rehearse new behaviors. The therapist may, for example, manage leader challenge by acknowledging the issues, appreciating that different viewpoints are helpful, but using the process to highlight the value of recognizing negative thought styles. This requires a clear distinction between group dynamics and psychodynamics. Paradoxically, the early structure of these groups promotes a rapid sense of security leading to cohesion that moves the group toward the differentiation stage quite rapidly.

Interpersonal groups will encourage member-to-member interactions from an early point and thus promote a strong sense of groupness. Groups employing an interpersonal or psychodynamic model are designed to use the group process as a major therapeutic vehicle. The leader will want to promote the differentiation stage and use it as an opportunity for interactional learning. The goal is to have the group move through the engagement and differentiation stages vigorously but without delays so that maximum time will be available for the interpersonal work stage before termination issues need to be addressed. Thus the developmental format forms a semistructured background that will guide therapist interventions.

Providing some structure within the first few sessions has been shown to increase levels of self-disclosure though care needs to be taken that the structure does not dampen individual initiative. In all types of time-limited groups there are advantages to creating a cohesive atmosphere quickly suggesting that consideration be given to introducing a modest degree of structure in early sessions. For example, the first two or three sessions of an interpersonal group for depression might be structured around discussion of the experiences of the members with depression. This might be followed by psychoeducational input regarding the signs and symptoms of depression, and a go-around discussion regarding what factors seem to be involved in triggering or maintaining the depression. Such structure has two goals: to elaborate on issues pertinent to the presenting diagnosis, and to provide a vehicle for rapid involvement in group interaction.

Several studies have found that the intentions of the therapist are a good predictor of outcome. This suggests that the actual overt behavior of the therapist is modulated by a range of implicit messages that surround and enhance the specific interventions. It would be wise for the therapist to specifically consider what therapeutic techniques would have the most impact at

regular intervals. These same studies however, also indicate that the impact of the therapist's intentions will be modified by the group climate, implying the need to monitor the atmosphere of the whole group regularly. As an example, in one study, therapist intentions to develop an interpersonal focus and provide group structure generally were associated with later group outcome. However, the same intentions in the presence of a group climate with significant conflict did not have an effect on outcome.

The therapist is also in a position to model interventions congruent with stage tasks. For example, early in a group the therapist will model empathic and supportive techniques to build an interactional atmosphere of trust. As the group moves into the differentiation stage, the therapist may model a somewhat more confrontational style. In the interactional work stage, the therapist may, if anything, increase levels of interventions with a greater depth of focus on individual member issues. During termination, the therapist may provide a model of openness to termination themes and a comfort in addressing them directly by focusing on important issues concerning self-sufficiency and loss.

10. Models of Group Therapy

It is estimated that there are several hundred types of groups. It would be unrealistic to describe even a small portion of them in detail. Table 1 provides an outline for placing a group model within a spectrum of possible groups.

In terms of the rows of "Time frame" and "Group entry" in the table, the models go from relatively unstructured through to time-limited and closed groups, to variable intensive group formats. GCBT and IPT-G represent more recent models developed for use in empirical research studies that are now widely used in general clinical use. They have the benefits of clinically oriented manuals and strong empirical validation that still allow the therapist reasonable room for individuality. Several studies have found that clinicians who use a defined model and adhere to the manual achieve better outcome results. The Yalom model differs from IPT-G through greater emphasis on the importance of "here-and-now" process interpretations. The literature makes frequent reference to this model though in practice it takes a variety of forms. The description of therapeutic factors is particularly useful in orienting the new clinician to general principles of group leadership. The empirical base is less robust because of the absence of a formal manual. Psychodynamic group psychotherapy differs from the Yalom model primarily through the ad-

ditional use of individual transference-oriented interpretations.

In terms of group composition, GCBT and IPT-G both focus on specific diagnostic clusters. Within the large encompassing criteria defined in the columns of the table, there is a multitude of formal adaptations for different target populations. The Yalom and Psychodynamic models tend to focus on goals related to interpersonal issues and to select members for a particular group on the basis of their level of interpersonal functioning.

Recent strong evidence indicates that patients with higher levels in the quality of their intimate relationships do better with an interpretive approach, whereas those with more imbalanced or chaotic levels of interpersonal relationships do better with a supportive approach. The interpretive group model focuses on unconscious processes and early relationships that is designed to increase anxiety and regression, and the supportive group model emphasizes basic group common factors such as universality, altruism, and cohesion and focuses on adaptation to the patient's current life. More interesting, these same studies found that the level of psychological mindedness predicted better outcome in both supportive and interpretive models.

In the remaining rows in the table, it is clear that support groups have their own unique features. For the other four columns there is a general trend from left to right for lower therapist activity, structure, and homework, and higher process focus and affect evocation. Mediating strategies move from external to internal focus.

To take depression as an example, GCBT groups emphasize a detailed examination of symptoms. The goal is to identify and change negative thought patterns that are a major feature of the illness. For panic disorder, there is a focus on learning control of the physiological symptoms and challenging the tendency to avoid anxiety-producing situations. Specialized protocols are used for other anxiety subcategories such as phobias and obsessive-compulsive disorder. IPT-G groups place the major focus on the quality of relationships and general socialization patterns with some attention to the origins of these difficulties. Yalom and Psychodynamic groups will focus in detail on relationship patterns and to varying extent on internal conflictual tension. Intensive personal therapeutic work with applied application to outside circumstances is anticipated in all these types of groups. GCBT generally uses specific homework assignments whereas the other models expect current application of change to be reported back into the group. This expectation of personal responsibility

TABLE 1
Comparison of Time-Limited Group Models

<i>Model features</i>	<i>Support groups</i>	<i>Group cognitive-behavioral therapy (GCBT)</i>	<i>Interpersonal therapy for group (IPT-G)</i>	<i>Yalom model interpersonal psychotherapy</i>	<i>Psychodynamic group psychotherapy</i>
Time frame	Open ended	Time limited	Time limited	Time limited	Time limited
Group entry	Open	Closed	Closed	Longer term	Longer term
Composition criteria	Variable, often by condition or circumstance	Common diagnosis or situation (i.e., binge eating, depression)	Common diagnosis or situation (i.e., binge eating, depression)	Open/closed	Open/closed
Formal pregroup preparation	Low	Moderate/high (Incorporated into early sessions)	High (Incorporated into early sessions)	Common interactional capacity	Common interactional capacity
Therapist style	High activity	High activity	Moderate activity	Low/moderate	Low/moderate
Group structure	Moderate/high	High (Programmed sessions)	Moderate (Problem areas/goals established and actively kept in focus)	Low/moderate	Low/moderate activity
Extragroup socializing	Encouraged	Permitted, perhaps encouraged	No	No	No
Process focus	Variable	Low group process focus; (managed to preserve a teaching environment)	Moderate group process focus (managed to preserve group integrity, not interpreted)	High "here-and-now" group process focus (interpreted re interpersonal conflict)	High "here-and-now" group process focus (interpreted re interpersonal and intrapsychic conflict)
Homework	Informal	Written homework and behavior change expected	Changing interpersonal/social patterns expected	Not formally prescribed	Not formally prescribed
Mediating strategies	Variable: Adapted to the common composition criteria	Identify and block negative cognitions	Identify and alter current interpersonal/social coping	"Here-and-now" interpersonal learning existential awareness	Identify and understand interpersonal and intrapsychic conflicts
Focus on affect	Variable	Low/moderate	Moderate (identification of excessive or blocked affect re current interpersonal tensions)	Moderate/high	Moderate/high

in the therapeutic process contrasts with the use of medication.

It is common to find a combined approach of medication and psychotherapy. Again using depression as an example, some symptomatic relief is expected in the first couple of weeks whereas the impact of psychotherapy becomes more evident by the beginning of the 2nd month.

IV. DESIGNING PROGRAMS

There is an increasing interest in the development of group programs in larger service systems. A larger flow of patients provides the opportunity to develop group programs for the most frequent diagnostic populations. Efforts to implement group programming often have had difficulties largely due to a failure to develop a comprehensive program. Nonetheless, the current focus on the development of organized service systems for a defined population base provides an opportunity for a resurgence in the use of group psychotherapy models. To maximize this opportunity it will be necessary to address potential resistance in both the attitudes of clinicians and the organization of service systems. The present health care context contains many of the same accessibility pressures that occurred during wartime and with the development of community mental health clinics. These periods were times of great enthusiasm for groups. For similar service demands and economic reasons, there are again strong pressures to treat a given clinical population in the most cost-effective manner.

There is a well-established literature concerning the way in which patients use psychotherapy services. Much of this information dates back before the major changes in health care delivery of the 1990s decade in the United States. In practice most patients attend relatively few sessions. By the end of 2 months, almost all service systems indicate that only about 20% of those entering will still remain in active treatment. Once this remaining cohort has reached the 6-month point, it is likely that attendance will continue for a longer period. It is worth noting that this curve is based on data collected prior to the major impact of managed care systems.

Empirical outcome studies have been quite consistent in their findings. Most patients respond quite quickly to formal therapy with over 50% improvement within the first 2 months. The rate of response continues to rise, though at a somewhat slower rate over the next 4 months so that by the 6-month point there is a 75% response rate. By the end of 2 years the improvement curve has risen slowly to 85%. This curve re-

flects an impressive response to psychotherapy, better than many medical treatments. This perspective on the predictable rates of change of a larger clinical population is a valuable guide in the development of clinical service programs.

The first step in designing a group program is to address the large percentage of patients who present with acute stress-precipitated depression and anxiety, generally more than one half of new assessments. This population can be effectively managed with therapy of up to about eight sessions. The brief time and the high turnover rate make this category less than ideal for the use of groups. However, several specific models have been developed for this purpose using crisis intervention theory. For example, a rapid access group may meet weekly, or more often, with an expected change in membership every session. The sessions are highly structured with a series of go-arounds so individual members are mainly the focus, with the group offering feedback, ideas, and encouragement. Practical goals will be set for each member to work on between sessions. A limit is set for maximum attendance, probably not more than eight sessions, but these may be spread over 3 or 4 months. Such groups are designed for supportive work to address a current issue, not for exploratory psychotherapy. The leaders need to keep this in mind even though the group may become surprisingly evocative at times. This type of group has much in common with inpatient ward groups. Referral criteria would need to specify that the group is not able to contain serious acute potential for self or other physical harm. Experienced co-therapists are indicated, at least one of whom should be quite knowledgeable about community mental health resources. This is not a group for neophyte leaders.

The next segment of a group program would deal with more intensive but time-limited groups in the 12- to 20-session range. This is the range that has been applied in most of the formal individual and group time-limited literature. More ambitious intensive therapy goals can be addressed. All time-limited models emphasize the importance of establishing specific goals. An active therapist stance is required to keep to the focus and still maintain a strong working alliance. This requires a careful assessment process to develop a collaborative agreement about focus as well as to prepare and motivate the patient for therapeutic work.

Time-limited groups should be developed for the most common diagnostic categories. Most of these models are relatively complex, and specific training in both the model and its application in a group format is required

for their successful application. Groups may also be formed, not so much by diagnosis, as by situation. Examples of these would be grief groups, divorce/separation groups, and preretirement groups. These groups vary in their balance between group process and leader-centered informational content. The therapist needs to be clear about what model is being used.

General interpersonal groups share many of the techniques of the just-mentioned groups but place more emphasis on learning from the group interaction. This approach is particularly helpful for issues of self-esteem and entrenched dysfunctional interpersonal patterns. Assessment procedures would focus on the more complex issues involved. Although these assessment procedures are based on an understanding of earlier childhood experiences, the application of them is maintained primarily on current situations. These groups offer more possibilities of process complications and require leaders who are experienced in such techniques.

Finally, a range of groups dealing with specific topic areas in an educational/skill development format may be considered. Although the range of possibilities is large, some examples would include eating disorder psychoeducational groups, stress management groups, assertiveness training groups, family communication groups, and childhood development groups. These formats make less use of the group process and tend to be leader centered. Nonetheless, the group format provides general properties of the supportive therapeutic factors that reinforce motivation and amplify learning. Leaders require less intensive training in group therapy but must be alert to group management problems. Ready access to clinical supervision is advised.

This leaves a much smaller number of patients with more severe levels of dysfunction often involving longstanding characterologic features or treatment resistant conditions. Group methods are particularly appropriate for this population as the group format provides a strong containing quality that serves to dampen reactivity. Longer time frames would be appropriate, often in the 6- to 8-month range. There is a double goal in these programs. First is active treatment, and second is to decrease use of intensive treatment services such as acute admissions and emergency room presentations. Some programs have had success with long-term maintenance programs for this population.

Most communities have support groups for many conditions. These are generally adapted over time to address the specific features of a condition. The most familiar and largest example of this is Alcoholics Anonymous with the emphasis on abstinence and the need to address

the alcoholic's sense of personal power by insistence on the acceptance of being subject to a higher power. It is recommended that the professional clinician be familiar with support group resources in the community and maintain a collaborative referral relationship and be available to self-help organizations when their members present with problems beyond the group's capacity to manage. It is also recommended that the self-help strategies be respected and that there not be efforts to turn them into amateur clinicians, a move that would undercut their value as self-help leaders.

This emphasis on specific models has a sound rationale. The use of a group format and the imposition of a time limit combine to pose limitations on what can be accomplished. Specific models provide clear guidelines to follow that are generally outlined in clinical manuals. These serve to keep the therapist on track, and outcome research indicates that following such guidelines results in more predictable positive outcomes. Most manuals primarily deal with positioning strategies for the therapist, leaving reasonable room for clinical flexibility. Some of these use a classroom atmosphere that provides greater emphasis on the learning of designated material. It is likely that clinicians will be increasingly expected to justify their choice of model in the light of empirical knowledge, as well as their competence to provide it.

V. SUMMARY

A. Group Programming

It is likely that the development of expanded group programs will become widespread in larger treatment systems. In this process, it is important that care be taken in matching patient characteristics to the programs available, or perhaps more important, that programs be developed for the sorts of problems presented by the patients. There are clear indications that many administrators favor tightly controlled models with scripted sessions. These can be conducted by therapists with less training and are easier to document. As a counterbalance to this, patients are becoming increasingly knowledgeable and outspoken about the sorts of treatments that are available and the indications for their use. In the long run, this is likely to serve as an important influence on program development.

There is reasonable evidence that longer-term treatment or maintenance programs can significantly reduce utilization of intensive resources. However, at the same

time, clinicians need to recognize that the majority of patients do well with much shorter treatment. This reflects in part a truly unfortunate but major split in the group psychotherapy community between a dedication to longer-term process-oriented approaches for senior clinicians in the field, and training in only quite structured models for many clinicians entering the field.

B. Group Research

There has been a remarkable increase in the quality of group research over the last decade. The importance of early group cohesion and a positive therapeutic alliance (to both the group and the leader) are now well established and need further investigation only in relationship to other variables. Similarly the concept of group development has substantive support in the time-limited closed group clinical literature with modest support regarding prediction of outcome. It is no longer possible to claim that process-oriented groups have little or no empirical validation as often stated in the service literature. An intensive psychodynamically oriented milieu program has demonstrated significant response for patients diagnosed with borderline personality disorder and other personality disorders. The clinical belief that patients with more severe functional status do better with a supportive approach has been validated, but also that those patients functioning at a higher level of interpersonal relationships do better with a dynamically informed interpretive approach of a time-limited nature. The value of structure in the early group has been reconfirmed as well as the importance of identifying at an early point, preferably during assessment, important issues to serve as a focus for treatment.

This research foundation can be developed further with attention to several research strategies. The nature of the group process is an important variable in all types of groups and needs to be regularly reported. Several studies indicate that aspects of the group process predict outcome as well or better than the hypothesized technical strategies in structured groups. Given the general positive outcome in almost all groups studied, a focus on linking patient, therapist, and process variables should now be of high priority. Assessments of characterologic traits predict outcome in relationship to therapeutic strategies, but there is much more to be learned about these phenomena. Single-point assessment of group process is not of value, sequential measures are necessary to be meaningful. External ratings from video/transcript sources are

needed to balance the current preponderance of member and therapist ratings. Leadership/therapist studies are weak and few between.

C. Group Training

Given the earlier program and research scenarios, to equip clinicians entering the field there are several guidelines concerning the nature of group training programs. It seems absolutely crucial that clinicians be prepared to apply a range of group models. There is overwhelming evidence that both structured and process-oriented formats are effective. On the structured side, expertise in applying cognitive and behavioral strategies is required. These have demonstrated effectiveness for depression, anxiety, and eating disorder syndromes, the most common presenting complaints. However, it is also evident that applying these techniques in a group setting benefits from an applied knowledge of group dynamics. This is particularly relevant to the early group where the development of a cohesive working atmosphere enhances outcome.

In terms of dynamically informed process-oriented group therapy the effectiveness literature is equally strong. Clinicians should be particularly trained in the indications for use of supportive versus interpretive models. Personality disorders also respond to the process-oriented approach. Many day/evening/inpatient milieu programs use a combination of structured modules and process-oriented groups. These programs generally use the same therapists for both components. This has a strong added advantage that the therapists will be acutely aware of the different strategies being employed and can implement them in a knowledgeable manner.

Group training needs to be grounded in basic group theory that applies to all types of groups. This is most effective when it is actively related to clinical technique and therapeutic strategies. Training should also involve an experiential component as a member of a group. This does not imply the need for treatment, but rather the importance of appreciating the power of group process on the individual. It is of great value in understanding the response of members to group events and to be aware in advance of possible situations in which interventions may be required. An experienced individual therapist may not necessarily make the transition to group therapy easily. Group therapy makes use of the group as a therapeutic agent, and the individual therapist may experience a sense of loss at the greater therapeutic distance from the individual members.

Therapists may also feel a loss of control of the therapeutic process. The same issues arise if a program therapist is supervised by a senior clinician who is not familiar with group theory and practice.

See Also the Following Articles

Anxiety Disorders: Brief Intensive Group Cognitive Behavior Therapy ■ Behavioral Group Therapy ■ Cognitive Behavior Group Therapy ■ Individual Psychotherapy ■ Psychodynamic Couples Therapy ■ Psychodynamic Group Psychotherapy ■ Self-Help Groups ■ Supportive-Expressive Dynamic Psychotherapy

Further Reading

- Alonso, A., & Swiller, H. I. (Eds.). (1993). *Group therapy in clinical practice*. Washington, DC: American Psychiatric Press.
- American Group Psychotherapy Association. This organization, through its national affiliate societies, provides information, programs and a journal about group psychotherapy. New York, NY 10010.
- Bernard, H. S., & MacKenzie, K. R. (Eds.). (1994). *Basics of group psychotherapy*. New York: Guilford.
- Burlingame, G., MacKenzie, K. R., & Strauss, B. (2002). *Group therapy*. In M. Lambert, A. E. Bergin, & S. L. Garfield (Eds.) *Handbook of psychotherapy and behavior change* (5th ed.). New York: John Wiley & Sons.
- Fuhriman, A., & Burlingame, G. M. (Eds.). (1994). *Handbook of group psychotherapy: An empirical and clinical synthesis*. New York: John Wiley & Sons.
- Kaplan, H. I., & Sadock, B. J. (Eds.). (1993). *Comprehensive group psychotherapy* (3rd ed.). Baltimore: Williams & Wilkins.
- MacKenzie, K. R. (1997). *Time-managed group psychotherapy: Effective clinical applications*. Washington DC: American Psychiatric Press.
- McKay, M., & Paleg, K. (Eds.). (1992). *Focal group psychotherapy*. Oakland, CA: New Harbinger.
- Rutan, J. S., & Stone, W. N. (1993). *Psychodynamic group psychotherapy* (2nd ed.). New York: Guilford.
- Wilfley, D. E., MacKenzie, K. R., Ayres, V. E., Weissman, M. M., & Welch, R. (2000). *Interpersonal psychotherapy for group*. New York: Basic Books.
- Yalom, I. D. (1995). *The Theory and Practice of Group Psychotherapy* (4th ed.). New York: Basic Books.

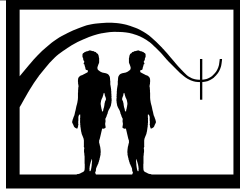

Guided Mastery Therapy

Asle Hoffart

Research Institute, Modum Bad and University of Oslo

- I. Description of Treatment
 - II. Theoretical Bases
 - III. Empirical Studies
 - IV. Summary
- Further Reading

GLOSSARY

defensive behaviors Behaviors that people use to cope with an activity about which they do not feel confident and that limit the proficiency and/or flexibility of performance.

self-efficacy Peoples' beliefs in what they can do and how strongly they believe it.

Guided mastery therapy is focused on changing clients' self-efficacy. This article will present the treatment process, the theoretical bases of guided mastery, and its empirical bases.

I. DESCRIPTION OF TREATMENT

A. General Strategy

Guided mastery therapy focuses on changing clients' self-efficacy, that is, the clients' beliefs in what they can do and how strongly they believe it. It is assumed that actual performance or nonperformance of challenging

tasks is the most potent determinant of the self-efficacy related to these tasks. With this emphasis on performance, it is not surprising that guided mastery first and foremost has been used in the treatment of the anxiety disorders, which are characterized by avoidance and other performance deficits. This presentation of guided mastery will therefore concentrate on the use of guided mastery for anxiety-related problems and largely be based on Stuart Lloyd Williams' formulation published in 1990.

In guided mastery, agoraphobic clients are assisted and guided as they enter grocery stores, enter freeways by car, or ride the bus; height phobic clients are helped as they enter a balcony of a tall building; and social phobics are guided to order and eat in a café. The therapist acts as a field expert, not only encouraging clients to perform tasks, but also guiding performance according to the principles of the self-efficacy model. The overall principle is to promote a positive feedback circle between performance and self-efficacy. Tasks are selected and structured so that they may lead to a maximal increase and generalization of self-efficacy, leading to further improvements in performance. Therapists remain alert to the actual performance of each client as well as to the way clients process the experience. For enhancement of self-efficacy, it is important that clients attribute performance successes to their own capabilities and not to external circumstances or aids. Therapists guide clients to perform progressively more difficult tasks as rapidly as possible according to

the principles: first to increase their level of performance, then to increase their proficiency and flexibility of performance, and, finally, to stimulate independent performance.

B. Case Example

The typical course of treatment is illustrated in the following example: Per suffers from severe bridge phobia. He is not able to walk or drive a car across bridges. When he is reminded of bridges or sees a bridge, he engages in vivid imagery of himself falling from the bridge. As a first task, Per agrees to walk accompanied by the therapist to the start of a 100 meter long bridge that crosses a river. The bridge is equipped with a lane for pedestrians and has 1 meter high railings on both sides. Next, Per agrees to walk 10 meters onto the bridge with the therapist walking beside him holding his arm. After successful completion of this task the therapist models the behavior unaccompanied and asks Per to do the same. After several intermediate steps, Per is able to walk alone to the middle of the bridge, which is his most feared place. His performance is awkward and restricted; still he tenses his muscles, stares at a distant point, and avoids moving close to the railing next to the river. The therapist models more appropriate behaviors and instructs Per concerning their performance: "Relax your legs, feel the ground under your feet." Before and after each task, self-efficacy is probed on a 0 to 100 percent certainty scale. Also, 0 to 10 scaled anxiety ratings are collected, especially when working with the awkward and restricted behaviors. Finally, Per is able to perform the criterion task: to lean over the railing and look into the water, holding his hands behind his back.

C. Increase Performance Level

The example illustrates several of the techniques used as part of the strategy to increase performance level rapidly. The main purpose of joint performance is to promote self-efficacy by reassuring clients that assistance is available if they should lose control. Thus, clients usually do more when accompanied than they would have been able if initially asked to engage in these behaviors by themselves.

Therapeutic tasks can be modeled overtly and through verbal coaching. The therapist in the example both demonstrates how to perform the difficult task and verbally coaches the client concerning awkward and restrictive behaviors. When people have difficulty initiating treatment behavior, treatment tasks are

divided into more easily achievable subtasks. Performance of each subtask is set as a proximal goal. The *setting of proximal goals* enhances self-efficacy by making clear what has to be done, by making performance successes possible, and by providing immediate feedback of success upon subgoal attainment. Therapy may also involve graduated exposure to treatment settings. In the case of Per, for example, after successfully confronting the 100 meter bridge, he would be encouraged to use a larger bridge. Additionally, the technique of giving physical and mechanical support is illustrated by the therapist holding Per's arm the first time he walks onto the bridge.

D. Increase Proficiency and Flexibility of Performance

Anxious people typically engage in defensive behaviors to help themselves cope with an activity about which they do not feel confident. Such behaviors may include clinging to the shopping cart when in a supermarket, holding one's breath at tense moments, or—as Per did—tense his muscles and stare at a distant point when walking on a bridge. In this way, people limit their proficiency and flexibility of performance. Proficiency of performance refers to the ability to perform without defensive rituals. Flexibility refers to the ability to do tasks in varied ways, without self-restrictions on the range of performance. It is assumed that these defensive behaviors maintain a state of low self-efficacy because they prevent the person from receiving positive feedback, as well as the belief that performance successes are due to the defensive behaviors and not to their own effectiveness. This conceptualization is explained to patients as a rationale for dropping these behaviors. Defensive behaviors are identified by observing clients' performance and by asking what they do to help themselves cope with the threatening activities. It is amazing how quickly anxiety arousal often declines on dropping defensive behaviors. Anxiety ratings provide a sensitive moment-to-moment indication of progress, and are particularly useful when working with defensive behaviors.

E. Stimulate Independent Performance

Initially, guided mastery involves accompanying patients into feared situations and providing assistance and guidance. This ensures that clients actually initiate therapeutic activities, that they progress rapidly, that the

therapists can observe the use of defensive behaviors, and that the therapist can immediately assess the clients' cognitive processing of performance information. However, the goal of therapy is for clients to become confident that they can function without assistance. To promote independent performance three principles are followed. First, the lowest level of assistance necessary for success is provided. Clients are accompanied and assisted only on tasks they would find difficult to do on their own. Second, assistance is faded out as soon as possible. Finally, patients are trained to be their own therapists. The principles of guided mastery are explained to the patients during therapy in order to enable them to apply the guided mastery approach on their own. The principles may also be discussed in group sessions with patients receiving guided mastery.

F. General Aspects

Performance levels are raised because proficiency and flexibility in coping behavior tend to increase as a by-product of each success. Therapists collect self-efficacy ratings (0–100 certainty) both before, during, and after performance in order to select appropriate tasks and to examine how mastery experiences have been interpreted by clients. As regards the therapeutic relationship, the guided mastery therapist adheres to the humanistic principles that are typical of various forms of psychotherapy: to show an optimal amount of empathy, warmth, and respect. The style of therapy is collaborative rather than directive and confrontational.

II. THEORETICAL BASES

Guided mastery therapy is based on self-efficacy theory. This theory holds that cognitive processes play a dominant role in the acquisition and retention of new behavior patterns. New behaviors may be learned by observing others. The effect of the model's behavior also influences learning. Efficacy expectations are distinguished from outcome expectations. An efficacy expectation can be defined as a person's conviction that he or she can successfully execute the behavior required to produce certain outcomes, whereas an outcome expectation is the estimate that a given behavior will lead to a specific outcome.

A main assumption of the self-efficacy model is that psychological procedures, whatever their form, serve as a means of creating or strengthening expectations of personal efficacy. Self-efficacy may be affected by verbal persuasion, vicarious experience (seeing another person

cope with the task), imaginal enactment (imagining oneself doing it), or emotional arousal, but direct performance accomplishments are believed to provide the most convincing evidence that one possesses the needed abilities. Thus, although the self-efficacy model is based on cognitive processes, it postulates that change is achieved mainly through behavioral performance.

Performance inhibitions and deficits are obvious features of anxiety, and, as mentioned above, the self-efficacy model has been applied to the analysis and treatment of anxiety disorders. People perceive threat and become anxious when they believe that they are powerless in the face of a threatening stimulus. This belief may either be based on efficacy or on outcome expectations: People can experience threat because they lack a sense of efficacy in achieving the behavior required to avert the dangerous events, or because they believe that the events are uncontrollable. Theorists from various orientations generally agree on these statements. However, self-efficacy theory also claims that anxiety and anxiety disorders are primarily maintained by low self-efficacy that one is able to exercise personal control, and not by beliefs that the threatening events themselves are uncontrollable. Recently, the concept of self-efficacy has been extended to covert activity. It is supposed that an individual's perceived ability to control and dismiss scary thoughts may be an important determinant of anxiety.

This general view of anxiety is reflected in self-efficacy models of specific clinical disorders. For instance, the self-efficacy model holds that agoraphobia is maintained by beliefs that one lacks the capabilities required to perform the feared activities. Low self-efficacy is maintained by avoidance behavior and by performing feared activities in an awkward and restricted way. By contrast, cognitive therapy models hold that agoraphobia results from catastrophic misinterpretations of bodily sensations. Agoraphobic avoidance is construed as safety behavior, designed to avert the occurrence of uncontrollable events such as having a heart attack or going crazy. Both of these models contrast with behavioral accounts, where agoraphobic avoidance is seen as a way of reducing anxiety and panic. With regard to panic disorder, self-efficacy for exercising control over scary thoughts is suggested as an important target of treatment.

There is an interesting mismatch between the general self-efficacy model of anxiety and the principles of anxiety treatment. In the general model, it is assumed that self-efficacy is enhanced by demonstrations that one is able to behaviorally prevent the occurrence of a threatening, aversive event. In guided mastery practice one relies heavily on demonstrations that one is able to

overcome the tendencies to avoid feared activities or to use defensive behaviors during performance. Direct evidence that one is able to exert personal control over the occurrence of a threatening event is seldom involved. Thus, self-efficacy with respect to overcoming avoidant and defensive tendencies and self-efficacy with respect to behavioral control over threatening events should be conceptually separated. This distinction may lead to more differentiated treatment interventions.

III. EMPIRICAL STUDIES

A core assumption of guided mastery therapy is that performance guided by the principles of the self-efficacy model is more effective than pure exposure treatment, that is, performance without such assistance. For height phobia, driving phobia, and snake phobia, guided mastery has been found to be more effective than mere exposure. With respect to agoraphobia, the results are mixed and less promising. In agoraphobic individuals who could perform the exposure tasks, but only under intense anxiety, performance-related anxiety declined more among those who received guided mastery than among those who received exposure. However, the two groups were not different on a measure of self-efficacy. Another study of agoraphobic individuals with little avoidance but intense performance-related anxiety did not find any differences between a guided mastery condition and an exposure condition. One study has compared cognitive therapy and guided mastery for severely agoraphobic subjects, and found cognitive therapy to be associated with better outcome on several measures 1 year after the end of treatment.

Concerning mediating mechanisms, the self-efficacy model states that phobia-related fear and avoidance behavior are maintained by low self-efficacy. Anticipated anxiety/panic and danger are assumed to be effects of low self-efficacy. Furthermore, the self-efficacy model predicts that changes in self-efficacy will lead to changes in these variables. Several of these predictions have been found for height-phobic patients. With regard to agoraphobia, the findings related to these predictions appear to depend on the research methods used. When ratings of the cognitive variables are anchored in specific behavioral tasks, self-efficacy predicts approach behavior, even when other factors such as previous behavior, anticipated anxiety, anticipated panic, catastrophic beliefs, and subjective anxiety are held constant. Catastrophic beliefs do not predict treatment effects when these other variables are controlled. However, when self-report cognitive measures not an-

chored in specific situations are used, and the analyses are based on the temporal sequence between predictors and outcome, the results are consistent with a cognitive therapy model and inconsistent with a self-efficacy model. Overall, a self-efficacy analysis of agoraphobia has not been clearly supported.

IV. SUMMARY

Guided mastery therapy focuses on changing clients' self-efficacy: clients' beliefs regarding what they can do. It is assumed that actual performance or nonperformance of challenging tasks is the most potent determinant of self-efficacy related to these tasks. Therapists act as field experts, guiding clients to perform problem-related tasks according to the principles of the self-efficacy model. Therapists are alert to the actual performance of clients as well as to the way clients process the experience. For enhancement of self-efficacy, it is important that clients attribute performance successes to their own capabilities and not to external circumstances or aids. Therapists guide clients to perform progressively more difficult tasks in order to increase levels of performance, to increase the proficiency and flexibility of performance, and to stimulate independent performance.

See Also the Following Articles

Efficacy ■ Homework ■ Outcome Measures ■ Panic Disorder and Agoraphobia ■ Self-Control Desensitization

Further Reading

- Bandura, A. (1988). Self-efficacy conception of anxiety. *Anxiety Research, 1*, 77.
- Hoffart, A. (1995). Cognitive mediators of situational fear in agoraphobia. *Journal of Behavior Therapy and Experimental Psychiatry, 26*, 313.
- Hoffart, A. (1998). Cognitive and guided mastery therapy of agoraphobia: Long-term outcome and mechanisms of change. *Cognitive Therapy and Research, 22*, 195.
- Williams, S. L. (1987). On anxiety and phobia. *Journal of Anxiety Disorders, 1*, 161.
- Williams, S. L. (1990). Guided mastery treatment of agoraphobia: Beyond stimulus exposure. *Progress in Behavior Modification, 26*, 89.
- Williams, S. L., Kinney, P. J., and Falbo, J. (1989). Generalization of therapeutic changes in agoraphobia: The role of perceived self-efficacy. *Journal of Consulting and Clinical Psychology, 57*, 436.
- Zane, G., and Williams, S. L. (1993). Performance-related anxiety in agoraphobia: Treatment procedures and cognitive mechanisms of change. *Behavior Therapy, 24*, 625.



Habit Reversal

Raymond G. Miltenberger

North Dakota State University

- I. Description of Treatment
 - II. Theoretical Bases
 - III. Applications and Exclusions
 - IV. Empirical Studies
 - V. Case Illustration
 - VI. Summary
- Further Reading

social support A component of habit reversal in which a significant other is enlisted to help the client control the habit behavior. The social support person prompts the client to use the competing response when the client engages in the habit behavior, and praises the client for engaging in the competing response and for refraining from engaging in the habit behavior.

GLOSSARY

awareness training A component of habit reversal in which the client learns to identify each occurrence of the habit behavior.

competing response training A component of habit reversal in which the client learns to engage in an incompatible behavior contingent on the occurrence of the habit behavior or on antecedents to the habit behavior.

differential reinforcement of alternative behavior (DRA) A procedure in which an acceptable behavior is reinforced so that it will increase and replace a problem behavior.

differential reinforcement of other behavior (DRO) A procedure in which reinforcers are delivered for the absence of a problem behavior during intervals of time.

habit disorder A repetitive behavior that does not typically serve any social function but occurs with sufficient frequency or intensity to cause distress to the client or significant others. Habit disorders include nervous habits (such as thumbsucking, nail biting, hair pulling), tics (such as head jerking, facial grimacing), and stuttering (word or syllable repetition, prolongation of word sounds, blocking).

I. DESCRIPTION OF TREATMENT

Habit reversal was developed by Nathan Azrin and Greg Nunn in 1973 as a treatment for nervous habits and tics. In 1974, these researchers also utilized habit reversal to treat stuttering. In the original study there were four major components to the habit-reversal procedure: awareness training, competing response practice, habit control motivation, and generalization training.

A. Awareness Training

Awareness training consists of a number of procedures designed to teach the client to become aware of every instance of the habit behavior as it occurs or when it is about to occur. The client needs to be aware of each instance of the habit in order to use the competing response contingent on the habit. In the response description procedure, the therapist instructs the client to describe the movements involved in the

habit. In the response detection procedure, the therapist teaches the client to identify each instance of the habit that occurs in session. In the early warning procedure, the client identifies and practices detecting the earliest signs or movements of the habit. In the competing response practice procedure, the client learns to engage in an incompatible behavior for a few minutes to heighten awareness of the muscles involved in the habit. In the situation awareness training procedure, the client identifies the antecedents or circumstances (situations, persons, places) in which the habit is most likely to occur.

B. Competing Response Practice

Through competing response training, the therapist instructs the client to identify a behavior that is physically incompatible with the movements involved in the habit and to engage in this behavior for one to three minutes each time the habit occurs or when the client is about to engage in the habit. The competing response involves isometric tensing of the muscles involved in the habit. The competing response is socially inconspicuous, so the client can engage in the behavior without disruption of ongoing activities. Examples of competing responses include the following. For nail biting, thumbsucking, hair pulling, or any habit involving the hands, the competing response involves holding the hands down at the side and making a fist or grasping objects. For a head jerking tic, the competing response involves isometric contraction of the neck muscles by pulling the chin in and down. For an oral habit such as mouth biting, the competing response involves lightly clenching the teeth. For stuttering, the competing response (called regulated breathing) involves slow, deep breathing with a slight exhale before speaking. The client practices the competing response in the therapy session and is instructed to engage in the competing response any time the habit occurs or is about to occur once the client leaves the session.

C. Habit Control Motivation

With these procedures (including habit inconvenience review, social support, and public display procedures), the therapist attempts to increase the client's motivation to get rid of the habit, thus making it more likely that the client will comply with the treatment procedures. With habit inconvenience review, the therapist reviews with the client all of the ways in which the habit is inconvenient or embarrassing. In the social

support procedure, the therapist calls the client on the phone at regular intervals and provides praise for the client's efforts and success in controlling the habit. The therapist also engages the assistance of a significant other (such as a parent, spouse, other family member, or friend) to help the client succeed in controlling the habit. The social support person praises the client when the habit is not occurring and praises the client for using the competing response. The social support person also reminds the client to use the competing response when an instance of the habit is observed. For young children, the social support person might need to manually guide the child through the competing response if the child does not initiate it independently. In the public display procedure, the client demonstrates his or her control over the habit in front of the therapist and significant others.

D. Generalization Training

The purpose of generalization training is to teach the client how to control the habit in everyday situations. The therapist first has the client practice the competing response until the client is using it correctly in session and then spends up to 30 minutes engaging the client in conversation while the client practices the competing response contingent on the occurrence of the habit. The therapist provides social support during this 30 minutes of practice by praising the client for the correct use of the competing response and reminding the client to use the competing response if the habit occurs and the client does not initiate the competing response independently. The therapist also uses symbolic rehearsal procedures in which the client imagines situations in which the habit typically occurs and imagines himself or herself successfully using the competing response in those situations.

The habit-reversal procedure is typically implemented in a small number of sessions (or one long session) with followup phone calls or booster sessions as needed. For example, in 1998 John Rapp and his colleagues used habit-reversal procedures to treat chronic hair pulling in three adolescents. Following two initial treatment sessions with clients and their parents, Rapp and colleagues then conducted booster sessions in the following months when clients were having difficulty successfully using the procedure. In each booster session, the therapist met with the clients and their parents, reviewing and practicing the procedures. In this study, the habit-reversal procedure was successful with one to three booster sessions.

II. THEORETICAL BASES

The success of habit reversal appears to be tied to the consistent use of the competing response contingent on the habit behavior or in anticipation of the habit behavior. Two mechanisms may be responsible for the success of the competing response in decreasing the occurrence of habit behaviors. One explanation is that use of the competing response contingent on the habit behavior works through a punishment process. One type of punishment involves the application of aversive activities contingent on the problem behavior. If the competing response is an aversive activity, then the behavior it follows (the habit behavior) will be punished and thus decrease in frequency. A second explanation is that the competing response is an alternative behavior that occurs and replaces the habit behavior. After the client learns to engage in the competing response in therapy sessions, use of the competing response is then reinforced by the therapist in the session and by the social support person outside of the sessions. The increase in this incompatible behavior then supplants the occurrence of the habit behavior. Unfortunately, it is not clear which conceptual explanation has the most validity. In all likelihood, the effectiveness of the competing response may be explained by a combination of these mechanisms.

The success of the social support procedure is due to the use of verbal prompts and two forms of differential reinforcement. Reminding the client to use the competing response amounts to a verbal prompt for the correct behavior. Providing praise to the client for the correct use of the competing response involves differential reinforcement of alternative behavior (DRA). The alternative behavior that is being reinforced in the DRA procedure is the competing response. Providing praise to the client for the absence of the problem behavior involves differential reinforcement of other behavior (DRO). In the DRO procedure, also called differential reinforcement of zero rate of behavior, a problem behavior (the habit behavior) is decreased when reinforcement is provided at periodic intervals for its absence.

III. APPLICATIONS AND EXCLUSIONS

Since the development of habit reversal in 1973, the procedure has been used to treat a wide variety of habit disorders in adults and children. Habit reversal has

been applied to motor and vocal tics associated with Tourette Syndrome and other tic disorders. It has been applied to habits involving the hands such as thumb-sucking, nail biting, hair pulling, scratching, and skin picking and to oral habits such as teeth grinding, mouth biting, lip chewing, and tongue protrusion. Habit reversal has also been applied to stuttering exhibited by adults and children as young as 6 years of age.

Because habit reversal requires the client to detect each occurrence of the habit behavior and use a competing response contingent on the habit, habit reversal can be used only by individuals who are capable of understanding the procedure, have the ability to carry out the procedure, and are motivated to use the procedure (they state that they want to stop the habit and are willing to use the procedures). The procedure may be ineffective with young children or with individuals with mental retardation because these individuals may not understand the procedure, may not be capable of carrying it out, or may not want to change their behavior.

Social support procedures may enhance the effectiveness of habit reversal with children when parents are diligent in prompting their child to use the competing response and praising the child for using the competing response and refraining from the habit behavior. However, when habit behaviors such as thumbsucking or hair pulling occur primarily when the child is alone, the parent may be unable to provide social support successfully. In such cases habit reversal may need to be supplemented with adjunct procedures, or other procedures may need to be used instead of habit-reversal procedures.

IV. EMPIRICAL STUDIES

Following the initial studies by Nathan Azrin and Greg Nunn in 1973 and 1974, much research has documented the effectiveness of habit-reversal procedures for the treatment of nervous habits, tics, and stuttering. In addition to showing that habit reversal is effective, researchers have also shown that simplified versions of habit reversal are effective. For example, in 1985 Ray Miltenberger, Wayne Fuqua, and Tim McKinley showed that awareness training and competing response training were effective in treating motor tics exhibited by adults. In 1985 Miltenberger and Fuqua further showed that awareness training and competing response training were effective in the treatment of nervous habits exhibited by adults. In 1996, Doug Woods and colleagues showed that awareness training

and the use of a competing response were also effective in the treatment of tics in children.

A number of researchers have shown that awareness training, competing response training, and use of social support are effective in the treatment of habit disorders in children. For example, in 1993, Joel Wagaman and his colleagues showed that these habit-reversal components successfully decreased stuttering in children, and in 1998, John Rapp and his colleagues showed that these procedures decreased chronic hair pulling in adolescents.

Other researchers have demonstrated the limitations of habit reversal with young children and individuals with mental retardation. In a study by Ethan Long and colleagues in 1999, habit reversal was not effective in the treatment of nail biting and other oral-digital habits exhibited by individuals with moderate to severe mental retardation. However, Long and colleagues found that the addition of differential reinforcement and response cost procedures following habit reversal decreased the habit behaviors for their participants. In these procedures, the participant was surreptitiously observed from another room, and, when the habit did not occur for an interval of time, the researcher entered the room and provided a reinforcer such as candy or money (differential reinforcement). When the habit was observed to occur, the researcher entered the room and removed some of the reinforcers (response cost). Other researchers have also shown that differential reinforcement and response cost are effective procedures when habit reversal fails to decrease habit behaviors in young children.

V. CASE ILLUSTRATION

The following case example illustrates the successful use of habit reversal with a 10-year-old girl, Jennifer, who engaged in chronic hair pulling to the point of having bald areas on her head. Jennifer's mother spent up to 30 minutes every morning fixing Jennifer's hair so that the areas of hair loss would not show, thus preventing Jennifer from being embarrassed at school by the hair loss. By their own report and the fact that they traveled a great distance for treatment, Jennifer and her parents were highly motivated to stop the hair pulling. They attended six therapy sessions over the course of nine days. The therapy sessions were conducted in such a short period of time because the client and her family had to travel a long distance to receive treatment. Outpatient treatment sessions would typically be conducted on a weekly basis.

The first session consisted of a behavioral assessment interview in which the therapist asked questions about the exact nature of the hair pulling, the antecedents of the hair pulling (where and when it happens, circumstances and people present, thoughts and feelings of the client preceding the hair pulling), and the consequences of hair pulling to identify or rule out any form of social reinforcement (e.g., attention) that might play a role in the maintenance of hair pulling. In this initial interview, the therapist also asked about the client's history, onset, course, and severity of the hair pulling, how the hair pulling was affecting the clients' lives, and the clients' motivation to eliminate the hair pulling. For Jennifer, hair pulling occurred in her classroom when she was taking a test or concentrating on other activities, and it occurred at home when she was studying or engaged in sedentary activities such as watching TV or lying in bed. There did not appear to be any form of social reinforcement for the hair pulling, for she often engaged in the behavior without others being aware of it. The initial assessment suggested that Jennifer was a good candidate for habit reversal and that adjunct procedures were probably not necessary. Had motivation been a problem or had there been some form of social reinforcement for the hair pulling, then these problems would have to be addressed with adjunct procedures. The first session ended with a description of the habit-reversal procedure to be implemented in subsequent sessions.

In the second session, awareness training and competing response training procedures were implemented with Jennifer and her parents. The therapist implemented the response description procedure by having Jennifer describe the hair pulling movements and then engage in these movements without actually pulling out any hair. Jennifer described and demonstrated all of the different ways in which she pulled her hair and the behaviors leading up to pulling out a hair strand. These precursor behaviors involved running her fingers through her hair, moving her hair back and forth between her first finger and her thumb, isolating one strand, and pulling the strand of hair with a plucking movement by holding on to the hair at its base. Jennifer demonstrated the behaviors from start to finish, ending with a simulated plucking movement.

After response description was complete, the therapist implemented response detection. Response detection is more difficult to implement with habit behaviors that typically do not occur around other people because clients will not naturally engage in the behavior in the session. Response detection is easier to conduct

with tics or stuttering because these behaviors will usually occur a number of times in the session, providing clients with opportunities to practice identifying their occurrence. With hair pulling (as with thumb sucking, nail biting, and other habits involving the hands) the therapist must have clients simulate the occurrence of the behavior during the response detection component of awareness training. The therapist instructed Jennifer to simulate her hair pulling movements in session about 10 times. During these simulations, Jennifer was told to imagine herself in various situations that she had identified as being antecedents for hair pulling. The therapist also had Jennifer simulate some of the activities associated with hair pulling while simulating the hair pulling movements. For example, she sat at a desk with paper in front of her and simulated taking a test while reaching up to pull her hair, or she sat on the floor against a wall simulating waiting her turn for an activity in gym class at school and simulated hair pulling in that position.

While she simulated the hair pulling movements, the therapist instructed Jennifer to stop at various points in the movement and notice how her arm felt or observe the position of her arm in space as it approached her head. Drawing her attention to the sight and feel of her arm at various points in the movement was intended to heighten her awareness of the hair pulling movement and make it more likely that she would detect the incipient hair pulling movements when they occurred in the natural environment.

The situation awareness training component of awareness training was begun in the first session when the therapist asked Jennifer and her parents to identify all of the circumstances in which hair pulling occurred. It was continued in this session as Jennifer simulated hair pulling in those situations or imagined hair pulling in those situations. Jennifer was also asked to identify thoughts and feelings that were antecedents to hair pulling. However, she could not identify any specific thoughts or feelings that preceded the behavior. It is not uncommon for children to be unable to identify thoughts and feelings as antecedents to a habit behavior; adults have been found to be better at providing such information. It is useful to obtain information on thoughts and feelings as antecedents to hair pulling or other habit behaviors because the occurrence of these thoughts or feelings may then cue the client to engage in the competing response to prevent subsequent occurrence of the habit behavior.

Before the second session was over, Jennifer and her parents were introduced to the concept of the compet-

ing response and the rationale for its use. The therapist told them that the competing response provides an alternative, inconspicuous activity to engage the hands so that the hair pulling cannot occur. The competing response, called the "exercise," was to be a behavior that was physically incompatible with hair pulling, that was easy to carry out, that was inconspicuous so that it did not draw attention to Jennifer, and that could be carried out for at least a few minutes each time hair pulling occurred or was about to occur. After introducing the concept and the rationale for its use, the therapist identified a number of different competing responses that Jennifer might consider using. The therapist then asked Jennifer and her parents to pick a few of the competing responses (or to identify other ones) that they were most comfortable using. Jennifer chose holding a pencil while at school, grasping a cushball while at home, and making a fist at her side to be used when she did not have an object to grasp. The therapist informed Jennifer and her parents that they would discuss the competing response and practice it in the third session.

The third session was devoted to practicing the competing response and social support procedures. Between sessions 2 and 3, Jennifer and her parents bought a cushball and other small items that she might grasp as part of her competing response and brought these items to the session. To practice the competing response, Jennifer simulated the hair pulling movements and then immediately engaged in the competing response for about one minute. After a couple of simulations of the complete hair pulling movements followed by the use of the competing response, Jennifer was instructed on subsequent trials to stop earlier in the hair pulling movement and engage in the competing response. For example, she was to initiate the competing response as soon as her hand touched her hair, as soon as her hand was raised above her shoulder, as soon as her hand was raised above her waist, and as soon as her hand was lifted off of her lap. By engaging in the competing response earlier and earlier in the movement toward hair pulling, Jennifer is more likely to catch herself before actually pulling a hair and engage in the competing response to prevent hair pulling outside of the therapy session.

Jennifer next practiced the competing response contingent on hair pulling movements as she simulated situations that were antecedents for hair pulling. By practicing the competing response while simulating natural situations, use of the competing response is more likely to generalize to natural situations outside

of the therapy session. Within this session, Jennifer practiced 12 to 15 times the competing response contingent on simulated hair pulling with instructions and praise from the therapist. During the course of this practice, the therapist introduced the concept and rationale for the use of social support.

The therapist told Jennifer and her parents that, although it was Jennifer's responsibility to detect each occurrence of hair pulling and use the competing response, she was more likely to be successful if her parents helped her. To help her, her parents must do three things. First, they should prompt her to "do your exercise" if they observed her engage in hair pulling but failed to use the competing response on her own. Second, they should provide praise when they observed Jennifer using her competing response. Finally, they should provide praise when they observed that Jennifer was not engaging in hair pulling, especially in situations that were usually antecedents for hair pulling. After describing the social support procedure, the therapist then instructed the parents to practice the procedures in session. The therapist asked Jennifer to simulate hair pulling without using the competing response a few times so that the parents had an opportunity to prompt her to do her exercise. The therapist then had Jennifer practice her competing response so that the parents had an opportunity to praise her for using it. The therapist also had Jennifer simulate an activity in which she usually pulled her hair and refrain from hair pulling to provide the parents an opportunity to praise her for the absence of hair pulling. The therapist observed the parents use the social support procedures and provided praise and any corrective feedback as necessary. At the end of the session, the therapist instructed Jennifer to use her competing response any time she engaged in hair pulling or was about to engage in hair pulling outside of the session. The therapist also asked the parents to provide social support outside of the session by prompting and praising Jennifer as they had learned in the session.

In the fourth, fifth, and sixth sessions, the therapist and clients discussed their use of the competing response and social support procedures outside of the sessions. The therapist provided praise for reports of accurate use of the procedures and answered any questions about use of the procedures. Additional session time was devoted to further practice of the competing response contingent on simulated hair pulling in a variety of simulated situations and the use of social support procedures by the parents. In the final sessions, the therapist also helped the clients plan use of the procedures in their home and school environments once

therapy sessions were terminated. The therapist and clients discussed Jennifer's typical daily routines at home and at school and planned use of the procedures at high-risk times in both settings. The therapist proposed scenarios that involved problems in implementing the procedures and worked with the clients to identify solutions to the possible problems. Finally, the therapist and clients worked out a plan to enlist the support of Jennifer's teacher as a social support person at school and defined the teacher's responsibilities in that role.

Once therapy sessions were terminated, the clients contacted the therapist at periodic intervals via e-mail and telephone to describe progress and to ask questions. Jennifer and her parents used the procedures consistently with few problems and reported that hair pulling had been almost completely eliminated for the 10 months since the therapy sessions were terminated. Jennifer's hair has grown in so there are no longer any bald areas, and she no longer requires her mother to fix her hair every morning to hide hair loss.

VI. SUMMARY

Habit reversal is a treatment for habit disorders and consists of a number of component procedures implemented on an outpatient basis in one or a small number of treatment sessions. Clients first learn to detect each instance of the habit behavior through awareness training procedures. They then learn to engage in a competing response contingent on the occurrence or anticipation of the habit. Motivation procedures such as social support help clients successfully utilize the competing response to control the habit. Generalization strategies help clients continue to be successful in controlling the habit outside of therapy sessions.

See Also the Following Articles

Classical Conditioning ■ Competing Response Training ■ Conditioned Reinforcement ■ Differential Reinforcement of Other Behavior ■ Negative Practice

Further Readings

- Azrin, N. H., & Nunn, R. G. (1973). Habit reversal: A method of eliminating nervous habits and tics. *Behaviour Research and Therapy*, 11, 619–628.
- Azrin, N. H., & Nunn, R. G. (1974). A rapid method of eliminating stuttering by a regulated breathing approach. *Behaviour Research and Therapy*, 12, 279–286.

- Long, E., Miltenberger, R., Ellingson, S., & Ott, S. (1999). Augmenting simplified habit reversal in the treatment of oral-digital habits exhibited by individuals with mental retardation. *Journal of Applied Behavior Analysis*, 32, 353–365.
- Miltenberger, R., & Fuqua, R. W. (1985). Contingent versus non-contingent competing response practice with nervous habits. *Journal of Behavior Therapy and Experimental Psychiatry*, 16, 195–200.
- Miltenberger, R., Fuqua, R. W., & McKinley, T. (1985). Habit reversal with muscle tics: Replication and component analysis. *Behavior Therapy*, 16, 39–50.
- Miltenberger, R., Fuqua, R. W., & Woods, D. (1998). Applying behavior analysis to clinical problems: Review and analysis of habit reversal. *Journal of Applied Behavior Analysis*, 31, 447–469.
- Rapp, J., Miltenberger, R., Long, E., Elliott, A., & Lumley, V. (1998). Simplified habit reversal for chronic hair pulling in three adolescents: A clinical replication with direct observation. *Journal of Applied Behavior Analysis*, 31, 299–302.
- Wagaman, J., Miltenberger, R., & Arndorfer, R. (1993). Analysis of a simplified treatment for stuttering in children. *Journal of Applied Behavior Analysis*, 26, 53–61.
- Woods, D., Miltenberger, R., & Lumley, V. (1996). Sequential application of major habit reversal components to treat motor tics in children. *Journal of Applied Behavior Analysis*, 29, 483–493.

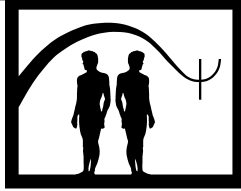

Heterosocial Skills Training

Eric Strachan and Debra A. Hope

University of Nebraska-Lincoln

- I. Description of Treatment
 - II. Theoretical Bases
 - III. Empirical Studies
 - IV. Summary
- Further Reading

GLOSSARY

- chaining** Training an individual to complete a complex, multistep behavior by reinforcing each of the substeps for their occurrence in the proper order (chaining may also be done in reverse, starting with reinforcement of the final step).
- heterosocial** Relating to interpersonal interactions between opposite sex individuals.
- operant conditioning** Training behavior by manipulating an individual's environment. In a simple version of operant conditioning, desired behaviors are increased via reinforcement, while undesired behaviors are decreased via punishment.
- shaping** Training an individual to complete a complex behavior by reinforcing successive approximations of the target behavior.
- social learning theory** A theory of human behavior in which environmental influences on behavior are supplemented by cognitive processes including modeling, imitation, and self-reinforcement.

Heterosocial skills training (HSST) is one of many approaches to improving psychological functioning grounded in operant conditioning and social learning

models of human behavior. Within that context, heterosocial skills can be thought of as the social behavior repertoire necessary for successfully initiating, maintaining, and terminating social relationships with persons of the opposite sex in a socially sanctioned manner. Heterosocial skills training, then, is any effort to introduce, increase, or refine those behaviors in an individual.

I. DESCRIPTION OF TREATMENT

Heterosocial skills training is both easy and difficult to describe as treatment. It is easy to describe because nearly everyone agrees on what general components are required in the intervention. It is difficult to describe because there is no generally accepted definition of heterosocial skill and its behavioral substrates, nor is there a generally accepted notion of when such skills deficits indicate dysfunction. The latter point notwithstanding, however, HSST is a multimethod approach to assisting clients with minimal or maladaptive dating behaviors. A good beginning for heterosocial skill interventions involves identifying a client's specific heterosocial skill deficits and appropriate remedies. Unfortunately, as just noted, there is little general agreement on, and thus no definition of, the particular deficits associated with heterosocial anxiety. One thing that most researchers and clinicians agree on, however, is that heterosocial skill deficits appear to be a mix of behavioral, cognitive, and emotional concerns. As an example, in 1986 Adrian

Furnham indicated that the most reliable heterosocial problems gleaned from studies of self-report questionnaires were fear of negative evaluation (cognitive and emotional concerns) and a lack of an understanding about how to interact with a person of the opposite sex (behavioral concerns). Fortunately, behavioral interventions have been shown to be very effective in myriad disorders that contain cognitive and emotional components. In fact, theorists would predict that acquiring and using new behaviors, both in the therapy room and daily life, would lead to anxiety reduction and perhaps even reinforcement and pleasure. For example, increased enjoyment in heterosocial situations may result in increased positive cognitions about dating situations.

Assessment of potential heterosocial skill deficits usually includes self-report measures and role playing. Representative self-report measures include the Situation Questionnaire (SQ) developed in 1968 by Lynn Rehm and Albert Marston, the Survey of Heterosexual Interactions (SHI) developed in 1975 by Craig Twyman and Richard McFall, and the Survey of Heterosexual Interactions for Females (SHI-F) developed in 1978 by Carolyn Williams and Anthony Ciminero. Each of these measures lay out a variety of heterosocial situations, and clients rate how difficult it would be to handle the situation on a 7-point scale. The SQ and the SHI are both appropriate for men (based on content), and the SHI-F is for women. Other related constructs that might be assessed with self-report are fear of negative evaluation and self-consciousness. The advantages of self-report measures include ease of administration and, so long as clients are honest, a reflection of clients' genuine beliefs regarding their own skills, capacities, and coping abilities. Unfortunately, a number of researchers, both in and out of the social skills world, have indicated that broad, general self-report measures can be poor predictors of actual behavior.

Naturalistic observation and ratings of role-playing exercises may be truer tests of actual behaviors, but these too come with a number of associated difficulties. In 1990, Debra Hope and Richard Heimberg noted that the utility of role plays varies based on whether the role play is assessed via an overall global rating or via specific, easily measured or counted behaviors such as duration of eye contact. Global ratings of social skill made by objective observers, friends, and interaction partners are more likely to correlate with participants' self-reports of dating anxiety than are ratings of specific behaviors. Some investigators have found modest correlations between global measures of social skill and anxiety and certain discrete behaviors (e.g., talk time and eye contact). However, as Ariel Stravinsky indicated in 2000, it

is not entirely clear whether these global ratings have any relation to a person's actual behaviors in real situations. Also, as Hope and Heimberg point out, most studies do not find significant differences between groups of dating-anxious and non-anxious participants on more than a few, if any, specific behaviors. The specific behaviors that do differentiate between groups in one study often will not show differences in another study of similar design. Thus, finding the behavioral correlates of social skill has been difficult.

Several explanations have been advanced to account for the difficulty in assessing social skill. First, a dating-anxious person's social behavior is influenced by the behavior of the interaction partner. For example, in 1985 Stephen Faraone and Richard Hurtig found that anxious men's appropriate verbalizations were less likely to evoke a positive response from female conversation partners than those of non-anxious men. In other words, two men who had the same frequency of appropriate verbalizations had different impacts on their female conversation partners based on how anxious those men felt. Second, considering that most studies of specific behaviors simply count the frequencies of identified behaviors, there is little consideration as to quality of the behavior. It may not be the raw frequency of a behavior that determines its social utility; timing and other aspects of quality may matter more. Such subtle factors may be incorporated into more global ratings. Finally, it seems likely that there is more than one way to be socially skillful. Different individuals may employ dramatically different behaviors, all of which can be effective.

Regardless of these theoretical and practical problems with assessment of social skill, a number of specific behaviors are typically targeted in HSST. According to Jeffrey Kelly's 1982 book on social skills training, the behavioral repertoire should include eye contact, smiling, head nodding, synchronizing facial expressions, laughing, asking conversational questions and making self-disclosures, complimenting, following-up on and acknowledging statements, and requesting dates. Speech duration and voice qualities (pitch, loudness, and flow) were also regarded as important, and other researchers have indicated that behaviors indicating a genuine interest in the other person ("you" statements and questions) are important predictors of peer ratings of social competence. Although we will not go into detail, for assessment purposes each of these behaviors must be clearly defined (operationalized) so as to be accurately counted, and some consideration is due to whether more is better or whether the relationship is curvilinear (too little and too much are both problematic). A clinician attempting

to assess heterosocial skill via role play can increase the accuracy of the ratings by videotaping.

As a final note regarding assessment, it bears mentioning that physical attractiveness appears to play a significant role in peer and other ratings of social competence. Although some aspects of physical appearance are relatively fixed, behavioral interventions are possible at this level, too, and have often focused on clothing style, grooming and hygiene, complexion, weight, and other modifiable aspects of appearance.

Once assessment is complete, as Peter Trower indicated in 1986, a generic HSST protocol consists of instruction, modeling, rehearsal, coaching (including feedback and reinforcement), and homework. Instruction, according to Trower and others, is the process of describing the skills in question and the functions they serve. The skills are broken down into behavioral components to facilitate practice and learning. Modeling takes advantage of the average person's ability to learn from the example of others. Through modeling, clients are able to see the entire sequence of desired behaviors from start to finish with the expectation of adding the pieces they lack in their own repertoire. Modeling can be done by the clinician, through video tapes, recorded dialogue, and prose (more lifelike modeling is preferable). Following instruction and modeling, the client is given the opportunity to rehearse new skills in role plays. The goal is to practice a variety of scenarios until the intervention criteria have been met and continue to be met in novel situations. Throughout the rehearsal phase, the clinician is providing coaching in the form of guidance, feedback, and reinforcement, which can be enhanced with videotape review sessions. The key to rehearsal and coaching is short and frequently repeated role plays that maximize practice opportunities. With each role play, the clinician should positively reinforce what was done well (however much or little that may be) and prompt for new or alternative behaviors where needed. Finally, homework is essential to the transfer of training from the therapy room to the client's daily life. As such, homework assignments usually entail having the client try the new skills in real situations outside the therapy room.

Positive outcome for HSST is a combination of decreased heterosocial anxiety and increased heterosocial competence (both self-report and clinician rated), and improved dating activity in the natural environment. In addition, many learning theorists would suggest that clients should be able to detect when they are performing a particular heterosocial skill or set of skills well versus poorly. In that way, clients can become their own coaches and internalize reinforcement.

Although minimal dating among college students has been the major focus of HSST research, other potential uses have been investigated over the years. For example, a number of researchers have used HSST as an intervention with rapists and child molesters. The basic hypothesis, summed up by William Whitman and Vernon Quinsey in 1981, is that without necessarily ascribing an etiological role to heterosocial skill deficits in sexual deviation, it seems clear that poor social skill constitutes an important clinical problem for many sex offenders such that adopting acceptable heterosexual behavior patterns may help reduce maladaptive, illegal, and violent behavior. In addition, in 1998 Douglas Nangle and David Hansen recommended HSST for adolescents engaging in high-risk sexual behavior. In this application, HSST would be focused on bolstering the skills necessary for adolescents to be competent in enacting the sexual decisions they make for themselves. Application of HSST techniques, then, appears to be limited only by the scope of heterosocial situations.

Although the emphasis here has been heterosocial skills training, there is no reason to think that HSST principles would not apply to same-sex dating situations. Adjustments for any cultural and individual differences can be easily incorporated.

II. THEORETICAL BASES

Without attempting a comprehensive history, it is worth beginning this discussion with a brief history of social skills training (SST) in general. Both the phrase and the approach date back to the 1960s and 1970s when clinicians and researchers working with persons diagnosed with severe and persistent forms of mental illness began to focus on the role of adequate social functioning in recovery and rehabilitation. Reflecting on the development of SST, William Anthony and Robert Liberman noted in 1990 that improvement in the individual's ability to master the challenges and problems inherent in everyday life was an important part of successful long-term rehabilitation. Early SST investigators assumed that, for the most part, patients were trying to do their best; thus, problems in rehabilitation were not grounded in resistance or lack of motivation, but rather in a deficit of some sort (e.g., a skill deficit). In other words, the impetus for SST was the realization that persons battling with severe psychiatric vulnerabilities could be adequately medicated in a seemingly stable environment and still fail to maintain adequate functioning. What was missing, however, was not the motivation or desire for wellness, but rather the skills to act well in the world.

Application of behavioral psychology—particularly the methods surrounding experimental analysis of behavior—to clinical concerns was central to SST's development. Clinicians began to see that behaviors could be developed through shaping, chaining, and other forms of operant conditioning. In the psychiatric hospital, experiments manipulating environmental contingencies led to the development of token economies and other behavioral interventions. Those experiments provided evidence that comprehensive social learning programs (in combination with adequate but not excessive medication) could be more powerful than stand-alone medication regimens and milieu-based interventions. As Clive Hollin and Peter Trower wrote in 1986,

In the history of SST, two ... advances within psychology were crucial. The first of these was renewed interest in the process of human social learning, culminating in a full social learning theory. As well as environmental influences on behaviour, social learning theory also places emphasis on cognitive processes such as modeling, imitation, and self-reinforcement. ... (And), in keeping with the philosophy of learning new behaviours, the movement was also away from a traditional pathology, or "medical," model in which behaviours are to be eliminated, and towards a "constructional approach" in which new, socially acceptable and competent behaviours are trained.

The general concept of SST interventions, then, grew up around the idea that human behavior is flexible and responsive to subtle (and not-so-subtle) environmental contingencies. Abnormal behavior need not arise from a "broken brain," but rather can reflect the normal operations of a contingency-driven behavior regulation system. The earliest SST interventions for social anxiety were based on the presumption that the anxiety is related to deficient verbal and non-verbal social skills that lead to poor outcomes in social situations. Those poor outcomes serve to discourage further social interaction so as to avoid further pain. The proverbial vicious cycle is then created and maintained—avoiding anxiety-provoking situations prevents the acquisition of the skills needed to generate successful social outcomes. Thus, SST interventions were believed to increase these behavioral skills, thus removing the underlying cause of the anxiety and increasing the probability of successful social outcomes.

Heterosocial skills training reflects a multimethod approach, based on the principles elucidated earlier, to assist clients with heterosocial skills deficits. The intervention is intended to build the repertoire necessary for successful dating outcomes. Note that referring to heterosocial skills deficits as minimal dating is not

meant to undercut its importance. Establishing intimate social and sexual relationships is an important goal for most people, and some authors have argued that failure to do so in adolescence is a major precursor of serious psychological disorders in adulthood. In addition, minimal dating and dating anxiety are major sources of real-life concern for the population on which most of the research has been done, namely college students. For example, in 1978, Hal Arkowitz and his colleagues reported that 50% of their 3,800-student sample indicated interest in a dating skills program and 31% of the sample claimed to be "somewhat" to "very" anxious about dating. One could probably assume that similar (or perhaps greater) numbers apply to those who have gone through a divorce, been widowed, been involved in inpatient psychiatric care, and so on. Thus, although the research has focused on samples of convenience, the results are likely important for a much broader population.

Consistent with the earlier discussion, the heterosocial skills deficit model assumes that certain individuals lack important components of the behavioral repertoire needed to perform in social situations involving the opposite sex. (As a side note, there are some data indicating that heterosocial skill deficient men tend to be deficient in same-sex interactions as well. That pattern does not appear to be the case for women.) The general result is that anxiety develops and builds in heterosocial situations as a result of rejection or inadequate social performance. That, in turn, leads to avoidance of those situations. In other cases, such as when an individual does not have the skills to find desirable heterosocial situations or attempt to interact within them, social isolation may develop in the absence of anxiety. Several authors, including Randall Morrison and Alan Bellack, have also noted that heterosocial skill repertoires need not necessarily be faulty for a person to suffer in social settings—what appears to be a skill deficit might actually be inadequate social cue recognition. That is, failure in output (inappropriate behavior) may be the product of failure of input (misunderstanding the situation), rather than lacking behavioral capacity. If, as an extreme example, a person mistakes cues of attraction for cues of hostility and acts accordingly, the end result is not likely to be a dream date. Such cue recognition training can be included in HSST.

III. EMPIRICAL STUDIES

In 1998, Nangle and Hansen pointed out that the number of heterosocial skills articles published in major

American psychology journals has declined from a peak of about 15 from 1975–1979 to a low of about 3 from 1990–1994. Reviews of the literature, including the 1977 reviews by Curran and Hal Arkowitz and the 1990 review by Debra Hope and Richard Heimberg mentioned earlier, generally conclude that HSST is effective for improving scores on the various dependent measures used in the research. Unfortunately, the studies are also consistently criticized for a number of reasons. The first is that the dependent and independent variables are not consistent across studies, thus making it difficult to interpret the findings and draw useful generalizations. From an independent variable perspective, participant selection and categorization methods are often poor, consisting, for example, of asking college students about their dating frequency. As several authors have mentioned, this generates a “high-frequency dating” category that might include someone who has gone out on 10 fun and interesting dates with a number of different partners as well as someone who has gone out on 10 minimal dates with a partner whose basic appeal is that he or she is still around after the first few dates. In addition, the studies are criticized because they typically have not included adequate no-treatment control conditions, have assumed generalization of the relevant skills rather than testing for it, have shown small effect sizes, and have inadequate assessment and training of individual-specific skill deficits.

Despite the criticisms, there are a number of sound studies supporting the efficacy of HSST. In 1975 James Curran reported the results of a controlled study in which minimally dating college men and women were exposed to HSST, systematic desensitization (SD), or no treatment. Participants completed self-report instruments and semistructured interactions (with an experimental confederate) both before and after the interventions. The active interventions were in a group format with six sessions (75 min each) over a 3-week period. Specific behaviors (e.g., giving and receiving compliments, listening skills, and nonverbal communication) were targeted by HSST which consisted of instruction, modeling, rehearsal, coaching, and homework. SD participants received a comparable amount of therapist contact with a procedure designed to reduce heterosocial anxiety via graduated exposure exercises. In the control conditions, clients received no treatment at all, or relaxation training not specifically geared toward heterosocial anxiety. The results indicated reductions in self-reports of anxiety and increased social competence as rated in the semistructured interactions for both the HSST group and the SD group, but not for either of the control groups.

Elaborating on those results during the same year, Curran and Francis Gilbert reported a similar study in

which the therapy was an individual format and in which participants kept diary records to monitor “real-life” changes. The design also included a 6-month follow-up. The results were as expected. Self-reports and observer ratings of anxiety decreased from pre- to posttesting for the HSST and SD groups but not for controls. HSST participants were rated as more socially skillful than SD participants and at 6 months the HSST were rated as more socially competent than any other group. Perhaps most important, both HSST and SD participants reported increases in dating activity in their natural environments.

Overall, the results indicate that HSST increases perceptions of social competence and decreases anxiety. SD also demonstrated that ability, but was outpaced by individualized HSST at 6-month follow-up in at least one study. These well-designed studies, which include adequate controls, multifaceted assessment, and at least some follow-up provide a solid foundation for HSST efficacy claims. Although that speaks in favor of specific HSST effects, there is some evidence that simple practice improves heterosocial skills as well. In 1974, Andrew Christensen and Hal Arkowitz were able to generate improvement in both self-report measures and actual dating frequency by randomly pairing volunteer men and women for a number of practice dates; there was no actual training or intervention on the part of the researchers. Participants merely paired up, went out, and in the end reported feeling and acting better in dating situations. In a series of three studies, one each in 1982, 1983, and 1984, Frances Haemmerlie and Robert Montgomery demonstrated that largely unstructured but positively biased interactions with members of the opposite sex was a viable option for treating dating anxiety. Thus, one hypothesis that can be drawn from the literature—one that generalizes across the different active treatment modalities (i.e., SST, SD, practice dating)—is that skill rehearsal in and of itself, structured or unstructured (but in a relatively safe and positive context), plays an important role in overcoming dating anxiety. Of course, not all dating anxiety is alike. For some there will be more pronounced behavioral deficits while for others the skill set will be intact but the presence of dysfunctional cognitions will get in the way of dating success. The relative success of HSST will thus depend on how thoroughly each of these areas has been assessed and incorporated into the intervention.

Regarding the use of HSST as an intervention for sexual deviance, the results indicate that self-reports and observer ratings of social competence increase with treatment compared to control. However, non-HSST methods such as covert sensitization also affect social competence, a surprising finding that may speak to the non-specific effects of structured therapeutic

interactions. The results on actual physiological arousal in target scenarios are inconclusive, and there are no data on the ultimate impact on convicted offenders. Thus, HSST works in its direct application but has not been conclusively shown to affect the related and generally more important constructs of arousal and recidivism.

It is worth noting that other data exist that inform questions of the efficacy of HSST as a treatment for dating anxiety. For example, in 1993 Debra Hope and her colleagues reviewed a number of studies that used SST to treat social phobia. These data are particularly relevant because those studies assumed that social skills deficits underlie social phobia (a diagnostic category under which dating anxiety might properly be subsumed). According to Hope and her colleagues, all the studies reviewed showed skill improvement for social phobics from before treatment to after. Unfortunately, only one of the studies compared SST to a reasonable no-treatment control (specifically, wait-list control) and the results of that study showed no difference between groups.

IV. SUMMARY

This article began with the notion that heterosocial skills are difficult to define and that behavioral deficits

probably interact with other non-behavioral phenomena, especially emotion and cognition, to disrupt dating success in some people. HSST grew out of theoretical interests in social learning theory and approaches that emphasize remediating deficits, not just eliminating symptoms. The weight of the evidence suggests that minimally dating individuals can find assistance with heterosocial skills training. HSST is not the only treatment for minimal dating, given that systematic desensitization and practice dating show similar effects.

See Also the Following Articles

Assertion Training ■ Behavior Rehearsal ■ Chaining ■ Communication Skills Training ■ Operant Conditioning ■ Role-Playing ■ Structural Analysis of Social Behavior

Further Reading

- Curran, J. P. (1977). Skills training as an approach to the treatment of heterosexual-social anxiety: A review. *Psychological Bulletin*, 84, 140–157.
- Hersen, M., Eisler, R. M., & Miller, P. M. (Eds.). (1977). *Progress in behavior modification* (Vol. 5). New York: Academic Press.
- Hollin, C. P., & Trower, P. (Eds.). (1986). *Handbook of social skills training* (Vols. 1 & 2). New York: Pergamon.
- Kelly, J. A. (1982). *Social skills training: A practical guide for interventions*. New York: Springer.

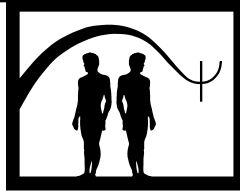

History of Psychotherapy

David Bienenfeld

Wright State University

- I. Earliest Approaches
 - II. The Christian Era
 - III. Rationalism and Moral Therapy
 - IV. The Psychoanalytic Movement
 - V. Ego Psychology
 - VI. The Object Relations School
 - VII. Self Psychology
 - VIII. Postanalytic Schools
 - IX. Summary
- Further Reading

topographic model Sigmund Freud's first model of the mind.

The model described three systems. System Cs, the conscious, contained those ideas and feelings of which a person was overtly aware; system UCs, the unconscious, contained memories, ideas, and feelings which could not be brought into awareness; system PCs, the preconscious, was the reservoir for thoughts that were not in awareness at a given moment, but which could be called to awareness with effort.

GLOSSARY

moral therapy A system of treatment promoted in the early 19th century by Philippe Pinel in France and Samuel Tuke in England. Moral therapy stressed humane treatment of the insane, and use of rational persuasion, occupational activities, and recreational engagement. Moral therapy was most appropriately delivered in the philanthropic, tranquil setting of the asylum.

psychological disaggregation In the schema of Pierre Janet, a lowering of psychological energy and barriers, resulting from psychological trauma, that produced symptoms and other psychological phenomena including paralysis, somnambulism, and trance states.

structural model Sigmund Freud's second model of the human mind, including three mental apparatuses. Id was the domain of unmodified drive impulses and primitive modes of thinking; ego was the executive agent of the mind, using memory, perception, thought, emotion, and motor activity; superego was the repository of parental and societal ideals, morals, and restrictions.

From the dawn of civilization, human beings have been subject to disorders of thought, emotion, and behavior. The assumptions of modern society that such problems originate in the mind are fairly recent concepts. The development of current ideas about human psychological development, the sources of psychopathology, and the place and nature of psychotherapy begin in ancient times. Following their path leads one through the magical thinking of the Middle Ages, the rationalism of the Enlightenment, the drama of the psychoanalytic movement, and the splintering of psychoanalytic thought to modern postanalytic ideas of the nature of mental distress and its treatment.

I. EARLIEST APPROACHES

Although evidence left by preliterate societies seems to tell that shamans dealt with what we would today

identify as mental illness, and although Hindu physicians as early as 1400 BC described various forms of insanity and prescribed kindness and consideration, the beginnings of planned therapy for mental disorders probably lie in Greek culture. Hippocrates was among the first to view mental illness as a natural phenomenon and approach it without superstition.

Priest-physicians, who made Aesculapius their god, enlisted his aid through "divine sleep, divine feasts, the sacred performances." In their temples, called *aesculapia*, they used rest, diet, massage, baths, exercise, and a hygienic life to achieve their desired ends. In particular, they employed a type of mental suggestion called incubation: The patient would lie down on the floor on a pallet. Aesculapius would reveal himself in a dream, which either healed the disease or advised the treatment to be followed. Sometimes the attendants used ventriloquism to aid the patient's conversation with Aesculapius. The god's dictates were interpreted through the personal associations of the interpreter, not the patient. Hippocrates probably worked at one of these temples.

Plato suggested that mental disorders were the result of love, great trouble, and interventions by the Muses. He advised the curative effect of words, their "beautiful logic." Greco-Roman tradition advocated analogous therapies, and suggested innocuous deception to free patients from groundless fears. They did permit and recommend more punitive approaches in severe cases. Later Roman practices, however, focused on herbs and other somatic treatments. With the spread of the Roman empire, the Greek spiritual and psychological methods virtually disappeared.

II. THE CHRISTIAN ERA

The early Christian church, through its first millennium, emphasized the importance of forbearance to pain and the mutability of earthly pursuits. The Middle Ages saw an evolution of faith-healing through organized theology. Through this period, there was no unifying theory of physiology or disease; barber-surgeons and dentists practiced medieval medicine without control or regulation. Magic and alchemy were the science of the time. Mental illness was most often regarded as a defect of spirit divorced from therapeutic intervention.

The Christian era did, however, bring about the development of hospitals with a humanitarian motivation. Religious doctrines of patience, pity, and the possibility of absolution from guilt set in motion a

spirit that would later nurture the development of the precursors of psychotherapy. In the thirteenth century, Pope Innocent III initiated the medieval hospital movement, which brought humaneness and tranquility to the treatment of simpletons and madmen. The monastic tradition of treatment through loving care was directed to those suffering from mental afflictions.

In 1725 the Franciscan monk Bartholomew Anglicus (Bartholomew) wrote *De Proprietatibus Rerum* (Of the Nature of Things). The seventh book of this encyclopedic tome dealt entirely with mental illnesses. For the treatment of melancholics, Bartholomew recommended,

such patients must be refreshed and comforted and withdrawn from cause of any matter of busy thoughts and they must be gladdened with instruments of music and some deal be occupied.

Although Bartholomew spoke for his fellow Franciscans, his attitudes stood in opposition to the inquisitors of France and to the Dominican orders, who aided local courts in adjudicating cases of sorcery and witchcraft, often directed against the insane. The force of the Church's crusade against Satan fell disproportionately on the mentally ill throughout the Middle Ages.

III. RATIONALISM AND MORAL THERAPY

By the 1700s, intellectualism had taken root in Europe as a popular philosophy. Adam Smith, Johann Wolfgang vonGoethe, Jean-Jacques Rousseau, and other philosophical giants pled for the right of man to improve his lot through the application of civilization's accumulated knowledge. In England, the Deists viewed God as more benevolent than the punitive power of their medieval predecessors. Humanitarianism encompassed the aim of improving social relations at large, and hence conferred sanction on emotional and social problems as worthy of philosophical and scientific attention. A similar curiosity about the nature of the human soul became a thread in early neurology and psychology. Medical science, however, was still far too underdeveloped to make much progress even in the milieu of such open-minded attitudes.

By the mid-eighteenth century in England, William Cullen viewed many diseases as the result of neurosis, including insanity, somnambulism, painful dreams, and hysteria. The Quakers, a small but influential group, were instrumental in the treatment of the insane. William

Tuke, a tea merchant, convinced the Society of Friends in 1796 to establish a retreat at York, where the mentally ill could receive care on the basis of the humane spirit of Quakerism. Their afflictions were treated with a regimen of personal encouragement and routine work.

Across the English Channel, the philosophical and political forces that drove the French Revolution in the late eighteenth century also led to the emancipation of the insane from incarceration. Philippe Pinel was particularly influential. Appointed superintendent of the infamous Salpêtrière, a prison for paupers and lunatics, he released the inmates from their chains in 1793, and treated them instead with kindness and respect. Many won their release from the institution. Pinel forbade violence toward the inmates in favor of persuasion. For maniacal fury, for example, he prescribed, "bland arts of conciliation or the tone of irresistible authority pronouncing an irreversible mandate."

In Europe and North America, the nineteenth century was the era of asylums. Germany built institutions at Saxony, Schelswig, and Heidelberg; France featured Bicêtre, Salpêtrière, and Charenton; in the United States, treatment occurred at Bloomingdale, McLean, and the Friends' Asylums. The spread of moral therapy, based in the approaches of the French and English Enlightenment, convinced a number of physicians that insanity could be cured. In 1826, Dr. Eli Todd of the Hartford Retreat in Connecticut reported curing 21 of 23 cases he admitted. Others reported similarly remarkable outcomes. In the flush of enthusiasm that all mental illness could be curable, more asylums were built. Eventually, the statistics were found to be fraudulent and the pendulum swung against the asylum movement. But the door had been irreversibly opened to earlier recognition of mental illnesses and the allocation of resources for their treatment. Drs. Thomas Kirkbridge and Isaac Ray, at meetings of the Association of Medical Superintendents of American Institutions (predecessor of the American Psychiatric Association) between 1844 and 1875 enacted a series of resolutions embodying these evolving attitudes. Insanity, they resolved, is a disease to which everyone is liable, and which is as curable as other diseases. They discouraged the use of physical restraint and advocated activity, occupation, and amusement.

Rudolf Virchow's (1821–1902) cellular theory of disease established the nervous system as the seat of both somatic and mental activity, and brought neurology into the mainstream of nineteenth-century medicine. As a result, the nervous patient became one deserving of medical recognition and attention. Neurologists began to accept hysterics and neurasthenics as patients.

The restrictive social mores of the Victorian era gave rise to no shortage of such patients for care and study. These shifts in patient profile and clinical practice also served to move the insane into the doctor's office and away from exclusive assignment to the asylum.

Among those adventurous enough to undertake the treatment of hysterical patients were two Parisians, Jean Martin Charcot (1825–1893) and Pierre Janet (1859–1947). Charcot, a pathologist, was instrumental in initiating the scientific study of hypnotism. Janet, his pupil at the Salpêtrière, directed his studies toward neurology, and specifically to hysteria. Under hypnosis, hysterical patients recalled long-forgotten memories, suggesting the existence of a separate type of consciousness from that which is active in everyday awareness. Janet believed that trauma led to a "psychological disaggregation," a lowering of psychological energy and barriers, that produced symptoms and other psychological phenomena including paralysis, somnambulism, and trance states. The split-off ideas became "emancipated" from their original stimulus and gained a life of their own as neurotic symptoms. He used hypnosis as a means to enter this other world of consciousness and direct the patient's perception and behavior.

IV. THE PSYCHOANALYTIC MOVEMENT

Charcot and Janet attracted many students from across Europe. Among these was the young Sigmund Freud (1856–1939). After graduating from the University of Vienna, Freud studied the biology of the nervous system under mentors including Ernst Brücke. Unable to support himself as a scientist, he opened a practice in neurology and found himself fascinated by his patients with hysteria. In 1885, he traveled to Paris to study with Charcot and Janet. He learned how to use hypnosis to treat the symptoms of hysteria, but was more interested than his teachers in the stories his patients related while in their trances. Back in Vienna, he found a kindred spirit in Josef Breuer, who believed that the secret to unraveling hysteria lay in allowing them to speak freely about their recollections, a technique that would give rise to free association.

In listening to these tales, Freud went a step further than Janet's psychology of dissociation, and postulated a dynamic quality of the mental apparatus through which unacceptable ideas were split off by some yet-undefined mechanism to reappear as psychological and behavioral symptoms. The recall of these memories

under light hypnosis allowed the repressed emotions to be expressed, resulting in at least transient relief of symptoms. He and Breuer took their first steps to describe the mechanisms of these processes in the cases published as the *Studies in Hysteria* in 1894.

Freud postulated that painful ideas were turned away from conscious awareness to avoid mental distress (unlust, or “un-pleasure”). The ideas were converted into symptoms through pathology that was exclusively psychological, not physiological. He identified repression as a mental activity that had to be overcome. Freud and Breuer eventually parted company over differences of opinion about Freud’s emphasis on sexuality as a driving force behind emotion and behavior.

By 1910, Freud had developed the major ideas that would form the core of psychoanalytic thinking. He identified the unconscious as the seat of most mental activity. He postulated the pleasure principle, which drove the human organism to maximize pleasure while minimizing displeasure. He identified the mental mechanisms that yielded the tales and images of dreams. From these, he extrapolated the mechanisms of psychological defenses. He began to study not only dreams but also parapraxes, wit, obsessions, and phobias for the meaning of their content.

In his first model of the human mind, the topographic model, Freud divided mental activity into three domains: The conscious, which he called the system Cs, contained those ideas and feelings of which a person was overtly aware. More revolutionary was the larger system UCs, the unconscious mind, which contained memories, ideas, and feelings that could not be brought into awareness. The preconscious, the system PCs, was the reservoir for thoughts that were not in awareness at a given moment, but which could be called to awareness with effort. The energy source for this apparatus was the drive. Originally, the drive was considered to be an internal somatic entity, aimed at self-preservation and sexual expression. At this early stage, the only drive was the libidinal drive.

The human organism, Freud postulated, sought to maintain a constancy of pleasure and a minimum of suffering. Drive would seek its own expression, but reality would often impede its attainment of its desires. Under these circumstances, the mind would use memory and dreams to fulfill drive wishes. This model accounted for much, but left many behaviors and emotions unexplained. Two subsequent developments expanded the theoretical and clinical power of psychoanalysis. First, Freud defined a second drive, the aggressive drive, which sought destruction and separation. Second, he augmented the topographic model with the structural model. Now the mental apparatus included the id, ego,

and superego. Id was the domain of unmodified drive impulses and primitive modes of thinking. Ego was the executive agent of the mind and the vehicle for the implementation of drives, using memory, perception, thought, emotion, and motor activity among its tools. Superego was the repository of parental and societal ideals, morals, and restrictions on activity and thought.

This schema allowed for a broad-ranging explanatory model. Drive impulses initiated in the id, demanding satisfaction. Ego would try to gratify id, but might run into limitations of reality or restrictions of society. In such cases, ego would need to turn back and tame the id. This conflict between ego and id could generate a panoply of unpleasant emotions and maladaptive behavior. In the opposite direction, ego’s confrontations with reality on the behalf of id strivings would generate conflicts as well. Superego represented an internalization of those elements of power and judgment from the environment. It provided the mind with guideposts for ideals and restraint. However, superego could thus stand in opposition to ego, generating a different kind of internal conflict.

A. Freud’s Followers

These powerful and revolutionary ideas, articulated by the eloquent and charismatic Sigmund Freud, attracted much attention worldwide, and a dedicated circle of followers in Vienna. Karl Abraham extended Freud’s sketchy ideas about human development into major contributions in the realm of character formation. Such contemporary designations as the easygoing “oral” personality and its controlling, possessive “anal” counterpart, are products of Abraham’s work. Sandor Ferenczi, a passionate follower of Freud, was less interested in pure theory and urged experimentation with treatment. He advocated “active therapy,” in which the analyst would deliberately promote or discourage the patient’s specific activities. He promoted deliberate mobilization of anxiety in the treatment to make it more available for analysis.

B. The Dissenters

Others of the Vienna group found Freud’s ideas inadequate or limiting, and advocated dissenting viewpoints. While Freud dreamed that mental activity would one day be explainable on the basis of neurologic principles, his work remained exclusively psychological. Alfred Adler sought actively for a unifying theory of biologic and psychological phenomena. He postulated the aggressive drive as the source of energy used by an

individual to overcome organic inferiorities through compensation (and hence gave birth to the phrase inferiority complex). Where Freud took sexuality and the Oedipal situation as literal motivations for development and behavior, Adler regarded them more in the symbolic sense. On the technical level, he engaged patients face to face in free discussion, rather than free association on the couch to an unseen analyst.

Otto Rank stressed emotional experiences over the intellectual constructs of psychoanalysis. He postulated that birth trauma was a universal human experience, and that the individual was forever seeking to return to intrauterine bliss. Healthy development could occur when, through later successful experiences of separation, the child is able to discharge this primal anxiety. Pathological states resulted from a fear of the womb and conflict with the wish to return. Rejecting the id and superego, he postulated the existence of will and counter-will as positive and negative guiding influences toward separateness. He ultimately turned his focus away from individual psychology and psychopathology to the realm of art and the soul.

Most prominent among the dissenters was Carl Jung, who originally clung to the Freudian vision in the extreme. Freud became strongly invested in Jung as his protégé and eventual heir to his position in the psychoanalytic movement. Jung began to extend Freudian principles to ideas that had excited him earlier including myth and legend. Freud had certainly done the same, invoking the tales of Oedipus and Electra, and analyzing the art of Michelangelo. But where he saw parallels or analogies, Jung saw a direct continuity of archaic material gathered into the collective unconscious. This storehouse of human experience, he posited, contains primordial images and archetypes that represent modes of thinking that have evolved over centuries. Jung saw Freud's view as too limited. Symbols, which were vehicles for the expression of wish and conflict for Freud, represented for Jung unconscious thoughts and feelings that are able to transform libido into positive values. The techniques derived from these values include active imagination, where the patient is encouraged to draw fantasied images and to associate more deeply by trying to depict the fantasy precisely.

Working at the forefront of the elucidation of the unconscious and the drives, Freud and his immediate successors devoted their efforts to understanding and analysis of the id. The success of their psychoanalytic techniques in addressing previously untreatable problems, brought broad appeal to psychoanalysis, and brought to the analysts patients with conditions more complex than hysteria. Questions of how the id is

tamed and what happens to its drive energy propelled the next generation of theoreticians and clinicians to focus more directly on the ego.

V. EGO PSYCHOLOGY

In retrospect, it is Sigmund Freud's daughter Anna Freud (1895–1982) who is often identified as the first voice of ego psychology. Encouraged by her father to extend the study and practice of psychoanalysis to children, she is best known for elucidating the defense mechanisms by which the ego masters the environment, the id and the superego, and which are the shaping forces of each individual's psychopathology. The names and definitions she assigned are still the benchmark terminology of psychoanalytic psychology: repression, suppression, denial, reaction formation, undoing, rationalization, intellectualization, sublimation, symbolization, and displacement. Still, however, she maintained that analysis of the ego paled by comparison with analysis of the id.

The promulgation of ego psychological theory fell to a generation of analysts who were mostly refugees from Hitler's advance through Europe, and who had to postpone their major work until they could resettle in the 1930s: Ernst Kris, Rudolph Lowenstein, Rene Spitz, and chief among his peers, Heinz Hartmann (1894–1970). A trainee of Freud's, Hartmann undertook the expansion of his mentor's model to explain some of its lingering questions: What was the origin of ego? How did ego tame id, which was powered by the potent energy of the drives? What was the purpose of the aggressive drive? What role did these structures and forces play in normal development?

For Hartmann, the unifying process of human psychological development was adaptation, a reciprocal relationship between the individual and his or her environment. The outcome of successful adaptation is a "fitting together" of the individual with the environment. Conflict is thus neither the cause nor the outcome of psychopathology, but a normal and necessary part of the human condition. In Hartmann's model, the ingredients of ego and id are present at birth in an undifferentiated matrix. Normative conflicts with the environment separate out ego from id. Defense mechanisms are tools for adaptation to the environment by either alloplastic means (changing the environment) or autoplasmic ones (changing the self).

Because psychic structures enable the individual to be less dependent on the environment, structure formation serves adaptation. Superego is one outcome of

adaptation to the social environment, a product of continuing ego development. Id, ego, and superego continue to separate by the process of differentiation. Within the ego, primitive regulatory factors are increasingly replaced or supplemented by more effective ones.

There is also a conflict-free sphere of ego development. Certain capacities have an inherent capacity for expression and growth, promoting adaptation to the environment without need to invoke conflict. In the motor sphere, these capacities include grasping, crawling, and walking. In the mental realm, they encompass perception, object comprehension, thinking, language, and memory.

Ego psychology used the language of Freud's original drive-structure model, and maintained most of its core assumptions. It stretched the explanatory capacities of the model and allowed for the treatment of cases previously impervious to psychoanalysis. Because these patients exhibited more interpersonal problems than strictly intrapsychic ones, and because the model of ego development was contingent on interactions with the personal and social environment, the door was opened to schools of thought that described something broader than a one-person psychology. Even while ego psychology was developing further in the 1930s, the school of object relations was branching off.

VI. THE OBJECT RELATIONS SCHOOL

A. Melanie Klein

Melanie Klein (1882–1960) studied under Sigmund Freud. With Freud's encouragement, she undertook the psychoanalysis of children. Finding the free association technique useless in such young patients, she originated the use of the content and style of children's play to understand their mental processes. Like many early psychoanalysts, she used her observations from the clinical sphere to generate theories of human development and psychopathology.

Klein's earliest papers shared and expanded Freud's emphasis on libidinal issues. The child, she noted, spins elaborate fantasies about food, feces, babies, and other aspects of the mother's body. Attempting to explore these curiosities, the child is inevitably frustrated, resulting in rage and fears of castration. Unlike her mentor, Klein found the seeds of the oedipal constellation in the first year of life as the disruption of weaning precipitates a turn to the father. In her view these urges take on a gen-

ital coloration. The harsh self-criticism that accompanies these fantasies is a precursor of the superego. She eagerly adopted Freud's emphasis on aggression in the 1920s. By the early 1930s, aggression had come to overwhelm all other motives in her schema. Even the seeking of pleasure and knowledge was defined as a desire for control and possession: "The dominant aim is to possess himself of the contents of the mother's body and to destroy her by means of every weapon which sadism can command." The oedipal conflict was recast as a struggle for destruction and power, and a fear of retaliation, rather than a search for forbidden love.

Freud had posited that fantasy was a defensive substitute for real gratification. Klein's elaborate mental processes resided in a world of unconscious *phantasy*, one which is inborn and constitutes the basic substrate of all mental processes. In this world of phantasy, the child houses vivid and detailed images of the insides of the mother's body and his or her own, filled with good and bad substances. He or she becomes focused on attempts to obtain good objects like milk, children, a penis, and to eliminate or neutralize bad objects such as feces.

Over the decade from the mid-1930s to the mid-1940s, Klein elaborated a model of development. The infant's earliest organization, which she called the paranoid position, involves the separation of good objects and feelings from bad ones. Mother is perceived only in terms of her good (providing) and bad (withholding) parts. By the middle of the first year, the infant is able to perceive the whole mother and experiences depressive anxiety as a result of his or her aggressive feelings toward the mother's bad parts. The child attempts to compensate by way of phantasy and reparative behavior. The Oedipus complex is a vehicle for such attempts at reparation.

Klein's ideas represented more than just a furtherance or modification of the Freudian model. They were entirely revolutionary. Klein left Germany in 1925 for England, where she stayed until her death in 1960. Her provocative ideas split the British Psychoanalytic Society, and eventually the entire international psychoanalytic community, as they blossomed into the various theories of object relations.

B. Margaret Mahler

Margaret Mahler (1897–1985) began her career as a pediatrician in Vienna. Like many of her peers, she was fascinated by the theories of the psychoanalytic movement and applied them to her work with children. She soon found, however, that the classical model was unable to explain much of what she observed. The linearity

of the drive structure model failed to encompass the richness and variety of emotional experience of the developing child. Her model instead emphasized the specific relationship between child and mother, and hypothesized that drives are not the root of interpersonal relations, but the result of them.

Just as Hartmann was proposing that id and ego begin in one undifferentiated state, Mahler posited that the child is born with an initial state of undifferentiated energy. It is by virtue of attachment to good and bad self objects that this energy differentiates into libido and aggression. The central theme of the developmental process is the need for the child to differentiate himself or herself from others to achieve autonomy and individuation. Such differentiation requires separation from the object(s), entailing a struggle between the wish for independence and the urge to return to the comfortable state of fusion. Mahler outlined a detailed agenda for psychological development:

1. The normal autistic phase occupies the first few weeks of life. The newborn is oblivious to stimulation, and lacks any capacity for awareness of other objects. He or she sleeps most of the time and is concerned only with tension reduction and need satisfaction.

2. The normal symbiotic phase lasts until about age 4 to 5 months, and is marked by an increased sensitivity to external stimuli. The infant is dimly aware of mother as an external object able to reduce tension. She is not yet a separate object, but rather part of a dual unity. Experiences are either all bad or all good. Nodes of good and bad memory traces form in the undifferentiated matrix of ego and id.

3. The differentiation subphase lasts until about 10 months of age, and begins with what Mahler called "hatching." The child is alert, and begins to search and explore the world beyond the mother-child orbit. He or she acquires the ability to differentiate internal and external sensations. With the developing ability to discriminate between self and object comes the ability to distinguish objects from each other. Stranger anxiety at about age 6 months is a marker of this capacity.

4. The practicing subphase begins with the capacity to crawl. The child's interests extend to inanimate objects. For Mahler, "psychological birth" coincides with the capacity for upright locomotion. The child takes pleasure not only in his or her own body, but also in the acceptance and encouragement of adults. In practicing walking, the child uses mother as home base, going out and returning. For successful completion of this subphase, mother must strike a balance between supportive

acceptance and a willingness to relinquish possession of the child.

5. The rapprochement subphase (15 to 24 months) is marked by the child's realization that he or she is a small person in big world, and that mother is a separate person. Language is a key skill in negotiating these currents, as the child alternates between "wooing" mother with needy clinging and rejecting her with hostile negativity. Mother's reaction is again critical to the outcome of the struggle. Successful resolution of this subphase was as important to Mahler as Oedipal resolution was to Freud.

6. The phase of libidinal object constancy, the ideal outcome of all earlier development, should be reached by age 2 or 3 years. Now the child forms a stable concept of himself or herself and others. These concepts require the unification of the heretofore divided perceptions of good and bad objects. The libidinal and aggressive drives that have become cathected to these dichotomous representations must now be merged. In a context of parental response that reinforces the perception of constant objects, the child is now in possession of stable and adaptable psychic structures for the rest of his or her life.

C. W. R. D. Fairbairn

Both Klein and Mahler elaborated schemes of development and psychopathology that relied on the classical unit of energy, the drive impulse, for their motivation. By the early 1940s, W. R. D. Fairbairn rethought the whole problem of motivation. Like Klein, he saw libido as inherently object-seeking, and conceived of ego structures as powered by object-directed energy. Just as Hartmann had formulated the ego in terms of natural adaptation, Fairbairn saw the roots of relation-seeking in biological survival. All human behavior, he concluded, derived from the search for others. Psychopathology, in this scheme, was not the outcome of misdirected drives, but of disturbed relations with others.

Unsatisfactory relations with real objects (e.g., parents) would lead to the creation by the ego of compensatory internal objects. If the environment is filled with unsatisfying or frustrating objects, the ego becomes filled with so many fabricated objects that it becomes fragmented. Ego then splits this population into good or ideal objects and bad (exciting or rejecting) objects. Splitting of the ego results from the child's attempts to maintain the best possible relations with a suboptimal mother, and continue through adult life if not somehow corrected. The psychoanalytic setting and process provide the opportunity for restoring to the ego a capacity

to make full and direct contact with others, thereby restoring psychological health.

D. D. W. Winnicott

D. W. Winnicott, who produced most of his work between about 1945 and 1970, took the object relations movement yet a step further from the one-person psychology of the classical model. Some of the catch phrases of his terminology have found their way into the everyday language even of those who have heard of their author.

In Winnicott's formulation, the infant begins life unable to integrate the disparate pieces of his or her experience with his or her environment. Mother ideally provides a holding environment for these early experiences. Mother, impelled by biologic dictates of adaptation, is absorbed with her baby for the first few months of its life. When the infant is stimulated (by hunger or cold, for example), he or she conjures up an image of an object to meet those needs. The sensitive and devoted mother provides exactly that object; the infant believes he or she has created it, and finds comfort in this power. This confidence is necessary for the emergence of the individual.

Mother also sees the baby and reflects its emotions and behavior, functioning as mirror of baby's experience. If the baby is seen, then he or she exists. Finally, mother must be sensitive to the developing child's need to be alone in a quiet, unintegrated state at times, in order to integrate experience and to develop a tolerance for aloneness.

By the end of the first few months, the child begins to learn about reality of the external world, and the limits of his or her own power. Reality itself does much of this work, but mother contributes through her gradual withholding of actions shaping the world to her infant's needs. Underlying these interactions is the child's natural push toward separateness. In order to adapt, the child learns to express his or her needs through gestures and utterances.

Mother can fail here in two ways: She may fail to provide hallucinated objects, or she may fail to tolerate the child's formless quiet states. The former failing leaves the child insecure and anxious. The latter fault fragments the child's experience. As his or her personal time is subjugated to parental intrusion, he or she becomes overly attuned to the claims of others, and his or her person fragments into a true self and a false self. The latter force aims toward compliance. The false self protects the true by hiding it, but deprives the child of a necessary sense of authenticity.

A critical tool on this path of development is the transitional object. Such an object, usually illustrated with a teddy bear or blanket, is one that the child believes he or she has created out of imagination to fill a need. The adult ideally does not question its origin, and simultaneously acknowledges its existence in the real world. This deliberate or intuitive ambiguity helps the child negotiate a transition from a world where he or she is at the center to one where he or she coexists with others. Even as the child's views of reality solidify, this configuration is never discarded. It remains a state of mind valuable for creativity and fantasy in healthy adult life.

Interactions in Winnicott's world are based not on drive needs, but on the perceptiveness of the parents and the developmental needs of their child. The gratification of drive derivatives, to which he gives only lip service, are less important than the attitude of the provider. Just fulfilling needs does not allow for the development of a healthy, true self. He redefines aggression not as a destructive drive impulse, but as a general state of vitality and motility. The origin of psychopathology is in conflict, not conflict between aggression and libido, or among drives, psychic structures, and reality, but conflict between the true and false selves. The object of psychotherapy is to free the true self from its bondage and allow the emergence of the genuine person.

VII. SELF PSYCHOLOGY

The theories of object relations were successful in addressing the limited ability of ego psychology and defense analysis to address the problems of those patients whose problems lay deeper than those of the classical neuroses. A different approach to the same challenge gave rise to self psychology. In the 1960s, Heinz Kohut was a prominent figure in the mainstream of psychoanalysis. Erudite, articulate, and charismatic, he was widely assumed to be the heir to Heinz Hartmann's mantle as the leading spokesman for ego psychology. But his disappointment in the limitations of classical and ego psychologies led him to follow his curiosity in a new direction.

Kohut began by redefining the observational position of the analyst. Exploration of the external world, Kohut reasoned, requires an outwardly directed observational stance. Exploration of the internal world, the realm of psychotherapy, requires an empathic, introspective stance. He rejected the objective mechanical formulations of the ego and object relations psychologies, promoting instead a vantage point from within the patient's experience.

Psychopathologies, from this perspective as well as from most object relations perspectives, were seen not as the emergence of oedipal wishes, but as the reactivation of early needs the satisfaction of which in childhood should have served as the basis for healthy development. Self psychology went further to assert that unempathic interventions in psychoanalysis repeated early traumata. Symptoms and unpleasant affects represented fragmentation products of an injured self. Psychoanalysis, then, should properly focus not on the meaning of the products, but on the reconstruction of what precipitated their emergence in the transference, and on the genetic precursors of this constellation.

Whereas the object relations theorists continued at least to pay lip service to the classical drives, and maintained their allegiance to the structural model, Kohut ultimately rejected the need for the constructs of drive, id, ego, and superego. Instead, he formulated normal and pathological development and function around the single notion of the self. The nuclear self, which is present at birth, develops structures that allow it to take over functions previously needed from outside. This structure building happens by maturational transformation of what is internally given, and by the process of transmuting internalization, whereby functions of objects are metabolized into the self.

Self psychology, like object relations psychology, emphasizes the primacy of objects in healthy and pathological mental function. The objects in self psychology, however, are not separated from the self, but exist in the context of a self-selfobject matrix. The selfobject is an intrapsychic concept, describing how the self experiences the specific functions provided by others en route to the attainment of development goals. The need for selfobjects never disappears, but matures from infantile neediness to mature adult intimacy.

The self that emerges was described by Kohut as the bipolar self, bridging two poles. The pole of self-assertive ambitions contains the capacities for self-esteem regulation, the enjoyment of mental and physical activity, and the pursuit of goals and purposes. Its development requires a mirroring selfobject. This pole is paired with the pole of values and ideals, which is associated with self-soothing, the regulation of feelings, the capacity for enthusiasm and devotion to ideals larger than the self. The development of this pole is promoted by an idealizable selfobject. Between the poles there exists a tension arc that gives rise to innate skills and talents, including empathy, creativity, humor, wisdom, and the acceptance of one's own mortality.

Psychopathology results from imbalances between the poles of the self, and these imbalances are themselves the product of deficient selfobject experiences. Psychotherapy identifies these deficits by empathic reading of the transference. Therapeutic correction requires both interpretation of the selfobject needs and their successful reenactment in the therapeutic dyad.

VIII. POSTANALYTIC SCHOOLS

The evolution of classical psychoanalytic theory into ego psychology, object relations, and self psychology was propelled by expanding clinical experience, and by failures of older paradigms to explain a widening circle of psychopathologies encountered in therapy. In the closing decades of the twentieth century, forces outside the boundaries of the psychotherapy drove further changes. The culture of medicine demanded reproducible techniques and empirical validation. Third-party funding and the growing perception of the patient as a partner in the therapeutic enterprise promoted briefer and more active forms of therapy. The two most notable schools to arise in this context have been cognitive and interpersonal therapies.

A. Cognitive Therapy

Cognitive therapy was developed by Aaron Beck at the University of Pennsylvania in the early 1960s. Trained in traditional psychoanalysis, he became impatient with its results, and devised a structured, short-term present-oriented psychotherapy for depression. Other forms were developed by Albert Ellis (rational emotive therapy), Arnold Lazarus (multimodal therapy), and Marcia Linehan (dialectic behavioral therapy).

The cognitive model proposes that distorted or dysfunctional thinking influences a person's mood and behavior, and that such distortions are common to all psychological disturbances. Realistic evaluation and modification of thinking is used to produce rapid improvement in mood and behavior. Enduring improvement results from modification of the core beliefs underlying the dysfunctional thinking.

In practice, cognitive therapy emphasizes the collaboration and active participation of both patient and therapist. It is goal-oriented, problem-focused, and time-limited, but ultimately aims to make the patient his or her own therapist. Highly structured sessions teach the patient to identify, evaluate, and respond to dysfunctional thoughts. By elucidating patterns in

multiple circumstances, cognitive therapy offers the opportunity to change the underlying core beliefs and effect lasting change.

B. Interpersonal Psychotherapy

Interpersonal psychotherapy (IPT) was developed in the 1970s by Gerald Klerman as a time-limited treatment for depression, particularly for use in research. Its initial success in depression led to modifications for subtypes of mood disorders, and for nonmood disorders including substance abuse, eating disorders, social phobia, panic disorder, and borderline personality disorder.

IPT makes no etiologic assumptions about psychopathology, but uses connections between current depressive symptoms and interpersonal problems as a pragmatic treatment focus. The therapist links symptoms to the patient's situation in the context of one of four interpersonal problem areas: grief, interpersonal role disputes, role transition, or interpersonal deficits.

Grief may be the reaction to the loss of an individual, or to a more abstract loss. The therapeutic focus is to facilitate mourning and the establishment of new activities and relationships. Interpersonal role disputes consist of conflicts with significant others. IPT explores the nature of the dispute and the relationship, and helps the patient find options to resolve it. If these efforts fail, patient and therapist look for ways to circumvent the conflict or end the relationship. Role transition, a change in life status, is addressed by helping the patient recognize the benefits and challenges of the new role, the positives and negatives of the old role. Interpersonal deficits are traits and behaviors that prevent an individual from establishing or maintaining satisfying relationships. IPT trains such a patient in means to conduct more successful relationships.

IX. SUMMARY

Before the seventeenth century, insanity was attributed to supernatural influences. Although most responses consisted of religious interventions or extrusion of the sufferer from society, there were always some who sought to provide treatment instead. The rise of the scientific method during the Enlightenment, and the social and political forces of democracy that accompanied, began to foster an inclination to address mental disorders with caring, activity, and communication. In the nineteenth century, the results included moral therapy and asylums.

The closing decades of the 1800s brought the attention of neurologists to illnesses including hysteria and

schizophrenia. Hypnosis represented a first step toward the understanding of mind and brain. Sigmund Freud, the most notable figure in this thread, listened carefully and creatively to the hypnotic recollections of his hysterical patients, and drafted the first theories of unconscious mental processes. Over the course of decades, his thinking evolved into a complex and powerful schema of psychic structures and their functions.

Whereas Freud and his immediate associates focused on the analysis of id urges and drive derivatives, the first generation of successors to the psychoanalytic movement focused on the role of the ego. Anna Freud and Heinz Hartmann elucidated its defensive and developmental features. Psychoanalysis became a more powerful treatment as a result.

The success of psychoanalysis, both in its original drive model and in the form of ego psychology, led practitioners to apply its principles to an ever-expanding patient population, including individuals with pre-oedipal problems, and to children. The result was a rethinking of the role of the human environment in the development of the individual and in the genesis of psychopathology. The object relations school, represented most significantly by Melanie Klein, Margaret Mahler, W. R. D. Fairbairn, and D.W. Winnicott, elaborated theories of human interaction that furthered the explanatory reach of psychoanalysis.

In a later split from ego psychology, Heinz Kohut found classical theories of structure and drive inadequate to explain or treat too many of his patients. Breaking the classical mold completely, he rejected virtually all the underpinnings of classical, ego, and object relations psychologies, and defined self psychology. This system focuses on the development of the bipolar self through the use of selfobjects, and defines all psychopathology in terms of disturbed selfobject functions.

The successes of psychoanalysis bred psychoanalytically based psychotherapies from the 1940s on. By the closing decades of the twentieth century, clinical, scientific, and social forces propelled the emergence of a number of nonanalytic psychotherapies, including cognitive therapy and interpersonal psychotherapy, which focus on contemporary issues of perception and response, while mapping a route to permanent psychic change.

See Also the Following Articles

Behavior Therapy: Theoretical Bases ■ Education: Curriculum for Psychotherapy ■ Oedipus Complex ■ Psychoanalytic Psychotherapy and Psychoanalysis, Overview ■ Research in Psychotherapy

Further Reading

- Alexander, F. G., & Selesnick, S. T. (1996). *The history of psychiatry: An evaluation of psychiatric thought and practice from prehistoric times to the present*. New York: Harper and Row.
- Beck, J. S. (1995). *Cognitive therapy: Basics and beyond*. New York: Guilford Press.
- Blanck, G., & Blanck, R. (1994). *Ego psychology: Theory and practice* (2nd ed). New York: Columbia University Press.
- Brenner, C. (1973). *An elementary textbook of psychoanalysis*. New York: Anchor Doubleday.
- Bromberg, W. (1954). *Man above humanity: A history of psychotherapy*. Philadelphia: J. B. Lippincott.
- Greenberg, J. R., & Mitchell, S. A. (1983). *Object relations in psychoanalytic theory*. Cambridge, MA: Harvard University Press.
- Jackson, S. W. (1999). *Care of the psyche: A history of psychological healing*. New Haven, CT: Yale University Press.
- Ornstein, P. H., & Kay, J. (1990). Development of psychoanalytic self psychology: A historical-conceptual overview. In A. Tasman, S. M. Goldfinger, & C. A. Kaufman (Eds.), *American Psychiatric Press review of psychiatry, Vol. 9* (pp. 299–322). Washington, DC: American Psychiatric Press.
- Walker, N. (1959). *A short history of psychotherapy in theory and practice*. New York: Noonday Press.
- Weissman, M. M., & Markowitz, J. C. (1998). An overview of interpersonal psychotherapy. In J. C. Markowitz (Ed.), *Interpersonal psychotherapy* (pp. 1–33). Washington DC: American Psychiatric Press.

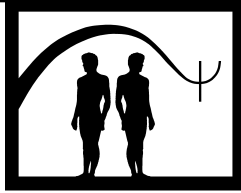

Home-Based Reinforcement

Douglas W. Woods and Michael P. Twohig

University of Wisconsin-Milwaukee

- I. Description of Treatment
- II. Theoretical Basis
- III. Empirical Studies
- IV. Summary
- Further Reading

GLOSSARY

fading The process of gradually removing prompts as the behavior continues to occur in the presence of a controlling stimulus.

interval schedule A schedule in which a reinforcer is made contingent on the passage of a particular duration of time before the first response to occur after that period of time is reinforced, (a) fixed-interval—schedule in which duration is always the same (b) variable interval—schedule in which the time interval varies about a given average duration.

reinforcement A process in which a behavior is followed by the presentation of a stimulus and as a result, produces an increase in the future probability of that behavior.

response cost A procedure in which a specified reinforcer is lost contingent upon behavior and, as a result, decreases the future probability of that behavior.

target behavior The behavior of interest, or the behavior to be altered.

Home-based reinforcement is a procedure used to modify the school-based behavior of children and adolescents through the use of contingencies delivered in

the home. This article presents a description of the procedure along with the theoretical basis and empirical support for its use.

I. DESCRIPTION OF TREATMENT

Home-based reinforcement (HBR) procedures involve providing consequences for behavior that occurs in school settings. However, unlike traditional school-based contingency management procedures in which consequences are controlled and delivered by school personnel, consequences for school-based behavior in HBR are controlled and delivered by a parent, guardian, or other caretaker in the child's home environment. HBR is typically used with children and adolescents and is usually initiated by school personnel or clinicians who seek an improvement in school attendance or academic performance or seek a decrease in school-based disruptive behavior. Although HBR has been implemented in many different ways (described later in Section III), a general template for implementation is as follows.

First, the clinician, with the help of the child, the child's teacher, and the child's parent, identifies behaviors targeted for acceleration or reduction. Likewise, the teacher and parent (with input from the child) agree on daily goals for acceptable performance with respect to each targeted behavior. Each of the daily goals is operationally defined so the teacher and child are clear as to whether or not the child has achieved the

goal for that particular day. After target behaviors and daily behavioral goals are identified, the clinician establishes a simple observation system. In the observation system, the teacher monitors the occurrence of the targeted behavior(s) and determines if the daily behavioral goals are achieved.

After the targets, goals, and observation system are established, the remainder of the HBR program is explained to the parent and teacher. This is done by (1) having the teacher send a letter to the parents describing the procedure, or (2) having the clinician facilitate a face-to-face meeting with the teacher and parent. Using either method, the program is explained as follows.

Each of the daily goals, corresponding to the target behaviors, is listed on an observation sheet that is given to the teacher. At the end of each school day, the teacher indicates whether or not the child achieved each of the daily goals. The teacher shares this information with the student and places the information on a note that is sent home daily with the child. The parent receives the note, signs it, and returns it to the teacher via the child on the next school day.

On receiving the note, the parent(s) provides consequences for school behavior. If all daily goals are successfully reached, the parent praises the child and provides the child with a previously agreed-on consequence such as snacks, privileges, or other tangible items to which the child does not typically have access. If all daily goals are not successfully reached, the parent and child discuss what could be done differently to ensure success the next day, and the parent provides a previously agreed-on consequence such as a loss of privileges. If the child fails to bring a note home, this is treated as a day in which all daily goals were not met and should be consequenced accordingly.

Although the program is best implemented by having the child receive feedback via the home note on a daily basis, sustained good performance warrants the gradual elimination of the feedback system to promote treatment maintenance. Although a variety of fading procedures have been used, the clinician could recommend that the frequency of notes being sent home first decrease from daily to one note every second or third day, to once per week, and finally to once per month. In using this fading procedure, the clinician should explain to the teacher and parents that all behavior exhibited by the child since the last home report is considered when determining whether the child has met his or her daily goals. Again, a change in the frequency of notes being sent home should only be implemented if the child is consistently meeting his or

her target goals. Fading should not be implemented if the child is not consistently meeting his or her daily behavioral goals.

II. THEORETICAL BASIS

Home-based reinforcement is based on operant learning theory. Specifically, it is thought that the presentation or removal of certain stimuli have the ability to alter behavior when delivered in a response contingent format. Reinforcers are stimuli that produce increases in the future probability of behavior. Reinforcers can include stimuli that are added to the environment (e.g., providing praise contingent on a child's good behavior) or removed from the environment (e.g., a parent's candy-buying behavior is reinforced when his or her child stops screaming "Buy me candy!"). In contrast, punishers are stimuli that produce decreases in the future probability of behavior. However, like reinforcers, punishers can include stimuli that are added to the environment (e.g., painful stimulation is received when the child touches a hot stove) or removed from the environment (e.g., a child's toy is briefly taken away when he or she is destructive with the toy). In all cases, reinforcement and punishment are defined by their outcome on behavior. If the behavior increases in strength, the stimulus following the behavior is classified as a reinforcer, and if the behavior decreases in strength, the stimulus following the behavior is classified as a punisher.

Reinforcers and punishers exert more or less control on the behavior depending on various levels of deprivation, satiation, and other establishing operations experienced by the person. When paired with previously established reinforcers, neutral stimuli (i.e., noncontrolling stimuli) can come to function as reinforcers or punishers in their own right.

In HBR, the reinforcers and punishers are initially the consequences provided at home (i.e., earned or lost privileges, snacks, tangibles). However, delivery of the reinforcing consequences is often paired with praise or positive marks on the home note. This pairing process results in such stimuli also becoming reinforcers that may provide more proximal control over the school behavior. Although operant theory is quite clear that learning will be most efficient if consequences immediately follow behavior, HBR begins with a more temporally distal consequence because the children's parents have better access and control over a wider array of consequences for which the child

is likely to be under the control of a current establishing operation. Although the theoretical explanation just provided is based on operant principles developed from nonverbal organisms, it must be recognized that much of the learning involved in HBR is occurring within a verbal context and with verbal organisms. Thus, it is likely that behavioral processes unique to verbal organisms, such as stimulus equivalence, play perhaps an even greater role in explaining the effectiveness of HBR. Unfortunately, a description of such procedures is outside the scope of this article.

III. EMPIRICAL STUDIES

Home-based reinforcement was first evaluated by Jon Bailey and colleagues in 1970. Because this original study demonstrated the effectiveness of controlling school-based behavior with home-based consequences, a growing volume of research has evaluated various effective forms and uses of HBR. This body of research is briefly reviewed later and includes discussions of behaviors targeted with HBR, methods of implementation, effective consequences, child variables, maintenance programs, and treatment acceptability of HBR.

A. Behaviors Targeted with HBR

Home-based reinforcement has been successfully used to increase academic skills and decrease disruptive behaviors in the classroom. Specifically, HBR has been used to increase motivation, rule following, grades, homework completion, listening, asking and answering questions, staying on-task, and completing class work. It has also been used to successfully decrease aggression, name calling, making noise, talking without permission, physically disturbing other children, and out-of-seat behavior.

The effects of the HBR procedure may also generalize to other nontargeted behaviors, persons, or settings. In 1983 Joseph C. Witt and colleagues found that when HBR was implemented to increase academic behavior, decreases were also seen in disruptive behavior. In addition, it has been found that when a HBR procedure is used on selected target students, the positive effects of the procedure may be seen in nontargeted students. For example, if a teacher targets the classroom behaviors of only half a class, it has been found that the nontargeted half will also show decreases in disruptive behavior. Likewise, data suggest

that the positive effects of HBR can generalize from school to home settings.

B. Methods of Implementation

Also of interest is the specific method that should be used when implementing HBR. Issues such as how the plan should be communicated to parents, how often the home notes should be sent home, what information should be included on the home note, and who should be in charge of the home note at school, all must be considered.

In 1972 R. J. Karraker investigated how much effort was needed to instruct parents in the use of HBR. The researchers taught the procedure to three groups of parents during either two, 1-hour conferences, a 15-min. conference, or by mailing the instructions home. It was found that all three methods of implementation were equally effective in increasing academic behavior.

In 1997 Richard W. Saudargas investigated the rate that home notes should be sent home and found that sending notes home daily was more effective in increasing academic behavior than sending the notes home every Friday. In addition, research has shown that parents prefer daily school notes to both weekly and standard report cards.

There is considerable variation in the amount of information that is included on the home notes. Some home notes only have information on performance in a specific area, such as math completion or disruptive behavior whereas others give a global rating of the child's behavior for the whole day. Both methods have been shown to be effective in changing the student's behavior.

Student involvement in HBR has also been successfully varied. In some cases, the teacher has completed the home note without the student's knowledge, and in others, the teacher has instructed the student when to mark the home note and then signed it at the end of the class. To this date no studies have directly compared the effectiveness of the two methods.

C. Effective Consequences in HBR

One issue that is clear is that some type of reinforcing consequence is necessary for HBR to be effective. In 1972 R. J. Karraker investigated whether receiving the home note without reinforcement would be effective in changing the behavior of children and found that improvements in academic behavior were seen

only after the home note was paired with some rewarding consequence.

Although it is clear that a home-based consequence must be delivered, the most effective form of that consequence is less clear. A number of studies demonstrated the effectiveness of praise and tangible reinforcers for bringing home a note with good ratings, but not all researchers have been successful with only praise. In 1977, Jean B. Schumacher found mixed results in student behavior when using only praise but found consistent increases in school conduct, class work, and daily grades when praise and tangibles were contingent on a satisfactory home note. Some research also suggests that using contingencies that affect a group of individuals in the home, rather than just the target child, may also enhance the effectiveness of HBR.

Researchers have also had success by adding response cost to HBR. In 1995, Mary Lou Kelly and colleagues found that inappropriate behavior could be decreased using normal a HBR procedure, giving points exchangeable for rewards contingent on appropriate behavior, but found greater effects by having the children cross a "smiley" face off their home notes for inappropriate behavior. In the response-cost phase of the experiment the children needed to keep certain amount of smiley faces or points to earn reinforcers.

D. Child Variables

The effectiveness of HBR has been demonstrated with children from kindergarten to high school, in both special and regular education classes, and with children who have learning disabilities. HBR has also been shown to be effective in institutional or group home settings.

E. Maintenance Programs

As stated earlier, the goal of HBR is to have the child eventually function independent of the reinforcement program. To do this, fading or other procedures are often utilized. Some research has suggested effective ways to gradually reduce reliance on HBR procedures.

In 1973 Richard Coleman demonstrated that increases produced by HBR could be maintained while gradually altering the procedure to make the child's school environment more natural. Prior to the altering the procedure, points were rewarded contingent on appropriate behavior using a short, variable interval schedule. The teacher gradually made the child's environment more natural by (1) increasing the interval, (2) subtracting points for inappropriate behaviors instead of reinforcing

appropriate behaviors, (3) extending the period of time during which points were taken away, (4) and making the child's weekly allowance contingent on an acceptable report from the teacher.

Another successful method for removing HBR is to gradually fade the procedure by increasing the criterion level required to receive reinforcement. For example, going from daily reinforcement, reinforcement could be made contingent on two consecutive days of appropriate behavior, followed by three until the schedule has been thinned to the point where the program can be terminated.

G. Treatment Acceptability of HBR

Clinicians should not only consider treatment effectiveness when choosing a procedure but should also attend to the acceptability of the intervention. An effective, but unacceptable intervention will likely meet with resistance and may produce negative emotional reactions in those involved. Thus, the acceptability of HBR procedures are discussed next.

Research has been conducted to determine the characteristics of acceptable behavioral interventions. Thomas Reimers conducted a review of the acceptability literature of behavioral interventions and found that the most acceptable interventions were those that (1) did not require large amounts of time, (2) were positive, (3) were less costly, and (4) did not produce negative side effects. Given that these are all characteristics of HBR, one could predict that HBR is an acceptable procedure.

In fact, many HBR investigations have assessed parent and teacher acceptability of HBR. In all, results showed that parents and teachers found HBR to be an acceptable way to deal with a student's behavior or academic problems. In 1989 Brian Martens and Paul Meller asked teachers to rate the acceptability of a response-cost procedure and a HBR procedure. The researchers found that the HBR procedure was rated as more acceptable than the response-cost procedure.

IV. SUMMARY

In summary, home-based reinforcement is an efficient, effective, and acceptable behavior modification procedure that is used to improve school-based performance or behavior in children and adolescents. Although there are many minor variations of the HBR procedure, in general it involves the delivery of

home-based consequences by the child's parents, contingent on school-based behavior.

See Also the Following Articles

Backward Chaining ■ Fading ■ Good Behavior Game ■ Homework ■ Minimal Therapist Contact Treatments ■ Parent–Child Interaction Therapy

Further Reading

Atkeson, B. M., & Forehand, R. (1979). Home-based reinforcement programs designed to modify classroom behavior: A review and methodological evaluation. *Psychological Bulletin*, 86, 1298–1308.

- Bailey, J. S., Wolf, M. M., & Phillips, E. L. (1970). Home-based reinforcement and the modification of pre-delinquent classroom behavior. *Journal of Applied Behavior Analysis*, 3, 223–233.
- Barth, R. (1979). Home-based reinforcement of school behavior: A review and analysis. *Review of Educational Research*, 49, 436–458.
- Kelley, M. L., & McCain, A. P. (1995). Promoting academic performance in inattentive children. *Behavior Modification*, 19, 357–375.
- Leach, D. J., & Byrne, M. K. (1986). Some “spill-over” effects of a home-based reinforcement programme in a secondary school. *Educational Psychology*, 6, 265–276.
- Witt, J. C., Hannafin, M. J., & Martens, B. K. (1983). Home-based reinforcement: Behavioral covariation between academic performance and inappropriate behavior. *Journal of School Psychology*, 21, 337–348.

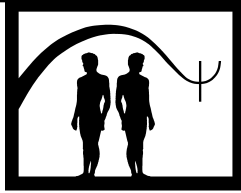

Homework

Lisa W. Coyne and Thomas W. Lombardo

University of Mississippi

- I. Description of Treatment
- II. Theoretical Bases
- III. Empirical Studies
- IV. Summary
- Further Reading

GLOSSARY

behavior therapy A systematic, direct, educational approach to therapy that uses principles and strategies that have been supported by research to change thoughts, feelings and behaviors to help clients.

cognitive therapy Very similar to behavior therapy but focuses much more exclusively on altering problematic thoughts and beliefs that are perceived as causing problems.

effect size A measure of how well therapy works.

meta-analysis A research methodology and set of statistical techniques that combine the results of several individual studies to get a more reliable answer to questions, such as "Does homework help therapy outcome?"

Homework assigned to be done outside of therapy sessions is believed to add to treatment effectiveness or even to be necessary for treatment effectiveness by therapists of most theoretical orientations. This article describes types of homework, the benefits of homework, the evidence that homework is useful, and some guidelines for increasing homework assignment compliance.

I. DESCRIPTION OF TREATMENT

Homework refers to therapeutic assignments given by a therapist to a client to complete between sessions. The use of such assignments has a number of purposes. First, homework is purported to enhance treatment generalization through *in vivo* practice. Consider the example of a client taught assertiveness skills in session. From a behavioral perspective, practice in a natural environment allows for nascent skills to come under the control of naturally occurring contingencies. Newly learned behaviors reinforced *in vivo* have a higher probability of further generalizing to other real-world settings than skills merely performed in the clinic with a therapist. Even unsuccessful attempts have their uses: they may be discussed with the therapist and used to shape new homework assignments addressing more specific problem areas. Second, homework assignments are meant to optimize treatment in a cost-effective way. Rather than investing in therapy for multiple sessions per week, clients are asked to practice skills on their own, leading to a more comprehensive and seamless therapeutic experience. In fact, many behavior therapy procedures, such as progressive muscle relaxation, depend on *in vivo* practice to attain meaningful treatment goals. Finally, consistent with Albert Bandura's theory of behavior change, experiences of success in homework assignments should increase clients' self-efficacy and thus improve general motivation for persisting with treatment.

A seminal work describing the importance of homework assignments in cognitive-behavior therapy is the

1979 depression treatment manual, *Cognitive Therapy for Depression* by Aaron T. Beck, A. John Rush Brian F. Shaw, and Gary Emery. These authors posit that homework plays a critical role in the therapeutic process. They conceptualize homework as a sort of trial in which clients strive to gain new insights about their thoughts, emotions, and behaviors that lead to the negative thinking that precipitates and maintains their depression. Assignments develop from collaboration between therapist and client, and their goal is not perfection, but practice. The function of homework assignments is to assist clients to effectively transfer skills learned in session to their home and work environments. With homework, progress made in session may be more likely to be applied throughout a client's life, across both time and situations.

Homework assignments first became incorporated into psychotherapy during the 1950s in G. A. Kelly's fixed role therapy, which encouraged clients to adopt different, more adaptive interpersonal behavior patterns or "roles" and to practice these patterns outside of the therapeutic environment. In recent years, cognitive-behavioral and rational-emotive therapies, as well as some psychodynamic therapies, have integrated systematic homework into their treatment paradigms. Homework assignments have been incorporated into manualized treatments for a wide variety of psychological problems, including depression, anxiety, substance abuse and dependence, personality disorders, posttraumatic stress disorder, sexual dysfunction, and schizophrenia as well as for parent training (child management).

Written assignments, self-monitoring procedures, and skills practice are three broad types of homework assignments. However, the structure, content, and quantity of homework assignments are a function of several factors, including the therapist's theoretical orientation and the client's particular problem and commitment to therapy. For example, in the 1979 Beck, Rush, Shaw, and Emery depression treatment manual, homework assignments are geared toward reducing the incidence of (or eliminating) the negative thinking that plays a role in depressive symptomatology. In this type of homework, a cognitive therapist might ask a client to monitor and write down pessimistic thoughts related to depressed mood, and then to practice replacing such thoughts with more positive thoughts. Similarly, a rational-emotive behavior therapist might direct a client to identify irrational thoughts, and then to produce evidence that both supports and counters their validity. With such evidence in hand, the client is instructed to weigh these pros and cons and then judge the truth

value of the cognition. A behavior therapist treating depression, on the other hand, might collaborate with the client to identify maladaptive behavior patterns, such as insufficient exercise or social withdrawal, and design homework assignments to alter these behaviors. It is not uncommon for a depressed client under the treatment of a behavioral therapist to leave a session with instructions to increase the frequency or duration of exercise, to visit at least one friend once per week, or to take time away from serving others to do something for themselves that they would ordinarily never do. Other typical homework assignments include exposure to feared thoughts, images, or situations, practice of social skills, biofeedback techniques, viewing videotapes, and practicing progressive muscle relaxation.

One clear example of the skills approach to homework used in behavior therapy is teaching a client applied muscle relaxation, which is often used for anxiety disorders. Applied muscle relaxation is a treatment in which an individual is taught a behavior that is incompatible with an existing response to specific situations. In the case of inappropriate or excessive anxiety, clients are taught to monitor their anxiety responses to environmental cues, such as increased heart rate and muscle tension, so that they can discriminate when they are becoming anxious. At the same time they are taught progressive muscle relaxation. For progressive muscle relaxation, therapists teach clients in a clinic session to focus sequentially on a number of different muscle groups while they first tense and then relax these muscles. This procedure is repeated until all muscle groups have been addressed, and the client reports lower levels of muscle tension and anxiety. After presenting the progressive muscle relaxation procedure in session, the client is typically provided with either verbal instructions and/or an audiotape of the therapist conducting the procedure along with homework instructions to practice the procedure at home. Initially, practice is done in a quiet, comfortable setting. Once mastery is achieved under those conditions, practice is done in progressively more distracting and less comfortable settings or situations. For example, a cancer patient who becomes anxious before and during chemotherapy sessions might first repeatedly practice relaxation at home, eventually add visualizing receiving cancer treatment while practicing, and then utilize relaxation just before and during the treatment itself.

Another type of homework assignment is *in vivo* exposure. Exposure involves persistently and repeatedly confronting feared objects or situations until feelings of anxiety subside. For example, in a 1993 study by Ruth

Edelman and Dianne Chambless, clients diagnosed with agoraphobia were assigned homework consisting of self-directed exposure between sessions. In comparison with clients who complied less, those who complied more with between-session exposure assignments reported significantly lower fear levels and fewer avoidance behaviors. By incorporating homework practice in treatment, it is believed that both the speed of learning a skill as well as the ease of acquiring that skill are enhanced.

II. THEORETICAL BASES

In general, homework assignments, as utilized in cognitive-behavioral therapies, are believed to improve client outcomes. Specifically, they are believed to increase the effectiveness and generalizability of treatment via between-session practice. This practice should both optimize the intervention and increase cost effectiveness for the consumer: homework, if adhered to, ensures multiple “sessions” per week for the price of one.

The major questions asked about homework deal with compliance with assignments. One question is whether the relationships found between homework compliance and treatment outcome are causal. That is, does increased homework completion lead directly to greater clinical improvement or is this simply a correlational relationship that is actually the result of some other factor or factors. The second question is how can therapists increase homework compliance and, relatedly, what factors are known to predict compliance difficulties. Awareness of the latter can assist therapists to be better prepared and have additional strategies in hand to aid compliance.

Several third-variable factors could account for the relationship between homework compliance and treatment outcome. Clients who are more motivated, either dispositionally or from early therapist interventions, might work harder in all aspects of therapy, including homework, and make more treatment gains. Parallel effects could arise from a more optimistic attitude or more openness to change. In either case, the effect of homework compliance on outcome would be incidental.

Also, the compliance–outcome relationship could work in the reverse direction: severely depressed clients might do little or no homework between sessions. This would imply that homework has no effect on outcome.

The evidence from two recent studies indicates that compliance does have a direct effect on treatment outcome. David Burns and Diane Spangler used structural equation modeling to answer this question in a 2000

paper and found support for a causal effect of homework compliance on outcome. Using a very different research strategy, repeated assessments of homework compliance and of improvement in depression, Michael Addis and Neil Jacobson found that early compliance predicted final outcome. Their results countered the reverse compliance–symptom severity alternative hypothesis and supports a causal relationship. Therefore, except for a very few studies that have found compliance unrelated to outcome, it appears that the more clients follow homework assignments, the more they improve.

Although homework is an integral part of many cognitive-behavioral therapies, it appears that client non-compliance may limit the benefits of assignments to treatment outcome. In a 1999 review paper, Jerusha Detweiler and Mark Whisman discuss failure to comply with homework assignments and possible methods for increasing compliance. Their review lists several factors that contribute to poor compliance: unrealistic goal setting (i.e., therapists making assignments too hard), lack of consideration of a given client’s ability to complete a particular assignment, poor client motivation, client expectations that their role in therapy is a passive one, and poorly designed assignments (e.g., those that do not come under the control of naturally occurring reinforcers). Other client-based reasons cited range from client perfectionism and fear of failure to comorbid personality disorders and high initial levels of symptomatology. These authors observe that, for homework to be beneficial, practice, commitment, and just plain hard work are required. This points out the importance of presenting to the client a sound, compelling treatment rationale to motivate this effort.

Detweiler and Whisman identify a number of task, therapist, and client characteristics relevant to increasing compliance. In terms of task characteristics, the more specific and concrete an assignment, the more likely a client will understand and complete it. For example, writing down assignments for the client may elicit more compliance than just verbally describing what they are to do. Providing concrete, specific details of what they are to do and when they are to do it can prevent misunderstandings and frustration for both the client and therapist. Shaping the client’s assignments, starting with brief and simple tasks and gradually increasing homework demands should also help by building self efficacy. Client characteristics that bear consideration include initial levels of symptomatology, motivation, or merely contextual barriers to completion. Consider a client who works on an assembly line and has been asked to write down instances of an intrusive

thought. Such an assignment is likely to end up a failure due to its poor feasibility. Using role plays with role-reversal, having the client act as the therapist and explain why homework and its completion are important, may enhance motivation. Therapist characteristics that may affect compliance are more difficult to define, as there are gaps in the empirical literature concerning this variable. Nonetheless, the authors posit that factors such as empathy and therapist behaviors related to recommending assignments may merit exploration.

In other studies done to examine factors associated with better homework outcomes, it has been found that the quality of the homework product is far more predictive of outcome than the quantity of homework produced and that more thorough reviews of one homework assignment will promote better compliance with subsequent homework assignments.

III. EMPIRICAL STUDIES

The primary question for homework is “Do homework assignments improve therapeutic outcome over and above in-session therapy effects alone?” In 2000, Nikolaos Kazantzis, Frank P. Deane, and Kevin R. Ronan conducted a meta-analysis of the literature on this empirical question. Combining 11 prior studies with a total of 375 participants, their analysis found strong effects of homework assignments on therapy outcome. Thus the answer seems to be a clear “yes.” These authors’ results also showed that the effect of homework was stronger for depression than for anxiety disorders. Homework assignments to practice social skills and watch videotapes had stronger effects on outcome than assignments to self-expose to feared objects or situations and relaxation practice. Finally, studies that used a range of homework assignments appeared to obtain better treatment effects than studies that used only single, specific homework assignments.

How large are the effects of homework on therapy outcome? The meta-analysis above found an effect size of $r = .36$. It is useful to see in more concrete terms how large a change a therapist can expect to see on a common measure of distress. The Burns and Spangler study described earlier separately examined two groups of depressed patients for the effects of homework on change in scores on the Beck Depression Inventory (BDI), a short, reliable questionnaire that is used by both researchers and private practitioners. For each of their groups, they found that homework accounted for a drop in BDI scores of 14 to 16 points. This improvement in BDI scores was comparable to a 1988 study done in a

private practice setting by Jacqueline Persons, David Burns and Jeffery Perloff. These authors found a 16.6 point BDI change with homework but noted that the vast majority of improvement occurred in their more depressed clients, those with initial BDI scores over 20. Homework had very little effect for their clients who had lower scores at the beginning of treatment. In general, the degree of BDI change produced by homework alone in these studies would move a client from being classified as “severely depressed” to “moderately depressed” or from “moderately depressed” to “mildly depressed.”

Psychodynamic and systemic or family therapies also often require or recommend homework. Although there is no literature to date investigating homework effectiveness within these therapies, there is no reason to think that the cognitive-behavioral research findings that support the use of homework would not generalize to these approaches.

IV. SUMMARY

Most theoretical orientations hold that what a client does in the natural environment outside of therapy sessions is a necessary condition for producing therapeutic change. Typically, clients are seen for about 1 hour each week. To extend what clients are taught in session to the time intervening between sessions and to implement what clients learn in session, therapists give homework assignments. Effective homework assignments can optimize the cost effectiveness of therapy for the consumer.

Homework assignments first became incorporated into psychotherapy during the 1950s, and since then, have become an integral part of both behavioral and cognitive-behavioral treatment paradigms. Other treatment modalities, such as systems therapy or psychodynamic interventions, also utilize homework. Homework is used in the treatment of a wide variety of disorders, which, along with factors such as therapist orientation and client commitment, may dictate the type of homework assigned. Common types of assignments include written assignments, self-monitoring procedures, and skills practice.

Research clearly shows that homework improves treatment outcome.

See Also the Following Articles

Applied Relaxation ■ Behavior Rehearsal ■ Discrimination Training ■ Exposure *in Vivo* Therapy ■ Guided Master Therapy ■ Home-Based Reinforcement ■ Negative Practice ■ Panic Disorder and Agoraphobia ■ Self-Control Therapy

Further Reading

- Addis, M. E., & Jacobson, N. S. (2000). A closer look at the treatment rationale and homework compliance in cognitive-behavioral therapy for depression. *Cognitive Therapy and Research, 24*, 313–326.
- Beck, A. T., Rush, A. J., Shaw, B. F., & Emery, G. (1979). *Cognitive therapy for depression*. New York: Guilford Press.
- Bergin, A. E., & Garfield, S. L. (1994). *Handbook of psychotherapy and behavior change* (4th ed.). New York: John Wiley and Sons.
- Bryant, M. J., Simons, A. D., & Thase, M. E. (1999). Therapist skill and patient variables in homework compliance: Controlling an uncontrolled variable in cognitive therapy outcome research. *Cognitive Therapy and Research, 23*, 381–399.
- Burns, D. D., & Spangler, D. L. (2000). Does psychotherapy homework lead to improvements in depression in cognitive-behavioral therapy or does improvement lead to increased homework compliance? *Journal of Consulting and Clinical Psychology, 68*, 46–56.
- Detweiler, J. B., & Whisman, M. A. (1999). The role of homework assignments in cognitive therapy for depression: Potential methods for enhancing adherence. *Clinical Psychology: Science and Practice, 6*, 267–282.
- Edelman, R. E., & Chambless, D. L. (1993). Compliance during sessions and homework in exposure-based treatment of agoraphobia. *Behaviour Research and Therapy, 31*, 767–773.
- Kazantzis, N., Deane, F. P., & Ronan, K. R. (2000). Homework assignments in cognitive and behavioral therapy: A meta-analysis. *Clinical Psychology: Science and Practice, 7*, 189–202.

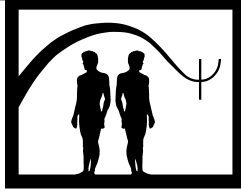

Humanistic Psychotherapy

Kirk J. Schneider

Saybrook Graduate School and Research Center

Larry M. Leitner

Miami University

- I. Humanistic Approaches: Description and Overview
 - II. Existential Therapy
 - III. Constructivist Therapy
 - IV. Transpersonal Therapy
 - V. Empirical Studies of Humanistic Therapy
 - VI. Summary
- Further Reading

GLOSSARY

constructivist therapy Humanistic approaches that stress personal and social constructions of psychological growth processes.

existential therapy Humanistic approaches that emphasize freedom, experiential reflection, and responsibility.

humanistic theory Comprises two overarching concerns: What it means to be fully, experientially human, and how that perspective illuminates the vital or fulfilled life.

humanistic therapy Conditions or stances that assist people to grapple with and become more of who they aspire to become.

transpersonal therapy Humanistic approaches that accent spiritual and transcendent dimensions of psychological well-being.

Humanistic psychotherapy is the applied branch of humanistic psychology and philosophy. Humanistic psychology and philosophy are time-honored folk and academic traditions that stress deep personal inquiry

into the meaning and purpose of life. In particular, humanistic psychology and philosophy pose two basic questions: What does it mean to be fully, experientially human, and how does that understanding illuminate the vital or fulfilled life? Correspondingly, humanistic psychotherapy comprises the conditions or stances by which people can come to intimately know themselves and, to the extent possible, to fulfill their aspirations. Humanistic psychotherapy is characterized by three major practice philosophies—the existential, the constructivist, and the transpersonal.

I. HUMANISTIC APPROACHES: DESCRIPTION AND OVERVIEW

Humanistic psychotherapy is a broad classification that embraces a diverse ensemble of approaches.¹ Each of these approaches is like a spoke on a wheel, the hub of which is the humanistic theoretical stance. The humanistic theoretical stance derives essentially from ancient Greek, Renaissance, and even Asian sources,

¹ The terms “approach,” “stance,” and “condition” are used instead of “treatment” in humanistic nomenclature. The reason for this substitution is because “treatment” implies the medical-like application of a technique to a measurable and well-defined symptom; however humanistic psychotherapy emphasizes the significance of a relationship—a condition, atmosphere, or forum—within which not just symptoms but complex life issues can be explored and addressed.

which all uphold the maxim, “know thyself.” Although there have been many variations on this theme throughout the development of psychology, let alone humanistic psychology, it has come to acquire a core humanistic meaning. For humanists, to know thyself is far from a simple project with trivial implications; to the contrary, it is an intensive intra- and interpersonal undertaking with world-historical significance. In the parlance of modern humanistic psychology the maxim has come to be understood as a dialectic between profound self-inquiry, and inquiry into the world. Indeed, the self cannot be separated from the world, according to contemporary humanists, and must be understood as a “self-world” process or construct as James Bugental has put it. A corollary to the humanistic stress on inquiry is engagement of potential. It is not enough to ask questions about life’s meaning, according to humanists, one must also, at the appropriate time, translate those questions into a meaningful life. In short, humanistic psychology has both an inquiring and moral-ethical component that suffuses through every mode of its application. To learn more about the history and development of humanistic philosophy and psychology, see *The Handbook of Humanistic Psychology: Leading Edges in Theory, Research, and Practice* and *Humanistic and Transpersonal Psychology: A Historical and Biographical Sourcebook*.

Contemporary humanistic psychotherapy is composed of three basic practice traditions: the existential, constructivist, and transpersonal. We will now describe the structure of these traditions, highlight their conceptual underpinnings, and consider the empirical evidence on which they are based.

II. EXISTENTIAL THERAPY

Existential psychotherapy derives from the philosophical and literary writings of such thinkers as Søren Kierkegaard, Friedrich Nietzsche, Martin Heidegger, Jean Paul Sartre, and Maurice Merleau-Ponty; and from the methodological formulations of investigators such as Edmund Husserl, Wilhelm Dilthey, and William James. The basic thrust of existential psychotherapy, as Rollo May, one of the leading contemporary spokespeople for the movement put it, is “to set clients free.” Freedom is understood as the cultivation of the capacity for choice within the natural and self-imposed (e.g., cultural) limits of living. Choice is understood further as responsibility; the “ability to respond” to the myriad forces within and about one. Although many forces are

recognized as restrictive of the human capacity for choice, for example, influences that May terms “destiny”—genes, biology, culture, circumstance—they are nevertheless highly mutative, according to existentialists, in the light of—and through the tussle with—choice. For existentialists, choice is the key to an engaged and meaningful life.

The second major concern of existential psychotherapy is the cultivation not just of intellectual or calculative decision-making, but decision-making that is felt, sensed, or in short, experienced. The stress on the experiential is one of the primary areas of distinction between existential and other (e.g., cognitive-behavioral, psychoanalytic) modes of practice. The experiential mode is defined by four basic dimensions—immediacy, affectivity, kinesthesia, and profundity. By immediacy, we mean that experience is fresh, living, “here and now”, by affectivity, we mean experience is characterized by feeling or passion; by kinesthesia, we mean experience is embodied or intensively sensed; and by profundity, we mean experience has depth, impact, and transcendent significance. Another way to characterize the experiential is through recognition, as Arthur Bohart has put it. To the degree that a thought, feeling, or behavior is recognized, according to Bohart, it is experienced.

Existential therapists have a variety of means by which to facilitate freedom, experiential reflection, and responsibility. Some, such as Irvin Yalom, emphasize the support and challenges of the therapist–client relationship to facilitate liberation. Yalom stresses the building of rapport and repeated challenges to clients to take responsibility for their difficulties. Further, Yalom homes in on the immediate and affective elements of his therapeutic contacts, but he refers little to kinesthetic components. Following the philosopher Martin Buber, Maurice Friedman also homes in on the interpersonal relationship but stresses the dimension of authenticity or the “I-thou” encounter as the key therapeutic element. The I-thou encounter according to Friedman is the dialectical process of being both present to and confirming of oneself, while simultaneously being open to and confirming of another. The result of such an encounter is a “healing through meeting” as Friedman puts it in *The Psychology of Existence*—which is a healing of trust, deep self-searching, and responsibility. Through the therapist’s I-thou encounter, in other words, the client is inspired to trust, enhance self-awareness, and take charge of his or her own distinct plight. James Bugental, on the other hand, accents the “intra” personal dimensions of freedom, experiential reflection, and responsibility. For Bugental, choice and responsibility are facilitated, not

merely or mainly through therapist and client encounter, but through concerted invitations (and sometimes challenges) to clients to attend to their subtlest internal processes—flashes of feeling, twinges of sensation, and glimpses of imagination. Via these means, according to Bugental, clients discover their deepest yearnings, their strongest desires, but also, and equally important, their thorniest impediments to these impulses. By grappling with each side, however, Bugental maintains that clients learn to negotiate their conflicts, elucidate their meaning, and rechannel them into living fuller and more empowered lives.

Similarly, Rollo May stresses the cultivation of what he terms “intentionality” in the therapeutic relationship. By intentionality, May refers to the “whole bodied” direction, orientation, or purpose that can result from existential therapy. In his case examples, May shows how intellectualized or behaviorally programmed interventions persistently fall short with respect to the cultivation of intentionality, whereas profound struggle, both between the therapist and client and within the client, can, if appropriately supported, lead to such a quality. For May (as with most of the existential therapists), the struggle for identity is essential—enhancing clarity, agency, and ultimately commitment or intentionality in the engagement of one’s life.

The client’s internal frame, and his or her own subjective wrestling is also a hallmark of Carl Rogers’ client-centered approach. For Rogers, the therapist must create the conditions for client freedom, searching, and responsibility; he or she would not (except in rare instances) attempt to dictate or teach these capacities. The rationale for this stance is foundational—clients must learn for themselves what is meaningful or essential to their growth. In Rogers’ view, there are three facilitative conditions necessary for optimal therapy—the therapist’s warmth or caring, the degree to which he or she is congruent or genuine, and the degree to which the therapist communicates unconditional positive regard for the client. With the provision of these conditions, according to Rogers, clients are freed to verbalize and embody more of who they experience themselves to be, and by implication, to eradicate the incongruities and pretenses of who they have been. By discovering more of who they are, moreover, clients do not become licentious in Rogers’ view; they become responsive, both to themselves and to those around them.

With his Gestalt therapy, Frederick Perls also emphasizes the client’s side of the therapeutic encounter, but through a very different means. One might say that whereas Rogers “alerts” clients about their liberating po-

tentials, Perls “alarms” them; and whereas Rogers accents therapeutic receptivity, Perls stresses therapeutic confrontation. For example, whereas Rogers might use active listening or empathic reflection with a given client, Perls might encounter a client directly—“how is it that you continually meet men who are bad for you?” Or Perls might refer to a client’s body position or manner of speaking and concertedly encourage the client to amplify and attend to those modalities.

The upshot of this synopsis is that existential therapists use diverse means by which to foster a similar result—client empowerment and consciousness-raising. In recent years, and partly as a response to the ethos of managed care, existential therapists have endeavored to reassess and in some cases streamline their repertoires. Existential oriented investigators are increasingly raising two questions: Which of the various existential practices work best, and under what general conditions? Leslie Greenberg, Laura Rice, and Robert Elliott, for example, have developed what they term “therapeutic markers” to guide their work. Such markers are statements, gestures, or signs that clients are experiencing specific kinds of difficulty, for example, identity conflicts, unfinished business with significant others, loss of meaning. By identifying the markers, therapists are better able to both identify and specify the interventions (e.g., supportiveness, uncovering) that address those markers. Therapists such as those discussed earlier have also found that specific Gestalt techniques, such as “chair work” and “systematically building the scene” can be of particular value in the appropriate circumstances. Chair work entails a role-play between a client and an imagined other who “sits” on an empty chair. The client “works out” or simulates an actual encounter with the imagined other, and with the assistance of the therapist, processes the feelings, thoughts, and implications of that experience. Systematically building the scene entails the use of vivid and concrete language to help clients revive and work through suppressed or traumatizing material.

Eugene Gendlin’s “Focusing Therapy” and Alvin Mahrer’s “Experiential Therapy” also provide methodical and intensive guidelines to optimize existential practice. Gendlin, for example, homes in on that which he terms the “felt sense,” which is a preverbal, bodily experience of a given concern, to facilitate therapeutic change. Very methodically, Gendlin encourages clients to identify their felt sense, explore its nuances as it evolves, and clarify its meaning or implication for their lives. Mahrer has four basic aims in his experiential therapy: assist clients into moments of strong feeling, help them to align with or integrate those moments, encourage them

to enact or embody the inner experiences associated with those moments, and support them to live or translate their discoveries into the present. Mahrer's approach has two overarching goals: (1) to help clients access deeper experiencing potential so that they can become (to the degree possible) "qualitatively new persons," and (2) to help them free themselves from the limiting feelings that have plagued them in the past, and with which they grapple in the present.

Kirk Schneider, with the assistance and inspiration of Rollo May, has synthesized a range of existential approaches with his model "Existential-Integrative Therapy." Existential-integrative therapy draws on a diversity of therapeutic approaches within a unitary existential or experiential framework. The aim of the existential-integrative approach is to address clients at the level at which they chiefly struggle—be that physiological, environmental, cognitive, psychosexual, or interpersonal—but all within an ever-deepening, ever-beckoning experiential context. By "experiential" Schneider refers to four characteristic dimensions—the immediate, the affective, the kinesthetic, and the profound (or cosmic). The degree to which a client can be "met" within the experiential context is a function of his or her desire and capacity for change, but also, according to Schneider, an assortment of therapist offerings. Among these offerings are "presence," "invoking the actual," "vivifying and confronting resistance," and "meaning creation (or cultivation)." Presence, for Schneider, holds and illuminates that which is palpably (immediately, affectively, kinaesthetically, and profoundly) relevant, within the client and between client and therapist. Presence holds and illuminates that which is charged in the relationship and implies the question, "What's really going on here, within the client and between me and the client?" Presence is the "soup" or atmosphere within which deep disclosure can occur, and based on this disclosure, the client's core battles become clarified. Invoking the actual refers to the invitation to the client to engage that which is palpably relevant. By invoking the actual, the therapist calls attention to the part of the client that is attempting to emerge, break through, and overcome stultifying defenses. Invoking the actual is characterized by such invitations (and sometimes challenges) as, "What really matters to you right now?", or "I notice that your eye moistened as you made that statement", or "What feelings come up as you speak with me?" At times, invoking the actual calls attention to content/process discrepancies, such as "You say that you are angry but you smile." If invoking the actual calls attention to that which is emerging in the client's experience, vivifying and con-

fronting resistance call attention to that which blocks what is attempting to emerge. These blocks or resistances are seen as life-lines from the existential-integrative point of view, but they are also acknowledged as progressively defunct. Vivifying resistance "alerts" clients to their defensive blocks, while confronting resistance "alarms" or "jars" them about those blocks. Together, vivifying and confronting resistance serve to intensify and eventually mobilize clients' counterresistances (the "counter-will" as Otto Rank has put it); it is these counterresistances that liberate vitality, bolster choice, and incite change. In the final stage of existential-integrative encounter, therapists help clients to consolidate the meanings, values, and directions of their present lives. Although meaning creation evolves naturally and spontaneously following breakthroughs over one's resistance, sometimes it requires a gentle prod. For example, a therapist might challenge a client to translate her newfound boldness into her constricted work relationships.

To sum, existential-integrative therapy, like existential therapy generally, assists clients to grapple with their experiences of life, not just their reports about life, and through this illumination, supports their intentional and embodied engagement with life.

III. CONSTRUCTIVIST THERAPY

"Constructivism"² refers to a group of theories holding the philosophical position that "reality" is, in some ways, created by (as opposed to thrust upon) persons. Constructivist therapists are faced with the challenge of understanding the lived reality of each client, not imposing some objective truths on all persons seeking their help. On this basis, constructivists believe that lives can be transformed and horrors transcended when we grasp the unique, personal, and richly powerful "realities" each of us has created. Therapy (and research, for that matter) is a cocreated experience between therapist and client, mutual experts on different aspects of the lived reality being created between them. This egalitarian relationship can be seen as more client empowering than approaches in which the more powerful therapist imposes diagnostic and treatment "realities" on the less powerful client. After briefly describing constructivism, we will discuss

² See also postmodernism/postmodern or poststructural philosophy/therapy.

some general aspects of constructivist therapy followed by a brief illustration of a few constructivist approaches.

Although all constructivists agree that reality cannot be known directly, different theoretical groups disagree on the exact nature of the relationship between the person and the world. Radical constructivists argue that it makes no sense to even speak of a reality outside of the meanings the person has created. Because reality cannot exist other than our construing it into existence, radical constructivists would argue that the meanings we create totally determine our experience of the world. Social constructivists would go to the other extreme. We are saturated with meanings created by cultures and imposed on us. Occupying a middle ground between these two extremes, critical constructivists argue that meanings are created in the dynamic interaction between the person and the world. In other words, although we cannot know it directly, the world is real, integral, and unfolding around us.

Constructivist therapies generally share certain attitudes about therapy. For example, most constructivists will listen to clients from the assumption that everything the client says is “true” in the sense of revealing important aspects of the client’s experiential meaning system. (This attitude is termed the credulous approach by some constructivists.) Similarly, there is a respect for contrast, oppositionality, or the dialectic as integral to meaning making. Most constructivists also are very attuned to making the therapy room a safe place for clients to experience life, explore, and grow. Without safety, creative encounter with the central meanings of one’s life is hampered; without creativity, reconstructing the bases of one’s existence is impossible. Finally, there is an emphasis on seeing the client as a process of meaning creation, rather than a static entity composed of specific meanings. This emphasis on seeing persons as processes implies that constructivists are always looking for the ways the client is changing from moment to moment or session to session. Art Bohart has taken this focus on client change and argued that therapy works because the self-healing client uses whatever the therapist does to grow and change.

As might be expected, different constructivist therapists employ these attitudes in different therapeutic approaches. Franz Epting, for example, is a leading proponent of George Kelly’s fixed role therapy. In fixed role therapy, the client first writes a character sketch that is open, revealing, yet sympathetic to the client’s experience. The therapist and client then cocreate an alternate sketch for the client to enact, typically for a 2-week period. Rather than being a behavioral prescrip-

tion, the procedure is designed to free the client to experiment with differing ways of experiencing life.

On the other hand, constructivist therapists such as Miller Mair, Robert Neimeyer, and Oscar Goncalves employ narrative approaches to therapy. These therapists believe that narratives give meaning and continuity to the lived experience of clients. Gaps, incompleteness, and incoherence in the client’s life story may indicate struggles in creating an integrated experience of self-in-the-world. Goncalves nicely illustrates constructivist narrative therapy with his “moviola” technique. This is a technique in which the therapist’s attention scans the settings of a client’s life, much like a camera in a movie. The therapist can zoom in on a detail or back off and get a more panoramic view. For example, a therapist might start by having the client describe the entire room in which a traumatic event occurred. Eventually, the therapist might help the client zoom in on the faces in the room, filled with fear and horror, while the abuse occurred. Because people intimately create meanings to understand their experiences, the experience of reviewing the abuse with an empathic therapist allows for new constructions to be created. These newer meanings, in turn, allow for newer experiences as clients’ lives move into the future.

Bruce Ecker and Laurel Hulley’s depth oriented brief therapy (DOBT) applies constructivist principles to understand and engage clients in radical change in a very short-term treatment. DOBT understands the symptom as painful because of the ways it invalidates important aspects of our experience. At the same time, there are other constructions, often at a lower level of consciousness, which makes the symptom absolutely necessary for the client. DOBT uses specific experiential techniques to help the client gain access to these deeper meanings. The client then can more consciously decide whether to keep or abandon these more unconscious meanings. For example, one client who described himself as a complete failure uncovered the ways in which his failure was rewarding. It served both as punishment for and proof to his parents that they had failed him in many ways.

Larry Leitner’s experiential personal construct psychotherapy (EPCP) is based on the relational, experiential, and existential foundations of constructivism. EPCP construes persons as simultaneously needing and being terrified of depths of emotional closeness. On the one hand, such intimate relationships can affirm the meanings that have formed the very foundation of our existence. On the other hand, we can experience devastating disconfirmation in intimate

relationships. Clients then struggle with needing to connect with others, risking terror to gain profound richness, versus retreating from intimacy, buying safety at the cost of the empty objectification of self and others. EPCP engages this struggle in the live relationship in the therapy room. Therapeutic growth can occur as the therapist offers optimal therapeutic distance, a blending of profound connection and separateness, when the therapist is close enough to feel the client's experience, yet distant enough to recognize those feelings as the client's and not the therapist's own.

Constructivist therapy also has been applied to special populations. For example, EPCP was an approach developed to understand and therapeutically engage the experiences of more severely disturbed clients, often those who have received *DSM* diagnoses such as "schizophrenia," "borderline," and "schizotypal." (Terms most constructivists would not countenance by the way.) Fay Fransella has applied constructivist therapy to stutterers. A central aspect of her therapy involves the creation of meaningful ways of encountering the world as a fluent speaker.

Tom Ravenette, using only blank sheets of paper and pencils, uses constructivist techniques to access the meaning-making system of children. For example, he will draw a bent line in the center of a page and have the child draw a picture incorporating the line. He then has the child draw a second picture, depicting an opposite to the one just drawn. As the child talks about the pictures, Ravenette enlarges the conversation to allow the child to say what she knows (but could not express) about her world. Linda Viney and Sally Robbins, working on the other end of the age spectrum, successfully utilize constructivist principles with elderly clients. Robbins, for example, has poignantly described using a constructivist version of reminiscence to help elderly clients come to terms with their lives and their deaths. Family system constructivists may use systemic bowties to help each client understand how their actions, based on their deepest fears, confirm the deepest fears of other family members. For example, in response to his fears that his wife does not love him, a client may respond vaguely to her when she is angry. She interprets the vagueness as his not respecting her, making her even angrier.

Finally, there is a growing literature empirically supporting the use of constructivist therapies. Linda Viney (in a 1998 issue of the journal *Psychotherapy: Theory, Research, Practice, Training*), for example, reviews 19 different studies exploring the effectiveness of personal construct therapy across different countries, ages, and

types of problems. Not only did she find substantial support for the effectiveness of constructivist therapy, she found effect sizes for client change to be at least as large as those reported in the cognitive-behavioral and psychoanalytic literature. In other words, good constructivist therapy respects the lived experiences of persons while being empirically supported using studies that meet the most rigorous of experimental criteria.

IV. TRANSPERSONAL THERAPY

The differences among the major humanistic approaches are certainly more of degree than of kind. There is a very wide overlap among transpersonal, existential, and constructivist modalities. However, whereas existential and constructivist therapies emphasize the interhuman, personal elements of client-therapist interaction, the transpersonal approaches accent the spiritual, religious, or cosmic implications of those dimensions. It is not that an existential- or constructivist-oriented therapist would exclude any such transpersonal theorizing—indeed, a number of them welcome such theorizing—however, on the whole, transpersonal therapists, above and beyond their existential and constructivist counterparts, bring to bear into their practices two basic knowledge domains: (1) religious faith traditions, and (2) mystical healing traditions. Religious faith traditions represent the seven major religious systems of the world—Buddhism, Hinduism, Islam, Judaism, Christianity, Taoism, and Confucianism—as well as the many indigenous lineages, such as Native American, Asiatic, and African traditions. Mystical healing traditions encompass a breathtaking span of indigenous, institutionalized, and individualized elements, but they all converge on one basic pattern—the experience of oneness with creation. While transpersonal therapists tend to be conversant with these transcendental viewpoints, it should be pointed out they do not draw on them to proselytize. Their essential task, by contrast—in accord with transpersonal pioneer C.G. Jung—is to facilitate client self-discovery.

In his essay from the germinal *Paths Beyond Ego*, edited by Roger Walsh and Frances Vaughan, Bryan Winitz sets forth several "postulates" of transpersonal psychotherapy. The first postulate proposes that transpersonal therapy embraces egoic, existential and transpersonal levels of human consciousness. This postulate derives from a "spectrum" model of human consciousness, developed formally by Ken Wilber, and used broadly by transpersonal scholars and practition-

ers. Roughly speaking, the spectrum model proposes a hierarchy of developmental psychospiritual stages, from the infantile “pre-egoic” stage to the culturally competent “egoic” stage to the personally inquiring “existential” stage to the unitive “transpersonal” stage. Although there are many nuances within this model, and diverse interpretations of its accuracy, it is nevertheless a core view for many transpersonalists.

The first postulate of transpersonal therapy then assumes a sweeping scope—all developmental stages of identity from the precultural (infantile) to the transcultural (sagely or saintly) are embraced. Moreover, for some in the transpersonal community, each developmental stage is a prerequisite to the next. One cannot, for example, simply “leap” from stage to stage, for example, from the conventional egoic stage to the transconventional “subtle” or “soul” level, without predictable difficulties and consequences. Among these are various kinds of regression, as manifested, for example, by the accomplished meditator who also semiconsciously indulges in alcohol, or the pious adept who concomitantly exploits others, and so on. Generally speaking, the more that clients can address and work through the stage of their developmental arrest, the greater their ability to advance to an expanded or “higher” developmental level. Put another way, the transpersonal therapist (like most depth therapists) must help clients “get through the night,” or manage their dysfunctionality, before he or she can assist them with profound or mystical realizations. Although other transpersonalists, such as Brant Cortright, believe that spiritual and mystical healing can, and often does, occur alongside of the dysfunctional, they do not discount the significance of addressing those dysfunctional states, and of supporting healing processes generally.

Wittine’s second postulate is that the therapist’s role in transpersonal therapy is critical. The therapist’s ability to hold and value psychospiritual healing refers directly back to his or her own psychospiritual work, awareness, and capacity to translate that work and awareness to the therapeutic setting. To the extent that therapists can “see” and acknowledge the unfolding spiritual implications in client’s quandaries, they embrace a deeper and broader therapeutic possibility for clients, a deeper and broader language within which to engage that possibility. Consider, for instance, the therapist who works strictly within a psychoanalytic frame and who views clients’ conflicts as derivative of circumscribed parental relationships; to what extent would such a therapist be open to implicit spiritual strivings in clients’ material—such as urges to wonder, yearnings to

transcend, or impulses to meld? The therapist’s presence to these spiritual possibilities is crucial—an entire therapeutic direction may hinge on what therapists ask about, how they inquire, and what they imply or suggest when they inquire. If a therapist is not attuned within himself or herself to the longing for or fear of an enlarged sense of spiritual meaning in a client’s rage or tearfulness, that client may never broach those motivations, and may feel shortchanged as a result. A conscious transpersonal therapist, on the other hand, can detect and call attention to emerging affects, images, symbolisms, and the like, that are bell-weather of profound spiritual or religious transformation; to the degree that one has not experienced and dealt with such intensities within oneself, however, it is doubtful that one could facilitate them in others. Great care, finally, needs to be taken in calling attention to emerging spiritual concerns—as with all humanistic therapies, it is the client, not the therapist, who must ultimately decide his or her fate, and the meaning or significance of that fate.

Wittine’s third postulate is that transpersonal therapy is “a process of awakening from a lesser to a greater identity.” By “awakening,” transpersonal therapists mean enlarging or expanding one’s identity. The enlargement of one’s identity invariably entails disruption, pain, and relinquishment. One cannot simply “leap over” one’s former way of living, particularly if it has been familiar and “safe,” and fail to experience disturbance. This disturbance becomes particularly acute if one lacks the means and resources to address it. For example, there is a major difference between an identity crisis that evolves gradually within familiar circumstances, and one that “shatters” or overtakes one abruptly. The experience that transpersonal therapists term “spiritual emergency” is an example of the latter variety of crisis. In spiritual emergency (which is to be distinguished from brief psychotic episodes or nonspiritual “breakdowns”), clients experience an acute transpersonal tear or rupture in their conventional experience of the world. This rupture may take the form of psychic openings, for example, visions, voices, telepathic states; or shamanic-like alterations of consciousness, such as channeling experiences, possession states, and UFO encounters.

According to Cortright, who draws on the foundational work of Stanislav and Christina Grof, there are three distinguishing features of those undergoing spiritual emergency: (1) They display changes in consciousness in which there is significant transpersonal consciousness; (2) they have an ability to view the condition as an inner psychological process, amenable to

inner psychological resources; and (3) they have the capacity to form a sufficient working alliance with a therapist. Although these features stand in marked contrast to relatively nontranspersonal, nonintrospective, and oppositional crisis clients, there are many gradations when it comes to spiritual emergency and there is as yet no firm consensus as to which clients fit which criteria. The general consensus for treating spiritual emergency clients, according to Cortright, is to help “ground” or support them, to offer deep and abiding presence to their struggle, and to draw on diet, exercise, massage, proper rest, meditation, and (when necessary) medication, to begin their healing path. Following these initial steps, a more depth-experiential approach can be implemented. The goal of such an approach, as with most transpersonal approaches, is to assist clients to integrate and transform split-off parts of themselves, and to facilitate expanded consciousness.

In general, transpersonal work proceeds through a series of steps that increase clients’ awareness. The more that clients can become aware of stifling or debilitating patterns, the more they are in a position to question and reshape those patterns. Although most therapists facilitate expanded awareness, transpersonal therapists create an atmosphere and make available methods that carry clients beyond conventional change parameters. Hence, whereas a cognitive therapist might help clients to deconstruct maladaptive beliefs, a transpersonal therapist would work with clients to deconstruct maladaptive attachments—beliefs, values—any core investitures that warp or curtail consciousness. Among the means that transpersonalists employ to facilitate such emancipations are meditative breathing, mindfulness and concentration exercises, guided visualization, stress reduction techniques, sustained self-observation, experiential reflection, disidentification exercises, demystifying dialogue, and somatic practices.

To sum, transpersonal therapists tend to be integrative therapists. They employ egoic stances (e.g., medical, psychoanalytic, cognitive) when questions of adjustment or personal identity are at stake, and transpersonal modes (e.g., spiritual-existential, contemplative) when issues of emancipation, enlightenment, or transpersonal identity arise. The question as to “who am I” is relentlessly pursued by transpersonal therapists. Although there are many gradations and variations among transpersonal practices, several principles stand out: Transpersonal therapy addresses the entire spectrum of (purported) consciousness; the therapist’s personal role is critical; and the enlarging or awakening of identity is the core of transpersonal practice.

V. EMPIRICAL STUDIES OF HUMANISTIC THERAPY

Humanistic therapy occupies a unique position among organized psychological practices. Whereas conventional therapies target overt and measurable symptom change as indicative of “effective” therapeutic outcome, humanistic approaches recognize many alternative criteria. Among these are shifts, not just in symptomatology, but in values, attitudes, and approaches toward life. To the extent that one becomes a “qualitatively new person,” as Alvin Mahrer puts it, or develops new talents, capacities, and appreciations for life, as Rollo May has put it, one fulfills humanistic standards. For humanists, it is one thing to “return to a previous level of functioning,” or to adjust to one’s spouse, or to become more productive at work, and quite another to supersede one’s previous level of functioning, to deepen one’s connection with one’s spouse, and to become passionate about one’s vocation. Whereas the latter tend to be overt and quantifiable, the former tend to be tacit, intimate, and qualitative. Given the confines of conventional research methodology (e.g., randomized controlled trials, objectified rating scales), humanistic therapies have become forgotten “stepchildren” in the competitive outcome battles. The empirical challenge of humanistic therapies is formidable: How does one assess the depth and breadth of intimate humanistic change? Or in short, how does one match the methodology with the mission?

Given these thickets of difficulty, humanistic researchers have turned to two basic investigative modalities to study therapeutic outcome—innovative quantitative methodology, and that which humanistic trailblazer Amedeo Giorgi terms “human science research methodology.” Although quantitative methodology has been found to be wanting by many in the humanistic community (e.g., because of its restrictive procedural requirements) for others, it has been considered both adaptable and informative. Since the 1950s, for example, Carl Rogers and his successors have undertaken a series of quantitative investigations of client-centered therapies. Among the prominent findings from these studies, and continuing today, are (1) robust support for therapist relationship factors—e.g., empathy, warmth, and genuineness—over therapist technical offerings (e.g., skilled interpretations), and (2) support for client agency, as opposed to therapist directiveness, as central to successful therapeutic outcome (as discussed in Bohart et al.’s 1997 review). Recent meta-analyses (large-scale analyses of aggre-

gated studies) confirm these findings. These have found, for example, that fully 30 to 35% of the variance in general therapeutic outcome is accounted for by therapist and relationship factors whereas only 15% of the variance is accounted for by techniques or therapeutic approaches (as discussed in Bohart and colleagues' 1997 review). Coupled with the research on affective expression and therapeutic outcome (see, for example, the studies in Greenberg et al.'s 1998 work), these quantitative findings provide broad support for humanistic practices.

In addition to these broad findings, there is specific quantitative evidence for the effectiveness of specific humanistic outcome. For example, there is specific evidence for the effectiveness of client-centered therapy for a variety of disorders; there is also evidence for the effectiveness of Gestalt therapy; and there is considerable evidence for the saliency of the underlying principles of meditative, experiential, and existential modalities. (See the Cain & Seaman volume for an elaboration).

There have also been important quantitative investigations of humanistic psychiatric practices. Drawing from the foundational work of R.D. Laing, Loren Mosher and his colleagues have studied numerous psychiatric "safe-houses." These facilities emphasize relational over medical and egalitarian over hierarchical therapeutic environments. Such programs, concluded Mosher after a 25-year review, are as effective or more effective than conventional hospital care, and on average, less expensive.

With regard to human science or qualitative inquiry into humanistic therapies, particularly therapeutic outcome, there have been far fewer rigorous studies. While the reasons for this situation are beyond the scope of this article, suffice it to say that there is a burgeoning new interest in such inquiry. Increasingly, sophisticated qualitative designs are being developed, such as Robert Elliott's Hermeneutic Single Case Efficacy Design, David Rennie's Grounded Theory Method, Arthur Bohart's Adjudication Model, and Kirk Schneider's Multiple Case Depth Research. These innovative formats hold the promise for important new inroads into outcome assessment. In the meantime, humanistic therapies enjoy wide qualitative support in a variety of case, observational, and testimonial modalities; the current emphasis is on formalizing those modalities.

VI. SUMMARY

Humanistic therapy is a multifaceted perspective that emphasizes existential, constructivist, and transpersonal practice philosophies. Varied as they are, these philosophies explore (1) what it means to be fully, experientially human, and (2) how that understanding illuminates the vital or fulfilled life. By assisting people to grapple with these perspectives, humanistic therapies empower people to become more of who they profoundly aspire to be; and in consequence more of who they are.

See Also the Following Articles

Alternatives to Psychotherapy ■ Existential Psychotherapy ■ Feminist Psychotherapy ■ Gestalt Therapy ■ Individual Psychotherapy ■ Integrative Approaches to Psychotherapy ■ Interpersonal Psychotherapy

Further Reading

- Bohart, A. C., O'Hara, M., Leitner, L. M., Wertz, F. J., Stern, E. M., Schneider, K. J., Serlin, I. A., & Greening, T. C. (1997). Guidelines for the provision of humanistic psychosocial services. *Humanistic Psychologist*, 24, 64–107.
- Cain, D. J., & Seaman, J. (2002). *Humanistic psychotherapies: Handbook of research and practice*. Washington, DC: American Psychological Association.
- Cortright, B. (1997). *Psychotherapy and spirit: Theory and practice in transpersonal psychotherapy*. New York: SUNY Press.
- Greenberg, L. S., Watson, J. C., & Lietaer, G. (1998). *Handbook of experiential psychotherapy*. New York: Guilford.
- May, R., Ellenberger, H., & Angel, E. (1958). *Existence: A new dimension in psychology and psychiatry*. New York: Basic Books.
- Moss, D. (1999). *Humanistic and transpersonal psychology: A historical and biographical sourcebook*. Westport, CT: Greenwood Press.
- Neimeyer, R. A., & Raskin, J. R. (Eds.). (2000). *Constructions of disorder: Meaning making frameworks for psychotherapy*. Washington, DC: American Psychological Association Press.
- Schneider, K. J. & May, R. (1995). *The psychology of existence: An integrative, clinical perspective*. New York: McGraw-Hill.
- Schneider, K. J., Bugental, J. F. T., & Pierson, J. F. (2001). *The handbook of humanistic psychology: Leading edges in theory, research, and practice*. Thousand Oaks, CA: Sage.
- Walsh, R., & Vaughan, F. (Eds.). (1993). *Paths beyond ego: The transpersonal vision*. Los Angeles, CA: Tarcher.



Implosive Therapy

Donald J. Levis

Binghamton University, New York

- I. Description of Treatment
- II. Theoretical Bases
- III. Empirical Studies
- IV. Summary
- Further Reading

GLOSSARY

implosive therapy A technique that involves use of an *in vivo* or imagery presentation procedure designed to extinguish via repetition those aversive conditioned cues responsible for eliciting and maintaining symptom execution.

neurotic paradox Why neurotic behavior is at one and the same time self-defeating and self-perpetrating.

imagery exposure Imaginal exposure of the feared or anxiety-evoking stimulus, using flooding in implosive therapy.

Implosive (flooding) therapy is a learning-based exposure technique of psychotherapy designed to treat a wide variety of maladaptive behaviors in a relatively short time period. The underlying theoretical model for this behavioral cognitive treatment approach to therapy is based on an extension of two-factor avoidance learning theory.

I. DESCRIPTION OF TREATMENT

A. Introduction

Imagine the suffering of a woman who becomes so panic stricken by the obsession she has cancer that psychiatric hospitalization is required. No matter how much medical assurance she is given that she is in excellent physical health, the nagging doubt somehow persists that she is not. Or consider a man who is forced to relinquish his professional career because he is afraid to leave his home out of fear that dog feces may be in his yard. His day becomes dominated with disturbing thoughts that find relief only in repetitious washing of his hands, clothes, and body. Perhaps it is hard to comprehend how one could become so frightened of bath water that a life preserver must be worn, or that a sound of a locomotive whistle in the distance evokes such terror in an individual that he runs around in a circle screaming at the top of his voice. The range of human fears may be extended almost indefinitely. Some individuals break out in a cold sweat at the sight of a car, an airplane, or a tall building. Others become so afraid of their own sexual feelings that they avoid the opposite sex, having become convinced they will be sent to hell for such feelings. Still others fear failure, loss of control, taking responsibility, being angry, or giving love and expressing compassion.

Committed to the goal of seeking methods to ameliorate such psychological suffering, the mental health

worker is confronted with the difficult task of selecting from hundreds of different treatment techniques. The rather chaotic state of the field today suggests the need to isolate and maximize the central procedural variables that appear to be reliably correlated with behavior change. One factor common to most treatment techniques stems from the observation that behavior change appears to occur following the elicitation from the patient of a strong emotional response to material presented during the therapeutic interaction. Implosive therapy is a treatment technique that is designed to maximize in a systematic manner the last-noted common denominator of therapeutic interaction, that of emotional responding and its resulting effects. Disillusioned with the insight-oriented emphasis of the time period, Thomas G. Stampfl in the late 1950s developed the technique of implosive therapy which some authors today call flooding therapy or response prevention therapy. Each of these terms is frequently used interchangeably in the literature since the goal of therapists is to maximize emotional responding by getting patients to confront their fears directly. Stampfl was the first investigator to extend systematically his learning-based exposure treatment approach to the treatment of a wide variety of clinical nosologies. Borrowing a term from physics he labeled his newly developed cognitive-behavioral approach implosion, to reflect the inwardly bursting (dynamic) energy process inherent in the release of affectively loaded environmental and memorial stimuli encoded in the brain.

Stampfl was initially influenced by the extensive clinical experience he gained from conducting "nondirective" play therapy with emotionally disturbed children. He concluded from this experience that exposure to the emotional stimulus features of the play material could account for virtually all the positive effects of therapy. Consistent with his clinical observations was the insistence by Abraham Maslow and Bela Mittleman in their 1951 abnormal text that the neurotic's symptoms, defense mechanisms, and general maladaptive behavior resulted from a state of anticipation or expectation of an impending catastrophic event, which, in turn, provided the motivating force for symptom development. These authors concluded that, although the catastrophic even usually remained unspecifiable by the patient, it generally involved fears associated with anticipation of abandonment, injury, annihilation, condemnation and disapproval, humiliation, enslavement, loss of love, and utter deprivation. Stampfl reasoned that if therapy was to succeed, these anticipatory fears, as was the case for the children he treated, needed to be

confronted directly in order for the unlearning of the emotional response attached to these fears.

B. *In Vivo* Exposure Approach

Stampfl at first adopted an *in vivo* exposure approach in which he instructed patients to confront directly in real life their feared stimulus situation. For example, one of his patients, a college student, reported a compulsive behavior he had engaged in for years. Upon retiring at night, this patient reported an urge to check to see if he had left the radio on. Every night (without exception) he checked the radio up to 50 times. He reported that any time he failed to engage in radio checking he developed much apprehension and anxiety and the feeling that something "terrible" or "catastrophic" might happen. He would fear, for example, that perhaps a short circuit would occur and a fire would result. Stampfl then instructed the patient to confront his fears directly by forcing himself not to check the radio and imagine that his worst fears would happen. He was asked to let himself tolerate as much anxiety as possible. The patient was able to follow the therapist's instruction; he reported seeing the radio burst into flames and hearing his father's voice telling him to "turn off the radio." Following additional repetitions of the therapist's instructions, the patient recalled a number of traumatic memories involving his father. Once the affect associated with these memories was eliminated, his compulsive symptoms disappeared.

C. Imagery Exposure Approach

Thomas Stampfl recognized that although this patient followed his *in vivo* instructions to confront directly the anxiety he experienced, most patients avoid engaging in an *in vivo* task because of the strength of the fear response associated with the task. He also recognized that many of the fears motivating the patient's symptoms did not lend themselves readily to an *in vivo* approach. He then developed his implosive imagery procedure, which was capable of being presented within the context of a therapy session. In an attempt to illustrate the above point, consider the case of an airplane phobic. Although most phobic behavior is clearly amenable to an *in vivo* exposure approach, the use of this procedure with an airplane phobic would entail the therapist's accompanying the patient on repeated airplane trips. Stampfl recognized that his imagery exposure procedure had the advantage of presenting the feared cues in the therapist's office. Furthermore, and

most importantly, the imagery technique has the additional advantage of introducing the more salient and emotionally intense fear cues associated with the phobic reaction that do not lend themselves to direct *in vivo* presentation. Examples of such fear cues include the fear of the plane crashing, the fear of dying, and the fear of being punished for guilt-producing behavior in the after-life. Imagery scenes involving the incorporation of these non *in vivo* presented fears have been clinically shown to produce a powerful emotional reactivity and subsequently a lasting therapeutic effect.

In summary, the fundamental task of the implosive therapist is to repeatedly re-present, reinstate, or symbolically reproduce those stimulus situations to which the anxiety response has been learned or conditioned. By exposing the patient to the stimulus complex of fear cues that are being avoided, the patient will be confronted with the full emotional impact of these cues. As a function of repetition, this emotional exposure weakens and eventually eliminates the connection between the eliciting stimulus and the resulting emotional response. For example, imagine a patient who is terrified of viewing horror films and takes a job as a movie projectionist which requires him to show such a movie. Although terrified during the first showing, by the tenth time he is exposed to watching the film little emotional reactivity is left.

It may at first seem that the goal of specifying the aversive learned events in the patient's life history represents a difficult, if not impossible, task. Stampfl noted that it is feasible for a trained clinician to locate "key" stimuli associated with the patient's problem area following in-depth diagnostic clinical interviews. This information allows a trained clinician to formulate hypotheses as to the type of traumatic events that may have contributed to the client's problems. Of course, these initial hypotheses must be conceived as only first approximations in the quest to determine the aversive cues controlling the patient's maladaptive behavior. As therapy progresses, it is usually possible to obtain additional information as to the validity of these cues and to generate new hypotheses. The elicitation of these hypothesized cues in imagery frequently results in the reactivation of the patient's memory regarding the initial historical events associated with development of the patient's conflict and fears. However, it is not essential to present imagery scenes that are completely accurate since some effects of emotional unlearning or extinction effects will occur through the established learning principle of generalization of extinction. Naturally, the more accu-

rate the hypothesized cues are and the more realistically they are presented by the therapist, the greater will be the emotional arousal obtained and subsequently the greater the emotional unlearning to the cues presented. This process is continued until the patient's symptoms are reduced or eliminated.

D. Procedural Instructions

Following the completion of two to three interview sessions, a treatment plan is developed. Patients are provided the rationale and theory behind the technique. A commonly used approach is to ask patients the following question: if they were learning to ride a horse and fell off the horse, what would the instructor have them do? (The usual answer is to get back on the horse.) The therapist might then comment that failure to get back on the horse might result in an increase in fear and possibly the generalization of that fear to events surrounding riding horses. The point is to illustrate that fears can be overcome by directly confronting them. Patients are told that the procedure being used involves an imagery technique and they will be asked to imagine various scenes directed by the therapist. Patients are instructed to close their eyes and play the part of themselves. They are asked, much as an actor or actress would be, to portray certain feelings and emotions that represent important parts of the process. They are told that belief or acceptance, in a cognitive sense, of the themes introduced by the therapist is not requested, and little or no attempt is made to secure any admission from patients that the cues or hypotheses actually apply to them. Following the administration of neutral imagery practice sessions, the therapist is ready to start. Once the implosive procedure is started, every effort is made to encourage patients to "lose themselves" in the part that they are playing and "live" or reenact the scenes with genuine emotion and affect. Compliance with the technique is readily obtained and rarely do patients terminate therapy prematurely.

Thomas Stampfl's procedure encompasses an operational feedback approach that is self-correcting. If the hypothesized cues introduced into a given scene presentation elicit emotional affect, support for their continued use is obtained. The greater the emotional arousal elicited by these cues, the greater the support for their use. Cues that do not elicit emotional arousal are abandoned and replaced by new hypothesized cues. This process is continued until the desired emotional affect is obtained and unlearned. Therapy continues until symptom reduction occurs. Significant levels of

symptom reduction usually occur within 1 to 15 hours of treatment.

E. Stimulus Cue Categories

As a guide in using the therapy, Thomas Stampfl has outlined the use of four cue categories that can be conceptualized in terms of progression along a continuum that ranges from extremely concrete to hypothetical. These four cue categories, in order of their presentation, are as follows: (1) Symptom-contingent cues, those cues correlated with the onset of the patient's symptoms; (2) reportable internally elicited cues, those verbally reported thoughts, feelings, and physical sensations elicited by presentation of the symptom correlated cues; (3) unreported cues hypothesized by the therapist to be related to the second cue category; and (4) hypothesized dynamic cues, those fear cues suspected to be associated with an unresolved conflict situation being avoided by the patient.

As an illustration of the application of these cue categories, consider the case of a woman who had to wear a life preserver while taking a bath. The symptom-contingent cues would encompass the presentation in imagery of all those cues surrounding her taking a bath without wearing a life preserver. Upon presentation of these cues, she reported the feeling that the bathtub consisted of a "bottomless pit of water," the second category. This in turn led to the therapist's hypothesis that she was afraid of drowning (third category). Because the patient manifested considerable feelings of guilt, the therapist hypothesized that the patient's fear of drowning related to her fear of being punished in hell (the fourth cue category). The systematic presentation and repetition of all these fear cues led to the elimination of the patient's phobic response and to the recovery of a memory in which she almost drowned in a bath tub when she was a child. Since repetition of the feared stimuli is considered an essential requirement in producing symptom reduction and elimination, patients are expected to conduct homework that involves 20 minutes daily of repeatedly imagining the scenes assigned to them by the therapist.

II. THEORETICAL BASES

Implosive theory is unique in its ability to integrate areas of psychology, in its resolution of the neurotic paradox, and in its ability to define complex behavior

according to basic principles of experimental psychology. To explain theoretically the development, maintenance, and unlearning (extinction) of psychopathology, Stampfl adopted and extended O. Hobart Mowrer's 1947 version of two-factor avoidance learning. Mowrer was influenced by Sigmund Freud's conclusion in 1936 that human symptoms reflecting psychopathology resulted from patients' attempts to escape and avoid the anxiety elicited by stimuli ("danger signals") associated with past exposure to traumatic experiences. Mowrer then concluded that the development and maintenance of human and animal avoidance (symptom) behavior involved the learning of two response classes.

A. Emotional Learning

The first response learned is how one becomes afraid of a previously nonaversive stimulus situation. To explain how fear is learned, Mowrer relied on the well-established laws of classical conditioning. Fear and other emotional conditioning result from the simple contiguity of pairing this nonemotional stimulation, in space and time, with an inherent primary (unlearned) aversive event resulting in the production of pain, fear, frustration, or severe deprivation. This biologically reactive, pain-producing stimulus is referred to as the unconditioned stimulus (UCS). Following sufficient repetition of the neutral stimulus with the UCS, the neutral stimulus becomes capable of eliciting the emotional response with which it was paired. Once the process is learned, the neutral stimulus is referred to as a conditioned stimulus (CS) and its elicitation of the emotional response (e.g., fear) as the conditioned response (CR). Stampfl believes the conditioning events of humans to be multiple, involving a complex set of stimuli comprising both external and internal CS patterns. Such conditioning events are believed to be encoded in long-term memory and capable of being reactivated at a later point in time.

B. Avoidance (Symptom) Learning

Mowrer viewed the resulting conditioned emotional response as a secondary or learned source of drive, possessing motivational or energizing properties, as well as reinforcing properties. These motivational properties of the conditioned emotional response set the stage for the learning of the second class of responses, referred to as avoidance or escape behavior. Avoidance or symptom

behavior is believed to be governed by the established laws of instrumental learning. Avoidance behavior is learned because the response results in the termination or reduction of the emotional state elicited by the CS. It is this reduction in aversiveness that serves as the reinforcing mechanism for the learning of the avoidance behavior.

C. Emotional-Avoidance Unlearning

Finally, Mowrer's two-factor theory argues that both emotional responding and subsequent avoidance behavior can be readily unlearned via the well-established principle of Pavlovian extinction. This principle states that the repeated presentation of the classically conditioned CS will weaken and cease to elicit emotional responding via the principle of non-reinforced CS exposure. The extinction of the CS results in the extinction of its drive properties. Without any motivating state to elicit and reinforce the avoidance behavior, it also will undergo an extinction effect. This is the therapeutic premise on which implosive therapy is based.

D. The Neurotic Paradox and Symptom Maintenance

Implosive theory has been instrumental in resolving Freud's expressed concern and puzzlement as to why patient's symptomatology may persist over the course of a lifetime. Mowrer labeled this concern the "neurotic paradox." In Mowrer's words it is a question as to why neurotic behavior is at one and the same time self-defeating and self-perpetuating. In other words, why does the neurotic's neurosis persist to the point of seriously incapacitating the individual when the behavior has long outlived any real justification?

To resolve theoretically the issue of sustained symptom maintenance, Thomas Stampfl developed his serial CS hypothesis. He observed that, although some clinical symptoms do appear to last for lengthy periods, the CSs initially eliciting the symptom frequently undergo a change over time, with the cues originally triggering the symptom failing to serve as an eliciting stimulus to repeated CS exposure. However, as they weaken, these cues are replaced from memory by a new set of previously unexposed fear cues that upon exposure recondition secondarily the first set of cues. When the new set of released cues also undergo an extinction effect from nonreinforced CS exposure, the stage is set for yet another set of new cues to be released. This process con-

tinues until all the encoded fear complex of cues undergo an extinction effect. In other words, implosive theory maintains that there is a network of cues representing past conditioning events involving pain which are stored in memory and which, upon reactivation, are capable of motivating a symptom over time. Thomas Stampfl believes these conditioned cues are stored in memory in a serial arrangement along a dimension of stimulus intensity, with the more aversive cues being least accessible to memory reactivation. Repeated symptom execution prevents further CS exposure to these cues and to the elicitation of those cues stored in memory. As a result, the anxiety and fear level attached to these unexposed CSs are conserved or maintained until they are exposed by being released from memory. The presence of these unexposed cues stored in memory, along with the intense emotional reactions conditioned to them, can be observed by preventing symptom occurrence.

III. EMPIRICAL STUDIES

Over the last 50 years, O. Hobart Mowrer's two-factor avoidance theory and related fear theories have generated an abundance of experimental support at both the human and animal level of analysis. It still remains the dominant avoidance theory within the field. Stampfl's extension of the theory to the area of psychopathology has also received strong empirical support at the human, animal, and clinical levels of analysis. This includes his serial CS hypothesis and his extension of the conservation of anxiety hypothesis to explain symptom maintenance and the neurotic paradox. Stampfl's techniques of *in vivo* and imagery implosive therapy and related CS-exposure techniques of treatment have been experimentally supported by a host of controlled clinical outcome studies, including studies involving the treatment of phobias, anxiety reactions, obsessive compulsive behavior, trauma victims, depression, and psychotic behavior. The procedure has also been shown to be nonharmful. Today, CS exposure techniques of treatment are regularly recommended as the treatment of choice for a number of clinical nosologies.

IV. SUMMARY

Implosive (flooding therapy) therapy is a cognitive behavioral treatment approach to psychopathology. It was first developed by Thomas G. Stampfl and extended

to encompass the treatment of a wide variety of clinical nosologies. Treatment effects are regularly reported to occur within 1 to 15 treatment sessions. The technique involves the use of an *in vivo* or imagery presentation procedure designed to extinguish, via repetition, those aversive conditioned cues responsible for eliciting and maintaining symptom execution. The therapist's task is to help the patient confront these cues directly within and outside the therapist's office. The underlying theoretical framework behind this technique is based on two-factor avoidance theory which Stampfl has extended to account for symptom maintenance and symptom extinction. Both the theory and treatment technique has been supported by considerable experimental research over the last 40 years at the human, patient, and animal level of analysis.

See Also the Following Articles

Avoidance Training ■ Classical Conditioning ■ Coverant Control ■ Emotive Imagery ■ Exposure *in Vivo* Therapy

Further Reading

- Boudewyns, P. A., & Shipley, R. H. *Flooding and implosive therapy: Direct therapeutic exposure in clinical practice*. New York: Plenum Press.
- Levis, D. J. (1985). Implosive theory: A comprehensive extension of conditioning theory of fear/anxiety to psychopathology. In S. Reiss, & R. R. Bootzin (Eds.), *Theoretical issues in behavior therapy* (pp. 49–82). New York: Academic Press.
- Levis, D. J. (1989). The case for a return to a two-factor theory of avoidance: The failure of non-fear interpretations. In S. B. Klein, & R. R. Mowrer (Eds.), *Contemporary learning theories pavlovian conditioning and the status of traditional learning theory* (pp. 227–277). Hillsdale, NJ: Erlbaum Associates.
- Levis, D. J. (1995). Decoding traumatic memory: implosive theory of psychopathology. In W. O. Donohue, & L. Krasner, (Eds.), *Theories of behavior therapy* (pp. 173–207). American Psychological Press, Washington, DC.
- Levis, D. J., & Boyd, T. L. (1985). The CS exposure approach of implosive therapy: In R. Turner, & S. L. M. Ascher (Eds.), *Evaluation of behavior therapy outcome* (pp. 59–94). New York: Springer.
- Levis, D. J., & Brewer, K. E. (2000). The neurotic paradox. In R. R. Mowrer, & C. B. Klein (Eds.), *Handbook of contemporary learning theories* (pp. 561–597). Hillsdale, NJ: Erlbaum Associates.
- Stampfl, T. G. (1970). Implosive therapy: An emphasis on covert stimulation. In D. J. Levis (Ed.), *Learning approaches to therapeutic behavior change* (pp. 182–204). Chicago: Aldine.
- Stampfl, T. G. (1991). Analysis of aversive events in human psychopathology, fear and avoidance. In M. R. Denny (Ed.), *Fear, avoidance and phobias: A fundamental analysis* (pp. 363–393). Hillsdale, NJ: Erlbaum Associates.
- Stampfl, T. G., & Levis, D. J. (1973). Implosive therapy. In R. M. Jurjevich (Ed.), *The international handbook of direct psychotherapy Vol. 1: Twenty-eight american originals* (pp. 83–105). Coral Gables, FL: University of Miami Press.

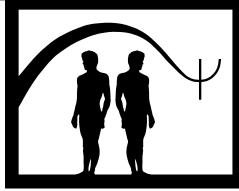

Individual Psychotherapy

Larry E. Beutler and T. Mark Harwood

University of California, Santa Barbara

- I. Development of Individual Psychotherapy
 - II. Theoretical Models of Individual Psychotherapy
 - III. The Effects of Individual Psychotherapy
 - IV. Summary
- Further Reading

GLOSSARY

behavior therapy A theory of psychotherapy in which problems are assumed to have been learned because the consequences of problematic behavior and feelings are rewarding. These treatments attempt to directly alter behavior and feelings by changing the pattern of consequences. The development of these models of treatment is most closely associated with Joseph Wolpe and B. Fred Skinner.

cognitive therapy/cognitive-behavior therapy Models of psychotherapy that attribute problematic feelings and behaviors to one's inappropriate or dysfunctional ways of thinking. The most recognized of these approaches was developed by Aaron T. Beck.

effectiveness studies Research designs that employ representative clinical populations of patients, as well as samples of therapists and psychotherapy. This type of research typically sacrifices some degree of experimental control for procedures that are closer approximations of actual clinical settings, procedures, and populations.

efficacy studies Research designs that employ randomized assignment, closely controlled and monitored treatments, and carefully selected and homogeneous samples of patients. This type of research typically sacrifices some degree of generalizability for experimental control.

experiential therapy Approaches to psychotherapy that emphasize the positive role of feelings and current experience. These approaches assume that efforts to stifle or avoid certain feeling states are at the basis of most human problems. They emphasize the role of the present, of feeling recognition, and of the innate human drive to grow (self-actualization) as processes that produce beneficial change.

exposure therapy Approaches to treatment that emphasize the importance of systematic exposure to situations and objects that evoke avoidance. This is a form of behavior therapy but has been incorporated into many models and approaches to cognitive and cognitive-behavior therapy as well.

integrative/eclectic psychotherapy Methods of intervention that draw from multiple theories. These approaches emphasize that the effectiveness of the procedure rather than its theoretical framework should be the guide to its application. These approaches range from those that blend different theoretical constructs to those that develop a case mix of specific techniques. Newer models are based on the development of cross-cutting principles of change rather than amalgamations of either specific techniques or general theories.

psychoanalysis The method of uncovering unconscious impulses and wishes that was developed by Sigmund Freud.

psychodynamic therapy: Approaches to psychotherapy that generally assume that behavior is caused by inner conflict and by disturbed psychic processes. These models of individual psychotherapy are generally short-term or less intensive variations of psychoanalytic therapies. Some of these variations include those built on object relations theory, ego psychology, and self-psychology.

Individual psychotherapy is the most typical form of psychotherapeutic treatment. It consists of one patient and one therapist. The psychotherapist, assuming the role of healer, authority, facilitator, or guide, employs a variety of theories and procedures to assist the patient or client to modify behaviors and feelings, gain understanding of self and others, change perceptions and beliefs, and reduce fears and anxieties. This entry will describe some of the more dominant methods of psychotherapy and the current status of research on its effects.

I. DEVELOPMENT OF INDIVIDUAL PSYCHOTHERAPY

The field of modern psychotherapy is over 100 years old. Freud is typically credited as the individual most responsible for introducing contemporary psychotherapy, in the form of psychoanalysis, to the Western world at the end of the nineteenth century. Almost from its inception, the developmental history of modern psychotherapy has been one of conflict, controversy, and change. Freud's early views were under attack nearly from the beginning, both from his students and from the established medical system. Conflict continues with the trend of growth and the emergent influence of various groups who present views that contrast with established schools of thought. In this environment, we have seen the emergence of literally hundreds of different theories and approaches to psychotherapy. Presently, psychotherapies differ in their theoretical constructs, their mode of delivery, their techniques, and the processes to which they attribute the patient's problems.

Those who are endowed by society with conducting and overseeing the field are also diverse, ranging from those with medical and psychological degrees to those with degrees in sociology, human development, social work, anthropology, group process, biology, and the like. Opinions about the nature of desirable credentials, advantageous types of experience and training, and the nature of psychotherapy itself are far from uniform. Yet, the prototype of "Individual Psychotherapy," a process that occurs between an individual person who has a problem and an individual practitioner who offers assistance, as originally set by Freud, continues to be the dominant model. Although there has been a good deal of research and writing on group therapy and to a lesser extent on marital and couples therapy, it is individual psychotherapy that has stimulated the most research and to which most conclusions are addressed.

Psychotherapy has increasingly come to be defined as a health-related activity and has thereby come under the purview of third-party payers and political bodies. Cost containment concerns have placed increasing pressures on practitioners to justify their procedures and to demonstrate that they are effective. This, in turn, has led to increasing emphasis being placed on those who conduct psychotherapy research to demonstrate the value of these procedures in ways that have scientific credibility.

II. Theoretical Models of Individual Psychotherapy

It has been estimated that there are over 400 different theories of individual psychotherapy. However, most of these fall within five general classes.

Cognitive psychotherapy models of intervention focus on identifying specific problems and changing the processes and mechanisms by which patients evaluate themselves, others, and their environments. A central assumption of this model is that beliefs rather than facts determine how one will evaluate one's own behavior, remember the past, and anticipate the future. If one's beliefs are distorted and inaccurate, then one's evaluations and memories will be distorted as well. Moreover, one may develop behavioral or emotional disturbances in which the behavior and feelings, too, are inappropriate to one's present situations. Distortions and misperceptions of events are assumed to be at the root of or associated with many problems that impair daily functioning. Cognitive psychotherapy applies methods that encourage re-inspection of these assumptions and the application of rational analysis to correct distortions and cognitive errors. This type of treatment focuses on directly altering one's symptoms through a process that involves the rational and realistic appraisal of situations and the application of thoughtful and systematic problem solving strategies.

Behavior therapy models of individual treatment focus on immediate events and consequences. Symptoms are thought simply to reflect patterns of learning that are cued by the presence of evoking environmental stimuli. That is, behavioral models eschew the use of mental or biological events as explanations for behavior. They look for both causes and consequences within the person's immediate environment or in the concomitant occurrences of sequential cues that progress to more remote consequences. The focus of such treatments is on the development of new skills and on repeated exposure to aversive stimuli leading to extinction of behaviors

that are excessive and repetitive. In this model, the therapist is a guide and instructor rather than a philosopher and healer. Indeed, postulations of illnesses are thought to obfuscate the factors that support and reinforce dysfunctional and disturbed behaviors.

Interpersonal psychotherapy models emphasize that all behavior, whether problematic or adaptive, occurs within a social context. That is, they focus on social and intimate crises such as loss and expected loss, transitions to new social environments, skills to navigate social expectancies and demands, and mediating the competing expectancies and desires that emerge when one enters into relationships with other people. This form of treatment assumes that there are a finite number and type of interpersonal problems that relate to such conditions as anxiety and depression. Interpersonal treatment involves identifying the problematic interpersonal patterns, creating understanding of the interpersonal nature of one's problems, learning to anticipate when problems will emerge, gaining a meaningful understanding of one's own behavior, and developing skills of communication and assertion that can be applied in competitive environments. The therapist assumes an authoritative role in directing the patient through a process of identifying and exploring the nature and causes of one's problems and directs the patient in a process of selecting and using effective procedures for ameliorating these problems and developing improved interactions with others.

Psychodynamic/psychoanalytic psychotherapy models are widely varied but are bound by a common emphasis on the indirect relationship between behavior and environment. That is, disturbed behavior and feelings are thought to reflect internal conflicts rather than current events. The conflicts are symbolized by symptoms and are thought to derive largely from primitive experiences that predispose patients to continue to reenact certain dysfunctional patterns of behavior in a vain effort to obtain a resolution in the present for a conflict whose nature is out of awareness and whose genesis is in the past. Thus, in contrast to other models, neither immediate situations nor dysfunctional thoughts cause disturbance. Indeed, these situations and thoughts are thought to more likely be the consequences of the individual's effort to resolve conflict rather than the causal agents of psychopathology. That is, current behaviors and situations may reflect the disturbance that is caused by the turmoil of inner struggles between contrasting impulses and wishes. Usually, the nucleus of these inner conflicts is kept unconscious by innate efforts to protect one's self from painful

awareness. Thus, the patient does not acknowledge, understand, or know the motivation behind behavior. Improvement is thought to relate to the development of insight and awareness, uncovering these unconscious processes, and becoming aware of how past experiences and filial needs, rather than current demands and exigencies, are determining one's current behavior.

Experiential psychotherapy models focus on problems that are associated with the failure to integrate emotional experience with either thoughts or behaviors. They adopt the viewpoint that from traumatic experience and interpersonal crises early in life, individuals learn ways to protect themselves from experiencing strong emotions. These defensive patterns typically involve separating one's self from one's emotional state and learning to be oblivious to personal emotional cues. Overreliance on rationality, on action and "doing," rather than on feeling and awareness is thought to arise when social forces encourage one to lose sight of inner experiences or to distort and suppress emotional drives and experiences. Experiential treatment is based in the here and now of immediate experience. It endeavors to identify current feelings and to bring these into high relief, often magnifying and enhancing these experiences in order to encourage emotional processing. In this process, the therapist attempts to foster the integration of emotional, behavioral, and cognitive life.

Experiential treatments strive to keep patients in the emotional present rather than retreating to thoughts of the past or future. They encourage patients to learn to tolerate strong feelings without withdrawal, attempting to help them remove their internalized, socially imposed sanctions against such feelings.

III. THE EFFECTS OF INDIVIDUAL PSYCHOTHERAPY

A. Models and Theories

Scientific research over the past 40 years confirms that individual psychotherapy is an effective method for initiating personal change and reducing feelings of unhappiness, stress, and conflict. Its effects are substantial and compare well to alternative treatments for emotional problems, such as psychoactive medication. In recent years, considerable attention has turned to efforts to identify which of the many available models and theories of treatment yield positive effects among different patient groups. Research on these various

models or types of psychotherapy indicates that substantial improvements are associated with their use—relief can be reliably achieved in various kinds of symptoms and problems.

Among the most widely accepted methods and models, those based on cognitive-behavioral, behavioral (e.g., exposure therapy), and interpersonal therapy principles have been most consistently identified as being effective. Models that have received some, but less, support from research, include those that are constructed around psychodynamic principles and emotional awareness or emotion-enhancing therapy (e.g., experiential therapy). Cognitive therapies have been identified as especially effective for treating depression, anxiety, general distress, chemical abuse, and specific anxiety disorders (e.g., obsessive-compulsive disorder, agoraphobia, panic disorder). Behavior therapies are identified as effective for treating depression, psychophysiological disorders (e.g., headache, rheumatic disease), and habit control problems (e.g., smoking, drug/alcohol abuse, enuresis, etc.). Experiential therapies are identified as effective for depression and relationship problems. Interpersonal therapy is identified as being effective for treating depression and eating disorders. Psychodynamic therapies are considered useful for depression, chemical abuse, and social distress.

B. Specific versus Common Contributors to Change

In his classic treatise on *Persuasion and Healing*, Jerome Frank defined psychotherapy as a form of interpersonal influence that involves (1) a healing agent in the person of the therapist, (2) a patient who seeks relief of his or her suffering from the healer or healing agent, and (3) a healing relationship comprised of a circumscribed, more or less structured series of contacts between the healer and the sufferer in which the healer attempts to bring about relief.

By restricting his definition of psychotherapy to these three elements and excluding specific mention of any of the myriad procedures and therapeutic models used by therapists to effect recovery or improvement, Frank underscored what has become a major point of controversy in the field. Namely, does the use of particular psychotherapeutic models and procedures add benefit to that which is obtained from a supportive and caring psychotherapeutic relationship alone? The essential controversy embodied in this question can be distilled to a conflict between those who attribute healing to the use of specific techniques and procedures (i.e., specific “antipathogenic” psychotherapeutic inter-

ventions) and those who attribute psychotherapeutic healing to the effects of a supportive, caring, and evocative therapeutic relationship in its own right—a medical versus a humanistic view of change.

Adherence to a medical analogy has resulted in the admonition that practice be restricted to the use of interventions that have been supported by scientific research. Scientists who look for the differences among psychotherapeutic treatments have advanced and published lists of effective treatment brands and have identified various diagnostic conditions for which each brand of treatment is considered to be effective. However, this line of investigation may oversimplify the difficulty of garnering evidence of efficacy on the 400+ different models of psychotherapy that are currently practiced in contemporary Western society. Restricting practice even to the 150 or so treatments that have been scientifically supported would mean that much of the service that is currently provided in hospitals and clinics throughout the world would have to be discontinued. Furthermore, even if society were to embrace this view and undertake a systematic study of these various treatments, the results may tell us very little about some of the more important and powerful contributors to treatment gain. Research strictly based on fitting brands of treatment to diagnoses of patients will tell us very little about the various modes and formats through which psychotherapy is applied and virtually nothing about the contributions of important nondiagnostic patient qualities and individual therapist variations.

To those who emphasize the similarities among treatments, rather than the differences, such lists of brand-name models inappropriately imply that there are more differences among the various models than have been consistently demonstrated. The qualities that contribute to the development of a healing relationship and those that dictate the specific use of different treatments may have little to do with the patient's diagnosis or the brand name of the treatment provided. By extension, many authors suggest that focusing on differences among brands and models of psychotherapy discourages research on ways both to enhance the presence of therapeutic relationships and to blend interventions across therapeutic models.

Many of these same authors suggest that the effort to identify certain brands of treatment that fit with patients who are identified only by diagnosis would both require that therapists learn many different and frequently contradictory treatment models and that clinicians could only treat a limited and perhaps insignificant number of patients—those who comply with certain inclusion and exclusion criteria.

The use of a medical analogy and the corollary assertion that practice should be restricted to empirically supported treatments applied within the confines of patient samples on which they have been systematically tested is one way to increase the credibility of mental health treatment in a political world. It reflects an effort to place psychotherapy on a parallel with medical treatments for diseases—effective treatment depends on accurate diagnosis, and once diagnosis is established, one should select and apply a treatment that has been scientifically demonstrated to be safe, practical, and effective in the treatment of that condition. From this perspective, the field would do well to consolidate around a uniform effort to find or develop specific procedures that work with particular kinds of problems and conditions.

Working from this viewpoint, clinicians and researchers alike are continuing to develop new theoretical models and technical methods of intervention, with the implicit assertion that these specific techniques and procedures are responsible for the effects of treatment, either positive or negative. This point of view has generated hundreds of theoretical constructs and causal inferences that describe the nature of effective psychotherapy. Each of the resulting theories and procedures vies for the status of being “most effective.”

Controversies between those who attribute change to the elements that are common to all treatments and those who attribute change to specific and unique treatments that derive from certain brands of treatment are not unique to psychotherapy. The past decade has seen the emergence of similar conflicts in the general area of health and medicine as well. Placebo effects, expectancy, hope, and other constructs are implicated in the treatment of a wide array of medical and health conditions and compete for effectiveness with active drugs, surgery, and other interventions that are based on contemporary notions of illness. Clearly, whatever else is working, both physical health and emotional/behavioral well-being rely more than most would acknowledge on the forces of interpersonal persuasion, expectation, faith, and relationship, and less than some would wish on the specifics of pathology-based treatments.

In contrast to the specific treatments approach, the common factors viewpoint focuses on the interpersonal qualities that are correlated with change rather than with the technical ones. Scientists from this camp point out that virtually no direct comparison of one legitimate treatment against another yields any meaningful differences between them. Most who review this latter body of literature conclude that “all have won and all must have prizes.” From the bulk of existing

data, it is not scientifically sound to conclude that there are any treatments that are uniquely effective. To many of these scholars, it is the ubiquitous qualities of support and caring within the patient–therapist relationship that are seen as signals in evoking change in all of these treatments. Proponents of the common factors model consider these relationship qualities to be relatively independent of the specific procedures and techniques used—they are based largely on the nature of the relationship or the bond that develops between patient and therapist. That is, common factors proponents conceptualize a healing relationship as one that instills hope, facilitates communication, conveys safety, and is imbued with the patient’s respect for, and trust of, the therapist.

These two viewpoints color how one perceives the extant research literature. For example, investigators who seek to identify specific treatments that work best with patients who carry different diagnostic labels are gratified by evidence that some treatments may produce substantially better effects among patients with different disorders than various comparison treatments or control groups. However, these same investigators tend to ignore the abundance of evidence indicating that all treatment studies produce essentially equivalent results. At the same time, researchers who believe that all treatments owe their effects to common interpersonal processes find their viewpoint reinforced by evidence that relationships and alliances are consistently related to outcomes but ignore the absence of direct evidence of a causal (rather than simply a correlational) relationship between alliance and outcomes. These investigators see the similarity of outcomes among different psychotherapy models as evidence for the causal nature of common factors, but no studies have been published that clearly demonstrate such a causal chain. For example, alliance may simply be a consequence of change rather than a cause of change.

It is certainly persuasive to look at the consistent correlation that exists between treatment qualities and outcomes, and to conclude that the many diverse therapeutic procedures that are effective all exercise their effects through the medium of improving the patient’s sense of safety, comfort, and support. Thus, it is popular to conclude that therapists who provide safety, while being collaborative and supportive, are likely to produce good effects regardless of the specific procedures or theories used. Such a conclusion lacks the necessary scientific support to conclude that the observed correlation is the result of a causal chain of events. It is equally plausible that change itself may cement and

foster warm and caring relationships, for example. It is also scientifically unjustified at present to conclude that some treatments are better than others.

Out of this awareness has emerged a third group of individuals within the individual psychotherapy movement who have attempted to integrate the opposing views of therapeutic specificity and therapeutic commonality. Members of this third group hold that the principal reason treatments don't show significant differences is that they have been tested on groups that are too homogeneous. They observe that within any treatment, there are some patients who get better, some who get worse, and some who fail to change. This pervasive pattern constitutes strong evidence that undisclosed patient factors are interacting with treatments. These scientists also hold that most research fails by attending only to therapy or relationship factors, and they assert that patient qualities themselves as well as the fit between patient qualities, and the procedures used also contribute to outcome. Indeed, they assert that patient qualities, therapy procedures, treatment relationship, and the fit or match between patient and treatment qualities are likely to make independent contributions to treatment benefit and that if relevant patient and matching qualities could be identified, the accuracy of predictions and the power of treatments could be substantially improved.

Contemporary research provides some evidence that while no specific procedure holds a mean or average advantage over others, there are some patient characteristics that mediate or moderate the effects of treatment, moreover, while the therapeutic relationship is very important, it may be more or less important depending on a variety of patient proclivities and the psychotherapeutic techniques utilized. Integrative and eclectic psychotherapy models accept the assumption that at least some interventions from widely different models are equally appropriate for some symptoms, some people, or some occasions. These models also assume that all treatment models are inappropriate for some people and that different people may benefit from different treatments. Some of these models simply blend two or more theories to make one new theory that is compatible with the techniques from more than one theoretical position. Other models attempt to directly identify patient markers that will indicate when to use different procedures and techniques of treatment, each representing different broad-band models.

Relatively new approaches within integrative and eclectic field have directed attention away from deriving finite lists of either theories or techniques, asserting that

integration is best achieved by identifying cross-cutting principles that govern behavioral change in any of several different individual therapy formats. These latter approaches attempt to develop prescriptive treatment programs based on trait and statelike characteristics that the patient brings into the treatment relationship. Research is accumulating to support this point of view and to suggest that cross-cutting principles and discriminative use of different treatment procedures tend to enhance treatment outcomes. At present, these three points of view are yet to be reconciled. Moreover, the diversity of viewpoint and of research interpretation embodied in these views underlie the presence of other cardinal issues in the field of individual psychotherapy.

C. Lesser Issues in Individual Psychotherapy

As individual psychotherapy begins its second century as an accepted treatment for emotional, behavioral, and mental disorders, it is faced with a variety of complex and difficult problems. These problems are largely occasioned by threats to the credibility of this form of treatment.

I. The Proliferation of Psychotherapy Models

In the past three decades, the sheer number of available and practiced psychotherapies has grown exponentially, now reaching several hundred. All or at least most of these theories purport to offer both an explanatory model of psychopathology and a model of treatment change. In almost all theories, the model of psychopathology, incorporates an explanation of normal behavior by invoking developmental and situational factors, as well as an explanation of deviance by invoking pathogens and insidious precipitators of disorder and disease. The explanations extend to all disorders and identified conditions, and, if they exclude a causal explanation of any type of psychopathology at all, it is an explanation of those disorders that are judged to be outside the influence of interpersonal persuasion methods. Thus, all theories undertake to explain virtually all behaviors and to develop concepts that can fit all persons. Although psychotherapists may be comfortable with this breadth, it does not instill great faith in the idea that psychotherapists really know what produces change and what is healing in the patient-therapist exchange. Those within the managed health care environment who are in charge of assigning treatments to patients are likely to find the process of distilling the truly effective treatment from among 400 or so theoretical descriptions rather daunting they may

conclude that a theory that explains everything really explains nothing.

Even among clinicians, the proliferation of theories and models may be taken as an indication that none of the models really works well. Clinicians are likely to develop new models when old ones don't work. Certainly, the fact that the highest percentage of clinicians identify themselves as being "eclectic" supports the view that no one theory is satisfactory. It is no wonder that psychotherapy has lost credibility both among patients and among managed health care providers, both of whom seem to believe that the various models and methods are interchangeable—there is no real or meaningful difference among them. Thus, a patient is recommended for or seeks psychotherapy for a condition or symptoms like depression; patients rarely seek a specific type of psychotherapy. In the rare instances in which a patient does seek a particular kind of therapy, typically one in which he or she has become familiar through friends or through reading, these treatments are likely to be rather exotic or unusual therapies. Predominantly, patients seem to view the particular therapist as being more important than the theoretical model from which he or she practices.

2. Criteria of Effectiveness

One of the major controversies in the field is how treatment effectiveness should be judged. Many psychologists believe that the best test of the worth of a psychotherapeutic treatment is in the observations of the clinician who exercises judgement and forms an opinion based on his or her theories of psychological disturbance and the elements that facilitate change. Such opinions, however, are by their nature very subjective; they cannot be reliably replicated, and their validity is highly suspect.

The usual criteria by which a treatment is judged to be effective is based on how persuasive, sincere, and articulate a clinician may be. These factors determine how effective a therapist is in persuading fellow clinicians to adopt his or her philosophy and perspective about psychotherapy. Political and legal criteria of a treatment's value are equally subjective and rarely focus on what the actual impact of the treatment is at the level of the patient's problems. Factors such as treatment cost, number of people accessed, popularity, and acceptance among peers are all considered in these criteria and frequently take precedence over actual effectiveness at altering symptoms and resolving problems.

In North America, as health care companies continue to struggle with the cost containment of mental

health services, managed health care has increasingly turned to more objective methods of assessing whether a treatment is appropriate. Some professional groups have emphasized the need for a scientific standard by which to judge a treatment's worth and have suggested certain research-informed standards by which to assess effectiveness.

By far the biggest obstacle to developing a uniform, research-based standard of care is that most contemporary approaches to treatment have not been subjected to empirical test. Nonetheless, a number of well-developed efforts have been made to translate the available research into standards of care or guidelines to direct practitioners. These guidelines typically specify the priority of various models and identify which ones among them have achieved empirical support through scientific research. A continuing obstacle to the implementation of these guidelines involves the sheer number of treatment models available.

Recognizing that it is difficult for clinicians to learn several different theoretical models and that often these guidelines are overly rigid, some authors have argued for a set of standards that emphasize empirically derived principles of psychotherapeutic change rather than either techniques or whole theories. This approach identifies various principles of selecting and applying treatments that are sensitive to ways in which patients differ from one another in their receptivity to different techniques, models, or therapeutic styles. It also emphasizes the need to customize the treatment to each patient, usually by mixing and fitting specific interventions or general styles to defined patient characteristics.

3. Integration of the Science and Practice of Psychotherapy

In these several ways, research findings are becoming more central to clinical practice, though this merger is frequently mandated by law and policy rather than being the result of a voluntary effort. Moreover, without a clear standard for assessing the scientific standing of various models of intervention, whatever merging or integration does occur is difficult to evaluate.

One of the most enduring and complex problems facing the practice of individual psychotherapy is the way in which scientific and clinical observers come to integrate their findings. This problem is complicated both because clinicians who practice psychotherapy and scientists who evaluate it have very different belief systems and perspectives. These differences underlie many of the disputes over the criteria by which to evaluate effectiveness and undermine the credibility of the treatment

itself. Some of the differences that exist between scientists and practitioners are embodied in what kind of research methodologies are most valued. Scientists have tended to value studies of efficacy, whereas practitioners tend to value studies of effectiveness.

Efficacy studies are typically characterized by the use of a highly defined sample of patients, a well-trained cadre of clinicians, random assignment to well-structured and specific treatments, and systematic measurement of outcomes. They contrast with effectiveness studies, which are often less controlled, with more typical samples of therapists and patients, clinical assignment procedures, and less systematic treatments and measures. Although these labels represent the end points of control and generalizability in psychotherapy research, there is ample reason to believe that the distinction between them is more arbitrary than real. Efficacy studies frequently use complex, clinically representative samples, real therapists, and clinically meaningful measurements, whereas effectiveness studies often include random assignment and controlled treatments. In the final analysis, the critical question is the clinical utility of research, by whatever method it is conducted.

Perhaps a more important factor in keeping scientists and practitioners apart is that within both the camp of practitioners and the camp of scientists, there are many factions. In this chapter, we have already pointed to the many different clinical theories that guide treatment, but equally problematic is the fact that scientists themselves have disparate interpretations about what contemporary research tells us.

At the present time, there is no well-accepted way to translate research findings directly into practice or for researchers to be very responsive to clinician opinions and needs. Some argue that a new model of research is needed that adequately addresses the problems of practice. This model would systematically include clinical as well as research perspectives in treatment.

IV. SUMMARY

Over the 100 plus years since it emerged as a formal professional activity, psychotherapy has proven itself to be both popular and effective. Individual psychotherapy is by far the most widely researched and practiced, and it sets the general standard of efficacy and effectiveness by which other approaches can be assessed.

With the popularity of individual psychotherapy has come a burgeoning number of practitioners representing various professional backgrounds and types of

training. Moreover, there has been an exponential growth in the number of theories used to describe the psychotherapeutic process and to guide one's work. Research has demonstrated that some of these approaches are effective, but most psychotherapeutic practices do not rely on scientific research for justification. Clinician experience and impressions are the most frequently used yardsticks by which to judge when treatment is effective and is working. However, this situation seems to be changing, and contemporary political movements and health care programs are recognizing the need to identify which treatments are effective and which ones are not. This movement has introduced a number of changes in the field of psychology. It has brought increasing pressure on clinicians to justify their practices in terms of research findings, and this development has placed more emphasis on making research that is clinically applicable.

As a result of changes in the health care environment, the disparities within the field of psychotherapy research as well as those between science and practice are becoming more apparent. New models are needed and are developing, both for making research more applicable and for applying research findings to the task of directing the course of treatment.

See Also the Following Articles

Behavior Therapy: Historical Perspective and Overview
 ■ Cognitive Behavior Therapy ■ Effectiveness of Psychotherapy ■ Efficacy ■ Exposure ■ Group Psychotherapy ■ Integrative Approaches to Psychotherapy ■ Interpersonal Psychotherapy ■ Neuropsychological Assessment ■ Objective Assessment ■ Research in Psychotherapy ■ Single Case Methods and Evaluation

Further Reading

- Bergin, A. E., & Garfield, S. L. (Eds.). (1994). *Handbook of psychotherapy and behavior change*, 4th ed. New York: John Wiley & Sons.
- Beutler, L. E. (2000). David and Goliath: When empirical and clinical standards of practice meet. *American Psychologist* 55, 997–1007.
- Corsini, R. J. (1981). *Handbook of innovative psychotherapies*. New York: John Wiley & Sons.
- Frank, J. D. (1973). *Persuasion and healing*. Baltimore, MD: Johns Hopkins University Press.
- Freedheim, D. K. (Ed.). (1992). *History of psychotherapy: A century of change*. Washington, DC: American Psychological Press.
- Nathan, P. E., & Gorman, J. M. (Eds.). (1998). *A guide to treatments that work*. New York: Oxford University Press.

Norcross, J. C., & Goldfried, M. R. (Eds.). (1992). *Handbook of psychotherapy integration*. New York: Basic Books.

Roth, A., & Fonagy, P. (Eds.). (1996). *What works for whom? A critical review of psychotherapy research*. New York: Guilford Press.

Wampold, B. E., Mondin, G. W., Moody, M., Stich, F., Benson, K., & Ahn, H. (1997). A meta-analysis of outcome studies comparing bona fide psychotherapies: Empirically, "All must have prizes." *Psychological Bulletin*, 122, 203–215.

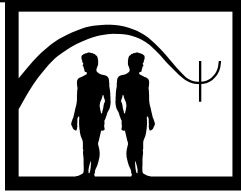

Informed Consent

Catherine Miller

Pacific University

- I. Description of Informed Consent
 - II. Legal and Ethical Bases of Informed Consent
 - III. Research on Informed Consent Procedures
 - IV. Summary
- Further Reading

of confidentiality. This article provides a description of the components of informed consent and methods of obtaining valid consent. Next, the article discusses the legal and ethical bases of the concept. Finally, a review of the available research on ways of obtaining informed consent and the impact that written forms have on the therapy process is provided.

GLOSSARY

confidentiality The ethical (and often legal) requirement to restrict disclosure of client information outside the therapy sessions.

mandated reporting of child abuse The legal requirement in all 50 states that psychologists report to authorities reasonable suspicion of physical, sexual, and/or emotional abuse of a child under the age of 18.

reasonable patient standard The prevailing standard employed when determining the amount of information to provide to clients in order to obtain consent for treatment. Although it is not clearly defined, this standard requires clinicians to provide as much information as a reasonable patient would desire.

Clinicians have an ethical and often legal obligation to obtain consent from clients prior to treating them. In order to obtain valid consent, clients must be fully informed regarding the nature of psychotherapy, including, for example, the potential benefits and risks of treatment, alternative treatments available, and limits

I. DESCRIPTION OF INFORMED CONSENT

Initially, informed consent was a medical concept applying only to physicians and surgeons. The concept was circumscribed, requiring only that doctors tell patients the type of treatment recommended. Within the medical community, the concept eventually was expanded in scope, requiring physicians to give patients enough information about different available treatments so that patients could make educated decisions as to whether to accept a particular form of treatment. More recently, the concept has been incorporated into other disciplines, such as psychology.

As it applies to psychotherapy, the current doctrine of informed consent requires a client to be informed of the potential benefits and risks of the contemplated treatments, the expected prognosis with and without treatment, and any possible alternative treatments. Barring exceptions such as emergency treatment, a person cannot be given therapy without his or her informed

consent to such procedures. Underlying the concept of informed consent is the principle that allowing a client to make an informed decision respects that person's autonomy and self-determination.

Valid consent implies that the client agrees to treatment intelligently, knowingly, and voluntarily. Intelligence, sometimes referred to as competency, is defined as a client's capacity to comprehend and evaluate the specific information that is offered, whereas knowledge is defined as a client's ability to appreciate how the given treatment information applies to him or her specifically. Finally, the voluntary element suggests that a client's consent may not be coerced or enticed by the treating agent. All three elements must be present in order to consider consent truly informed and valid.

The first element of competency or intelligence is a difficult concept for two reasons. First, there has been considerable debate over how much information should be given to a client to allow him or her to make an informed decision. Second, the concept is often difficult to assess with child clients.

Regarding the debate over the extent of information provided, historically there have been two standards employed to determine whether the client has received adequate information. The first is a professional standard, which requires that the amount of information provided to a client be what other professionals in the community typically provide. The professional standard has been criticized for being somewhat paternalistic, in that clinicians determine the extent of the information that is provided to clients. The second standard is the reasonable patient standard, which requires the professional to give as much information as a reasonable patient would desire to make treatment decisions. The major problem with this standard is the difficulty in quantifying the exact amount of information a reasonable patient would desire. This standard does, in addition, put the onus squarely on clinicians to provide information, even when not requested by a particular client. In recent years, the reasonable patient standard has been the prevailing model.

Regarding child clients, it should be noted that the right to give consent is a legal one that is based on a client's presumed ability to understand the information given. In general, only adults are considered able to understand treatment information and to be legally competent to give consent. In many states, minors are not legally competent to give consent; instead, consent for treatment must be obtained from a legal guardian or parent. However, some state statutes give minors limited rights to consent to treatment. For example, in Oregon, state law allows children 14 years of age and older to give

valid consent for outpatient mental health treatment without the consent of parents. Other states' statutes recognize the mature minor exception, granting minors near the age of majority or mature enough to understand and weigh treatment options the right to consent to treatment. Regardless of state law, it is important to involve even young children in the process of obtaining consent. Despite the fact that state laws often do not recognize their capacities, research has found that even young children may be capable of understanding and weighing treatment options. Given these findings, clinicians should endeavor to obtain assent to treatment from children ages 7 and older. The term assent does not imply legal consent; however, it suggests that young children should be given relevant treatment information and asked whether or not they wish to participate in treatment. If a child does not want to participate in treatment, despite parental consent, ethical principles dictate that the clinician should consider the best interests of the child. Such a dilemma would involve considering and respecting the child's autonomy while recognizing the legal authority of the child's parents.

Although providing information about treatment is necessary to ensure a person's consent is done intelligently, it is not sufficient to obtain informed consent from a client. In addition, a client's knowledge or ability to appreciate that the material is relevant to him or her specifically must be assessed. In order to ensure that a client fully appreciates the information provided, a clinician must regularly question the client's comprehension of the material. One way of assessing comprehension is to ask a client to repeat, in his or her own words, treatment information that was presented previously. Only with a reasonable appreciation of the information will consent to treatment be considered valid. By the reasonable patient standard, clinicians bear the responsibility of ensuring that clients understand and appreciate the treatment information given.

Finally, in order to satisfy the requirement that consent be given voluntarily, no undue pressure may be placed on the client by the treating agent. For example, clinicians should avoid promising miraculous and timely cures; they should also avoid offering financial incentives for participating in treatment. To ensure the voluntary element necessary to valid consent, clients must be told that they can withdraw from treatment at any time.

The limits of informed consent should be noted by clinicians. Obtaining informed consent does not provide permission to clinicians to perform illegal or unethical acts. For example, a therapist cannot justify sexual acts with a client by claiming that informed consent for these

acts as part of treatment was obtained from the client. In other words, there clearly are limits on those things to which a client can validly consent.

Given the three elements of valid consent, it should be clear that obtaining informed consent is not a one-time incident but instead is an ongoing process throughout treatment. Several authors have suggested that clinicians adopt a process model rather than an event model of informed consent. Ongoing discussions with clients throughout the treatment process may be necessary to ensure that they have sufficient opportunities to ask questions and have information clarified. At a minimum, there are two discrete times during the therapy process when informed consent should be obtained: at the initiation of therapy and when particular treatments are proposed.

At the initiation of therapy, clinicians should provide general information on the nature and process of therapy to potential clients. Informed consent for treatment generally should be obtained at the beginning of the very first session, prior to obtaining potentially sensitive information, conducting assessments, or implementing any treatment techniques. The following information should be given at the initial session to assure informed consent. First, clients should be told the qualifications of the therapist and any supervision that is required. Second, clients should be told the limits of confidentiality (e.g., mandated reporting of child abuse) and general client rights (e.g., the right to withdraw from therapy at any time). Finally, clients should be told logistical information, such as scheduling practices and fee structures.

In addition to general information on the nature of therapy, the informed consent process should continue when specific treatments are proposed. At this time in the therapy process, clinicians should provide information on the purpose of the proposed treatment, any possible discomforts or harms, and any potential positive benefits. In addition, clients must be told about alternative treatments available and the possible risks and benefits of these treatments. Finally, clients must be told that no treatment is an option and must be informed of the possible consequences of opting out of treatment.

It is imperative that clinicians document this ongoing process of obtaining informed consent. The first major point of documentation is at the first session. At that time, clinicians are advised to employ a written information sheet that is read and signed by the client. Although there are many variations of this form, it should be written in plain language free of jargon or legalistic phrases and should contain the information

necessary for the client to make an informed choice regarding whether or not to participate in therapy. However, it should be noted that a signed informed consent form is not enough to demonstrate knowledge, one of the three elements of informed consent. To document client knowledge, clinicians should include in a progress note any client questions or statements that indicate that the client has a full appreciation of the information given. The second major point of documentation is when specific treatment techniques are proposed. At that time, clinicians should carefully document in progress notes the treatment options presented to the client and any questions asked by the client. Standard of care issues now dictate that clinicians should determine which treatment to employ by reading available literature and using empirically supported treatments. If a clinician decides to employ an unusual or experimental treatment, he or she should thoroughly document that the client has been fully informed about the nature of the experimental treatment and the possible risks and benefits. In addition, the clinician should document that the client was given information about standard treatments.

The documentation requirements ensuring valid consent may become more time-consuming when clinicians conduct family or couples sessions. In those instances, informed consent should be obtained from all participating members at the initiation of therapy and throughout the treatment process. In addition, progress notes should document that discussions have been held regarding any issues that are unique to family or couples sessions. For example, clinicians should discuss with all family members how to handle difficult confidentiality issues faced when more than one client is in the room and should document these discussions in the progress notes.

II. LEGAL AND ETHICAL BASES OF INFORMED CONSENT

Several legal cases illustrate the importance of obtaining informed consent. The first major legal statement of the need for consent occurred in the 1905 case of *Mohr versus Williams*. In this case, the plaintiff used a physician for performing an unauthorized surgical operation. While the plaintiff did consent to an operation on her right ear, the physician instead performed an operation on her left ear, as he had found the left ear to be more in need of treatment once the surgical procedures had commenced. Following the operation, the

plaintiff claimed that she had not previously experienced any difficulty with her left ear but that she currently was having trouble hearing out of that ear. The court found in favor of the plaintiff and stated that a surgical operation by a physician upon the body of his patient is unlawful when performed without either the express or implied consent of the patient.

In 1914, the case of *Schloendorff versus the Society of New York Hospital* expanded on the requirements for informed consent. The court stated that a patient must be apprised of the potential benefits and major risks of any proposed treatment, as well as the available alternative treatments. However, the court did not give specific guidance on how much information is sufficient. A later case, *Canterbury versus Spence* (1972), appeared to support the reasonable patient rather than the professional standard of information provision. The court in this case stated that physicians have “a duty to impart information which the patient has every right to expect.” Since this 1972 case, physicians have been considered to have an affirmative duty to impart as much information as a reasonable patient would require, regardless of whether a particular patient asks for such information.

It is clear from the above brief review that case law has supported obtaining informed consent for medical procedures. However, courts have not directly addressed whether or not informed consent is applicable to typical psychological or counseling services. Likewise, state statutes that address the concept of informed consent have typically addressed only physician obligations to obtain consent. Currently, all states have statutes mandating some type of informed consent procedures for physicians and psychiatrists. Not every state, however, clearly specifies that psychologists or other mental health providers must obtain informed consent for psychological treatments. For example, Oregon law on informed consent states only that physicians and surgeons must obtain informed consent for treatment, with no mention of any such obligation on the part of psychologists. On the other hand, Colorado and Indiana statutes mandate that psychotherapists obtain informed consent. Other state legislatures currently are considering bills requiring psychologists to obtain informed consent prior to treatment. It appears that the recent increase in legislative activity stems from controversy surrounding therapy techniques designed to activate repressed memories. These techniques supposedly help adults recover or unlock previously repressed or forgotten memories of childhood sexual abuse. Critics claim that these techniques result in false memories rather than true memories of abuse and that the techniques lack a scientific

basis. Critics have introduced legislation requiring psychologists to inform clients of the scientific basis of all treatment techniques, as part of their efforts to reduce the use of repressed memory techniques. Clearly, clinicians should be aware of the statutes in the states in which they practice, as laws regarding informed consent for therapy vary across state lines.

Regardless of whether state statutes or case law mandate that clinicians obtain informed consent prior to mental health treatment, ethical codes of conduct typically dictate that clinicians apply the concept of informed consent with all clients. For example, the ethical codes developed by the American Psychological Association (APA) and the American Counseling Association (ACA) contain sections dealing with informed consent. In the APA code, Principle 4.02 states that psychologists must obtain informed consent by using “language that is reasonably understood by participants.” If a client is a child or otherwise unable to give consent, psychologists must obtain consent from the legal guardian. In addition, psychologists must provide information to a child or other legally incompetent person and obtain assent from that person. The overarching principle espoused in ethical principles is that clinicians must consider the client’s best interests, autonomy, and self-determination.

Clinicians should be aware that not obtaining valid consent prior to treatment places them in a precarious position. Due to ethical principles requiring informed consent, a client may file an ethical complaint with the state licensing board for a clinician’s failure to obtain valid consent. Complaints regarding lack of informed consent may be based on the three areas discussed previously: lack of competence to consent to treatment, lack of voluntary consent, or lack of sufficient information. To be found in violation of the ethical code, a psychologist must only be found to have neglected standard and reasonable informed consent procedures. It is not necessary for the client to have been harmed due to the psychologist’s negligence for a clinician to be found in violation of the ethics code. In egregious cases, the result may be suspension or loss of the license to practice psychology in that state.

In addition to an ethical complaint, clinicians who neglect to obtain valid consent from clients may find themselves facing a civil lawsuit. Despite a lack of case law directly addressing the concept of informed consent for psychological services, it is only a matter of time until such a suit is filed. In contrast to an ethical complaint, the client in a civil suit must show, among other things, that the client was harmed by the clinician. To win a suit based on a failure to obtain informed

consent, the client must prove all of the following five things: (1) that the risks involved with a therapy should have been disclosed; (2) that the risks were not disclosed; (3) that the risks materialized; (4) that the materialized risks resulted in injury; and (5) that the client would not have accepted the therapy if he or she knew of the risks involved. It is true that such lawsuits are uncommon and difficult to prove currently. However, the rise of empirically supported treatments may increase the frequency of complaints made by clients who did not receive information and full disclosure regarding such treatment options. Injury or harm may be demonstrated by a client who incurred expenses while participating in an ineffectual therapy for a long period of time, when a more time-efficient and empirically supported therapy was available but was not disclosed to the client. In our increasingly litigious society, clinicians should be aware of the growing possibility of legal liability for failure to obtain fully informed consent.

III. RESEARCH ON INFORMED CONSENT PROCEDURES

There has been little research conducted on the process or effects of obtaining informed consent. The limited research that is available has addressed three main areas: prevalence of informed consent procedures, optimal methods of obtaining informed consent, and effects of informed consent procedures on client disclosure or attendance.

First, research has not supported the idea that all clinicians employ some form of consent procedure. As stated previously, consent procedures include utilizing a written informational form and documenting ongoing discussions with the client. As recently as 1993, Daniel Somberg, Gerald Stone, and Charles Claiborn found that only 60% of psychologists reported utilizing any type of consent procedure with all clients. Thirty-seven percent of the remaining psychologists stated that they did not employ informed consent procedures with all clients due to believing that such procedures were irrelevant, while 16% stated that they often simply forgot to obtain informed consent.

As should be clear from previous sections, the use of both written forms and ongoing discussions with clients is encouraged. Research has found that the sole use of written forms to convey information on the therapy process and treatments has increased over the past two decades. However, research does not support the exclusive use of a written informational form as a method of

obtaining valid consent. There are two major problems with sole reliance on such forms. First, researchers have found that the average length of consent forms doubled from 1975 to 1982, in order to include more information about client rights and confidentiality. Second, the written forms typically employed generally require that the reader have at least a college education. One study found that the average readability of consent forms was grade 15.7 (third year college level), while some reached grade 17+ (postgraduate level).

Given the increasing length and complexity in such forms, it is important to ask whether the typical client can comprehend such information. It is possible that longer and more detailed forms, while covering all of the required consent elements, are primarily utilized to protect clinicians against ethical complaints or lawsuits rather than as a way to educate and inform clients. Clearly, understanding is an important element in giving informed consent; without it, a signature on an informational form is not valid. Although not directly addressing clinical or treatment forms, a 1994 study by Traci Mann on the understanding of research informed consent forms is relevant. Overall, Mann found that longer consent forms inhibited the amount of information retained by participants. Mann concluded that research participants often agree to engage in studies that they do not understand, which belies the whole idea of informed consent. His findings imply that long, complex consent forms should not be employed with clinical clients.

An alternative to employing detailed informed consent forms is a procedure suggested by Mitchell Handelsman and Michael Galvin in 1988. These authors developed a question sheet that includes a list of commonly asked questions. This sheet also instructs potential clients that they have a right to ask any or all of these questions to their therapist. Handelsman and Galvin directed that some of the questions must be answered by the therapist even if not asked by the client; examples of such questions that therapists are ethically obligated to discuss with clients would be those dealing with confidentiality and the general nature of treatment. However, the remaining questions are left to the discretion of the client, respecting the right of clients to not be given information that is not wanted. It may also encourage the use of a process format of obtaining informed consent, rather than a single event model. To date, no studies have been done investigating the level of client retention of information presented in such a format.

Several studies have examined the effects of informed consent procedures on the therapy process, with most of the research examining the effects of

written informational forms. Clearly, some clinicians have been reluctant to employ informed consent procedures, particularly written forms, on a regular basis. The primary concern may be that the use of legalistic forms and terms is detrimental to the establishment of a therapeutic relationship. In other words, informed consent procedures, particularly written forms, may create a negative impression of therapy in general and the therapist specifically. It is also possible that clinicians are concerned that too much information on the limits of confidentiality may deter clients from revealing important but sensitive information. However, in general, the literature does not support these negative effects of informed consent procedures; instead, research has found primarily positive results from the process of obtaining informed consent.

In regard to the therapeutic relationship, in 1990 Mitchell Handelsman surveyed 129 undergraduate students regarding their impressions of a hypothetical therapist. Holding level of experience of the therapist constant across conditions, Handelsman varied the amount of written information provided to survey participants. In all conditions, participants were provided minimal written information about the therapist, including his educational background and years of experience. In the first condition, participants also were provided the question sheet. In the second condition, participants were given a legal disclosure form, outlining client rights, limits to confidentiality, and other information often considered part of informed consent procedures. Finally, in the third condition, participants were given a brochure that provided general information to commonly asked questions (e.g., What is the difference between a psychologist and a psychiatrist?). Based on the information provided, participants were asked to complete a questionnaire regarding their impressions of the hypothetical psychologist. Overall, Handelsman found that the use of more written information increased participants' positive judgments of therapists' experience, likeability, and trustworthiness, in addition to their likelihood of referring the therapist to others. This study suggested that written information, whether disclosed in a more legalistic document or through a question sheet, may improve therapist ratings. The study was not able to conclude that the question sheet was more beneficial than the legal disclosure form.

In a separate study in 1990, Mitchell Handelsman surveyed 137 undergraduate students to assess whether varying level of therapist experience would affect the previously established positive impact of legal disclosure forms. For this study, half the participants received the legal disclosure form; the other half received both the

legal disclosure form and the question sheet. In addition, therapist level of experience varied. In the first condition (the low-experience condition) participants were told that the hypothetical therapist was recently licensed within the past year. In the second condition (the moderate-experience condition), participants were told that the therapist had been practicing for at least 9 years. Finally, in the third condition (the high-experience condition), participants were told that the therapist had been in practice for 19 years. Overall, Handelsman found that participants rated experience highly. However, with more information provided, the less experienced therapist was rated more highly. Handelsman's findings suggest that adding more written information in the informed consent process improves client ratings, particularly with less experienced therapists.

In 1993, Therese Sullivan, William Martin, and Mitchell Handelsman conducted a survey of 124 undergraduate psychology students to further investigate the impact of information on ratings of clinicians. Participants were assigned to one of two conditions. In both conditions, participants were given a hypothetical transcript of a first therapy session. In the first condition (informed consent transcript condition), the transcript was accompanied by a written consent form and included discussion of confidentiality, alternative treatments, and risks and benefits of therapy. In the second condition (control transcript condition), no written form accompanied the transcript and no discussion on informed consent issues was included. Following presentation of materials, all participants were asked to complete a questionnaire regarding impressions of the therapist. The authors found that the combined presentation of oral and written information positively impacted therapist ratings.

To date, only one study has found any negative effects of written forms on client impressions of therapists. In 1992, Mitchell Handelsman and William Martin found that male adult clients reported lower ratings for therapists who provided written informed consent forms than no information at all. However, the forms employed in this study were difficult to read, as they required at least a 10th-grade reading level, had complex sentences, and were single-spaced. As previously reported, less readable forms are likely to be misunderstood by clients. It appears from this study that therapist ratings also suffer from complex information forms.

As the above brief review demonstrates, the limited research that has been done appears to support the idea that informed consent procedures improve client ratings of therapists. Further research has examined

whether informed consent procedures affect client behaviors in therapy, such as termination rates and the frequency of disclosures of sensitive information.

Termination and no-show rates of clients at a counseling center of a state university were examined in 1995 by Patricia Dauser, Suzanne Hedstrom, and James Croteau. In the partial disclosure condition, participants received only the counseling center's standard written information, including the services provided at the clinic, limits of confidentiality, length and frequency of sessions, and the client's right to terminate treatment. In the full disclosure condition, participants received the standard written form as well as written materials containing more detailed information. Specifically, participants were told the name of the assigned therapist, the therapist's experience and typical treatment procedures, anticipated positive results of therapy, possible risks, potential alternatives to therapy, fee structure, the name of the therapist's supervisor (if applicable), and the name and number of the state licensing board. Overall, the authors found no differences between the two conditions in no-show or termination rates during the course of therapy, suggesting that more information does not negatively affect client attendance.

The results of research on the impact of informed consent procedures on client disclosures have been mixed. In recent years, legislation in most states has mandated that certain information revealed by clients (e.g., child abuse, imminent harm to others) be disclosed to authorities. This legislation is based on the idea that society has more of an interest in preventing harm than in protecting client confidentiality. Informing clients of the limits of confidentiality is a standard part of most informed consent procedures. Some studies have found that warning clients of the limits of confidentiality reduces client disclosures, whereas other studies have found that it has no impact. As an example, Daniel Taube and Amiram Elwork examined rates of disclosure of sensitive information in 1990. These authors assessed 42 adult outpatient clients regarding level of self-disclosure following either minimal information on confidentiality limits or full information regarding this topic. The authors found that information on confidentiality limits does reduce self-disclosure for some patients in some circumstances. In particular, more informed clients did not admit to as many child punishment and neglect behaviors, nor did they admit to as many socially unacceptable thoughts and behaviors as the minimally informed group. The authors suggested that legislation on mandated reporting of certain client information may not achieve its intended aim of

protecting society and may also hinder the therapy process. Due to conflicting findings in the literature, further research is needed to clarify the impact of informed consent procedures on client disclosures.

IV. SUMMARY

Obtaining informed consent of all clients is an ethical requirement for psychologists. In addition, it is likely that psychologists will increasingly be legally required to obtain informed consent prior to treatment. Informed consent is valid only if given intelligently, knowingly, and voluntarily. The reasonable patient model is now the standard of care, suggesting that clinicians must take the responsibility for initiating dialogues with clients regarding consent issues. An ongoing, process model is advisable, rather than a single event model that relies exclusively on a written informational form. Both written forms and continual discussions are helpful, as long as the client understands these basic areas: nature of therapy in general, limits to confidentiality, treatment techniques available, and the risks and benefits of potential techniques (including the option of no treatment).

Research has found that not all therapists currently utilize informed consent procedures, believing it may be irrelevant or even harmful to the therapeutic relationship. In general, research has supported the positive effects of providing more information to the client prior to treatment. For example, research has found that increased information appears to improve client ratings of clinicians. Although not directly studied, it is possible that providing more information to clients reduces the risk of exploitation of clients by informing them of rights and expectations. In addition, it is possible that utilizing informed consent procedures may align client and clinician expectations of therapy, resulting in a better therapy outcome, as well as fewer lawsuits or ethical complaints for clinicians. Clearly, further research should be conducted on these hypotheses.

It should be noted, however, that research has not been uniformly positive as to the effects of informed consent procedures. When long or complex written materials are utilized, client comprehension suffers. Also, research is mixed on the effects of informed consent procedures on client disclosure of sensitive information. At least one study has found that disclosure of sensitive material may be inhibited when more information on the limits of confidentiality is provided to clients. Further research on this issue is needed to clarify the extent of client censoring of sensitive materials.

See Also the Following Articles

Bioethics ■ Cancer Patients: Psychotherapy ■ Economic and Policy Issues ■ Flooding ■ Legal Dimensions of Psychiatry ■ Medically Ill Patient: Psychotherapy ■ Supervision in Psychotherapy

Further Reading

- American Psychological Association. (1992). Ethical principles of psychologists and code of conduct. *American Psychologist*, 42, 1597–1611.
- Appelbaum, P. S. (1997). Informed consent to psychotherapy: Recent developments. *Psychiatric Services*, 48, 445–446.
- Crowhurst, B., & Dobson, K. S. (1980). Informed consent: Legal issues and applications to clinical practice. *Canadian Psychology*, 34, 329–343.
- Gustofson, K. E., & McNamara, J. R. (1987). Confidentiality with minor clients: Issues and guidelines for therapists. *Professional Psychology: Research and Practice*, 18, 503–508.
- Koocher, G. P., & Keith-Spiegel, P. (1998). *Ethics in psychology: Professional standards and cases* (2nd ed.). New York: Oxford University Press.
- Marczyk, G. R., & Wertheimer, E. (2001). The bitter pill of empiricism: Health maintenance organizations, informed consent, and the reasonable psychotherapist standard of care. *Villanova Law Review*, 46, 33–93.
- Zuckerman, E. L. (1997). *The paper office* (2nd ed.). New York: Guilford Press.

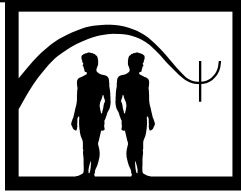

Integrative Approaches to Psychotherapy

Jerry Gold

Long Island University

- I. Description of Treatment: A Historical and Conceptual Overview of Psychotherapy Integration
 - II. Theoretical Bases of Psychotherapy Integration
 - III. Research on Integrative Approaches to Psychotherapy
 - IV. Range of Patient Populations and Issue of Diversity
 - V. Case Example
 - VI. Summary
- Further Reading

theoretical integration The most conceptually complex form of psychotherapy integration, in which the underlying theories of personality and psychopathology are synthesized and are the foundation of a new therapeutic approach.

This article will introduce the reader to progress in the area of psychotherapy integration. This is a new and exciting subdiscipline in the field of psychotherapy. It is concerned with using and combining the most effective elements of psychotherapy theory and practice in ways that accentuate the power of integrated psychotherapies to help a wider range of patients, with a broader spectrum of problems, to change.

GLOSSARY

assimilative integration A system of psychotherapy integration that depends largely on one approach but that incorporates concepts and methods as dictated by clinical necessity. These new elements are transformed to fit into the primary approach.

common factors That group of variables that have been found to be the effective ingredients of most psychotherapies.

common factors integration The combination of therapeutic approaches based on the ability of particular methods to deliver the desired common factor of change.

psychodynamic A synonym for psychoanalytic, it refers to unconscious motivations, perceptions, emotions, and conflicts that determine behavior, and to forms of psychotherapy that emphasize these factors.

psychotherapy integration The combination of techniques and/or concepts from two or more psychotherapeutic approaches into a single method of psychotherapy.

technical eclectic The most pragmatic and common form of psychotherapy integration, in which interventions are matched to patient characteristics, symptoms, and problems on the basis of research findings and clinical knowledge.

I. DESCRIPTION OF TREATMENT: A HISTORICAL AND CONCEPTUAL OVERVIEW OF PSYCHOTHERAPY INTEGRATION

From the earliest foundations of modern approaches to psychotherapy, practitioners and students of psychotherapy have been extraordinarily unwilling to learn from systems of psychotherapy other than their own. Each school of psychotherapy has developed in a state of isolation from the other schools. This state of segregation within the field of psychotherapy has had dramatic and important effects. It has led to unwanted

hostility between adherents of the various psychotherapeutic schools, and to efforts to dismiss out of hand the ideas and methods of competing approaches without systematic study or intellectual consideration. This self-imposed therapeutic “apartheid” also has prevented psychotherapists and patients from benefiting from clinical and theoretical innovations introduced by colleagues who are loyal to other psychotherapeutic approaches. Michael Mahoney argued in 1985 that these schisms in the field were political in nature and did not reflect clinical reality, which indicated that none of the therapeutic schools could claim to be vastly superior to any other.

This stubborn isolationism in the field of psychotherapy stands in contrast to the fact that psychotherapists have always been interested in, and long have attempted to use, new developments in the natural and social sciences, philosophy, theology, the arts, and literature. A small group of scholars and clinicians have been able to cross sectarian lines and have countered the segregation of the various schools of psychotherapy. These integrationists have aimed at establishing a useful dialogue among members of the various sectarian schools of psychotherapy. Their goal has been the development of the most effective forms of psychotherapy possible. The integration of therapies involves the synthesis of the “best and brightest” concepts and methods into new theories and practical systems of treatment.

Integrative forms of psychotherapy vary greatly depending on the particular version that is being considered, yet all share one common goal and purpose. Integrative psychotherapies are the result of the synthesis of theoretical concepts and clinical techniques from two or more traditional schools of psychotherapy (such as psychoanalysis and behavior therapy) into one therapeutic approach. It is hoped and assumed that this therapeutic synthesis will be more powerful and will be applicable to a wider range of clinical populations and problems than were the individual models of psychotherapy that formed the basis of the integrated model.

Histories of early efforts at integrating compiled by Marvin Goldfried and Cory Newman in 1992, and by Jerold Gold in 1993, identified scattered but important contributions as early as 1933, when Thomas French argued that concepts from Pavlovian models of learning should be integrated with then current psychoanalytic insights. In 1944 Robert Sears offered a synthesis of learning theory and psychoanalysis, as did John Dollard and Neal Miller in 1950, whose translation of psychoanalytic concepts and methods into the language and framework of laboratory-derived learning principles was a watershed event.

Early clinical efforts at integrating behavioral and psychoanalytic interventions in a single case were introduced by Bernard Weitzman in 1967, in 1971 by Judd Marmor, and by Benjamin Feather and John Rhodes in 1973. These clinical efforts demonstrated that unconscious factors in a patient’s psychopathology could be ameliorated through the use of behavioral methods, along with traditional psychodynamic exploration and interpretation.

In the past two decades a number of important integrative approaches to psychotherapy have been developed. In 1977 Paul Wachtel published a groundbreaking book that advocated an integration of psychoanalytic theory with social learning theory, and in which he demonstrated ways in which clinicians could effectively use behavioral and psychoanalytic interventions with one patient. This integrative approach received enormous attention within the behavior therapy and psychoanalytic communities, and was followed by other efforts at promoting a dialogue between clinicians of various orientations, as well as a relative torrent of articles and books that focused on integrative topics. In 1984 Hal Arkowitz and Stanley Messer published an edited volume in which prominent behavior therapists and psychoanalytic therapists discussed and debated the possibilities of extensive integration of the two systems.

In 1992 John Norcross and Marvin Goldfried published a handbook that presented a variety of fully developed integrative systems of psychotherapy. This effort was followed in 1993 by a volume edited by George Stricker and Jerold Gold in which an even greater number of integrative models was presented, and the clinical utility of psychotherapy integration was explored with regard to a variety of clinical problems and populations. These volumes illustrated that integrative models were no longer focused exclusively on the synthesis of psychoanalytic and behavioral systems. Newer integrative efforts have combined humanistic, cognitive, experiential, and family systems models with each other and with psychoanalytic and behavioral components in ever more sophisticated combinations and permutations. Process-experiential psychotherapy, an innovation introduced by Leslie Greenberg, Laura Rice, and Robert Elliot in 1993, and acceptance and commitment therapy (ACT), described by Steven Hayes, Kirk Strosahl, and Kelly Wilson in 1999, are important examples of integrative approaches that rely heavily on the integration of humanistic and experiential approaches with cognitive-behavioral therapies. Similarly, an integrative model that blended existential,

humanistic, and narrative therapies was described in 1999 by Alphonse Richert.

These psychotherapeutic systems have received increasing attention on the part of clinicians and researchers alike, and have become established and viable alternatives to traditional schools of psychotherapy.

In 1992 John Norcross and Cory Newman identified eight variables that have encouraged this rapid proliferation of integrative psychotherapies after decades during which these efforts were scanty. These included (1) The ever-increasing number of schools of psychotherapy; (2) a lack of clear-cut empirical support for superior efficacy of any school of therapy; (3) the failure of any single theory to adequately explain and predict pathology, or personality and behavioral change; (4) the growth in number and importance of shorter term, focused psychotherapies; (5) greater communication between clinicians and scholars that has resulted in increased willingness to, and opportunity for, experimentation; (6) the intrusion into the consulting room of the realities of limited socioeconomic support by third parties for long-term psychotherapies; (7) the identification of common factors in all psychotherapies that are related to outcome; and (8) the development of professional organizations, conferences, and journals that are dedicated to the discussion and study of psychotherapy integration.

II. THEORETICAL BASES OF PSYCHOTHERAPY INTEGRATION

A. Modes of Psychotherapy Integration

The three most commonly discussed forms of integration are technical eclecticism, the common factors approach, and theoretical integration.

1. *Technical Eclecticism*

This is the most clinical and technically oriented form of psychotherapy integration. Techniques and interventions drawn from two or more psychotherapeutic systems are applied systematically and sequentially. The series of linked interventions usually follows a comprehensive assessment of the patient. This assessment allows target problems to be identified and identifies the relationships between different problems, strengths, and the cognitive, affective, and interpersonal characteristics of the patient. Techniques are chosen on the basis of the best clinical match to the needs of the patient, as guided by clinical knowledge and by research findings.

a. Multimodal Therapy The most influential and important integrative approach that is representative of technical eclecticism is multimodal therapy, described by Arnold Lazarus in 1992 and studied extensively by him and many others since that time. Multimodal therapy was derived from Lazarus's experiences as a behavior therapist, and particularly from his follow-up studies of patients who relapsed after seemingly successful behavioral treatment. His research and clinical experience indicated that most behavioral problems had more extensive psychological and social causes and correlates than then current behavior therapy had addressed. Seeking to expand the range of his ability to work in a more "broad spectrum" way, Lazarus arrived at a multimodal, or broad-based, eclectic therapy.

Multimodal therapy is organized around an extensive assessment of the patient's strengths, excesses, liabilities, and problem behaviors. Upon completion of this assessment, that patient's clinically significant issues are organized within a framework that follows the acronym of the *BASIC ID*: Behavior, Affect, Sensation, Imagery, Cognition, Interpersonal relations, and Drugs (or biology). As the firing order or causal sequence of variables in the *BASIC ID* is identified, interventions are selected and are implemented. More microscopic *BASIC ID* profiles of discrete or difficult problems and of components of a firing order can be attempted once the initial, global assessment and interventions are completed.

Lazarus states that he prefers to use methods that have been demonstrated through empirical tests to be effective with specific problems and skills, and his theory and technical strategies are more heavily aligned with social learning theory and with cognitive-behavior therapy than with any other therapeutic school. However, in his broad-spectrum approach, he often includes imagery work, techniques drawn from couples and family therapy, gestalt exercises and some affective and insight oriented interventions.

b. Systematic Eclectic Psychotherapy This system of psychotherapy integration was described by Larry Beutler and Amy Hodgson in 1993. This is an empirically informed system in which a thorough assessment of the patient is followed by the prescription of techniques, if available, that have received the most research validation for efficacy with that specific clinical profile. When such research-based matching is not possible, techniques are selected according to accumulated clinical findings drawn from the literature and from the experience of the individual therapist. Beutler and Hodgson choose therapeutic interventions by considering the

interaction of three variables: the stage of involvement in psychotherapy that the patient has reached; the necessary change experiences for which the patient is prepared; and the dominant aspects of the patient's immediate clinical status. Clinical techniques can be matched with four psychological spheres that are assessed on an ongoing basis: overt dysfunctional behavior, faulty thinking, inhibitions of affective and sensory experience, and repressed unconscious conflict. Therapists who work in this framework are free to draw on interventions from any existing system of psychotherapy ranging from psychoanalytically oriented interpretations, to experiential, emotional work, to efforts at modifying thoughts and overt behaviors.

2. Common Factors Approaches to Integration

Common factors integration starts from the identification of specific effective ingredients of any group of therapies. This way of thinking has its origins in the 1936 paper by Saul Rosenzweig, who argued that all therapies shared certain effective ingredients of change, despite their overt ideologies and technical procedures. Also critically important in this area is the work of Jerome Frank, who in 1961 suggested that all systems of psychological healing share certain common, effective ingredients, such as socially sanctioned rituals, the provision of hope, and the shaping of an outlook on life that offers encouragement to the patient. Integrative therapists who rely on common factors concern themselves with the task of identifying which of the several known common factors will be most important in the treatment of each individual. Once the most salient common factors are selected, the therapist reviews the array of interventions and psychotherapeutic interactions to find those that have been found to promote and contain those ingredients. The integrative therapies that result from this process are structured around the goal of maximizing the patient's exposure to the unique combination of therapeutic factors that will best ameliorate his or her problems.

a. Transtheoretical Psychotherapy The most important and widely accepted integrative psychotherapy that exemplifies the common factors mode is transtheoretical psychotherapy, described by James Prochaska and Carlos DiClemente in 1992. In this system, the therapist selects intervention techniques after three patient characteristics are assessed. These are the change mechanisms or common therapeutic factors that are required, the stage of change at which the patient seeks help, and the level of change that is necessary. Prochaska and Di-

Clemente identified 10 possible change factors that operate in the entire range of the psychotherapies, including consciousness raising, self-liberation, social liberation, counterconditioning, stimulus control, self-reevaluation, environmental reevaluation, contingency management, dramatic relief, and helping relationships. Each of these factors is linked to particular therapeutic interventions, although most therapies contain only 2 or 3 of the 10. The concept stage of change refers to the patient's readiness and motivation to change. Five stages have been identified, including precontemplation (the patient is not actively considering change), contemplation (consideration of change without current readiness), preparation, action, and maintenance. Depth of change refers to the sphere of psychological life in which the targeted problem is located, including situational problems, maladaptive thinking, interpersonal conflicts, family conflicts, and intrapersonal conflicts. The trans-theoretical therapist selects interventions that will have maximal impact at the desired level of change, will be consistent with the patient's readiness for change, and will convey the highest level of exposure to the most powerful change factors.

b. Common Factors Eclectic Psychotherapy Sol Garfield described in 2000 another influential integrative model that is grounded in common factors research. Garfield integrates interventions from a variety of psychotherapies, with the aim of providing the patient with a number of positive experiences and skills. The common factors that guide Garfield's selection of therapeutic techniques include an empathic, hope-promoting therapeutic relationship; emotional release or catharsis; explanation and interpretation; desensitization; reinforcement; confrontation of problems; provision of new information and skills; and time as a healing factor.

3. Theoretical Integration

Theoretical integration refers to the most complex and sophisticated mode of psychotherapy integration. Psychotherapies that are theoretically integrated rely on the synthesis of concepts of personality functioning, psychopathology, and psychological change from two or more traditional systems. These integrative theories explain behavior and internal experience in cyclical, interactional terms, by looking for the ways in which environmental, motivational, cognitive, and affective variables influence and are influenced by each other. Perhaps the best known version of theoretical integration is a form of psychotherapy that is so well established that it is recognized only rarely as integrative:

cognitive-behavior therapy. As described by Marvin Goldfried in 1995 in an important work on psychotherapy integration, cognitive-behavior therapy is based on a theory of psychopathology and of personality change that is greater than the sum of its behavioral and cognitive parts. This expanded, integrated theory guides the therapist in the selection and use of interventions that are drawn from each school of therapy.

The systems of psychotherapy that are based on theoretical integration use interventions from each of the component theories, and lead to original techniques that may be added to the technical repertoire of the originating therapeutic schools. At times, the clinical efforts suggested within a theoretically integrated system substantially may resemble the choice of techniques of a technically eclectic model. The essential differences may lie in the belief systems and conceptual explanations that precede the clinical strategies selected by the respective therapists. Theoretical integration goes beyond technical eclecticism in clinical practice by expanding the range of covert and overt factors that can be addressed therapeutically. Subtle interactions between behavioral and interpersonal experiences and internal states and processes can be assessed and targeted for intervention from a number of complementary perspectives. Expected effects of any form of intervention in one or more problem areas can be predicted, tested, and refined as necessary. This conceptual expansion offers a framework in which problems at one level or in one sphere of psychological life can be addressed in formerly incompatible ways. That is, the therapist might target a problem in cognition not only to help the patient to think more adaptively, but to promote change in interpersonal behavior, or to rid the patient of a way of thinking that maintained powerful unconscious feelings.

a. Cyclical Psychodynamics Paul Wachtel introduced the most important and influential integrative approach that exemplifies theoretical integration in 1977. This system is known as cyclical psychodynamics and was the first psychotherapeutic model in which psychodynamic theory and therapy were integrated completely with other systems, including especially behavioral theory and behavior therapy techniques. The integration of psychoanalytic and behavioral theories led to the integrative theory that posited that human beings are influenced by unconscious factors that reflect their ongoing perceptions of significant interpersonal relationships. Further, these unconscious issues were seen as maintained and reinforced by the responses of the persons with whom the patient was interacting.

With this cyclical theory as a foundation, Wachtel pioneered the viewpoint that those clinical issues that were the typical concern of psychodynamic therapists could be addressed in therapy through the use of behavioral techniques such as desensitization and assertiveness training. Wachtel argued convincingly that these active behavioral interventions could reach and change unconscious conflicts, fantasies, and depictions of the self and of other people, and as such were useful within a psychodynamically informed psychotherapy. In an updated work on cyclical psychodynamics that was published in 1997, Wachtel expanded his integrative approach to include concepts and methods that were drawn from family systems therapy and gestalt therapy.

b. Cognitive-Analytic Therapy Cognitive-analytic therapy was developed by Anthony Ryle in his role as a consulting psychiatrist in the British National Health System, and has been described in two books that were published in 1990 and 1997. Cognitive-analytic therapy is a theoretical and technical integration of psychoanalytic object relations theory with schema-based cognitive theory and therapy. Ryle found that it was possible to reconceptualize psychoanalytic concepts as the unconscious images of self and of others in explicit, cognitive terms. This theoretical integration allows the cognitive-analytic therapist to introduce and to emphasize the use of cognitive techniques for the purpose of actively modifying these depictions of the self and of other people that exist outside of the patient's awareness but that exert powerfully negative influence on the patient's behavior, symptoms, and relationships.

c. Assimilative Integration A particular subset of theoretical integration that has been the focus of much recent interest is assimilative integration. This way of thinking about psychotherapy integration was introduced into the literature in 1992 by Stanley Messer. Messer suggested that many integrative approaches could best be termed assimilative due to the impact that new techniques have on the existing conceptual foundation of the therapy. As therapeutic interventions are used in a context other than that in which they originated, the meaning, impact, and utility of those techniques are changed in powerful ways. Essentially, these interventions (such as psychodynamic interpretation used by a behavior therapist) are assimilated into a different model and thus are changed in meaning and in impact. In his discussion of assimilative integration of psychotherapies, Messer pointed out that all actions are defined and contained by the interpersonal, historical,

and physical context in which those acts occur. As any therapeutic intervention is an interpersonal action (and a highly complex one at that) those interventions are defined, and perhaps even re-created, by the larger context of the therapy. Therefore, a behavioral method such as systematic desensitization will mean something entirely different to a patient whose ongoing therapeutic experience has been largely defined by psychodynamically oriented exploration, than that intervention would mean to a patient in traditional behavior therapy.

George Stricker and Jerold Gold introduced an influential version of assimilative integrative psychotherapy into the literature in 1996. This integrative approach is one in which the basis for the therapy is traditional psychodynamic exploration. Most of the therapeutic work is carried out through the usual psychoanalytically oriented techniques of clarification, confrontation of defenses and resistances, and interpretation of unconscious conflict and of transference phenomena. However, there are frequent occasions during which an intervention that originated in cognitive, behavioral, or experiential therapy will be introduced into the treatment. Even though these interventions may seem identical to those used by therapists from those other schools, the assimilative nature of this therapy means that the intention, meaning, and potential impact of these interventions will differ, reflecting the basic psychodynamic foundation of the therapy. As an example, when a common behavioral intervention such as assertiveness training is assimilated, it is chosen as much for its ability to bring unconscious conflicts about anger into awareness for the patient as it is for its behavior benefits. Similarly, the use of a cognitive restructuring technique may help a patient to lessen his or her resistances to therapy by reducing anxiety, as well as helping that person to learn a more adaptive way of thinking.

III. RESEARCH ON INTEGRATIVE APPROACHES TO PSYCHOTHERAPY

Research on systematic eclectic psychotherapy as described by Beutler and Hodgson has yielded promising empirical support for the effectiveness of matching patient characteristics and specific therapeutic interventions. Larry Beutler, Paulo Machado, David Engle, and David Mohr conducted an important study of this approach to integrative psychotherapy in 1993. These authors reported that when depressed patients were assigned randomly to three different forms of psychotherapy, two patient characteristics were crucial in predicting the effectiveness of the different therapies.

As predicted, cognitive therapy was most effective for those patients who externalized responsibility for their depressions, while those patients with an internal locus of control showed the greatest improvement in the insight-oriented, focused expressive psychotherapy. Patients with higher levels of defensiveness and with greater resistance to authority were helped most by a self-directed therapy.

In 1999 James Prochaska and John Norcross summarized the research literature concerned with the effectiveness of technically eclectic psychotherapies. Although they were appropriately concerned with the limitations of the methodologies used in many of these studies, Prochaska and Norcross concluded that this approach had, on average, a moderate to large effect size and performed better than control therapies in about 70% of the studies that were located.

The transtheoretical model of psychotherapy and its basis in the stages of change in psychotherapy as described by James Prochaska and Carlos DiClemente in 1992, has been studied extensively. These studies, summarized by Carol Glass, Diane Arnkoff, and Benjamin Rodriguez in 1998, have demonstrated the maximized effectiveness of psychotherapies that include interventions that are drawn from several different dimensions of psychological life, as does our model. These studies impressively support the idea that technique serves the patient best when interventions are matched to the patient's immediate clinical need and psychological state.

Clinical trials of integrative psychotherapies that synthesize psychodynamic formulations and exploration with active interventions have yielded preliminary but positive results. For instance, the integrative, interpersonal psychotherapy for depression developed by Gerald Klerman, Myrna Weissman, Bruce Rounsaville, and Eve Chevron in 1984 has outperformed medication and other psychological interventions in a number of studies. Haim Omer, writing in 1992, offered empirical support for integrative interventions that heighten the patient's awareness of his or her participation in psychotherapy, thus improving the impact of the basic exploratory stance of the psychotherapist. Carol Glass, Brian Victor, and Diane Arnkoff pointed out in a 1993 publication that several systems of integrative psychotherapy, such as the "FIAT" model (Flexible, Interpersonal orientation, Active, and Teleological understanding) have been demonstrated, albeit in limited numbers of studies, to outperform either strictly psychodynamic or cognitive-behavioral interventions.

Anthony Ryle reported in 1995 that short-term and long-term versions of cognitive analytic therapy (CAT) have been found to be more effective than

purely psychodynamic or behaviorally oriented approaches. Perhaps the most impressive and important collection of studies of integrative psychotherapy that compare the synthesis of two or more approaches with traditional therapies have been carried out by David Shapiro and his colleagues at the Sheffield Psychotherapy Project. Shapiro and Jenny Firth-Cozens reported on this work in an important paper published in 1990. These workers studied the impact of two sequences of combined psychodynamic and cognitive-behavioral therapy: dynamic work followed by active intervention or vice versa. They found that the greatest gains were made, and the smoothest experiences of treatment were reported, by those in the dynamic-behavioral sequence. Patients in the behavioral-dynamic sequence more frequently deteriorated in the second part of the therapy, and did not maintain their gains over time as often as did patients in the other group.

An integrative approach to treating agoraphobia that combines behavioral, systemic, and psychodynamic theories and techniques was evaluated by Diane Chambless, Alan Goldstein, Richard Gallagher, and Priscilla Bright in 1986. These authors found that their integrated model led to marked or great improvement for almost 605 of the patients. Specific treatment effects included lessened avoidance, depression, social phobia, and agoraphobic symptoms, and enhanced assertiveness for their subjects. When this treatment was compared to standard drug therapy and to behavior therapy, the patients treated with the integrated therapy had a much lower dropout rate than either of the other therapies.

Another theoretically integrated approach that has been tested empirically is process-experiential therapy, an integration of principles and methods derived from client-centered, gestalt, and cognitive therapies that was described in 1993 by Leslie Greenberg, Laura Rice, and Robert Elliot. This therapy has been found to be more efficacious than control therapies such as standard behavior therapy. The effectiveness of this integrative model has been demonstrated with individuals on a short-term basis for problems such as anxiety and depression. Glass, Arnkoff, and Rodriguez pointed out in 1998 that a version of this approach that had been adapted for use with couples also has been demonstrated to be more effective than standard control measures.

Dialectical behavior therapy (DBT) is an integrative psychotherapy aimed at alleviating borderline personality disorder. Marsha Linehan described this approach to this disorder in 1987. DBT integrates skills training, cognitive restructuring, and collaborative problem-solving from cognitive-behavior therapy, with relationship elements (such as warmth, empathy, and unconditional

positive regard) from client-centered therapy, and with aspects of psychoanalytic works as well. Borderline personality disorder is recognized by most clinicians as among the most difficult forms of psychopathology to treat, yet DBT has gained wide acceptance among clinicians in recent years, due in great part to the research support for its effectiveness. Glass, Arnkoff, and Rodriguez reported that patients who received DBT demonstrated better treatment retention, had fewer suicide attempts and episodes of self-injury, fewer hospitalizations, decreased anger, greater social adjustment, and more improved general adjustment when compared with those who received standard therapies. These results were maintained over a 1-year follow-up period, and were replicated in a second study.

The first psychotherapeutic approach that has been demonstrated empirically to be effective for treating chronic depression (dysthymic disorder) is an integrative model developed by James McCullough in 2000. This psychotherapy is known as CBASP, for the systems that it synthesizes: Cognitive, Behavioral, Analytic, and Systems psychotherapies. CBASP has been found to be as or more effective as antidepressant medication and traditional forms of psychotherapy in alleviating the symptoms and interpersonal problems involved in chronic depression. As importantly, its results are more enduring and more resistant to relapse than are other treatments.

IV. RANGE OF PATIENT POPULATIONS AND ISSUE OF DIVERSITY

Marvin Goldfried, an early, influential advocate of psychotherapy integration, summed the dilemma of the psychotherapy patient in a cartoon that he included with an article published in 1999. Goldfried's cartoon shows a therapist and patient shaking hands, with two thought bubbles above the head of each person. The therapist is seen to be thinking, "I hope he has what I treat!" while the patient silently worries, "I wonder if he can treat what I have?"

Integrative approaches to psychotherapy would seem, at least in theory, to be uniquely suited to the needs of patients with diverse backgrounds and problems. The problem highlighted by Goldfried may best be avoided by employing an integrative outlook. The hallmark of effective integration is the flexibility of the therapist and the therapeutic approach, and the overriding concern for the individuality of the patient. Unlike many traditional psychotherapeutic systems and schools, wherein the patient is made to fit into, or to

conform with, the therapist's preconceived notion of what works for whom, the integrative therapist tries to tailor the therapy to meet the needs and characteristics of the patient.

Similarly, it would be difficult to think of a specific psychological disorder or patient population for which integrative approaches could not be considered. Since the cornerstone of psychotherapy integration is using the best of what works, any therapeutic approach to any problem may, at least in theory, be improved by the addition of active ingredients from other models.

Presently there exist a number of important contributions to the literature on psychotherapy that are concerned with improving the lot of patients from diverse backgrounds. Sheila Coonerty demonstrated in 1993 that an integrative model of psychotherapy that combines behavioral and psychodynamic elements could be used successfully in the treatment of school-aged children. Mary Fitzpatrick published in 1993 the application of a similar integrative model to the problems of adolescents. Iris Fodor introduced into the literature in 1993 an integrative therapy that was designed particularly for the needs of female patients. Fodor's model integrated concepts and methods from gestalt therapy and cognitive-behavior therapy with feminist theory and therapy. Many integrative therapists have focused on improving the effectiveness of family therapies by adding elements from other schools of psychotherapy. Among the more influential approaches of this type are William Pinsof's integrative family therapy, published in 1995, which assimilated behavior, cognitive, and psychoanalytic methods into family therapy, and Mary Joan Gerson's 1996 integration of psychoanalytic and family systems therapies.

In 1993 Anderson Franklin, Robert Carter, and Cynthia Grace described an integrative approach to psychotherapy with Black African Americans in which issues of race and culture were synthesized with clinical concepts and methods. These authors illustrated how an understanding of the adverse social and cultural factors in American life that shape African American identity development and family structure can be integrated with a variety of therapeutic approaches within a systems framework. Nicholas Papouchis and Vicky Passman, also writing in 1993, described an integrative model of psychotherapy specifically designed to meet the needs of geriatric patients. These authors described how the cognitive deficits, personal losses, and physical illnesses that often afflict the elderly make the traditional psychodynamic therapist less accessible to many older people. However, Papouchis and Passman

pointed out that the judicious integration of structured cognitive-behavioral techniques into a psychodynamically oriented psychotherapy may be used effectively by this population, allowing these patients to benefit from the curative factors contained in both approaches.

A number of integrative psychotherapists have explored the ways in which an integrative perspective can be helpful in extending the reach of Western psychotherapies to other sectors of the world. These contributions collectively demonstrate the cultural sensitivity and respect for indigenous traditions, meanings, and ways of life that must be part and parcel of any effective psychotherapy. Articles by Sylvester Madu and Karl Pelzer, both of which appeared in 1991, described integrative therapeutic systems that synthesized several Western therapies with traditional African modes of healing. Both of these writers noted that the openness and flexibility of integrative therapies made these approaches more likely to be able to accommodate the cultural necessities of African life than were standard forms of treatment. Willi Butollo published in 2000 a report of an integrative therapy that he had developed while working in refugee camps in Bosnia during and after the civil war and ethnically motivated atrocities that occurred in the Balkans. Butollo's approach synthesized elements from humanistic, interpersonal, psychodynamic, and cognitive-behavior therapies, and was found clinically to be extremely effective in helping trauma survivors to recover from posttraumatic syndromes.

Integrative therapists have been concerned with expanding the effectiveness of psychotherapy to include politically and economically disenfranchised individuals. In 1989 Paul Wachtel expanded his pioneering integration of psychoanalysis and behavior therapy by focusing on the economic, political, and societal factors that lead to psychopathology. Wachtel then expanded his clinical methodology to include intervention in these areas.

In 1990 Jerold Gold described an integrative therapy that was aimed at helping institutionalized inner-city children and adolescents recover from the mixed impact of individual psychopathology, family dysfunction, and social problems such as divorce, poverty, drug abuse, malnutrition, and substandard housing. Gold's synthesis of psychodynamic, family systems, and behavioral methods also included a strong emphasis on understanding and utilizing the cultural framework within which each patient lived, and posited for the therapist the role of social and political advocate when appropriate.

Integrative psychotherapies have been applied successfully to a wide range of clinical syndromes and patient

populations. Anxiety disorders and related conditions such as panic disorders and phobias are the focus of at least three integrative models. As noted above, Diane Chambless and her colleagues demonstrated in 1986 that an integrative treatment model for agoraphobia was highly successful in alleviating that difficult condition. Barry Wolfe described an integrative approach to anxiety disorders that has been highly influential since it appeared in print in 1992. Wolfe proposed a developmental model for anxiety disorders in which unconsciously processed experiences of self-endangerment are established and maintained during traumatic interpersonal experiences. Wolfe demonstrated how an integration of imagery, behavioral, experiential, and interpersonal techniques could be used to treat this disorder. Another integrative therapy for anxiety disorders was published in 1993 by Jerold Gold, who based his integrative model on a synthesis of concepts and methods from attachment theory, behavior therapy, and humanistic therapy. Obsessive-compulsive disorder was targeted for treatment by R. Harris McCarter in 1997. This author based his approach on a combination of behaviorally oriented exposure techniques with psychoanalytic interventions that were aimed at enhancing the patient's ability to regulate his or her internal emotional experience.

Depression, in its acute and chronic manifestations, has been the focus of much effort on the part of integrationists. We have already encountered the integrative, interpersonal psychotherapy for depression developed by Gerald Klerman, Myrna Weissman, Bruce Rounsaville, and Eve Chevron in 1984. In 1992 Hal Arkowitz presented an integrative approach to depression that exemplified a common factors model. In 1993 Adele Hayes and Cory Newman wrote about an integrative model for depression that allowed the therapist to intervene with techniques drawn from behavior therapy, cognitive therapy, experiential therapy, interpersonal therapy, psychodynamic therapy, and biological psychiatry. As discussed earlier, the most effective therapy for chronic depression that has been introduced to date is the integrative CBASP model that was described by James McCullough in 2000.

Other integrationists have turned their attention to more severe disorders that often are impervious to the effects of traditional psychotherapies. One of the most important examples of this work was discussed earlier in this article, that being Marsha Linehan's dialectical behavior therapy for borderline personality disorder. Anthony Ryle wrote in 1997 of his successful attempt to treat borderline and narcissistic disorders with cognitive analytic therapy. Other important integrative models

that have been applied to severe psychopathology include Mitchell Becker's treatment for organic disorders that he wrote about in 1993; the integrative therapy for bulimia proposed by David Tobin in 1995; Nicholas Cummings' integrative psychotherapy for substances abusers, reported on in 1993; and integrative therapies for schizophrenia discussed by David Hellcamp in 1993 and by Giovanni Zapparoli and Maria Gislon in 1999. Finally, integrative models have made inroads into areas such as health psychology, as discussed by Robert Dworkin and Roy Grzesiak in 1993. These authors described an integrative psychotherapeutic approach to the treatment of chronic pain that combined the behaviorally oriented procedures of biofeedback, hypnosis, and relaxation with psychodynamic exploration and medical interventions.

V. CASE EXAMPLE

This brief case report is drawn from the author's practice and exemplifies aspects of theoretical, assimilative integration and an instance of technical eclecticism. It overlaps to a large degree with other integrative approaches but cannot be assumed to illustrate exactly the many approaches that have been discussed in this article.

Mr. X was a 35-year-old single man who had entered psychotherapy suffering from dysthymic disorder of several years' duration. He was seen in weekly psychodynamic psychotherapy sessions. As the therapy unfolded the unconscious determinants of Mr. X's depression were explored and were interpreted to him. It became clear that Mr. X had never gotten over the dissolution of his relationships with his parents, which had occurred when the patient was in his late twenties. At that time he had abandoned a lucrative career in the financial industry to become a high school teacher. This decision was highly satisfying to him on an emotional and interpersonal level, but was experienced by his parents as a major disappointment and betrayal. After trying to "mend fences" and receiving only continued anger and criticism from his parents, Mr. X had stopped seeing and speaking to them.

As far as the patient was aware, he had gotten over his hurt, anger, and longing for contact with and approval from, his family. However, as his dreams, free associations, and reactions to the therapist were explored, it became apparent that he was stuck in a process of interrupted mourning for his parents. In this state he was beset by helpless rage at his mother and father, guilt and shame at having hurt them, and an unrealistic hope that

they would one day come to love and accept him for his choice. All of these emotions were kept outside of his awareness through active defensive processes, among which was the unwitting decision to turn his anger against himself. The outcome of these unconscious attacks on himself was to feel sad, listless, and depleted, and to be constantly plagued by self-critical thoughts and images.

Interpretation of these unconscious processes and emotions helped to gain some distance and relief from his self-critical, attacking stance, but he was still unable to feel the anger and longing that he agreed intellectually seemed to be at the core of his depression. At this point, a period of cognitive restructuring was begun, with two goals: first, to further alleviate the patient's suffering, and second, because it was assumed that the presence of these thoughts continued to turn Mr. X's anger at his parents back toward himself to externalize his anger. The use of the cognitive intervention to test this was typical of assimilative integration, as it involved using a technique from cognitive therapy in order to promote change at a psychodynamic level.

As Mr. X became increasingly successful at countering his self-critical thinking, his depressive symptoms improved significantly. He began to have longer periods during which his self-esteem was maintained. As importantly, he began to recognize that the internal stimuli for his self-criticism often were dimly perceived reminders of his parents, and he began to fully feel the anger that their rejection still evoked in him. It seemed that the integration of cognitive restructuring had in fact accomplished its assimilative goal of reaching and making more accessible to the patient previously disavowed, unconscious emotional conflicts.

As Mr. X gained more access to his anger and feelings of rejection, his guilt and sense of failure diminished greatly. However, he also experienced a powerful upsurge of longing for his parents and for their love and approval. These feelings led him to contact them, but he was rebuffed in a cold and cruel way when he refused to give into their demands to return to his old job. This experience was, of course, entirely disheartening to the patient, but did help him to recover a series of memories from his childhood, all of which were concerned with his inability to satisfy his parents' demands for academic, social, and athletic success on his part. These memories echoed his present-day experience in their emotional tone of longing for love, and of feeling essentially unlovable because of his inability to attain it from his parents.

Mr. X explored these memories, emotions, and the connected image of himself as unlovable, for a number

of weeks without much progress. Remembering the success he had had with the introduction into the therapy of cognitive techniques, Mr. X asked the therapist if there might be another way to approach these issues. The therapist suggested that Mr. X might try using the empty chair technique. This method originated in gestalt therapy and involves speaking to an imaginary person whom the patient imagines is sitting in a chair in the therapist's office. This technique has been found empirically to be highly effective in helping people with "unfinished business" in this case, with Mr. X's incomplete mourning and with his longing for parental approval and love that did not seem possible to obtain. This prescriptive matching of an effective technique with a specified problem is typical of technical eclecticism, but in this case it also has an assimilative purpose. The therapist hoped that any unconscious factors that were maintaining the patient's longing could become more accessible by having Mr. X interact with the images of his parents in the sessions. As Mr. X spoke with the imaginary figures in the empty chair he was able to experience his need for love and approval in an expanded way, and found that this catharsis left him sad but comforted at the same time, with a lessened sense of need. He also became aware that he had always blamed himself for his parents' coldness and criticism. His dialogue with them helped him to become more aware of their intrinsic emotional limitations, and to separate his sense of worth and of being lovable from their inability to love. Again, the integrative technique had been successful at two levels, in this case at the experiential level for which the method had been designed, and at the psychodynamic level for which it had been integrated in an assimilative mode.

After about 11 months of therapy, Mr. X had freed himself of his dysphoric mood, but had begun to experience frequent bouts of anxiety that bordered on panic. It became clear that he also suffered from significant social anxiety that had been disguised and warded off by his depression.

Attempts to explore Mr. X's anxiety symptoms, and to identify the situational precipitants or the psychodynamic meanings of these symptoms, were fruitless and frustrating. Mr. X felt helpless and incompetent during these discussions, and the therapist eventually began to consider these interactions as constituting a transference repetition of some past relationship in which Mr. X's distress had been responded to with a lack of concern or competence on the part of a significant other. The therapist then suggested a change of tactics: the introduction of cognitive-behavioral techniques that were aimed at relaxation, anxiety management, and self-soothing.

These techniques were employed for a number of simultaneous purposes. The first purpose was to address the clinical situation and to enable Mr. X to master his anxiety and to gain a new level of comfort when faced with anxiety. Second, these active interventions were a way to move the therapy past this stalemate, and thus to resolve the resistances involved in the patient's anxiety symptoms without addressing those resistances directly. Attempts to explore and interpret the unconsciously motivated, resistive nature of the patient's anxiety had led only to Mr. X feeling criticized, ineffective, and "stupid," and to a perception of the therapist as hostile and demeaning. Finally, the therapist hoped that by actively helping Mr. X to lessen his anxiety, the patient would have an immediate (corrective emotional) experience of being valued and cared for that would illuminate and correct the negative enactment in which patient and therapist were caught.

As Mr. X became more capable of managing his anxiety he also became more aware of the interpersonal precipitants of these symptoms, and was better able to explore the warded-off meanings as well. Most important, patient and therapist were able to reestablish a positive working alliance and to explore fruitfully the past relationships, particularly with Mr. X's father, in which Mr. X's pain and fear had been met by indifference and ridicule. As he stated, "By showing that you cared how I felt and that you were willing to help in an accepting way, you proved how different you are from my father. That allowed me to see and feel how hurt and angry I am at him for how he made fun of me when I was scared, and how I expect that, and get it from others now."

This case example demonstrates the ways in which interventions from another therapeutic system can be assimilated into psychodynamic therapy, changing the meaning and impact of that intervention, and eventuating in psychodynamic and interpersonal changes that would not be anticipated in the original (here, cognitive-behavioral and experiential) systems. The active interventions led to the reduction of painful symptoms and the acquisition of new skills, but also to a radical shift in the patient's defenses, transference situation, and his understanding of his psychodynamics. Most important, the active provision of help led to the establishment of new and benign ways of perceiving himself

and important people in his life, which became the bases for hopefulness, a sense of self-worth, and a newly independent, grief-free, way of life.

VI. SUMMARY

Integrative approaches to psychotherapy blend together techniques and ideas that are drawn from the widest possible ranges of schools of psychotherapy. The goal inherent in these approaches is maximizing the patient's exposure to those factors that induce change. As such, integrative approaches represent an attempt to develop and apply, custom-fitted, broad-spectrum psychotherapies that will meet the needs of the majority of patients.

Among the many useful integrative approaches there are a number that synthesize psychoanalytic, cognitive, and behavioral features. Others emphasize the integration of humanistic and experiential therapies with more active approaches, while still a third group has focused on the combination of family systems and integrative models. Some integrative therapies are empirically tested and are guided by data, while others reflect clinical wisdom and experience.

See Also the Following Articles

Alternatives to Psychotherapy ■ Existential Psychotherapy ■ History of Psychotherapy ■ Humanistic Psychotherapy ■ Individual Psychotherapy ■ Interpersonal Psychotherapy ■ Multimodal Behavior Therapy ■ Research in Psychotherapy

Further Reading

- Beier, E. G. (1966). *The silent language of psychotherapy*. Chicago: Aldine.
- Bohart, A. C., & Tallman, K. (1999). *How clients make therapy work*. Washington, DC: American Psychological Association.
- Cummings, N., & Cummings, J. (2000). *The essence of psychotherapy*. New York: Academic Press.
- Gold, J. R. (1996). *Key concepts in psychotherapy integration*. New York: Plenum.
- Hubble, M., Duncan, B., & Miller, S. (1998). *The heart and soul of change*. Washington, DC: American Psychological Association.

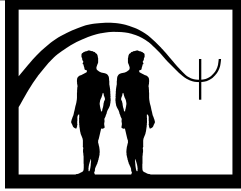

Interpersonal Psychotherapy

Scott Stuart

University of Iowa and Iowa Depression
and Clinical Research Center

Michael Robertson

Mayo-Wesley Centre for Mental Health

- I. Treatment Description
 - II. Theoretical Basis
 - III. Applications and Exclusions
 - IV. Empirical Studies
 - V. Summary
- Further Reading

GLOSSARY

cognitive behavior therapy (CBT) A treatment which focuses on the patient's internally based cognitions in an effort to relieve symptoms, change behavior, and ease suffering.

content affect Refers to the dominant feeling experienced at the time of a significant event.

defense mechanisms Psychological structures that assist in the modulation of internal conflicts in order to achieve harmony, both internally with demands and prohibitions, and externally with social reality and individual desires, needs, and wishes.

ego strength A term broadly referring to the ability to modulate and balance internal needs and wishes with external reality. Sometimes the term is simply used to refer to the ability to withstand threats from the external world and to modify the external world.

here and now A term that refers to present, ongoing active events in interpersonal relationships, in contrast to fantasized future or past presentations.

interpersonal incidents Descriptions by the patient of specific interactions with a significant other.

interpersonal inventory A brief description of important people in a person's life, which include the amount and quality

of contact, problems in the relationship, and expectations about the relationship.

interpersonal psychotherapy (IPT) A time-limited treatment that focuses on interpersonal relationships as a means of bringing about symptom relief and improvement in interpersonal functioning.

maintenance treatment The explicit agreement to continue treatment and contact at a "lower dose" than the agreed upon for active treatment.

process affect Refers to the emotion experienced by the patient as he or she is describing to the therapist events surrounding the cause of the affect.

transference The feelings and attitudes brought about towards a person in the present that stem from unconscious feelings and attitudes derived from a relationship with a person in the past.

treatment contract The conscious and explicit understanding between the therapist and the patient, which includes the number, frequency, and duration of sessions, the clinical foci of treatment, the roles of the patient and therapist, and the planning for contingencies such as illness, lateness, missed sessions, and acceptable and unacceptable contact for out of session and off hour emergencies and behavioral expectations, such as substance abuse.

Interpersonal psychotherapy (IPT) is a time-limited treatment that focuses on interpersonal relationships as a means of bringing about symptom relief and improvement in interpersonal functioning. This article will describe the fundamental characteristics of IPT, the

theoretical basis of the treatment, and will detail several of the therapeutic interventions used in IPT.

I. TREATMENT DESCRIPTION

A. Introduction

IPT is a time-limited, dynamically informed psychotherapy that aims to alleviate patients' suffering and improve their interpersonal functioning. IPT focuses specifically on interpersonal relationships as a means of bringing about change, with the goal of helping patients to either improve their interpersonal relationships or change their expectations about them. In addition, IPT also aims to assist patients to improve their social support network so that they can better manage their current interpersonal distress.

IPT was originally developed in a research context as a treatment for major depression, and was codified in a manual developed by Klerman and colleagues in 1984. Since that time, a great deal of empirical evidence supporting its use has accumulated. As clinical experience with IPT has increased, its use has broadened to include both a number of well-specified *Diagnostic and Statistical Manual of Mental Disorders, 4th edition* (DSM-IV) diagnoses and the treatment of patients presenting with a variety of interpersonal problems.

IPT is based on both empirical research and clinical experience. Rather than being a static and codified treatment, IPT is designed to incorporate changes that improve the treatment, as additional data and clinical experience accumulate. Instead of being applied in a strict "manualized" form in which the clinician is required to follow precisely a treatment protocol, clinicians using IPT are encouraged to use their clinical judgment to modify the treatment when necessary in order to provide maximum benefit for their patients. The practice of IPT should be based on equal measures of empirical research, clinical experience, and clinical judgment.

B. Characteristics of IPT

IPT is characterized by three primary elements: (1) IPT focuses specifically on interpersonal relationships; (2) IPT is time limited as an acute treatment; and (3) the interventions used in IPT do not directly address the transference relationship.

1. Interpersonal Relationships

Interpersonal psychotherapy is based on the concept that interpersonal distress is linked with psychological

symptoms. Thus the foci of treatment are twofold. One focus is the difficulties and changes in relationships that patients are experiencing, with the aim of helping patients to either improve communication within those relationships, or to change their expectations about those relationships. The second focus is helping patients to better utilize their social support network so that they are better able to deal with the crises that precipitated their distress.

Interpersonal psychotherapy therefore stands in contrast to treatments such as cognitive-behavior therapy (CBT) and psychoanalytically oriented psychotherapy. In contrast to CBT, in which the focus of treatment is the patient's internally based cognitions, IPT focuses on the patient's interpersonal communications. In contrast to analytically oriented treatments, in which the focus of treatment is on understanding the contribution of early life experiences to psychological functioning, IPT focuses on helping the patient to improve communication and social support in the present. Past experiences, although clearly influencing current functioning, are not a major focus of intervention.

Interpersonal psychotherapy seeks to resolve psychiatric symptoms rather than to change underlying dynamic structures. Although ego strength, defense mechanisms, and personality characteristics are all important in assessing suitability for treatment, change in these constructs are not presumed to occur in IPT. The question that should drive the therapist's interventions is, "Given this particular patient's personality style, ego strength, defense mechanisms, and early life experiences, how can he or she be helped to improve here-and-now interpersonal relationships and build a more effective social support network?"

2. Time Limit

The acute phase of IPT is time-limited. In general, a course of 12 to 20 sessions is used for the acute treatment of depression and other major psychiatric illnesses, and a contract should be established with the patient to end acute treatment after a specified number of sessions. Clinical experience has shown that having a definitive endpoint for therapy often "pushes" patients to make changes in their relationships more quickly. The time limit also influences both patient and therapist to focus on improving the patient's interpersonal functioning in current relationships.

Although empirical research is limited to controlled treatment studies in which weekly treatment is provided and then abruptly stopped, clinical experience has clearly demonstrated that tapering treatment over time is more effective. In other words, weekly sessions may be used for

6 to 10 weeks, followed by a gradual increase in the time between sessions as the patient improves, such that weekly sessions may be followed by biweekly and monthly meetings. Although acute treatment should be time-limited, both empirical research and clinical experience have clearly demonstrated that maintenance treatment with IPT, particularly for recurrent disorders such as depression, should be provided to reduce relapse risk. Maintenance IPT must be distinguished from the acute phase of treatment in IPT, and a specific contract must be negotiated with the patient for the maintenance phase.

3. The Interventions Used in IPT Do Not Directly Address the Transference Relationship

The third characteristic of IPT is the absence of interventions that address the transference aspects of the therapeutic relationship. It is readily acknowledged in IPT that transference occurs; it is a universal phenomenon in all psychotherapy. However, although in IPT the therapist's experience of transference is used to provide information about the patient and his or her interpersonal relationships, the transference relationship is not addressed directly. To do so detracts from the focus on symptom reduction and rapid improvement in interpersonal functioning that is the aim of IPT, and also typically leads to a longer course of treatment than is required for IPT. The goal in IPT is to work with the patient quickly to solve his or her interpersonal problems before problematic transference develops and becomes the focus of treatment.

Although the transference is not directly addressed, the use of transference in IPT to assess the patient's attachment style and to understand the patient's interpersonal functioning is crucial. The use of transference to formulate questions about the patient's interpersonal relationships outside of therapy is also important. The transferential experience should be used by the therapist to formulate hypotheses about the patient's interpersonal difficulties, and to ask questions about how the patient asks others for help, ends relationships, and reacts when others are not responsive to his or her needs. These questions are directed outside of the therapy relationship, however, to current interpersonal relationships.

As an illustration, consider a patient who forms a dependent relationship with the therapist. The patient may manifest this dependency as difficulty in ending sessions, calls to the therapist between sessions, or in more subtle pleas to the therapist for help or reassurance. This transferential relationship should inform the therapist about several aspects of the patient's functioning: (1) The

patient is likely to have similar problems in relating to others; (2) the patient is likely to have difficulty in ending relationships; and (3) the patient has likely exhausted others with the persistent dependency. A hypochondriacal patient would be an excellent example of this kind of behavior, manifested in the ways described.

Further, the transferential experience should be used by the therapist to predict potential problems in treatment, and to modify the therapy accordingly. For instance, the therapist might hypothesize that the patient's dependency may be a problem when concluding treatment, and may begin discussing the ending of therapy much sooner than with less dependent patients. The therapist should also strongly encourage a dependent patient to build a more effective social support network, so that the patient's needs are more fully met outside of therapy rather than fostering a dependent or regressive relationship in the therapy itself. Appropriate modifications would also be made with patients who are avoidant or who manifest other personality characteristics.

C. Treatment Process

IPT can be divided into assessment (described later), initial sessions, intermediate sessions, treatment conclusion, and maintenance treatment phases. During each, the clinician has a well-defined set of tasks to accomplish. Undergirding these therapeutic tasks and techniques is the stance taken by the therapist. Clinicians should be active and maintain the focus of therapy. The therapist should also be supportive, empathic, and strongly encouraging, and should make every effort to convey a sense of hope to the patient and to reinforce his or her gains.

1. Initial Sessions

During the initial sessions of IPT (usually the first one or two meetings following the general assessment) the therapist has three specific tasks. These are (1) to conduct an interpersonal inventory; (2) to work collaboratively with the patient to determine which problem areas will be the focus of treatment; and (3) to develop a treatment contract with the patient.

The interpersonal inventory is a brief description of the important people in the patient's life, and for each includes the amount and quality of contact, problems in the relationship, and the expectations about the relationship. These descriptions need not be exhaustive; those that become treatment foci will be revisited in detail later. The purpose of the inventory is to determine which relationships to work on, and to gather further

information regarding the patient's attachment and communication patterns.

Once the inventory is complete, the patient and clinician should mutually identify one or two problem relationships on which to focus. The therapist should frame the patient's problem as interpersonal, and should give specific examples of the way in which the problem fits into one of the four problem areas: grief and loss, interpersonal disputes, role transitions, or interpersonal sensitivity.

Establishing a treatment contract is an essential part of IPT. In general, the contract should specifically address (1) the number, frequency and duration of sessions, which in general will be about 12 to 20; (2) the clinical foci of treatment; (3) the roles of the patient and therapist, particularly the need for the patient to take responsibility for working on his or her communication between sessions; (4) contingency planning: issues such as missed sessions, lateness or illness; and (5) acceptable conduct: contact out of hours, emergencies, and behavioral expectations such as substance use.

Because of the injunction in IPT to limit discussing the transference relationship directly, the contract must serve as a rock solid point of reference for both patient and therapist. Thus when contract violations occur, the therapist can remind the patient that both had initially agreed on certain guidelines for therapy, and that the patient, by failing to meet his or her responsibility, is in essence minimizing the benefit of the treatment. The therapist would then proceed to ask questions about similar behavior outside of the therapeutic relationship.

2. Intermediate Sessions

During the intermediate sessions of IPT, the patient and therapist work together to address the interpersonal problems identified during the assessment. In general, work on these issues proceeds in the following order: (1) identification of a specific interpersonal problem; (2) a detailed exploration of the patient's perception of the problem, including communication patterns and expectations about the relationship; (3) collaborative brainstorming to identify possible solutions to the problem; (4) implementation of the proposed solution; and (5) reviewing the patient's attempted solution, with positive reinforcement of the changes made and discussion of refinements to be carried out.

The tasks of the therapist in the intermediate sessions of IPT are to assist the patient in discussing his or her problematic interpersonal relationships, and to attend to the therapeutic relationship. In addition, the

therapist must actively work to maintain the focus of therapy, rather than encouraging or allowing the patient to talk about peripheral issues.

Once a specific issue is identified, the therapist should encourage the patient to describe his or her perceptions and expectations about the relationship problem. Whether it is a problem in communication or a matter of unrealistic expectations, the patient and therapist work collaboratively to brainstorm and identify possible solutions. The patient is responsible for attempting to implement the agreed upon solution, and to provide feedback regarding the attempted solution and its results at the next session. The therapist and patient then review these results and make modifications as needed.

A number of solutions can be considered in IPT. For instance, a change in communication to a style that is more direct may be of help with a dispute. A change in circumstances, such as a change in location or in employment, may be of benefit during a role transition. Changes in expectations, with a movement toward other social support, are also viable options. In IPT, however, the endpoint of therapy is not simply insight; it is change in communication, behavior, and social support that leads to symptom resolution.

3. Completing Acute Treatment

Acute treatment with IPT comes to an end as specified by the therapeutic contract. There are both theoretical and practical reasons for keeping acute treatment with IPT time-limited. The time limit is very effective in generating change, as it often compels patients to work more rapidly on improving communication skills and building more effective social networks. In addition, the time limit influences both patient and therapist to focus on acute symptoms rather than on personality change. Moreover, to extend IPT beyond the acute time frame may lead to the development of problematic transference, as the relationship between patient and therapist assumes greater importance.

On the other hand, the success of therapy is also dependent on the patient's belief that the therapist is committed to helping the patient, and that the patient's needs supercede other considerations. The IPT therapist should prioritize helping the patient ahead of satisfying the dictates of a manualized protocol. Consequently, if extending the therapy beyond the number of sessions initially agreed upon is clearly in the patient's best interest, then it should be extended. The apparent conflict between maintaining the therapeutic contract and extending sessions when needed can be resolved by renegotiating a new treatment contract with the patient. Clinical judgment should be used to make such a decision.

Clinical experience with IPT strongly suggests that the best clinical practice is usually to extend the interval between sessions once the patient is in the recovery stage of acute treatment. Rather than continuing to meet weekly, the patient and therapist may choose to meet biweekly or even monthly toward the end of treatment. This gives the patient further opportunities to practice communication skills, to reinforce the changes that have been made, and to develop more self-confidence while remaining in a supportive relationship, all of which facilitate better and more stable functioning.

As the primary goals of IPT are symptom relief and improvement in interpersonal functioning, the specific aims of treatment conclusion are to foster the patient's independent functioning and to enhance his or her sense of competence. The therapist is still available should a future emergency arise, but the expectation is that the patient will quite capably function independently.

4. Maintenance Treatment

Rather than using the traditional psychoanalytic model in which "termination" is a complete severing of the therapeutic relationship, concluding acute treatment with IPT does not signify the end of the therapeutic relationship. In fact, in IPT it is usually agreed that there will be therapeutic contacts in the future, and provision is specifically made for these. Clinical experience, theory, and empirical evidence all make clear that IPT should be conceptualized as a two-phase treatment, in which a more intense acute phase of treatment focuses on resolution of immediate symptoms, and a subsequent maintenance phase follows with the intent of preventing relapse and maintaining productive interpersonal functioning. Therefore, the therapist should specifically discuss future treatment with the patient prior to concluding therapy. A specific contract should be established with the patient for the specific alternative for the provision of maintenance treatment that is chosen. Options include specifically scheduling maintenance sessions at monthly or greater intervals; concluding acute treatment with the understanding that the patient will contact the therapist should problems recur; or planning to have the patient contact another provider in the future. Decisions about how to structure future treatment should rely on clinical judgment.

In essence, IPT follows a "family practice" or "general practitioner" model, in which short-term treatment for an acute problem or stressor is provided until the problem is resolved. Once resolved, however, the therapeutic relationship is not terminated; as with a general practitioner, the therapist makes himself or her-

self available to the patient should another crisis occur, when another time-limited course of treatment can be undertaken. In the interim, the therapist may choose, like a general practitioner, to provide "health maintenance" sessions periodically. There is no compelling clinical or theoretical reason to come to a complete termination with most patients in IPT, while the data clearly support the benefit of maintenance treatment.

D. Techniques and Therapeutic Process

It is the focus on extra-therapeutic interpersonal relationships rather than any particular intervention which characterizes IPT. Not surprisingly, given its psychodynamic roots, IPT incorporates a number of "traditional" psychotherapeutic methods, such as exploration, clarification, and even some directive techniques. While there are no techniques which are actually forbidden in IPT, all should be used in the service of helping the patient to modify interpersonal relationships.

More important than any techniques, however, is the establishment of a productive therapeutic alliance. Warmth, empathy, genuineness, and conveying unconditional positive regard, though not sufficient for change, are all necessary for change in IPT. Without a productive alliance, the patient will flee therapy, an obstacle which no amount of technical expertise can overcome.

A primary goal of the IPT therapist should be to understand the patient. If the patient does not perceive that the therapist is truly committed to doing this, the patient will not readily disclose information, will not feel valued as an individual, and will not develop a meaningful relationship with the therapist. Working to understand the patient should always take precedence over any technical interventions. Further, all IPT interventions should be therapeutic; the ultimate value of an intervention is the degree to which it helps the patient. Techniques should not be used simply because they are included in a manualized protocol; the benefit to the patient should guide the interventions used in treatment.

1. Nonspecific Techniques

Nonspecific techniques are generally understood as those that are held in common across most psychotherapies. Examples would be the use of open-ended questions, clarifications, and the expression of empathy by the therapist. These techniques play a crucial role in IPT, as they serve to help the therapist understand the patient's experience, convey that understanding to the patient, and to provide information regarding the genesis

of the patient's problems and potential solutions to them. Techniques such as problem solving with the patient, giving directives, and assigning homework can also be used judiciously in the service of facilitating interpersonal change.

2. Communication Analysis and Interpersonal Incidents

The analysis of the patient's communication patterns is one of the primary techniques used in IPT. The therapist's task is to assist the patient to communicate more clearly what he or she wants from significant others. Communication analysis requires that the therapist elicit information from the patient about important interpersonal incidents. Interpersonal incidents are descriptions by the patient of specific interactions with a significant other. If the identified dispute results in a pattern of fighting between spouses, the therapist might ask the patient to "describe the last time you and your spouse got into a fight," or to "describe one of the more recent big fights you had with your spouse." The therapist should direct the patient to describe the communication that occurred in detail, re-creating the dialogue as accurately as possible. The patient should describe his or her affective reactions as well as both verbal and nonverbal responses, and describe observations of his or her spouse's nonverbal behavior.

The purpose of discussing an interpersonal incident is twofold: (1) to provide information regarding the miscommunication that is occurring between the parties; and (2) to provide insight to the patient about the unrealistic view that the problem is intractable. The goal in working through an interpersonal incident is to examine the patient's communication so that maladaptive patterns of communication can be identified. The patient can then begin to modify his or her communication so that his or her attachment needs are better met.

3. Use of Affect

The more the patient is affectively involved in the issues being discussed, the greater the motivation to change behavior or communication style. Consequently, one of the most important tasks for the IPT therapist is to attend to the patient's affective state. Of particular importance are those moments in therapy in which the patient's observed affective state, and his or her subjectively reported affect, are incongruent. Examining this inconsistency in affect can often lead to breakthroughs in therapy.

Affect can be divided into that experienced during therapy (process affect) and that reported by the patient to have occurred in the past (content affect). Con-

tent affect refers to the predominant affect experienced at the time of a significant event. For instance, a patient might describe feeling "numb" at the time of the death and funeral of a significant other. Process affect, on the other hand, refers to the affect experienced by the patient as he or she is describing to the therapist the events surrounding the loss. The same patient, for example, might describe a "numb" feeling at the time of the funeral, but when describing the event to the therapist might be in tears, and feeling sadness, or perhaps anger. When met with this incongruence in affect, the therapist can focus directly on the discrepancy between content and process affect. In other words, when the report the patient gives about how he or she felt during an interpersonal event is different from the affect he or she is exhibiting during the session, it should be noted by the therapist and explored further.

4. Use of Transference

Transference is a universal occurrence in all psychotherapies, and plays an extremely important part in IPT. However, in contrast to longer-term psychodynamic therapies, information gleaned from the transference that develops during IPT, although an important source of data, is not typically a point of intervention.

By observing the developing transference, the IPT therapist can begin to draw hypotheses about the way that the patient interacts with others outside of the therapeutic relationship. Sullivan coined the term "parataxic distortion" to describe this phenomena: The way in which a patient relates to the therapist in session is a reflection of the way in which he or she relates to others as well. Attachment theory also supports the idea that individuals tend to relate to others in a manner that is consistent both across relationships and within relationships. Thus the transference or parataxic distortion recognized by the clinician provides a means of understanding all of the other relationships in the patient's interpersonal sphere.

Using these data, the therapist can then begin to draw conclusions about the patient's attachment style and problems in communicating to others. The therapist should ask questions to confirm or disprove these hypotheses. For instance, if the therapist notes that the patient tends to be deferential in therapy, hypothesizing that the patient tends to be the same way in other relationships is reasonable. The therapist may want to ask about the experiences (or difficulties) that the patient has had in confronting others, or in dealing with rejection. Similarly, if the patient behaves in a dependent manner during therapy, the therapist may ask about

how the patient maintains relationships, or about experiences the patient has had in ending relationships.

The key difference between IPT and transference-based therapies is that the IPT therapist should avoid making transference comments, and particularly interpretations, about the therapeutic relationship. As long as a reasonably positive transference is maintained, therapy can proceed without the need to focus on it. The therapist should focus instead on the here-and-now problems in the patient's extratherapy interpersonal relationships. With well-selected patients, keeping the therapy short-term allows the therapist to assist the patient to solve his or her interpersonal problems before the transference becomes intense, and as a result, becomes the new focus of therapy.

E. Interpersonal Model

1. Problem Areas

IPT focuses on four specific interpersonal problem areas: grief and loss, interpersonal disputes, role transitions, and interpersonal sensitivity. Psychosocial stressors from any of the problem areas, when combined with an attachment disruption in the context of poor social support, can lead to interpersonal problems or psychiatric syndromes. Although these categories are useful in focusing the patient on specific interpersonal problems, it is important to be flexible when using them. Rather than "diagnosing" a specific category, the problem areas should be used primarily to maintain focus on one or two interpersonal problems, particularly as the time available in IPT is limited. Because the interpersonal problems experienced by patients are all derived from the combination of an acute interpersonal stressor combined with a social support system that does not sufficiently sustain the patient, effort should always be directed toward improving the patient's social supports as well as addressing the specific problem.

a. Grief and Loss. Grief in IPT can best be conceptualized as a loss experienced by the patient. In addition to the death of a significant other, a loss such as divorce may be seen by the patient as a grief issue. Loss of physical functioning, such as that following a heart attack or traumatic injury, may also appropriately be considered in the grief problem area.

The therapist's tasks are to facilitate the patient's mourning process, and to assist the patient to develop new interpersonal relationships, or to modify existing relationships to increase social support. Although new or existing relationships cannot "replace" the lost rela-

tionship, the patient can reallocate his or her energies and interpersonal resources over time.

Several strategies are useful in dealing with grief issues. Primary among these is the elicitation of feelings from the patient, which may be facilitated by discussing the loss and the circumstances surrounding it. The use of process and content affect may be quite useful. Often the patient will initially describe the lost person as "all good" or "all bad," and be unaware that this idealization (or devaluation) covers other contradictory feelings. Grief issues commonly involve layers of conflicted feelings surrounding the lost person, and assisting the patient to develop a "three-dimensional" picture of the lost person, including a realistic assessment of the person's good and bad characteristics, is a helpful process in the resolution of the grief.

This same process can be used for other losses as well, such as the loss of a job, a divorce, or loss of physical functioning. In such instances the patient will also need to grieve the loss, and to move toward establishing new social supports. Encouraging patients to develop a more realistic view of their loss is helpful as well.

b. Interpersonal Disputes. The first step in dealing with interpersonal disputes is to identify the stage of the conflict, and to determine whether both parties are either actively working to solve the problem, have reached an impasse, or have reached a point at which dissolution is inevitable. Successful treatment does not necessarily require that the relationship be repaired. Resolutions to the conflict may be to modify the relationship, to modify expectations about the relationship, or to exit the relationship. The important point is that the patient makes an active and informed decision about the relationship.

A primary goal of treatment is to assist patients with interpersonal disputes to modify their patterns of communication. Patients may become locked in patterns of communication with others that result in misunderstanding, or in cycles of escalating affect. The therapist can assist the patient to communicate his or her needs more clearly and productively, rather than provoking hostile responses. The therapist should model direct communication to the patient, and may engage the patient in role playing to reinforce the new communication. Although IPT is generally an individual therapy, inviting a significant other to therapy for several conjoint sessions can be an invaluable way to observe the communication *in vivo*, and to begin to help the couple to make changes in their interactions.

C. Role Transitions. Role transitions encompass a huge number of possible life changes. Included are life cycle changes such as adolescence, childbirth, and decline in physical functioning, and social transitions such as marriage, divorce, changes in job status, and retirement. Typical problems include sadness at the loss of a familiar role, as well as poor adaptation or rejection of the new role. Role transitions often result in the loss of important social supports and attachments, and may require new social skills.

The therapist should assist the patient in moving from his or her old role, which includes assisting the patient to experience grief over the loss, often using some of the techniques described for dealing with grief issues. It is crucial to help the patient to develop a realistic and “balanced” view of the old role, including both positive and negative aspects. Assisting the patient to develop new social supports is also essential.

d. Interpersonal Sensitivity. There are some patients who either because of personality traits, avoidant attachment styles, or other factors, may have problems with poor interpersonal functioning. “Interpersonal sensitivity” refers specifically to a patient’s difficulty in establishing and maintaining interpersonal relationships. Patients with interpersonal sensitivities often require a different approach than is utilized with patients who have better social skills.

Patients with interpersonal sensitivities may have few, if any, interpersonal relationships to discuss in therapy. Relationships with family members, although they may be quite disrupted, may be some of the only relationships the patient has. The therapeutic relationship may also take on greater importance, as it too may be one of the patient’s only relationships. The therapist should be prepared to give feedback to the patient regarding the way he or she communicates in therapy, and may utilize role-playing to practice skills with the patient. In addition, the therapist should assist the patient to get involved in appropriate social groups or activities in the community. Above all, the therapist and patient must keep in mind that the therapy is not designed to “correct” the social difficulties, but rather to teach the patient some skills to build new relationships, and to relieve his or her acute distress.

II. THEORETICAL BASIS

IPT is grounded in attachment theory, which as described by Bowlby among others, rests on the premise

that people have an instinctual and biological drive to attach to one another. When crises occur, individuals seek reassurance and care from those important to them. Interpersonal communication is intrinsic to this process, and individuals who cannot effectively ask for care, and consequently cannot obtain the physical and psychological care they need, will suffer as a result. When interpersonal support is insufficient or lacking during times of stress, individuals are less able to deal with crises and are more prone to develop psychiatric symptoms.

Bowlby described three different types of attachment styles that drive interpersonal behavior. Secure attachment describes individuals who are able to both give and receive care, and are relatively secure that care will be provided when it is needed. Because securely attached individuals are able to communicate their needs effectively, and because they are able to provide care for others, they typically have good social support networks. Thus they are relatively protected from developing problems when faced with stressors.

Anxious ambivalent attachment, in contrast, is a style in which individuals behave as if they are never sure that their attachment needs will be met. Because of this, such individuals believe that care must be sought constantly. Such individuals often lack the capacity to care for others, since their concern about getting their own attachment needs met outweighs all other concerns. Consequently, they have a relatively poor social support network, which in combination with their difficulties in enlisting help, leave them quite vulnerable to interpersonal stressors.

Individuals with anxious avoidant attachment typically behave as if care will not be provided by others in any circumstances. As a result, they avoid becoming close to others. The paucity of their social connections, along with their tendency to avoid asking for help during times of crises, leaves these individuals quite prone to difficulties.

In essence, attachment theory states that those individuals with less secure attachments are more likely to develop psychiatric symptoms and interpersonal problems during times of stress. A persistent belief that care must be constantly demanded from others, or that care will not be provided by others, typically leads insecurely attached individuals to have more difficulty in asking for and maintaining social support during times of crisis. Severe disruptions of important attachment relationships, such as the death of a significant other, also lead to an increased vulnerability to psychiatric symptoms.

Interpersonal psychotherapy also follows the biopsychosocial model of psychiatric illness, resting on the

premise that psychiatric and interpersonal difficulties result from a combination of interpersonal and biological factors. Individuals with a genetic predisposition are more likely to become ill when stressed interpersonally. On this foundation rests the individual's temperament, personality traits, and early life experiences, which in turn are reflected in a particular attachment style. The attachment style may be more or less adaptive, and has effects on the person's current social support network and his or her ability to enlist the support of significant others. Interpersonal functioning is determined by the severity of current stressors in the context of this social support.

Interpersonal psychotherapy is therefore designed to treat psychiatric symptoms by focusing specifically on patients' primary interpersonal relationships, particularly in the problem areas of grief, interpersonal disputes, role transitions, and interpersonal sensitivity. This is done by helping the individual to recognize and modify his or her communication patterns, which has a threefold effect. First, it leads to more effective problem solving, as conflicts can be more directly addressed. Second, it improves the patient's social support; communicating in a way to which others can more readily respond will more effectively meet the patient's attachment needs. Third, these improvements in communication and in conflictual relationships, and improved social support, help resolve the interpersonal crisis and result in symptom resolution.

III. APPLICATIONS AND EXCLUSIONS

The purpose of conducting an assessment is to determine when IPT should be used, and to whom it should be applied. The assessment may take several sessions to complete. It is only after the assessment, and the determination that the patient is suitable, that IPT should formally begin.

During the assessment, the therapist should evaluate the patient's attachment style, communication patterns, motivation, and insight. Assessment of DSM-IV diagnoses should also occur. IPT should not, however, be restricted only to patients with DSM Axis I diagnoses; it is quite suitable for patients with a variety of interpersonal problems such as work conflicts or marital issues. In fact, because patients without major psychiatric illness often have more secure attachments and better social support networks, they are usually able to utilize IPT very effectively.

Special attention should be paid to patients diagnosed with personality disorders. Those with cluster A disor-

ders including paranoid, schizoid, and schizotypal personality disorders may be unable to form effective alliances with their therapists in short-term therapy, whereas those with severe cluster B disorders such as narcissistic, histrionic, borderline, and antisocial personality disorders may require more intensive therapy than can be provided in an IPT format. However, many patients with depression or anxiety superimposed on a personality disorder may benefit a great deal from short-term therapy with IPT if the focus is on the treatment of the depression or anxiety rather than on personality change.

The assessment should include an evaluation of the patient's attachment style. This should consist of information about the patient's perception of his or her patterns of relating to others, and an evaluation of the patient's past and current relationships. Questions regarding what the patient does when stressed, ill, or otherwise in need of care are particularly helpful. The patient should also be queried about his or her typical responses when asked to assist others.

The patient's attachment style has direct implications regarding his or her ability to develop a therapeutic alliance with the therapist and the likelihood that treatment will be beneficial. Those patients with more secure attachment styles are usually able to form a more productive relationship with the therapist, and because of their relatively healthy relationships outside of therapy, are also more likely to be able to use their social support system effectively. Individuals with more anxious ambivalent attachments can usually quickly form relationships with their clinicians, but often have difficulty with the conclusion of treatment. Those with anxious avoidant attachments may have difficulty trusting the therapist. Consequently, when working with anxious avoidant patients, the therapist may need to spend the initial sessions working on developing a productive therapeutic alliance, waiting until a good alliance is established before moving into more formal IPT work.

The therapist should also use the assessment to forecast and plan for problems that may arise during therapy. For example, because patients with anxious ambivalent attachment styles often have difficulty in ending relationships, the therapist may modify his or her approach by emphasizing the time-limited nature of the treatment, and by discussing the conclusion process earlier. Significant others may also be included in sessions more frequently to ensure that therapeutic dependency does not become a problem. When working with avoidant patients, the therapist should plan to spend several sessions completing an assessment, taking great care to convey a sense of understanding and empathy to the patient.

The therapist should conduct an assessment of the patient's communication style. The way in which the patient communicates his or her needs to others has profound implications for the therapeutic process, as well as for the likelihood that the patient will improve with therapy. The therapist should directly ask the patient for examples or vignettes in which a conflict with a significant other occurred. Patients who are able to relate a coherent and detailed story are likely to be able to provide the narrative information necessary to work productively in IPT. Insight can also be judged by noting the way in which the patient describes an interaction, and the degree to which the other person's point of view is accurately represented.

In general, patients who have characteristics that render them good candidates for all of the time-limited therapies will be good candidates for IPT. These include motivation, good insight, average or better intelligence, and sufficient ego functioning. Other characteristics specific to IPT include (1) a specific interpersonal focus of distress, such as a loss or interpersonal conflict; (2) a relatively secure attachment style; (3) the ability to relate a coherent narrative; and (4) a good social support system.

IV. EMPIRICAL STUDIES

Interpersonal psychotherapy has been demonstrated to be efficacious in a number of research studies; at present, with the exception of cognitive therapy, IPT enjoys more empirical support than any other form of psychotherapy. Since the initial studies of IPT in 1979 by Klerman, Weissman, and colleagues, IPT has been demonstrated to be efficacious with a number of depressed populations, including depressed geriatric patients, depressed adolescents, depressed patients who are HIV-positive, and patients with dysthymic disorder. IPT has also been used for both postpartum and antenatal depression. In addition, it has been tested with patients in the depressed phase of bipolar disorder and with eating disorders.

Largely because of the success of the early efficacy studies, IPT, along with CBT, was chosen as a comparative psychotherapeutic treatment in the National Institute of Mental Health Treatment of Depression Collaborative Research Program (NIMH-TDCRP). Both were compared to treatment with imipramine and with placebo over 16 weeks. IPT was found to be superior to placebo, and was equal to imipramine and CBT for mild to moderate depression. Neither psychosocial treatment was as effective as imipramine for severe depression. The

consensus from the NIMH-TDCRP study is that IPT and CBT are effective for mild to moderate depression, but that antidepressant medication should remain the gold standard treatment for severe depression.

Another major study evaluating IPT involved maintenance treatment of patients with recurrent depression. Acutely depressed patients who had suffered at least three prior episodes were treated with a combination of imipramine and IPT over 16 weeks. Patients who recovered were then assigned to one of five maintenance treatments: (1) imipramine alone; (2) imipramine plus monthly IPT; (3) monthly IPT alone; (4) monthly IPT plus placebo; and (5) placebo alone. The patients were then followed for 3 years.

Mean depression-free survival time was significantly longer for those patients who received imipramine alone or imipramine plus IPT. Over 3 years, the mean time before relapse of depression was about 120 to 130 weeks for patients who received imipramine with or without IPT as an adjunct. The patients who received IPT alone or IPT plus placebo had a mean survival time of about 75 to 80 weeks. Although significantly better than the mean survival of patients who received only placebo (roughly 40 weeks), treatment with IPT alone was not as beneficial as treatment with maintenance antidepressant medication. The current consensus is that recurrent depression should be treated with maintenance antidepressant medication, with IPT a viable alternative for patients who do not want or who cannot tolerate medication.

Currently IPT is being investigated for use with social phobia and somatization disorder. The use of IPT has also been described with groups, couples, and in a family practice setting. Excellent reviews of this research can be found elsewhere.

The research on IPT clearly demonstrates its efficacy as a time-limited treatment for acute depression, and as an effective alternative to medication for patients with recurrent depression. Further, there are numerous studies that suggest that IPT may be efficacious for patients with a variety of DSM-IV Axis I disorders.

V. SUMMARY

Interpersonal psychotherapy is characterized by three essential elements: a focus on interpersonal relationships, a contract that specifies a time limit for therapy, and the use of interventions that focus on relationships outside of therapy rather than on the transference relationship. Attachment theory undergirds the approach used in IPT, and the attachment style of the patient

should instruct the therapist about the patient's suitability for treatment, prognosis, and the potential problems that may arise in therapy. Further, the patient's attachment style should inform the therapist about the ways in which the therapy can be modified.

Interpersonal problems and psychiatric symptoms are conceptualized within a biopsychosocial framework. An acute interpersonal crisis, such as a loss, interpersonal dispute, or a difficult life transition, creates problems for patients for two reasons: (1) Their interpersonal communication skills within their significant relationships are not adaptive; and (2) their social support network is not sufficient to sustain them through the interpersonal crisis. IPT proceeds by helping patients to communicate their attachment needs more effectively, to realistically assess their expectations of others, and to improve their social support. This should help resolve interpersonal problems and relieve psychiatric symptoms.

The conduct of IPT is based on a three-point foundation. First, the practice of IPT rests on empirical research. Second, the practice of IPT reflects clinical experience. Finally, and most important, the practice of IPT includes the use of clinical judgment: The therapist

must recognize the unique nature of the relationship with the unique individual with whom he or she works, and must always place the needs of the patient above a strict adherence to a manual. Given these foundational supports, IPT is an efficacious, effective, and extremely useful clinical approach to interpersonal problems.

See Also the Following Articles

Grief Therapy ■ Structural Analysis of Social Behavior ■ Sullivan's Interpersonal Psychotherapy ■ Time-Limited Dynamic Psychotherapy

Further Reading

- Bowlby, J. (1988). Developmental psychiatry comes of age. *American Journal of Psychiatry*, 145, 1–10.
- Klerman, G. L., Weissman, M. M., Rounsaville, B. J., & Chevron, E. S. (1984). *Interpersonal psychotherapy of depression*. New York: Basic Books.
- Stuart, S., & Robertson, M. (2002). *Interpersonal psychotherapy: A clinician's guide*. London: Edward Arnold Ltd.
- Weissman, M. M., Markowitz, J. W., & Klerman, G. L. (2000). *Comprehensive guide to interpersonal psychotherapy*. New York: Basic Books.

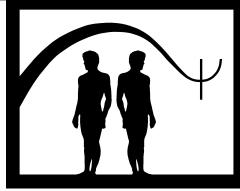

Interpretation

T. Wayne Downey

Western New England Institute for Psychoanalysis and Yale University

- I. Interpretation: A Definition
 - II. Why Interpretation?
 - III. What Gets Interpreted?
 - IV. Timing and Scope of Interpretations
- Further Reading

GLOSSARY

genetic History of the individual encompassing both biological influences, the temperamental givens in birth and development, and the prior influences of environmental nurture and stressors.

internalization Process by which the new knowledge conveyed by the interpretation becomes syncretic with the person's expanded sense of self.

interpretation Technique for reformulating the many competing and conflicting modes of thought from the multiple developmental epochs of the mind.

I. INTERPRETATION: A DEFINITION

Interpretation is a basic process in psychoanalysis and psychotherapy by which old information of the patient is translated into a new syntax of self-understanding by a therapist. It is a fundamental element of the process of psychological healing. The act of interpretation simultaneously promotes psychological repair and is the mode for bringing about psychological change in the individual. It is a technique by which one individual, the psy-

chotherapist or analyst, plumbs the unconscious mind of the analysand or patient with the purpose of bringing to light new cognitive connections, new feeling states, and new perspectives on human relationships. Interpretation involves a reformulation of the affected mind to address the defensive intellectualizations, rationalizations, and denials of fact and outer reality that have been erected by individuals to salvage and preserve their limited and compromised sense of identity and being, such as it is. Interpretation connects the latent and manifest meanings that reside in a person's psyche as they emerge in the context of a special therapeutic relationship. This relationship consists of transference of past history on the part of the patient onto his or her image of the therapist and countertransference empathic referencing of this transference on the part of the therapist. Interpretation provides a medium and context for further objectification of the individual's subjective experience, leading to an increase in capacities for insight, self-analysis, and self-interpretation. On another level these shifts in reflection are accompanied by new senses of self and identity in relation to others. When it works well interpretation brings about incrementally and occasionally dramatically a new language of self in a new key.

II. WHY INTERPRETATION?

To understand interpretation and its fundamental role in the therapeutic action in dynamic treatments,

psychotherapy, and psychoanalysis it is first necessary to review some central concepts about the growth and functioning of the mind. The brain provides the biological engine of the mind. Dysfunctions of the brain can readily translate into disorders of the mind. The mind is also capable of its own disorders apart from neurophysiology that are related to its often imperfect attempts to synthesize the conflicting types of information that it is presented with and the divergent modes by which it processes that information. For instance, one of the great paradoxes of human existence involves the presence of a sense of both mindedness and mindlessness in our psychology. The evolution of mankind's capacities for consciousness, self-awareness, and self-reflection are central aspects of what separates *homo sapiens* from other organisms. The human capacity for thought that extends beyond the immediate neural responses to stimuli for the purposes of obtaining pleasure, release, or avoiding unpleasure is present and developed in humans as in no other species. The capacity for mental activity that goes beyond the immediate and relatively fixed response to signal forms of activity adds variety to human behavior and to the possibility of thinking about things.

We have a potential and actual psychology that we share, communicate, and talk about in myriad ways. Many organisms may use signs and signals to communicate. These occur without a sense of memory and foreknowledge and the mutually reinforcing transfer of information and intellect that we both observe and infer in humans. In the realm of feelings and affective life, while flight and/or fight provides a foundation of basic organismic and affective responses, the dimension of time adds complexity, depth, and layers of feelings and shared understanding. The apprehension of a dangerous or painful future becomes the foundation for a complex of anxieties and is something that humans share. The memory of a noxious past in the form of depressive dread is part and parcel of human existence in a world of psychological infinitude that continues through and beyond time. We possess minds that meet, diverge, that are lost and found but that are nonetheless capable of thinking about a self or other selves through a unique medium that we call psychological mindedness.

The other part of the paradox of mindedness that I referred to earlier is mindlessness. Mindlessness in psychoanalytic terms represents preconscious and unconscious realms and aspects of our minds that are typically "lost" or unknown. We conceptualize the disavowed "mindless" unconscious as originating in our psychological prehistory. It emerges as part of the earliest psychological stirrings and questings of the infant-

organism. As such it contains all the contradictions and conflicts of the organism's attempt to derive a structure and function of thought from rudimentary physical and psychological experience. In Freud's original terms we come to conceptualize this first infant area of psychological strata as primary process thought. Primary process thought is an "unminded" mode of thinking about perceptions that we think are experienced by the infant and are reported by the adult as occurring in a relatively monadic context. There are few social referents in this realm. It is a way of perceiving that will eventually give way through experience, learning, socialization, and neuropsychological maturation to the dyadic mindedness and organized cognition of secondary process thought.

The toll on the developing brain of managing these divergences of mind and consciousness is that certain modes of thought and experience are relegated to unconscious mental functioning. This is the price to be extracted for resolving conflicts between one part of the mind and another. We describe this as intrapsychic conflict resolution. This mode may also be active in resolving conflict between the psyche and forces or beings in the outer world, what we refer to as interpsychic conflict resolution. Both forms may be, and often are, sequestered in the "mindless," disavowed regions of unconscious thought although each area of conflict may also have its derivatives in consciousness.

The result of such syntheses is that we split our consciousness in our waking state and to some lesser extent in our sleeping state. We must think and act as though we know what we are doing and responding to in its entirety even when, in fact, we know only a portion, sometimes only a small portion, of the picture of perception and response. If our responses become stereotypic with fixed outcomes that seem not to benefit from experience and learning, we categorize such responses as "neurotic." Neurosis is a quality of experience that is driven more by the need to appease the internal psychic economy of the individual than it is geared to benefiting from novel experiences and attaining a newer and better adaptation of inner and outer worlds. What in the optimum sense should be a part of mindedness becomes instead coopted by conflict resolution that leads to repetitive behaviors and circular modes of thought. Thus the child who has been severely abused and neglected by a parent may continue to encounter such a parent in his many relationships throughout life as though to work out through repetition the trauma of the early parental catastrophe. Such neurotic modes affirm a mindless frozen psychological state in which

what is unconscious dictates mental outcome rather than facilitating new levels of mentation and psychological organization. In the example just given that would mean having the psychological flexibility to move on to appreciate and appropriate the new opportunities for nurturing and nontraumatic mothering in later life figures or thought.

The therapist is the agent necessary to make interpretations and shed new light on dim repetitions. Such interpretations are delivered in a value-neutral manner except insofar as they carry with them an investment in the patient acquiring increasing self-perspective and making a psychological recovery. To cite another example, the power of an individual's anger may be blocked from perception and expression, or, conversely, it may be expressed in overly strong and inappropriate ways. In either case the person is unable to face the threat that anger poses. They may feel either paralyzed in the first instance or defeated by their own rage in the second. They require interpretation of what they are unaware of through the medium of a significant and trusted other to be able to link up all levels of the neurotic feeling state that has brought with it either such an overabundance or a paucity of action.

We equate "healthy" psychological development with a wholeness of consciousness; one that admits to opposites, similarities, ambiguities, and divergent lines of thought. We look for flexibility, adaptability, and the capacity to ride through life's inevitable conflicts so as to arrive at some sort of stability and interpenetration of conscious thought with unconscious fantasy that enlarges and deepens the individual's engagement with inner and outer worlds. The need for interpretation is always there, but healthy individuals are less blocked and more able to provide meaningful reformulations of everyday events. They are able to learn from their experience and the experience of others without the aid of special pleadings of special agents.

To approach the matter of interpretation from a somewhat different direction, in the ideal, because we are capable of empathy, putting oneself in the mind of another, there exists the possibility of psychological healing. The prototype for this experience is the mother's psychological work in intuiting and inferring the affective and cognitive state of her nonverbal infant and then taking the necessary steps physically or psychologically to remedy its distress. If the child was cold and wet, warmth and dryness would be the soothing response. This response would permit the infant to identify such a state, not from the affective perspective of anxiety and helplessness, but with the anticipation

and optimism that the ministrations of another are correct, timely, and will bring relief. Ultimately this would allow for the development of the capacity for self-soothing through the process of internalization. If the infant is fearful of separation from the mother or the presence of strangers, the mother's adoption of a calm stance through verbal tone, words, and actions will eventually increase the child's sense of security in the mother's availability and protectiveness. Such interpretive understanding translates into the child's taking in the mother's loving presence. If things go wrong in such situations the child will end up afraid of anxiety and distrustful of the adult's abilities to understand and remedy their fear of the strange. Over time the infant becomes more able to take in, to internalize, the mother's empathic actions. This eventuates in the ability to consciously and unconsciously soothe and care for themselves in situations of potential estrangement or physical discomfort.

This empathic paradigm is the cornerstone of psychological healing. By means of it, one participant, the therapist, listens and observes another person, the patient, in distress and infers and interprets the hidden and unconscious elements that have led them to repeatedly hit the same mental block as in their love and work lives.

In 1901 Freud originally introduced the technical lynchpin of interpretation in his classic work *The Interpretation of Dreams*. In its initial guise in his attempts to treat hysteria, interpretation involved a "Rumpelstiltskin" sort of technique in which deep understanding by the therapist was converted into memory of genetic events that were expected to magically change the patient's symptomatology. In most versions of the fairy tale "Rumpelstiltskin" if the princess whom Rumpelstiltskin has given a baby can guess his name she may keep the baby and he will vanish. In his treatment of hysterics Freud had started from the notion that as a group hysterics suffer from their reminiscences. His remedy was to go to the heart of their problems and with his profound powers of intuition wrench into consciousness the unconscious amnesic event that was causing the hysteric's symptoms. This would lead to their cure. In this early theory, by finding the "gnome" of their neurosis and labeling it would cause it to vanish.

By 1901 Freud had progressed to the point past labeling the trauma to using the interpretation of dreams as the agent of therapeutic action by which what was unconscious in the manner of unacceptable wishes and impulses was made conscious. Thus he articulated the unconsciously dominated nature of dreams and the light

that their interpretation could shed on the neuroses of everyday life and what had amounted to, heretofore, the individual's mindless domination by their unconscious. The interpretation of a person's dreams was conducted mainly in the context of their own personal meanings and metaphors. The previous historical emphasis had been on dreambook and cookbook kinds of understanding of generic dream symbolism. Inherent in such an approach was a grammar of dream symbolism that attributed meanings to symbols on an abstract basis that was divorced from the possibility that the dreamer might have developed idiosyncratic meanings of their own for the objects and dynamics encountered in their dream life. The analysis of a dream is an example par excellence of the proposition regarding healing that resides in the phenomenon of interpretation. It is the rare individual, and Freud was certainly one, who can interpret the multilayered meaning of one's own dream. To arrive at such meanings usually requires two minds and the convergence of the unconscious "mindlessness" of both parties. The exercise involved in this meeting with another mind may allow the dreamer to eventually carry on the work of dream interpretation independently, just as the exercise of analysis may set the stage for future self-analysis.

In the early era of id psychology, interpretation enjoyed a decade's reign during which it was considered "the royal road to the unconscious" and thus the avenue of therapeutic cure. As the subsequent development of analysis has borne out, innovations expand the range of treatment but they also reveal the shortcomings of the current dominant technique and point toward areas in need of further theoretical clarification. This heyday established the subsequent niche of dream interpretation in analytic technique but it also uncovered its shortcomings. Practitioners began to realize that id psychology with its emphasis on the understanding of forbidden wishes and desires located in the deep unconscious could only bring the treatment dyad so far. There were obvious limitations to its general treatment effectiveness. Other factors of therapeutic significance emerged that came to be categorized in terms of self and object relations. In order to promote the further understanding of symptom and character it became necessary to subject the person's internalized images of others as well as their actual social relations to interpretive attention. Although the initial premise still holds that the work of interpretation is to uncover hidden meanings and occult connections, the potential residence of such meanings took on more global consideration in personality functioning. Areas may be encountered in object relations, ego psychology, and in relation to the defensive activi-

ties of the ego, not to mention in relation to the meanings that reside in the unconscious conscience, that are subject to first the therapist's and then the therapist and patient's interpretive scrutiny.

III. WHAT GETS INTERPRETED?

There are now considered to be many dimensions to interpretation. It can be seen as a process that may extend through many aspects of space and time. Freud initially emphasized the temporal and historical aspects of interpretation. The earliest form of interpretation tended to have a genetic emphasis. That is, the ideal interpretation attempted to link up the individual's current difficulties functioning and the many "mindless" factors throughout life that had contributed to the difficulties and were being actively expressed through them. This approach aimed at positing as the nidus for a symptom an event that was either unconscious or not clearly conscious in its recall. "Your arm became paralyzed because you were in conflict about using it to strike your father" would be one such example. If presented in the proper emotional setting, this would expose the noxious forbidden element of trauma. It is brought into consciousness in a more fully and clearly focused manner that allows the individual a better view of the regressed elements of his or her history that his or her mind had hitherto deemed too painful or too awful to acknowledge. This is a technical point that has been emphasized many times by Loewald in his modern reformulation of psychoanalysis.

In an overall sense psychoanalysis is an ally of memory. This is the case to the extent that one of the goals of psychic exploration is to provide the individual with a fuller sense of the historical truth of his or her life as it courses back and forth through memory and time. Ernst Kris conceptualized the therapeutic process as an activity in which the personal myth of the individual is gradually replaced with a sense of conviction about the affective and experiential elements of a life that is both more compelling and more coherent than the one that had been woven into the fabric of their neurosis. Paradoxically adolescence, a period that often holds vivid memories, is also one in which the pressure of interpretation will yield a significantly altered story line through the reconstructions that inevitably accompany a dynamically founded treatment. A not uncommon statement might be "we can now understand your sense of dominance and distance with females during your teenage years as an outgrowth of several early stinging

rejections by girls that became coupled with your own deep anxieties about sexual and emotional intimacy. This seems quite consonant with the manner in which you have kept me (your therapist) at a distance. It has also manifested itself in the conflicts of intimacy that you have attempted to defend yourself against by seeing me as sexually threatening and at the same time emotionally withdrawn.” The interpretation presented here *en bloc* would in all likelihood be parceled out over time, eventuating in this summary interpretation. Such ideas when introduced in a timely fashion with a tactful tone of voice should lead over time to a gradual acceptance, acknowledgment, and further elaboration of the interpretive premise. This may lead over time to an equanimity that comes from possessing a sense of an apt and resonant relation to both inner and outer realities. It may be even more enhancing in introducing a larger acceptance of the objective and subjective mix of fantasy and fact that constitutes such “realities.” Human experience being what it is, a state of relative equanimity is just that, and although neurotic difficulties may have been fixed, the mind is never fixated in any healthy state. We will always struggle to process our experience in a manner that updates our realities at the expense of our personal myths.

The upshot of any interpretation may be quite varied. The patient may respond with immediate recognition, what Ralph Greenson termed the “aha” phenomenon. Alternatively the reaction may be vague resistance, either in response to the sense of criticism that every interpretation inevitably conveys, or as a function of the partial nature of the interpretation. On the therapist’s side of the treatment process or the couch, the reaction may be “oi vay!” The therapist, with or without reaction from his patient, immediately registers the vast error in his interpretation. When errors of interpretation occur, necessarily unavoidable but hopefully rarely, they require acknowledgment on the part of the analyst. Perhaps this would mean an apology, depending on the circumstances and the content of the errant ideas. Following this there should be a moving on to more fully understand how the patient interpreted the misunderstanding on the part of the therapist. For some patients it is the therapist’s grace in responding to an incorrect interpretation rather than his or her acumen that saves the day. In addition there is currently developing an added appreciation that such spontaneous moments may reference memory and events that are beyond the usual realm of interpretation in declarative memory. They may bring in elements from the “noninterpretive” realm of nondeclarative memory for attention and objectification.

In addition to the dimension of time there is a metaphorical dimension by which interpretations extend through the layers of mind and consciousness, from surface to depth. In addition to placing the spotlight of interpretation on elements involving group and interpsychic dynamics of social relations and control, the operations of the ego per se need at times to be an object of attention. It is not only the conflicts that the ego works to control but also the workings of the ego as an organ of synthesis and adaptation and as a partner or hostage of conscience that needs to be taken into consideration.

In a stepwise fashion a series of interpretations may lead to a complex revision of the patient’s sense of world and self. New and novel choices begin to appear in the mind’s eye. Fresh ideas presented in the proper sequence can lead to paranoia evaporating over time, to be replaced by a less anxious, more confident, and less reactive sense of self. “Originally your independence in childhood served you well, given the discontinuities in care that you experienced with your mother and your need to put some space between the two of you. You sensed at several levels of awareness that she could not accept you for who you were. This left you with confusions about dependency and now in your work and in your love life this cloak of alienated independence that you cover yourself with serves to keep you apart from others and unfulfilled in terms of your self-esteem. You end up not safe, as you intended, but anxious and never fully relaxed or satisfied. Yes, your escape is swallowed up by anyone and anything but also you are never able to fully be yourself with another.” Such a revisionist approach spans areas of history, defense, self-configuration, and neurotic adaptation while pointing the way toward a potentially less defended and restricted person with a more fulsome nature. Such interpretive syntheses may only be possible toward the end of an analysis when there is a fairly firm sense that all the facts are in and available for tally.

As the previous examples have indicated most interpretations follow from the content of the patient’s thoughts, the subject matter of their consciousness. There are exceptions in which the process of associating becomes coopted by predominantly defensive dynamics. We are then confronted with the paradoxical situation that speaking one’s mind serves mainly to cloud and obscure one’s more cogent thoughts and feelings. This defensive maneuver was initially identified in relation to dreams where the telling of the dream became so elaborated and extended that there was no time or opportunity for its deeper examination and interpretation. The supposedly cooperative and compliant dreamer pro-

duced too much of a good thing and in the process defeated the central purpose of dream analysis. This profusion of information without the opportunity for comment or interpretive scrutiny may occur in the course of any string of associations. At those instances the content of the patient's communication becomes less interesting than the quality and the process of the associations as they exhibit more of the quality of an action. When a torrent of words drowns out the facts contained in the stream of associations, a comment acknowledging the diversion of words from meaning is indicated. "The pressure and volume of your words and speech, while seeming to communicate a great deal, actually confuses me and makes it more difficult to understand what is going on in you. I wonder if there is some anxiety behind your words that we need to examine?" This might be one among many possible comments that the therapist could make in such a situation.

A current associational emphasis that is popular among some therapists is that of "close process monitoring." This technique expands the usual emphasis in any treatment, the ebb and flow of verbal material toward or away from areas of conflict and concern. The defensive nature, particularly with regard to matters of aggression, is given a predominant focus. Comments and questions leading up to interpretive statements are restricted to here and now observations that call patients' attention to shifts in their train of thought away from more affectively loaded material. This often involves bringing to light hostile and aggressive thoughts and feelings about the analyst that the patient is consciously suppressing and unconsciously censoring.

IV. TIMING AND SCOPE OF INTERPRETATIONS

The timing and scope of an interpretation has everything to do with how successful or effective an interpretation is. It is also critical if the therapist's activity at a particular point is gauged toward building to a broader interpretation. Some treatments may hinge upon the proper and timely application of a very limited number of interpretive comments. Selecting the right moment when idea, emotion, and resistance is at a proper pitch is key. The therapist's ease in understanding and delivering a properly timed formulation is also a significant factor in its successful reception by the patient. Much of an interpretation's effectiveness is contingent on how much data, both affective and cognitive, the therapist has at his or her disposal. This may

be a factor in setting apart analysis from most psychotherapies. In an analysis, with its greater frequency and often intensity of meetings, we anticipate that there will be less use of guesswork and intuition and a more refined processing of the unconscious into conscious thought. Therapists of different professional persuasions and different temperaments will vary widely in how much they rely on empathy and intuition in their interpretive activity. In Kleinian analyses and in briefer forms of psychotherapy the therapist may rely more heavily on "deep" intuition-rich verbal interventions to shortcut the defensive activities of the ego and get right to the heart of the matter. This is more in accordance with the technique of the early days of id analysis as opposed to current fashion that draws more on a constant assessment of object relations and the quality of the ego's defensive activity to determine how to proceed in a stepwise manner toward id interpretation.

Some versions of interpretation are met with immediate approval or disapproval. Depending on the quality of the therapeutic alliance, positive or negative, collaborative or combative, the degree to which an interpretation will be accepted for further internalization may be immediately apparent. At other times the impact of an interpretation is apparent only over time in the context of the further elaboration and working through of associations and defenses. This may be particularly the case when working with children, whose response to interpretations may appear minutes, hours, or days later. Children's responses may also show up in their play in apparent wide displacement from the therapist's words.

Central to determining what is healthy collaboration and what is neurotic compliance is the degree to which interpretations open up new avenues of information for inquiry and exploration. A premature interpretation may be greeted by a range of responses: incredulity at the therapist's cognitive lapse, confusion and self-blame, or the therapist may find himself the target of a withering attack of invectives and humiliation. Of course, it is impossible to assess the impact on the patient of tactfully delivered words until they are spoken. If the patient's reaction needs to be redressed with regard to the transference or countertransference elements elicited by an interpretive comment, that will require time and an open mind by both parties. Some patients are well-versed in contemporary or past therapeutic techniques and apply them easily and at will. They are also often too smart by half, bending their energies to making interpretive points before the therapist does. The quantity of clarifying comments is also important. Too many interpretations may cause them to fall on deaf ears. At

other points such comments will only be received according to the criticism that is inherent in them. If that is the case the interpretive activity either has no effect or it has a negative countertherapeutic impact. Traumatically sensitized patients are more prone to experience the therapist's words almost literally as being struck by a cudgel or raped. These concrete, physically referenced reactions can be taken up as defensive reactions of one sort or another.

A tilted relationship is one aspect of any therapy in which a psychological "expert" is helping a psychologically in need "patient." There is always the risk and danger that the interpretations will be perceived as a manifestation of the analyst's legitimate or illegitimate authority. Likewise they may be taken as evidence by the patient of the therapist's investment in the power politics of the situation. If that happens, boredom and impatience on the part of either member of the therapeutic dyad may come to supplant the fervor of self-other exploration. If the patient is mainly reacting to suggestion and is in the process of succumbing to the analyst's need to be the authority, the treatment process will come to feel more and more predictable, stereotyped, and static. If there are narcissistic issues on the part of the analyst or analysand that are not accessible to insight and clarification then stalemate, breakdown, or a compromised therapeutic process is inevitable. In these occasional situations unanalyzed rage in the patient or therapist may lead to stultification or truncation of the treatment.

The scope of interpretations has become much more varied and vast as the varied and vast capacities of the human mind have become more accessible to understanding. It ranges from interpretations of content, process, and defense to the sorts of overarching historical and genetic interpretations on which this aspect of technique was founded. In the case of defense analysis, attention is drawn to largely unconscious mechanisms that restrain the patient in speaking his or her mind. These may be in place to avoid coming across to the therapist as too active, too passive, too involved or needy, or too affect ridden, to mention a few of the conditions of defense. Interpretation of the mythic history of the individual may possess a particular power if used sparingly and precisely, identifying and appreciating the compulsive and repetitive aspects of historical experience without taking up camp in the past at the expense of existential frame in the here and now. Care should be taken not to develop a historical mantra that becomes yet another version of the personal myth or that distracts or displaces in an exaggerated and unwar-

ranted fashion from pressing dynamic issues in current-day experience.

There is as yet no agreed on objective standard for interpretation in the field. We are left with an activity that is still more art than science. The crucial element in interpreting is that it should always contain a question mark and rarely an exclamation point. It should indicate both what the analyst knows or thinks he or she may know as well as extending an invitation to the patient to provide further data from all levels of the mind to extend the interpretive moment to a clearer conclusion. As is continually emphasized, the overall treatment alliance is an essential part of therapeutic efficacy. In some instances the process of collaboration is as much or more important than the self-knowledge that emerges from it. At times it is not what is said that is most pertinent. At its core, self knowledge, including the growing ability to auto-interpret, should cause the distinction between what the therapist perceives and anticipates of the patient and what the patient's understanding of themselves is, to be subject to more and more overlap. The other's understanding of one's self should become ever more one's self-awareness and self-acceptance.

At the point in a treatment where there are no new issues left to interpret and explore there should be an emerging sense of completion and wholeness to complement the feeling that what has been available for resolution and reformulation has, by and large, been apprehended. To put it another way, in the ideal therapy, a time of mourning, celebration, and parting emerges that signifies that a maximum (for the moment) of self-understanding and self-acceptance has been achieved. It is not the completion of a life's story but rather the end of a chapter in the life of an individual when the need for another to understand one's self has reached a developmental conclusion. This is much as the need for a child to have understanding and defining parents wanes with the ending of adolescence. The self-understanding that comes from interpretation has been internalized and "knowing thyself" in the universal (and idealized) dimensions of love and work has been optimized. For many this will include knowing that at some future time they may come again to be beyond their psychological depth. In addition to having a better sense of when they have reached the limits of self-help, they will be able to interpret their own need to once again rely on the help and interpretive powers of a therapist. Ultimately an open mind with better access to, and reciprocity with, conscious and unconscious mindedness should be the endpoint of interpretation.

See Also the Following Articles

Applied Behavior Analysis ■ Behavioral Assessment ■ Behavioral Case Formulation ■ Countertransference ■ Functional Analysis of Behavior ■ Psychoanalysis and Psychoanalytic Psychotherapy: Technique ■ Transference

Further Reading

Busch, E. (2000). What is a deep interpretation? *Journal of the American Psychoanalytical Association*, 48, 237–254.

Davis, J. (2001). Revising psychoanalytic interpretations of the past: An examination of declarative and non-declarative memory processes. *International Journal of Psychoanalysis*, 82, 449–462.

Freud, S. (1901). *The interpretation of dreams*, Standard Edition, V. IV. London: The Hogarth Press.

Greenson, R. (1967). *The technique and practice of psychoanalysis*. New York: International Universities Press.

Kris, E. (1975). *Selected papers*. New Haven, CT: Yale University Press.

Loewald, H. (2000). *The essential Loewald*. Hagerstown, MD: University Publishing Group.



Intrapsychic Conflict

Alan Sugarman

San Diego Psychoanalytic Society and Institute and
University of California, San Diego

- I. Affect—Trauma Model
 - II. Topographic Stage
 - III. Transference
 - IV. Dream Analysis
 - V. Structural Theory
 - VI. Technical Implications
- Further Reading

GLOSSARY

abreaction A cathartic release of pent-up affect usually associated with trauma.

ensor Synonymous with the term of repressive barrier anthropomorphosized in order to dramatically make the point of the fact of repression.

compromise formation The synthesis created by conflicting mental components.

defense The counterforce opposing the expression and emergence into consciousness of socially unacceptable or otherwise problematic biological and somatic urges.

instinctual drives Mental/somatic entities which are the mental representation of somatic stimuli.

intrapsychic conflict The basic psychoanalytic idea that almost all mental phenomenon and psychologically mediated behavior are the product of opposing mental forces or structures.

latent content An aspect of the dream that deals with underlying or repressed thoughts stimulated by the day's activity and seeking expression.

libidinal drive The tendency of the psychological structure seeking the satiation of biological needs, as well as psychological needs, for affiliation and merger.

manifest content Refers to the aspect of dreams that are expressed clearly and directly within the dream.

multiple functions The almost universal tendency of certain defenses to serve multiple functions at the time of their use.

primary process A mode of thinking in which logical and formal relations between mental contents are absent and there is a press for immediate gratification of pleasurable needs. Contraindications exist without difficulty. Temporal considerations are irrelevant.

psychic energy An imprecise term referring to the economic work or resource required on the part of the individual to accomplish a certain act or invest a psychological structure with capacity.

reality principle The tendency for an organism to orient itself to practical social dictates and requirements.

repression A form of defense in which unacceptable urges and materials are kept outside the realm of consciousness.

repression barrier The psychological structure that separates the contents of the system unconscious from the preconscious system by a defense and the function of the censor.

resistance A form of defense specifically oriented towards keeping certain thoughts and ideas out of the talk between analysis and analysis.

secondary process functioning Refers to a mode of functioning in which logic, temporal relationships, and social and physical reality predominate as principles.

sexual drives Refers to drives emanating from specific bodily areas and following a development timetable, which have a pressure, an aim, an object, and a source.

structural model The psychoanalytic model developed by Freud that hypothesized the existence of three basic psychological structures that embody and mediate between

the demands of external social reality and internal, biologically based, instinctual needs.

structures Psychological constructs of drive, representation, motivation, and function that exist to carry out psychological work and integrate various domains of mental functioning.

superego The agency within the structure model that is responsible for determining ideal social reality and measuring various aspects of the individual's function in relationship to this reality.

system conscious (CS) A set of structures oriented towards conscious and explicit experience.

system preconscious (PCS) Refers to the existence of psychological material that can be made conscious and has not attracted enough repression to render it incapable of being known consciously.

system unconscious (UCS) Refers to the psychological and biological structures that press for expression and satiation and are not capable of consciousness.

topographical model The model of the mind developed by Freud that postulates the existence of conscious and unconscious mental processes separated by repressive barrier.

transference The tendency for all people to "transfer" feelings, attitudes, and relationships more appropriate to a specific person in the past of the individual to some other analogous, present, and active social relationship.

The concept of intrapsychic conflict, also called internal conflict, psychic conflict, or neurotic conflict, is central both to the psychoanalytic theory of mind and the application of that theory to differential treatment strategies. This concept refers to the basic psychoanalytic thesis that almost all mental phenomena and psychologically mediated behavior are the result of opposing mental forces or structures. Thus, symptoms, personality structure, fantasies, emotions, and so on reflect the synthesis of more basic mental components. This synthesis of these conflicting mental components is referred to as a compromise formation. Psychoanalysts assume that virtually all complex mental acts are compromise formations designed to allow the maximum possible gratification of the conflicting components with the least possible mental pain. Intrapsychic conflict and its subsequent compromise formations are ubiquitous and not inherently pathological. Rather they are understood as essential aspects of the human condition. Thus, psychoanalysis has traditionally been viewed as a psychology of intrapsychic conflict. Conflict and compromise formations are pathological only when they lead to excessive inhibition of key human urges, when they give rise to excessive anxiety and/or depression, when they cause excessive inhibition of important psychological functions, when they lead to ex-

cessive self-destructiveness, or when they bring the individual into excessive conflict with his or her environment. Mental health occurs along a continuum in terms of intrapsychic conflict. Conflict and compromise formation move from the healthy to the unhealthy parts of the continuum as they interfere in one's life in the previously listed ways.

I. AFFECT—TRAUMA MODEL

Psychoanalysis' theory of mental functioning, and the technical implications drawn from it, has evolved over the past 100 years. Each phase in that evolution has defined the conflicting elements of the mind differently and derived different technical precepts from those definitions. Freud's first stage of thinking occurred between the mid-1880s and 1897. The psychological model that he developed during those years is commonly referred to as the affect-trauma model. While trying to understand the etiology and treatment of neurotic symptoms, Freud emphasized the role of environmental trauma and subsequently pent-up charges of affect. Essentially Freud said that neurotic symptoms derived from internal conflict between the individual's conscious moral standards and distressing affects or ideas that were incompatible with these precepts. In general, trauma, usually of a sexual nature, was understood to overstimulate the individual to a degree that an intense charge of affective energy developed. This affective charge was defended from consciousness to avoid the unpleasant feelings generated by it running counter to conscious moral standards. Damming up of affect occurred and became expressed in disguised ways through neurotic symptoms. Oftentimes symptoms would develop years later when a current event stimulated memory traces of early events that had not been experienced consciously as fully traumatic at the time they occurred. In these situations a conflict was postulated to arise between what was repressed as a child and the adult's current moral standards. During this earliest stage of psychoanalytic theorizing, the strategy of treatment revolved around helping the patient to remember the traumatic event and to cathartically release the pent-up affect associated with it. Freud called this cathartic release *abreaction*. In this way the pathological impact of intrapsychic conflict was thought to be overcome.

II. TOPOGRAPHIC STAGE

By 1897, however, Freud was finding this understanding of psychic conflict unsatisfactory and the

treatment results from it disappointing. Thus, his topographic stage of theorizing was developed over the next 26 years as his understanding of intrapsychic conflict underwent radical revision. Perhaps most importantly, several events, including Freud's own self-analysis, led him to shift his focus away from memories of actual childhood sexual traumas and their related affects as a significant component of intrapsychic conflict. Instead Freud came to the conclusion that most of his patients' memories of childhood sexual seductions were, in fact, disguised unconscious wishes. These wishes had to be disavowed because they conflicted with other components of the mind, resulting in a false belief that an actual sexual trauma had occurred during childhood. The recent furor over the false-memory syndrome speaks to how slow nonanalysts have been to realize the intensity and ubiquitousness of childhood sexual wishes and the defenses against them.

During this second phase in the development of his thinking, Freud defined and elaborated his concept of libidinal drive as a key component of intrapsychic conflict. He introduced the concept of instinctual drive as a mental-somatic construct, defining it as a mental representation of somatic stimuli. The sexual drives had a pressure, an aim, an object, and a source. The source referred to a part of the body imbued with sexual energy, following a developmental timetable. These sources became synonymous with the stage of development at which they were primary—hence, the oral, anal, phallic, and genital stages of development. Inherent in this idea of a sexual drive following a developmental timetable was Freud's notion of libido or psychic energy. That is, this energy was postulated to arise in the somatic sources of the sexual drive and to provide the impetus for the mind to work. Freud maintained his belief in the importance of the sexual drive and its underlying energy, even when he ultimately rejected the topographic model in 1923.

Freud's topographic stage of thinking involved far more than the realization that childhood sexual wishes and fantasies exerted a profound impact on mental functioning into and through adulthood, however. That is, he had to explain the reason that patients experienced and reported such wishes as memories of actual occurrences. Furthermore, he needed to explain why such memories (in reality, fantasies) emerged only during treatment. These issues required the introduction of a counter force to becoming aware of such wishes or fantasies—that is, defense. During this stage in his model building, Freud used the term “repression” synonymously with defense. Repression did not refer to any particular type of defense mechanism but to the

gamut of ways in which the mind could render a wish, thought, fantasy, or memory unconscious. It represented the work of the ego or self-preservative instincts that had as their aim the preservation of the individual.

Freud's topographic model did far more than redefine the conflicting elements of the mind. It also attempted to chart out the organization of the mind and to map the main components through which internal conflict was actualized. Thus, three systems or layers of the mind were described: (1) the system Unconscious (UCS); (2) the system Preconscious (PCS); and (3) the system Conscious (CS). These three systems were structures, each with its own type of mental contents, and each characterized by qualitatively different modes of functioning. Essentially these structures or stratas of the mind were viewed as the mind's attempt to harness the instinctual drives so that the individual could adapt to reality. Were the instinctual drives and wishes to succeed in their push for conscious awareness and discharge, the individual would experience unpleasant feelings as well as potential danger. During this era of Freud's thinking all sorts of mental phenomena including jokes, slips of the tongue, dreams, as well as neurotic symptoms were understood to involve a conflict between instinctual wishes and the mind's counter forces occurring within and between these mental strata.

The UCS was viewed as the deepest strata of the mind and the repository of instinctual drives and wishes, always pushing for conscious expression. This system is characterized by a very primitive mode of functioning or thinking that Freud called the primary process. In this mode of functioning, logical and formal relations between mental contents are absent. Contradictions exist without difficulty, temporal considerations are irrelevant, and so on. What Freud called the pleasure principle dominates. Drives and wishes push for discharge, gratification, and relief of tension without consideration for anything but pleasure. It is important to distinguish this system UCS from the descriptive term unconscious. Contents of the system UCS are kept unconscious through a repression barrier; that is, active amounts of psychic energy are used to keep the contents dynamically unconscious. In contrast, descriptively unconscious mental contents might be outside of conscious awareness only because attention is not directed at them. Were attention to be focused on them, they would become conscious. No defensive force is exerted against this possible occurrence.

This distinction becomes relevant when defining the system PCS. The contents of this system are also unconscious but only descriptively so. They are capable of becoming conscious once attention is focused on them.

Thus, Freud initially located the active censor or repressive barrier that kept dynamically unconscious content out of consciousness at the boundary between the system UCS and PCS. Intrapsychic conflict occurred first at this juncture. This barrier allowed the system PCS to function according to what he called the secondary process in which logical reason and moral concerns characterize the relationship between its mental contents. The reality principle predominates so that any discharge of instinctual drives or wishes has to be filtered, altered, and/or disguised to make it compatible to reality logic and the individual's moral standards. Freud eventually explained that the system PCS modified drive impulses at all levels on their way through the system to the system CS. Thus, repression or defense no longer became conceptualized as a static barrier occurring between the systems UCS and PCS. Instead unconscious wishes are continually transformed during their traversal of the system PCS and had to pass by a second censor at the boundary between the systems PCS and CS. Intrapsychic conflict could occur at any step along the way. To pass muster and get past the censor unconscious drive laden wishes have to be disguised—what psychoanalysts labeled drive derivatives. Only such derivatives can be allowed into the system CS to be discharged.

The system CS was described by Freud as on the mind's surface. All its mental contents are conscious, although only a limited range of contents can be attended to at any moment. Perception occurs in this system as does attention. Thus, the system CS receives input from both the deeper recesses of the mind as well as from the external environment. To become aware either of mental contents from inside or perceptual stimuli from without, the system CS has to invest what was called attention cathexis, that is, to invest content or stimuli with psychic energy that has become neutralized of its sexual and/or aggressive drive qualities. As with the system PCS, the contents of the system CS follow the reality principle and are characterized by secondary process functioning.

This stage of Freud's thinking in which internal conflict was viewed as occurring between the instinctual drives of the system UCS and the censorship and defenses of the system PCS continues to be important because all of Freud's papers on clinical technique were written during this era. For example, he formulated the important clinical concept of transference during this era and emphasized the importance of analyzing dreams. Dream analysis became synonymous with psychoanalytic technique during this stage as Freud de-

scribed dreams to be the royal road to the Unconscious. Vestiges of this theoretical understanding of internal conflict continue to appear in modern day clinical literature because Freud never reformulated his theory of technique when he gave up this model in 1923. This failure to recast his theory of technique has impeded the development of modern-day thinking about technical matters as many analysts and nonanalysts alike seem to operate therapeutically out of an outdated understanding of mental functioning and conflict.

For example, the clinical dictum that psychoanalytic technique should aim to raise unconscious mental content to consciousness is still regarded by many as the means by which psychoanalysis cures despite it being overly simplistic and at odds with how most contemporary psychoanalysts understand the mind to work. But during the topographic era, Freud believed that one only had to make the patient aware of his or her unconscious sexual and, later, aggressive wishes derived from childhood in order to overcome the symptoms and/or character traits for which treatment was being sought. Resistance to analytic treatment at this stage was thought to reflect solely the operation of the defense mechanisms in the clinical encounter. That is, resistance was the patient's defensive attempt to protect against the analyst's attempts to make the analyst aware of unconscious wishes. Resistance analysis meant that one had to overcome the resistance so as to allow the patient to gain access to the recesses of the Unconscious. This formulation led to didactic if not coercive practices such as telling the patient that he or she was in a state of resistance with the implicit, if not explicit, idea that he or she should stop doing so. Such an approach has led many nonanalysts as well as analysts of more modern schools to criticize classical analysis as coercive and controlling.

III. TRANSFERENCE

In this theoretical vein, Freud introduced the concept of transference as a clinical phenomenon arising within the analytic situation. Originally Freud viewed transference as the displacement of unconscious wishes and fantasies about past individuals in the patient's life onto the person of the analyst. He first viewed such transference as an obstacle to making the unconscious conscious, but later came to view it as an ally in the work. That is, transference allowed the analyst to see the unconscious wishes, feelings, thoughts, and so on, and to bring them to the patient's conscious awareness.

But during this stage of thinking, too often, the emphasis was placed on demonstrating to the patient the unconscious wishes or fantasies about historical objects rather than on understanding the reasons that such contents had to be disguised or on the analyst's actual contributions to the patient's transference perceptions.

IV. DREAM ANALYSIS

Dream analysis also took priority during this era of psychoanalytic theorizing. Given the dream's latent content about unconscious wishes, the analysis of dreams took high priority in guiding the analyst's decisions about where to intervene. The prevailing theory of analytic cure, making what was unconscious conscious, led the analyst to interpret the unconscious or latent content of the dream to the patient. In particular, this approach to dream analysis focused on remembering or reconstructing the experiences and fantasies of childhood. At the same time, the defensive use of dreams to avoid other less comfortable mental contents received short shrift. So did the attempt to understand why a childhood drive-laden experience or fantasy had to be expressed through dreaming rather than remembered and experienced more directly. Such distinctions about whether to give dream analysis particular priority in determining analytic interventions or whether to regard the dream as just one of many types of mental content that can serve multiple purposes continues to be debated in the literature and serves, in part, to distinguish those analysts who continue to practice from a primarily topographic perspective from those who have integrated Freud's structural model and more recent advances in psychoanalytic thinking into their theory of technique.

V. STRUCTURAL THEORY

By 1923, Freud felt obliged to change his model again, first through his important book, *The Ego and the Id*, and then with *Inhibitions, Symptoms, and Anxiety*, published in 1926. These two volumes are considered to define the structural theory of psychoanalysis, a model which once again shifted the conceptualization of intrapsychic conflict. Essentially, theoretical inconsistencies in the topographic model along with the problem of how to formulate the newfound clinical phenomenon of unconscious guilt led Freud to revise his understanding about what sort of conflicts gave rise

to mental phenomena. The terms conscious, preconscious, and unconscious remained in psychoanalytic theory but only as adjectives describing the nature of mental contents or processes. They no longer referred to strata or organizations of the mind.

Instead an explicitly tripartite model with the mind composed of three separate structures—id, ego, and superego—was described. The use of the term structure is a metaphor that refers to enduring patterns and configurations of mental processes that show a slow rate of change. That is, they are theoretical abstractions that have proven valuable clinically and can be inferred from behavior or mental content. The id is the structure that most closely approximates Freud's early concept of the system Unconscious. It involves mental representations of the twin instinctual drives of libido and aggression, operates according to the pleasure principle, and is organized according to the rules of the primary process. Freud conceived of the ego as developing out of and retaining roots in the id while the later ego psychologists such as Heinz Hartmann described the id and ego as differentiating out of an originally undifferentiated matrix. Regardless of its origins the ego is described as the mental structure that balances and mediates the pressure of the id drives and superego and integrates them with the need to adapt to the demands or pressures of the external world. As such it operates toward the goal of preservation of the individual. Thus, it involves multiple functions, the most important of which, in regard to intrapsychic conflict, is defensive functioning. At times it helps the id to gratify its drive impulses and, at other times, it exerts defense against them in order to adapt to the external world. Intrapsychic conflict occurs at such times. Because successful defenses must always allow some drive discharge, the ego facilitates the development of compromise formations.

The third structure, the superego, was added by Freud to help explain unconscious guilt. It is the internalized representation of parental values and prohibitions—in essence a conscience as well as an ego ideal. Conflict among these structures—structural conflict—was seen by Freud as the genesis of all subsequent mental phenomena. In this model, still used by many if not most American psychoanalysts, the genesis of symptoms or character traits is as follows. An id wish or impulse runs into conflict with an internal or external prohibition, which threatens the ego with a variety of unpleasurable situations causing signal anxiety or depression. This signal affect stimulates defensive functioning, which leads the ego to find a compromise formation that allows for some id gratification while also

preventing the impulse from becoming manifestly conscious; the compromise formation also assuages the prohibitions of the superego. Symptoms and character traits are examples of such compromise formations as are other mental phenomena. Besides the intersystemic conflicts that can develop between these structures, intrasystemic conflicts also occur. These conflicts involve clashes between mental contents of the same structure, for example, between incompatible ideals in the superego or between opposing drive wishes in the id.

VI. TECHNICAL IMPLICATIONS

Only in the past 20 years have psychoanalysts begun to systematically revise their theory of technique to implement the implications of this new understanding of mental functioning and intrapsychic conflict. Expanding the ego's unconscious awareness of intrapsychic conflict has become the focus of clinical technique based on the assumption that such ego expansion will bring mastery. No longer are resistances viewed as obstacles to making the unconscious conscious. Instead the importance of understanding the reasons for resistance is emphasized as is an awareness that the occurrence of resistance can be used as an opportunity to teach the patient how to observe the manifestations of unconscious conflict as they occur in his or her free associations.

Increasingly the importance of addressing the conscious ego and intervening at the surface in a way that the patient's ego can grasp and observe is seen as more important than deep interpretations of id content. Psychoanalysts now assume that unconscious id content will emerge into consciousness under its own impetus as the anxieties and threats that motivate the ego to

defend against them are understood. Self-analysis—the ability to continue to observe and analyze such resistances to full consciousness—is now a goal of technique and a definition of a successful analysis, as we accept that intrapsychic conflict never disappears. Instead psychoanalysis aims to increase ego mastery over such conflicts with the assumption that conscious awareness and understanding of such conflicts will lead to compromise formations that are more adaptive and less restrictive. Thus, contemporary structural theory promulgates an approach to analytic technique that studies all facets of intrapsychic conflict rather than giving therapeutic priority to one of them. As such it can be viewed as a comprehensive approach to analysis.

See Also the Following Articles

Oedipus Complex ■ Resistance ■ Structural Theory ■
Topographic Theory ■ Transference Neurosis ■
Unconscious, The

Further Reading

- Brenner, C. (1982). *The mind in conflict*. New York: International Universities Press.
- Dowling, S. (1991). *Conflict and compromise: Therapeutic implications*. Madison, CT: International Universities Press.
- Nagera, H. (1966). *Early childhood disturbances, the infantile neurosis and the adult disturbances*. New York: International Universities Press.
- Sandler, J., Holder, A., Dare, C., & Dreher, A. U. (1997). *Freud's models of the mind. An introduction*. Madison, CT: International Universities Press.
- Sugarman, A. (1995). Psychoanalysis: Treatment of conflict or deficit. *Psychoanalytic Psychology*, 12, 55–70.



Job Club Method

Nathan H. Azrin

Nova Southeastern University

- I. Theoretical Basis
- II. Empirical Studies
- III. Description
- IV. Summary
- Further Reading

GLOSSARY

job-finding Viewed as a chain of responses from the initial step of identifying a job lead, each of the steps being taught and supervised in the Job Club session, rehearsed, and actually put into practice under the supervision of the Job Club instructor.

I. THEORETICAL BASIS

The Job Club method is based on established principles of learning similar to those used in behavior therapy and by applied behavior analysis for treating psychological problems. The process of job-finding is viewed as a chain of responses from the initial step of identifying a possible job lead, each of the steps being taught and supervised in the Job Club session, rehearsed, and actually put into practice under the supervision of the Job Club instructor. Also included are modeling (imitation), self-recording of each of the job-seeking behaviors, progress charting, and “homework” assignments for out-of-session behaviors. The same rationale governs the conduct of the Job Club instructor

analogous to that of the therapist in behavior therapy; specifically, the Job Club instructor constantly reinforces the job seeker using descriptive praise that designates the specific behavior being praised. The instructor is always positive, praises any action in the direction of the final goal of obtaining a job, never criticizes, and directs attention to future constructive actions rather than past difficulties.

The program takes place in a group for reasons of cost/benefit but also to obtain group support including finding job leads for each other, transportation assistance (car pools), and assigning each job seeker a partner such that they work in pairs with the partner providing a role model, reminders, and assistance, thereby having each person receiving continuous individual assistance while still functioning in a group.

Also similar to behavior therapy, the Job Club program is highly structured with standardized forms and scripts that are individualized for each person.

II. EMPIRICAL STUDIES

Prior to 1975, many types of job-finding programs were being promoted and used, such as those relying on “Job Development,” or subsidized priming (such as the G.I. bills), or motivational seminars, interview rehearsal, and public employment agency listings of openings by employers. Controlled evaluation of all of these programs using the accepted scientific require-

ment of a randomly assigned control group was absent, similar to the situation that had existed previously in medicine and clinical psychology.

In 1975 my colleagues and I, as part of an Illinois research group (see Further Reading) conducted the first controlled evaluation using the Job Club method to help normal job seekers to obtain jobs. The result was that in 3 months 92% of the Job Club members had obtained jobs compared with 60% of those in the comparable wait-listed control group.

In 1979, the Job Club program was evaluated with job seekers who had severe job-finding handicaps: former mental patients, retardation, prison records, physically handicapped, and other such difficulties. As compared to a control group of similar job seekers who were given a motivational and information counseling program, 95% of the Job Club members obtained jobs versus 28% of the information counseling members. In 1980, the Job Club method was evaluated in a controlled study with chronic welfare recipients by the U.S. Department of Labor. The results were that twice as many job seekers enrolled in the Job Club obtained jobs than did those counseled by the agency's existing program.

Since that time the Job Club has been evaluated by many different controlled studies, all of which have found the method to be more effective than any of the alternatives with which it has been compared. More specifically, the Job Club has been found effective in different studies with high school students, the elderly, the visually impaired, the intellectually handicapped, the chronically mentally ill, unemployed professionals, deaf people, workforce programs, physically handicapped, state hospital patients, halfway house and outpatient mental patients, alcoholics, drug addicts, those with psychiatric disorders, criminal offenders, and in several foreign countries.

The Job Club method also has been found empirically to decrease depression and to increase feelings of self-efficacy, indicating its value in improving one's psychological state as well as in obtaining employment.

III. DESCRIPTION

A. Setting

The job seekers meet as a group—preferably 8 to 12 persons in a room equipped with a large table for ease of writing. These should be several telephone lines and an extension phone for each primary phone such that

the assigned “buddy” and instructor can listen to all calls made. The facility also provides a copy machine for résumé copies, secretarial assistance for typing résumés, daily copies of the help wanted advertisements in the local newspapers, and several copies of the Yellow Pages telephone directory. The room also contains a file of job openings uncovered by previous and current club members. A bulletin board displays for each member a visually conspicuous record in histogram form of the (1) number of telephone calls, (2) number of letters written, and (3) number of interviews obtained; these serve as a progress chart.

B. Schedule

The members attend each day for 2 weeks, arranging interviews during half of each day and attending the interviews during the other half of the day. The second half of the day after the first 2 weeks is attended by all those members who have not yet obtained a job during the first 2 weeks. The local telephone calls, photocopying, postage, stationery, and secretarial assistance are provided without cost to the job seekers. A new group can start every 2 weeks.

C. Initial Session

During the initial session, the members briefly introduce themselves to the group and identify what type of work they have had and hope to obtain. A written form is circulated on which members list their telephone number, address, and any transportation needs. This list is photocopied and distributed to all and arrangements are made to assist those with transportation needs. Each person is paired off with a “buddy” to work together. An explanation of the program and its record of successes is provided. The members are instructed to attend any interviews arranged in the sessions that day and all future days.

D. Specific Procedures

1. Job finding is treated as a full-time job; as stated, half of each day is spent in the Job Club office, and the remainder of the day is spent attending interviews.

2. Personal sources of job leads. Because surveys have consistently shown that the initial job leads for two-thirds of jobs obtained were first identified by a friend, relative, or acquaintance, the Job Club makes a systematic effort to contact those persons and not to rely primarily on published job listings.

3. Supplies and services. As noted above, the program provides all supplies and services necessary for the job seeker without cost. The actual cost to the agency has been found to be very slight relative to the usual cost of a job-finding person.

4. Group support. Members are instructed and prompted to assist each other with transportation, obtaining job leads for others and providing mutual encouragement and advice.

5. Buddy. Each member is paired with a "buddy" to provide each other with assistance. The buddy is given a checklist to record the other buddy's phone contacts with potential employers; they review the checklist recordings together.

6. Positive personal and social attributes. In addition to work skills, the Job Club approach stresses the communication of positive personal and social attributes. The job seeker is shown how to identify these attributes and how to stress these attributes during an interview, in the job resume, and when first contacting a potential employer to arrange an interview.

7. Open letters of recommendation. The job seekers are taught to obtain open letters of recommendation that can be given to interviewers and possible employers at the time of initial contact to maximize the initial positive impression.

8. Interview rehearsal. The program has each job-seeker rehearse being interviewed using common questions asked by job interviewers and is given written material describing how such questions might best be answered for maximum benefit.

9. Interview behavior reminder checklist. The program provides instruction and a checklist of behaviors to be considered in interviews, such as proper posture, eye contact, arranging a call-back date, handshake at start and end, describing positive personal attributes, and so on. The completed checklist is reviewed the next day with the Job Club instructor.

10. Assistance by family. The program sends a letter to the family (spouse, parent, or significant other) providing suggestions as to how they can assist the job seeker, such as by actively seeking job leads, providing needed transportation, relieving the job seeker of household activities that would interfere with Job Club attendance, providing encouragement, assistance in typing or letter writing, and so on. Surveys have shown that family members are typically a source of productive job leads.

11. Counselor individual attention. In order to provide the job seeker with continuing feedback, advice, and support in spite of the group setting, the counselor

follows a "continuous rotation" rule in which the counselor observes each club member in systematic rotation, spending no more than about 1 minute per club member. The counselor examines the forms being filled out, listens briefly if needed on the extension phone to job seeker calls, praises for efforts made (e.g., number of leads collected), and gives brief instruction as to what to do until the next counselor contact. This procedure plus the "Buddy" procedure described earlier provides continuous feedback and support.

12. Telephone book. The "Yellow Pages" of the local telephone book is used as a major source of job leads in the session. Because companies are conveniently listed by the type of business, the job seeker contacting those businesses will know if they are likely to utilize the job seeker's skills. As noted above, surveys have consistently shown that jobs were obtained from contact with nonpublicized sources.

13. Current job leads leading to new leads. Because personal contacts have been found to be the most frequent source of productive job leads, job seekers are taught (and supervised in session) to request additional leads from any contact person who has no positions immediately available; this situation occurs often in the telephone book contact, with friends, or at the termination of unsuccessful interviews.

14. Auto transportation is often a problem for job seekers possibly because of insufficient funds, or relative lack of public transportation in rural areas. As noted in "Group support" earlier, the club members are encouraged to assist these members with this need. Also as noted previously in "Assistance by family," family members are sent a letter urging them to supply auto transport to interviews and indeed to the Job Club location as well as to the job site when a job is obtained.

15. Telephone as initial contact. Rather than using actual "drop-ins" as a method of contacting potential employers, which usually allows 2 to 4 contacts per day, the Job Club arranges for the telephone to be used as the initial contact to arrange an interview. The telephone contacts can be made under supervision in the Job Club session and in great number.

16. Number of sessions. The goal of the Job Club is to obtain employment for all (100%) of the job seekers. If a fixed number of sessions are allowed, the most needy or job handicapped are likely to remain unemployed. Therefore, the Job Club program allows and encourages continued attendance until a job is obtained. Even after a job is obtained, the members are encouraged to return if they again become unemployed. This continual access

is logistically made possible by having the continued access members meet in the afternoon each day, while new members meet in the morning hours, with a new group starting in the morning every 2 weeks. After the 2 weeks, the members attend in the afternoon. In practice, past club members attend only occasionally, usually to use the copy machine, or telephone, or to obtain postage or typing assistance, but this continued availability appears very important in assuring the most difficult-to-place persons that they will not be abandoned.

17. Multiple sources of job leads. Surveys reveal that productive job leads result from many sources, primarily from personal contacts, but also about a third from various public announcements. The Job Club accordingly emphasizes primarily the personal sources (see "Personal Sources of Job Leads" earlier), but also common public announcements that are obtained by visits to a local public service employment agency, and announcements in newspapers' help wanted advertisements and professional and trade newsletters.

18. Personal orientation of résumé. In recognition of the great role played by personal attributes, the résumé does not only chronicle the Job Club members' job-relevant experience but also positive personal attributes of the job seeker, such as being "a team player," a "leader," "dedication to one's employer," "motivates the employees reporting to him," "needs no supervision," "well-liked by customers and fellow employees," and so on, whichever attributes honestly apply to the specific job seekers. These personal attributes are noted and emphasized in the interview as well.

19. Type of job applied for. In recognition of the diversity of skills of a given job seeker, they are encouraged to apply for more than one type of position (grant writer as well as English teacher, for example) and also to list the diversity of their experiences that may not be evident from the listing of their work history, such as being multilingual, computer proficient, organizing groups for community service, or club projects leader.

20. Structured job-seeking schedule. The job seeker is given preprinted forms and taught by the counselor to use them to arrange each day's activities with regard to interviews (date, time, name of interviewer, address, telephone number, etc.), call-backs after an initial inquiry or after each interview, persons to contact for possible leads, and so on. By structuring each day's activities the job-seeker's job search is focused, organized, and full-time.

21. Job Seeker Progress Feedback. A major problem in the job search is the discouragement and loss of motivation that results when no job placement has resulted from one's initial efforts. To help overcome this prob-

lem, the program provides feedback to the job seeker via a visual display on the wall of the room depicting separately how many interviews, telephone calls, and letters were completed by the job seeker since the start of the research. Also on the wall is a chart showing how the probability of success increases as the number of interviews increases, as determined by the results of all previous Job Club members. A job seeker's attention is directed to this chart as feedback on how his or her efforts are increasing the probability of success even though no placement has yet been obtained.

22. Counselor's style. The counselor's style is consistently positive, never criticizing or pointing out shortcomings or errors in carrying out the specific steps of the search. Rather, the counselor praises all progress and all efforts, even the fact of attendance. To address any omissions or errors, the counselor follows a "future-oriented" style, describing to the client what changes or additions might be made in future efforts to improve the chances of success.

IV. SUMMARY

The Job Club method is a program for assisting job seekers to obtain employment that has been found effective in several controlled outcome studies. It requires an experienced counselor as the leader and functions in a group format. The members do not passively listen to suggestions, but rather are actively engaged and supervised in the job search during each session by obtaining job leads and arranging interviews. The sessions continue for each job seeker until he or she obtains a job or discontinues attendance. The results of this intensive program has been that more than 90% of the attendees obtain employment. The program is based on the principles of learning and motivation embodied in the psychological body of knowledge known as behavioral psychology, which emphasizes rehearsal and functional improvement.

See Also the Following Articles

Behavioral Contracting ■ Contingency Management ■
Good Behavior Game ■ Homework ■ Token Economy ■
Vocational Rehabilitation

Further Reading

Amvine, C., & Bullis, M. (1985). The Job-Club approach to job placement: A valuable tool. *Journal of Rehabilitation of the Deaf*, 19, 18-23.

- Azrin, N. H., & Besalel, V. A. (1980). *A Job Club counselor's manual: A behavioral approach to vocational counseling*. Austin, TX: Pro-Ed Publisher.
- Azrin, N. H., Flores, T., & Kaplan, S. J. (1975). Job-Finding Club: A group assisted program for obtaining employment. *Behavior Research and Therapy*, 13, 17-27.
- Azrin, N. H., & Philip, R. A. (1979). The Job-Club method for the job-handicapped: A comparative outcome study. *Rehabilitation Counselors Bulletin*, 25, 144-155.
- Azrin, N. H., Philips, R. A., Thienes-Hontos, P., & Besalel, V. A. (1980). A comparative evaluation of the Job Club program with welfare recipients. *Journal of Vocational Behavior*, 16, 133-145.
- Elksnin, L. K., & Elksnin, N. (1991). The school counselor as job search facilitator: Increasing employment of handicapped students through job clubs. *School Counselor*, 38, 215-220.
- Jacobs, E. (1984). A skills oriented model facilitating employment among psychiatrically disabled persons. *Rehabilitation Counseling Bulletin*, 28, 87-96.
- McGurvin, M. C. (1994). An overview of the effectiveness of traditional vocational rehabilitation services in the treatment of long-term mental illness. *Psychosocial Rehabilitation Journal*, 17, 37-54.
- Murphy, G. C., & Athanson, J. A. (1987). School to work transition: Behavioral counseling approaches to the problems of finding jobs for unemployed adolescents. *Behavior Change*, 4, 41-44.
- Stilham, H. H., & Remley, T. P. (1992). The Job Club methodology applied in a workforce setting. *Journal of Employment Counseling*, 29, 69-76.

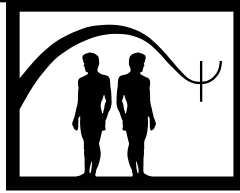

Jungian Psychotherapy

Jeffrey Satinover

Yale University

- I. Introduction
 - II. Description of Treatment(s)
 - III. Theoretical Bases
 - IV. Empirical Studies
 - V. Summary
- Further Reading

GLOSSARY

(Archetypes are preceded by asterisks. Some are also correlated [*in brackets*] to characters in the popular film series “Star Wars,” as these were deliberately designed by George Lucas to represent Jungian archetypes.)

active imagination A practice whereby imagery is deliberately engaged as though one were participating in one’s dreams while awake. [*As when Luke “feels the Force.”*]

amplification Used chiefly as a method of dream interpretation, whereby the therapist explicates a patient’s dream by relating those myths, legends, fairy tales or otherwise archived symbol, images, and stories that seem most pertinent to the dream.

analysis (Jungian) The formal designation given Jungian psychotherapy within the Jungian world, reflecting Jung’s early role in the development of (Freudian) psychoanalysis. However, the practice of Jungian therapy is very unlike that of classical psychoanalysis.

* **anima** A personified representation (imago) of the undeveloped feminine potential in a man. [*Princess Leia*]

* **animus** A personified representation (imago) of the undeveloped masculine potential in a woman. [*Han Solo*]

archetypal (Jungian school) Followers of James Hillman. Hillman considers there to be no “Self”—and no “self” ei-

ther. His school focuses on literary elaborations of archetypal motifs rather in the spirit of Lacan and of deconstructionist literary criticism. He terms his approach “archetypal psychology.” While much admired throughout the Jungian world, it has no formal structure (e.g., training methods, programs, or institutes). It may be thought of as being focused on the technique of amplification, narrowly and for its own sake.

archetype An innate, latent nucleus of personality predispositions conforming to a consistent set of attitudes, ideas, emotions, and behaviors. Symbolically represented as the stereotyped characters of myth, fable, and literature.

classical (Jungian school) Followers of Jung’s original formulations. The classical school is emphasized in this article and relates Jungian analysis as less a form of therapy than a modernized Gnostic spiritual discipline: a sacred journey or quest to achieve full realization of the Self. [*Luke Skywalker is the hero of the quest*]

* **collective unconscious** The various archetypes; the innate preformed structure of the psyche.

developmental (Jungian school) Followers of Jung whose primary interest is in practical therapeutics. Formerly termed the “clinical” school, which is more accurate. However, it is also true that this school assumes that adult personality develops largely on the basis of childhood developmental process. The classical school is more interested in adult developmental changes while the archetypal school considers development a “fantasy.”

extraversion One of two fundamental orientations of a person. The extravert directs interest and adaptive effort chiefly toward the outer world and other people.

Gnosticism A perennial religious philosophy that identifies God (or a god) with an interior state of “illumination” available only to initiates. Gnostic strains accompany the

mystical practices of most religions. Gnostic variants of Christianity have always been the chief source of heresy in the Church's view. [*The Jedi Knights*]

* **Great Mother** A personified representation (imago) of on the one hand the experience of being comforted and nurtured, and on the other, of being terrifyingly vulnerable to the withdrawal of same.

individuation process The process of achieving "wholeness," wherein all competing aspects of the personality are accepted, integrated and harmonized. Marked by the appearance of the Self, and by subjective states of a religious or spiritual character.

inflation Hypomania.

introversion One of two fundamental orientations of a person. The introvert directs his interest and adaptive efforts chiefly toward the inner world and himself.

mandala A term from Buddhist iconography, these are complex images whose basic structure consists of a circle subdivided into four major quadrants, and further subdivided or inscribed with complex, highly symmetrical, often recursive designs. Mandala-like imagery represents the Self and is expected to emerge spontaneously in dreams and visions as the sign of a successful individuation process.

personal unconscious Jung's term for what Freud called the unconscious (i.e., repressed material) in contrast to archetypes, that are presumed never previously to have been conscious.

psychoid A necessarily ill-defined term that refers to the puzzling mind-brain interface.

* **Self** The entirety of the personality encompassing both consciousness and the unconscious; an experienced unity of all archetypes; the endpoint of the individuation process. Often felt subjectively as the presence of God and so symbolized in dreams, visions, and in cultural products. [**The Force*]

* **shadow** A personified representation (imago) of the personal unconscious. [*Darth Vader*. But the "dark father" is not typical.]

synchronicity The relatedness of two events solely on the basis of their meaning to an individual, in the absence of any possible direct or indirect causal relation. This relatedness was held by Jung to be in some sense objective, however, and not merely in the mind of the individual(s) perceiving the meaning. Pathologically: ideas of reference.

* **trickster** A personified representation (imago) of a capacity for paradox, and concealed wisdom, messenger to the gods. [*C3PO and R2D2*]

types A set of innate personality predispositions on three orthogonal axes.

* **wise old man** A personified representation (imago) of a capacity for spiritual insight and experience. Leads to the Self [*apart from their ears, Joda looks exactly like Jung*.]

I. INTRODUCTION

Jungian therapy ("J_analysis") is a face-to-face psychoanalytic psychotherapy based on psychodynamic

principles elaborated by the Swiss psychiatrist Carl Gustav Jung (b. July 26, 1875, Kesswil, Switzerland; d. June 6, 1961, Küsnacht) after his break with Freud and classical psychoanalysis around 1912. In sharp contrast to the early psychoanalytic model of the mind restricted to instinct, drive, and defense, Jung postulated an innate, irreducible, and thus additional psychic need to apprehend meaning and to express it symbolically. This need most commonly generates a religious impulse that cannot in every case be derived from (nor need always be a defense against conflict with) the biological drives. When ignored or blocked, this need can produce not only unhappiness, but psychological distress and eventually overt symptoms. Jung considered the now-widespread dismissal of religion as driven less by rational disillusionment than by hubris.

Classical Jungian therapy therefore aims at promoting an "individuation process," marked by an individually determined interior experience of a markedly mystical character. Jungian scholarship incorporates and interprets a vast, world-spanning body of mythological, religious, mystical, and occult references. Jungian ideas are widely embraced within artistic, literary, religious, and pastoral circles, but remain largely peripheral to academic psychology and psychiatry.

Jung anticipated many later trends: "ego-psychology," which defines, and focuses treatment toward expanding a defense-free domain of the ego; the ideas of Otto Rank, who similarly focused on free will; Heinz Kohut with his emphasis on a "self" developed out of "normal narcissism"; Hans Loewald's re-evaluation of regression as not merely restorative but creative; and Abraham Maslow's notion of "self-realization." Today's easy blending of "new age" psychotherapy and spirituality likewise parallels Jung's approach—and was in large part fostered by it.

II. DESCRIPTION OF TREATMENT(S)

A. Historical Backdrop

It took about 1000 years for European culture to consolidate around a relatively uniform body of Christian, creedal beliefs. That this would happen was by no means a foregone conclusion. The main competitors to early and medieval Christianity formed a group of philosophies and theologies loosely called "Gnostic." They shared with each other, and with many Eastern religions, the view that the goal of spirituality was a

form of personal “illumination,” a specific state of mind, if you will.

Jung considered his “analytic psychology” to be a modern reformulation of these same ancient Gnostic principles. The mass return to these ancient mysticisms that marked the 1960s was therefore unsurprisingly characterized as well by a sudden upsurge of interest in Jung. (Timothy Leary applied to the C. G. Jung Institute of Zürich in 1971 but was rejected.)

Jungian psychology arose within an unusually gifted, accomplished, and eclectic circle of continental scientists, artists, poets, writers, and theologians who gathered around the person of Jung (see, for example, the proceedings of the Eranos Conferences of the 1930s and 1940s). Most shared with Jung a deep hunger for the mysterious and a visceral dislike of the rationalism and materialism that they considered Freudian psychoanalysis to embody—indeed, modernism altogether. But they were also too sophisticated for the fading religiosity of pre-World War I Europe.

They were seekers, an intellectual elite that heralded the new-age spirituality that would explode in populist form worldwide two decades later. As Jung conceived it, “analysis” should stimulate the “Self” to emerge, heralded by imagery associated with God (dreams; induced visions called “active imaginations”) and accompanied by the unique emotions attending divine revelation. This “individuation process,” hence classical Jungian therapy itself, therefore has a markedly spiritual—specifically Gnostic—cast.

Nonetheless, Jung had a strikingly open mind toward what we now call “biological psychiatry.” In the mid-1950s he chaired the First International Congress on Chemical Concepts of Psychosis, having formulated a prescient biochemical theory of schizophrenia—in the same book in which he first outlined his *religiously* based objections to Freudian psychoanalysis. Freud had specifically appointed Jung his “prince and heir,” and as Jung was a rising young psychiatrist assigned him the task of “conquering for psychoanalysis the psychoses,” as Freud himself had the neuroses, by showing that psychotic imagery, like dreams, consisted of the same infantile conflicts, in disguised form, as in neurotic fantasy. But Jung concluded otherwise: Psychotic imagery was a rigidified self-portrait of innate, biologically foundational brain processes. They were on this genetic basis universal, and did not arise from the idiosyncratic conflicts of an individual mind. Such imagery was accessible in normal states as well, mystical and creative ones in particular; their emergence and fixedness in psychosis was due neither to spiritual development nor creative genius but rather, he guessed, to a

destructive toxin. To treat all such imagery as born of neurotic conflict at once grossly underestimated both art and religion and grossly overestimated both the neurological integrity of a brain affected by psychosis and the power of psychoanalysis as a treatment method. Empirically, if not strictly speaking scientifically, Jung was well ahead of his time on both points.

Jungians after Jung have been keen students of other schools of psychotherapy—object relations theory, the ideas of Heinz Kohut, Gestalt therapy, for example, even classical psychoanalysis—as much as they have been keen students of religion, both new and old. However, those Jungians most interested in other schools of therapy tend not to be the ones most interested in religion. This difference in “culture,” as it were, underlies the major divisions in the Jungian world, markedly enough so that conferences in the 1970s and 1980s explicitly addressed the conflict between a second-generation “clinical” camp and Jung’s first generation of followers. The clinical practices of the former are scarcely distinguishable from the clinical practices of any well-trained, psychodynamic psychotherapist, even if the language they use is different.

By the 1980s, yet a third strand in Jungian thought and therapy had developed, largely under the influence of James Hillman, whose talents and approach to treatment are chiefly literary, with a strong “deconstructionist” cast. Whereas Jung and his early followers sought a form of enlightenment as symbolized by the emergence of a unitary “Self,” Hillman and his followers pursue rather a never-ending process of poetic interpretation and story-telling whereby any (and every) firm belief save one can ultimately be “seen through,” as they put it: deconstructed not into a set of socially inculcated self-serving biases, but into a set of transcendental self-serving illusions (“gods”). Whereas Jung made an explicit analogy between the “Self” and God (or to a Gnostic Christ), Hillman makes an explicit analogy between his “archetypal psychology,” and the god Hermes, messenger among all the gods—and trickster to their self-importance.

The sole firm belief opaque to Hillman’s archetypal psychology is, of course, the firm belief that any and every firm belief can ultimately be “seen through,” the belief on which depends the trickster’s own self-importance.

These three Jungian camps have now acquired more or less formal names: the “classical,” “developmental,” and “archetypal” schools, respectively. (No school wants not to be called “clinical.”) A brief analysis of the same case as approached by representatives of each of the schools may be found in *The Cambridge Companion to Jung*, and

an excerpted web version at <http://www.iaap.org/articles/ccj3approaches.html>. What follows is a synopsis of classical, hence distinctively Jungian, psychotherapy.

B. Classical Jungian Therapy

1. Format

Jungian therapy (“Jungian analysis”) is conducted face-to-face. Jung believed that the “neutrality” of the classical psychoanalyst was undesirable—because largely illusory. He was the first to argue for a more “personal” form of psychotherapy in which the mixing of the patient’s problems and biases with those of the therapist would be accepted as a virtue. Treatment sessions last about an hour and take place no more than three times weekly, more typically once or twice.

2. Process

Classical Jungian therapy has two chief components: dream interpretation and “active imagination.” Dream interpretation begins immediately; active imagination is a method usually employed later.

a. Dream Interpretation The Jungian approach to dream interpretation uses two main techniques: association and amplification. To associate to his dream, the patient freely expresses, without censorship, any thoughts that the imagery brings to mind. In contrast to classical psychoanalytic technique, however, Jungian-style association is interrupted, not free. It is akin to the limited association Jung asked of his subjects in his early word-association studies: Once a link is established by the patient between an element of the dream and some aspect of the patient’s life—past or present—the therapist encourages him or her to set that element aside and associate to other aspects of the dream. Jung insisted that while associations eventually lead toward a patient’s familiar conflicts (which he called “complexes”) they wandered away from the specific meaning of the dream to which they were tethered. Inevitably, the lack of new information will lead both therapist and patient to devalue dream interpretation. Over the years, this is exactly what has happened in most schools of psychoanalytic psychotherapy. On the other hand, those classically trained Freudians in whose hands dream-interpretation remains a vital art (and those patients who have likewise learned its vitality) invariably interrupt free associations in precisely the way Jung argued they should—a matter more of common sense than of deep theoretical distinction. Jung’s rather overly sharp argument with free association also reflects the relatively limited role played by

conflict, repression, and compromise in the (early) Jungian psychodynamic theory of symbol and symptom formation, hence in the classical Jungian approach.

For both practical and theoretical reasons, in the early stages of a classical Jungian treatment, dream interpretation consists in teaching the patient (by commentary, not directive) how to make plausible links between the elements of the dreams and their personal concerns. Early on, the dreams are expected to be of the kind familiar to most psychotherapists: fleeting, fragmentary, often confusing.

Patients are encouraged to keep careful records of their dreams, and to note their responses both to the dream imagery itself and to any of the personal material evoked by the dreams. They are likewise encouraged to express both the dreams and their responses in plastic form: drawing, painting, poetry, story-telling, music, even dance, as the patient is inclined. For perhaps two years, a classical Jungian analysis may consist of little else but attention to dreams.

Over time, it is anticipated that the character of the dreams will subtly change. From reflecting a more or less self-evident preponderance of personal problems and concerns expressed in idiosyncratic images composed largely of memory traces, the dreams will begin to become more mysterious—harder to link to personal experiences—and will take on a more general character. More fable-like, such “big dreams” employ the universal characters of myth and legend: heroes, villains, monsters, kings, queens, princes and princesses, fantastic landscapes. They are also more likely to unfold as full-scale dramas, with a coherent structure. This kind of imagery is termed “archetypal,” by which Jung meant to indicate at once their common and their fundamental nature. He considered these figures, and the dramas they engaged in, to be the intrapsychic representation of the innate structure and dynamic of the human psyche, the “images of the instincts.” Out of the inherent repertoire of such dramas (aspects of brain function that presumably evolved as discrete patterns of adaptive response to being a human being in a typical human setting), the ones that are individually emphasized in each person reflect the psyche’s deepest response to particular challenges constructed from the common, evolved responses of the human species to like challenges. Variations in this response unique to each individual’s specific genetic background may be evident as well, especially if these reflect relatively long-term adaptational pressures that affected many ancestral generations.

Once criticized as dangerously racist, such notions tend nowadays to be taken for granted in evolutionary

medicine—as for example in the strong genetic pigment correlations and statistically near-perfect north–south geographic gradient in the distribution of seasonal affective disorder. Group differences in innate brain-based response patterns attenuate, naturally, as the human gene pool becomes increasingly mobile and admixed. It should be said, however, that the classical Jungian therapist attributes to these patterns a transcendent meaning that goes beyond purely biological explanations.

b. Active Imagination Once a patient has begun to experience “big dreams,” they are encouraged to take their expressive engagement with the material a step further. The patient will be guided to converse with the dream figures in imagination. The goal is to achieve a state of mind akin to certain forms of meditation that utilize explicit visualization. These meditative practices can be found worldwide and are detailed, for instance, in Jewish Kabbalistic, medieval Christian-contemplative, Tibetan Buddhist, and Chinese Taoist texts, *inter alia*. When successful, the visualized dream characters are experienced as holding up their end of the conversation, as it were, on their own, not as being invented by the patient in the way that an author invents dialogue.

On the other hand, it is not uncommon for authors (indeed, anyone experiencing creative inspiration) to feel that certain ideas appear spontaneously. But the purpose of “active imagination” is not artistic but rather to learn from whatever the “characters” themselves have to say. “Active imagination” is a state of dissociation, cultivated for constructive purposes rather than for defense. Arguably, it has much in common with classical free association. The major difference between active imagination and free association—and between individuals drawn to the one and those drawn to the other—may precisely be the well-known individual differences in dissociability. The temperament of Jungians, both patients and professionals, may therefore tend on average to be more expressive, sentimental, and “hysteroid”; of Freudians, more restrained, intellectual, and “obsessive.” An older parallel distinction is that between the romantic and the classical types. In sum: That which Freudians dichotomize by the abstractions “hysteria” and “obsessionality,” Jungians poeticize as the enmity of Apollo and Dionysus.

3. Individuation

In any event, not everyone has a knack for active imagination. Those who do are considered to have the essential skill for the “individuation process.” Utilizing active imagination as its chief vehicle, the Jungian analysand may now undergo a lengthy series of imagi-

native encounters with the major “archetypes.” These appear as larger-than-life beings of mythic proportion and (in the meditative state) so real as to engender intense emotional response. The therapist’s role at this stage is two-fold: First, to ensure that the emergence of this archetypal material is paced so as to minimize the risk of “inflation” (hypomania); and second, to guide the analysand toward literature that “amplifies” the meaning of the emerging themes.

Jung’s own autobiography remains the best example in the literature of such a state, and of the difficulty of discriminating among deliberate active imagination, psychotic hallucination, and extreme dissociation. There are some individuals who are able to engage in active imagination but who should not, because of its potentially destabilizing effects.

In a successful individuation process, the encounter with the archetypes greatly expands the individual’s sense of meaning and purpose in life, and their flexibility in adaptation. Potentials previously unrecognized and untapped may be awakened, and aspects of the personality that had lain fallow may now be cultivated and incorporated, yielding greater “wholeness.”

Jung believed that such an expansion of the personality was marked in dreams and active imagination by the spontaneous appearance of symbols of the “Self.” These are images whose basic geometric format is the quartered circle (“mandala”). They are strikingly similar to symbols utilized worldwide to represent God; in polytheistic cultures, the highest god; in Gnostic religions, the union of all gods.

The symbol system Jung considered closest to that which emerges in modern patients was that of the alchemists. Their journey to all the planets, their “sublimation” of lead through various metals to gold, their quest to unite ever higher-level opposite elements to form the Philosopher’s Stone: All symbolized the transformation of personality by the progressive encounter with and integration of the “lesser” gods within to form the “Self”—hence the capitalization.

The ideal classical Jungian individuation process is expected to traverse the following stages: (1) Integration of the “personal unconscious,” or “shadow,” loosely equated with the unconscious as defined in psychoanalysis; this prepares the individual for integration of the “collective unconscious,” that is, the archetypes; to wit (2) the “anima”—unrealized feminine aspects of a man, or “animus”—unrealized masculine aspects of a woman; (3) the “Great Mother,” the embodiment of everything maternal, both nurturing and engulfing, as nature herself can be; (4) the “Wise Old Man,” the embodiment of “spirit”; (5) the “Self,” an overarching union of all of

these, that is at once the superordinate representation of God and the foundation of individual identity (as in the equation of Atman and Brahman in Hindu mysticism; or of Christ and the person in orthodox Christian theology).

Individuation itself is a never-ending process. Jung considered the ignition of the process in therapy, and at least some substantial experience of the “Self,” to be the goal of therapy. With the acquisition of a sense of meaning and higher purpose in life, symptoms may be expected either to disappear or, if not, to have taken on the kind of meaning that allows them to be accepted as a gift rather than a hindrance.

III. THEORETICAL BASES

In classical Jungian therapy, practice and theory are intimately intertwined. A common criticism of Jungian therapy is that it amounts to the indoctrination of the patient in a specific quasimystical worldview. The classical Jungian would sharply deny that this is criticism; Jung and many of his followers explicitly consider the individuation process to be a modern equivalent to antique rites of initiation into the cult and doctrine of certain gods and/or goddesses. But he would balk at “indoctrination.” A central tenet of Jungian theory is that the “initiatory” sequence of archetypes emerges spontaneously from within the patient, rather than being overtly or covertly taught. Similarities to any external sequences arise because of innate predispositions that underlie the symbol-making potential of the human brain.

Evolution suggests that the brain should develop predispositions to apperceive experience according to common if flexible categories and patterns (like the newborn whose mouth conforms, without instruction, to the negative space of a human nipple). Fully formed “images” per se need not be embedded innately for common forms to emerge widely. Nor can simple commonality of experience account for all the overlap in imagery: Even motherless infants hunger for her expected presence. (This particular line of reasoning led to a rapprochement in the United Kingdom between followers of Jung and of Melanie Klein.)

A. Biology versus Spirit in Jungian Therapy

Against this one may argue that Jung developed Jungian therapy not empirically but much as did Freud: out of a lengthy attempt to define himself, free from serious outside accountability, with patients

turning into followers, and with data from all. The importance and plausibility of the archetypal hypothesis notwithstanding, the vast body of Jungian writing detailing “archetypal imagery” in case studies can provide no compelling supportive evidence for it. Today’s Jungian therapists are therefore far less likely to assume that something is archetypal just because it looks like it.

What exactly is an innate structure of the psyche? Jung’s revolt against Freudian reductionism led to Jung’s claim that there is a “level” of the psyche deemed “psychoid,” that is at once both instinctive and transcendent. Critics argue that this is a mere assertion and that the concept “psychoid” is ill-defined. In effect, Freud argued that society strikes a never-wholly successful compromise between animal desires and a wholly pragmatic civility, religion of any kind serving to enforce the precarious dominance of the latter. Jung argued that society need strike no such balance, since in the form of spirituality he advocates desire and civility become one; only organized religion is a problem in stifling both spirituality and instinctive gratification.

The religious instinct, Jung thus argues, is real, not a defensive pose taken up by one of the animal instincts to help us avert our gaze from its true intent. Like any instinct, it has an underlying nervous system physiology that is relatively invariant among all human beings. Hence, its patterns of expression, and the sequence of maturational steps it follows, are similarly invariant. It may be ignored, as may any other instinctive drive, but only at significant cost: a sense that life is ultimately meaningless. On the other hand, Jung argued, spirituality that defines itself as unconnected to instinct tends to become sterile and unfulfilling, a criticism he leveled without cease at Christianity.

A dominant Eastern model for the individuation process in early Jungian circles (in the 1930s) was therefore Kundalini Yoga, a form of mystical practice in whose original (Tantric) form enlightenment could be achieved via the sacred sexual union of the male and female practitioners. The corresponding Western model was, again, alchemy, the symbolic content of which was explicitly sacred-sexual, the “union of opposites” depicted as the explicit sexual conjugation of a naked king and queen; and the practice of which involved a male alchemist and his “mystical sister” (*soror mystica*) working together in sacred precincts of the “laboratory.”

In the classical Jungian model of therapy as individuation, an intense mutual emotional entanglement of analyst and analysand was anticipated and cultivated. As in psychoanalysis, these emotions are termed “transference”

and “countertransference,” but they are not interpreted as the emergence of long-repressed infantile longings whose original objects are found in the family. Rather, they are understood as the awakening of never-before experienced longings whose proper objects are divine.

To penetrate into the depths of the psyche in a classical Jungian analysis is therefore meant to be a profoundly spiritual journey whereby the tension between material drives and spiritual longings are resolved by their union. Such a journey has importance beyond the resolution of an individual’s personal conflicts: To achieve in any significant measure a “union of matter and spirit” is to contribute to the building of a new explicitly post-Christian spiritual epoch. In light of modern culture-wide sentiments it is remarkable that Jung and his followers elaborated all these ideas well before World War II.

B. The Structure of the Psyche

1. *Conscious versus Unconscious*

For Freud the unconscious is primarily a set of primitive, unacknowledged desires that to remain out of sight require an ever-expanding construction of mutually reinforcing false ideas, self-serving attitudes, and conveniently filtered, distorted and, as needed, invented, memories. But such freedom from self-knowledge demands an exhausting vigilance. Psychoanalytic treatment therefore consists largely of a tactful undermining of this vast defensive fortress. Treatment releases the energy invested in defense for other “constructive” purposes.

To that aspect of the unconscious that is more than what has been repressed psychoanalytic theory did once accord a place—Freud recognized that some dream images, for example, represented “vestiges” of an early stage in the (biological) evolution of brain function. But as the term “vestige” suggests, he considered this material of little practical significance. It is rarely even mentioned anymore.

Jung’s dislike of psychoanalytic theory, and of Freud’s worldview, follows rather directly. Freud’s insistence that all human activities are but distorted variations of material, instinctive drives—that “higher meaning” is therefore nothing but cheesecloth veiling the bleak truth of reality—seemed to Jung much like what the alchemists called “the universal solvent.” In its attack, it excepts nothing: not even the beaker supposed to contain the solvent; not even, therefore, psychoanalysis itself. In such a bleak view, there are no “constructive” purposes in whose service all that freed energy can be

placed without some new illusion to sustain it. “Sublimation” therefore is not sublime, it is merely the “highest” form of defense against reality.

For Jung, by contrast, the structure created by repression is the trivial and uninteresting aspect of the unconscious (the “personal unconscious”). What Freud considered a mere vestige, Jungians view as the essential, inherited anatomy of the psyche, and by virtue of its link to spirit, the pathway toward higher meaning. Jungians argue that meaninglessness is a priori pathogenic, and to train people to accept it is to induce, not alleviate, both psychological and societal disorder. The Nazis succeeded, Jung argued, because they offered Germans meaning, whereas Weimar deprived them of it. The power of his simple insight—that no one accepts meaninglessness—was severely compromised by Jung’s own early flirtation with Nazi ideology.

The repressed material of the personal unconscious may need to be dealt with first, but the individuation process proper will only begin when material from the deeper levels of the collective unconscious begins to emerge. This deeper material is not considered to be a disguise for otherwise unacceptable but perfectly expressible thoughts and feelings. The mythic imagery is treated rather as genuine metaphor—that is, the best possible representation of profound states of mind otherwise inexpressible. The repressed material of the personal unconscious and the innate archetypes of the collective unconscious are related in that personal conflict, hence repression, develops only around matters that are of inherently profound import.

2. *Archetypes*

The infant is born hard-wired to form an attachment to a specific kind of external object. Later, to this latent expectation there becomes associated a specific set of sensory impressions. But the innate representation can never adequately be embodied by any real experience or memory. Instead, the mind, when released from the criticisms of rationality, will creatively weave together—from memory and from imagination—whatever fragments it needs to paint a portrait of the hidden, never before “seen,” yet more “real,” more deeply longed-for and feared “Great Mother,” the “archetype” against which all human mothers—indeed, all women—are subtly going to be judged; and against which they subtly judge themselves.

Religion and therapy come together in this model when the compulsive philanderer, say, realizes that not only is he pursuing his mother in the guise of other

women (the personal unconscious at work), but that his disappointment in his mother arises less from her flaws as a person than from his previously unacknowledged longing for a Mother of the sort not ever available in earthly form (an element of the collective unconscious). The latent, preformed imago of “mother” Jung called the “Great Mother” archetype. A family of archetypes constitutes the basic structure of the human psyche. Such a viewpoint has much in common with later “object relations” psychoanalytic theory except that for Jungians, “introjects” do not come from the outside—they begin within, are projected outward onto more or less suitable objects, and only then reintegrated.

Many Jungian archetypes have obvious parallels in typical human experience and so lend themselves to a more standard psychoanalytic or object-relations reinterpretation: Perhaps images of the “Great Mother” are energized not by innate, universally human expectations but by experiences that are universal, or nearly so, subjectively processed. (The Jungian model is closest to an interactionist model.) But other archetypes are not so easy to reinterpret this way. For example, the so-called trickster figure, common to many folk religions, and especially to shamanism, was the veritable patron god of alchemy in the form of Hermes (Mercurius). Why jokes, trickery, adolescent mischief-making, chicanery, and even outright duplicity should have so honored a place in certain forms of spirituality is hardly self-evident—unless one starts with the assumption that all such “higher” pursuits are cons.

3. The “Self”

The hermetic mysticisms of antiquity guided the seeker along a more-or-less well-known path toward a distinct state of illumination. The state is represented by a plethora of metaphors; the path likewise. But a common feature of most metaphors for the path is that of a synthesis of some sort: Initiation consists of the controlled identification with, incorporation of, and disidentification from a sequence of gods (“metabolized introjects”). The journey to each of the planets (named after the gods) is one such metaphor; the progressive transformation of base metals (lead) to noble ones (gold) is another (with each metal associated with a planet and a god). Hermes guides the soul on its planetary peregrination; Mercurius guides the alchemist in the progressive “sublimation” of the metals. As each “god” is encountered, identified with, and disidentified from, it is integrated to form a larger nucleus of personality that Jung called the “Self.” Although experienced within, it is experienced as larger and other than one’s personal identity.

4. Personality Types

Jung also authored the widely accepted distinction between “introversion” and “extraversion.” He considered these traits as defining an important and universal dimension of human personality—an axis along which everyone tends toward a characteristic position that forms their most comfortable way of relating to the world. Jung extracted two other independent such axes as well: one defined by a polar contrast between “thinking” and “feeling”; the other by a polar contrast between “sensation” and “intuition.” The eight types thus defined seem at first glance to have a rather forced symmetry. But of all of Jung’s theoretical constructs, his typology has earned the most research-based confirmation.

A careful study of Jung’s ideas about the archetypes and the collective unconscious on the one hand, and of his typology on the other, reveals very little compelling connection between them—they could easily be developed as two entirely different models of the psyche.

There is one critical point of contact, however, with respect to the concept of introversion. When he at first accepted Freud’s plan that he should conquer the psychoses for psychoanalysis, Jung spoke of the essential problem in psychosis as being that of “narcissism”—the turning away from relationships to a solipsistic world of inner gratification. Freud’s understanding was that this turning away was regressive and defensive—that the healthy capacity to spurn narcissism had been acquired by the psychotic and then split off (a defensive “vertical split in the psyche,” as Freud would later characterize it when indirectly responding to Jung’s abandonment of psychoanalytic theory), a variant of repression.

But eventually, Jung came to two very different conclusions: First, as noted before, that however it may first have been initiated, the profound entrenchment of psychosis was due not to psychological defense and resistance, but by a serious biochemical defect. The second conclusion was that narcissism per se was more than an early stage in psychic development and more than a defensive regression to that stage: It was a normal, natural, and absolutely critical component of the psyche at all stages of life, and perhaps especially necessary in later maturity in particular. That is why when he broke from Freud over just this issue, Jung ceased using the word narcissism and replaced it with “introversion.”

When Jung rejected/was ejected from the psychoanalytic movement, a nascent psychodynamic understanding of healthy narcissism was ejected as well. The mutual bitterness of this parting ensured that it would take Jung’s followers a good 50 years to accept the importance of the “personal unconscious,” and that it

would take Freud's followers the same 50 years to produce and accept the ideas of a Heinz Kohut and of related forms of self psychology.

C. Science or Religion?

Most people are unaware of this, but many major mainstream American churches have tacitly but extensively made of Jungian theory a new theological foundation. (This is especially true, for example, of the Episcopal church in general and of the female religious orders of the American Catholic church.) In many cases the incorporation of Gnostic and pagan themes is remarkably explicit given the flat contradiction between the Hebrew and Christian scriptures, on the one hand, and the Gnostic heretics to whom Jung explicitly relates his own ideas. To the extent that religions have felt that they need to justify themselves on psychological grounds—theology proper apparently being passé—they have frequently therefore become agents for the widespread social acceptance of Jungian psychotheological ideas, although these are rarely recognized for what they are. Jungian theory and therapy thus exerts an extraordinary cultural influence both via formal religion and informal post-sixties' spirituality.

Yet Jung also exerted an important influence—one that continues to grow—on arguably the most fundamental of the hard sciences, namely physics. Mathematical physicists with a keen interest in quantum mechanics cite certain Jungian ideas regularly in their writings. A few of the more prominent names include Christopher Isham, professor of theoretical physics at Imperial College, London, and Henry Stapp of the Theoretical Physics Group at Berkeley, Harald Atmanspacher of the Max Planck Institut and Kalervo Laurikainen at CERN. On the brief back flap biography of his *Lectures on Quantum Theory: Mathematical and Structural Foundations* Isham specifically mentions his interest in “the work of C. G. Jung,” and on the cover, the letter “o” in “theory” is replaced by a snake biting its tail—the “ouroboros”—a favorite symbol of Jung's that he often interpreted as referring to a mysterious wholeness of everything that evades causality. This is no accident.

In the late 1920s and early 1930s Jung developed a theory of “synchronicity,” the idea that events unrelated by any causal chain were nonetheless related via meaning, not merely as an invention of imagination, but objectively. Astrology, for example, claims that stellar arrangements as happen to be seen on earth, and perceived as forming images drawn from earthly expe-

rience (e.g., Scorpio the scorpion), influence both behavioral tendencies and chance events in the life of selected individuals, and that this influence is uniquely symbolized by the constellation's image.

The kernel of astrology is not the idea that stars influence people—one could contrive some chain of physical events, however farfetched, that might effect such an influence; perhaps some as-yet-to-be-discovered radiation, for example. What is nutty is rather the claim that the nature of the effect is reliably characterized by the earthly image to which in two dimensions an impossibly widely separated three-dimensional array of stars happen to conform—only for the moment!—and merely in someone's imagination.

Ideas of this sort strike most scientists as absurd beyond mention, but they have formed an important part of classical Jungian practice: Jung's daughter provided astrological charts for many new students at the C. G. Jung Institute in Zürich—not officially, to be sure, but wholly accepted; lectures on tarot and palm reading are unexceptional; divination via the I Ching has long held an especially esteemed place in classical Jungian practice. In his autobiography, Jung provides a number of examples where he would interpret an incidental event that occurred during a treatment session just as he would a dream reported by the patient—as when once a bird flew into the room. Synchronicity, in short, has never been a mere cognitive foible of classical Jungian therapy; it has been central to it.

But physicists (a minority, to be sure) of varying rank, from modest to the very best, find in “synchronicity” a rather startling analogy to certain bizarre features of quantum mechanics (e.g., “entanglement”), wherein two particles appear to function as though they were one, with an instantaneous orchestration of behavior between them, no matter how widely separated, and even backward in time: Neither causality nor physical interaction (e.g., forces) is involved. Out of early quantum hypotheses Einstein brilliantly drew such behavior as an inevitable consequence, hoping thereby to demonstrate their absurdity. But all subsequent experiments, over 80 years, have instead validated their reality. Physical reality as understood by the very foundations of physical science is exactly as Einstein said quantum mechanics describes it, a description he considered so absurd as to be its own self-evident impossibility proof. Yet so it is.

Marcus Fierz, an eminent Swiss physicist whose brother became a Jungian analyst and founder of the Jungian inpatient psychiatric facility Klinik am Zürichberg, assisted Jung with later corrections to the statistics

in Jung's astrology paper. The corrections erased any statistical significance in the supposed correlations between constellations and psychology. Between hard modern science that does indeed unveil a mysterious universal correlation among subatomic particles everywhere, and Jung's unsuccessful attempt to statistically correlate astronomical orbits with human fantasy, there is a huge gulf—which Jung dismissed.

Having found that a better statistical analysis nullified his hypothesis, he changed his hypothesis. Synchronistic relations occur within statistical fluctuations, he then claimed, not in excess of them as do causal associations. By contrast, the physical relations created by entanglement are detected precisely in their violation of classically expected statistical results. It may be plausibly argued, therefore, that however poetic the analogy between modern physics and a Jungian model of psyche, there is no real connection whatsoever. How is it then that so many eminently qualified scientists have taken Jung's ideas, amateur statistics and all, so seriously? Is there something about the Jungian theory of synchronicity that should perhaps not be dismissed out of hand?

The answer is a qualified "yes," and arises out of an aspect of Jungian theory and history that is often alluded to but has yet to be fully clarified: The personal relationship and collegial interchange between Jung and one of the very greatest of the founders of quantum mechanics—Wolfgang Pauli. Within their relationship Jungian theory, practice, and history unite.

In 1904, Einstein had been Jung's dinner guest: "These were very early days when Einstein was developing his first [i.e., special] theory of relativity..." Jung recalled. "I pumped him about his relativity theory. I am not gifted in mathematics. I went fourteen feet deep into the floor and felt quite small." Nonetheless, says Jung, "...it was he who first started me off thinking about a possible relativity of time as well as space, and their psychic conditionality."¹

Fifteen years later, in the early 1920s, Wolfgang Pauli was at work on the mathematics of "spin," a quantum phenomenon whose utter mysteriousness even today remains to be fully fathomed. Among other things, spin ensures that two identical particles with the same (half-integer) spin will tend to avoid each other—not via any force propagating at the speed of light, but by fiat, instantaneously, everywhere in the universe and probabilistically, as though orchestrated by some gentle

omnipotent conductor who merely urges—and who leaves no physical trace of his existence.

For electrons—the foundational instance of such a spin-bearing particle—these probabilities conform to the mathematical relations of three intersecting rings, rotating about three perpendicular axes with a common center, but with some twists: Each ring may rotate simultaneously in both possible (opposite) directions. By the laws of classical physics (including those in which Einstein firmly believed) such "superpositions" are completely impossible—like one object being in two places at the same time; and to return to its original position, a ring must complete two identical rotations (a fact that is beyond human visualization). But superpositions do, in fact, exist. Recently, objects large enough to be seen by the naked eye have been made to exist simultaneously in two places at once. And on the fact that two-rotations-equals-one depends every diagnostic MRI scan ever taken. Furthermore, the speed of rotation for each ring, in either direction, was quantized—it could assume only discrete values, like pulses or rhythms, giving spin values what we might call "clock-speeds," that in multielectron systems are determined by certain special powers and inverse powers of 2.

Pauli's initial success in 1924 delineating these relations would win him standing as one of the very greatest of the founders of quantum mechanics, the 1945 Nobel prize, and on that occasion an unsurpassed accolade by Einstein, who designated Pauli his "spiritual son" and successor as director of the Institute for Advanced Studies at Princeton.² The strange relations of spin—now termed the Pauli Exclusion Principle—are directly responsible for the current explosion of quantum technology, including such astounding feats as quantum teleportation, quantum computation, and the emerging field of "spintronics."

But even this understates the matter: "There is no one fact in the physical world which has a greater impact on the way things *are* than the Pauli Exclusion Principle. To this great Principle we credit the very existence of the hierarchy of matter ... which makes possible all of nuclear and atomic physics, chemistry, biology and the macroscopic world that we see" (theoretical particle physicists Ian Duck and E.C.G. Sudarshan).

¹ Before their estrangement, Freud had publicly deemed Jung his "spiritual son *and heir*." The infinitely nuanced, unfailingly courteous Einstein, friend to Freud, and knowing of the true relationship between Pauli and Jung, gave Pauli his love with no strings attached. Quantum theory was Einstein's permanent *bête noir*.

¹ Jung, C. G.: *Letters*, Vol. 2, p. 108.

But Pauli had also been wrestling with a profound twofold despair. In 1927 his mother poisoned herself after discovering that Pauli's father's was having an affair with a much younger sculptress whom he later married; and his scientific genius had early on led him to a deep estrangement from Catholicism. "I am baptized 'antimetaphysical,'" he wrote, "instead of Catholic." (To safeguard his rise in the professoriate at the University of Vienna in the 1890s, Pauli's Jewish father converted to Catholicism—much as today a conversion to leftism is *de rigueur*; near the end of his life Pauli seems to have made something of a return to his father's abandoned faith.) In May 1929 Pauli formally left the Catholic church and in December 1929 a beautiful and seductive cabaret performer married the lovesick physicist, even though he was her second choice. In 1930 she abruptly abandoned him and quickly married her first choice.

Pauli had by no means been happy with his 1924 formulation of spin, whatever his colleagues thought. "My nonsense is conjugate to the nonsense which has been customary so far," he wrote. Yet in 1927, the year that his mother killed herself, he fully satisfied himself with respect to spin, inventing the three famous "Pauli matrices," mathematical representations of the doubly valued quantum spin, one for each spatial axis. In anguish, regardless, Pauli drank heavily and provoked humiliating public quarrels until, at his father's urging, he consulted Jung.

Jung repeatedly claimed that he never "formally analyzed" Pauli because he found Pauli's natural psychological capacity so great ("He even invented active imagination for himself...") and because Jung was intent on studying and presenting Pauli's dreams as objective evidence for his theory of the collective unconscious, archetypes, individuation, the Self and the relationship of these to alchemy: "Now I am going to make an interesting experiment to get that material absolutely pure, without any influence from myself, and therefore I won't touch it," Jung stated. Instead, "[a]t the end of the year I am going to publish a selection from his first four hundred dreams, where I show the development of one motif only." Pauli was officially treated by Dr. Erna Rosenbaum who, since she was "a beginner," Jung "was absolutely sure she would not tamper."

Nonetheless, Jung supervised Rosenbaum's work and met weekly at noon with Pauli to discuss and interpret Pauli's dreams: "[H]e was doing the work all by himself," for 3 months, Jung says, but "for about 2 months, he had a number of interviews with me. ... I did not have to explain much."

In 1935, Jung discussed 400 of these dreams as the 1937 Terry Lectures in Psychology and Religion at Yale. They form the evidentiary backbone for all his volumes on alchemy. At Yale, Jung asserted that "the dreams I am going to relate ... represent an entirely uninfluenced natural sequence of events" and that in these dreams, his "well-educated intellectual" (and at the time anonymous) subject "worked out (among other matters) the problem of perpetual motion, not in a crazy way but in a symbolic way. He worked on all the problems which medieval philosophy was so keen on."

The climax of the series was not a dream, however, but a "visual impression" that "sums up all the allusions in the previous dreams." Jung called it "a turning point in the patient's psychological development ... in the language of religion—a conversion." The visual impression was (in Pauli's words, as quoted by Jung):

There is a vertical and a horizontal circle having a common center. This is the world clock. It is supported by the black bird. The vertical circle is a blue disc with a white border divided into $4 \times 8 = 32$ partitions. A pointer rotates upon it. The horizontal circle consists of 4 colors. On it stand 4 little men with pendulums, and round about it is laid the ring that was once dark and is now golden formerly carried by 40 children. The world clock has three rhythms or pulses. (1) The small pulse—the pointer on the blue vertical disc advances by $1/32$. (2) The middle pulse—one complete rotation of the pointer. At the same time the horizontal circle advances by $1/32$. (3) The great pulse—32 middle pulses are equal to one complete rotation of the golden ring.

Jung refers to this vision as the "perpetuum mobile," and provides 64 pages of world religious commentary on it, representing it as the spontaneous emergence of the Self. Thereafter, Jung says, Pauli "became a perfectly normal and reasonable person. He did not drink any more, he became completely adapted and in every respect normal. ... He had a new center of interest." In 1934, Pauli discontinued his sessions with Rosenbaum and married that same year, for life.

Never in his many discussions of this prototypical vision does Jung mention Pauli's successful matrix model of three quantized spin axes, which this visual impression obviously reproduces; nor the admix of feelings over his personal losses (the black ring turning golden once again; the blue and white motif that Jung related to Mary, the Mother of God in Catholicism, but not to Pauli's own lost mother). Indeed, the particular problem that the Pauli Exclusion Principle solved was how and why the first four "magic" numbers of the periodic

table arise: 2, 8, 18, and 32. Pauli was widely known to have continued his problematic drinking long after.

However weakened Jungian theory may be by the lack of evidence from one of its chief sources, and in spite of the fact that throughout their ensuing friendship Pauli made his own doubts clear about many of Jung's scientific claims, Pauli made no bones about his personal debt to Jung. He had wanted Jung to test "synchronicity" against the rigors of statistical evidence; Jung refused. When urged by colleagues not to damage his reputation by later copublishing a book with Jung, Pauli nonetheless insisted: "For there comes the time when I must give documentary evidence of what I owe this man."

IV. EMPIRICAL STUDIES

Only very recently has any attempt been made to assess the value of Jungian treatment with due consideration to the fundamentals of experimental design. Numerous presentations on outcome have been delivered at Jungian conferences by Dr. Seth Rubin of the Society for Psychotherapy Research, and the first peer-reviewed article was published in 2002 in the *Journal of Analytical Psychology*.

However, a German Jungian society has published on the web and in print an extensive, lengthy, and independently funded study with attempt at controls and a clear delineation of its own limitations and weaknesses. This study found that "Even after 5 years, ... improvement in the patients' state of health and attitude ... resulted in a measurable reduction of health insurance claims (work days lost due to sickness, hospitalisation days, doctor's visits and psychotropic drug intake) in a significant number of the patients treated ... [with] long-lasting effects on the patients' psychological well-being. [However], there are numerous major methodological problems with these data including the lack of comparison sample, the non-representativeness of the sample, the unreliability of pre-treatment data, the high rate of attrition, the need for multi-variate statistics, and uncertainty about the actual treatments offered."

V. SUMMARY

C. G. Jung has exerted an enormous and steadily growing influence on modern culture, especially as the "search for meaning" has taken on special urgency in light of the triumphs of scientific materialism. Transplanted via anal-

ogy from physics to psychology, the seminal ideas of the theoretical physicist Wolfgang Pauli profoundly influenced Jung's theory of the psyche. Although greatly helped by Jung the person, and deeply grateful to him, Pauli predicted what has in fact happened: That for an era bereft by science of religion, Jungian theory would ultimately prove more worthy as a philosophy than as a strictly scientific model of psychology.

Jungian therapy is therefore most distinct when aiming its therapeutics primarily at the development of a spiritual life. Its practitioners root themselves theoretically in a model they find personally congenial and that provides for them, as it were, a larger myth within which to lead a meaning-infused life. In practice, the evidence for and against the comparative efficacy of a specifically Jungian treatment method is no better than for any other method—or worse. Given the many different approaches that have arisen among the various Jungian schools—and within them—a good argument can be made that the parameters defining Jungian therapy will surely evade adequate denotation, but that individuals who identify themselves as Jungian therapists do as good a job on the whole as do those who do not. There is no doubt that many individuals deliberately seek Jungian therapy for what the term "Jungian" connotes and that Jungian therapists favor a style of communication that is comfortable for such individuals.

See Also the Following Articles

Adlerian Psychotherapy ■ Beck Therapy Approach ■ Behavior Therapy: Historical Perspective ■ Dreams, Use in Psychotherapy ■ Existential Psychotherapy ■ History of Psychotherapy ■ Gestalt Psychotherapy ■ Oedipus Complex ■ Psychoanalysis and Psychoanalytic Psychotherapy: Technique ■ Self-Psychology ■ Sullivan's Interpersonal Psychotherapy ■ Unconscious, The

Further Reading

Archive for Research in Archetypal Symbolism. (1991). *An encyclopedia of archetypal symbolism*. Boston: Shambhala.

Cook, D. A. G. (1987). Jung, Carl Gustav. In *The Oxford companion to the mind* pp. 403–405. Oxford: Oxford University Press.

Edinger, E. F. (1973). *Ego and archetype; individuation and the religious function of the psyche*. Baltimore, MD: Penguin Books.

Jacobi, J. S. (1984). *The psychology of C. G. Jung: An introduction with Jungian analysis*. Edited by M. Stein (Eds.); Introduction by J. Singer. Boulder, CL: Shambhala.

- Jung, C. G. (1989). *Memories, dreams, reflections*. Recorded and edited by A. Jaffé; translated from the German by R. and C. Winston. New York: Vintage Books.
- Jung, C. G. (1970). *Collected works. 1953–1961*. Princeton, NJ: Princeton University Press.
- Jung, C. G. (1973). *Letters*. (Selected and edited by G. Adler, in collaboration with A. Jaffe. Translations from the German by R. F. C. Hull.) Princeton, NJ: Princeton University Press.
- Jung, C. G. (1984). *Dream analysis: Notes of the seminar given in 1928–1930*. Princeton, NJ: Princeton University Press.
- Jung, C. G. (1996). *The psychology of Kundalini yoga: Notes of the seminar given in 1932 by C. G. Jung* Edited by S. Shamdasani. (Bollingen series; 99) Princeton, NJ: Princeton University Press.
- Meier, C. A. (1959). *Jung and analytical psychology*. Newton Centre, MA: Dept. of Psychology, Andover Newton Theological School.
- Meier, C. A. (1987). *The meaning and significance of dreams*. Boston: Sigo Press.
- Meier, C. A. (Carl Alfred). (1989). *Consciousness*. Boston: Sigo Press.
- Nagy, M. (1991). *Philosophical issues in the psychology of C. G. Jung*. Albany, NY: State University of New York Press.
- Neumann, E. (1972). *The great mother; an analysis of the archetype*. Translated from the German by R. Manheim. Princeton, NJ: Princeton University Press.
- Satinover, J. (1980). *Puer aeternus: The narcissistic relation to the self. Quadrant 13*, 2.
- Satinover, J. (1984). Jungian Psychotherapy. In M. Sacks, P. Rubinton, & W. Sledge (Eds.), *Core readings in psychiatry: An annotated guide to the literature* pp. 306–308. New York: Praeger.
- Satinover, J. (1986). Jung's lost contribution to the dilemma of narcissism. *Journal of the American Psychoanalytic Association*, 34, 401–438.
- Satinover, J. (1995). Psychopharmacology and Jungian analysis. In M. Stein (ed.), *Jungian analysis* (2nd ed.). Chicago: Open Court Press.
- Shelburne, W. A. (1988). *Mythos and logos in the thought of Carl Jung: The theory of the collective unconscious in scientific perspective*. Albany, NY: State University of New York Press.
- Smith, R. C. (1996). *The wounded Jung: Effects of Jung's relationships on his life and work*. Evanston, IL: Northwestern University Press.
- Steele, R. S. (1982). *Freud and Jung, conflicts of interpretation*. London; Boston: Routledge & K. Paul.
- Storr, A. (1981). Jung, Carl Gustav 1875–1961. In J. Wintle (Ed), *Makers of modern culture* pp. 258–260. New York: Facts on File.
- Ulanov, A. B. (1971). *The feminine in Jungian psychology and in Christian theology*. Evanston, IL: Northwestern University Press.
- Vincie, J. F. (1977). *C. G. Jung and analytical psychology: A comprehensive bibliography*. New York: Garland.
- The wisdom of the dream [videorecording]: Carl Gustav Jung* [Wilmette, IL]: Public Media Video, c1989. v. 1. A Life of dreams (53 min.); v. 2. Inheritance of dreams (53 min.); v. 3. A world of dreams (53 min.)



Language in Psychotherapy

W. Rand Walker

University of Idaho, Moscow

- I. Introduction
 - II. Evolution of Therapeutic Language
 - III. Therapeutic Communication
 - IV. Language and the Therapeutic Relationship
 - V. Summary
- Further Reading

GLOSSARY

bridging Language that associates current thoughts and feelings with historical events or previous experiences. For example, “Is this a familiar feeling?” and “You said when she yelled at you the thought ‘I am such a loser’ popped into your head. Is that a new thought or is it a familiar one?”

clarification Clarifications are questions (or statements with the inflection of a question) that serve to confirm the perspective of the client. During instances when the client is vague, clarifications are used to encourage more description or explanation in order to bring clarity to the session. Importantly, a clarification can also be a way to convey an understanding of the client’s situation or perspective.

confrontation Noticing, and bringing the client’s attention to, events, behaviors, or content that are inconsistent with the goal of progress or change. Mixed messages, aloof behavior, and inconsistent remarks are examples of content that are typically confronted.

counterassumptive A counterassumptive statement is used to manage the working distance between the client and therapist. It targets the assumption of the client and counters it without arguing with the client. For example, when the client says “tell me what I should do” the therapist can respond with a counterassumptive instead of arguing or

fusing the client’s request (“It isn’t obvious to me either ... I wish I knew”).

description There is an important distinction between inference and description. Describing behavior is generally less threatening than inferring something from the client’s behavior. “It doesn’t look like you like your kids” is an inference and “when you talk about your kids your face becomes more constricted and strained” is a description.

dichotomous questions Presenting a choice between two statements is a dichotomous question. “What feels more true to you ... that you are angry or that you are afraid?”

edification Educating the client is an essential variable in the change process. Explanations regarding the etiology and causes of various problems, imparting treatment options, developing new skills, and Socratic discussions, are all examples of edification in counseling.

exclamations Exclamations are used to convey an active empathic stance. “Wow!,” “How awful!,” and “Outstanding!” are expressions that either convey an understanding regarding the intensity of a given situation, or welcome clients to experience something they are currently holding at an emotional distance.

extensions When clients constrict content and have difficulty acknowledging what might be obvious emotional dimensions of their life experience, the therapist can take an active empathic stance and state it for the client. This very delicate and advanced skill is used as an invitation to delve further into emotional content. For example, the client says “I am lonely” and when there is a reasonable amount of certainty, the therapist can use an extension “and it has been this way for a long time.”

horizontal questions Horizontal questions are used when the therapist wants the focus to stay on the emotional and

relational aspects of a client's experience. When the client makes a sensitive and personal self-disclosure, the therapist can respond either vertically (which focuses on the informational level of content) or can respond horizontally. "Now that you have told me this, what are you thinking?" or "What was happening right before you told me this?" are examples of horizontal questions.

imperatives A statement that elicits a specified action. "Tell me what you're thinking" or "Say the first thing that comes to mind when I say 'airplane'."

interpretations An interpretation is a well-timed and carefully constructed explanation of the client's experience, disorder, or interpersonal context. In most instances, this is where the theory of the therapist emerges. The primary difference between an interpretation and a clarification is that the interpretation introduces a new perspective to the client (it is the therapist's perspective).

minimal encourager These are sounds and statements that encourage the client to continue in a monologue. "Mmm," "uh huh," and "ooh" are examples of minimal encouragers designed to keep the process going without undue interference.

open-ended question A question that cannot be answered with a "yes or no" or single word response. "What did you do on your vacation?" as opposed to "Did you have a nice vacation?"

paraphrasing Putting the client's description into different words as a means of conveying an understanding of the client's thoughts and experiences.

performatives Statements that are also actions. "I do" in a wedding binds the individual in a commitment, a compliment like "That looks nice" has the effect of making the recipient feel good, or the therapist saying "I have confidence in your ability to handle this" is intended to instill a sense of self-efficacy.

probes These are statements and questions designed to elicit more information regarding a specific area of content. "I'm thinking you must have had a good reason to start drinking again after all the things you have been through" is a probing statement and "Why did you start drinking again?" is a probing question.

reflection Rephrasing or restating the emotional or affective part of the client's statement. Many therapists rely on reflections as a way of expressing empathy and acceptance of the client.

reflexive questions Posing questions that put the client in a position to consider new perspectives or alternatives. Reflexive questions start off with statements like "What would happen if..." and "Let's say you were assertive with your boss, what would you expect to happen?"

strategic questions Tactful use of strategic questions is an option when the therapist observes the need for more direct challenges. Strategic questions are often corrective and imply a desired outcome. "What keeps you from doing your own grocery shopping at this point?" and "Something

stops you from speaking out about this to your boss (with the inflection of a question)" are examples of strategic questions.

summarizing Rephrasing the client's utterance as a means of clarifying and conveying an understanding of the client's disclosure.

verdictives These are performative statements that serve as verdict or implicit declaration. "I think you can handle this" or "It is necessary to deal with this" are verdictives.

vertical questions Interviewing often requires a number of questions regarding the client's history, family structure, educational background, and other facets of the individual's personal life. Vertical questions are designed to elicit information and logical details. When a client discloses something very personal, the therapist can either address the informational aspects of the disclosure (via vertical questions like "How long?" and "When?") or can focus on the emotional and personal aspects of the revelation (see horizontal questions).

I. INTRODUCTION

Throughout this encyclopedia, there are descriptions of specific psychological theories and novel techniques of therapy that set various orientations apart. In spite of numerous differences expressed by the respective denominations in psychotherapy, there is one common element that very few would dispute; the essential use of language as a mechanism of change. In the short time psychotherapy has existed, the field has evolved into a craft with its own language, conversational rules, and social structure. Although the process of therapy is more than word selection and phrasing, there is a growing accumulation of verbal strategies designed to assist the therapist through a number of situations and contexts. This article is a review of the actual verbal "tools of the trade" that serve as the staple of most therapeutic approaches.

II. EVOLUTION OF THERAPEUTIC LANGUAGE

The systematic use of conversation for therapeutic purposes is not a new concept. As far back as Hellenic Greece, rhetoricians were employed to challenge the logical errors of melancholic "patients" in order to effect a more positive outlook on life and to find solutions to problems. The Greek formulation of mental processes paved the way for the use of persuasion, motivational conversations, and encouragement, as a healing form.

In spite of the historical dominance of mystical and spiritual formulations of human suffering, it is clear that very few “lost faith” in the use of a confidential and abiding relationship to produce behavioral changes or to render assistance to those who needed it. Even the priests of the middle ages were purveyors of a healing conversation in the form of confession. This sacramental ritual included many facets of modern psychotherapy. A confidential setting, self-disclosure, focus on behavior change, and a redemptive relationship are all elements in common with the secular practice of psychotherapy. It was not until the “age of enlightenment” that the intellectual formulations of mental illness and human suffering returned to mainstream Western thought. As the ideas and attitudes shifted away from the more mystical views of mental disturbance, the medical field advanced concepts that served as the precursors to psychotherapy as we know it today. Importantly, the more humane and optimistic views posited by Tuke, in Great Britain, and Rush, in the United States, encouraged treatments based on rational and scientific formulations of mental illness and set the tone for the next century.

A culmination of theoretical contributions led to the ultimate invention of psychotherapy; however, psychoanalysis was the first type of therapeutic conversation to emerge as a discipline. By the time of Freud’s death in 1939, psychoanalysis had developed an assortment of well-defined pragmatic verbal strategies. The verbal activity of the contemporary analyst is largely centered around the sequence of free associating, confronting, clarifying, interpreting, and “working through” material as it emerges in the session. In essence, the psychoanalyst’s artful use of language creates a process of unencumbered exploration while striking a delicate balance between defensive self-preservation and a desire to access the troubling source of the individual’s problem or neurosis. With a strict sense of restraint and economy, the analyst uses a series of prompts and other linguistic devices of language to accumulate enough data or material to form an interpretation. In many ways, it is initially a process of collecting pieces to a puzzle and then it proceeds to an interpretation, at which point the therapist actually attempts to put the pieces together. The interpretation brings to light connections that were, at one time, outside of the individual’s awareness. With each insight, the individual is equipped to reallocate psychological resources previously dedicated to the unresolved intrapsychic conflict. Freud described the process as two travelers on a train with one looking out the window and describing what

is on the landscape and providing details about the scenery. The other traveler is blindfolded, but is able to explain details and impart meaningful information regarding the countryside as they pass through. This one-sided and slow deliberation was unprecedented in terms of a social structure and seminal with regard to the development of therapeutic language.

The psychoanalytic approach to treating psychological and emotional problems was a dramatic departure from the “bootstrapping” and “advice giving” mores of the time. Society began to accept the notion that emotional suffering and mental illness was often too complex to resolve with simplistic solutions. Along with the changes in attitude came a rapid succession of new therapies, as well as more lively debates about what “active ingredients” of therapy make it effective.

Although psychoanalysis solidified the presence of the “talking cure” in the twentieth century, a proliferation of therapeutic approaches would lead to an expansion of ideas regarding therapeutic language. There was a notable transition from the “free floating” and nonintrusive stance of the psychoanalyst to a more active and broadly applied use of the therapeutic relationship. A new taxonomy of language developed around a number of core concepts in psychotherapy that included a collection of therapist behaviors and types of utterances. Therapeutic orientations began to offer ideas regarding language usage and presented techniques that were based on their respective theories of change. Whether it be insight, a corrective emotional experience, or an in-depth exploration of an important aspect of the client’s life experience, clinicians and theorists were discovering how to make these types of conversations occur.

The new faces of therapy expanded well beyond the original constraints imposed by “psychodynamic” theory. Albert Ellis broke through the vales of neutral distance with his often blunt and usually directive approach to dialogue in his rational emotive therapy (now rational emotive behavior therapy). Conversely, Carl Rogers placed considerable importance on a nonjudgmental and supportive collaboration in his person-centered therapy. Mirroring techniques, passive empathic statements, and an emphasis on genuine dialogue, are all activities advanced by Rogers as “facilitative” therapist behaviors. Fritz Perls demonstrated a number of creative strategies that intensified the emotional experience in therapy, including cathartic techniques such as the “empty chair” where the client engages in a role-played conversation with an imagined person. Aaron T. Beck and his colleagues established a

method of “collaborative empiricism” in his cognitive therapy approach. His method included the use of the Socratic method, engaging the client in a scientific inquiry using questions, and persuasive challenges to problematic thought processes and perceptions. The interpersonal theorist Harry Stack Sullivan attended scrupulously to the impact of his wording and phrasing on his patients and lectured extensively on the importance of deliberate syntax. His well-regarded work on interviewing and therapeutic processes articulated minute differences between well-constructed therapist statements and poorly constructed ones. Milton Erickson was widely known for his creative use of language and his effective use of metaphors. The full spectrum of contributions to therapeutic language is a vast and voluminous subject; however, it is clear that developments in therapeutic language have come from a multitude of sources. Close examination of the various techniques and approaches reveal a field that is willing to integrate new ideas and to learn from one another. The rapid growth of “integrative” and “eclectic” therapeutic movements is testimony to the widespread recognition of the need for the creative application of a variety of tools, rather than strict adherence to a narrow and dogmatic view of change.

III. THERAPEUTIC COMMUNICATION

The cornerstone of most therapeutic approaches centers on the mutual participation in a special type of conversation, a conversation that is implicitly different from everyday discourse and that is unique in terms of structure and content. The “way” the therapist phrases something, the timing of a given response, even the selection of words, have become a recognizable form of social interaction. The cliché “How does that make you feel?” may be the best known of the therapist’s staples; however, the skilled therapist is capable of applying many more proprietary tools of the trade to help the client. Historically, it is clear that the development of therapeutic approaches was largely dependent on recognizing what worked in different situations. The remainder of this article focuses on the actual verbal behavior of the therapist, how language changes within different contexts of the process, and what the therapist hopes to achieve with different types of verbal responses.

Much of what we know about language in psychotherapy comes from the field of “process research.” Studies of the actual behavior as well as *in vivo* observa-

tions of different forms of therapeutic communication have resulted in a reliable taxonomy of words and behavior that are unique to psychotherapy relative to everyday conversation. The seminal research of Clara Hill, William Stiles, Sol Garfield, Kenneth Howard, Carl Rogers, Larry Beutler, Leslie Greenberg, Michael Patton, Robert Russell, Hans Strupp, David Orlinsky, and numerous others, elevated the level of description from vague and theoretically laden inferences, to measurable entities. The content and scope of process research attends to complex variables within the session such as therapist intentions, types of utterances or “verbal response modes,” probabilities of therapist responses within different contexts, conversation analysis, semantics, “good moments,” and other interpersonal variables related to positive outcomes. The collective findings of this type of research have had a direct influence on the therapeutic terminology, the validity of outcome studies that use process measures to assess treatment integrity, and training. The glossary provides an overview of therapist statements, as well as the typical contexts in which they are used. Ultimately, these tools make it possible to engage the client in a conversation that is markedly different from other forms of social support, help, or advisement.

The fields of anthropology and “conversation analysis” observe that in most interpersonal contexts and cultures, verbal interactions fall into fixed patterns that are predictable and orderly. When people abide by these social tenets, it contributes to a sense of cooperation, safety, and compatibility. Even minor infractions of these rules can lead to anxiety, perceived disturbance, interpersonal distance, conflict, or the interpretation of rudeness. For example, a self-disclosure of emotional pain or suffering will typically lead to consolation, commiseration, or supportive comments. Beyond that point, however, intuitive signals cause one or both speakers to change the topic away from the delicate subject matter and on to a subject that is not so sensitive. Subsequently, a concern about intrusiveness or a fear of intensifying the person’s emotional pain can effectively thwart a therapeutic conversation. Conversely, it is understood, even expected, that the collaborative relationship between the client and the therapist is in effect to talk about things that are difficult to share and to address issues beyond the normal scope of everyday conversation. Therapists develop the ability to depart from the social restrictions that limit the course and depth of everyday conversation with implicit permission to abandon conventional patterns of conversation in order to engage the client in a

unique and constructive process. Probing questions, long silences, interpretations, *in vivo* descriptions of behavior, and clarifications, are but a few verbal events that are rarely observed in most other interpersonal contexts. This relatively new type of dialogue employs a variety of illocutionary strategies in order to promote positive movement in the therapy process. Therapists-in-training learn to use a variety of verbal strategies that have known effects on the direction of the session and that are introduced as a means of meeting identified therapeutic goals. Specific roles are adopted (e.g., teacher, redemptive listener, a guide through the healing process, motivational speaker, and persuader) to engage the client in different types of therapeutic interactions. In whatever the context, the skilled therapist relies on the systematic use of language to ensure the best chance of a positive outcome.

The appropriateness and quality of any therapeutic response is dependent on the situation at hand. Although there are over 400 identified "orientations" of psychotherapy, the conversation of therapy is fairly uniform when considering context. There is an initial greeting, then a brief gathering of information, a subsequent exploration or delving into more detail, and then a "winding down" period. Each session follows a general trend and provides a "frame" that guides the therapist's responses. Take, for instance, the statement "I feel bad." Again, the type of therapist response will depend significantly on when or in what context the statement was made. If it occurs early in the session, the therapist may ask questions, or direct the client to elaborate, as a means of establishing a focus, or to determine the context of the client's reported experience (e.g., "Tell me what has been happening" or "What has happened since our last session?"). The same statement, "I feel bad", elicits a different set of therapeutic responses when it occurs further into the therapeutic hour. It is notable that most of the "treatment"-oriented techniques occur during this part of the therapy session. It is not unusual for the therapist to use techniques to intensify the client's emotional experience or engage the client into a deeper exploration of content. Therapist empathy becomes more finely tuned and is accompanied by a due amount of encouragement, even pressure, to work through difficult material. Clients are sometimes guided through a courageous process of facing dreaded material, conquering personal demons, and are systematically exposed to fears and stimuli that provoke escape and avoidance. When the client says, "I feel bad" toward the end of the session, the constraints of time affect the therapist's response. The same disclo-

sure might require attention to coping strategies that the client can use between sessions (e.g., "What do you expect to happen to this feeling later today? or "Do you think it would be helpful to go over some of the coping strategies we have discussed previously to get us through the week?"). The therapist will also summarize the session with relevant information, new insights, or present an objective view of the possibilities in the future. It follows then, that the quality of any given response depends significantly on the context in which it occurs.

The therapist is also mindful of "timing" a statement or question appropriately and is poised to respond to opportunities for positive movement. When to exert pressure and when to back off, is an hourly challenge that is largely determined by the readiness and competence of the client. Premature exploration often leads to flight responses or other types of resistance such as restricting content, dominating the session, attempts to change the therapeutic arrangement, and emotional withdrawal. An absence of exertion or movement can lead to meandering and even apathy. In both cases, there is a risk of a negative effect. One poignant example of this comes from an intake conducted by a seasoned psychologist working with a woman struggling to bond with her adopted child. She reported feeling repulsed by her new son's attempts to be close to her. At one point during a description of her son, she displayed a look of disgust and made a gesture that signified "go away." After observing the intensity of her emotion, the psychologist asked, "Is this a familiar feeling?" It did not take long to realize that the question thrust her into a dissociative state. Her history of abuse had yet to be disclosed to anyone and they scrambled for 2 hours using standard grounding techniques to get back to the "here and now." Although this kind of "bridging" question was not a bad one, the timing was clearly premature. If the same question occurred several sessions later, it may have resulted in a more fruitful outcome. Thus, it is not simply what the therapist says that makes a difference, it is also what the therapist chooses not to say. At any given moment, the therapist is considering options, restraining his or her own impulses, and choosing one response over another, based on what has the best chance of leading the conversation in a direction that will help the client.

For better or worse, each utterance has the potential of affecting the course and experience of the conversation. The study of pragmatics examines the interpersonal effect of phrasing and syntax. Each statement has a probability of influencing the direction and nature of

the subsequent utterance. When the therapist makes a statement or asks a question, it is often “goal-directed” and made with specific intentions. For instance, if therapists believe that creating a “here-and-now” experience is important to therapeutic success, then they will ask questions differently than if they are interested in gathering basic information. Instead of the therapist asking “So what was it like in your house growing up?” the therapist might set up the question with a present tense like “It is 6 o’clock in the evening at your house when you were growing up ... what is happening around you?” This type of phrasing is more likely to be “experienced” than the past tense questioning.

Depending on the goal of a given session, the therapist will pose questions and initiate dialogue with a fair amount of attention to probability. Starting the session with “O.K., where is a good place to start today?” produces a different direction or set of responses than “So tell me about your week.” An even more predictable outcome can be generated with a statement like “Last time we were talking about your relationship with your brother and how he was the prized son.” In each case, the therapist uses language to shape the course and emotional depth of the session.

Mindful of the multiple layers of therapeutic communication and the known effects of certain types of statements, the therapist mentally juggles a variety of options and then selects a response according to the immediate goals of the session. An example of how the therapist considers the probable effect of one type of utterance versus another is observable in instances when the client discloses a closely guarded secret. After the disclosure, the therapist can ask “vertical” questions designed to generate information about the historical and factual aspects of the secret. “How long ago did this happen?” or “What makes you think that?” are examples of vertical questions. However, the skilled therapist might decide to prioritize strengthening the therapeutic relationship over gathering information. In this event, the therapist could ask a “horizontal” question such as “What was it like to say that?” or “Tell me what you were thinking before you told me this.” Horizontal dialogue changes the focus from the content of the disclosure to the client’s experience of therapeutic relationship. When a delusional patient discloses a fear of an “FBI plot” to assassinate him, the therapist can respond with at least two routes of exploration. It is tempting to assess and treat the delusion or psychosis; however, the seasoned therapist recognizes the tenuous nature of the therapeutic relationship with this type of problem. Subsequently, since the notion of an FBI plot

is frightening to the patient, empathic language and supportive comments are appropriate responses. “Approximating” statements make it possible to express an understanding of the fear without endorsing the belief. “If I were convinced the FBI intended to kill me it would be very frightening and I wouldn’t know who to trust” is different than “If I were in your shoes I would be very frightened.” The therapist will attempt to side with the fear and express an understanding of the experience before attempting to confront the delusion. When it is time to confront the delusion directly, it is prudent to phrase the probe in a manner that elicits a description, rather than a belief. “What are you seeing that convinces you that this is happening?” leads to a description of external events and “Why do you think this is happening” generates a response depicting thought processes and theories. Therefore, the therapist can minimize problematic exchanges and lower the chances of exacerbating the patient’s delusion with carefully crafted phrasing.

Countless situations are navigated and managed with the deliberate use of language. Although there is not a “right way” to respond to every situation, there are responses that have better probabilities of success than others.

IV. LANGUAGE AND THE THERAPEUTIC RELATIONSHIP

The therapist is also monitoring the quality and strength of the therapeutic relationship. Freud was the first to recognize the intense bond that forms when two individuals embark on the therapeutic journey and others have concluded that this is one of the most critical dimensions to successful therapy. It is necessary to establish intimacy and trust before the therapist employs any deep probes or challenges. In order to keep the focus on the client it is necessary to discard the most common means of achieving interpersonal intimacy, namely two-sided self-disclosure. When people pursue personal relationships, they willingly collaborate in a “do as I do” process that is proportional and rhythmic. When we meet someone for the first time, we often attempt to achieve a level of intimacy and comfort by beginning a search for things in common. “Where are you from?” “Where did you attend college?” and “What do you do for fun?” are questions that lead to a point of excitement when people find a mutual domain of experience or interest (i.e., “Me too!” or “Oh really, I have a friend at that university. Perhaps you know her...”).

With emotionally and deeply personal information the implications of disclosure are more threatening. As the layers of self-protection peel away, there is a lingering state of vulnerability until the other responds with either an affirmation or a similar unveiling of personal content. Intimacy in psychotherapy is different. Client disclosures are met with expressions of understanding, empathy, and prompts to continue rather than reciprocal self-disclosures. Empathic sounds (e.g., “uh huh,” “hmmm,” and “oh”) and positive nonverbal gestures serve to encourage, even invite the client to discuss sensitive material if it is needed.

The seminal work of Carl Rogers emphasized the importance of creating a strong alliance between the therapist and client. To be in “sync” with clients and to reflect an understanding of their experience is a necessary condition of therapy. Conveying a genuine interest in the individual, as well as making an effort to understand the client’s emotional experience, or empathy, is the cornerstone of a functional therapeutic relationship. Upon disclosing the horror of a traumatic event, the client sees and hears indications of empathy and a human response. A grimace or the sound of a quiet gasp serves to encourage, even prompt the client into further exploration. Rogers emphasized the nonintrusive and tentative stance of “passive empathy” as a means of establishing a safe and “facilitative” environment. Although the therapist is encouraged to monitor (and even express) his or her own personal reactions within the therapeutic process, there is a clear separation between the therapist’s experience and the client’s reported experience. Instead of “me too” statements, the therapist attempts to acknowledge and validate the client’s view of the world. Once the therapist is confident about the level of “intersubjectivity” or degree of shared knowledge, the therapist can tread carefully into the client’s space. Sometimes it is a matter of expressing or conveying an “experience of the client’s experience,” but also verbalizing thoughts and feelings that the client is reluctant to admit. Therapy is brimming with opportunities for this type of connection. For example, as an exhausted and anxious single mother describes all of the activities and obligations that she encounters on a daily basis, the therapist can use a passive empathic statement such as, “That must be overwhelming” or he or she can choose an active empathic statement such as, “Wow, when I think of doing all of that I feel overwhelmed.” In either case, the therapist uses empathy to fortify the therapeutic alliance and create a safe place for therapy to occur.

The therapeutic relationship is also subject to periods when it shifts into altered states. During the course

of therapy, Freud noted that patients would develop a distorted view of the patient–analyst relationship. Frequently, the patient would transfer thoughts and feelings associated with parental figures to the analyst. It became evident to Freud that this phenomenon, which he labeled “transference,” was an opportunity to work through unresolved conflicts of the patient’s childhood. Harry Stack Sullivan expanded on the notion of transference with his concept of “parataxis,” which included feelings about people in general rather than just parental figures. Nonetheless, when these feelings emerge in the therapy session it presents some opportunities for positive movement. The therapeutic dyad can serve as a microcosm of other relationships and facilitate an opportunity to work through pervasive issues that exist in the individual’s social milieu.

Hostility, seductiveness, submissiveness, and dominance are all examples of behavior addressed in the safety of the therapeutic environment. In these cases, the therapist must establish and manage a “working distance.” In his book *Making Contact*, Harvard psychiatrist Lesten Havens describes working distance as “being alone together” in a state of “noninvasive closeness.” The instincts of the client might compel him or her to submit too readily to the will of the therapist, rebel against the therapeutic process, or to take over the process with his or her own preferred form of dominance. Language moderates imbalances created by these polar movements and prevents the therapist from colluding with the client’s attempt to derail threatening but constructive movement. The seductive client may attempt to draw the therapist out of a neutral stance by appealing to the personal needs of the therapist. After disclosing in provocative detail, a sexual dream about the therapist and then conveying current sexual feelings, the therapist is saddled with the task of redirecting the focus without rejecting the client. When the client moves toward the therapist in this way, the use of horizontal questions such as “What is it like to tell me about these feelings?” can create an objective moment. A statement such as “It says a lot about the trust we have established that you are able to talk about this with me. You can speak openly about these feelings and know, with confidence that I will not betray you by changing our relationship in that way” is a “performative” (see glossary) statement that declares the status of the relationship. If the client exhibits embarrassment or regret, a counterassumptive statement such as “One thing I will ask is that the next time you have a dream like that about me could you give me a full head of hair and rippling stomach muscles?” This statement counters the assumption that

the client did something wrong by disclosing the dream, but also reaffirms the safety of the therapeutic setting.

Managing the working distance involves keeping a perspective and thinking of these events in terms of data instead of personal dilemmas. Harry Stack Sullivan referred to a state of mind called “participant observer.” Like the ethnographic researcher, the therapist is both experiencing and studying the situation. Instead of treating challenging situations as a problem, the therapist observes the behavior and assesses the degree to which the behavior is likely to be a problem in the individual’s daily life. Using the example of the seductive client, rather than thinking about how appealing the therapist must be to elicit such feelings, the therapist considers the possibility that this behavior is a maladaptive response to psychological intimacy. The socially anxious client sometimes projects hostility or aloofness as a way of creating a safe distance from people whom they perceive as a threat. The therapist subdues the initial experience of rejection and, again observes the behavior as important data. By use of description, as well as carefully constructed questions, it is possible to capitalize on the emergence of the behavior and offer an opportunity that literally does not exist in any other setting. The therapist can offer “objective” feedback about potentially problematic behavior without an obligation to apologize or repair the relationship.

In addition to dealing with the challenges of direct “focal messages” or the literal content of any given utterance, there are “metamessages” that are equally important. Metamessages are the implicit messages that are not typically acknowledged as a message, but have a profound impact on the conversation nonetheless. If, for instance, a client pleads to the therapist “Just tell me what to do” the therapist has a few options. One common response to this type of plea is to refuse the request with an explanation. “It wouldn’t be appropriate for me to tell you what to do in this case” or “This is your life and I think you are in the best position to make a decision of this importance.” The focal messages in this case are “no” and “It isn’t a good idea to tell you what to do.” However, one of the metamessages might be perceived as “I am withholding my advice” and “I probably do have the answers but it is against the rules to tell you.” In spite of the reasonable focal content, these metamessages could result in resistance, problems in the therapeutic alliance, and unnecessary arguments. One way to counter this

metamessage would be to use a statement such as “I wish I knew what the right way to handle this would be . . . it is not obvious to me either” (which is a “counterassumptive” statement). This response counters the assumption that the therapist knows what is best for the client and, for whatever reason, chooses to keep from the client, and sends another message acknowledging the complexity and difficulty of the client’s situation.

V. SUMMARY

Psychotherapy resides in our culture as a widely accepted and specialized form of communication. The psychotherapist shapes the process by using a unique combination of verbal tools and well-placed responses to the client. Importantly, statements are selected on the basis of the known effects of specific devices or techniques, and are utilized as a means of meeting an identified therapeutic goal. The therapist adopts specific roles such as teacher, redemptive listener, a guide through the healing process, motivational speaker, and persuader, and engages the client in different types of therapeutic interactions. In whatever the context, the skilled therapist relies on a deliberate use of language to ensure the best chance of a positive outcome.

See Also the Following Articles

Acceptance and Commitment Therapy ■ Communication Skills Training ■ Confrontation ■ Functional Communication Training ■ History of Psychotherapy ■ Interpersonal Psychotherapy ■ Rational Emotive Behavior Therapy ■ Sullivan’s Interpersonal Psychotherapy ■ Working Alliance

Further Reading

Havens, L. (1986). *Making contact: Uses of language in psychotherapy*. Cambridge, MA: Harvard University Press.

Nofsinger, R. E. (1991). *Everyday conversation*. Newbury Park, CA: Sage.

Schegloff, E. A. (1984). On some questions and ambiguities in conversation. In J. M. Atkinson & J. Heritage (Eds.), *Structure of social action: Studies in conversation analysis* (pp. 28–52). Cambridge, MA: Cambridge University Press.

Stiles, W. B. (1992). *Describing talk*. Newbury Park, CA: Sage.

Wachtel, P. L. (1993). *Therapeutic communication: Principles and effective practice*. New York: Guilford Press.

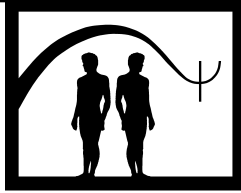

Legal Dimensions of Psychotherapy

Howard Zonana

Yale University and Connecticut Mental Health Center

- I. Confidentiality and Privilege
 - II. Access to One's Own Medical Records
 - III. "Duties to Third Parties" or When Can Victims of a Patient's Violent Behavior Hold the Psychotherapist Accountable?
 - IV. Federal Law and Regulations Regarding Confidentiality
 - V. Boundary Violations: Psychotherapist–Patient Sexual Contact
- Further Reading

GLOSSARY

adjudicate Refers to the process whereby differences and conflicts within the justice system are heard and settled.

confidentiality The right of a patient to have any information or communications made during the course of treatment and evaluation to be held in strict confidence unless authorized to be divulged.

due process The process whereby the rights of parties in a conflict are assiduously protected in the settlement of that conflict. Due process generally entails the opportunity to know and examine one's accusers and the chance to present one's own case in defense of an accusation.

HIPAA Health Insurance Portability and Accountability Act of 1996, which is federal law intended to rectify a variety of conflicting state laws concerning health related issues. It has stringent confidentiality protections.

privilege Refers to disclosures made in court or for legal reasons and is an exception to the general rule of evidence of the justice system, in which every member or party to a conflict has a right to every other person's evidence.

There are both ethical and legal underpinnings to the confidential relationship between a psychotherapist and a patient. Confidentiality here refers to the right of a patient to have communications, made during the course of evaluation or treatment, held confidential absent express or implied authorization. Although confidentiality is not absolute, and may vary with the professional qualifications of the therapist, it remains a core value for mental health professionals and patients.

A variety of professionals may fulfill the role of psychotherapist. Physicians specializing in psychiatry and psychoanalysis have the ability to prescribe medication for their patients in addition to performing psychotherapy in its varied forms. Clinical psychologists with master's or doctorate degrees have special training in administering and interpreting psychological testing as well as clinical training in psychotherapy. Other licensed professionals who conduct psychotherapy are social workers and nurses with master's or doctorate degrees. In addition there are marital and family counselors and the clergy.

Psychotherapy involves disclosures of the most personal nature, including wishes, fears, dreams, fantasies as well as detailed disclosures regarding one's personal, educational, legal, employment, social, sexual, and family history. This information is important, not just for the isolated facts and psychological symptoms, but also to learn how the person deals with stress and conducts personal and intimate relationships. This data is needed for accurate assessment and diagnosis, as well

as treatment. The style and process by which the information is disclosed by the patient/client is also revealing of personality traits and cognitive styles of dealing with the inevitable stresses of daily life. It is not uncommon for a psychotherapist to be the recipient of information that has never been shared by the patient with anyone else. Unless there is some assurance of confidentiality, it is unlikely that individuals would be as open or free about making disclosures, especially as there remains a significant stigma associated with mental disorders and their treatment.

I. CONFIDENTIALITY AND PRIVILEGE

Confidentiality protections are derived from a variety of sources. The oldest derives from professional and ethical codes. Since the fourth century BCE, the Hippocratic Oath has required that physicians respect the confidentiality of patient communications:

And whatsoever I shall see or hear in the course of my profession, as well as outside my profession, in my intercourse with men, if it be what should not be published abroad, I will never divulge, holding such things to be holy secret.

Professional organizations, such as the American Medical Association (AMA), since early in its history, have been concerned with the importance of confidentiality. The current code of medical ethics has a section on confidentiality:

The information disclosed to a physician during the course of the relationship between physician and patient is confidential to the greatest possible degree. The patient should feel free to make a full disclosure of information to the physician in order that the physician may most effectively provide needed services. The patient should be able to make this disclosure with the knowledge that the physician will respect the confidential nature of that communication. The physician should not reveal confidential communications or information without the express consent of the patient unless required to do so by law.

The American Psychiatric Association (APA) publishes for its members *The Principles of Medical Ethics* with special "Annotations Especially Applicable to Psychiatry." Members are required to follow the basic AMA principles as well as the APA Annotations. The APA

principles state that psychiatrists must "respect the rights of patients, colleagues, and other health professionals, and that they must safeguard patient confidences within the constraints of the law." The guidelines on confidentiality also tell psychiatrists that they "may release confidential information only with the authorization of the patient or under proper legal compulsion. The continuing duty of the psychiatrist to protect the patient includes fully apprising him/her of the connotations of waiving the privilege of privacy." Other therapists are also bound by ethical codes to keep information within the therapeutic relationship confidential. The American Psychological Association, in its *Ethical Principles of Psychologists and Code of Conduct*, informs therapists that "safeguarding information about an individual that has been obtained by the psychologists in the course of his teaching, practice, or investigation is a primary obligation of the psychologist." The National Association of Social Workers (NASW) also has a code of ethics with an elaborate confidentiality section. Section 1.07c states in part

Social workers should protect the confidentiality of all information obtained in the course of professional service, except for compelling professional reasons. The general expectation that social workers will keep information confidential does not apply when disclosure is necessary to prevent serious, foreseeable, and imminent harm to a client or other identifiable person.

All clients must be informed by the social worker of the limits of confidentiality in a given situation. The American Counseling Association requires its members to adhere to a code of ethics that has a full section on confidentiality. Counselors must respect their clients right to privacy and avoid illegal and unwarranted disclosures of confidential information.

The concepts of confidentiality and privilege are related but separate. Privilege laws, strictly speaking, only relate to disclosures made in court whereas confidentiality statutes govern therapist's obligations outside the courtroom. Privilege is an exception to the general rule that the justice system has a right to every person's evidence. Confidentiality is both an ethical and legal duty that protects a patient from unauthorized disclosures of protected information. At this point all states and the federal courts recognize important confidentiality and privilege protections in the psychotherapist-patient relationship. At the same time statutes and courts have created numerous exceptions to the confidentiality/privilege rights.

By far the most influential rationale for recent privilege law is the traditional justification enunciated by Dean Wigmore. Essentially utilitarian in nature, this justification asserts that communications should be privileged only if the benefit derived from protecting the relationship is important enough to society that it outweighs the detrimental effect on the search for truth. In particular, Wigmore set out four conditions for the establishment of a privilege:

1. The communications must originate in a confidence that they will not be disclosed.
2. This element of confidentiality must be essential to the full and satisfactory maintenance of the relation between the parties.
3. The relation must be one which in the opinion of the community ought to be sedulously fostered.
4. The injury that would inure to the relation by the disclosure of the communications must be greater than the benefit thereby gained for the correct disposal of litigation.

The evolution of the privilege concept in law is helpful in understanding its current role for psychotherapists. The rule that an advocate could not be called as a witness against his client existed in Roman times. It is unclear whether the Roman tradition influenced the Anglo-Saxon attorney–client privilege, but English recognition of the privilege goes back at least to the reign of Elizabeth I. The purpose of the privilege was to prevent the attorney from being required to take an oath and testify against his client. Later, it was also considered that such testimony against one to whom loyalty was owed would violate the attorney’s honor as a gentleman. Thus, the original justification for the privilege was nonutilitarian. Accordingly, the attorney, rather than the client, held and asserted the privilege. Today the privilege is the prerogative of the client. The client, not the lawyer, holds the privilege. The client has the ultimate authority to raise or to waive the privilege. In addition to the attorney–client privilege under English common law there was also a spousal privilege and, until the Reformation, a clergy–communicant privilege.

The physician–patient privilege did not exist under the English common law, and physicians were expected to testify as any other witnesses in court proceedings. In the United States, a New York court first recognized the clergy–communicant privilege in 1813. In 1828, New York also became the first state to grant a testimonial privilege to communications between a doctor and patient. This permitted a patient to prevent a physician

from testifying about information relevant to the patient’s treatment that was divulged to the physician in his professional capacity. The psychological counseling privilege has gained recognition since the 1950s, and more recently the privilege has been extended to cover other therapists and sexual assault counselors. Around 1970 there were some efforts by psychiatrists to assert the privilege in their own right. Psychiatrists argued that the patient could not fully understand what they were agreeing to when they signed a release of information. Only the analyst could understand the full implications of the disclosures made in therapy. Courts were by and large not sympathetic with this argument and have clearly held that it is the patient’s privilege and is not the prerogative of the therapist.

By 1996 all 50 states and the District of Columbia had enacted some form of psychotherapist privilege. Federal courts, however, did not accept the privilege. In 1972 the Chief Justice of the Supreme Court transmitted to the Congress proposed rules of evidence for the federal courts that had been formulated by the Judicial Conference Advisory Committee and approved by the Judicial Conference of the United States. The proposed rules defined nine specific testimonial privileges, including a psychotherapist–patient privilege. Congress rejected this recommendation in favor of Rule 501, which was more general and authorized federal courts to define new privileges by interpreting “common law principles ... in the light of reason and experience.”

Until 1996 only a few federal jurisdictions adopted a limited form of a psychotherapist privilege. Others rejected it entirely. Because of these conflicts in the federal courts the U.S. Supreme Court agreed to hear the case of *Jaffee v. Redmond*. Mary Lu Redmond was the first police officer to respond to a “fight in progress” call at an apartment complex in Illinois. As she arrived two women ran toward the squad car saying there had been a stabbing in one of the apartments. Officer Redmond relayed the information and requested an ambulance. As she was walking to the entrance of the building several men ran out, one waving a pipe. Two other men then burst out of the building, one chasing the other and brandishing a butcher knife. He disregarded her repeated commands to drop the weapon, and Redmond shot him when she believed he was about to stab the man. He died at the scene, and people came pouring out of the building, and a threatening confrontation followed before other officers arrived. A suit was filed against the officer claiming excessive force. There was conflicting testimony from the victim’s relatives claiming that he was unarmed and that she drew her gun immediately on exiting the squad

car. After the shooting Redmond saw a clinical social worker for 50 sessions. The plaintiff sought access to the therapy notes concerning the sessions in their cross-examination of Officer Redmond. The district judge rejected Redmond's assertion that the contents of the therapy notes were protected under the psychotherapist–patient privilege. Neither the therapist nor Redmond complied with the order to release the notes. The judge instructed the jury that they could presume the notes would have been unfavorable to Redmond, and the jury awarded approximately \$550,000 in state and federal claims.

The U.S. Supreme Court majority opinion concerning this case held that confidential communications between a licensed psychotherapist and her patients in the course of diagnosis and treatment are protected from compelled disclosure under Rule 501 of the Federal Rules of Evidence. They explicitly recognized and extended the privilege for psychiatrists and psychologists to licensed social workers. They noted that there would be situations in which the privilege must give way, for example, if a serious threat of harm to the patient or to others could be averted only by means of the disclosure by the therapist.

In spite of the importance of the recognition of a psychotherapist–patient privilege, it is important to be aware that the patient's privilege is not absolute. There are several exceptions to both the psychotherapist–patient privilege and confidentiality statutes. The patient waives the right to confidentiality when he or she places his or her mental condition into issue in civil litigation, the so-called patient-litigant exception. This is permitted to allow the defendants to explore a patient's prior history to confirm that the current mental condition was related to the claimed injury and had not been present before. Since *Jaffee*, courts continue to differ about the breadth of this exception. The most frequent examples are plaintiff's claims in civil cases for emotional distress damages or in suits under the Americans with Disabilities Act in which a party's mental condition may be part of the case. Some courts have held that where a patient merely alleges "garden variety" emotional distress following an injury and not a specific psychiatric disability or unusually severe distress, this has not been deemed sufficient to waive the psychotherapist–patient privilege. However, there is wide variation in individual rulings. A waiver is frequently deemed to apply when parents cannot agree in custody disputes regarding who is best able to care for the child. In many jurisdictions, statutes also exclude the use of the privilege in involuntary civil commitment proceedings.

The dangerous patient exception to the privilege was explored in a case where a man was indicted for threatening to kill the president. The defendant moved to exclude from evidence his prior statement to a psychiatrist that he "wanted to shoot Bill Clinton." The government argued that under the *Jaffee* exception the privilege was not available, and the trial court agreed. On appeal the Tenth Circuit rejected the broad claim that the privilege does not apply in the criminal setting but remanded the case for an evidentiary hearing "to determine whether ... the threat was serious when it was uttered and whether its disclosure was the only means of averting harm to the president when the disclosure was made." If serious and the only means for averting harm then the privilege would not be available. On remand, the District Court heard from the psychiatrist that the man had been discharged to his father's care after his hallucinations of killing the president had stopped and he was stabilized on antipsychotic medication. Three days later the psychiatrist learned that the man had left the father's home, and his whereabouts were unknown. Concerned that he would again stop his medication without supervision, the psychiatrist now concluded that he posed a "serious threat" but commitment was not an option because he had disappeared. The Secret Service was concerned that he had money to travel and had once before been investigated for similar threats. Based on this evidence the court denied the defendant's motion to exclude the disclosure to his psychiatrist. Neither the trial court nor the appellate court considered whether the disclosure, designed to prevent a future harm, should be admissible in a subsequent criminal prosecution.

California has an evidentiary rule permitting this type of disclosure, which has led to psychiatrists and psychologists being called to give evidence of aggravation in capital sentencing hearings after making a *Tarassoff* warning that ultimately failed to protect a victim. The prosecutor was interested in showing long-standing hostility and premeditation by use of this testimony. Other state courts, without this rule of evidence, have refused to let such testimony into evidence.

Other exceptions to confidentiality include reporting laws, such as those relating to communicable diseases; child abuse and neglect; chronic health problems affecting safety to drive; disabled physicians; elderly abuse; and mentally retarded abuse. Most states also permit disclosures, without patient consent, when therapists wish to consult with other professionals for the purpose of diagnosis and treatment, when decisions need to be made regarding hospitalization of the patient, or when the patient poses a risk of harm to self or others.

There are also special rules that come into effect when the work setting or facility has developed specific guidelines. For example, correctional institutions, employee assistance programs, and the military all have additional exceptions to confidentiality. Prison wardens generally require, as a work rule, that any information regarding escapes or escape plans are not confidential and require disclosure to security staff. In employee assistance programs, some information concerning work performance issues may be available to the employer. Commanding officers in the military frequently must be told certain information that would be confidential in other settings. Such special settings frequently require a therapist to learn about and then inform the patient of any limitations on confidentiality that may be applicable.

There have not been many cases brought against psychotherapists for inappropriate breaches of confidentiality reaching appellate levels of review. Many explanations have been offered to account for this small number. The standard of care is not as clearly defined as in other areas of medicine, and causation and damages are hard to prove. There is rarely a physical injury, and courts have been reluctant to make awards for purely emotional damages. Patients may also be reluctant to file cases and expose their mental history in public. It is also possible that many cases settle before reaching open court. Nonetheless a small number of cases have reached public attention, and some are instructive.

In 1986 Diane Wood Middlebrook was writing an authorized biography of Anne Sexton, an American poet. Although Sexton had left detailed instructions regarding most of her papers including some therapy notebooks and a few tapes, her psychiatrist, Dr. Martin Orne, released 300 tapes after obtaining the permission of Sexton's daughter and literary executor, Linda Gray Sexton, to allow the biographer to review the tapes. The release of the tapes evoked great consternation from both literary and psychiatric circles. One professional called his actions a "betrayal of his patient and profession." Others felt the family's wishes did not matter and that confidentiality should survive a patient's death. Dr. Orne believed that the patient would have been eager to have the material reviewed. Eventually charges of an ethics violation were brought against Dr. Orne and adjudicated by the American Psychiatric Association. Ultimately a decision was reached that no ethical violation occurred. Although no lawsuit was filed, the situation illustrates the high sensitivity to these issues as well as the vulnerability of psychotherapists to ethical complaints.

Some liability for disclosures has been founded upon "breach of contract." In *Doe v. Roe* a psychiatrist and her psychologist husband wrote and published a book about a wife and her late husband eight years after the couple terminated psychotherapeutic treatment with the psychiatrist. The book reported extensive details of their lives with verbatim quotations on the feelings, fantasies, and thoughts of both husband and wife concerning the marriage that was breaking up. The therapist claimed that she had obtained verbal consent during the course of therapy. The suit was brought for breach of contract and in tort, for a violation of the confidentiality statute between physician and patient and for invasion of privacy. The court held that the defendant psychiatrist had entered into an agreement with her patients to provide medical care, and although not an express contract, the court stated that the physician impliedly covenants to keep in confidence all disclosures made by the patient concerning the patient's physical and mental condition "as well as all matters discovered by the physician in the course of examination or treatment." The court noted that patients would bring out "all manner of socially unacceptable instincts and urges, immature wishes, perverse sexual thoughts—in short the unspeakable, the unthinkable, the repressed." The psychologist husband who was a co-author was not in a contractual or physician-patient relationship with the plaintiff but the court held him equally liable as a co-violator.

The courts have used a similar means to hold non-physician therapists to a standard of care encompassing confidentiality. In *Mississippi State Board of Psychological Examiners vs. Hosford*, a psychologist was suspended from practice by the state board for revealing confidential information about his patient. The patient and her husband had sought a treatment for marital difficulties. The psychologist voluntarily and unilaterally revealed information about the wife in a subsequent divorce and custody action to the husband's attorney and signed an affidavit attesting that the wife was not a competent parent. This disclosure was made without a court order requiring disclosure. The Mississippi Supreme Court reviewed the American Psychological Association's Ethical Principles, the psychologist patient privilege, and a "public imperative that the psychology profession as a whole enjoy an impeccable reputation for respecting patient confidences" when the psychologist appealed the decision of the licensure board. The suspension was upheld.

The complexity of the psychotherapist-patient privilege and the Fifth Amendment were illustrated in a case

that arose on an Indian reservation and thus was heard in federal court. D. F. was a troubled 13-year-old adolescent who was admitted to a residential treatment program at a county mental health center. Over the course of 6 months she received very conflicting messages about the confidentiality of her statements made to center staff. She was suspected of harming two infant cousins who had died within a short time of each other. While at the center she was repeatedly encouraged by staff to write and discuss her abuse of young children to gain better ward privileges. At the same time some of the staff were in close communication with Protective Services and the FBI. The staff could never reach consensus about their role and responsibilities. Finally, after more than 6 months on the unit, she confessed. She was arrested and charged with second-degree murder. When the government attempted to introduce her confession, the defense argued that it was not voluntary. The admission into evidence of a confession that was not voluntary, within the legal meaning of the word, violates due process. The court found that the therapists were acting more like "state actors" (police) than they were therapists as they were directly communicating with law enforcement, and thus the confession was determined to be coerced and inadmissible. The staff never clearly defined their role as caregivers with a duty to look after the patient's best interests. Had they done so they would have thought of suggesting that she have a lawyer appointed to attend to her legal problems as well as obtaining legal guidance for the staff.

II. ACCESS TO ONE'S OWN MEDICAL RECORDS

Traditionally, medical records were considered the property of the physician or therapist and thus were under his or her full control. As recently as 1975 a woman, who had signed a contract to write a book about her own experiences as a patient, wished to read her psychiatric records. The New York court, at that time, had no difficulty in upholding the hospital's right to refuse such access. This rule has been altered as the vast majority of states have passed right-of-access laws permitting patient access to their own medical records. Generally, however, these laws allow therapists a limited ability to restrict access where there are reasonable grounds for a judgment that access would be harmful to the patient.

III. "DUTIES TO THIRD PARTIES" OR WHEN CAN VICTIMS OF A PATIENT'S VIOLENT BEHAVIOR HOLD THE PSYCHOTHERAPIST ACCOUNTABLE?

Prior to the mid-1970s psychotherapists had little exposure to lawsuits from individuals who were injured by their patients. This generally was limited to cases of (a) harm by a patient to other patients on an inpatient unit, or (b) negligent discharge from inpatient facilities that resulted in harm to families or strangers within a short period of time from the discharge. This was based on a common-law principal that imposed a duty on the person having custody of another to control the conduct of that person. This common law principle is stated in Restatement of the Law, Second, Torts § 320

one who is required by law to take or who voluntarily takes the custody of another under circumstances such as to deprive the other of his normal power of self-protection or is subject him to association with persons likely to harm him, is under a duty to exercise reasonable care so to control the conduct of third persons as to prevent them from intentionally harming the other or so conducting themselves as to create an unreasonable risk of harm to him, if the actor

1. Knows or has reason to know that he has the ability to control the conduct of the third persons, and
2. Knows or should know of the necessity and opportunity for exercising such control.

As written this would not seem to apply to outpatients in psychotherapy.

A. The Tarasoff Case

In 1969 a case arose in California that substantially expanded the duty of care for psychotherapists. The facts are interesting, and although a jury (because of a settlement prior to trial) never heard the case, it has become a landmark case for psychotherapists. Prosenit Poddar was a 25-year-old Bengalese Indian student at the University of California in Berkeley when he murdered another student, 19-year-old Tatiana Tarasoff. Why he killed this young woman he "loved," but barely knew, gradually emerged. Poddar had risen with amazing success through the Indian educational system. In the 1960s he was one of a small number of

Indian students chosen because of his intellectual abilities to pursue graduate-level study in United States in the field of electronics and naval architecture. He grew up in a tiny village in a remote area of India. His upbringing was so the distant from that of Western society that when he first attended the University in India, his friend Farrokh Mistree had to teach him how to eat with a knife, fork, and spoon and had to explain plates to him. He was a member of the lowest caste in India, the so-called untouchables. During his first year in the United States he did quite well academically. His friend Mistree then joined him in the states but was able to adapt much more quickly to U.S. culture. In the fall of 1968, during his second year, Poddar met Tatiana Tarasoff at an International Students' Organization folk dance. She talked, danced, and flirted with him. She told him of her background, being born in Shanghai of Russian parents, moving to Brazil and then the United States. She was studying languages at a local college and liked to practice at the International House where Poddar was living. She was outgoing and friendly with many of the foreign students but gradually Poddar's interest in her increased, and he told his friend Mistree of his powerful attraction. He did not understand how her behavior, that seemed more than friendly to him, was compatible with spending time with other male students. His friend explained that he thought her interest was genuine but probably only casual.

At a New Years Eve party, he was alone with her in an elevator. It was a festive occasion, and people had been drinking. Impulsively she kissed him for the New Year. He was stunned, as he had never had physical contact with a woman other than his relatives. He almost immediately fled to tell his friend of the new development. In the months that followed he became increasingly upset by her inconsistent behavior. He installed microphones in his room to record their conversations both on the phone and in person. His friend suggested that he end the relationship because it was interfering with his work. He did so, but a month later she called and said she missed him. Within a month he was again uncertain, and in an effort to clarify the situation, he proposed marriage. She did not accept but also did not clearly refuse. Shortly afterward he again confided to his friend that Tatiana's friends were now laughing at him. "Even you, Mistree," he said, "laugh at my state. But I am like an animal, I could do anything, I could kill her. If I killed her, what would you do?" He began to stay in his room for days. He told fellow students that he would like to blow up the house where she lived with

her brother and parents. They persuaded him that it was not possible but did not say anything to warn anyone or call the police.

In June, Tatiana returned to Brazil for the summer, but nothing changed for Poddar. His friend suggested that he see a doctor, set up the appointment, and accompanied him. After the initial interview the psychiatrist placed him on antipsychotic medication and set up weekly appointments with a psychologist. During the summer months Poddar became friendly with Tatiana's brother, Alex, spent time with him, and planned to share an apartment with him in the fall. He began to fantasize about rescuing Tatiana from a contrived situation so she would understand the depth of his affection for her. When he told his friend Mistree that he planned to buy a gun to effect this plan, Mistree called the therapist and told him that Poddar planned to stop therapy and buy a gun. The psychologist consulted with the psychiatrist, and they decided that Poddar needed to be hospitalized. Because of peculiarities in California commitment law the psychologist wrote a letter to the University police requesting their assistance in hospitalizing Poddar. Shortly thereafter the Berkeley campus police found Poddar in his new apartment with Alex and interviewed him there. Poddar denied he had a weapon and denied any specific threats although he acknowledged that there had been a difficult relationship between him and the young woman. The police warned him to stay away from her and left without taking any other action. Tatiana's brother Alex was present during interview and knew that the threats were related to his sister but he did not take them seriously and did not report them to his family. When the head of the clinic reviewed the case, he ordered the therapist to destroy the letter to the campus police requesting hospitalization.

Tatiana returned in September, and Poddar overheard her recounting a summer affair to her friends. He began to follow her around. He then purchased a gun, perhaps to carry out his plan of rescuing her from a disaster situation. He consulted with Alex about what would be the best way to approach his sister but Alex recommended that he stay away from her and that it was all over and best forgotten. Poddar insisted that he must talk with her, but Alex told him not to go over to his parent's house, as his father was quite hot tempered. Poddar then made several efforts to see Tatiana at the house. After her mother turned him away, he returned in midafternoon before anyone else came home. As he left his apartment, he slipped a kitchen knife as well as the gun into his pocket as protection against her angry

father. When she answered the door he tried to explain his need to talk with her and forced his way past the closing door. Tatiana screamed, pushed him away, and started to run away. He fired at her scream and followed her. He took the knife from his pocket as they plunged together through the kitchen door. Within minutes he dialed the phone number of the Berkeley City Police stating that he thought he had killed someone. Poddar was charged with first-degree murder. He pled insanity and diminished capacity. Although all experts agreed with the diagnosis of paranoid schizophrenia, the jury found Poddar guilty of second-degree murder. He was sent to California state prison. Five years after he had begun serving a sentence, the California Supreme Court issued its decision; overturning the jury verdict on the grounds the trial judge had given inadequate instructions on diminished capacity to the jury. Rather than retry him, a deal was struck. Because he had already served 5 years, if the state would agree to release Poddar from prison; his attorney personally guaranteed that Poddar would return immediately to India and would never come back to the United States.

Alongside the criminal case, *Tarasoff v. Regents of the University of California* also ended with a settlement. Tatiana's parents sued the University of California and the therapists for the wrongful death of Tatiana. They included a complaint that the psychiatrist's failure to warn them or Tatiana of the danger that Poddar posed to the family was a legal cause of action. Because the trial court dismissed the causes of action as groundless it was appealed to the California Supreme Court on their legal adequacy. After the Court rendered its first decision holding that psychotherapists had a duty to warn potential victims of their patient's threats and that the campus police could be found liable for a failure to warn Tanya, a rehearing was requested although such requests are almost never granted, it was in this case. The second decision reaffirmed but modified the original decision. It required therapists to "protect" intended victims, rather than just "warn" them and absolved the police from any liability. Although the Court expressed concern about the confidentially issues raised by psychiatrists and other mental health professionals, they concluded in both decisions "The protective privilege ends when the public peril begins." The major holding of the case was that the therapists could not escape liability on the grounds that Tatiana was not their patient. The Court held:

When a therapist determines, or pursuant to the standards of his profession should determine, that his patient presents a serious danger of violence to another, he

incurs an obligation to use reasonable care to protect the intended victim against such danger. The discharge of this duty may require the therapist to take one or more of various steps, depending upon the nature of the case. Thus it may call for him to warn the intended victim or others likely to apprise the victim of the danger, to notify the police, or to take whatever other steps are reasonably necessary under the circumstances.

Justice Mosk, in a concurring opinion (meaning that he agreed with the holding but not the legal reasoning), agreed that under the limited circumstances of this particular case, Poddar's therapists had a duty to warn Tatiana. Although Mosk believed the therapists' duty had been satisfied by warning the campus police, he considered this a factual matter to be raised by the defense on remand and did not dissent on this basis. He dissented from the majority's use of the term "standards of the profession." What standards? Psychiatric opinions of future violence were inherently unreliable. "The majority's expansion of that rule will take us from the world of reality into the wonderland of clairvoyance."

Justice Clark, in dissent, was concerned about the pressure on psychiatrists to protect themselves.

Now, confronted by the majority's new duty, the psychiatrist must instantaneously calculate potential violence from each patient on each visit. The difficulties researchers have encountered in accurately predicting violence will be heightened for the practicing psychiatrist dealing for brief periods in his office with heretofore nonviolent patients. And, given the decision not to warn or commit must always be made at the psychiatrist's civil peril, one can expect most doubts will be resolved in favor of the psychiatrist protecting himself."

Because the case settled prior to trial, there was no discussion or expert opinion of what warnings or protective action were possible or appropriate in the above circumstances.

Although California went on to clarify the meaning of the principle in later decisions to cover only identifiable victims, other jurisdictions disagreed and expanded the scope of the decision. The broadest interpretation occurred in 1980 in the case of *Lipari v. Sears Roebuck & Co.* There, a patient fired a shotgun in a crowded nightclub, blinding a woman and killing her husband. There were no advance warnings to his therapists, and he never threatened any specific person. He did make clear that he was unhappy with his treatment. While still in treatment at the V.A. day care center he purchased a shotgun at Sears, but told no one on his treatment team. He terminated treatment 3 weeks later. One month after the

termination he entered the nightclub. The Nebraska District Court allowed the plaintiffs to proceed in their lawsuit against the hospital. The court held it was for the jury to decide whether the therapist knew or should have known of the patient's dangerous propensity. It did not matter that the victims were not identifiable. The Court rejected the limitation to identifiable victims and focused on the foreseeability of the act.

A Vermont case extended the liability to situations where only damage to property was involved. In that case a patient informed his master's-level counselor that he intended to burn down another person's barn.

The duty has also expanded in some jurisdictions to the area of a patient's erratic driving. In one case a man diagnosed with paranoid schizophrenia, and with an extensive history of depression, self-mutilation, and noncompliance with neuroleptic regimens, was confined following his excision of his left testicle. One day prior to the expiration of his commitment he was observed driving dangerously on the hospital grounds. His commitment was not renewed, and he was released to outpatient follow-up. He promptly threw away his medication and resumed use of street drugs. Five days later he ran a red light at excessive speed and hit a vehicle, injuring the driver. She filed a suit, charging the state with negligent treatment by failing to recommit him or releasing information, regarding his violation of probation conditions. The court adopted the foreseeability standard from *Lipari* to hold that a psychiatrist has a duty to take reasonable precautions to protect anyone who might foreseeably be injured by the patient's drug-related problems. This line of cases requires therapists to protect victims from their patients' negligent behavior rather than just intentional harmful acts.

An interesting variant occurred in another California case where the question arose as to whether a therapist has to make a warning if the potential victim is already aware of the danger. In *Jablonski v. U.S.* the victim was the defendant's common-law wife, Melissa Kimball. Ms. Kimball was fully aware of her husband's violent tendencies in view of his prior beatings of her and his attempted rape of her mother. His more recent behavior included threatening the mother-in-law again. His psychiatrist recommended a voluntary hospitalization, which he refused. Prior psychiatric records from the V.A. were not obtained that would have revealed homicidal ideations toward his former wife. His wife brought him back for a second visit but the physicians felt that although he was potentially dangerous due to his antisocial personality he was not presently committable.

Two days later he attacked and murdered his common-law wife. The victim's daughter claimed the psychiatrists were negligent by failing to warn her mother of her husband's foreseeable danger. The court agreed. "Warning Kimball would have posed no difficulty for the doctors, especially since she twice expressed her fear of Jablonski directly to them. Neither can it be said ... that direct and precise warnings would have had little effect." The reasoning of the Court seemed to be that, even though others had suggested she stay away from him, a warning from a doctor carries greater weight and might have influenced the victim.

Almost all jurisdictions have adopted some form of the *Tarasoff* duty, either through case law or by statute. Some courts have reasoned that this duty to protect third parties should be imposed because of the therapist's control over the patient, while others have taken a modified approach by broadening the therapist's duty to warn all foreseeable victims. Some have limited liability to specific identifiable victims or to a class of identifiable victims (e.g., children). A minority of jurisdictions has declined to recognize the obligation altogether, especially for outpatient therapists (Florida, Virginia, and Texas). The American Psychiatric Association has proposed model legislation to better define the nature of the liability as well as what actions are sufficient to fulfill the duty. They suggest language to include "actual" or "real" threats as well as identifiable victims. They also suggest that hospitalizing the patient or making reasonable attempts to notify the victim and calling the police is sufficient to satisfy the duty. This model statute was adopted in some 22 states with variations in wording.

There were many concerns that this decision would have dire effects on the psychotherapeutic relationship. Some felt that psychotherapists would be deterred from treating potentially violent patients or that patients would be deterred from seeking therapy. Others thought that patients would be less likely to share violent fantasies or that once a warning was issued the therapy would end as in the *Tarasoff* case. Subsequent studies and experience, however, have failed to confirm these fears. Psychotherapists have and should increase their use of consultation in potential *Tarasoff* cases, which is a useful step in planning carefully as well as averting liability.

Tarasoff and subsequent cases have defined and expanded the psychotherapist's obligations to victims of their patient's actions if they are deemed foreseeable. The challenge is how to maintain trust with patients while carefully assessing and evaluating risk of violence

to third parties. Therapists must then consider how best to protect potential victims as well as their patients by considering increased contact, medication, hospitalization, warnings, or other protective actions. Problems have arisen when past medical records have not been reviewed or past therapists have not been contacted.

By contrast when patients reveal information about past crimes most confidentiality statutes (except for child abuse reporting) do not permit disclosure by the therapist. Yet therapists, unlike attorneys who hear such information are generally more uncomfortable keeping such information confidential, especially if the crime is serious, and often wish to call law enforcement authorities. They are concerned that patients are using psychotherapy to “get away with a crime.” But for an expectation of confidentiality, patients would not disclose such information to therapists. In such circumstances a consultation with an attorney or knowledgeable colleague may be useful in reviewing duties and obligations.

IV. FEDERAL LAW AND REGULATIONS REGARDING CONFIDENTIALITY

Aside from comprehensive regulations regarding treatment of substance abusers in facilities receiving federal funding, the federal government has generally left confidentiality protections of medical information to the states. In 1996, however, Congress passed the Health Insurance Portability and Accountability Act (HIPAA). Concerns about the fact that more and more health care providers and plans are using electronic means of storing and transmitting health information caused Congress to attempt to develop privacy rules and to ask the Department of Health and Human Services (HHS) to provide regulations if there was no congressional action by August 1999. Congress did not act, and regulations were developed by HHS and went into effect in April 2001. Compliance is required by 2003. This Act covers all health care providers who have engaged in at least one standard electronic transaction or providers that use billing services that utilize electronic transactions as well as health plans. The Act distinguishes between consent and authorization. Consent must be obtained to release information for “treatment, payment, and health care operations” (TPO). Consent, in this context, is a general document that gives health care providers, who have a direct treatment relationship with a patient, permission to use and disclose all health information for TPO. Authorization is required for more specific releases of information. An authorization is a more cus-

tomized document that gives providers permission to use specified protected health information (PHI) for specified purposes, which are generally other than TPO, or to disclose PHI to a third party specified by the individual. Psychotherapy notes have received some special protections if they are kept separate from the rest of the medical record and are for the use of the therapist only. In general, disclosures of information will be limited to the “minimum necessary” for the purpose of the disclosure. This provision does not apply to the disclosure of medical records for treatment purposes because physicians, specialists, and other providers need access to the full record to provide quality care.

States that have more stringent confidentiality protections under local state laws (like those covering mental health, HIV infection, and AIDS information) are not preempted by HIPAA. These confidentiality protections are seen as setting a national “floor” of privacy standards. This law was not designed to resolve disputes between insurers and providers nor prevent subpoenas of records for court-related issues. HHS is beginning to issue “guidances” so that practitioners will be able to understand the regulations and their requirements.

V. BOUNDARY VIOLATIONS: PSYCHOTHERAPIST–PATIENT SEXUAL CONTACT

The boundaries of any relationship define how the parties ought to behave toward each other in their respective roles. In the psychotherapist–patient relationship, these boundaries are derived from professional ethical guidelines, cultural morality, and jurisprudence. Generally, boundaries include agreements relating to scheduled sessions; fee agreements; establishing “treatment goals” that are modified through negotiation; therapy sessions focused entirely on the client; an understanding regarding confidentiality and any limitations; and finally, no sexual contact or even social contact with patients, except when “overlapping [social] circles” render such contact unavoidable. The purpose of these limits is to create an atmosphere of safety and predictability within which the treatment can proceed. These guidelines have evolved from the psychoanalytic method of treatment. They have not been codified or updated to include current modes of treatment especially involving treatment of the seriously and chronically mentally ill in the public sector. This work does involve professionals in their clients’ lives especially when they live in supervised housing or are being delivered and administered medications in their homes or apartments.

Many of these patients or clients are also supervised and at times accompanied by staff to aid in shopping for food or clothes as well as helping with money management programs. Many of these behaviors have been deemed unethical when they have occurred in psychoanalytic-type treatment settings. Even within psychotherapeutic approaches, it has not been possible to articulate definitive guidelines, as most clinicians would agree that guidelines should be tailored to the particular requirements of the individual patient.

The fiduciary nature of the physician–patient relationship is fundamental to boundary setting and creates a covenant that controls the imbalance of power to ensure a safe and trusting relationship based on the patient’s needs. In essence, the physician guarantees that, within the therapeutic relationship, the patient can feel comfortable revealing intimate personal information without fear of exploitation.

Not all boundary crossings are equivalent to malpractice or substandard care. Many do not harm the patient or threaten the treatment. Helping a patient who has fallen or consoling a patient who has just been informed that a close relative has died are humane responses that should not be discouraged. There are situations where some behaviors may be inappropriate in some contexts but not in others, for example some touching of terminally ill, geriatric patients or HIV-infected patients. Both culture and context are important factors to consider in reviewing behavior.

Any sexual contact, however, has been increasingly viewed as an egregious violation of patient trust. Here, psychotherapists are seen as allowing personal interests to supercede those of the patient in a manner that may cause significant harm.

In cases involving breaches of confidentiality courts have been more willing to look at physicians’ ethical guidelines and fiduciary duties, than they have in cases involving physician–patient sexual contact. The courts’ inconsistency in applying the ethical standards and fiduciary aspects of the psychotherapist–patient relationship to sexual conduct remains unclear. Judicial unfamiliarity with the medical professions standards may reflect the inconsistent statements made by different professional organizations and the relatively late response of the American Medical Association to develop specific standards.

Like confidentiality standards, the ethical proscriptions against sexual contact between physicians and patients are long standing and were emphasized in the Hippocratic Oath that was codified around 460 BCE: “In every house where I come I will enter only for the good of my patients, keeping myself far from all intentional

ill-doing and all seduction, and especially from the pleasures of love with women or with men.”

Prior to 1990, the AMA recognized the potential for power abuse in the physician–patient relationships and declared “sexual misconduct” in the practice of medicine to be unethical. However, the code did not define “misconduct” and thus did not clarify what type of sexual conduct was proscribed. Today the code expressly provides that sexual contact that occurs concurrently with the physician–patient relationship constitutes sexual misconduct. Sexual relationships that predate the physician–patient relationship, such as sexual contact with a spouse, are an exception to this general rule. In most other cases the AMA has explained that sexual contact between a physician and patient is almost always detrimental to the patient and is unethical because the physician’s self-interest inappropriately becomes part of the professional relationship. Because a fiduciary relationship exists between a patient and a physician, physicians have obligations to act solely for the welfare of patients and refrain from engaging in sexual activity.

The American Psychiatric Association, in its annotations to the AMA Code for psychiatrists much earlier specified the possibility for exploitation of patients (1973—first edition of the Principles of Medical Ethics with “Annotations Especially Applicable to Psychiatry”): “The necessary intensity of the therapeutic relationship may tend to activate sexual and other needs and fantasies on the part of both patient and psychiatrist, while weakening the objectivity necessary for control. Sexual activity with a patient is unethical.” This policy was promulgated in the 1970s along with the suggestion that if therapy was ended but the subsequent relationship was exploiting the patient it too was unethical.

Other psychotherapeutic disciplines have similar codes. The ethical code for psychologists states that “Sexual intimacies with clients are unethical.” Likewise for social workers, “The social worker should under no circumstances engage in sexual activities with clients.” Similarly the ethical code for marriage and family therapists maintains, “Sexual intimacy with clients is prohibited.”

In one survey of psychiatrists in the 1980s, 7.1% of male and 3.1% of female psychiatrists admitted sexual contact with patients. In three surveys of psychologists, between 1977 and 1986, 12.1% of male psychologists and 2.6% of female psychologists reported sexual contact with patients. There are several indications that the incidence of sexual contact may be higher than admitted by therapists. For example, there were low return rates in some of the surveys, and some states have felony criminal penalties for such behavior. In one study, 63% of psychiatrists surveyed reported treating

at least one patient who had experienced sexual contact with another physician. In another study, 50% of psychologists reported treating at least one patient who had been sexually involved with a previous therapist.

Indeed, between 1976 and 1986, sexual misconduct was the most frequent cause of lawsuits against psychologists insured under American Psychological Association policies, accounting for 44.8% of all moneys (\$7,019,165.00) paid in claims. There is nothing to suggest that the incidence among the different mental health professionals differs greatly. In response to similar concerns, the American Psychiatric Association extended the prohibition from current patients to both current and former patients in 1993.

Problems abound in the implementation of remedies for victims of such misconduct and unethical behavior. There are now generally four avenues of redress and complaints can be filed simultaneously:

1. Traditional malpractice claim
2. Complaint to the state medical or professional licensing board
3. Criminal complaint
4. Ethical complaint to the professional association

A. Traditional Malpractice Claim

Health care professionals—including dentists, gynecologists, physicians, psychiatrists, psychologists, therapists, and medical technicians—spend millions of dollars purchasing medical-malpractice insurance from state, regional, and national liability insurers. For example, the St. Paul Fire & Marine Insurance Company, the largest medical-liability company in the nation, sells and renews thousands of medical-malpractice policies each year. The language appearing in St. Paul's medical-liability contracts is very similar to that appearing in legal-malpractice policies. Typically, the coverage provision states: "This agreement provides protection against professional liability claims which might be brought against you in your practice as a physician or surgeon. ... Your professional liability protection covers you for damages resulting from ... your providing or withholding of professional services."

For at least 30 years, St. Paul—as well as those professionals who were insured—has asked state and federal courts to decide whether St. Paul must defend professionals who allegedly seduced, battered, sexually assaulted, or molested their patients. As expected, St. Paul's defense has been consistent: These intentional injuries do not "arise out of" or "result from rendering professional services." The medical-liability carrier,

however, has not prevailed in every case, even though the third-party patients' allegations involved allegedly intentional acts excluded by St. Paul's insurance contracts. State courts have either refused, or failed to employ, various legal doctrines to help determine whether "deviant" physicians and medical technicians are "rendering professional services." Instead, these tribunals have permitted some generalized notion of public policy to influence whether some insurers must defend their insureds in cases involving sexual assault.

In one early case in 1977, *Hartogs v. Employer Mutual Liability Insurance Company*, Dr. Hartogs was a practicing psychiatrist. Under the guise of medical treatment, Dr. Hartogs administered "fornication therapy" to cure his patient's lesbianism. The patient received judgment for \$15,000.00 and Dr. Hartogs's insurer refused to pay the judgment on the grounds that the treatment did not constitute medical malpractice. They argued that sexual relations could not be considered a medical treatment. Dr. Hartogs brought an action against the insurer to recover his costs and expenses in defending the action, as well as the expenses incurred by him when he filed for bankruptcy to protect his property. As part of his argument for compensation, Dr. Hartogs noted that the jury had specifically found medical malpractice.

The court ruled that the insurer was not obligated to indemnify Dr. Hartogs for two reasons. First, the court held that a distinction should be drawn between medical malpractice in the mind of the patient, and medical malpractice in the mind of the doctor. The patient believed at the time that appropriate medical therapy was being administered. On the other hand, the doctor administering this treatment knew at all times that what he was doing was in no way pursuant to the doctor-patient relationship. As such, as between Dr. Hartogs and his insurer, his actions could not constitute medical malpractice.

Second, as a matter of public policy, the court would not allow itself to be used to enforce illicit or immoral or unconscionable purposes. The court held that to allow judgment in this type of case would be to indemnify immorality and pay the expenses of prurience. The Court did not deal with the question of how the plaintiff would collect judgment given that Dr. Hartogs had filed for bankruptcy.

On the other side of the same question, the issue of protecting the victim was focused on by the 1982 Michigan decision, *Vigilant Insurance Company v. Kambly*. In that case, Vigilant Insurance Company filed an action for relief, absolving it from liability under a professional insurance policy issued to a psychiatrist. The court's decision denied relief. In that case, Dr. Kambly

had induced his patient to engage in sexual intercourse under the guise of treatment. In its judgment, the court stated that there was no reason for distinguishing between this type of malpractice and others. The court noted that in each situation, the essence of the claim is the doctor's departure from proper standards of medical practice. In addition, the court found that allowing insurance coverage would benefit the patient, not the physician. Therefore, Dr. Kambly would not unjustly benefit from the determination that coverage existed.

The court further held that it was unlikely that the insured was induced to engage in unlawful conduct by relying on the insurability of any claims. Therefore, allowing insurance coverage would not induce future similar unlawful conduct by practitioners. In addition, the policy was not obtained in contemplation of a violation of the law. Finally, the court noted that there was a great public interest in protecting the interests of the injured party.

A number of insurers in the United States provide funding for a defense in sexual abuse cases but do not pay a judgment on a finding of liability. There is a problem throughout the lawsuit, however, that any settlement negotiations are complicated and restricted by the fact that the organization providing the defense is not ultimately responsible for paying the judgment. Many policies now either exclude or place liability limits (e.g., \$25,000) on policies for behavior or malpractice that stems from sexual interest or contacts.

The ethical guidelines in this area have also become the legal standard of care. Nonetheless, posttermination contacts continue to evoke much discussion in the clinical literature. Many allegations of abuse are based on allegations that transference continues after therapy ends. Transference, however, remains a complicated construct with multiple definitions. Freud initially used the concept to explain some of the irrational behavior of patients in treatment by the idea that feelings and other aspects of earlier relationships were "transferred" to the analyst who came to represent, often unconsciously, figures from the patient's past. Some therapists and treatment modalities do not accept or use the concept, while others believe that it exists in all therapies. Some psychoanalysts believe transference never ends and therefore taints any consent for posttermination relationships. This has led to conclusions that both former patients and patients are not capable of providing legally informed consent, even in the absence of a specific evaluation. A popular view of transference is that it refers to all feelings that arise between a patient and therapist. Others extend the concept to include all relationships, for example, a young woman falling in love

with an older man. Given this uncertainty, it is not surprising that courts have frequently misunderstood the concept. Even for those adopting a transference paradigm, there is a need to assess what role it may be playing. Patients continue to make many decisions while in treatment and posttreatment, and there is no literature to support global incapacity to do so just as a result of being in treatment.

B. Complaint to State Licensing Board

Another option available to victims is to file a complaint with the state licensing board regulating the offending therapist. Virtually all jurisdictions have licensure laws and codes of ethics that prohibit therapist-patient sexual contact and specify that such contact is grounds for discipline. The primary purpose of licensure laws is to protect the public from incompetent and unscrupulous therapists. As a general rule, state licensing boards are responsible for establishing and enforcing codes of ethics for the professions they regulate. In addition, most licensing statutes give the boards authority to refuse to grant a license to a therapist who has committed sexual misconduct or been found guilty of a felony involving moral turpitude. Furthermore, licensing boards also have authority to investigate ethical complaints and impose disciplinary sanctions.

Therapists accused of sexual misconduct are entitled to a hearing before disciplinary action is taken. Most complaints, however, are resolved without hearings through the use of negotiated settlements. If the complaint is not settled informally, and an administrative hearing becomes necessary, the burden of proof is low, a preponderance of the evidence (the standard of proof required in civil cases), and the rules of evidence are relaxed. In addition, although licensing board hearings are not as private and confidential as those of professional associations, they do provide less public exposure than civil trials.

From the victim's perspective, licensing board regulation has several positive aspects. First, most licensing boards do not impose a statute of limitations on the filing of complaints. In many cases, the statute of limitations is 2 to 3 years for a civil malpractice action. Therefore, disciplinary action by the licensing board may be the victim's only available remedy. Second, state licensing boards have a range of sanctions available to them. Most boards are authorized to discipline by warning, reprimand, censure, or probation. They may also suspend or revoke a license to practice.

C. Criminal Complaints

Several factors have led to the enactment of specific statutes criminalizing psychotherapist sexual misconduct. First, although some mental health professionals feel that the intensity of the therapist–patient relationship impairs the patient’s ability to consent to a sexual relationship with the therapist, courts have been reluctant to recognize this in criminal cases making it impossible to prosecute offending therapists under traditional sexual assault statutes. The second and more significant factor has been the public outcry and demand for specific legislation. In 1984, Wisconsin became the first state to enact a specific statute criminalizing psychotherapist sexual misconduct. At least 15 states have enacted some form of criminal penalty for psychotherapist or physician sexual misconduct, and most of these statutes have withstood constitutional challenges. The majority of these statutes impose criminal sanctions on therapists engaging in sexual contact while performing psychotherapy, defining those terms broadly enough to bring physicians within the scope of the statutes. Ten of the 15 statutes cover sexual contact both within and outside actual treatment sessions during an ongoing professional relationship. Two statutes apply to sexual contact outside the treatment setting only if the patient is emotionally dependent on the therapist, and two apply only to contact during therapy sessions or medical treatment or examination. All but one of the statutes applies a strict liability standard, expressly excluding consent as an affirmative defense.

Some private interest groups have argued that consent should not be eliminated as a defense in such cases because to do so “treats any person who consults a mental health professional as a child.” Eliminating consent as a defense, however, does not treat the patient as a child but merely recognizes that “competent individuals may be unduly influenced in special relationships.” Furthermore, as one commentator indicates, “patient consent to sex . . . is not the issue.” Rather, “it is the breach of fiduciary trust by the therapist who engages the patient in sex that is the appropriate focus of wrongdoing.”

Proponents of criminalization point to its deterrent and retributive value, its function as an alternative form of redress for patients inadequately served by civil or disciplinary avenues, and its potential for raising money via fines for both victim treatment and prevention programs. In reality, however, very few people file charges under these criminal statutes, suggesting that the disadvantages of criminal controls far outweigh the advantages.

Furthermore, prosecution is completely dependent on the victim’s willingness to come forward, and vic-

tims of physician sexual misconduct will be hesitant given the fact that a criminal conviction generally yields no monetary award, and the prosecutor, rather than the victim’s own legal advocate, maintains control over the case. In addition, the threat of criminal sanctions may have a chilling effect on both colleague reports and patient complaints, masking the significance of the problem and limiting the effectiveness of other controls. Moreover most malpractice insurance coverage excludes coverage for criminal acts, eliminating access to civil damages to cover the costs of necessary subsequent treatment.

Criminalization may, indeed, make it more difficult for the victim to prevail or negotiate settlements in civil suits, in that admissions will be less likely, and therapist assertions of Fifth Amendment rights may delay discovery in civil and administrative actions, pending completion of the criminal trial. In addition, criminal conviction offers little or no opportunity for rehabilitation. Finally, prosecutors face the higher reasonable doubt burden of proof and the limitations of strict rules of evidence. Given these barriers to prosecution, it is clear that criminal statutes, like civil actions, are inadequate in and of themselves to deal effectively with the problem of physician sexual misconduct.

D. Ethics Complaints to the Professional Association

Although many professional groups use professional licensing boards to adjudicate ethical violations, some professional organizations like the American Psychiatric Association (and the American Psychological Association and National Association of Social Workers) have procedures to adjudicate ethical complaints directly. If a complaint of unethical conduct against a member is sustained, that person can receive sanctions ranging from reprimand to expulsion from the association. A formal complaint has to be made in writing, and the ethics committee of the local district branch has the ability to appoint an ad hoc investigating committee to conduct an investigation and to render a decision. Due process requires that the accused member will be notified of a hearing by certified mail at least 30 days in advance. The notice includes the day, time, and place of the hearing. In addition, it includes a list of witnesses expected to testify, notification of the member’s right to representation by legal counsel (or another individual of the member’s choice), as well as notification of the member’s right to appeal any adverse decision to the ABA Ethics Appeals Board. In addition to sanctions the

district branch may also, but is not required to, impose certain conditions such as educational or supervisory requirements on a suspended member.

Patients are sometimes reluctant to file complaints, because they do not want any publicity of the details of their lives to become fodder for the press. But after years of what was termed a “conspiracy of silence,” several factors have changed the dynamics of reporting. First, as a result of both patient and women’s rights movements, patients feel less protective of and less intimidated by physicians and other professionals and are more willing to speak out. Increased awareness of sexual abuse, child abuse, date rape, clergy abuse, and therapist–patient exploitation has resulted in an increased focus on the healing professions. Professional organizations have also spoken out against these transgressions, developed training programs, and treatment programs for impaired professionals.

This section highlights a few of the major themes that have come under scrutiny over the past few decades. The factors that influence the practice of mental health professionals are an algorithm of a professional’s ethical, moral, and legal duties to provide competent care to patients. These duties are modified over time to reflect changing science, practice, and legal regulations as promulgated by courts, legislatures, professional organizations, and agencies that regulate professional practice. The mental health professional must learn to analyze clinical situations so as to know

how to balance sometimes conflicting values and rules so that proper care can be rendered to a patient.

See Also the Following Articles

Bioethics ■ Confidentiality ■ Documentation ■ Economic and Policy Issues ■ Education: Curriculum for Psychotherapy ■ History of Psychotherapy ■ Informed Consent ■ Multicultural Therapy ■ Supervision in Psychotherapy ■ Working Alliance

Further Reading

- Developments in the law – Privileged Communications. (1985). *Harvard Law Review*, 98, 1450–1454.
- 45 CFR Parts 160 and 164, Federal Register: December 28, 2000, volume 65, Number 250, pp. 82461–82829, RIN: 0991-AB08.
- Jaffee v. Redmond*, 518 U.S. 1, 135 L. Ed. 2d 337, 116 S. Ct. 1923 (1996).
- Gutheil, T. G. & Gabbard, G. O. (1993). The concept of boundaries in clinical practice: Theoretical and risk-management dimensions. *American Journal of Psychiatry*, 150, 188.
- Jorgenson, L., Randles, R., & Strasberger, L. (1991). The furor over psychotherapist-patient sexual contact: New solutions to an old problem. *William & Mary Law Review*, 32, 645.
- Tarasoff v. Regents of the University of California*, 17 Cal. 3d 425, 442, 131 Cal. Rptr. 14, 551 P.2d 334 (1976).

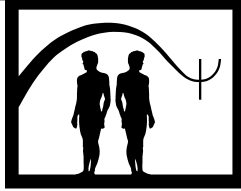

Logotherapy

Paul T. P. Wong

Trinity Western University, British Columbia, Canada

- I. Introduction
 - II. The Spiritual Dimension
 - III. The Meaning of Meaning
 - IV. Basic Tenets
 - V. Existential Frustration and Noogenic Neurosis
 - VI. Logotherapeutic Techniques and Applications
 - VII. Recent Developments
- Further Reading

GLOSSARY

dereflection A logotherapeutic technique to redirect clients' attention away from their problems to more positive aspects of their lives. It is built on the human capacity for self-distancing and self-transcendence.

existential analysis Developed by Viktor Frankl, it refers to therapeutic techniques that bring the hidden meaning of existence into consciousness.

logotherapy Developed by Viktor Frankl, it refers to a spiritually, existentially oriented therapy that seeks to achieve healing and health through meaning.

meaning-centered counseling and therapy Developed by Paul T. P. Wong, it focuses on the transformation of cognitive meanings as well as life's purposes. It integrates both cognitive-behavioral and narrative processes.

paradoxical intention A logotherapeutic technique to encourage the patient to do or wish to happen what the patient fears. It is built on the human capacity for self-detachment.

I. INTRODUCTION

This article will present an overview of Viktor Frankl's (1905–1997) logotherapy and existential analysis.

Known as the “Third Viennese School of Psychotherapy,” logotherapy was developed in the 1930s because of Frankl's dissatisfaction with both Freud and Adler.

Frankl accepts Sigmund Freud's concept of unconsciousness but considers the will to meaning as more fundamental than the will to pleasure. Existential analysis is designed to bring to consciousness the “hidden” meaning or spiritual dimension of the client.

Frankl received training in individual psychology from Adler. He differs from Adler because he focuses on the will to meaning, while Adler emphasizes social interest and the will to power. However, some of the basic concepts of logotherapy, such as freedom and responsibility, bear the imprint of Adler's influence.

A major difference between logotherapy and psychoanalysis is that both Freud and Adler focus on the past, while logotherapy focuses rather on the future—on the meanings to be fulfilled.

Although logotherapy and existential analysis tend to be used interchangeably or together as a single label, it may be helpful to recognize the following difference between these two terms:

Logotherapy means therapy through meaning, and it refers to Frankl's spiritually oriented approach to psychotherapy. *Existential analysis*, on the other hand, refers to the analytical therapeutic process involved in addressing the patient's spiritual, existential needs. To the extent that logotherapy makes the patient aware of the hidden meaning of existence, it is an analytical process.

Logotherapy is a distinct branch of existential–humanistic school psychotherapy, because of its focus on

the human spirit and “the meaning of human existence as well as on man’s search for such a meaning.” What sets Frankl apart from North America’s existential psychotherapy is his unconditional affirmation of life’s meaning. The main objective of logotherapy was to facilitate clients’ quest for meaning and empower them to live meaningfully, responsibly, regardless of their life circumstances.

Logotherapy was put to severe test in a very personal way between 1942 and 1945, when Frankl was committed to Nazi concentration camps. His experience in these camps was recorded in his best-selling book *Man’s Search for Meaning*. His personal triumph over unimaginable trauma has been the most compelling testimony to logotherapy. There are no other psychotherapists whose life and work are as inseparable as Frankl’s. He is logotherapy, and vice versa.

II. THE SPIRITUAL DIMENSION

It is not possible to practice logotherapy without understanding the human spirit or the spiritual dimension of human existence. According to Frankl’s dimensional ontology, human beings exist in three dimensions—somatic, mental, and spiritual. Spirituality is the uniquely human dimension. However, these different dimensions must be understood in their totality because a person is a unity in complexity.

A. The Defiant Power of the Human Spirit

One of the prepositions of logotherapy is that the human spirit is our healthy core. The human spirit may be blocked by biological or psychological sickness, but it will remain intact. The human spirit does not get sick, even when the psychobiological organism is injured.

According to Frankl, part of the human spirit is unconscious. When the human spirit is blocked or repressed, one experiences existential vacuum or neurosis. Existential analysis seeks to remove the block and brings to consciousness the will to meaning.

According to Joseph Fabry, the noetic dimension of the human spirit is the “medicine chest” of logotherapy; it contains love, the will to meaning, purpose, creativity, conscience, the capacity for choice, responsibility, sense of humor, and so forth.

The defiant power of the human spirit refers to people’s capacity to tap into the spiritual part of the self and rise about the negative effects of situations, illness

or the past. Paul T. P. Wong proposes that it may be more helpful for scientific and therapeutic purposes to conceptualize the human spirit as inner resources, which can come to one’s aid in coping with life stress.

B. Logotherapy and Religion

Frankl differentiates between spirit, spirituality, and religion. Spirit refers to one of the dimensions of humanity. Spirituality is manifest in a person’s quest for meaning. Religion encompasses the ultimate meaning, super meaning, as well as God. He clearly recognizes the importance of religion but is reluctant to be considered religious. He equates authentic religion with deep spirituality.

In an interview with Matthew Scully in 1995, when Frankl was already 90, he seemed to be more explicit about the important role of religion and faith in logotherapy. Frankl said:

I have come to define religion as an expression, a manifestation, of not only man’s will to meaning, but of man’s longing for ultimate meaning, that is to say a meaning that is so comprehensive that it is no longer comprehensible ... But it becomes a matter of believing rather than thinking, of faith rather than intellect. The positing of a super-meaning that evades mere rational grasp is one of the main tenets of logotherapy, after all. And a religious person may identify Supermeaning as something paralleling a Superbeing, and this Superbeing we would call God.

III. THE MEANING OF MEANING

The Greek word *logos* represents the word, the will of God, the controlling principles of the universe, or meaning. Dr. Frankl translates *logos* as meaning. Therefore, logotherapy means healing and health through meaning. But what is meaning?

A. Specific versus Ultimate Meaning

According to Frankl, there are two levels of meaning: (a) the present meaning, or meaning of the moment, and (b) the ultimate meaning or super-meaning. Dr. Frankl believes that it is more productive to address specific meaning of the moment, of the situation, rather than talking about meaning of life in general, because ultimate meanings exist in the supra-human dimension, which is “hidden” from us. He cautions

against addressing ultimate meanings in therapy, unless the client is openly religious.

Each individual must discover the specific meanings of the moment. Only the individual knows the right meaning specific to the moment. The therapist can also facilitate the quest and guide the client to those areas in which meanings can be found.

B. Meaning versus Value

In his earlier writings, Frankl often used meaning and value interchangeable. Fabry has clarified the difference between meaning and value:

We create unique relationships and accept unique tasks, face unique sufferings, experience unique guilt feelings and die a unique death. The search for meaning is highly personal and distinct. But millions of people have gone through situations that were similar enough so they could react in a similar way. They found what was meaningful in standard situations. They found universal meanings, which is the way Frankl defines values: "meaning universals."

Therefore, values are abstract meanings based on the meaning experiences of many, many individuals. Frankl believes that these values can guide our search for meaning and simplify decision making. For example, life can be made meaningful if we realize three categories of values—experiential, creative and attitudinal.

Traditional values are the examples of the accumulation of meaning experiences of many individuals over a long period of time. However, these values are threatened by modernization. Frankl believes that "Even if all universal values disappeared, life would remain meaningful, since the unique meanings remain untouched by the loss of traditions."

Implicit in all his writings, Frankl gives the impression that values, like Kant's categorical imperatives, are somehow universal, from which specific meanings flow. Thus, every experience of meaning involves the realization of some values. But these values may lie latent and need to be awakened or cultivated through existential analysis. This kind of reasoning may explain why Frankl insists: "The meaning of our existence is not invented by ourselves, but rather detected."

IV. BASIC TENETS

The logotherapeutic credo consists of freedom of will, will to meaning, and the meaning of life. These are the cornerstones of logotherapy and existential analysis.

A. Freedom of Will

Frankl realizes that "Human freedom is finite freedom. Man is not free from conditions. But he is free to take a stand in regard to them. The conditions do not completely condition him." Although our existence is influenced by instincts, inherited disposition, and environment, an area of freedom is always available to us. "Everything can be taken from a man, but ... the last of the human freedoms—to choose one's attitude in any a given set of circumstances, to choose one's own way." Therefore, we always have the freedom to take a stand toward the restrictive conditions and transcend our fate.

Freedom of will is possible because of the human capacity for self-distancing or self-detachment: "By virtue of this capacity man is capable of detaching himself not only from a situation, but also from himself. He is capable of choosing his attitude toward himself."

B. Responsibility and Responsibleness

With freedom comes responsibility. Joseph Fabry once said responsibility without freedom is tyranny, and freedom without responsibility leads to anarchy, which can lead to "boredom, anxiety, and neurosis." Frankl points out that we are responsible not only to something but also to Someone, not only to the task, but to the Taskmaster.

Frankl differentiates between responsibility and responsibleness. The former comes from possessing the freedom of will. The latter refers to exercising our freedom to make the right decisions in meeting the demands of each situation. "Existential analysis aims at nothing more and nothing less than leading men to consciousness of their responsibility."

C. Will to Meaning

Frankl considers the will to meaning as "the basic striving of man to find and meaning and purpose." The will to meaning is possible because of the human capacity to transcend immediate circumstances. "Being human is being always directed, and pointing to, something or someone other than oneself: to a meaning to fulfil or another human being to encounter, a cause to serve or a person to love."

Self-transcendence often makes use of the power of imagination and optimism. Self-transcendence is essential for finding happiness, which is not the end, but the by-product of trying to forget oneself. "Only to the

extent to which man fulfils a meaning out there in the world, does he fulfil himself.”

D. Meaning of Life

Every meaning is unique to each person, and each one has to individually discover the meaning of each particular situation. The therapist can only challenge and guide the patient to potential areas of meaning: creative, experiential, and attitudinal values.

According to logotherapy, we can discover this meaning in life in three different ways: (1) by creating a work or doing a deed; (2) by experiencing something or encountering someone; and (3) by the attitude we take toward unavoidable suffering.

Attitudinal values are especially important in situations of unavoidable suffering. Frankl claims: “This is why life never ceases to hold meaning, for even a person who is deprived of both creative and experiential values is still challenged by a meaning to fulfil, that is, by the meaning inherent in the right, in an upright way of suffering.”

V. EXISTENTIAL FRUSTRATION AND NOOGENIC NEUROSIS

Existential frustration is a universal human experience because the will to meaning can be blocked by external circumstances and internal hindrances. Existential frustration leads to noogenic neurosis or existential vacuum. According to Frankl, “Noogenic neuroses have their origin not in the psychological but rather in the ‘noological’ (from the Greek *noos* meaning mind) dimension of human existence.” Therefore, logotherapy is uniquely appropriate in dealing with existential neuroses.

Existential vacuum refers to general sense of meaninglessness or emptiness, as evidenced by a state of boredom. It is a widespread phenomenon of the twentieth century, as a result of industrialization, the loss of traditional values, and dehumanization of individuals. People may experience existential vacuum without developing existential neurosis. Many feel that life has no purpose, no challenge, no obligation, and they try to fill their existential vacuum with material things, pleasure, sex, or power, busy work, but they are misguided. Frankl believes that “The feeling of meaninglessness not only underlies the mass neurotic triad of today, i.e., depression-addiction-aggression, but also may eventuate in what we logotherapists call a ‘noogenic neurosis.’”

Suffering is not a necessary condition for meaning, but it tends to trigger the quest for meaning. Frankl has

observed that people are willing to endure any suffering, if they are convinced that this suffering has meaning. However, suffering without meaning leads to despair.

Logotherapists do not ask for the reason for suffering, but guide their clients toward the realization of concrete meanings, and choose the right attitudes. Often, logotherapists appeal to their clients to take a heroic stand toward suffering, by suggesting that unavoidable suffering gives them the opportunity to bear witness to the human potential and dignity.

Search for meaning is more likely to be occasioned by three negative facets of human existence: pain, guilt, and death. Pain refers to human suffering, guilt to the awareness of our fallibility, and death to our awareness of the transitoriness of life. These negative experiences make us more aware of our needs for meaning and spiritual aspiration. Neuroses are more likely to originate from our attempt to obscure the reality of pain, guilt, and death as existential facts. Logotherapy provides an answer to the tragic triad through attitudinal values and tragic optimism.

VI. LOGOTHERAPEUTIC TECHNIQUES AND APPLICATIONS

Frankl considers noogenic neurosis as the collective neurosis of contemporary Western society. The goal of logotherapy is to enable patients to discover their unique meanings and consider their own areas of freedom. In cases of psychogenic or individual neurosis, which may be treated by traditional psychotherapy or medication, logotherapy serves as a supplement and helps break the vicious cycles of neurosis.

According to E. Lukas, the four main logotherapeutic techniques are paradoxical intention, dereflection, modification of attitudes, and appealing techniques.

A. Paradoxical Intention

Frankl defines paradoxical intention as follows: “The patient is encouraged to do, or to wish to happen, the very things he fears (the former applying to the phobic patient, the latter to the obsessive-compulsive).”

This technique builds on the human capacity for self-detachment to break the vicious cycle, which traps people in psychogenic neuroses, such as phobia, anxiety, and obsessive—compulsive behaviour. Self-attachment enables the patient to adopt a new attitude, to stand back or laugh at the situation or self. In applying paradoxical intention, the therapist tries “to mobilize and utilize exclusive human capacity for humor.”

For the phobic patient, he has a “fearful expectation” that a particular symptom might occur, and his fear creates “anticipatory anxiety, which in turn brings about what the patient fears to happen. Thus “fear of fear” creates a “vicious cycle.” The most common reaction to “fear of fear” is “flight from fear,” and the phobic pattern is maintained by excessive avoidance. This vicious cycle is broken when “the pathogenic fear is replaced by a paradoxical wish.” As a result, the patient no longer avoids situations that create anxiety.

With phobic patient, paradoxical intention typically begins with self-detachment (often after invitation and persuasion). The second step is to ask the patient to develop a new attitude of not fearing but welcoming the symptoms. This typically results in a reduction of symptom, which allows therapist to work toward enhancing meaningful living.

In the case of obsessive–compulsive disorder, the patient fights against the obsessions or compulsions. However, the more he fights against these symptoms, the stronger they become. Again, a vicious cycle is created. To break this vicious cycle, the patient with compulsive hand washing because of fear of infection would be told to tell himself “I can’t get enough bacteria, I want to become as dirty as possible.”

According to D. Guttman, paradoxical intention has been used with increasing frequency with good results especially in treating clients who suffer from phobias and obsessive–compulsive disorder.

B. Dereflexion

Frankl developed dereflexion to counteract hyperintention (trying too hard) and hyperreflection (thinking too hard). Examples of hyperintention include trying very hard to fall asleep, excessively pursuing pleasure, happiness, or power. Addiction is a form of hyperintention.

Hyperreflection involves excessively monitoring one’s performance, and becoming very anxious about failure. Hyperreflection may turn everyday minor problem into catastrophes, and small obstacles into insurmountable hurdles.

This technique is built on the human capacity of self-distancing and self-transcendence. The clients are asked to redirect their attention away from their problems to more positive aspects of their lives. For example, instead of worrying about not being able to fall asleep, the client is asked to use the time to read a book or watch TV. Typically, the first step is to help clients to put some distance between themselves and their symptoms. Then, they are invited to use their defiant power

of the human spirit to transcend their present conditions and move toward positive activities. This will result in a reduction of symptom.

Joseph Fabry points out that by immersing ourselves in work or by choosing the right attitude, we can transcend not only external conditions but also ourselves. The goal of dereflexion is to help clients transcend themselves and move toward creative and experiential values.

C. Modification of Attitudes

It is used for noogenic neuroses, depression, and addiction by promoting the will to meaning. It can also be used in coping with suffering related to circumstances, fate or illness. Generally, the emphasis is on reframing attitudes from negative to positive. For example, the client may be asked: “Is there anything positive about the situation?” or “What freedom is still available to you in this situation?”

D. The Appealing Technique

These three logotherapeutic techniques are more likely to be effective, when the therapist appeals to the client’s defiant power of the human spirit. The therapist makes use of the power of suggestion and directly appeals to the client to change for the better, regardless of the client’s current circumstances, and physical–emotional condition. The therapist expresses trust in the client’s dignity, freedom, responsibility, meaning orientation, and potential for positive change.

Frankl claims that “Logotherapy is neither teaching nor preaching. It is far removed from logical reasoning as it is from moral exhortation.” However, appealing often involves exhortation on the value of taking a heroic stand against suffering. For example, a nurse suffered from an inoperable tumor and experienced despair because of her incapacity to work. Frankl tried to appeal to her sense of pride and moral obligation to her patients:

I tried to explain to her that to work eight or ten hours per day is no great thing—many people can do that. But to be as eager to work as, and so incapable of work, and yet not be despair—that would be an achievement few could attain. And then I asked her: “Are you not being unfair to all those sick people to whom you have dedicated your life; are you not being unfair to act now as if the life of an invalid were without meaning? If you behave as if the meaning of our life consisted in being able to work so many hours a day, you take away from all sick people the right to live and the justification for their existence.

E. The Socratic Dialogue

In Socratic dialogue, the therapist facilitates the client's discovery of meaning, freedom, and responsibility by challenging and questioning. The dialogue may begin with a struggle between client and therapist but should never become negative.

According to Paul Welter: "Socratic questions need to be asked that stretch the thinking of the client. This requires careful listening to find the circumference of the client's thought." Another consideration is that counselors need to know the moment when silence is more curative. Often silence occurs when the clients reflect on the deeper meanings of words from the counsellors.

F. Family Logotherapy

J. Lantz has applied logotherapy to help the client family discover the meaning of opportunities within the family through social skills training, Socratic questioning, and existential reflection. According to E. Lukas, meaning-centered family therapy helps the family focus on meaningful goals rather than the obstacles; consequently, family members learn to overcome the obstacles to pursue meaningful goals.

G. The Therapist–Client Relationship in Logotherapy

Frankl tends to emphasize partnership between therapist and client in the quest for meaning. According to Lantz, logotherapeutic practice is based on the following assumptions: (a) commitment to authentic communication by the therapist, (b) the therapists' communication of essential humanness, and c) the therapist's ultimate concern being similar to that of the clients.

VII. RECENT DEVELOPMENTS

In the past 15 years, Dr. Frankl's classic logotherapy has been elaborated and extended by Alfred Langle and the International Association of Logotherapy and Existential Analysis (*Gesellschaft fur Logotherapie und Existenzanalyse*). This Viennese society (GLE-Wien) is parallel to Viktor-Frankl-Institut–Scientific Society for Logotherapy and Existential Analysis (*Wissenschaftliche fur Logotherapie und Existenzanalyse*), also in Vienna.

According to A. Langle, existential analysis is now a full-fledged psychotherapeutic method, of which Dr. Frankl's logotherapy is considered its subsidiary branch.

Langle has applied existential analysis to cases of psychosocial, psychosomatic, and psychogenic disturbances.

Langle recognizes four fundamental preconditions for meaningful existence: (a) accept the situation, (b) find some positive value in the situation, (c) respond according to one's own conscience, and (d) recognize the specific demands of the situation.

He also postulates four types of fundamental human motivations:

1. The question of existence: I am, but can I become a "whole" person? Do I have the necessary space, support, and protection?
2. The question of life: I am alive, but do I enjoy it? Do I find it fulfilling? Do I experience a sense of abundance, love, and realization of values?
3. The question of the person: I am myself, but am I free to be myself? Do I experience validation, respect, and recognition of my own worth?
4. The question of existential meaning: I am here, but for what purpose, for what good?

Langle has developed additional methods, such as the biographical method of using phenomenological analysis to overcome unresolved past issues and the project analysis to elucidate areas that have proved to be a hindrance to one's life.

Joseph Fabry was largely responsible for introducing logotherapy to North America. Under his guidance and encouragement, Paul T. P. Wong has developed the integrative meaning-centred counselling and therapy (MCCT). It focuses on both the transformation of cognitive meanings as well as the discovery of new purposes in life. As an integrative existential therapy, it incorporates cognitive-behavioral interventions and narrative therapy with logotherapy.

See Also the Following Articles

Alderian Psychotherapy ■ Biblical Behavior Modification ■ Existential Psychotherapy ■ Humanistic Psychotherapy ■ Paradoxical Intention

Further Reading

- Fabry, J. (1994). *The pursuit of meaning* (new rev. ed.). Abilene, TX: Institute of Logotherapy Press.
- Frankl, V. E. (1984). *Man's search for meaning* (rev. and updated). New York: Washington Square Press/Pocket Books.
- Frankl, V. E. (1986). *The doctor and the soul: From psychotherapy to logotherapy* (Rev. and expanded). New York: Vintage Books.

- Guttman, D. (1996). *Logotherapy for the helping professional: Meaningful social work*. New York: Springer.
- Langle, A. (2000). Existential analysis. Übersetzung von 1999 *Fundamenta Psychiatrica: EA – die Zustimmung zum Leben finden*.
- Lantz, J. (1996). Stages and treatment activities in family logotherapy. *The International Forum for Logotherapy*, 19, 20–22.
- Lukas, E. (1984). *Meaningful living*. New York: Grove Press.
- Lukas, E. (1991). Meaning-centered family therapy. *The International Forum for Logotherapy*, 14, 67–74.
- Welter, P. (1987). *Counseling and the search for meaning*. Waco, TX: Word Books.
- Wong, P. T. P. (1999). Towards an integrative model of meaning-centered counselling and therapy. *The International Forum for Logotherapy*, 22, 47–55.



Manualized Behavior Therapy

Michael J. Zvolensky

University of Vermont

Georg H. Eifert

University of Hawaii

- I. Description of Manualized Behavior Therapy
 - II. Theoretical Bases of Manualized Behavior Therapy
 - III. Applications and Exclusions
 - IV. Empirical Studies
 - V. Case Illustration
 - VI. Summary
- Further Reading

GLOSSARY

- behavior therapy** Application of interventions based on an understanding of learning principles.
- effectiveness** The degree to which a treatment produces positive outcomes in the context in which treatment most often is sought (i.e., “real world”).
- efficacy** Demonstrations that an intervention improves psychological status in well-controlled, experimental studies.
- functional analysis of behavior** Isolation of proximate, contextual causes of problematic behavior and the tailoring of therapy protocols to reverse these causes once identified.
- multicomponent treatment strategies** Therapies that contain treatment elements that are based on behavioral and cognitive-affective processes.
- treatment integrity** Degree to which the implementation of a specific treatment matches the way it was conceptualized and intended to be employed.
- treatment manuals** Written materials that identify key concepts, procedures, and tactics for the delivery of a clinical intervention.

I. DESCRIPTION OF MANUALIZED BEHAVIOR THERAPY

A. Treatment Manual Description

In general, treatment manuals for psychological disorders are written materials that identify key concepts, procedures, and tactics for the delivery of a clinical intervention. Accordingly, treatment manuals are designed to help modify the variables and processes believed to produce, maintain, or increase the magnitude or frequency of problematic behavior. As is typical of treatment methods in general, there is considerable diversity in regard to the level of specification in a particular manualized therapy, which is contingent, at least in part, on the treatment strategy being employed. Despite this diversity, all manualized therapies provide rules and statements pertaining to how therapists are to prepare for treatment, describe what they should do during the session itself, and characterize how the process of therapy is to proceed over time. In the case of behavior therapy, which reflects the application of interventions largely based on an understanding of psychological learning principles, manuals serve to characterize the treatment process for persons with an identified psychological disorder.

At least initially, the primary aim of developing and implementing manualized behavior therapies was to improve the evaluation of particular treatment strategies and entire treatment programs. Within this context,

manuals served to specify (in abbreviated form) the nature of the treatment, and articulate (in detail) how it was to be delivered. In this way, researchers would have available a precise and standardized clinical methodology that could easily be used in the evaluation of a particular treatment's efficacy. In addition, manuals provided researchers with the opportunity to standardize training in a specific treatment to increase the chance that the therapy would be delivered in the manner designated by and consistent with the theoretical underpinnings of the approach. Today, the development and utilization of manualized behavior therapies reflect an important breakthrough in the larger history of developing and evaluating psychosocial treatments for behavior disorders.

B. Reasons for Treatment Manuals in Mental Health Work

With the advantage of hindsight, it is quite easy to identify a number of key reasons why manualized therapies originally emerged in the mid to late 1970s. Prior to having standardized treatment methods and procedures, researchers often were left "in the dark" in regard to how a particular treatment was delivered. In the best-case scenario, questions about the effects of a clinical trial could be directed at how well a particular treatment was delivered. In the worst-case scenario, it was possible to question whether a particular treatment was really delivered at all, or at least whether the key components of that therapy were implemented. Other types of common concerns were aimed at such issues as whether the therapy under investigation was delivered in a consistent fashion across study participants. Still other concerns were aimed at how well the results could be replicated across independent research sites. All the questions, and others similar to them, essentially reflect questions of treatment integrity. A prerequisite for adequately addressing questions of treatment integrity from a scientific standpoint is to have a methodology that identifies the treatment of interest, and guides one in a step-by-step manner in regard to how it should be delivered.

In more recent years, the development and utilization of manualized behavior therapies have exceeded the boundaries of research circles. Indeed, the use of manuals in clinical contexts with no clear research objectives has been spurred on by health care policy changes demanding that psychological services follow guidelines for relatively brief treatments that have an empirical basis for outcome. Thus, despite

the fact that manuals have helped to improve the quality of large-scale clinical trials in accordance with their original intended purpose, it is perhaps not surprising that they increasingly have been the subject of controversy and intense debate. In fact, the use of treatment manuals has called attention to clinical issues that strike at the very heart of what treatment should be considered clinically useful and in what contexts it should be implemented (e.g., controlled or real world settings).

II. THEORETICAL BASES OF MANUALIZED BEHAVIOR THERAPY

A. General History

At the time of inception of behavior therapy, the prevailing paradigm in clinical psychology was psychodynamic. Since that time there has arguably been a major paradigmatic shift from psychoanalytic approaches to behavioral approaches. This transition was based, at least in part, on the observation that psychoanalytic methods for treating behavioral disorders have not been consistently demonstrated to be superior to no treatment, placebo, or other treatment conditions. In contrast, investigations of behavior therapy have emphasized empirical scrutiny and quantifiable behavior change. As a consequence, behavior therapy applications have been widely recognized as being very successful for treating a wide variety of behavioral problems, ranging from anxiety disorders to developmental disabilities.

B. Function Oriented

Behavior therapy differs from other forms of psychological therapies in regard to its commitment to basic research and link with behavior theory. Specifically, behavior therapy is aimed at determining environment-behavior relations that either can explain the cause or maintenance of maladaptive behaviors individuals typically seek treatment for in clinical settings. Elucidation of these environment-behavior relations has emerged from behavioral research, most notably operant and classical conditioning. Congruent with the laboratory research on which it is based, behavior therapy focuses on the function rather than the structure of behavior. In the most general sense, structural analyses focus on how people behave (e.g., form of a

particular response), whereas functional analyses focus on why people behave (e.g., purpose of a particular response).

In a functional approach, behavior therapists attempt to explicate the relation between observable behavior and the contextual variables of the environment, particularly focusing on observable antecedents and consequences of behavioral responses. For example, if a child's recurrent tantruming in a school classroom is routinely followed by attention from the teacher, a behavior therapist might encourage the teacher to praise the child when the child is not tantruming and ignore the child when a tantrum occurs. Thus, tantruming behavior aimed at receiving attention is not reinforced, thereby changing the function of such responding. This process of assessment, called a functional analysis of behavior, is the core of behavior therapy approaches.

C. Idiographic Oriented

The other major theoretical component of behavior therapies is that they have historically been idiographic (i.e., individual) rather than nomothetic (i.e., group) approaches to assessing and changing behavior. Nomothetic approaches, by definition, focus on the identification of the commonalities and differences among traits and dispositions that occur within and between groups of people. Idiographic approaches, on the other hand, focus on variability in the behavior of a person over time and across situations. As such, a second aim of the functional analysis is to identify consistent sources of variance for a particular person presenting to the clinic with a specific behavioral problem.

Despite the uniformity among behavior therapists commonly perceived by the public, it is important to note that not all behavior therapists are alike. Indeed, there are different behavioral approaches, differing in specific aspects of their clinical approach and the focus of treatment. This diversity is reflected in the numerous terms that have been employed to describe this general therapeutic approach (e.g., applied behavior analysis, behavior modification, cognitive-behavior therapy). Although these various terminologies capture relative differences in one's specific approach, behaviorally oriented therapists are all committed to changing maladaptive behavior through a functional, idiographic-based assessment of specified target behaviors. Thus, even in the case of standardized treatment manuals that identify the major processes functionally related to a particular disorder, treatments are tailored to the individual—at least at the level of

practical implementation. Through this identification of the controlling variables, it has been possible to develop standardized treatment strategies that are based on behavior principles to alter problematic behavior. To achieve these goals, behavior therapists attempt to provide their patients with a new set of learning experiences that are in accord with positive behavior change within the patients' value system.

III. APPLICATIONS AND EXCLUSIONS

A. Empirically Supported Therapies and the Use of Treatment Manuals

There have a number of important developments within the behavioral health care that have come to shape the application of manualized behavior therapies. Perhaps most influential has been the push to establish empirically supported therapies for a variety of recognized psychological disorders. This movement has been at least partially in response to cost-containment efforts in the health care system in general and funding-related restrictions for behavioral health services specifically. For example, health care policy changes have strongly recommended, and in certain cases demanded, that psychological services follow guidelines for relatively brief treatments that have an empirical basis for positive outcome.

The movement to develop lists of empirically supported therapies for target populations defined by diagnostic categories has been pioneered by the Division 12 Task Force on Promotion and Dissemination of Psychological Procedures. The function of the task force has been to critically review the existing empirical psychological treatment literature in an effort to identify those psychosocial interventions that have shown promise in alleviating specific types of psychological distress. Once potential treatments are identified and agreed on, the task force communicates this information to the behavioral health community. The task of charting efficacious treatments is an ongoing process, as researchers are continuously examining therapies, refining their components, and assessing their utility across different populations, sites, and time periods (see Section IV). In all cases, the therapies that are evaluated by the task force have been manualized to facilitate the understanding and evaluation of the treatment's key concepts, procedures, and delivery tactics.

B. Behavior Therapy's Contributions to Standardization of Psychosocial Treatments

As behavior therapy always has been committed to empirical evaluation and time-efficient strategies, it is not surprising behavior therapists have been at the forefront of the major developments in the movement toward empirically supported treatments. In fact, behavioral and cognitive-behavioral therapies overwhelmingly top the list of empirically supported therapeutic interventions for a wide variety of disorders. In an illustrative example, the majority of empirically supported treatments can be considered behavioral in their theoretical foundations, content, and implementation procedures. For example, of the “well-established treatments,” 93% are considered “behavioral” in content and procedures.

Whereas behavioral interventions were largely based on operant and classical conditioning principles through the late 1970s, cognitive treatment strategies have been increasingly added to these therapies from the 1970s through the 1990s. This evolution of behavior therapy reflects the growing recognition that internal processes such as thoughts and language characterize many important aspects of psychological dysfunctions. As an extension, many clinicians believe that by directly targeting cognitive-affective processes, they can facilitate positive behavior change along a greater number of different response domains. Thus, it is not surprising contemporary behavioral interventions can be best described as multicomponent strategies that contain treatment elements that are based on both basic learning principles and more recent developments in experimental cognitive psychology (e.g., research on memory biases). Hence, most behavior therapies are now described as cognitive-behavioral treatments and compiled in multiple component treatment manuals. Although it is not entirely clear at this juncture to what extent specific therapy components contribute to treatment outcome and maintenance, available evidence suggests that both cognitive and behavioral components contribute to the overall positive outcome achieved by cognitive-behavioral treatment protocols.

C. Contemporary Issues Related to the Potential Limitations of Manuals

There have been a number of controversies surrounding the use of manualized treatments (e.g., flexibility of therapist in treatment delivery, creativity of therapist, reification of treatment to a fixed manner). All these in-

tensely debated topics differ in content but essentially rest on questions concerning the relative utility of manualized treatments as applied to “real-world” behavior problems. For the purposes of this article, only two of the most common concerns will be described.

1. Manuals as Standardized Treatment Strategies

Some scholars have suggested that manualized behavior therapy undermines and restricts clinical judgment of individual therapists in the practice setting. Manualizing treatments could be problematic because most clinicians are highly sensitive to the individual needs and characteristics of their patients. Furthermore, greater degrees of flexibility often are needed to deliver treatment in the “real world” relative to when the treatments are developed and initially tested in clinical trials conducted in research settings.

Yet, these concerns must be weighed against the background of a large body of evidence that suggests personal biases typically are worse or at the very least not better than statistical prediction based on scientific analyses of persons with the same or similar type of problem. Thus, manualized treatments, which generally are based on scientific testing of groups of people, guide therapists in implementing what research rather than clinical judgment suggests is the most clinically appropriate thing to do. It is becoming increasingly evident that the “truth” lies somewhere between a strict individually tailored relative to a strict manualized approach. Indeed, insofar as a clinician can modify a manualized treatment to help identify and target aspects of an individual's behavior that might interfere with the successful implementation of a proven manual, success rates should continue to improve.

2. Manuals as Treatment Strategies for Comorbidity

Another concern raised about manualized therapies is that they often are developed from studies involving patients with a homogenous diagnostic profile yet are implemented clinically on patients with multiple behavior problems (i.e., diagnostic heterogeneity). Recent research in such areas as the anxiety disorders has seriously challenged this concern, as in the vast majority of clinical trials using manuals, patients have high rates of psychiatric comorbidity. In addition, many of these patients have not responded to alternative treatment strategies in the past, and in this respect, can be considered “treatment refractory” or at least “treatment resistant.” Of further interest has been the finding that

some manualized behavior therapies have been found to produce clinical improvement in other not specifically targeted behavior problems.

Taken together, then, it may be more appropriate to suggest that the clinical effectiveness of manualized treatment will be partially a function of presenting problem, nature of comorbidity, and the specific treatment being employed. With the recognition that this is a complex problem in need of further systematic study, it will be critically important for future research to address the generalizability of manualized behavior therapies across different clinical populations and settings. Along these lines, increased attention to questions of effectiveness will assume an increasingly critical role in determining the relative clinical utility and generalizability of particular psychosocial treatments.

IV. EMPIRICAL STUDIES

A. General Treatment Development and Evaluation Model

Psychosocial treatment development and dissemination is based on the stage model used by the Food and Drug Administration for the approval of drugs. Briefly, there are three primary units, each reflecting different stages in treatment development. Stage 1 reflects technological refinement and pilot research aimed at developing theoretically based treatment strategies that can usefully be applied to a specific type of psychopathology. Stage 2 is concerned with demonstrating that a particular treatment can produce positive behavior change in a controlled evaluation. In addition, in Stage 2, research can be aimed at ascertaining the mechanisms of action for a particular treatment (i.e., how it works). Stage 3 is field research involving larger samples of patients for the evaluation of treatments that already have shown initial success in Stage 2.

B. Empirically Supported Treatment Manuals

The empirically supported treatment task force evaluates all manualized therapies according to their efficacy; that is, demonstrations that an intervention improves psychological status in well-controlled, experimental studies. This research differs slightly from questions of effectiveness, defined as the relative degree of utility of a treatment to produce positive outcomes in the context in which treatment most often is sought. Typically, large-

scale clinical trials are used to evaluate and demonstrate the efficacy of psychological interventions. Such evaluations are outcome oriented, that is, they typically are an evaluation of a particular type of therapy compared to some type of control group (e.g., placebo, other form of therapy), although a variety of different evaluation formats exist (e.g., series of single case studies).

The criteria for demonstrating efficacy are categorized as either “well-established treatments” or “probably efficacious treatments.” Although it is not possible to review the criteria for each of these domains in their entirety, well-established therapies generally have demonstrated superior outcome compared to a control condition (e.g., placebo) or another treatment on two separate occasions by independent investigators. In contrast, probably efficacious treatments generally indicate that a treatment is superior to persons who desire psychological treatment but are on a waiting list for such treatment.

In all cases, the evaluation process involves persons with a particular type of psychological disorder being randomly assigned to a specified treatment condition. For example, patients with panic disorder may either be randomly assigned to receive an “active” psychological treatment or separate treatments such as a medical drug or a placebo pill. In these trials, patients are then evaluated in a standardized manner over the same amount of time using the same types of clinically relevant outcome measures. Overall, these efforts allow one to determine whether a therapy can reduce psychological distress in both a statistically and clinically useful way.

V. CASE ILLUSTRATION

For purposes of this article, a clinical case presentation of an individual with panic disorder may help illustrate the use of a multicomponent treatment manual that is prototypical for other treatment manuals used for the majority of psychological dysfunctions.

A. Case Description

Sam is a 33-year-old married white male with a 10-month history of recurrent panic attacks. His panic attacks occur in an unpredictable and uncontrollable manner and last for approximately 2 to 15 min. Sam indicated that his panic attacks occur at least once every other day and involve chest pain, difficulty breathing, racing and pounding heart, increased sweating, and lightheadedness. As a result of these symptoms, Sam

believed he had cardiac disease. Due to the worry about the panic attacks, Sam had begun to avoid socializing with friends and family and declined professional opportunities to travel for his job as a computer programmer. After a thorough medical exam that found no indication of cardiac or other medical problems, Sam was referred to an anxiety disorders treatment center at a university hospital. After a psychiatric interview and testing, it was determined Sam suffers from panic disorder.

B. Manualized Therapy for Panic Disorder

We now discuss how Sam might be treated with a current well-established therapy for panic disorder and agoraphobia termed panic control therapy (PCT). This multicomponent cognitive-behavioral intervention is guided by the use of a treatment manual entitled *Mastery of Your Anxiety and Panic-II (MAP-II)* that articulates the procedures for PCT in a step-by-step fashion. Manual-based therapies like the *MAP-II* also include self-report and behavioral assessment tracking instruments that can be readily employed to evaluate treatment progress of individual patients across different time frames.

MAP-II contains a number of key components, including exposure to bodily and environmental situations associated with fear and panic, relaxation, and breathing retraining, as well as cognitive interventions. Briefly, exposure to interoceptive bodily events is achieved through exercises that produce somatic sensations that are similar to panic (e.g., head spinning, breathing through a straw). Situational exposure involves contacting feared environmental stimuli without escaping from them if panic symptoms occur. For instance, a person with panic disorder with agoraphobia who fears crowds might be asked to go to a shopping center and stay there for a specified period of time or until potentially high levels of anxiety have subsided. Relaxation training refers to exercises that serve to decrease base levels of autonomic arousal, as this decreases the likelihood of future panic attacks. Breathing retraining refers to having patients breathe diaphragmatically at a normal rate in an effort to optimize the balance between oxygen and carbon dioxide in the patient's blood. Cognitive strategies typically are aimed at (a) correcting misappraisals of bodily sensations as threatening, (b) helping patients to predict more accurately the future likelihood of panic attacks, and (c) helping patients to predict more accurately and rationally the likely consequences of panic attacks.

C. Treatment Process with Manual

Sam's treatment would most likely be conducted in an individual setting over a period of about 2 months. As is the case for most psychosocial interventions, the *MAP-II* first provides Sam with educational information about the nature, origin, and course of panic disorder prior to the application of specific intervention strategies. This information helps patients realize that they are "not alone" and communicates that professionals understand their specific type of problem. The second and ongoing step in Sam's *MAP-II* treatment would be to have him monitor both negative emotional experiences and stressful life events to facilitate the recognition and identification of environmental events that contribute to the occurrence of recurrent panic attacks. Identifying such negative life events makes the potential occurrence of panic attacks more predictable and perhaps controllable, thereby lessening their aversiveness.

Third, the therapist would train Sam in relaxation and breathing exercises and have him practice these exercises until he has acquired the skill of reducing and controlling bodily arousal. Throughout *MAP-II* therapy, the therapist is instructed to guide Sam in correcting maladaptive cognitive errors related to worry about the negative consequences of panic attacks. For example, during cognitive restructuring, Sam would be taught to reconceptualize his panic attacks as harmless events that occur in response to "natural" stressors. Finally, Sam would participate in repeated trials of interoceptive exposure, and if necessary, exteroceptive exposure exercises in both the clinical setting and his natural environment. Such exercises would be continued until such stimuli no longer elicit significant levels of anxiety. Therapy would be discontinued when Sam's condition improved to a level that he can adequately perform his life tasks and his psychological status has returned to a healthy level.

VI. SUMMARY

In summary, treatment manuals are written materials that identify key concepts, procedures, and tactics for the delivery of a clinical intervention. In this manner, treatment manuals are designed to help modify clinically relevant variables and processes involved with problematic behavior. Although manuals can be quite diverse, all provide rules and statements pertaining to how the therapist is to prepare for treatment, describe what they should do during the session itself, and characterize how the process of therapy is to proceed over

time. Manuals have greatly helped in efforts to improve the evaluation of particular treatment strategies by specifying the nature of the treatment and articulate how it is to be delivered. More recent, manualized behavior therapies have become apparent in clinical service contexts, calling attention to clinical issues that strike at the very heart of what treatment should be considered “clinically useful” and in what contexts it should be implemented (e.g., controlled or real-world settings).

An extension of the treatment utility issue has been the development of empirically supported therapies for target populations pioneered by the Division 12 Task Force on Promotion and Dissemination of Psychological Procedures. Testifying to the established place of manuals in contemporary clinical care, all therapies that are evaluated by the task force have been manualized so as to facilitate the understanding and evaluation of the treatment’s key concepts, procedures, and delivery tactics. Perhaps because behavior therapy has always been committed to empirical evaluation and time-efficient strategies, it is not surprising the majority of empirically supported treatments can be considered behavioral in their theoretical foundations, content, and implementation procedures. Although the use of manuals has been controversial in a number of respects, few would challenge the contention that they likely will retain in an important and influential role in continued evolution of psychological treatment in upcoming years.

See Also the Following Articles

Behavioral Consultation and Therapy ■ Behavior Therapy: Theoretical Bases ■ Cognitive Behavior Therapy ■ Collaborative Care ■ Comorbidity ■ Effectiveness

■ Integrative Approaches to Psychotherapy ■ Multimodal Behavior Therapy ■ Panic Disorder and Agoraphobia ■ Research in Psychotherapy

Further Reading

- Chambless, D. L., Sanderson, W. C., Shoham, V., Bennett-Johnson, S., Pope, K. S., Crits-Christoph, P., Baker, M., Johnson, B., Woody, S. R., Sue, S., Beutler, L., Williams, D. A., & McCurry, S. (1996). An update on empirically validated therapies. *The Clinical Psychologist, 49*, 5–18.
- Eifert, G. H., Schulte, D., Zvolensky, M. J., Lejuez, C. W., & Lau, A. W. (1998). Manualized behavior therapy: Merits and challenges. *Behavior Therapy, 28*, 499–509.
- Garfield, S. L. (1996). Some problems associated with “validated” forms of psychotherapy. *Clinical Psychology: Science and Practice, 3*, 218–229.
- Heimberg, R. C. (1998). Manual-based treatment: An essential ingredient of clinical practice in the 21st century. *Clinical Psychology: Science and Practice, 5*, 387–390.
- Persons, J. B. (1991). Psychotherapy outcome studies do not accurately represent current models of psychopathology. *American Psychologist, 46*, 99–106.
- Society for Science of Clinical Psychology. <http://pantheon.yale.edu/~tat22/>
- Task Force on Promotion and Dissemination of Psychological Procedures. (1995). Training in and dissemination of empirically validated psychological treatments: Report and recommendations. *The Clinical Psychologist, 48*, 3–23.
- Wade, W., Treat, T. A., & Stuart, G. L. (1998). Transporting an empirically supported treatment for panic disorder to a service setting: A benchmarking strategy. *Journal of Consulting and Clinical Psychology, 66*, 231–239.
- Wilson, G. T. (1996). Manual-based treatments: The clinical application of research findings. *Behaviour Research and Therapy, 34*, 295–315.

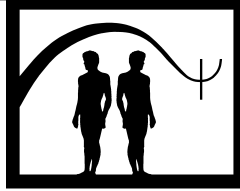

Matching Patients to Alcoholism Treatment

Margaret E. Mattson

National Institute on Alcohol Abuse and Alcoholism

- I. Description of Treatment
 - II. Theoretical Bases
 - III. Empirical Bases
 - IV. Summary
- Further Reading

others and that, in clinical practice, treatment outcomes can be improved by matching subgroups of patients with the therapy most suited to their particular needs using matching rules derived from previous experience.

GLOSSARY

alcoholism Alcoholism (also referred to as alcohol dependency) is an addictive disorder diagnosed by a series of specific DSM defined criteria such as, progressive loss of control over drinking, tolerance, withdrawal symptoms, continued drinking despite adverse consequences, narrowing of usual activities in favor of alcohol seeking.

clinical trial A clinical trial is a prospective experiment in which therapeutic interventions are evaluated. Desirable features which increase the rigor of the experiment include random assignment to treatment group, masking of clinician, research assessor and patient with respect to treatment assignment, and in the case of pharmacologic studies, use of matched placebo.

matching factors Matching factors are patient characteristics that affect outcomes differentially when two or more treatments are compared.

outcome predictors Outcome predictors are characteristics that influence the outcome of treatment across the board but do not have differential effects depending upon the type of treatment.

Patient-treatment matching is the concept that particular treatments may work better for some patients than

I. DESCRIPTION OF TREATMENT

Patient-treatment matching occurs when treatment is prescribed based on the needs of the individual patient, as contrasted with providing the same therapy to all patients with the same diagnosis. It has been suggested that triaging clients to treatments based on their particular needs and characteristics might significantly improve outcome. The potential of the matching hypothesis has been of particular interest in the treatment of alcohol use disorders, prompting researchers and clinicians to search for assignment rules to individualize selection of psychosocial treatments. The literature in this area spans several decades and includes small-scale studies, reports from a large multisite clinical trial, and examinations of underlying theory and clinical practice implications. It provides a useful example to illustrate the rationale and implementation of the matching hypothesis and is used as the model here. Although the focus here is alcohol dependency as the target for patient treatment matching interventions, the concept is relevant to other disorders and has been used to varying extents in numerous medical, psychiatric, and educational contexts.

In its most basic form, matching is done informally by providers when, based on their clinical judgment,

they provide treatment “tailored” to specific features of the patient and the patient’s disorder. Patients may also practice “self-matching” when they contribute to varying degrees to treatment decisions based on, for example, their beliefs about various treatments and what will benefit them, or other influences, such as availability of resources, advice from others, and so on.

However, the formal practice of matching in clinical and research settings is based on validated rules that link particular patient characteristics with certain treatments. Typical steps in the matching process are: (a) systematic assessment of patient characteristics and needs, (b) availability of specific matching rules, and (c) consistent assignment of patients to well-defined treatment in accordance with the specified matching rules. Ideally, the guidelines should be based on validated research, and patient outcomes should be monitored to determine the extent of improvement and if modifications are necessary.

In addition to matching patients with treatments, matching of patients to therapists has also been of interest and is reviewed by the Project MATCH Research Group in 1998 who concluded that therapist effects on treatment outcome may contribute more toward explaining the variance in outcomes than either specific treatments employed or baseline patient characteristics. Reporting on a study of therapist influence on treatment outcome conducted as a part of the multisite Project MATCH, they found that therapist effects did indeed exert an effect on treatment outcome as well as patient satisfaction with treatment. Interestingly though, most of the observed effects were due to “outlier” therapists whose clients tended to show poorer outcomes. They advise that future studies take into account the potential effect of “outlier” therapists.

Until relatively recently, matching to treatments for alcohol dependence has involved interventions of a verbal nature, such as behavioral therapies, counseling, and psychotherapy. Beginning in the 1990s, the development of medications that target neurochemical systems implicated in the addictive process have brought a new and promising approach to treatment of alcoholism. In addition to clinical trials evaluating the efficacy of these drugs, (both alone and in combination with verbal therapies) matching hypotheses have also been tested. As knowledge emerges on the neurochemical and neurogenetic determinants of alcohol addiction, the rationale is strengthened for hypothesizing that outcome may be improved when particular neuroactive medications are linked to certain patient characteristics of known biological basis.

II. THEORETICAL BASES

Interactions differ from predictors in that predictors affect the outcome of treatments in a similar way (Figure 1A). In contrast, interactions arise when the patient characteristic of interest has a differential effect on the treatments being compared (Figure 1B and 1C). Thus, the main effects of different treatments may suggest that they have similar benefits, however, analyses that examine the interactions between certain patient and treatment types may make differential benefits evident.

The idea of matching is not new, having first been proposed in the alcohol treatment area in 1941 by K. Bowman and E. Jellinek and is common to other fields such as psychiatry, medicine, and education. R. E. Snow in 1991 discussed aptitude-treatment interactions as derived from the educational psychology literature as a framework for research on individual differences in psychotherapy.

Matching came to be of interest to alcoholism treatment researchers when despite decades of outcome research no clearly and generally superior treatment(s) that could be considered the “magic bullet” of alcoholism treatment emerged. In parallel, thinking concerning the nature of alcoholism diversified and a view of the disorder as the end result of a complex interaction of factors—environmental, personal, interpersonal, and biological—competed with the predominant medical model of alcoholism as a unidimensional disease. It was suggested that perhaps the “one-size-fits-all” approach was inappropriate for alcoholism treatment. The notion that perhaps the missing ingredient in the treatment selection process was the matching of patient to treatment began to evolve.

The hypothesis was that perhaps the addition of matching could enhance outcomes above and beyond what could be accomplished by simply choosing generally effective treatments and paying attention to generic curative elements such as support, rapport, and communication from the therapist. This concept was fostered by about 40 studies published in from the 1970s through the 1990s suggesting that a variety of patient features—demographic, drinking relating factors, intrapersonal characteristics, and interpersonal factors—appeared to “match” with particular treatments.

III. EMPIRICAL STUDIES

A. Early Studies

Development of the experimental database pertaining to the patient-treatment matching hypothesis may

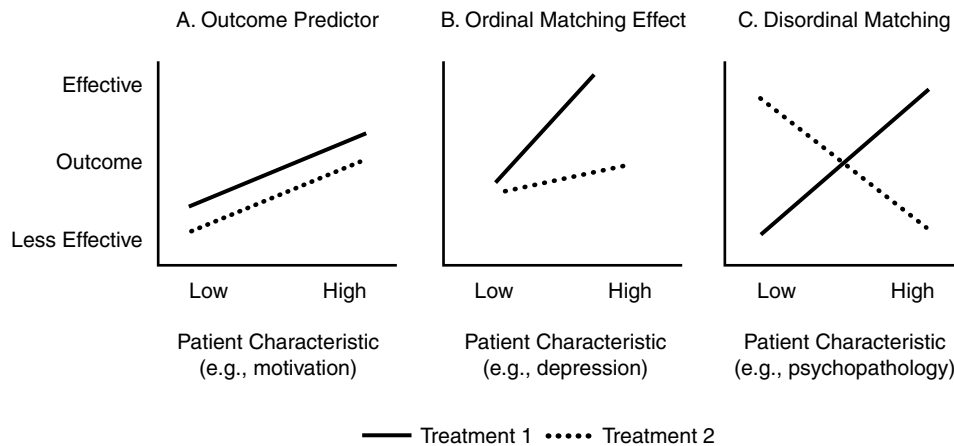

FIGURE 1 Three hypothetical examples of the relation of patient characteristics to treatment success are presented. The X axis (horizontal line) of each graph reflects the degree to which a patient has a certain characteristic. It may be a continuous variable (i.e., a patient may lie anywhere along a spectrum of characteristic levels varying from low to high), such as the degree of a patient's motivation, or a dichotomous variable, such as the presence or absence of a family history of alcoholism (not shown). The Y axis (vertical line) is a measure of treatment outcome (e.g., the percentage of days in a given period that the patient consumed alcohol). The relationship between the two lines that represent the two treatments being compared reveals information about the effects of varying levels of patient characteristics on outcome. (A) The relationship between an outcome predictor and two treatment types is shown. For example, how does a client's motivation affect the outcome of two different treatments? The outcome of treatment with both therapies is related to the patient's characteristic (i.e., the higher the motivation, the better the outcome for both treatments, although Treatment 1 appears a bit more beneficial than Treatment 2). The fact that the lines are parallel indicates that the effect of the patient's motivation is similar for both treatments. Therefore, the characteristic factor is an outcome predictor that does not affect the treatments differentially. (B) An ordinal matching effect is shown. Patients with low levels of the characteristic of interest, such as depression, appear to have about the same success regardless of the treatment they receive. For patients with higher levels of depression, the results diverge, and there is a definite advantage in choosing Treatment 1. (C) Disordinal matching is shown. Patients with low levels of a characteristic, such as psychopathology, have better success when receiving Treatment 2 than Treatment 1. For patients with high levels of psychopathology, the opposite occurs: Treatment 1 is more effective than Treatment 2.

be roughly divided into two eras. The first era consists of about 40 studies from the 1970s through the early to mid-1990s. These were mostly smaller scale, single-site studies. Some of the studies from the earlier portion of this period had methodological shortcomings, such as lack of a priori hypotheses; differing, less well documented therapies, and varying outcome measures that detracted from the studies and made comparisons across studies difficult. Nevertheless, the accumulating body of knowledge was viewed as promising not only for improving patient outcomes but also for making more effective use of ever-decreasing resources as reimbursement policies and other economic forces began to change the face of addiction treatment in this country.

During the 1980s and early 1990s, methodologic advances occurred in addiction clinical research and numerous more sophisticated matching studies were reported, further strengthening the hope for matching as a clinical tool. An important catalyst were two reports from the Institute of Medicine in 1989 and 1990

calling for additional definitive and systematic research on this question. The matching hypothesis had become part of the national research agenda.

B. Project MATCH

The second era of matching studies was marked by the 1989 launch of a multisite clinical trial, Project MATCH, by the National Institute of Alcohol Abuse and Alcoholism (NIAAA) the principal sponsor of research on alcohol disorders in the United States. It was conceived of as the largest, most statistically powerful and most methodologically rigorous psychotherapy trial ever undertaken. The stated objective was to subject the matching hypothesis to its most rigorous test to date. Its research questions were based largely on the previous body of published studies and the latest knowledge of treatments believed to be generally effective and suitable for delivery both in a multisite clinical trial and in actual clinical practice.

1. Project MATCH Design

The details of the rationale and design of Project MATCH are described in a publication of the Project MATCH Research Group in 1993 and by D. Donovan and M. E. Mattson in a 1994 monograph. The study tested promising patient-treatment combinations involving 21 patient characteristics and three treatments: twelve-step facilitation (TSF), motivational enhancement therapy (MET), and cognitive-behavioral therapy (CBT). After determination of eligibility and an extensive baseline assessment, 1,726 patients were randomly assigned to one of the three treatments. The treatments were administered during a 12-week period by trained therapists following standardized manuals. Therapist supervision continued during the trial to ensure fidelity to the treatment protocol across all sites. The treatments are described in three therapists manuals written by their developers and published by the National Institute of Alcohol Abuse and Alcoholism as part of the eight-volume Project MATCH Monograph Series.

Drinking outcomes and other indicators of function were assessed at the end of treatment (3 months) and thereafter at 6, 9, 12, and 15 months. A subset (outpatients only) were recontracted 39 months after treatment. The two primary drinking outcome measures were percentage days abstinent and drinks per drinking day.

2. Project MATCH Sample

Patients were treated at nine locations in the United States. Five sites functioned as outpatient clinics, and five sites delivered Project MATCH treatments as aftercare following an episode of inpatient treatment or intensive day hospital. (One site had both an outpatient and aftercare capacity.) Treatment-seeking clients at the 9 locations were recruited from a total of 27 treatment facilities. Individuals with concurrent drug dependence diagnoses (other than marijuana) were excluded from the trial. The participants were almost exclusively alcohol dependent (as opposed to alcohol abuse only) and had an average of six (out of a possible nine) *DSM-III-R* dependence symptoms, and drank on average 25 days per month, with an average of 15 drinks per drinking day. Over one half had a history of prior treatment for alcoholism, approximately 75% were male, and almost all showed chronic effects of alcohol consumption on various areas of life functioning.

3. Project MATCH Hypotheses

Based upon previous research, a series of client characteristics were identified and tested as potential treatment-matching variables. The matching variables and the measures used to operationalize them are described

in several publications authored by the Project MATCH Research Group. The patient-matching characteristics were alcohol involvement (i.e., severity of alcohol problems), cognitive impairment, conceptual level (a measure of abstraction ability), gender, meaning seeking (i.e., desire to find greater purpose in life), motivation (i.e., readiness to change), psychiatric severity, sociopathy, social support for drinking, alcoholic subtype, severity of alcohol dependence, psychiatric diagnosis (Axis I disorder), antisocial personality, anger, self-efficacy, social functioning, prior engagement in Alcoholics Anonymous, religiosity, treatment readiness, autonomy, and problem recognition. Hypothesized interactions between each of these client characteristics and the Project MATCH treatments were specified at the beginning of the trial. The matching hypotheses were a priori, that is specified in advance, and were not revealed during the trial to therapists and research assistants to maintain objectivity in treatment and assessment.

4. Project MATCH Results

In the following section, we consider how results of Project MATCH answered two questions: (a) How did patients fare in the different treatment conditions? and (b) Were any treatments particularly effective in subgroups of patients defined by the characteristics listed above?

a. Results: Main Effects. Patients in all three treatment conditions demonstrated major improvements in drinking, as well as other areas of functioning such as depression, use of illicit drugs, and liver enzyme status. Overall, MATCH clients were abstaining over 85% of the days throughout the year following treatment, and alcohol consumption decreased fivefold. Even those not successful in maintaining abstinence who continued to drink experienced a substantial reduction in alcohol consumption. In general, effects for the three treatments were similar, with the exception that 10% more of the outpatients receiving TSF attained complete abstinence over the 1-year follow-up period compared to the other two treatments. In addition, more aftercare patients were able to sustain complete abstinence throughout the year after treatment than the outpatients, despite the fact that the aftercare patients entered the study with more alcohol dependence symptoms.

b. Results: Matching Interactions. The findings of Project MATCH surprised many and challenged the belief that patient-treatment matching was critical in the treatment of alcoholism. Contrary to the expectations

generated by the supporting literature, large and uniform effects for matches between single-patient characteristics did not emerge. Many hypothesized matches were not supported, and those found were, for the most part, of rather modest magnitude and often varied over time, between arms of the trial, and for the two primary outcome measures.

Of the 21 patient variables studied, the four with matching effects deemed more plausible were those involving, in the outpatient arm: psychiatric severity, client anger, and social network support for drinking, and, in the aftercare arm, alcohol dependence. These are briefly described.

Patients in the outpatient arm with low psychiatric severity treated with TSF had more abstinent days as compared to those treated with CBT, a differential as high as 10% for several months during the follow-up period. The largest difference occurred 6 months after the end of treatment, when clients without concomitant psychopathology had 87% days abstinent in TSF versus 73% in CBT.

Motivational enhancement therapy was postulated to be more effective for clients with higher anger scores presumably because of its non-confrontive nature. MET clients in the outpatient study who were high in anger were abstinent more often than clients receiving the other treatments (a differential of 9%, i.e., 85% vs. 76%) and drank less intensely when they did drink. Clients with low anger fared better in CBT and in TSF as compared to MET. The effect persisted throughout the 1 year after treatment and was also present at the 39 months follow-up. This finding was the most consistent matching result across time.

As predicted, clients having a social network supportive of drinking did better in TSF than in MET. This difference was not apparent in the first year after treatment, emerging among the outpatients at the 3-year follow-up. TSF patients reported abstinence on 83% of days versus 66% for the MET patients. This difference of 17 percentage points was largest size effect observed in Project MATCH. The effects appear due to a steady decline among clients with high drinking support in the MET group after the end of treatment, whereas the TSF group maintained their gains. An influential factor may be differences in levels of AA attendance, with attendance levels higher in the TSF group than in the MET group.

It had been hypothesized that clients high in alcohol dependence would do better in TSF whereas those lower in that trait would benefit more from CBT. Because TSF is a treatment that puts greater emphasis on total abstinence, it was postulated to be more effective with highly dependent clients than either CBT (which

taught skills to deal with “slips”) or MET (which focused on clients’ own decision making to motivate them to become abstinent). Aftercare clients low in alcohol dependence had better outcomes when treated with CBT than TSF (i.e., abstinence on 96% of post-treatment days vs. 89%). However, at higher levels of dependence, the better treatment choice was TSF (i.e., 94 vs. 84% days abstinent). The effect was consistent for the posttreatment period of 15 months.

c. Results: Clinical Implications. The clinical implications of Project MATCH were described by the investigators in a 1998 publication as follows:

In summary, the results of testing the *a priori* matching hypotheses showed several matches of modest-to-moderate magnitude, often with variability over time, outcome measures and arm of the study. These results suggest that matching clients on several of the attributes tested in Project MATCH to one of the three treatments appears to enhance outcomes to a modest degree, with the most robust of the confirmed effects constituting a moderate difference of 17 percentage points in abstinent days.

The Project MATCH Research group concluded that viewpoints differ on how clinically important these single characteristic effects are, although, overall, the findings do not suggest that major changes in triaging procedures are warranted. R. Longabaugh and P. Wirtz have extensively analyzed the mechanisms and “active ingredients” involved in the matching hypotheses and have discussed possible reasons for the failure to find a greater number of matches.

C. Medications as Matching Targets

The literature on pharmacological agents in the treatment of alcoholism have been reviewed extensively and point to the increasing potential of pharmacologic agents as aids in treatment of alcoholism.

In the early 1990s interest in the opiate antagonist naltrexone as an adjunct in the treatment of alcohol dependence was illustrated by key studies from two groups in 1992, that of O'Malley and colleagues and Volpicelli and colleagues. Previously used as a treatment for opiate dependence, naltrexone was approved for treatment of alcoholism by the FDA in 1994. Previously, the only approved drug for this purpose was disulfiram (Antabuse). Disulfiram functions as a deterrent to drinking by producing an aversive effect if alcohol is consumed through inhibition of aldehyde dehydrogenase, an enzyme involved in the metabolism of alcohol.

Data from studies of the efficacy of naltrexone were subjected to subsequent post hoc analyses by A. J. Jaffe and associates in 1996. These results illustrate the possibility of matching subgroups of patients to drug/psychosocial combinations. The question examined was "Do patients with certain baseline characteristics respond more positively to the drug/psychosocial combinations than those without these characteristics?" The authors concluded that naltrexone appears more beneficial for alcoholics with high craving and poorer cognitive functioning.

Research by Mason and colleagues in 1996 suggested that the use of the antidepressant desipramine may reduce the risk of relapse in depressed alcoholics, but not in the nondepressed. In 1994, H. R. Kranzler and others found that buspirone appeared more helpful to anxious alcoholics although the same had not been observed in a previous 1992 study by Malcom and colleagues. In 2000, two studies on the agent ondansetron, a 5-HT₃ antagonist, suggested it differentially affected drinking in early versus later-onset alcoholics. Early-onset alcoholics were defined as those who showed drinking problems earlier in life, had antisocial characteristics, and a family history of the disorder in first-degree relatives. They found that ondansetron reduced drinking preferentially in the early-onset group. In a small pilot study also in 2000 the same investigators combined ondansetron with naltrexone and found that the combination reduced alcohol consumption in the early-onset group to a larger degree than either of the two medications alone.

Based on preliminary studies such as these, it is tempting to speculate that perhaps new and better matching algorithms may be found when matches are based on pairing of pharmacologic treatments with biologically based patient characteristics. Much additional research remains to determine if intriguing, but preliminary, results can be replicated and extended. Needed are future studies with larger samples in multiple sites and settings, and greater understanding of the neurochemical mechanisms underlying clinical observations. The future of matching patients to pharmacologic treatments remains open pending further investigation.

IV. SUMMARY

Although many alcoholics indeed benefit from treatment, no single treatment has been shown to be effective for all those diagnosed with the disorder. For many decades it was suggested that assigning alcoholic patients to treatments based on their particular needs and characteristics might improve treatment outcomes. In-

terest in matching accelerated during the 1970s and 1980s as supporting evidence accumulated in the literature. However, these studies were small scale, and replication was required before specific recommendations for clinical practice could be advanced. In late 1989 NIAAA launched a multisite clinical trial, Project MATCH, with the goal of learning whether different alcoholics respond selectively to particular treatments. The study tested a promising set of patient-treatment combinations in 1,726 patients randomly assigned to three well-defined psychosocial treatments.

Patients in all three treatment conditions demonstrated major improvements in drinking, as well as other areas of functioning such as depression, use of illicit drugs, and liver enzyme status. However, in terms of matching the findings of Project MATCH challenged the popular belief that matching patients to treatment was needed to significantly improve outcome. Of the 21 patient characteristics evaluated, only four statistically significant matches with potential clinical implications were identified. These matches involved psychiatric severity, anger, social support for drinking, and alcohol dependence.

Viewpoints differ on how clinically significant these single characteristic matches are, given their overall variability over time and the rather modest size of most of the effects. The Project MATCH investigators in 1998 concluded that

matching clients to particular treatment, at least based on the attributes and treatment studied in Project MATCH, is not the compelling requirement for treatment success as previously believed. The matches found, however, are reasonable considerations for clinicians to use as starting points in the treatment planning process.

It may be that other patient characteristics, or other treatments, or settings not studied in this large project may have matching potential. For example, continued future work involving matches of patient characteristics with pharmacological treatments that target the neurochemical pathways involved in addiction will assess the robustness of preliminary findings on this variant on the matching theme. Until such validation is forthcoming, no clinical guidelines can be made with reasonable certainty.

See Also the Following Articles

Addictions in Special Populations: Treatment ■ Controlled Drinking ■ Self-Help Groups ■ Substance Dependence: Psychotherapy

Further Reading

- Donovan, D., & Mattson, M. E. (Eds.). (1994). Alcoholism treatment matching research: Methodologic and clinical approaches. *Journal of Studies on Alcohol, Supplement No. 12*, 1–171.
- Friedman, L. M., Furberg, C., & DeMets, D. (1985). *Fundamentals of clinical trials*. Littleton, MA: PSG Publishing.
- Hester, R. K., & Miller, W. R. (1995). *Handbook of alcoholism treatment approaches: Effective alternatives* (2nd ed.). Needham Heights, MA: Allyn and Bacon.
- Project MATCH Research Group. (1998). Clinical implications of Project MATCH. *Journal of Mental Health, 7*(6), 589–602.
- Project MATCH Research Group. (1993). Project MATCH: Rationale and methods for a multisite clinical trial matching patients to alcoholism treatment. *Alcoholism: Clinical and Experimental Research, 17*(6), 1130–1145.
- U. S. Department of Health and Human Services, Public Health Service, National Institutes of Health, National Institute on Alcohol Abuse and Alcoholism. (2000, June). *10th Special Report to the US Congress on Alcohol and Health*. Washington, DC.

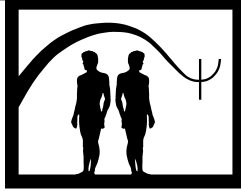

Medically Ill Patient: Psychotherapy

Randy A. Sansone

Wright State University School of Medicine

Lori A. Sansone

Alliance Physicians, Kettering Medical Center

- I. Description of Treatment
 - II. Theoretical Bases
 - III. Empirical Studies
 - IV. Summary
- Further Reading

GLOSSARY

countertransference The therapist's partly unconscious or conscious emotional reactions to the patient.

psychodynamics The systematized knowledge and theory of human behavior and its motivation, the study of which depends largely on the functional significance of emotion. Psychodynamics recognizes the role of unconscious motivation in human behavior. The science of psychodynamics assumes that one's behavior is determined by past experience, genetic endowment, and current reality.

psychoeducation Information in which the content is psychological or psychiatric in nature.

somatization The unconscious manifestation of psychological conflicts, either fully or in part, as somatic or body symptoms.

transference The unconscious assignment to others of feelings and attitudes that were originally associated with important figures in one's early life.

In this article, we highlight the complex relationship between medical illness and emotional or psychological distress and present options for psychotherapy treat-

ment. This task is complex because of the variety of medical illnesses that individuals experience (e.g., from seasonal allergies to life-threatening forms of cancer), the unique psychological composition and reaction of each individual, and the many available treatment options that have been determined as efficacious.

Is there an association between medical illness and emotional distress? Among many patients, there appears to be. For example, 10 to 15% of individuals with medical illnesses suffer from depression, and among those with chronic illness, the prevalence of mood disorders increases up to 25 to 50%. It has been estimated that up to 25% of cancer patients suffer from depression, and that cancer treatment, itself, results in emotional distress for 40 to 60% of patients. Among patients with active medical illness, depression is one of the most common psychiatric complications in medical treatment and outcome. Surprisingly, not all patients with medical illness suffer from emotional distress, but no one knows exactly why this is.

Does emotional distress truly influence medical treatment and outcome? Among patients with similar types and severity of illness, those with depression remained in hospital for longer periods of time (up to 10 days). Depression among diabetic patients is associated with poor treatment compliance and an increased risk for vascular complications. Among cardiac rehabilitation patients, those who received treatment for depression had lower rehospitalization rates. Finally, following the hospitalization of one family member,

studies indicate that there is an increase in the health care utilization of the remaining family members during the subsequent 3 years. These examples underscore that psychological factors appear to have an effect on one's response to medical illness and treatment.

In examining that effect, it is clear that medical illness is associated with some form of loss. Whether the loss is functional (e.g., use of one's legs), economic (e.g., inability to sustain employment), relational (e.g., loss of significant other, friends, or family), and/or self-esteem, a variety of factors affect how illness will be experienced. For example, there may be factors that predate the medical illness, such as early developmental psychodynamics, major psychiatric disorders, and/or personality traits or disorders, that affect the subsequent experience of illness. In addition, the arrival of medical illness may precipitate major psychiatric disorders as well as psychodynamic issues related to the illness experience.

I. DESCRIPTION OF THE TREATMENT

A. Assessment

1. Patient Reactions to Psychological Referral

Patients may be self-referred or referred by the treating clinician or family for psychological treatment. The patient's perception of the referral for psychological intervention may affect the entry into the treatment process. For example, negative reactions may result in failed appointments and, thus, prolonged psychological distress.

Referrals for psychological assessment and treatment may precipitate a variety of patient concerns. These may include social stigmatization (e.g., "Others will think I'm crazy!") as well as damage to self-esteem (i.e., "I can't do this on my own?"). Psychological referrals may be confusing to the patient who does not understand the relationship between emotions and medical illness. In addition, the patient may resist psychological referral if the recommendation is misinterpreted as an abandonment by the physician.

2. Selection Criteria for Psychotherapy Treatment

The selection criteria for entry into psychotherapy treatment vary from therapist to therapist. In general, the patient must be sufficiently intact on a cognitive level to enable participation in treatment. Among pa-

tients with medical illness, common concerns are the cognitive effects of drug treatment as well as delirium. Patients must be able to verbally interact (e.g., exclusions include aphasic patients) and reasonably able to relate to others (e.g., exclusions include severe personality disorders such as schizoid or antisocial personalities).

The ideal patient has a healthy and mature relational capacity. H. Levenson and R. E. Hales note the importance of the patient's ability to view issues in psychological terms, respond to a therapeutic experience in a positive manner, and make adaptations through personal strengths. These authors indicate that psychological pain may actually function as a potent motivation for treatment and emotional growth.

3. Contributory Factors to Psychological Distress among the Medically Ill

In the psychological assessment of the patient with medical illness, the psychotherapist must consider various contributory factors that might account for emotional distress. These factors, which become focal points in the subsequent development of a treatment plan, are described later and noted in Figure 1.

a. Early Developmental Issues Early developmental issues can temper the present-day experience of medical illness. Areas that might be explored with the patient include: (1) the relationship with parents, particularly parental effectiveness as caretakers (i.e., based on past experience, can the patient reasonably trust others to take care of him/her?); (2) the family philosophy of and approach to illness (e.g., acceptability, response patterns

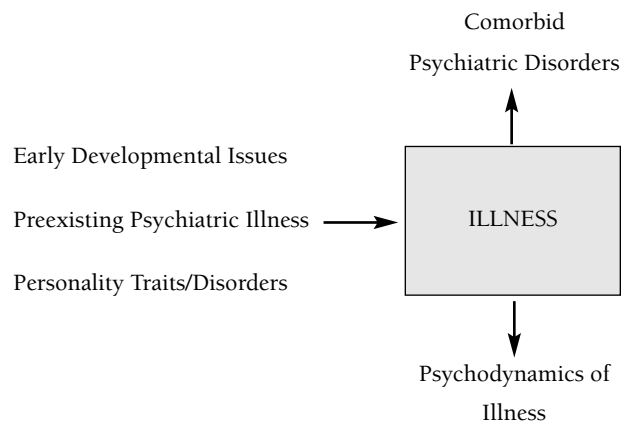

FIGURE 1 Contributory factors to emotional distress in patients with medical illness

to ill members, support and involvement; did parents effectively address, discredit, or dramatize illness in family members?); (3) prior personal experience with illness including illness among family members and friends; and (4) personal tolerability of dependency. It is also important to explore any cultural context or meaning of illness (e.g., the interpretation of hallucinations during delirium as a spiritual visitation from ancestors), and the expected response to illness within a specific culture, if applicable.

b. Preexisting Psychiatric Disorders Some of the current emotional distress may have actually predated the medical illness (i.e., the patient may have a preexisting psychiatric disorder). This possibility is based on the expected prevalence rates of major psychiatric disorders in the general population. For example, according to the National Comorbidity Survey, the lifetime prevalence of any depressive disorder is nearly 20%, anxiety disorder 25%, and substance abuse 27%. Therefore, it is worthwhile to explore for preexisting psychiatric disorders, particularly acute depression (major depression), chronic depression (dysthymic disorder), and substance abuse. These disorders may presently be comorbid, or co-exist, with the medical illness.

In addition to preexisting major psychiatric disorders, some adult patients also suffer from personality disorders. With their onsets in childhood, personality disorders result in long-standing and consistent deviations in cognition, behavior, and interpersonal relationships—all of which may influence the course and management of medical illness (e.g., medication compliance, appointment attendance, cooperation with treatment and medical personnel, reaction to illness, ability to elicit support from others). As an example of personality disturbance affecting illness, we have empirically determined that at least 7% of patients actively sabotage their medical care and that medically self-sabotaging behavior is typically associated with personality pathology, specifically borderline personality disorder.

Personality disorders can be difficult to diagnose during an initial evaluation, particularly if the patient is relatively high functioning and well educated. Oftentimes, diagnosis evolves with continuing or ongoing contact with the patient. However, health care personnel and family members may provide important historical information that suggests personality pathology, which is usually manifest in interpersonal functioning.

c. New-Onset Psychiatric Disorders After the onset of illness, patients may experience new-onset, or sec-

ondary, psychiatric disorders, most frequently either depression and/or anxiety. It appears that depression is particularly frequent among sufferers of neurological or cardiovascular disease. According to D. Spiegel and C. Classen, up to 50% of cancer patients experience clinical depression or anxiety, and the rate of depression in oncology patients is four times the prevalence found in the general population. Spiegel and Classen report that nearly 90% of these clinical syndromes are either manifestations of or reactions to illness or its treatment (i.e., secondary).

In addition to other factors, secondary mood disorders may be caused by a variety of medications administered to patients with medical illness. S. M. Valente and colleagues outline an extensive list of these medications (see “Further Reading”) that include specific anti-inflammatory drugs and analgesics (e.g., ibuprofen, baclofen, opiates), anticonvulsants, antihistamines, particular anticancer drugs, caffeine, and propranolol. As with preexisting psychiatric disorders, these secondary mood disorders have the same potential to interfere with treatment by reducing compliance, optimism, and cooperation.

d. Medical Illness Psychodynamics There are well-known psychodynamics that are outgrowths of medical illness (see Table 1). Many of these psychodynamics center on the patient’s experience of loss.

In addition to the themes relating to loss, D. Spiegel and C. Classen emphasize the importance of the patient’s reaction to the disease, itself. For example, with

TABLE 1
Psychodynamics That May Be
Associated with Medical Illness

- Greater helplessness and increased dependency on others
- Need for social support
- Loss and mourning (e.g., disability, disfigurement, employability)
- Significant changes in usual activities, routines, life patterns
- Increased responsibility for own care (e.g., medication regimens, follow-up visits)
- Need to reexamine life priorities
- Feelings of alienation from others
- Threat of premature death
- Unpredictable course of illness
- Symptom control
- Secondary gain (e.g., nurturance needs, deserved punishment)

regard to cancer, some patients attempt to overly control their feelings in an effort to literally control the cancer. Some patients believe that maintaining a positive attitude, even at the cost of dealing with and sorting through by-product issues, is a means of curing cancer. These beliefs may result in the patient's unrealistic needs to remain strong and in control. Patients may also struggle to maintain a self-perception of being "normal" which can cause unrealistic overextensions of self.

Following diagnosis, the psychological demands on patients continue. For example, D. Spiegel and C. Classen describe cancer as a series of stressors, from beginning treatment protocols to the changes in the social and physical environment to fears of death. The complex demands of illness, as well as the stigma of illness, may result in social isolation and breaches in social support. In our experience, it appears that genuine support can be maintained in most families for about a year, but gradually, family members may lose their stamina and resilience.

4. Use of Psychological Measures in Medically Ill Patients

a. Mood Assessment Mood and anxiety disorders, the most common psychiatric disorders among the medically ill, may be assessed in a variety of ways. However, sometimes the direct approach is the best approach. In support of this, a group of investigators reported that, among a group of patients with terminal illness, asking the direct question, "Are you depressed?" was more valid than three sophisticated psychological assessments for depression.

b. Psychological Measures of Illness Experience Psychological measures specific to the illness experience have not been broadly utilized in clinical settings. However, examples of general measures include the Millon Behavioral Health Inventory; the Psychological Adjustment to Illness scale; and the Illness Behavior Questionnaire. The latter measure contains seven scales including general hypochondriasis, disease conviction, psychological versus somatic concern, affective inhibition, affective disturbance or dysphoria, denial, and irritability. Examples of illness-specific psychological measures, which are uncommon, include the Mental Adjustment to Cancer scale.

c. Psychological Measures of Health-Related Quality of Life Of the measures available, the Medical Outcomes Study 36-Item Short Form, or SF-36, is probably the most commonly used measure of health-related

quality of life. This 36-item questionnaire, with known reliability and validity, contains eight subscales and measures health status, general functioning, and well-being. It has been used among broad samples of patients as a measure of outcome.

B. Treatment

Following assessment, the psychotherapist will hopefully have sufficient information to determine the initial foci of therapeutic work. These foci function as the basis for developing an eclectic and individualized treatment approach. Given the possible short duration of anticipated treatment, the therapist must, according to H. Levenson and R. E. Hales, select the symptoms, behaviors, or conflicts most amenable to treatment.

1. Timing of Psychotherapy Treatment

An important consideration for the therapist and patient is the timing of psychotherapy treatment. Coping strategies are ideally taught to the patient and family when motivation and physical stamina are relatively high (i.e., the early phases of illness), whereas treatment in the later phases of medical illness may limit efficacy.

2. Establishing the Therapeutic Relationship

a. The Paradox of Empathy Although most therapists have an understanding of what it feels like to be depressed or anxious, to suffer the loss of a relationship, or to mourn a death, far fewer have experienced the unique types of compromises precipitated by medical illness. This potential difference poses unique constraints with empathy in the therapeutic relationship because most of us do not understand what it is like to be burned beyond recognition or to deal with a disfiguring surgery. In this regard, we believe that it is important, when applicable, for therapists to actively acknowledge their lack of personal experience with a particular medical process, and the feelings associated with it, in an effort to promote a candid and sincere need to understand the patient. Likewise, therapists can explain their familiarity with a specific disease process and/or the illness experience from work with other patients.

b. Engagement with Emotional Boundaries Because of the potential devastation of medical illness and the resulting biological and psychological regression that occurs, the therapist needs to be sensitive to the extensive support needs of these patients. Spontaneity, genuineness, warmth, and the candid expression of support

are important qualities in the building of rapport. At the same time, realistic internal emotional boundaries need to be established within the therapist to avoid emotional overinvolvement.

c. Transference As the treatment relationship unfolds, various types of transferences may evolve. A transference is the patient's unconscious assignment to others of thoughts and feelings that were originally associated with important figures in one's early life (American Psychiatric Association's *Psychiatric Glossary*). As an example, the patient may have been abandoned by parents as a child and now unconsciously expects that the treatment team will also abandon him or her. Examples of more subtle transferences might be the patient's unconscious resentment about the health and well-being of the therapist. Differences in age, gender, professional backgrounds, and level of education may cause breaches in the therapeutic relationship based on early issues. Finally, the early relationship with caretakers may affect the patient's reaction to being helped and supported by the treatment team as well as accepting the natural and expected dependency that occurs in a treatment relationship.

d. Countertransference Countertransferences may also develop. Countertransference is the therapist's partly unconscious or conscious emotional reactions to the patient (American Psychiatric Association's *Psychiatric Glossary*). As examples, the therapist may not feel comfortable working with patients who are going to die, due to earlier unresolved experiences with death as well as our cultural discomfort with death. The therapist may also be concerned about the patient's medical illness prohibiting an orderly exploration of issues. Likewise, the therapist's own prior experience of illness may affect his or her perception of the patient. As a final example, the therapist may feel uncomfortable with the medical overlay associated with the care of the patient (e.g., hospital setting, liaison with medical personnel, medical communication or jargon, uncertainty about the treatment process or outcome), which may be a reflection of an early sense of helplessness in undefined or overwhelming situations.

Beyond transference and countertransference issues, other relationship dynamics may emerge. For example, as therapy progresses, a mutual denial regarding the severity of illness may develop between the patient and the therapist. This dynamic may function to protect the continuity of the therapeutic relationship.

e. The Therapist with Medical Illness One final issue involving the therapeutic relationship needs to be considered—that of the therapist who suffers from medical illness. In these circumstances, the therapist may experience prominent defenses against his or her own illness including denial, omnipotence, and reaction formation (i.e., the latter being an unconscious defense mechanism in which the individual adopts thoughts and behaviors that are the opposite of what he or she is really experiencing). Reaction formation may be in response to dependency and debilitation. Medical illness may also result in empathic failure in the treatment relationship because of the therapist's emotional preoccupation and subsequent withdrawal from the patient. For therapists with medical illness, there is also the delicate issue of disclosure to patients about the illness, particularly its course and prognosis.

3. Psychotherapy Treatment Components

In the remainder of this section, we discuss psychotherapy treatment from a general perspective in an effort to accommodate the most generic patient with medical illness. We wish to emphasize that most effective therapies with patients with medical illness incorporate an eclectic and individualized approach. Several common components will be discussed (i.e., psychoeducation, acute problem solving, cognitive-behavioral techniques, psychodynamic psychotherapy, family intervention). The resulting treatment structure, including the various treatment components, is not limited to an individual-therapy format but may be incorporated into a group format as well. In addition, different treatment providers may captain the individual components.

a. Psychoeducation Psychoeducation is typically an ongoing process during treatment. Psychoeducation may occur while describing the process of psychotherapy, when inviting the mutual sharing of medical information (e.g., disease effects, prognosis, necessary medical intervention), and while validating key psychodynamic issues such as loss. In this regard, therapists who treat patients with medical illness need to understand the natural course and treatment of the illness, if such information is available.

b. Acute Problem Solving A variety of practical life issues may need to be addressed with the patient. These may include inexpensive resources for medical supplies, financial aid, child care, transportation, sexual functioning, and cosmetic concerns (e.g., hair loss with chemotherapy). The therapist plays an active role in

triaging problems to appropriate adjunctive health care personnel (e.g., social work) and community resources (e.g., wig salons) as well as addressing issues relevant to psychotherapy treatment (e.g., telling a spouse the prognosis).

Acute problem solving may also be addressed in brief psychotherapy treatment models. H. Levenson and R. E. Hales describe two examples of specific models of brief, dynamic psychotherapy for medically ill patients. One model is Time-Limited Dynamic Therapy that is an interpersonal therapy approach based on the premise that present relational difficulties were learned in childhood. The preceding investigators report that this model is particularly applicable to patients with medical illness because chronic illness may initiate a pattern of disturbed interpersonal relationships. A second example of a brief psychotherapy model is Short-Term Dynamic Therapy of Stress Response Syndromes, a 12-session treatment developed by M. Horowitz in 1976. This model focuses on the alleviation of an immediate stressor and is intrapsychic, rather than interpersonal, in format.

c. Cognitive-Behavioral Techniques Cognitive-behavioral interventions can be very helpful for patients with medical illness by modifying thoughts, emotions, and behaviors. Cognitive-behavioral treatment focuses on the elicitation and “correction” of unintentional thinking errors or cognitive distortions that precede the exacerbation of emotional discomfort. Illogical thoughts (e.g., “I’ll never feel better”) are systematically elicited and processed to determine their nature (are they, for example, a result of magnifying or minimizing situations?). These thoughts, which are actively linked with emotional discomfort (i.e., “notice that when you think this, you feel like this”), are ultimately reformed, relabeled, or replaced (“you don’t feel good now; you will feel better, later”).

d. Psychodynamic Psychotherapy Although not applicable to all patients, many have early developmental issues, particularly parents’ responses to caretaking and illness as well as the patient’s experience of dependency, which relate to and affect the current medical illness. In working with the patient, the therapist needs to maintain an active mental checklist of prominent current issues with the intent of threading these back into the developmental history to explore for any former issues that might be affecting the current medical experience. We are fairly candid with patients about the purpose of this historical information (e.g., “I need

to understand your childhood background to determine its possible influences on your illness.”). When present, an understanding of the association between past and present relationships may help resolve excessive fears and address defenses such as denial.

Psychodynamic psychotherapy can assist patients by alleviating the complex issues related to loss and changing social and family roles. As an example, the therapist needs to explore and clarify the meaning of illness to the patient in terms of possible role reversal (i.e., being cared for by one’s children). Other common psychodynamic themes are listed in Table 1.

Terminal illness is a particular challenge in the treatment process, in part because of the therapist’s task of ascertaining the meaning and value of defense mechanisms such as avoidance and denial. For example, dying patients may avoid the disclosure of the extent of their disease to loved ones. Patients may even avoid asking the treatment team about the prognosis so as not to confirm a negative one. Denial may limit the patient’s reality of being finite as well as sabotage personal closure needs. On the other hand, some of these defenses may be the psychological substance of immediate survival. Therefore, the therapist must delicately explore the function of these dynamics and determine their adaptability. Again, these defenses are not always pathological or problematic.

Another challenging issue in the treatment of patients with medical illness is the patient’s personal determinism with regard to his or her own death. Although beyond the scope of this article, the patient’s desire to end pain, suffering, family stress, and financial exhaustion may precipitate the contemplation of suicide. Unquestionably, there are a variety of complex social, spiritual, religious, moral, and legal dilemmas entailed in this issue. However, the immediate clinical dilemma is the intended meaning of the patient’s disclosure of suicidal thinking. Is the disclosure a “cry for help” or is it the need to explore a difficult decision with another human being? Is the therapist’s contemplation of intervention an overt need to rescue the patient or avoid legal prosecution for inaction, or the therapist’s intolerance of the patient’s decision? What are the legal risks of not intervening with such a disclosure, particularly if the family supports the patient’s decision to suicide? Finally, is the decision to suicide a rational one or a decision driven by fear or untreated depression, and does it matter? As a general guideline for therapists, at this juncture, it is particularly important to reassess and treat (or alter treatment of) mood disorders as such intervention may result in the resolution of suicidal ideation.

e. Family Intervention Although most therapists do not undertake intensive family therapy work in the treatment of patients with medical illness, it is usually helpful to meet with the family. The family may provide additional background information, require individual professional support (e.g., the spouse who is depressed and needs antidepressant medication), and/or require a liaison between the patient and/or hospital personnel. In addition, families may require education about specific psychological issues (e.g., the role of depression, emergence of delirium secondary to the treatment) as well as some reframing about their loved one's behavior (e.g., the patient's low frustration tolerance, fear, confusion, inability to make decisions).

f. Group Therapy As noted previously, all the preceding treatment components may be undertaken in group format. The psychological advantages of group treatment of patients with medical illness include the ability to emphasize the universality of experiences, deal with disability on a mutual level, engage in emotional sharing, sort out relationships with family, and acknowledge and attempt to resolve grief and loss.

In working with cancer patients, D. Spiegel and C. Classen describe the goals of group therapy, many of which apply to all group treatments. These investigators emphasize the goals of building social bonds, using the group experience as a working lab to practice and express emotions, processing feelings about death and dying, redefining life goals, increasing social support, comparing health information, improving one's relationship with the health care team, and improving coping skills. With regard to the latter, a group experience is an excellent way to discover how others have dealt with and resolved specific issues or problems (e.g., having sexual relations while wearing a colostomy bag).

Group treatment is determined by the patient's individual needs (e.g., social comfort with groups, level of debilitation, type of medical illness), the available resources, and the availability of sufficient fellow patients (usually 7–10) who meet the group's criteria for entry (e.g., HIV infection). Some groups are very structured including an explicit number of sessions, while others are open-ended and continue as long as the need persists. In addition to patient groups, some therapists provide group intervention to families.

Group treatment is potentially more cost effective than individual treatment. However, potential difficulties in initiating group treatment include establishing the proper working group size, defining entry criteria (e.g., type of illness, stage of illness, age, sex), sollicita-

tion of members (e.g., bulletin board advertisements, physician referral only), duration of the group both per session and total duration, and whether the group is open to new members or not. Other potential problems include reimbursement, establishing and maintaining confidentiality, and leadership. Unlike typical psychotherapy groups, members may have to be prepared for the inevitable death of some participants, depending on the composition of the group.

4. Treatment Strategies for Major Psychiatric Disorders

a. Preexisting and Current Mood Disorders As noted previously, patients commonly develop depression and anxiety disorders, either prior to the onset of illness or during it. Mood and anxiety disorders are usually treated in a traditional fashion with antidepressant or antianxiety medications as well as the consideration of psychotherapy. Certain types of antidepressants, the selective serotonin reuptake inhibitors (SSRIs), are favored because of their ability to treat both depression and anxiety, and their minimal side effects, particularly the lack of cognitive and cardiovascular effects. With one exception (citalopram), these drugs tend to be very safe in single-drug overdoses.

b. Somatoform Disorders Somatoform disorders consist of a collection of psychiatric disorders that include somatization disorder (i.e., the presence of multiple physical complaints involving multiple body areas or body systems); conversion disorder (the presence of a symptom complex that is under unintentional but voluntary control and whose onset relates temporally to stress or conflict); pain disorder (pain symptoms in which psychological factors contribute in an unintentional way); and hypochondriasis (nondelusional, but persistent preoccupation with one's body or symptoms with regard to disease). These disorders may be associated with other types of psychiatric disorders, particularly mood and anxiety disorders. Because of the patient's focus on physical symptoms and the oftentimes unintentional generation of symptoms, there may be little interest in mental health support. However, symptoms may be reduced in some patients with supportive psychotherapy geared to stressors and interpersonal conflicts, frequent appointments with the primary care physician, conservative medical intervention, and the treatment of comorbid conditions such as mood and anxiety disorders with antidepressants. With regard to the latter, those antidepressants which exert an antiobsessive effect (e.g., SSRIs) may be particularly

helpful in some patients. Among this group of patients, there is a great deal of heterogeneity and in some cases, more sophisticated types of psychotherapy may be utilized in particular patients as well as more complicated combinations of psychotropic medications. Some of these patients may even benefit from hypnosis (e.g., conversion disorder).

5. Treatment Strategies for Patients with Personality Disorders

We believe that the presence of a personality disorder is one of the most difficult issues in the treatment of patients with medical illness. Because of their long-standing nature, personality disorders tend to be tenacious and difficult to change. Most theorists believe that long-term treatment is required and the outcome or prognosis may be limited. In addition, there are few studies that clarify the efficacy of treatment for personality disorders. Indeed, some disorders, such as antisocial personality disorder, have questionable responses to treatment. The interplay of medical illness and personality disorder can be exasperating for the clinician as well as the family and health care team. For example, the management of diabetes may be extremely difficult among patients who sabotage their administration of insulin, resulting in repeated hospitalizations and medical complications.

It is important to emphasize that the presence of personality disorder is not always a meaningful issue in treatment. For example, in cancer victims with poor prognoses, personality disorder treatment is neither realistic nor appropriate. In these latter cases, the therapist may limit treatment to minimizing the impact and effects of the personality-disordered behavior on family, medical staff, and other patients.

II. THEORETICAL BASES

It is difficult, at times, to accurately measure and describe the psychotherapy process and why it works. Perhaps it is the psychological intimacy that provides immeasurable support. Perhaps it is the revelation of fear, anger, disappointment, and shame—all the feelings that incarcerate the spirit. It may also be establishing new conceptual paradigms to replace the previous ones that no longer work. Whatever the growth-promoting elements of psychotherapy treatment are, they certainly apply to the treatment of those with medical illness. The modifications in psychotherapy treatment of this population primarily center on the additional knowledge

base required in working with a medical illness, the biological stress of the illness, and the ever-prominent issue of death. Although suicide is always a concern in working with patients with nonmedical illness, it remains an issue with the patient with medical illness as well, in addition to the threat of death from illness.

III. EMPIRICAL STUDIES

In a 1994 review of the literature, H. R. Conte reported that there were few controlled empirical studies, and only occasional case reports, exploring the efficacy of supportive psychotherapy for patients with medical illness. Results indicated beneficial effects, in general. Although it is impossible to compare outcome studies because of differing patient populations, therapeutic interventions, treatment settings, and types of medical illness, we present some highlights from the literature.

A. Psychoeducation

Among patients with chronic illness, researchers found that classroom as well as home psychoeducation (e.g., instruction on mind–body relationships, relaxation training, and communication skills) resulted in improvements with pain, sleep disturbance, mood, and anxiety. Formalized psychoeducation has also been undertaken with cancer patients and found to enhance both cognitive and behavioral coping skills.

B. General Psychological Intervention

In a group of patients with atopic dermatitis, those who entered into a psychological treatment demonstrated a greater improvement in their skin condition than did those patients in standard medical treatment. In a review of outcomes among those with chronic heart failure, it has been reported that psychological and behavioral interventions have the potential to substantially enhance treatment outcomes. Among patients undergoing coronary artery bypass surgery, those who participated in daily supportive psychotherapy had fewer medical complications and shorter lengths of hospitalization, compared with controls. Through meta-analysis, the efficacy of psychological interventions among both children and adolescents with chronic medical illness has been explored; despite a host of limitations, results support the overall efficacy of psychological intervention.

C. Cognitive-Behavioral Interventions

Cognitive-behavioral intervention has been found to improve depression among patients with chronic illness. Multicomponent behavioral therapy among patients with irritable bowel syndrome resulted in greater symptom reduction compared with controls.

D. Group Therapy

In examining the sense of well-being as an outcome measure for patients with serious medical illness in time-limited (12 sessions) group therapy, researchers found that although somatic concern remained sustained, all patients noted an improvement in their sense of well-being. Likewise, among cancer patients receiving radiation therapy, there were significant decreases in both physical and emotional symptoms for those who participated in 10 group therapy sessions of 90 min each. Through multicenter evaluation, group therapy with breast cancer patients has been empirically assessed and resulted in improved mood, fewer maladaptive coping responses, and improved support. Finally, group therapy (six sessions) among patients with malignant melanoma resulted in decreased stress, greater use of coping skills, and effective changes in the lymphoid cell system.

E. Cost Effectiveness of Psychotherapy

Researchers have found that psychotherapy can be cost effective among certain medical patients with concomitant psychiatric illness. In addition, there is evidence that psychiatric consultation-liaison services for medical patients reduces the overall cost of care. Studies indicate that psychiatric illness, notably depression, usually prolongs hospital stays for medical patients and intervention reduces cost. In summary, it appears that reducing psychiatric morbidity among medical patients also has the potential to reduce their overall cost of medical care.

F. Caveats

Although many studies clearly support the efficacy of psychological intervention in patients with medical illness, there are studies that do not. For example, the provision of group therapy for the relatives of patients with chronic aphasia was appreciated but did not lead to measurable improvements in participants' perceptions of personal, social, or family burdens. Among patients with

testicular cancer, psychotherapy did not affect outcome when compared with controls. In examining the impact of treating depression among hospitalized veterans and the effect on participants' preferences for life-sustaining therapy, surprisingly, these preferences did not change, regardless of the improvement in depression.

IV. SUMMARY

The psychotherapy of patients with medical illness must be individualized to the needs of each patient. Treatment components may include psychoeducation, acute problem solving, cognitive-behavioral techniques, psychodynamic psychotherapy, family intervention, and group therapy. The unique aspects of medical illness temper the psychodynamics of the issues in the treatment process. The therapist must integrate both the knowledge of psychology and biological disease to effect an outcome. Although most studies underscore the effectiveness of psychological interventions in the medical patient, the documented limitations of psychological intervention in some populations underscores the importance of further investigation.

See Also the Following Articles

Bioethics ■ Cancer Patients: Psychotherapy ■ Collaborative Care ■ Comorbidity ■ Countertransference ■ Informed Consent ■ Integrative Approaches to Psychotherapy ■ Neurobiology ■ Transference

Further Reading

- Levenson, H., & Hales, R. E. (1993). Brief psychodynamically informed therapy for medically ill patients. In A. Stoudemire, & B. S. Fogel (Eds.), *Medical-psychiatric practice* (Vol. 2, pp. 3–37). Washington, DC: American Psychiatric Press.
- Spiegel, D. (1999). Psychotherapeutic intervention with the medically ill. In D. S. Janowsky (Ed.), *Psychotherapy indications and outcomes* (pp. 277–300). Washington, DC: American Psychiatric Press.
- Spiegel, D., & Classen, C. (Eds.) (2000). *Group therapy for cancer patients: A research-based handbook for psychosocial care*. New York: Basic Books.
- Spira, J. L. (Ed.), (1997). *Group therapy for medically ill patients*. New York: Guilford Press.
- Stoudemire, A., & Fogel, B. S. (Eds.), (1993). *Medical-psychiatric practice*. Washington, DC: American Psychiatric Press.
- Stoudemire, A., Fogel, B. S., & Greenberg, D. B. (Eds.), (2000). *Psychiatric care of the medical patient*. New York: Oxford University Press.
- Valente, S. M., Saunders, J. M., & Cohen, M. Z. (1994). Evaluating depression among patients with cancer. *Cancer Practice*, 2, 65–71.

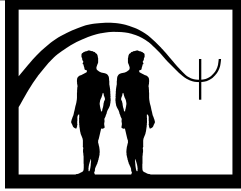

Minimal Therapist Contact Treatments

Anderson B. Rowan and Julie M. Storey

Malcolm Grow Medical Center, Andrews Air Force Base, Maryland*

- I. Treatment Description
 - II. Theoretical Bases
 - III. Literature Review
 - IV. Treatment Abstract
- Further Reading

GLOSSARY

minimal therapist contact treatments (MCT) Rely heavily on out-of-clinic interventions. Often it is referred to as a “home-based” treatment.

cost-effectiveness Percentage improvement per minute of clinician contact.

Minimal therapist contact is a term used to describe psychological interventions that utilize alternative forms of instruction and treatment administration (e.g., written materials, computer programs, videotapes, audiotapes, and portable biofeedback equipment) to reduce professional contact time without compromising treatment intensity. Because minimal therapist contact treatment (MCT) relies heavily on out-of-clinic interventions, it is often referred to as a “home-based” treatment.

I. TREATMENT DESCRIPTION

For the purposes of definition, it is important to distinguish between other forms of intervention that utilize alternative delivery methods and MCT treatments. These other forms of intervention, including certain types of bibliotherapy and many self-help interventions, effectively reduce the amount of contact time, but they accomplish this by decreasing the intensity of the intervention. For example, efficiency may be improved solely by decreasing the number of sessions in the intervention, limiting the patient–therapist interaction to a one-time, informational exchange, or eliminating the patient–therapist relationship altogether (e.g., pure self-help). MCTs on the other hand, seek to deliver an intervention of equal intensity and duration to standard clinic-based treatments (SCT) while maintaining ongoing (although less frequent) patient–therapist contact.

MCTs offer many potential advantages over SCTs. First, at-home skill acquisition and practice eliminates the need for frequent, lengthy clinic visits, improving access to care for many patients. Specifically for patients living in rural areas who must travel significant distances for care, a decrease in clinic visits makes obtaining treatment more feasible due to a reduction in transportation costs and lost work time. A reduction in clinic visits, however, will likely improve access to care for all patients, not just those living in rural areas. For example, recent treatment utilization data suggest that 80% of patients attend fewer than six treatment sessions, suggesting the length of standard interventions may be a barrier to patient care in general.

* The views expressed in this article are those of the authors and do not reflect the official policy or position of the United States Air Force, Department of Defense, or the United States Government.

Second, MCTs reduce the total amount of therapist contact time that results in decreased provider cost per patient treated. Cost-effectiveness, defined as percentage improvement per minute of clinician contact, has been shown to be as high as five times greater in MCTs as compared to SCTs. This characteristic of MCTs fits in well with the prevailing method of health care funding and delivery: managed care. Health maintenance organizations (HMOs) are concerned with treatment cost, treatment quality, and patient access to care. As a method of cost containment, many HMOs limit the number of preapproved clinic visits. MCTs respond to this need to balance cost containment and patient care by decreasing cost without sacrificing treatment efficacy.

Compared to efficiency-enhancing methods that rely solely on reducing or eliminating therapist contact time, MCTs offer the potential benefit of greater patient involvement and skill acquisition without the loss of intervention and monitoring by a trained therapist. In addition, this utilization of alternative mediums of instruction and delivery allows the therapist to focus on tailoring interventions to specific patients and to respond to factors and circumstances that arise during treatment. MCTs are also flexible and can often incorporate the beneficial aspects of other efficiency-enhancing formats. For example, the first author has designed a group administered MCT protocol for the treatment of chronic headaches (HA). Finally, MCT's use of extensive at-home skill acquisition and practice theoretically may facilitate skill generalization and internal attributions for change. However, no studies have examined differences in generalization.

Some potential disadvantages may also exist for MCTs. The first author's experience with MCTs suggests they may require a higher level of motivation or cognitive ability than SCTs, although no studies have investigated such a requirement. In addition, the increased reliance on patient self-administration presents the potential for reduced adherence, although poor adherence has not been reported in the existing literature.

II. THEORETICAL BASES

The term "minimal contact" implies a form of treatment administration and delivery that is not limited to a particular theory. This represents a significant advantage for MCTs because they can potentially be applied to any type of intervention that is translatable into a standard protocol, regardless of clinical orientation. However, the MCTs described in the literature have, almost entirely, been developed from treatments based in cognitive-be-

havioral theory. This trend is not a random occurrence but is due primarily to the nature and developmental stage of cognitive-behavioral interventions that make them especially suitable for MCT methods.

First, cognitive-behavioral interventions rely heavily on education and exposure to new experiences for treatment efficacy. Both of these treatment components lend themselves to home-based interventions that utilize alternative mediums to communicate information. Second, treatment efficacies of many cognitive-behavioral interventions for a variety of disorders have received significant empirical support. Once an intervention has been established and its efficacy empirically supported, the amount of additional clinical improvement gained by modifying the content of the intervention will eventually plateau. Cognitive-behavioral interventions for chronic headaches reached such a plateau, leading researchers to look toward enhancements in treatment delivery for further improvement of the interventions. MCT methods provide one means by which the efficiency of established interventions can be enhanced while the treatment content, intensity and efficacy remain intact.

III. LITERATURE REVIEW

Research exists to support various forms of MCT for adult patients with both physical and psychological disorders, including migraine and tension HA, hypertension, and panic disorder. In addition, research supports the use of MCT for HA and enuresis in children.

The literature on MCT of HAs in adults consistently finds MCT to be equally as effective as the more intensive SCTs. Results of a recent meta-analysis of 20 controlled clinical outcome trials suggest MCTs, on average, are more cost-effective and require substantially less professional contact time, as well as, fewer clinic visits. In addition, MCTs produced similar or significantly better outcomes than SCTs requiring more professional contact.

More specifically, a 1996 review article including eight studies of MCTs for tension-type HA found MCTs to be equally as effective as SCTs for the reduction of HA activity. MCT for tension-type HA has also been compared to prophylactic, pharmacological intervention (Amitriptyline HCL). The results suggest MCTs are similarly efficacious in terms of decreasing HA frequency and intensity. However, compared to the medication group, additional benefits were realized in the MCT group, such as more internalized locus of control, fewer general somatic complaints, and fewer side effects. Although long-term fol-

low-up studies of these interventions have been somewhat lacking, existing data have consistently shown good maintenance of effects throughout follow-up periods ranging from 3 months to 2 years.

Similar results have been reported for migraine HA. Three investigations comparing the efficacy of MCT and SCT relaxation/thermal biofeedback interventions suggest MCT is equally as effective as SCT for the reduction of migraine HA. One study to date has investigated the efficacy of MCTs as compared to abortive medication (ergotamine tartrate) for the reduction of migraine HA. The results found MCT to be equally as effective as this abortive intervention, although patients treated with medication experienced improvements more rapidly than those treated with MCT.

No research to date has been conducted comparing MCT to treatment with prophylactic medication. However, one study compared MCT alone to MCT plus propranolol (the most commonly used prophylactic agent for migraine HA). The results indicate that, although both interventions were effective, the addition of the prophylactic agent yielded significant enhancements in HA reduction.

MCT methods have also been used in the treatment of essential hypertension with equivocal results. One study investigated the efficacy of a 5-session, thermal biofeedback MCT for adults with essential hypertension who required at least two drugs for hemodynamic control. This intervention was compared to a standard, 16-session, thermal biofeedback SCT. The results suggest that patients in the MCT did significantly poorer controlling their blood pressures without medication than those in the SCT. However, a previous investigation comparing a 9-session thermal biofeedback MCT to a 20-session SCT found equivalent reductions in blood pressure and antihypertensive medication use. Methodological limitations, such as small sample size, suggest that more research is needed in the area of MCTs for hypertension.

A recent study also supports the efficacy of MCT methods in the administration of cognitive-behavioral treatment of panic disorder. When compared to a standard, 10-session cognitive-behavioral intervention for panic disorder, a minimal contact approach involving 5 sessions and supported by self-help materials yielded similar improvements both immediately posttreatment and at 12-month follow-up. In addition to applying minimal contact methods, this particular intervention also reduced the total length of therapy while maintaining the efficacy of the longer, clinic-based intervention.

Data have also been reported that support MCTs in pediatric populations. A review article including three

school-based and four home-based MCT interventions concludes that MCT for pediatric and adolescent migraine, regardless of setting, is equally as effective as SCTs. The existing research on pediatric tension HA for both SCTs and MCTs are more modest, however, with the percentage of participants experiencing clinically significant improvement (defined as > 50% reduction in overall HA activity) being low, but similar, for both types of intervention. In terms of mixed-type HA, a recent treatment study of a home-based MCT for children (ages 10–12) found the MCT to be as efficacious as the SCT and over twice as cost-effective.

Similarly, data supporting the efficacy of MCTs for the treatment of nocturnal enuresis in children have also been reported. This treatment relied on the children's parents for the administration of the treatment. Although some limitations may exist for the application of MCTs with children, such as inability to read and the need for significant parental involvement in treatment, more research is needed on MCT in this population.

In general, research has fairly consistently shown MCTs to be as effective as more costly SCT for the treatment of a variety of disorders in both adult and child populations. The extensive body of research demonstrating the efficacy of MCTs for chronic HA suggest MCTs for HA are ready for widespread clinical application. However, additional research is needed to verify MCTs for the treatment of other disorders and to investigate the potential advantages and disadvantages of minimal contact methods beyond increased cost-effectiveness.

IV. TREATMENT ABSTRACT

Although MCT methodologies could result in many different therapy formats, a prototype based on a typical intervention is presented here as an example.

A prototypical MCT might take an 8-session, 8-week SCT and administer it utilizing three in-clinic sessions, two telephone contacts, and a series of audiotapes and manuals across the same 8 weeks. Table 1 compares a typical minimal therapist contact treatment (MCT) to a standard clinic-based treatment (SCT).

The first week of intervention looks almost identical in the two forms of treatment except for the use of training materials. During Week 2, the SCT therapist meets the patient for another 60-min session, while the MCT therapist speaks with the patient briefly on the telephone. During this telephone conversation, the MCT therapist will ask general questions regarding treatment progress, relaxation practice, and any behavior monitoring/recording that was assigned during Week 1. The

TABLE 1
Example Minimal Therapist Contact Treatment versus Standard Clinic-Based Treatment Protocols

Week	Session content	Type of contact		Time (min)		Training material
		MCT ^a	SCT ^b	MCT	SCT	MCT
1	Education, treatment rationale, relaxation demonstration	Clinic	Clinic	60	60	Manual, audiotape
2	Progressive muscle relaxation (PMR) exercises; discrimination training (16 muscle groups)	Phone	Clinic	10	60	Manual, audiotape
3	PMR exercises (8 muscle groups)	None	Clinic	0	60	Manual, audiotape
4	PMR exercises (4 muscle groups)	None	Clinic	0	60	Manual, audiotape
5	PMR exercises (4 muscle groups); relaxation by recall, autogenic phrases, positive imagery, problem solving	Clinic	Clinic	60	60	Manual, audiotape
6	Same as Week 5	Phone	Clinic	10	60	Manual
7	Same as Week 5	None	Clinic	0	60	Manual
8	Review all components	Clinic	Clinic	40	60	Manual
Total		3 visits 2 phone calls	8 visits	180	480	

^a MCT = Minimal Therapist Contact Treatment.

^b SCT = Standard Clinic-Based Treatment.

MCT therapist will also briefly discuss the treatment activities for the upcoming weeks and remind the patient of the date and time of the second treatment session that will take place during Week 5.

During Weeks 3 and 4, the MCT patients do not have any contact with the therapist. They follow the readings and instructions regarding further development of relaxation and stress management skills that are contained in the manual and use the audiotapes to guide their skill acquisition and practice.

Week 5 for the MCT patients involves a 60-min clinic visit during which the therapist reviews the materials and the homework assigned during Weeks 3 and 4. The therapist also discusses problem solving, previews the information for Week 6, and schedules the final clinic visit for Week 8.

At the end of Week 6, a 10-min telephone contact is conducted. During this contact, the MCT therapist will ask questions regarding treatment progress, skills practice, and problem-solving exercises, discuss briefly the material for Week 7, reinforce the patient's effort and progress, and confirm the appointment for Week 8.

No contact is made with the patients in MCT during Week 7, and the patient meets with the therapist for a final 40-min session at the end of Week 8. During this visit, the materials and practice of skills from Weeks 5 through 8 are reviewed, posttreatment plans and goals

are developed, and feedback is acquired regarding the treatment process.

Throughout the same 8-week period, SCT patients are exposed to the same information and skills, but they are delivered in weekly, 60-min, in-clinic sessions, with or without supplemental written and audiotape materials. It is important to recognize that many SCTs utilize supplemental materials such as manuals and audiotapes; however, in SCTs the intention of these materials is to review and reinforce the information and techniques presented by the therapist during in-clinic sessions. On the other hand, training materials used in MCTs are intended to be the primary delivery medium for the majority of the instruction.

See Also the Following Articles

Art Therapy ■ Bibliotherapy ■ Brief Therapy ■ Home-Based Reinforcement ■ Self-Help Groups ■ Self-Help Treatment for Insomnia ■ Single-Session Therapy

Further Reading

Blanchard, E. B., McCoy, G. C., McCaffrey, R. J., Berger, M., Musso, A. J., Wittrock, D. A., Gerardi, M. A., Halpern, M., & Pangburn, L. (1987). Evaluation of a minimal-therapist-contact thermal biofeedback treatment program for essential hypertension. *Biofeedback and Self-Regulation*, 12(2), 93–104.

- Bollard, R. J., & Woodroffe, P. (1977). The effect of parent-administered dry-bed training on nocturnal enuresis in children. *Behaviour Research and Therapy*, *15*, 159–165.
- Botella, C., & Garcia-Palacios, A. (1999). The possibility of reducing therapist contact and total length of therapy in the treatment of panic disorder. *Behavioural and Cognitive Psychotherapy*, *27*, 231–247.
- Cote, G., Gauthier, J., Laberge, B., Cormier, H., & Plamondon, J. (1994). Reduced therapist contact in the cognitive behavioral treatment of panic disorder. *Behavior Therapy*, *25*(1), 123–145.
- Griffiths, J. D., & Martin, P. R. (1996). Clinical-versus home-based treatment formats for children with chronic headache. *British Journal of Health Psychology*, *1*, 151–166.
- Haddock, C. K., Rowan, A. B., Andrasik, F., Wilson, P. G., Talcott, G. W., & Stein, R. J. (1997). Home-based behavioral treatments for chronic benign headache: A meta-analysis of controlled trials. *Cephalalgia*, *17*, 113–118.
- Richardson, G. M., & McGrath, P. J. (1989). Cognitive-behavioral therapy for migraine head-aches: A minimal-therapist-contact approach versus a clinic-based approach. *Headache*, *20*, 137–142.
- Rowan, A., & Andrasik, F. (1996). Efficacy and cost-effectiveness of minimal therapist contact treatments of chronic headaches: A review. *Behavior Therapy*, *27*, 207–234.

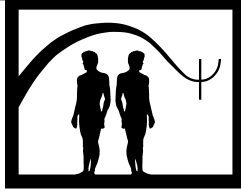

Modeling

Kurt A. Freeman

Pacific University

- I. Components of Modeling Intervention
 - II. Theoretical Bases
 - III. Applications and Exclusions
 - IV. Empirical Studies
 - V. Case Illustration
 - VI. Summary
- Further Reading

I. COMPONENTS OF MODELING INTERVENTION

As an intervention technique, modeling is relatively simple and is designed to assist clients in learning new behavior patterns. The procedure involves two primary components. First, the client is provided with an opportunity to observe the correct or desired form of behavior. Thus, theoretically any behavior that can be replicated in a form that is observable to the client may be taught through modeling. Second, the client imitates the observed behavior, demonstrating learning. For modeling to be effective as an intervention, the client must be able to demonstrate an imitative response. In other words, the client must be able to observe (i.e., pay attention to) the model (i.e., the person demonstrating the desired response) and then implement the skill that was just demonstrated. Clients who have particular characteristics that may interfere with attending to the model (e.g., blindness) or demonstrating the imitative response (e.g., physical disability) may not be good candidates for the use of this intervention.

Modeling is said to produce observational learning on the part of the client. Observational learning can be further divided into two forms of learning: imitation and vicarious learning. Imitation involves simply matching the topography of the observed behavior. For example, if a client observes a therapist demonstrate how to effectively introduce oneself to individuals unknown to the client (a skill that may be lacking in the

GLOSSARY

imitation Re-creation of an observed response.

vicarious learning Change in the likelihood that a person will demonstrate an observed behavior based on whether the observed model experiences reward or punish for engaging in the behavior.

Modeling is a psychotherapy technique utilized to produce changes in a client's behavioral repertoire by providing a demonstration of the desired behavior patterns and then affording opportunities for imitation. In this article, the basic components of the modeling procedure are discussed. Then, the theoretical bases on which the techniques are founded is explored. A review of the applicability of the technique follows, after which a synthesis of relevant research assessing the effectiveness of the approach is provided. Finally, a case example is given as an illustration of the process of using modeling as an intervention.

client's behavioral repertoire), imitation involves the client simply repeating or matching the demonstrated introduction responses. Vicarious learning, on the other hand, involves a change in the likelihood of the targeted response being imitated as a function of observing the model being rewarded or punished for engaging in the targeted behavior. Using the earlier example, vicarious learning may result in the client being more likely to demonstrate the effective greeting response if the modeling situation involves the model being rewarded for implementing the skill (e.g., through a warm reception by "unknown" individuals).

Observational learning as a result of witnessing a model can produce three different effects. First, observing a model can result in the acquisition of previously unlearned behaviors. Thus, modeling can be used to increase a person's behavioral repertoire. In addition to establishing completely novel behavior patterns, modeling can facilitate chaining—the process of sequentially exhibiting various behaviors so that they form a complex pattern.

Second, modeling can result in a strengthening or weakening of inhibitory responses, referred to as inhibitory or disinhibitory effects, respectively. Regarding the former, modeling can strengthen inhibition to engage in a particular response via exposure to a model who is punished for engaging in the targeted behavior. Take, for example, a young child who tantrums. Assume that her parents are using time out as a punishment technique to decrease tantrums. If the time-out procedure is effective, it will inhibit the likelihood that the young girl will tantrum. Furthermore, if she observed (perhaps at school) another child being placed in time out after engaging in a tantrum, this could further decrease the likelihood that she will tantrum. Through observing the model (in this case, the other child) being punished for the target behavior, she is now even less likely to engage in the tantrum, above and beyond the decrease produced by experiencing the time out directly. Alternatively, modeling can weaken previous learning that has inhibited responding. As an illustration, consider a student who was previously punished for participating in class (e.g., other students laughing at his incorrect answers, the teacher sternly correcting the student when he is wrong). If this student observes a model experience rewarding consequences as a result of participating in class, this may weaken the previous inhibitory learning, thus increasing the likelihood that the student will participate.

Finally, modeling may evoke previously learned behavior patterns, referred to as the response facilitation effect. Although seemingly similar to the disinhibitory effect,

the response facilitation effect differs because of the previous learning that was involved. The disinhibitory effect occurs when behavior was previously punished. However, the response facilitation effect produces an increase in the likelihood of the occurrence of a response pattern that was not previously punished. In essence, then, the modeled behavior in this case simply serves as a cue to engage in behavior that has already been learned.

In 1977, Albert Bandura described the factors that influence the effectiveness of modeling as a behavior change technique. First, if modeling is being used to facilitate the demonstration of a particular behavior pattern by the observer, then the modeled behavior should result in successful (i.e., reinforcing) consequences for the model. Second, modeling is more likely to produce the desired impact if the model is similar to the observer(s), or has a high status. For example, if one is working with an adult African American client, modeling may be more effective if the model is also an adult African American individual. Thus, attention to factors such as age, gender, and ethnicity are important when selecting a model. Third, the complexity of the behavior modeled should be appropriate based on the abilities and developmental level of the observer. Fourth, the observer has to attend to the model for the exposure to have an effect. Fifth, the modeled behavior should occur within the proper context. For example, if a therapist is trying to teach the social skills necessary for successfully greeting a new person, the therapist should arrange a situation in which the client can observe one person demonstrate the necessary skills while interacting with a second person, perhaps in the waiting room or other similar situation. Sixth, the modeled behavior should be repeated as frequently as necessary for the learner to demonstrate correct imitation. To facilitate generalized learning, the desired behavior should be modeled in various situations and context. Finally, the observer should be given opportunities to imitate the modeled behavior as soon as possible after modeling has occurred, with corrective and positive feedback provided.

There are several variations in the format of presenting the modeling procedure to the client. The traditional form involves a live model demonstrating the desired responses. The client watches the model and then is provided with the opportunity to demonstrate the imitative response. Live, or *in vivo*, modeling is advantageous because of the ability to adapt and modify the model selected and the demonstration of the desired response to best meet the needs of a particular client. For example, specific appropriate models can be selected to match the

characteristics of the client. Furthermore, particular behaviors of concern that are idiosyncratic to the client can be selected and demonstrated. However, the advantages of *in vivo* modeling can also be disadvantages in that it may be difficult to select ideal models or create the necessary conditions for the demonstration of various forms of behavior.

To provide for frequent exposure to the model, symbolic modeling may be used. Symbolic modeling can be achieved via the use of several different modeling formats, such as use of video, film, slide presentation, and so on. With symbolic modeling, the model is somehow recorded while demonstrating the desired responses. Then, the client is exposed to the recorded version of the modeling demonstration. Although the initial investment may be larger in terms of equipment and time needs, symbolic modeling can result in more efficient demonstration of the desired responses because once the model is recorded, it can be used repeatedly with the same client, or with multiple clients. In fact, there are commercially available resources to teach a variety of skills via symbolic modeling.

Finally, covert modeling has been described in the literature. Covert modeling involves carrying out the intervention via the use of imagery. With this variation, the client is instructed to imagine the model demonstrating the desired response, rather than actually witnessing the scenario *in vivo*. For a person to participate in covert modeling, she or he must be able to create detailed cognitive/mental images. Thus, careful assessment of a client's abilities to create detailed images is necessary prior to using covert modeling. Like live modeling, covert modeling has as an advantage flexibility in that a client can image models and scenarios that are particularly relevant. Furthermore, like video or film modeling, covert modeling has as an advantage ease of implementation in that a client can be repeatedly and frequently exposed to the model with minimal effort.

In addition to the general formats of modeling, the variants of this procedure can be further defined by whether they involve simple modeling or participant modeling. The former involves exposure to the model presented in any of the formats described earlier, followed by the opportunity for imitative responding. Participant modeling, on the other hand, also involves some form of guide practice either during or just after exposure to the model. With this form of modeling, the clinician physically guides the client to engage in the desired response, thus ensuring correct or successful performance.

Regardless of the form of modeling used, there are several components to the use of the intervention that

should be considered, as described by Sherry Cormier and Bill Cormier in their 2000 text. First, the client should be provided with a rationale for the use of the modeling procedure. Essentially, the therapist should explain that by observing effective demonstration of skills/behaviors, the client should be better able to learn those desired responses. Second, Cormier and Cormier recommend addressing five components of the actual modeling scenario: (a) specifying and dividing desired goals into identifiable behavioral responses, (b) arranging the actual behaviors into a logical order of presentation, (c) selecting the appropriate model, (d) providing verbal instructions to the client prior to modeling, and (e) demonstrating the targeted behaviors repeatedly. Third, the client needs to be provided with an opportunity to demonstrate the modeled responses. At this stage of the intervention, the therapist should observe the client imitate the response, provide induction aids (e.g., verbal or gestural prompts), and offer positive and corrective feedback. Feedback and induction aids can be reduced and eliminated as the client demonstrates mastery of the responses. Finally, critical to the success of any modeling situation, the therapist should ensure that the imitated behavior produces desired, positive outcomes.

II. THEORETICAL BASES

Several authors have hypothesized about the theoretical reasons for why modeling produces observational learning. Those explanations have ranged from being firmly grounded within behavior analytic theory to being linked to cognitive and social learning theories. The cognitive-behavioral account provided by Albert Bandura, the researcher perhaps most strongly associated with modeling and observational learning due to his prolific research and writings about the topic, has received the greatest acceptance within the field of psychology.

Bandura proposed the contiguity theory (which eventually became part of his more expanded theory of social learning) as a means for understanding the impact of modeling. According to this theory, an observer acquires (i.e., learns) the modeled response through continuous associations between the observed behavior and sensory events, mental representations, and so on, that occur during the exposure to the model. These "cognitive" events then serve as cues for the occurrence of the behavior that was originally modeled.

According to Bandura, there are four main processes that influence the observational learning that occurs as a

result of modeling. First, attentional processes are important in that they affect how much of an impact the modeled event will have on the observer. Attentional processes are affected by variables related to both the modeling stimulus (e.g., salience, distinctiveness, complexity, prevalence) and the observer (e.g., sensory capabilities, emotional arousal, past reinforcement history). Second, retention processes are involved, including such factors as symbolic coding of the modeled behavior, cognitive organization of the observed information, and symbolic and motoric rehearsal (i.e., imitation). Third, motor production processes are important influences in observational learning. Physical capabilities of the observer/learner, previous learning of similar responses, self-observation of imitation, and feedback regarding the accuracy of the imitative response are all variables that affect whether observing a model will result in imitative responding. Finally, motivational processes such as external reinforcement, vicarious reward and punishment, and self-reward or -punishment all are relevant to determining whether observing a model will produce imitation.

III. APPLICATIONS AND EXCLUSIONS

Unlike some psychotherapeutic techniques that are applicable for use with a limited number of clinical problems, evidence suggests that modeling strategies are effective with a wide variety of psychological, behavioral, emotional, and social problems. In fact, research evaluating the applicability of this intervention is so large that a thorough discussion is beyond the scope of this article. Instead, a brief discussion is provided to familiarize the reader with relevant issues.

As mentioned earlier, for modeling to be effective as a psychotherapeutic intervention, it is necessary for the person to be able to both attend to the model and engage in the imitative response. Thus, as the research supports, use of this intervention is possible with clients who meet these prerequisite skills. The clinician needs to determine whether the modeling procedure is the technique most likely to produce the desired effect. Thus, the clinician should consider various factors when determining whether to use this intervention, such as the clinical issue at hand, the complexity of the desired outcome, the ability to create the appropriate modeling conditions, and client interest and motivation.

Extending the applicability of the intervention even further, evidence suggests that modeling actually can be

used with people who do not already demonstrate imitative responses. Through the use of prompting, shaping, and differential reinforcement, the generalized imitative response can be taught to clients who do not already exhibit such behavior. As a result, modeling may be used with people with severe or profound retardation, autism spectrum disorders, and clients with psychoses who do not already demonstrate the imitative response. In such situations, if use of modeling is desired, clinicians must first teach the imitative response to the clients. Once imitation is established, continued use of reinforcement for said responses will ensure that such clients will be able to benefit from modeling.

When considering the use of modeling strategies, one should also consider that particular formats of modeling have been shown to be more beneficial for use with certain clinical issues. For establishing new behavioral repertoires, evidence suggests that modeling (*in vivo* or symbolic) with guided performance may be effective. With this variant of modeling the client is first exposed to the model (with steps taken to ensure that the client is attending). Then, the client is guided to perform the desired behavior, after which reinforcement is provided for demonstrating the behavior. Use of the physical guidance is gradually decreased as the client demonstrates the imitative response with increasing independence.

Presentation of coping versus mastery models should also be considered. Coping models are those models who initially exhibit flawed or fearful performances, but then become increasingly competent in the desired behavior. This transition may occur during one or repeated modeling implementations. Mastery models, on the other hand, demonstrate the desired behavior perfectly from the beginning. Evidence suggests that coping models may produce more beneficial outcomes for clients, particularly when targeting fears, phobias, or other avoidance-based clinical problems. The opportunity to observe someone experience similar fear reactions, and then learn to overcome them, appears central to this finding.

Finally, evidence suggests that modeling techniques are useful with clients from diverse ethnic and cultural backgrounds. Studies have evaluated various modeling interventions with African Americans, Asian Americans, Hispanic Americans, gays, and lesbians. The use of ethnic and/or culturally similar models increases the salience and relevance of the model, thereby increasing the likelihood that clients will attend to the models. Although the general intervention format will not vary greatly across ethnic groups, Sherry Cormier and Bill

Cormier suggest in their 2000 text that clinicians consider three issues to ensure cultural sensitivity: (a) ensure that the live or symbolic model is culturally similar to the client, (b) ensure that the content to be demonstrated in the modeling scenario is culturally sensitive, and (c) be familiar with and account for differences in how people attend to, learn from, and use modeled information.

IV. EMPIRICAL STUDIES

Although the phenomena of learning via observing a model has been recognized for many years, methodologically sound research on the influence of models on observer's behaviors dates back to the 1950s and early 1960s. During this early research, experimenters designed investigations that documented the occurrence of observational learning. For example, researchers demonstrated that participants would engage in imitative responses of observed behaviors in the presence of the model who had demonstrated the behavior. This early research was important in that it demonstrated the phenomena of interest could be investigated under controlled, replicable conditions.

In 1961, Albert Bandura, Dorothea Ross, and Sheila A. Ross expanded on earlier non-clinical research by investigating whether the imitative response would occur in the absence of the model. To do so, they had 36 boys and 36 girls with a mean age of 59 months observe adult models engage in either aggressive or non-aggressive behavior with inanimate objects (i.e., toys). Following the observation period, the children were allowed to interact with the toys in the absence of the models while experimenters documented the presence or absence of aggressive imitative responses. Those children who observed the aggressive models were more likely to be aggressive with the toys than those children who had watched non-aggressive models. More important, Bandura, Ross, and Ross demonstrated that the influence of the model persisted in the absence of the actual model. Over the next 10 to 15 years, Bandura and his colleagues conducted numerous studies evaluating the effectiveness of modeling, the conditions necessary to produce observational learning, and the extent of learning produced via the process of modeling.

Applied research also has emerged and strengthened the position that modeling is an effective therapeutic tool. Since the initiation of this research, investigations have demonstrated the effectiveness of modeling with children, adolescents, and adults, and for various clinical

problems (e.g., aggression, poor social skills). Furthermore, the intervention has proven effective with clients from various ethnic and cultural backgrounds. What follows is a sample of research on modeling in these different areas.

A significant amount of research has demonstrated the usefulness of various forms of modeling with children and adolescents. For example, in 1942 Gertrude Chittenden utilized symbolic modeling to alter aggressive responses by children. In this investigation, the participants were exposed to several "plays" in which an adult and a child used dolls to enact non-aggressive alternative responses in reaction to a situation in which both dolls wanted to play with the same toy, a scenario shown to produce aggressive responses in the participants. Furthermore, the plays involved the dolls receiving positive rewards for demonstrating the prosocial alternative responses. During observations conducted after watching the models, Chittenden found that there was a significant decrease in displays of aggressive responses and increase in modeled prosocial behavior.

In 1986, Eva Feindler, Randolph Ecton, Deborah Kingsley, and Dennis Dubey utilized modeling as one of several interventions to address anger management problems displayed by adolescent males residing in a psychiatric hospital. These experimenters used a between-groups wait-list control design to evaluate the impact of an 8-week group therapy program targeting anger control. The intervention group was taught various anger control strategies via the use of symbolic and participant modeling, which also included opportunities for role playing and behavioral rehearsal. Results indicated that the experimental group displayed significantly lower rates of anger problems posttreatment as compared to the members of the wait-list control group.

Research on the use of modeling to treat anger control problems and aggression is not limited to children and adolescents. In 1990 Frank Vaccaro assessed the impact of instructions, *in vivo* modeling, role playing, and feedback on verbal aggression displayed by 6 institutionalized older adults. Using an ABAB single-subject design, Vaccaro found that the intervention resulted in decreased instances of verbal aggression for all 6 participants. Further, improved behavior generalized from the experimental situation (i.e., the group therapy sessions) to the milieu setting.

A significant amount of research has been conducted assessing the utility of different modeling approaches to treating fears and phobias exhibited by both children and adults. In 1996, Rutger W. Trijsburg, Marko Jelicic, Walter W. van den Broek, and Annelies E. M. Plekker

utilized participant modeling to treat phobic reactions to injections experienced by a 26-year-old female. According to the authors, this client demonstrated a “resistant-type” phobia in that she displayed strong, sometimes violent resistance to receiving a shot. Utilizing both scores on the State-Trait Anxiety Inventory and heart rate monitoring, the researchers found that the client’s phobic reactions decreased as a result of exposure to a model receiving shots.

Matthew R. Sanders and Lyndall Jones provided a demonstration of the effectiveness of participant modeling with an adolescent female in 1990. In this investigation, the participant was a 13-year-old female with multiple medical and dental phobias, with comorbid oppositional defiant disorder. At the time of the investigation, she was scheduled for major surgery in 6 months. The investigators utilized coping skills training, systematic desensitization, and *in vivo* desensitization with participant modeling to help her overcome her fears.

As a final example of research demonstrating the utility of modeling to treat fears and phobias, consider a study conducted by K. Gunnar Goetstam and Dagfinn Berntzen in 1997. In this investigation, three pairs of adults with animal phobias participated. One person in each pair had stated that he or she was unable to participate in exposure therapy. Therefore, this person observed the other participant in the pair receiving direct exposure of the feared animal, thus creating a scenario involving *in vivo* modeling. Results showed that after observing the first person participating in direct exposure, the second person’s phobic reactions reduced significantly. Furthermore, following modeling, the second person engaged in direct exposure to further reduce phobic responding. Results showed that treatment goals were achieved within 15 min for participants who had experienced modeling before desired outcome goals were met, as compared to within 1.5 to 2 h for the participants who experienced direct exposure only.

In addition to research demonstrating the usefulness of modeling to treat aggression and phobias, a significant amount of research has shown that these procedures can be used effectively with individuals with developmental disabilities and/or mental retardation. Research with this population has utilized participant modeling, as well as various forms of symbolic modeling.

The use of modeling procedures with children and adults with autism has received particular attention. In 1986, Adeline S. Tryon and Susan Phillips Keane utilized participant modeling to target imitative play in 3 boys with autistic-like features. In this investigation, participants were exposed to a peer demonstrating appropriate play. Peers were selected for their similarity in

age and gender to the participants and for their ability to engage in appropriate play with toys. Results showed that exposure to peer models resulted in increased appropriate play across a variety of toys, as well as a decrease in self-stimulatory behavior.

Researchers have also evaluated the effectiveness of video (symbolic) modeling with individuals with autism. Thomas G. Haring, Craig H. Kennedy, Mary J. Adams, and Valerie Pitts-Conway effectively used video modeling to teach 3 adults with autism skills used to purchase items from grocery and other stores in their research study published in 1987. Furthermore, Marjorie H. Charlop and Janice P. Milstein’s 1989 research article describes the use of video modeling to teach 3 autistic children conversational speech. Finally, Marjorie H. Charlop-Christy, Loc Le, and Kurt A. Freeman demonstrated in their study published in 2000 that video modeling was more effective than *in vivo* modeling in teaching a variety of skills to 5 autistic children.

In addition to the research just mentioned, others have demonstrated the usefulness of modeling specifically with individuals with developmental disabilities to address developmental problems such as delayed social skills, deficits in expressive language, underdeveloped discrimination abilities (e.g., colors, shapes, on/under), and poor walking performance. Furthermore, researchers have demonstrated the utility of various modeling strategies with individuals with mental retardation who are experienced other clinical problems such as substance abuse problems, phobias and fears, selective mutism, and so on.

As should be evident from the brief review provided, modeling procedures are widely applicable and effective. The research described earlier only provides an introduction to the use of modeling, however. Evidence suggests that modeling procedures can be effectively incorporated into treatments for many different psychological, social, and emotional problems. Other clinical and social issues that have been shown to respond positively to modeling include smokeless tobacco use, parenting, child safety, breast self-examination, self-defense skills, altruistic behavior, and gender stereotyping modification, to name just a few more. Thus, the research supports the general applicability and versatility of modeling interventions with a variety of psychological, social, and health-related issues.

V. CASE ILLUSTRATION

Consider Jeremy, a 13-year-old Caucasian male receiving services in a large-scale residential facility. In

addition to full participation in the milieu therapy provided to all residents, Jeremy was also referred for individual psychological services due to social skills problems, oppositionality, and ongoing severe conduct problems. His behavior problems significantly affected his social functioning in that he was severely rejected by his peers. Teacher, peer, and other staff report all indicated that Jeremy was actively avoided, taunted, and made fun of by the majority of his peers. For example, it was not uncommon for Jeremy's peers to say something such as "Don't talk to me!" in response to his attempts to initiate interactions.

Further assessment on initiation of psychological services revealed the presence of significant social skills deficits that likely contributed to his social rejection. First, he was awkward in his attempts to initiate or maintain conversations. Specifically, he would attempt to start conversations by yelling hello to peers or adults from across the room and generally speak with a voice that was louder than conversational level. Second, Jeremy would attempt to procure interactions with popular peers by using age-appropriate phrases or wearing "trendy" clothes. Rather than elevating his social status, these attempts appeared to further alienate him from his peers, as evidenced by laughter and jeers directed toward him. Third, Jeremy tended to use mannerisms and gestures that were exaggerated and excessive. Fourth, Jeremy demonstrated poor table manners, as evidenced by him talking with food in his mouth, eating rapidly and/or with his finger, and eating in a messy manner (resulting in food being on his face and/or clothes). This particular behavior pattern often set the stage for ridicule and rejection during the lunch recess hour. Finally, Jeremy typically presented with a facial expression characterized by a clownlike vacant grin.

Modeling procedures were used during individual therapy sessions to target his social skills deficits directly. First, *in vivo* modeling was used to target his poor table manners. To accomplish this, the therapist conducted 3 one-half-hour sessions weekly while he and Jeremy sat together at a dining table in the lunchroom at Jeremy's junior high school. Sessions occurred during Jeremy's regular lunch period while he and his peers ate lunch. After establishing the need to target table manners, and describing the rationale for participant modeling, the therapist described verbally and demonstrated physically proper table manners (e.g., use of a napkin, appropriate rate of eating, chewing with one's mouth closed). Then, collaboratively the therapist and Jeremy selected a specific skill for focus, rather than attempting to intervene with all relevant behaviors at once.

Once the target skill was selected, the therapist initiated each session by verbally and physically reviewing the proper target behavior and then drawing Jeremy's attention to peers who were demonstrating that behavior while they ate lunch. During the observation, the therapist would verbally describe the behavior being modeled by the peer, as well as point out the positive social benefits of engaging in such behavior. After a brief period of observation, Jeremy was then instructed to eat his lunch while attempting to demonstrate the appropriate response. Positive and corrective feedback was provided during this time. Periodic prompts to observe his peers were also provided until Jeremy demonstrated the skill successfully.

In conjunction with *in vivo* modeling to target table manners, symbolic modeling was used to address various other social skills problems (e.g., facial expressions, voice volume). Sessions involving symbolic modeling typically occurred every other week in a therapy session room. Again, the deficit skills were identified and reviewed prior to implementing the intervention. Furthermore, appropriate skills were also discussed and modeled by the therapist. Examples of targets identified included taking turns appropriately, offering praise to his peer, and displaying facial expressions appropriate to the context. After establishing the target behaviors, symbolic modeling was implemented. Symbolic modeling in this case took the form of videotaped interactions between Jeremy, the therapist, and another similar-aged male peer. The peer was selected because care providers had identified him as being quite socially skilled. Interactions occurred in the context of involvement in some sort of board game. Following 10–15 min of playing the game while being videotaped, Jeremy and the therapist would review the videotape so that Jeremy could observe the peer implement appropriate social skills. Further, Jeremy's behaviors were evaluated, and positive and corrective feedback was provided. Then, Jeremy was provided with another opportunity to interact with the peer and the therapist while playing a game, thus allowing for imitation of the desired responses.

Modeling procedures were effective in altering some of Jeremy's serious social skills deficits in the therapeutic contexts. He learned how to eat in a more socially acceptable manner while the therapist was present, how to talk in a more normal tone of voice while playing a game with a peer, and how to change his facial expressions to more closely match the situation (e.g., smile when there was a joke told, scowl when losing the game). The level of prompting that was needed to ensure the use of these skills decreased during the ther-

apy situation. Unfortunately, however, Jeremy was discharged from the residential program before specific measures could be taken to prompt generalization and maintenance of treatment gains, as these did not appear to be occurring naturally.

VI. SUMMARY

Modeling is a psychotherapy technique that is designed to create opportunities for the client to learn new behavior patterns or alter existing ones. Implementation of the intervention involves several relatively simple steps. First, the client is exposed to a model who demonstrates the desired response. The model can be presented live, symbolically, or cognitively. Second, the client is provided with an opportunity to imitate the desired response. Finally, corrective and positive feedback is provided to the client.

Modeling can produce two different forms of learning, imitation and vicarious learning. Imitation simply involves the observer matching the topography of the model's behavior. Vicarious learning, on the other hand, involves either an increase or decrease in the likelihood that the client will demonstrate the modeled behavior as a result of the model being rewarded or punished, respectively. As a result, the modeling situation should be created in a manner that capitalizes on the desired outcome. For example, if modeling is being used to decrease problem behavior, then the intervention should associate negative consequences with engaging in the behavior.

Research has demonstrated that modeling is an effective psychotherapeutic technique. Evidence suggests

its utility with clients from diverse backgrounds, as well as those with diverse intellectual or developmental functioning. Furthermore, the intervention has been shown to affect a variety of clinical and social problems—such as smoking, phobias and fears, deficits in parenting skills—as well as important health-related behaviors (e.g., self breast examination). Finally, evidence suggests that the intervention may be most effective as a component of a larger set of strategies to address clinical or social issues.

See Also the Following Articles

Behavior Rehearsal ■ Cultural Issues ■ Heterosocial Skills Training ■ Race and Human Diversity ■ Retention Control Training ■ Role-Playing ■ Symbolic Modeling

Further Reading

- Bandura, A. (1977). *Social learning theory*, New York: Prentice Hall.
- Charlop-Christy, M. H., Le, L., & Freeman, K. A. (2000). A comparison of video modeling with in vivo modeling for teaching children with autism. *Journal of Autism & Developmental Disorders*, 30, 537–552.
- Cormier, S., & Cormier, B. (2000). *Interviewing strategies for helpers: Fundamental skills and cognitive behavioral interventions*. Pacific Grove, CA: Brooks/Cole.
- Dowrick, P. W. (1999). A review of self modeling and related interventions. *Applied & Preventive Psychology*, 8, 23–39.
- Masia, C., & Chase, P. (1997). Vicarious learning revisited: A contemporary behavior analytic interpretation. *Journal of Behavior Therapy and Experimental Psychiatry*, 28, 41–51.
- Masters, J. C., Burish, T. G., Hollon, S. D., & Rimm, D. C. (1987). *Behavior therapy: Techniques and empirical findings* (3rd ed.). New York: Harcourt Brace Jovanovich.

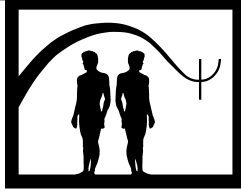

Mood Disorders

Michael Robertson

Mayo-Wesley Centre for Mental Health

Scott Stuart

University of Iowa and Iowa Depression
and Clinical Research Center

- I. Introduction
- II. Depression
- III. Mania and Bipolar Disorder
- Further Reading

unpleasant sense of agitation or sadness rather than classically elevated mood.

GLOSSARY

- depression** An abnormal psychological state that is characterized by reduction of mood, interest, and vitality. It can be considered as the opposite state of mania. Depression differs from normal sadness in the severity of the symptoms and the lack of reactivity to otherwise pleasurable activities.
- dysphoria** An unpleasant emotional state that may be a mixture of sadness, low-grade anxiety, and negativity. Dysphoria is most likely a nonpathological alteration of mood state that represents a part of the normal spectrum of human experience.
- dysthymia** A chronic, persistent disturbance of mood that has some low-grade features of depression persisting over prolonged periods.
- hypomanic episodes** These share many features of manic episodes although they are considered to be not as severe as mania, or to cause as significant an amount of disruption to a sufferer's social or work abilities.
- mania** An abnormal psychological state that is characterized by overexcitement and elevation of mood. A "manic episode" is considered to be present if the symptoms create marked impairment for a person in his or her working and social interpersonal lives.
- mixed mood states** Characterized by the simultaneous presence of manic symptoms and depressive symptoms. Some clinicians refer to this condition as "dysphoric mania," which is characterized by the presence of irritability or an

I. INTRODUCTION

Disorders of mood or affect are among the most commonly recognized psychological disorders in both clinical and community settings. Individuals can develop a mood disorder at any time in their lives, although the nature, clinical presentation, and course of mood disorders vary greatly from individual to individual. This article will describe the features of mood disorders, their etiology, and their treatment.

The terms "mood" and "affect" are often used interchangeably; however, they refer to two different concepts. Mood is best defined as, "the prevalent emotional state described by an individual, consistently present over a prolonged period of day to weeks," as opposed to affect, which is best defined as, "the observable emotional state of an individual at a specific point in time, that may be changeable from moment to moment." Metaphorically speaking, mood refers to a person's climate whereas affect refers to the day's weather conditions.

The disorders of mood clinically recognized currently in the *Diagnostic and Statistical Manual of Mental Disorder, 4th edition (DSM-IV)* are:

1. Depression
2. Mania or hypomania
3. Dysthymia

4. Mixed mood states
5. Dysphoria

II. DEPRESSION

A. History of Depression

Depression is a heterogeneous condition that encompasses different types of illness. In ancient Greece the term “melancholia” (referring to “black bile”) described a temperament characterized by lethargy, sullenness, and brooding. The concept infiltrated Western and non-Western cultures over time and numerous philosophers and physicians have written of its effects on the human psyche.

Sigmund Freud in his 1963 text *Mourning and Melancholia* conceptualized depression as a process of “internalizing” lost loved ones and “turning anger inwards” so that negativity directed at the loss would dominate the psyche. In the latter half of the twentieth century, psychological and psychiatric disorders were seen in more complex biological, psychological, and social terms, leading to a broader conceptualization of depressive disorders as having primarily psychological or biological origins. Currently, depression that is of clinical significance is referred to as a “major depressive disorder” by the American Psychiatric Association. This is the core concept around which our current classification of mood disorders revolves.

B. Phenomenology of Depression

The features of a major depressive disorder are shown in Table I. More severe forms of depression can occasionally have a number of unusual psychotic features such as delusions (false unshakeable beliefs) or hallucinations (disturbances of perception without a stimulus, e.g., hearing voices).

There is considerable variation in the experience and presentation of depression across the life span. In children and adolescents, depression may manifest in non-emotional ways such as behavioral deterioration, withdrawal, irritability, weight loss, school refusal, or self-injury. In the elderly, depression may manifest as preoccupation with health, paranoia, memory loss, cognitive impairment, or irritability. There is also a significant overlap between depression and responses to grief.

C. Epidemiology of Depression

Estimates of the prevalence of major depressive disorder by age and gender have been derived from the

TABLE I
Features of Major Depression

-
1. Significantly depressed mood that is in excess of normal sadness
 2. A loss of interest in an individual's usual activities
 3. Marked loss of self-esteem, or self-reproach
 4. Impaired sleep
 5. Psychomotor agitation or retardation (a subjective sense of either psychological and physical perturbation or slowing)
 6. Reduced or increased appetite with weight loss or weight gain
 7. Feelings of hopelessness about the future
 8. Suicidal thinking
 9. Significant anxiety such as panic attacks or generalized worry or obsessional thinking
-

The Epidemiological Catchment Area (ECA) study of 18,000 community and institutionalized subjects over 18 years of age at five sites throughout the United States, according to Weissman and colleagues in 1991. The ECA found that the overall lifetime prevalence of mood disorders is 6%. This differs slightly from the 1994 DSM-IV data that suggest a lifetime prevalence of 10 to 25% risk of depression in women as opposed to a 5 to 12% lifetime risk for men. The ECA data indicate a much higher prevalence of all the mood disorders among persons under the age of 45. The ECA also reported a relatively higher prevalence of major depressive disorder in women than in men, which, although consistent across the ages, was more evident among the younger adult group than in the elderly or in childhood. The study also found alcohol abuse and dependence was more prevalent in men than in women, leading some to argue that depressive disorders and alcohol abuse and dependence may be different manifestations of the same biopsychosocial vulnerability.

Sex differences in depression begin in early adolescence and persist at least until midlife. However, women with a previous history of a depressive episode are no more likely to experience a new episode than men with a previous history of a depressive episode. This suggests that the higher risk in women results from women having a higher risk of experiencing major depressive disorder for the first time.

A number of studies performed prior to the ECA study suggested that the prevalence rates of depressive disorders may be changing. The findings seemed to indicate a progressively lowering of the age of onset of depressive disorders and a possible increase in childhood

mood disorders as well as an observed reduction in suicide in the elderly.

D. Etiology of Depression

As with most psychological disorders, the causes of depression are multiple and overlapping. It is customary to divide etiological theories of depression into biological, psychological, and social factors.

1. Biological Factors

a. Biogenic Amines The human brain communicates with itself biochemically. The biological chemicals that are involved in this process are referred to as neurotransmitters. There are likely to be numerous neurotransmitters involved in the complex processes of the human brain; however two chemicals from the amine family have been implicated in the disordered functioning of the brain in depression, according to Nemeroff in 1998. The first, serotonin or 5-hydroxy-tryptophan (5-HT), is the most active biological amine in the human brain. A second biogenic amine, noradrenaline (NA), has also been implicated. The biogenic amine theory of depression postulates that levels of 5-HT and NA are present in subnormal levels in the parts of the human brain that regulate mood. The mechanism of action of virtually all antidepressant compounds is to effectively increase the level of activity of these compounds.

b. Neuroendocrine Factors Research by Nemeroff in 1998 indicated that the state of depression is associated with alterations in the level and activity of various endocrine glands, particularly the adrenal gland and the thyroid gland. This research demonstrated that higher levels of corticosteroids such as cortisol are associated with depression, as are alterations in responsiveness of the adrenal gland to the suppressive effects of artificial corticosteroids such as dexamethasone. Other hormonal disturbances include alterations in thyroid gland function.

c. Genetic Factors There have been numerous family and molecular studies of depression; however, progress has been limited by the fundamental problem of phenotypic identification. The controversy regarding the precise definition of depression has limited the study of depression to specific groups of individuals with “undisputed” depression. These patients tend to have more severe depression and are more similar in presentation than many patients treated in clinical settings. This has likely distorted the findings regarding depression to some degree, as most of the patients studied have had this more severe and uniform type of illness.

In general, most family studies highlight that depression and manic depression tends to cluster in families, according to Tsuang in 1990. The risk of developing depression in an individual with a first-degree relative with either depression or manic depression varies from 7 to 15% for depression and manic depression. Moreover, studies of identical (monozygotic) and nonidentical (dizygotic) twins indicate that the concordance for depression is approximately 60% for monozygotic twins and 30% for dizygotic twins, as discussed by Taylor in 1993.

Studies examining linkage of depression to other genes and molecular markers have been promising but inconclusive. In essence, the balance of opinion regarding the genetic etiologic factors in depression is that they are polygenic and multifactorial.

2. Psychological Factors

a. Attachment Style In the 1950s, John Bowlby evolved the concept of “attachment,” which referred to the complex process by which animals and humans seek proximity to and interact with caregivers. Bowlby postulated that there was a biological and psychological drive to seek proximity to caregivers. Later studies, such as Ainsworth and colleagues’ 1985 observations of infants’ responses to separation from their caregivers, created the notion that human attachment could be either “secure” and flexible, or “insecure.” The notion that attachment styles remained fixed throughout the life span suggested that adults could also be securely or insecurely attached. It is common to observe patterns of disturbed attachment in individuals who develop depressive disorders; however, insecure attachment in itself does not condemn an individual to depression. It is likely that a “poorness of fit” between a person with an insecure attachment style and his or her social environment will predispose an individual to depression.

b. Cognitive Style In the late 1960s, Aaron Beck formulated the idea that certain styles of viewing the world could predispose an individual to depression. Beck saw that individuals evolved a pattern of perceiving and interpreting events described as a “schema.” A cognitive schema that was “depressogenic” was characterized by a triad of a negative view of self, present circumstance, and future circumstances. Further, depressed individuals have been found to have depressive attributional styles that are more global and stable than nondepressed individuals. Beck’s clinical approach thus advocates identifying and altering factors in these types of schema.

c. Personality and Temperament Personality refers to the relatively enduring and stable patterns of thinking,

behaving, and acting that are present consistently over time. The various recent psychiatric classification systems such as the American Psychiatric Association's 1994 *Diagnostic and Statistical Manual of Psychiatric Disorders 4th Edition (DSM-IV)* and the World Health Organization's *International Classification of Disease (ICD-10)* have highlighted the concept of "personality disorder" as a substantive clinical entity. This construct emphasizes the presence of persisting maladaptive patterns of interaction that produce clinically significant impairment in social, occupational, and interpersonal functioning. Certain types of personality, such as those with unstable emotions or relationships (borderline personality disorder) or excess perfectionism (obsessional personality disorder) may be at higher risk for depression.

Temperament refers to those biologically based dispositions that color personality. It was of interest in antiquity and has more recently enjoyed increased attention in a research and clinical context. Temperament is evident across the life span and relatively stable over time. Authors such as C. Robert Cloninger in 1987 have described temperament-based personality variables such as "novelty seeking," "harm avoidance," and "reward dependence" that may have their origin in neurophysiological states. These temperamental characteristics may have significance in the genesis of depression.

3. Social Factors

a. Early Environment Loss of a parent in early childhood has been long considered a risk factor for the later development of depression. More recently, loss of a parent either through death or family disintegration and the associated ecological disruptions have been associated with depression as well. Early childhood difficulties such as childhood anxiety disorders, behavioral problems, or illness may predispose an individual to later adult psychopathology.

b. Gender There has been an apparent higher incidence of depression in women as opposed to men. This has been debated, however, as some experts, including Jorm in 1987, have argued that the prevalence of mood disorders is roughly equal between the sexes, but that women are more likely to present for treatment or divulge depressive symptomatology.

c. Interpersonal Factors Specific studies including Brown's 1978 research, have isolated independent risk factors for depression in women including the lack of a

confiding relationship and having more than three children. Similarly, the lack of a social support network seems to be a risk factor for depression in both sexes. Unemployment and other social adversity as well as abrupt loss of status are also associated with depression.

E. Treatment of Depression

As depression is invariably the product of a complex interaction of biological, psychological, and social factors, interventions in the treatment of depression are also grounded in these three areas.

1. Biological Treatments for Depression

a. Antidepressant Medication The current understanding of the biochemical origins of depression has led to several generations of medications that putatively correct the underlying "biochemical imbalance." At present these agents all have the effect of altering the activity of biogenic amines in the human brain. The classes of agent and their putative mechanisms of action are listed in Table II and depicted in Figure 1.

Duration of drug treatment. The duration of treatment with antidepressant agents has been an area of recent controversy. Studies have indicated that in many cases depression is a relapsing and remitting condition that requires long-term treatment, according to the American Psychiatric Association in 1993. Several useful terms describing the stages of treatment of depression include:

TABLE II
Classes of Antidepressants and
Their Putative Mechanisms of Action

Selective serotonin reuptake inhibitors (SSRI)—Inhibit serotonin reuptake pump
Serotonin-noradrenaline reuptake inhibitors (SNRI)—Inhibit serotonin and noradrenaline reuptake pumps
Monoamine oxidase inhibitors (MAOI)—Inhibit the enzyme that catabolizes biogenic amines
Tricyclic agents—Inhibit serotonin and noradrenaline reuptake and alter postsynaptic receptor activity
Tetracyclic agents—Block alpha-2 noradrenaline receptor (stimulation of this inhibits release of biogenic amines)
Other agents—Varied degree of activity
mirtazapine—blocks alpha-2 noradrenergic receptors and type 2 and 3 serotonin receptors
nefazodone—inhibits serotonin transporter and type 2 serotonin receptors

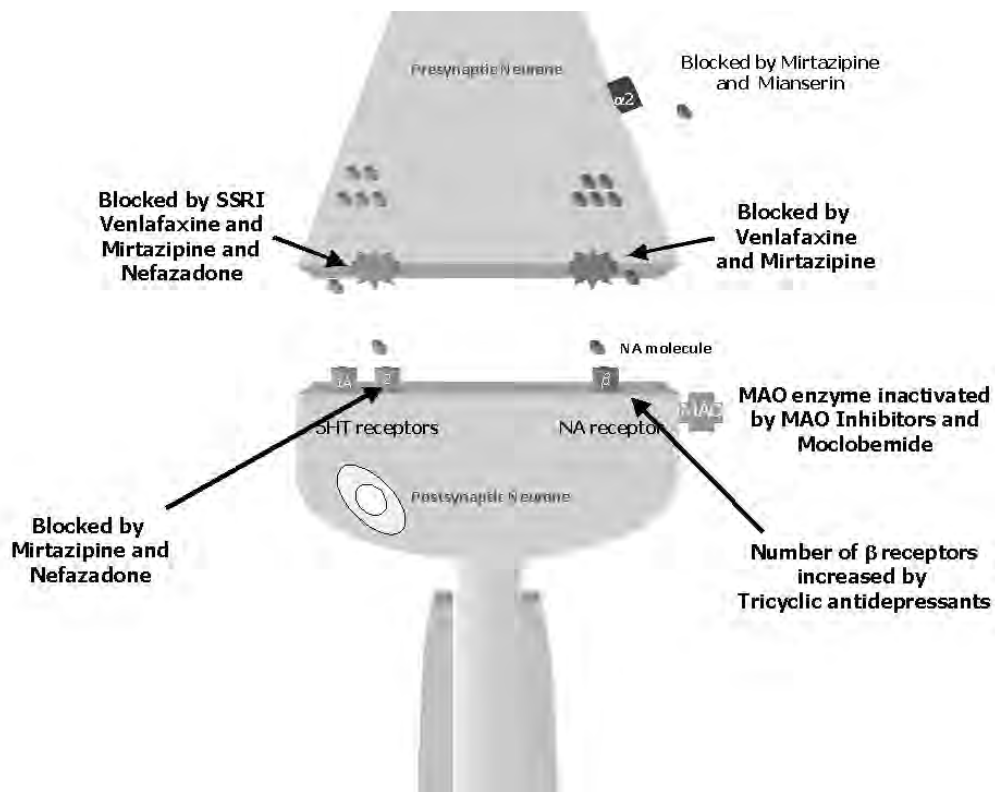
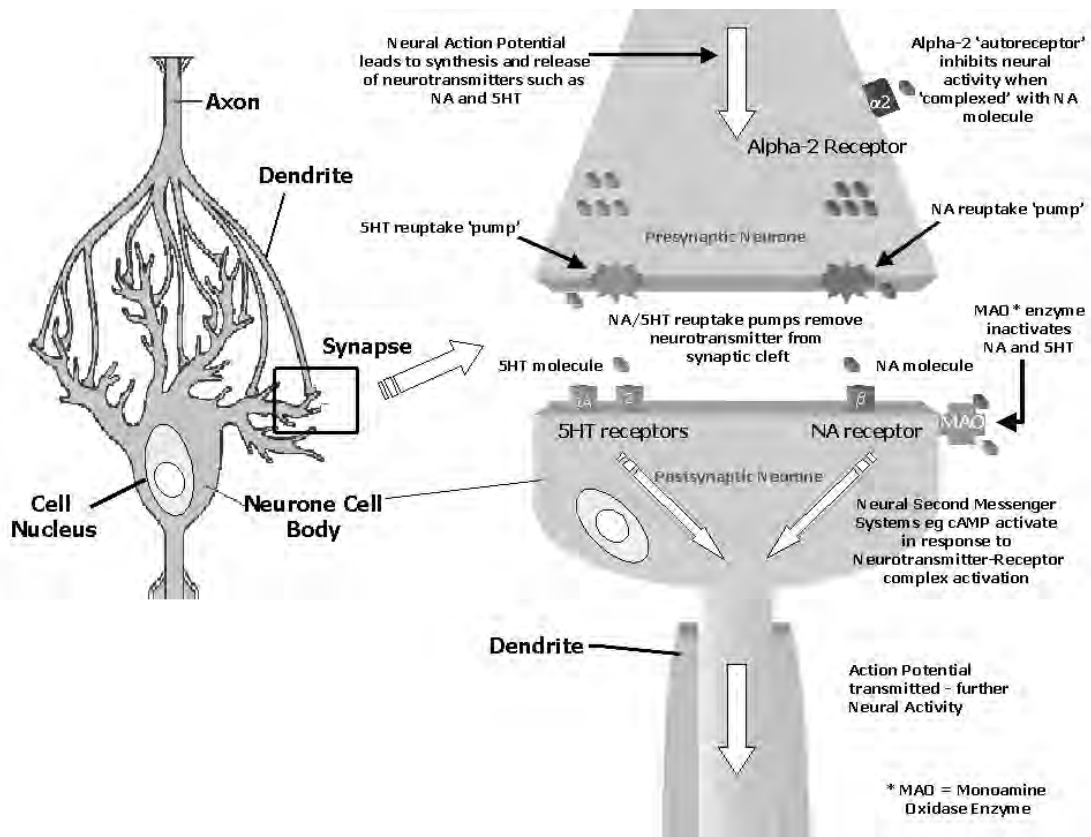

FIGURE 1 Putative mechanisms of action of antidepressant agents.

1. **Response:** the point at which depressive symptoms alter following treatment initiation. A 50% reduction in the level of symptoms is typically considered a response to treatment.
2. **Remission:** the point at which the diagnostic criteria for depression are no longer met. There may be residual symptoms at this point.
3. **Recovery:** the point of resolution of the depressive syndrome. This period requires 3 months of remission prior to being defined as remission.
4. **Relapse:** the reemergence of the depressive syndrome within the 3-month recovery phase.
5. **Recurrence:** the reemergence of symptoms during the remission phase.

The natural history of depressive disorders is for a 50% rate of recurrence after one episode of major depression and an 80 to 90% rate of recurrence after two episodes, according to the American Psychiatric Association in 1993. It states, therefore, that long-term treatment with antidepressant medication is necessary in cases where individuals are at high risk of recurrent depression.

b. Electroconvulsive Treatment Electroconvulsive treatment (ECT) is perhaps the most controversial area of psychiatric practice. In the late 1930s an Italian psychiatrist Ugo Cerletti experimented with convulsive treatments using electrical stimulation, as described by

Abrams in 1988. This was based on observations that people suffering comorbid epilepsy and depression experienced improvements in their mood after seizures. According to Abrams, as technology and neuroscience have advanced, ECT has become a safe and effective treatment for severe biological depression.

It is thought that the therapeutic effects of ECT result from changes in the brain's biochemistry. Over a course of treatment, ECT has anticonvulsant effects that raise seizure threshold and decrease seizure duration. The so-called seizure threshold at which seizures will occur increases during ECT and it is thought that this may be a part of its mechanism of action. Periods of increased electrical activity in the brain, including seizures, promote the release of the compound adenosine, which in turn acts on several neuroreceptors to produce alteration of their chemical activity. Additionally, ECT increases norepinephrine turnover and α_1 -adrenergic receptor sensitivity and decreases presynaptic α_2 -adrenergic receptors. ECT also appears to enhance the effects of the serotonergic system but differs from antidepressant medication treatment in producing increases in serotonin (5-HT₂) receptor binding in the cerebral cortex. These findings suggest that ECT may have important actions on monoaminergic transmission that contribute to its therapeutic effects.

c. Rapid Transcranial Magnetic Stimulation Rapid transcranial magnetic stimulation (rTMS) uses an exter-

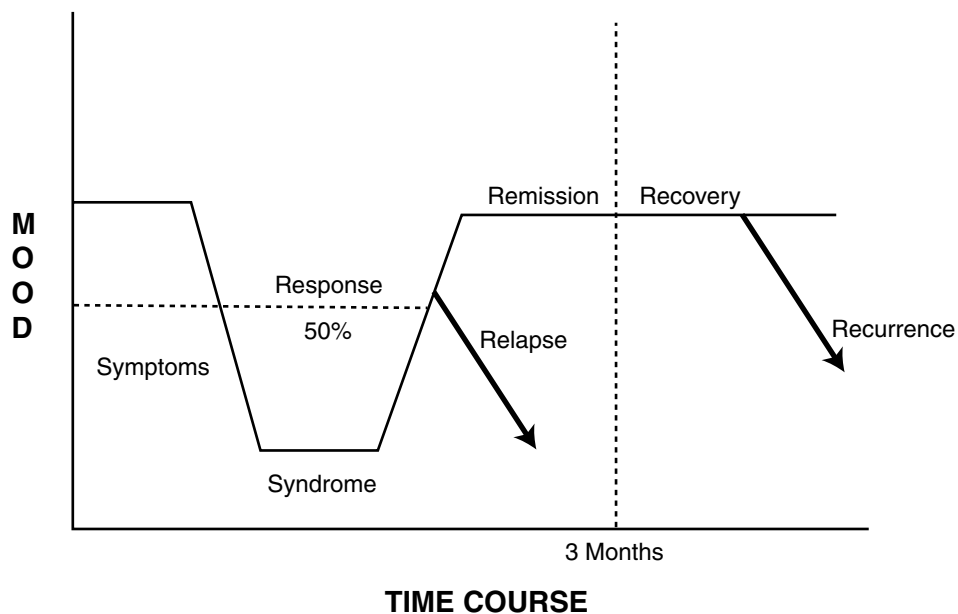

FIGURE 2 The stages of depression treatment.

nal magnetic field passed through a small coil applied to the scalp to allow focused electrical stimulation, which generates a focused magnetic field of 1.5 to 2 teslas. The magnetic field in turn depolarizes brain cells to a depth of 2 cm from the coil. Some evidence suggests that major depression may be characterized by hypoactive cortical areas. It was postulated by Post and colleagues in 1997 that rTMS stimulation of these frontal areas may help relieve symptoms.

Currently, the use of rTMS for the treatment of neurological and psychiatric disorders is still under investigation. Several open-label and controlled studies have suggested that rTMS may be at least temporarily effective in both animal models of depression and patients with major depression, according to Post and colleagues in 1997. A number of small, open-label studies have suggested that rTMS may be effective in some patients with treatment-resistant major depressive disorder as well as in those with milder major depressive disorder.

d. Phototherapy Phototherapy (light therapy) was first introduced in 1984 as a treatment for seasonal affective disorder (SAD; depression with seasonal pattern). In this disorder, according to Wehr and Rosenthal in 1989, patients typically experience depression as the sunlight period of the day decreases with advancing winter. Women represent at least 75% of all patients with seasonal depression, and the mean age of presentation is 40, as discussed by Blehar in 1989.

Phototherapy typically involves exposing the afflicted patient to bright light in the range of 1,500 to 10,000 lux or more with a light box that sits at face level for approximately 1 to 2 hours before dawn each day, according to Lam in 1994. As circadian rhythms are frequently disrupted in major depression, this is thought to be the basis of SAD and some of the features of depression. Exposure to light results in a phase advance that shifts the phase response curve earlier in the day. In addition, light suppresses the production of melatonin from the pineal gland at night. A number of controlled studies by Blehar in 1997 suggests that phototherapy is effective as monotherapy and as an adjunctive agent in the treatment of seasonal depressions.

2. Psychological Treatments for Depression

The specific details of this area are discussed elsewhere in this text. In brief, a number of studies have confirmed that the focal structured psychotherapies such as Beck's cognitive behavior therapy (CBT) and Klerman's interpersonal psychotherapy (IPT) are equivalent in antidepressant efficacy for depression of mild to moderate

severity, according to Elkin in 1989. There is also evidence that the combination of antidepressant medication and psychotherapy has greater efficacy than either alone. Evidence suggests that a short-term psychotherapy, while efficacious in acute depression, confers little protection against further episodes. There is now a shift to studying and providing psychological treatments in maintenance fashion as well as acute treatment for depression.

III. MANIA AND BIPOLAR DISORDER

A. History of Bipolar Disorder

Aretaeus of Cappadocia (ca. 150 AD) is likely to have initially nominated that mania and melancholy were associated entities stating, "It appears to me that melancholy is the commencement and a part of mania" (see Goodwin and Jamison's 1990 work). In the 19th century, French psychiatrists offered the description "folie à double forme." Later that century, the German psychiatrist Emile Kraepelin elaborated the ideas that the core of depression was lowered mood and slowed mentation, whereas mania was characterized by elation and accelerated mental activity. Unlike depression, which may have significant "neurotic" contributions, Kraepelin saw manic states as being hereditary and biologically determined.

B. Phenomenology of Bipolar Disorder

Bipolar disorder is diagnosed when a person suffers a manic episode at some point in his or her lifetime. People who suffer from bipolar disorder are prone to develop episodes of hypomania, mania, and depression. The features of a manic episode are listed in Table III.

A "manic episode" is considered to be present if the symptoms create marked impairment for a person in his or her work or social and interpersonal functioning. "Hypomanic" episodes share many features of manic episodes although they are considered to be not as severe or to cause as significant amount of disruption to a sufferer's social or work functioning.

Current classification systems describe a number of different types of bipolar disorder:

1. **Type I bipolar disorder:** Diagnosed if an individual suffers an episode of mania. Depressive episodes may or may not be present as well.

TABLE III
Features of a Manic Episode

-
1. Distinct periods of abnormal or persistently elevated or irritable moods
 2. Inflated self-esteem or grandiose behavior
 3. A decreased need for sleep
 4. Overtalkativeness
 5. Racing thoughts
 6. Being easily distracted
 7. Overactivity including increased productivity, increased sexual drive, or purposeless agitation
 8. Overspending
 9. Disinhibition in social activities
 10. Possible recklessness in behavior including gambling, sexual indiscretions, or exercising poor judgment
 11. Psychosis including hallucinations (abnormal sensory experiences), severe disorder of thinking, or delusions (fixed unshakeable ideas that are often false).
-

2. **Type II bipolar disorder:** Diagnosed if an individual suffers episodes of both depression and hypomania.
3. **Mixed mood states:** Characterized by the simultaneous presence of manic symptoms and depressive symptoms. Some clinicians often refer to a condition known as “dysphoric mania,” which is characterized by the presence of irritability or an unpleasant sense of agitation or sadness rather than classically elevated mood.

C. Epidemiology of Bipolar Disorder

The ECA data suggest that the lifetime risk for bipolar disorder is approximately 1.2% in the general population. It commonly affects young adults from 20 to 40 years of age. It tends to affect both men and women equally, and also appears to have a similar rate of occurrence across a variety of cultural and racial groups, according to Weissman and colleagues in 1991.

D. Etiology of Bipolar Disorder

1. Biological Factors

Unlike depression, mania is now regarded as primarily a biologically determined process. The general consensus is that during a manic episode the brain is usually overactive in terms of chemical activity, electrical activity, and generalized neurological processes. Most studies, according to Post in 1997, have consistently indicated

that there may be imbalances or overactivity of a number of neurotransmitters including serotonin, noradrenaline, dopamine, glutamate, and other excitatory compounds during acute mania as well as possible disturbances in thyroid hormone or cortisol and newly described neurochemicals such as neuropeptides.

More recently, researchers have uncovered some possible disturbances in complex chemical processes occurring within the neurons including alterations in the activity of so-called second messenger systems involving compounds such as cyclic adenosine monophosphate (cAMP) and phosphatidylcholine, as described by Post in 1997.

There has been some additional interest in a process referred to as “kindling” (in which a number of neurons are chronically hyperactive and have a tendency to summate with produced marked neural overactivity, rather like kindling in a fire combining to produce a large flame) in the temporal lobe of the cerebral cortex and more specifically the deep nuclei that comprise the limbic system including the hippocampus and amygdala, according to Post in 1997.

2. Genetic Factors

A first-degree relative (such as child or sibling) of someone suffering from bipolar disorder has approximately a 6% risk of developing bipolar disorder but a 15% risk of developing either depression or bipolar disorder, according to Tsuang in 1990. Tsuang notes that children of people suffering from bipolar disorder have approximately a 25% risk of developing a mood disorder if either parent suffers from bipolar disorder and a 75% risk of developing a mood disorder if both parents suffer bipolar disorder.

E. The Treatment of Bipolar Disorder

1. Medication

The treatment of mania and hypomania has two phases: an acute phase, in which the acute syndrome is quelled and social and occupational impairment is improved; and a maintenance phase, in which medications are administered long term to prevent the recurrences of the condition.

a. Mood Stabilizers

Lithium. In the 1940s Australian psychiatrist John Cade discovered the tranquilizing properties of lithium (see work by Goodwin and Jamison in 1990). Since

that time lithium has been the primary treatment for acute and prophylactic treatment of mania. In comparative studies with antipsychotic agents, it yields better overall improvement in most aspects of manic symptomatology, including psychomotor activity, grandiosity, manic thought disorder, insomnia, and irritability, according to Post in 2000. The type of patient most likely to respond to lithium carbonate is someone with a classic presentation and euphoric mania (rather than dysphoric mania) and a pattern of mania followed by a depression and then a well interval. The number of patients with this “classic” presentation is relatively small, hence lithium’s status as the “gold standard” treatment is under threat.

Valproic Acid. Studies by Bowden and colleagues in 1994 demonstrated that anticonvulsant medications such as valproic acid are efficacious in acute and maintenance treatment of bipolar disorder. This is possibly due to the effects on temporal lobe kindling and also its effects in acting on so-called inhibitory neurotransmitter systems that reduce neural activity. This research indicates that valproic acid seems to be the treatment of choice for dysphoric mania or mixed states as well as those patients with rapid-cycling types of bipolar disorder. Valproic acid also has the potential benefit of rapid oral loading in acute mania, which is usually well tolerated and associated with a rapid onset of response, according to Post in 2000.

Carbamazepine. Carbamazepine appears to have similar benefits as valproic acid, as described by Denikoff and colleagues in 1997; however, its side effect profile and potential for drug interactions tend to lessen its use.

Lamotrigine. Lamotrigine is a newly approved anticonvulsant for add-on therapy that has antidepressant and possibly mood-stabilizing properties, according to Calabrese and colleagues in 1999. Its place in the management of bipolar disorder is still being investigated; however, a significant risk of severe rash may limit its use.

Gabapentin. Gabapentin is a newly approved anticonvulsant for adjunctive therapy that may also have some mood-stabilizing effects in bipolar patients. The drug appears to have positive effects on sleep and anxiety.

Topiramate. Topiramate is a recently approved add-on agent for treatment of refractory epilepsy. Preliminary experience suggests that it may have mood-stabilizing properties in rapid-cycling patients, with better antimanic than antidepressant effects, according to Post in 2000.

b. AntiPsychotic Agents The use of major tranquilizers has historically been confined to the acute treat-

ment of mania, particularly if there are psychotic features present. In recent years, a new class of major tranquilizers that lack the troublesome side effects of older antipsychotic agents has helped to improve the acute management of mania. These agents include risperidone and olanzapine (both serotonin-dopamine antagonists), which are frequently coadministered with mood stabilizers to control acute mania. In some cases, these agents need to be used for maintenance treatment as well.

2. Psychological Management

Psychosocial factors may contribute 25 to 30% to the outcome variance of bipolar disorder and despite optimal pharmacotherapy, up to 50% of sufferers may encounter further episodes, according to Joyce in 1992. It is important to note, however, that all of the studies of psychological interventions in the treatment of bipolar disorder have been used during the recovery phase of treatment, and have been used only to prevent relapse—there is no evidence that any psychological intervention is of benefit in the acute treatment of mania.

a. Family Therapies Several studies support the efficacy of brief family-focused interventions in both inpatient and outpatient settings, with an emphasis on education, problem solving, and reduction of ambient stress within the family, as discussed by Miklowitz and colleagues in 1996.

b. Group Psychotherapies Several studies suggest the benefits of group therapies, although no actual controlled studies exist. There is limited evidence of benefits in the areas of compliance with medication, problem solving, and interpersonal functioning, according to Scott in 1995.

c. Cognitive Behavior Therapy Cognitive behavior therapy for bipolar disorder has focused on improving compliance and in recognition of early symptoms of relapse. The results of some trials suggest that this reduces relapse rates, and there are some observations of improvement in social functioning and employment stability, as discussed by Robertson in 2000.

See Also the Following Articles

Cognitive Behavior Therapy ■ Pain Disorders ■ Psychopharmacology: Combined Treatment

Further Reading

- Akiskal, H. S. (1995). Toward a temperament-based approach to depression: Implications for neurobiologic research. *Advances in Biochemical Psychopharmacology*, 49, 99–112.
- American Psychiatric Association. (1994). *Diagnostic and statistical manual of mental disorders, 4th Edition*. Washington, DC: American Psychiatric Press.
- Bowden, C. L., Brugger, A. M., Swann, A. C., Calabrese, J. R., Janicak, P. G., Petty, F., et al. (1994). Efficacy of divalproex vs lithium and placebo in the treatment of mania. *Journal of the American Medical Association*, 271, 918–924.
- Calabrese, J. R., Bowden, C. L., Sachs, G. S., Ascher, J. A., Monaghan, E., & Rudd, G. D. (1999). A double-blind placebo-controlled study of lamotrigine monotherapy in outpatients with bipolar I depression. Lamictal 602 Study Group. *Journal of Clinical Psychiatry*, 60, 79–88.
- Cytryn, L., & McKnew, D. (1996). *Growing up sad: Childhood depression and its treatment*. New York: Norton.
- Denicoff, K. D., Smith-Jackson, E. E., Disney, E. R., Ali, S. O., Leverich, G. S., & Post, R. M. (1997). Comparative prophylactic efficacy of lithium, carbamazepine, and the combination in the treatment of bipolar disorder. *Journal of Clinical Psychiatry*, 58, 470–478.
- Gabbard, G. O. (1994). *Psychodynamic psychiatry in clinical practice: The DSM-IV edition*. Washington, DC: American Psychiatric Press.
- Kessler, R. C. (1997). The effects of stressful life events on depression. In *Annual review of psychology*. Palo Alto, CA: Annual Reviews.
- Kessler, R. C., Davis, C. G., & Kendler, K. S. (1997). Childhood adversity and adult psychiatric disorder in the U.S. National Comorbidity Survey. *Psychological Medicine*, 27, 1101–1119.
- Lam, R. W. (1994). Morning light therapy for winter depression: Predictors of response. *Acta Psychiatrica Scandinavica*, 89, 97–101.
- Miklowitz, D. J., Frank, E., & George, E. L. (1996). New psychosocial treatments for outpatient management of bipolar disorder. *Psychopharmacology Bulletin*, 32, 613–621.
- Nemeroff, C. B. (1998). The neurobiology of depression. *Scientific American*, 278, 42–49.
- Post, R. M., Ketter, T. A., Denicoff, K., Pazzaglia, P. J., Leverich, G. S., Marangell, L. B., et al. (1996). The place of anticonvulsant therapy in bipolar illness. *Psychopharmacology*, 128, 115–129.
- Post, R. M., Leverich, G. S., Denicoff, K. D., Frye, M. A., Kimbrell, T. A., & Dunn, T. M. S. (1997). Alternative approaches to refractory depression in bipolar illness. *Depression and Anxiety*, 5, 175–189.
- Post, R. M., & Weiss, S. R. B. (1997). Kindling and stress sensitization. In R. T. Joffe & L. T. Young (Eds.), *Bipolar disorder: Biological models and their clinical application*. New York: Marcel Dekker.
- Robertson, M. D. (1999). Interpersonal psychotherapy for patients recovering from bipolar disorder. *Australasian Psychiatry*, 71, 329–331.
- Shea, M. T., Pilkonis, P. A., Beckham, E., Collins, J. F., Elkin, I., Sotsky, S. M., Docherty, J. P. (1990). Personality disorders and treatment outcome in the NIMH Treatment of Depression Collaborative Research Program. *Am J Psychiatry*, 147, 711–718.
- Suomi S. J. (1991). Early stress and adult emotional reactivity in rhesus monkeys. In *Childhood Environment and Adult Disease: Symposium No. 156*, Ciba Foundation Symposium Staff, editors. Wiley, Chichester, England.
- Swann, A. C., Bowden, C. L., Morris, D., Calabrese, J. R., Petty, F., Small, J., et al. (1997). Depression during mania: Treatment response to lithium or divalproex. *Archives of General Psychiatry*, 54, 37–42.

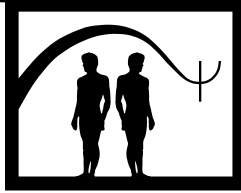

Multicultural Therapy

David Sue

Western Washington University

- I. Theoretical Basis
 - II. Description of Treatment
 - III. Empirical Studies
 - IV. Summary
- Further Reading

I. THEORETICAL BASIS

Multicultural therapy (MCT) developed out of the recognition that current forms of psychotherapy were inadequate to meet the needs of ethnic minorities. In fact, some have suggested that ethnic minority clients have been harmed by psychotherapy as currently formulated and practiced. Barriers to effective cross-cultural counseling included the generic aspects of Eurocentric counseling: verbal and emotional expressiveness, individual centered, self-disclosure and intimacy, nuclear family orientation, and egalitarian relationships. These elements of counseling and therapy are often in opposition to the beliefs or values of ethnic minorities. Many ethnic groups value the family rather than the individual, have hierarchical family patterns, demonstrate different communication patterns and styles, and are more hesitant about revealing information of a personal nature. In addition, there has been little attention paid by humanistic, psychodynamic, and cognitive-behavior therapies to issues of racism, oppression, and acculturation conflicts. Because of the inadequacies of current counseling theories and techniques, there was a need to develop a multicultural therapy.

MCT has developed into two somewhat divergent camps, although both have stressed the importance of considering culture in counseling. Total immersion into the cultural group under study is a part of the emic approach (culture-specific model). It attempts to generate new theories of psychopathology and therapy from the study of different cultural groups. Current systems of

GLOSSARY

- acculturation conflict** Conflict between traditional ethnic values and the adoption of values of the host culture.
- barriers to cross-cultural psychotherapy** Values, expectations, and behavioral differences between the therapist and client that impede the therapeutic process.
- cultural encapsulation** Ethnocentric perspective that does not acknowledge cultural differences.
- culture-specific (emic) therapy** Therapies developed from the study of the helping processes found in specific cultural groups.
- co-construction** A process in which therapists work with and learn from clients in jointly developing appropriate intervention strategies.
- ethnic identity models** Models that indicate the “stages” that members of ethnic groups go through in attaining identity.
- generic characteristics of counseling** Traditional Euro-centered therapy that is based on the importance of openness of expression, individualism, action orientation, and a clear distinction between physical and emotional realms.
- universal (etic) multicultural therapy** Therapies based on hypothesized factors that transcend cultural differences and involve shared human experiences but holding that culture is universal.
- worldview** Frame of reference based on a particular set of values and beliefs.

the classification and treatment of mental disorders are considered to be “culturally encapsulated.” As Uchenna Nwachuku and Allen Ivey in 1991 pointed out, “In contrast with the conventional approach of adapting existing counseling theory to ‘fit’ a new culture, the culture-specific method seeks to generate a new theory and technologies of helping.” Only by adopting such a methodology can one prevent the imposition of an existing framework on other ethnic groups. New theories originating from the culture under study can be developed using anthropological methods and observations. Natural helping styles and means of problem solving for each cultural group are then identified. A culture-specific psychotherapy training model involving the African-Igbo, a tribe in Nigeria, was described by Nwachuku and Ivey. The steps involved:

1. Generating a culture-specific theory. Questions such as, “How do people in this culture view the helping relationship?” “What methods are used in solving problems?” “How similar or different are they from EuroAmerican approaches” were used to determine problem-solving approaches from the African-Igbo perspective. Study of the culture revealed a group, extended family, and community orientation. Childrearing was shared by the family and the entire community. The locus of decision making centered in the extended family and community, and problem solving involved participation by these units.

2. Generating training material based on the analysis of the culture. It was determined that effective helping approaches involved a multiperspective rather than individual frame of reference. The family and community values in decision making were stressed as well the need for harmony for cultural tradition. A more directive style was more in line with cultural expectations.

The emic or culture-specific orientation avoids the “imposed etic” or the presumed universality of theories developed in one culture and applied to another. Many EuroAmerican therapists apply psychodynamic, humanistic, or cognitive-behavioral techniques to members of different ethnic groups without questioning the validity of this practice. Donald Cheek was one of the first to point out the ethnocentric basis of traditional counseling approaches. He stated,

I am advocating treating one segment of our population quite differently from another. This is implicit in my statement that Blacks do not benefit from many therapeutic approaches to which Whites respond. And

I have referred to some of these approaches of counselors and therapists as “White techniques.”

Many of the recommendations regarding therapy with ethnic minorities contain aspects of the culture-specific approach. With American Indians, there has been suggestions to incorporate cultural healing elements such as the talking circle, sweat lodge, and community interventions such as network therapy. African American therapists often indicate the importance of the Afrocentric worldview. This perspective has its roots in both the African heritage and experiences from slavery. As opposed to the Eurocentric view, there is greater emphasis on interdependence, extended family orientation, spirituality, and holism. Treatment modalities are expected to include Afrocentric elements.

In 1993, Paul Pedersen and Allen Ivey developed a description of four synthetic cultures that are actually based on the extreme grouping of the values of different cultural groups found in the world: (a) The Alpha culture is described as high in power distance. Inequalities as accepted and expected. Children are taught to obey and authority is respected; (b) The Beta culture is characterized as strong uncertainty avoidance. To deal with uncertainty, rigid rules have developed, and deviant or different ideas are suppressed. Citizen protest is repressed and conservatism and emphasis on the law is popular; (c) The Gamma culture is associated with high individualism. Emphasis is on the individual or the nuclear family. People have the right to express their own opinion and freedom of the press is supported. Education is the process of learning how to learn and evaluate; (d) The Delta culture is highly masculine. Money and possessions are dominant values. Men are expected to be assertive and tough while women should be nurturing and tender. Performance, strength and accomplishments are admired. Culture-centered therapy skills involve identifying culturally learned values and expectations and developing techniques and goals that are consistent with the specific groups.

In general, the culture-specific models have identified the differences in values, orientation, and philosophy that need to be addressed in counseling and the new therapy skills that need to be learned in working with culturally different populations. However, not all multicultural clinicians share the culture-specific perspective in multicultural therapy. Suzette Speight, Linda Myers, Chikako Cox, and Pamela Highlen argued in 1991 that the culture-specific approach makes multicultural psychotherapy an “extra skill area” that is somehow different from “regular counseling.” They

contend that culture-specific methodology could have negative consequences, particularly if a “cookbook” method of therapy is employed with a checklist of the values of each cultural group and directions on how counseling should proceed. Such an approach would overemphasize cultural differences, ignore individual variations, and lead to possible stereotyping ethnically different clients.

The second trend in multicultural therapy involves an etic or modified universal perspective. Under this framework, all counseling is considered to involve cultural factors (defined broadly to include differences between the therapist and client in terms of diversity issues such as age, gender, social class, religious background, and ethnicity). A proponent of the universal perspective to multicultural therapy is Mary Fukuyama who argued that cultural factors are present in all psychotherapy and must be addressed. In working with all clients it is important to consider the context and social environment when conceptualizing the presenting problem. Such a focus would enable the therapist to gain an understanding of the worldview of the client. The modified universal approach would also reduce the danger of stereotyping, encourage the assessment and consideration of cultural values and beliefs, and understand how societal norms and values can affect processes such as acculturation. Criticisms of the universal multicultural perspective include the continued reliance on therapy approaches based on individualistic and Eurocentric models with culturally different groups. Others are concerned that defining culture to include sexual orientation, age, religiosity, and other diversity issues will dilute the emphasis on the plight of ethnic minorities.

Although the culture-specific and universal forms of multicultural therapy have been espoused, neither has not been fully developed as a theory. Not until 1996 was a multicultural therapy theory presented in a complete form. In a book titled, *A Theory of Multicultural Counseling and Therapy* by Derald Sue, Allen Ivey, and Paul Pedersen, multicultural counseling and psychotherapy (MCT) is described as a “metatheory” of counseling or a “theory or theories.” MCT incorporates elements of both the universal and cultural-specific perspectives. As currently constructed, the theory of multicultural counseling and psychotherapy is composed of six propositions:

1. MCT is considered a metatheory of counseling and psychotherapy that includes a culture-centered organizational framework in which to view different theories of

counseling. All theories of psychotherapy are identified as stemming from a particular cultural context. Mental health professionals need to identify the values, assumptions, and philosophical bases in their work. Not recognizing these can result in the imposition of their worldview onto their clients. MCT accepts aspects of the psychodynamic, humanistic, behavioral, and biogenic approaches as they relate to the worldview of the client. MCT co-constructs definitions of the problem and solutions with the client that reduces the chances of oppression. The approach attempts to help individuals, families, and organizations develop new ways of thinking, feeling, and acting both within and between differing worldviews. Failure in therapy can result from an overemphasis on either cultural differences or similarities. Successful therapy involves utilizing a combined perspective.

2. Multiple levels of experiences (individual, group, and universal) and contexts (individual, family, and cultural) affect both the counselor and the client. Although the salience and strength of these identities vary from individual to individual and over time, they must be considered part of the focus of treatment. Elements of the similarities and differences between the therapist and client can either assist or obstruct development of a working alliance. It is important for the therapist to identify and strategize in dealing with these factors. The person–environment interaction is central to MCT. Both the therapist and client are affected on multiple levels through these identities, and this interaction can influence the conduct and success of therapy.

3. Cultural identity of both the client and the therapist can affect problem definition and the identification of appropriate goals and treatment. These dynamics are also influenced by the dominant–subordinate relationship among different cultural groups in the United States. Most theories of helping have ignored issues of dominance and power. The stage of ethnic identity for both White and ethnically different clients can affect the relationship. For many ethnic minorities, the cultural identity can go through stages such as unawareness or unacceptance of the self as a cultural being, recognizing the impact of cultural variables, redefining the self as a cultural being, and the development of a multicultural perspective. Therapists who are not members of ethnic minorities are also hypothesized to go through a parallel process.

4. When the processes of helping and goals are consonant with the experiences and cultural values of the client, the outcome is likely to be enhanced. This can be accomplished by matching the counselor and client on relevant variables or to have the counselor develop a

larger repertoire of multicultural skills. MCT recognizes the two aspects of culturally-sensitive therapy, that of the cultural specific and the universal. The cultural-specific approach can help generate new helping skills and theories whereas the universal can help identify therapy processes transcending culture. Co-construction with the client can facilitate these processes.

5. MCT stresses the importance of developing additional helper roles such as that of an advisor, consultant, advocate, systems interventionist, and prevention specialist. Traditional psychotherapy has emphasized one-to-one interactions. The new roles help focus attention on the family, community, and government policies that may also affect the mental health of a particular client.

6. Instead of self-actualization, insight, or behavior change, the basic goal of MCT is the "liberation of consciousness." It involves the expansion of consciousness as it applies to the individual, family, group, and context for behavior. The underlying cultural dimensions of specific problems are identified with the specific client. MCT therapists are able to draw on both Eurocentric and other cultural forms of helping. The psychoeducational component of MCT is emphasized in helping the client gain awareness of the cultural aspects related to the presenting problem.

II. DESCRIPTION OF TREATMENT

Cross-cultural psychotherapy is still in the evolving phase and has not developed a specific course of treatment. Instead it advocates incorporating a "culture-centered" perspective when employing the different therapeutic approaches and techniques. As mentioned earlier, there are two major models for MCT, the culture specific and the universal. Although the techniques for each are discussed separately, many are shared between the two approaches.

A. Culture-Specific Treatments

1. Assess and explore the indigenous cultural belief systems of the culturally different client. Study and understand culture-bound syndromes and the explanatory basis of disorders. For example, "sustos" is the folk belief among some Latinos and people from Mexico and other Latin American countries, that the soul has left the body because of a frightening event resulting in illness. Healing results in the return of the soul to the body. In "rootwork," a belief found in certain African- and EuroAmerican populations, generalized anxiety

and somatic problems are thought to be the result of witchcraft or sorcery. Cure is effected by utilizing a "root" healer who can remove the spell. *DSM-IV* lists a number of culture-bound syndromes that reveal the belief system underlying the cause and treatment for disorders found in different cultural groups.

2. Become knowledgeable about indigenous healing practices. As opposed to Western beliefs and practices, indigenous practices often involve the support of the disturbed individual through the use of communal and family networks, efforts to problem solve or develop treatment through a group context, reliance on spiritual healing, and the use of shamans or a respected elder from the community. Although we may not subscribe to these particular beliefs or practices, the psychotherapist can assist as a facilitator of indigenous support.

3. Consult with and seek the services of traditional healers within a specific culture. A liaison with indigenous healers can help deliver treatment more effectively. When the problem is clearly defined as primarily rooted in cultural traditions, referral to traditional healers becomes necessary. Advice regarding specific intervention strategies and how they can be reinterpreted to fit the specific culture can lead to more effective outcome.

4. Developing indigenous helping skills entails working in the community, making home visits, and expanding roles to include activism, prevention, outreach and social change. The culture-specific approach can be helpful to therapists in exposing them to multiple cultural perspectives, becoming aware of different philosophical and spiritual realities, and developing a more holistic outlook on treatment.

Techniques based on the universal perspective on psychotherapy are discussed in the context of the multicultural counseling and therapy theory. MCT provides a culture-centered element in traditional forms of intervention. Indeed, the different Eurocentric approaches to psychotherapy can be effectively employed when modified to be appropriate with multicultural populations. Following are some suggested steps in multicultural psychotherapy:

1. Role preparation and establishing rapport. To establish a working alliance, a therapist must be able to establish rapport with a client. The client must feel understood and respected. Some ethnic group members are responsive to emotional aspects of the interview process; for others "credibility" can be demonstrated through the identification of appropriate issues. For many ethnic minorities, therapy is a foreign process. To

enhance the working relationship, it is helpful to explain what happens in therapy, the roles of the both the client and the therapist, and confidentiality. Determining the expectations of the clients, their understanding of the treatment process, their degree of psychological mindedness and difficulties they might have with the therapy is an important aspect of role preparation. The concept of “co-construction”—that solutions will be developed only with the input and help of the client is introduced. Explain that problems are often complex and can be influenced by family, social, and cultural factors, and that you work together to determine if these are areas that need to be addressed.

2. Assessment—incorporating contextual and environmental factors. A culture-centered assessment would begin with an exploration of issues that may be faced by members of ethnic minorities such as immigration or refugee experiences, difficulties at work or in school, language and housing problem, possible issues with discrimination or prejudice, and acculturation conflicts (Recent immigrants or even individuals from first and second generations often show a pattern in which the children acculturate more quickly than the parents, and this difference often leads to conflict within the family). Social and community supports should also be identified. The assessment allows one to determine the possible impact of environmental, cultural, and social issues on the presenting problem. If the therapist determines the problem is external in nature, the therapist must help the client not to internalize the problem. Instead, the therapist might assist the client with developing strategies to cope with the external issues.

a. Ethnic or cultural identity. The cultural identity of both the therapist and client can affect both the problem definition and goals. Different identity development models have been developed for specific ethnic groups, but they all describe the process in which an individual moves from the host culture frame of reference to an acceptance of one's own cultural group. Determining the degree of ethnic identity of a particular client can help prevent stereotyping. Some clients will show little adherence to ethnicity and consider it unimportant whereas others may have a very strong ethnic identity that may influence how they perceive the presenting problem. Intervention strategies will depend on the stage of ethnic identity of the client. Those with a strong desire for assimilation into White society may reject attempts to explore ethnic variables. If the clinician determines that the presenting problem does not involve a rejection of the client's own ethnic identity, then mainstream psychotherapy

approaches can be useful. At another stage of ethnic identity, the individual may become angry over issues of racism and oppression and respond with suspicion to the therapist. They may feel that therapy attempts to have them adjust to a “sick” society. Ethnic identity issues have to be identified to determine if this should be a focus of therapy.

b. Although controversial, a number of ethnic researchers and clinicians posited models of White Racial Identity Development that apply to EuroAmerican therapists. Hypothesized stages are: (a) conformity or the obliviousness and lack of awareness of racism. Success in life is seen to be dependent on effort and not race. Ethnic minorities are evaluated according to EuroAmerican standards. The therapist professes to be “color blind” and does not question the relevance of applying therapy approaches to ethnic groups; (b) disintegration or the conflict produced by the beginning recognition of discrimination and prejudice against ethnic minorities. An individual at this stage may avoid contact with people of color; (c) Reintegration that involves resolving conflict by returning to beliefs of minority inferiority; (d) Pseudoindependence or the acknowledgement of societal biases and the recognition of White privilege. However, the individual may perpetuate racism by attempting to have minorities adjust to White standards; (e) immersion/emersion that is marked by a personal focus on one's own biases and to directly combat racism and oppression; and (f) autonomy in which the individual accepts one's whiteness and is comfortable acknowledging and accepting ethnic differences.

(1) Intake forms. Background information, history, description of the problem, mental status exam, and other means of gathering data should include a section determining whether the characteristics or behaviors are considered normative for the particular cultural group. If the clinician determines the problem may have cultural aspects, a determination has to be made if it applies to a particular individual. This would reduce the chances of stereotyping. When using *DSM-IV-TR*, it is especially important to do a thorough assessment of Axis IV (psychosocial and environmental problems) to eliminate the possibility that the presenting problems may actually be “other conditions that may be a focus of clinical attention” rather than a mental disorder. It is essential that the therapist remain aware of validity issues with different types of assessment and clinical judgments involving specific ethnic minorities. *DSM-IV-TR* warns that there may be a tendency to

overdiagnose schizophrenia in certain ethnic groups. Behaviors considered normative in a specific ethnic group may be seen as pathological from another group's perspective. Asian Americans tend to score low on assertiveness and high on social anxiety. Rather than being considered negative attributes, these may represent the Asian values of modesty and group orientation. African Americans may show a "healthy paranoia" or suspiciousness resulting from experiences associated with oppression and racism.

(2) Problem definition. Consider the clients' perspective on problems. How did they arise and how are they affecting functioning? Are specific cultural factors involved? In interviewing an individual make certain information about family, friends, and possible cultural/environmental factors is also obtained. When working with a family, these areas are also explored along with the possibility of acculturation conflicts between the parents and children.

(3) Goal definition. First, identify the different theoretical therapeutic techniques or processes used to attain goals. What assumptions underlie the techniques, and are they acceptable to members of other cultural groups? What kinds of modifications may have to be made or new techniques adopted? Second, the therapist should acquire knowledge of the experiences of ethnic minorities in the United States and issues involving oppression and discrimination. Many are still affected by their minority status and face conflicts over acculturation issues. There must be a willingness to acknowledge and address cultural and value differences with clients. Third, therapists should seek continuing education and consultation when working with ethnic minority populations and be willing to take on different roles such as advisor, advocate, and consultant.

B. Culture-Centered Interventions

Although psychoanalytic, humanistic, and behavioral models have differences in theory and techniques, they still share similarities in their "generic" approaches to psychotherapy and the conceptualization of the "healthy" client. There has been some movement in each of these approaches to make them more compatible for the different cultural groups. One such suggestion involves coconstruction. In *DSM-IV-TR*, it is noted that is important to identify possible "cultural explanations of the individual's illness." These explanations are how the particular individual views the problem and are part of the co-construction process.

In general, the research on therapy for ethnic minorities has revealed that they prefer techniques that are di-

rective, action oriented, and concrete. Some have suggested that cognitive-behavioral approaches show promise. However, as with all therapies, the cultural elements have to be identified. For example, what constitutes an "irrational belief" for particular cultural groups would have to be determined. Also, as with all Eurocentric psychotherapies, the focus has to change from the individual to include family, community, and societal factors. An individual's current mental complaints might stem from oppression and discrimination.

Currently, there are no specific guidelines in modifying traditional forms of psychotherapy to make them more appropriate for the problems of ethnic minorities. Regardless of psychotherapeutic orientation, the suggestions for multicultural assessment and co-construction can be helpful. All Eurocentric schools of psychotherapy face similar problems. They tend to have an individual focus and only work with the client rather than to attempt to address social and cultural concerns. Psychodynamic approaches could perhaps include exploration of a family or cultural unconscious to determine how these influenced individual development. Questions related to how these affected the identity of the individual could be explored. Humanistic therapists might use Abraham Maslow's hierarchy of needs to help identify the satisfaction of needs and the consideration of environmental concerns. Again, there could be a developed focus on cultural and family dimensions.

Empathy and other helping skills could not only be directed to the individual but to interpersonal relationships, the family, and the environment. The notion of co-construction fits well in the humanistic framework. With both the psychodynamic and the humanistic therapies, action and concrete suggestions need to be included as part of the therapy. Cognitive-behavior therapies are direct and action oriented and fit well into the expectations of many ethnic minority clients. However, they are also focused on the individual and need to be modified in use with other cultural groups. Cognitions considered to be "irrational" may not be perceived that way by ethnic minorities. The challenge is to understand what thoughts might be considered irrational by members of different cultural groups. In addition, the "unit" of treatment may not be the individual but the family, community, or even society. Group therapy with ethnic minorities also has to involve alterations. Techniques such as "ice breakers" are often used to facilitate interaction among the participants. Again, many of the activities reflect a cultural basis, and as therapists, we must analyze it as such. Some members of ethnic minorities may be uncomfortable participating because of the seeming lack of structure and ambiguity of these activities. Pairing individuals up with

other group members or providing structured tasks may generate more responsiveness. The focus of groups often is in personal development, and being a member of a family or particular ethnic groups is ignored. It may be valuable to focus on social identity and the increased understanding and responses to differences between groups.

Family therapy is also based on Eurocentric models and should not be imposed on families from different cultural groups. The family structure needs to be identified and relationships assessed. Therapy should be co-constructed with the help of family members. Systems theories should be expanded to include societal issues such as discrimination, poverty, and conflicting value systems. Reframe the concept of the "identified patient" as conflicts between different value systems. Again, the emphasis is to help the family develop better ways of handling problems within and between cultural constraints. It will be a challenge for individuals with training in Eurocentric therapies to develop more culture-centered treatment strategies.

III. EMPIRICAL STUDIES

There has been a number of studies examining some of the factors that affect cross-cultural therapy. However, most of these are not theoretically based, and few have addressed either the culture-specific or modified universal multicultural therapy models. For the culture-specific approach presented earlier by Uchenna Nwachuku and Allen Ivey on the African-Igbo culture, U.S. graduate students in a counseling program responded to problems presented by videotaped African-Igbo clients. The counselors displayed listening skills, allowed the client to determine direction, and focused clearly on the individual. The counselors were then trained in a workshop with information gained from the analysis of African-Igbo culture and were again rated on their performance with videotapes of African-Igbo clients. Improvement was noted in the use of more culturally aware responses but difficulty was still displayed in focusing on family and community values rather than the individual and the use of influencing skills such as giving advice. The study indicated that culture-specific information and training can improve sensitivity to different cultural styles, but that aspects of Eurocentric therapy remain difficult to alter.

There has been no direct research on either the modified universal model or the six propositions of multicultural counseling and psychotherapy. Indeed it can be argued that past research on culturally different populations is culture bound and difficult to interpret from

a culture-centered perspective. However, although the theories have not been directly examined, some of the research can apply to the propositions in multicultural counseling and psychotherapy. It must be noted that many of the cross-cultural studies involve college populations, and the findings may not be valid with ethnic clients living in the community. The following are hypotheses and research support in the area of multicultural counseling and psychotherapy that could be predicted from MCT. These are from the chapter "Research and Research Hypotheses in Intercultural Counseling" by David Sue and Norman Sundberg.

1. Conceptualization of mental disorders and psychotherapy will influence access. In general, Southeast Asians are less likely to enter psychotherapy because they associate mental illness with stigma and shame and are not acquainted with the notion of psychotherapy. Asian American groups tend to believe that mental illness is due to a lack of willpower and believe that they should deal with the problem themselves. Hispanic American families are more likely to utilize family, relatives, or community resources for emotional problems. Both groups underutilize mental health resources. African American and American Indians may show cultural mistrust of psychotherapy feeling that the therapy symbolizes oppression. African Americans tend to overutilize mental health services but also tend to terminate more quickly and show little positive gain. There is also some evidence that they use the therapy session to deal with external problems such as problems with agencies and the law rather than personal issues.

2. The degree of similarity in the expectation between client and therapist toward the process and goals of counseling affects effectiveness. In a number of research studies, ethnic minorities are more likely to be responsive to approaches that are more directive and action oriented and rate therapists using these approaches as more "credible." Pretherapy explanations of the process of therapy and the responsibilities of the client and therapist lead to greater satisfaction of services.

3. Ethnic similarity between client and therapist will enhance the probability of a positive therapeutic outcome. Reviews of ethnic matching have produced mixed results. Some support has been found in some studies and not in others. There is some support that African Americans prefer an ethnically similar therapist and that stage of racial identity development is related to this preference. Among Hispanic Americans, a slight preference for an ethnically similar therapist was found, especially among those low in acculturation. In one study of clients in the Los Angeles area, ethnic

matching was a significant predictor of outcome for Hispanic Americans and approached significance for Asian Americans, especially among recent immigrants. For all groups, including EuroAmericans, ethnic match was related to length of treatment except for African Americans. In many of the studies, other similarities between the therapist and client involving attitudes, values, or style was as, if not more, important than ethnic matching.

4. Among ethnic minorities, degree of acculturation or stage of ethnic identity affects receptivity to counseling. In general, low-accultured ethnic minority individuals appear to prefer an ethnically similar therapist. This has been found with Asian American, Hispanic American, and American Indian participants. For African American clients, there is some support for the view that those with a cultural distrust were more likely to terminate earlier with a White than a African American therapist. There is limited support for the view that the stage of ethnic identity is related to the types of problems presented and reaction to the counselor.

5. Exploring cultural and environmental variables can increase the "credibility" of the therapist. Cultural sensitivity as defined by the acknowledgment of culture, acculturation conflicts, and other issues faced by ethnic minorities demonstrated by therapists increased their ratings of credibility. The acknowledgement of ethnic differences between the client and therapist has also found to be related to positive outcome. Demonstrating a culturally sensitive approach by exploring cultural issues increased the therapeutic alliance, regardless of ethnic differences between the client and therapist. Cultural sensitivity displayed by the therapist has been found to be related to greater client self-disclosure and satisfaction.

6. The stage of identity for a EuroAmerican therapists can affect their reaction to ethnic minority clients. The concept of "White identity" is controversial in that EuroAmericans also go through a stage of racial identity. Certainly it would seem that if therapists denied the possibility of prejudice and discrimination faced by ethnic minority group members, they would not be able to understand the worldview of many culturally different clients and not be able to provide appropriate interventions. There has been limited support for the impact of the specific stage of White identity development and self-reported multicultural competencies.

7. Ethnic minorities prefer directive, concrete, and action-oriented psychotherapy techniques. Most of the studies indicate that ethnic minorities show a preference for a directive when compared to a client-centered approach. This appears to be more true for recent im-

migrants or those with low acculturation. Ethnic minority females show somewhat greater acceptance of a client-centered approach than males. However, what ethnic clients may want is more structure and guidance in therapy and advice or suggestions for different courses of action.

Thus, it would seem that some of the predictions made by multicultural therapy has received some support. However, what is needed are more explicit testable hypotheses to measure outcome in a varied of ways (symptom reduction, termination, and satisfaction) and to involve the use of actual patient populations.

IV. SUMMARY

Consideration of cultural factors in psychotherapy is being addressed by the different mental health organizations. It is receiving greater recognition in *DSM-IV-TR* where it is discussed both in the Appendix and as a subheading under the different disorders. The mental health field has responded primarily by drawing attention to possible cultural factors but not questioning the universality of psychotherapies developed according to Eurocentric models. Multicultural therapy approaches attempt to have practitioners understand the culture-specific nature of Western therapies and to identify assumptions and values under their system of psychotherapy. All therapies develop under some type of cultural framework. To deal with the inadequacies of current counseling theories and techniques in working with different ethnic groups, there is an increased attention to the impact of cultural factors.

Multicultural therapy has developed into somewhat different theoretical models. The culture-specific model or emic approach attempts to determine how a cultural group defines problem behaviors and problem-solving techniques. Anthropological observations and interviews are used to gather information. The concept of "healer" within the culture is identified to understand the philosophical nature of "therapy." From this, new theories of psychopathology and psychotherapy may develop. Criticism of the culture-specific model includes the possibility of overemphasizing culture, ignoring individual differences, and the necessity of developing a different approach for the cultural groups.

The modified version of multicultural therapy attempts to identify universals and considers all therapy to have cultural components that need to be identified. Some criticize the universal approach as just adding

culture to Eurocentric psychotherapies. A multicultural therapy that lies in between the culture-specific and universal perspectives was recently developed. It emphasizes the cultural aspects of all forms of counseling, emphasizing that practitioners need to identify the value system underlying their therapeutic approaches, and the importance of considering behaviors in context and multiple levels of experience (individual, group, universal). This theory is considered to be a theory of theories and has formulated a number of testable propositions and corollaries.

Intervention strategies based on culture-specific models are developed specifically for the population under study. With the African-Igbo, U.S. counseling students learned the methods of therapy derived through interviews with indigenous "experts" and observation and workshop material. The universal and multicultural therapy models develop intervention based on a culture-centered approach. Cultural factors are identified and assessments modified. The culture-specific nature of psychodynamic, humanistic, and cognitive-behavioral theories are identified and modified to incorporate family, groups, and environmental considerations. To reduce stereotyping, the ethnic identity of the client is assessed along with the identity of the therapist. Co-construction or the understanding of the problem, solutions, and appropriate interventions are made with the help of the client. Individual, family, and group therapies need to go through the process of identifying the assumptions underlying the models and altering the techniques to fit the worldview and expectation of ethnic minorities.

Research on cultural factors in psychotherapy has been relatively limited and without a theoretical basis. Most studies involve college populations and deal with specific aspects of cross-cultural counseling such as the rating of credibility, preference, and expertise. Although the findings are mixed, there is some support for ethnic matching of the therapist and client, espe-

cially for African Americans and less acculturated Hispanic and Asian Americans. It also appears that ethnic minorities feel more comfortable with action-oriented and concrete approaches of helping. Therapists are also rated higher when they demonstrate cultural sensitivity when dealing with an ethnic minority client. These findings are only tentative and need to include more actual clients and therapists.

See Also the Following Articles

Bioethics ■ Cultural Issues ■ Race and Human Diversity
■ Transcultural Psychotherapy

Further Reading

- American Psychological Association. (1993). Guidelines for providers of psychological services to ethnic, linguistic, and culturally diverse populations. *American Psychologist*, 48, 45–48.
- Cheek, D. (1976). *Assertive Black ... puzzled White*. San Luis Obispo, CA: Impact.
- Fukuyama, M. (1990). Taking a universal approach to multicultural counseling. *Counselor Education and Supervision*, 30, 6–17.
- Pedersen, P. (1988). *A handbook for developing multicultural awareness*. VA: Alexandria, VA: American Association for Counseling and Development.
- Pedersen, P. B., & Ivey, A. (1993). *Culture-centered counseling and interviewing skills: A practical guide*. Westport, CT: Praeger.
- Ponterotto, J. G., Casas, J. M., Suzuki, L. A., & Alexander, C. M. (1995). *Handbook of multicultural counseling*. Thousand Oaks, CA: Sage.
- Speight, S. L., Myers, L. J., Cox, C. I., & Highlen, P. S. (1991). A redefinition of multicultural counseling. *Journal of Counseling and Development*, 70, 29–36.
- Sue, D. W., Ivey, A. E., & Pedersen, P. B. (1996). *A theory of multicultural counseling and therapy*. Pacific Grove, CA: Brooks/Cole.
- Sue, D. W., & Sue, D. (1999). *Counseling the culturally different (3d ed.)*. New York: John Wiley & Sons.

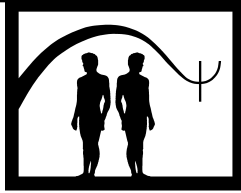

Multimodal Behavior Therapy

Arnold A. Lazarus

Rutgers University and Center for Multimodal Psychological Services

- I. Description of Treatment
 - II. Theoretical Bases
 - III. Applications and Exclusions
 - IV. Empirical Studies
 - V. Case Illustration
 - VI. Summary
- Further Reading

GLOSSARY

- BASIC I.D.** An acronym of Behavior, Affect, Sensation, Imagery, Cognition, Interpersonal relationships, and Drugs/Biological processes.
- bridging** A procedure in which the therapist deliberately tunes into issues that the client wants to discuss, then gently guides the discussion into more productive areas.
- second-order BASIC I.D.** Focusing on a specific problem in the BASIC I.D. to flesh out more information; useful for breaking impasses in therapy.
- social learning theory** A system that combines classical and operant conditioning with cognitive mediational factors (e.g., observational learning and symbolic activity) to explain the development, maintenance, and modification of behavior.
- structural profile inventory** A 35-item questionnaire that assesses the extent to which one is apt to be active or inactive; emotional or impassive; aware of or indifferent to sensory stimuli; reliant on mental imagery; inclined to think, plan, and cogitate; gravitate toward people and social events or avoid them; and engage in healthful habits and activities.
- technical eclectic** The use of techniques drawn from diverse sources without also adhering to the disciplines or theories that spawned them.

tracking the firing order A careful scrutiny of the firing order of the BASIC I.D. modalities to facilitate more effective sequencing of treatment procedures.

I. DESCRIPTION OF TREATMENT

Multimodal behavior therapy (also called Multimodal therapy) rests on the observation that at base, we are biological organisms (neurophysiological/biochemical entities) who *behave* (act and react), *emote* (experience affective responses), *sense* (respond to tactile, olfactory, gustatory, visual, and auditory stimuli), *imagine* (conjure up sights, sounds, and other events in our mind's eye), *think* (entertain beliefs, opinions, values, and attitudes), and *interact* with one another (enjoy, tolerate, or suffer various interpersonal relationships). By referring to these seven discrete but interactive dimensions or modalities as Behavior, Affect, Sensation, Imagery, Cognition, Interpersonal, Drugs/Biologicals, the convenient acronym BASIC I.D. emerges from the first letter of each one.

Many psychotherapeutic approaches are trimodal, addressing affect, behavior, and cognition—ABC. The outcomes of several follow-up inquiries pointed to the importance of *breadth* if treatment gains were to be maintained. The multimodal approach provides clinicians with a comprehensive template. By separating sensations from emotions, distinguishing between images and cognitions, emphasizing both intraindividual and interpersonal behaviors, and underscoring the bio-

logical substrate, the multimodal orientation is most far-reaching. By assessing a client's BASIC I.D. one endeavors to "leave no stone unturned."

The elements of a thorough assessment involve the following range of questions:

B: What is this individual doing that is getting in the way of his or her happiness or personal fulfillment (self-defeating actions, maladaptive behaviors)? What does the client need to increase and decrease? What should he or she stop doing and start doing?

A: What emotions (affective reactions) are predominant? Are we dealing with anger, anxiety, depression, or combinations thereof, and to what extent (e.g., irritation versus rage; sadness versus profound melancholy)? What appears to generate these negative affects—certain cognitions, images, interpersonal conflicts? And how does the person respond (behave) when feeling a certain way? It is important to look for interactive processes—what impact do various behaviors have on the person's affect and vice versa? How does this influence each of the other modalities?

S: Are there specific sensory complaints (e.g., tension, chronic pain, tremors)? What feelings, thoughts, and behaviors are connected to these negative sensations? What positive sensations (e.g., visual, auditory, tactile, olfactory, and gustatory delights) does the person report? This includes the individual as a sensual and sexual being. When called for, the enhancement or cultivation of erotic pleasure is a viable therapeutic goal.

I: What fantasies and images are predominant? What is the person's "self-image?" Are there specific success or failure images? Are there negative or intrusive images (e.g., flashbacks to unhappy or traumatic experiences)? And how are these images connected to ongoing cognitions, behaviors, affective reactions, and so forth?

C: Can we determine the individual's main attitudes, values, beliefs, and opinions? What are this person's predominant shoulds, oughts, and musts? Are there any definite dysfunctional beliefs or irrational ideas? Can we detect any untoward automatic thoughts that undermine his or her functioning?

I: Interpersonally, who are the significant others in this individual's life? What does he or she want, desire, expect, and receive from them, and what does he or she, in turn, give to and do for them? What relationships give him or her particular pleasures and pains?

D: Is this person biologically healthy and health conscious? Does he or she have any medical complaints or concerns? What relevant details pertain to diet, weight, sleep, exercise, and alcohol and drug use?

The foregoing dimensions or modalities are some of the main issues that multimodal clinicians traverse while assessing the client's BASIC I.D. A more comprehensive problem identification sequence is derived from asking most clients to complete the Multimodal Life History Inventory. This 15-page questionnaire facilitates treatment when conscientiously filled in by clients as a homework assignment, usually after the initial session. Seriously disturbed (e.g., deluded, deeply depressed, highly agitated) clients will not be expected to comply, but most psychiatric outpatients who are reasonably literate will find the exercise useful for speeding up routine history taking and readily provide the therapist with a BASIC I.D. analysis.

A. Placing the BASIC I.D. in Perspective

The treatment process in multimodal behavior therapy rests on the BASIC I.D., which serves as a template to remind us to examine each of the seven modalities and their interactive effects. It implies that we are social beings that move, feel, sense, imagine, and think, and that at base we are biochemical–neurophysiological entities. Students and colleagues frequently inquire whether any particular areas are more significant, more heavily weighted, than the others are. For thoroughness, all seven require careful attention, but perhaps the biological and interpersonal modalities are especially significant.

The biological modality wields a profound influence on all the other modalities. Unpleasant sensory reactions can signal a host of medical illnesses; excessive emotional reactions (anxiety, depression, and rage) may all have biological determinants; faulty thinking, and images of gloom, doom, and terror may derive entirely from chemical imbalances; and untoward personal and interpersonal behaviors may stem from many somatic reactions ranging from toxins (e.g., drugs or alcohol) to intracranial lesions. Hence, when any doubts arise about the probable involvement of biological factors, it is imperative to have them fully investigated. A person who has no untoward medical/physical problems and enjoys warm, meaningful, and loving relationships, is apt to find life personally and interpersonally fulfilling. Hence the biological modality serves as the base and the interpersonal modality is perhaps the apex. The seven modalities are by no means static or linear but exist in a state of reciprocal transaction.

A patient requesting therapy may point to any of the seven modalities as his or her entry point. *Affect:* "I suffer

from anxiety and depression.” *Behavior*: “It’s my compulsive habits that are getting to me.” *Interpersonal*: “My wife and are not getting along.” *Sensory*: “I have these tension headaches and pains in my jaw.” *Imagery*: “I can’t get the picture of my grandmother’s funeral out of my mind, and I often have disturbing dreams.” *Cognitive*: “I know I set unrealistic goals for myself and expect too much from others, but I can’t seem to help it.” *Biological*: “I’m fine as long as I take lithium, but I need someone to monitor my blood levels.”

It is more usual, however, for people to enter therapy with explicit problems in two or more modalities—“I have all sorts of aches and pains that my doctor tells me are due to tension. I also worry too much, and I feel frustrated a lot of the time. And I’m very angry with my father.” Initially, it is usually advisable to engage the patient by focusing on the issues, modalities, or areas of concern that he or she presents. To deflect the emphasis too soon onto other matters that may seem more important is only likely to make the patient feel discounted. Once rapport has been established, however, it is usually easy to shift to more significant problems.

Any good clinician will first address and investigate the presenting issues. “Please tell me more about the aches and pains you are experiencing.” “Do you feel tense in any specific areas of your body?” “You mentioned worries and feelings of frustration. Can you please elaborate on them for me?” “What are some of the specific clash points between you and your father?” The therapist will then flesh out the details. However, a multimodal therapist goes farther. She or he will carefully note the specific modalities across the BASIC I.D. that are being discussed, and which ones are omitted or glossed over. The latter (i.e., the areas that are overlooked or neglected) often yield important clinical information.

In this description of the overview of treatment processes, it is important to explain several procedures that are employed by multimodal behavior therapists.

1. Second-Order BASIC I.D. Assessments

The initial Modality Profile (BASIC I.D. Chart) translates vague, general, or diffuse problems (e.g., depression, and unhappiness, and anxiety) into specific, discrete, and interactive difficulties. Techniques—preferably those with empirical backing—are selected to counter the various problems. Nevertheless, treatment impasses arise, and when this occurs, a more detailed inquiry into associated behaviors, affective responses, sensory reactions, images, cognitions, interpersonal factors, and possible biological considerations may shed light on the situation. This recursive applica-

tion of the BASIC I.D. to itself adds depth and detail to the macroscopic overview afforded by the initial Modality Profile. Thus, a second-order assessment with a client who was not responding to antidepressants and a combination of cognitive-behavioral procedures revealed a central cognitive schema—“I am not entitled to be happy”—that had eluded all other avenues of inquiry. Therapy was then aimed directly at addressing this maladaptive cognition.

2. Bridging

A strategy that is probably employed by most effective therapists can readily be taught to novices via the BASIC I.D. format. We refer to it as bridging. Suppose a therapist is interested in a client’s emotional responses to an event. “How did you feel when your father yelled at you in front of your friends?” Instead of discussing his feelings, the client responds with defensive and irrelevant intellectualizations. “My dad had strange priorities and even as a kid I used to question his judgment.” Additional probes into his feelings only yield similar abstractions. It is often counterproductive to confront the client and point out that he is evading the question and seems reluctant to face his true feelings. In situations of this kind, bridging is usually effective. First, the therapist deliberately tunes into the client’s preferred modality—in this case, the cognitive domain. Thus, the therapist explores the cognitive content. “So you see it as a consequence involving judgments and priorities. Please tell me more.” In this way, after perhaps a 5 to 10 minute discourse, the therapist endeavors to branch off into other directions that seem more productive. “Tell me, while we have been discussing these matters, have you noticed any sensations anywhere in your body?” This sudden switch from cognition to sensation may begin to elicit more pertinent information (given the assumption that in this instance, sensory inputs are probably less threatening than affective material). The client may refer to some sensations of tension or bodily discomfort at which point the therapist may ask him to focus on them, often with a hypnotic overlay. “Will you please close your eyes, and now feel that neck tension. (Pause). Now relax deeply for a few moments, breathe easily and gently, in and out, in and out, just letting yourself feel calm and peaceful.” The feelings of tension, and their associated images and cognitions may then be examined. One may then venture to bridge into affect. “Beneath the sensations, can you find any strong feelings or emotions? Perhaps they are lurking in the background.” At this juncture it is not unusual for clients to give voice

to their feelings. “I am in touch with anger and with sadness.” By starting where the client is and then bridging into a different modality, most clients then seem willing to traverse the more emotionally charged areas they had been avoiding.

3. Tracking the Firing Order

A fairly reliable pattern may be discerned of the way that many people generate negative affect. Some dwell first on unpleasant sensations (palpitations, shortness of breath, tremors), followed by aversive images (pictures of disastrous events), to which they attach negative cognitions (ideas about catastrophic illness), leading to maladaptive behavior (withdrawal and avoidance). This S-I-C-B firing order (sensation, imagery, cognition, behavior) may require a different treatment strategy from that employed with a C-I-S-B sequence, a I-C-B-S, or yet a different firing order. Clinical findings suggest that it is often best to apply treatment techniques in accordance with a client’s specific chain reaction. A rapid way of determining someone’s firing order is to have him or her in an altered state of consciousness—deeply relaxed with eyes closed—contemplating untoward events and then describing his or her reactions.

One of my clients was perplexed at the fact that she frequently felt extremely anxious “out of the blue.” Here is part of an actual clinical dialogue:

Therapist: Now please think back to those feelings of anxiety that took you by surprise. Take your time, and tell me what you remember.

Client: We had just finished having dinner and I was clearing the table. (Pause) I remember now. I had some indigestion.

Therapist: Can you describe the sensations?

Client: Sort of like heartburn and a kind of a cramp over here (points to upper abdomen).

Therapist: Can you focus on the memory of those sensations?

Client: Yes. I remember them well. (Pause) Then I started remembering things.

Therapist: Such as?

Client: Such as the time I had dinner at Tom’s and had such a migraine that I threw up.

Therapist: Let me see if I am following you. You started having some digestive discomfort and then you had an image, a picture of the time you were at Tom’s and got sick.

Client: Yeah. That’s when I stopped what I was doing and went to lie down.

This brief excerpt reveals a sensation-imagery-behavioral sequence. In the actual case, a most significant

treatment goal was to show the client that she attached extremely negative attributions to negative sensations, which then served as a trigger for anxiety-generating images. Consequently, she was asked to draw up a list of unpleasant sensations, to dwell on them one by one, and to prevent the eruption of catastrophic images with a mantra—“this too shall pass.”

II. THEORETICAL BASES

Multimodal behavior therapy is behavioral in that is based on the principles and procedures of experimental psychology, especially social learning theory. According to this theory, all behaviors—normal and abnormal—are maintained and modified by environmental events. The initial behavioral theories rested on animal analogues and were decidedly mechanistic. They put forth rather simplistic analyses of stimulus-response contingencies. The advent of what is now termed cognitive-behavior therapy rests on a much more sophisticated foundation. Emphasis is now placed on the finding that cognitive processes, which in turn are affected by the social and environmental consequences of behavior, determine the influence of external events. The main focus is on the constant reciprocity between personal actions and environmental consequences.

Social learning theory recognizes that association plays a key role in all learning processes. Events that occur simultaneously or in quick succession are likely to be connected. An association may be said to exist when responses evoked by one set of stimuli are similar to those elicited by other stimuli. The basic social learning triad is made up of classical (respondent) conditioning, operant (instrumental) conditioning, and modeling and vicarious processes. Added to the foregoing is the personalistic use of language, expectancies, selective attention, goals, and performance standards, as well as the impact of numerous values, attitudes, and beliefs. A person’s thoughts will determine which stimuli are noticed, how much they are valued, and how long they are remembered. In the brief space allocated, it is not possible to do justice to the nuances of social learning theory, but I hope that its level of sophistication and experimentally based outlook can be appreciated.

A pivotal concept in multimodal behavior therapy is that of technical eclecticism. As more therapists have become aware that no one school can possibly provide all the answers, a willingness to incorporate different methods into their own purview and to combine different

procedures has become fairly prominent. There are several different ways in which methods may be combined. The first is to utilize several techniques within a given approach (e.g., exposure, response prevention, and participant modeling from a behavioral perspective). One may also combine techniques from different disciplines, especially when confronted by a seemingly intractable patient or problem. Yet another way of combining treatments is to use medication in conjunction with psychosocial therapies. In addition, one may treat certain clients with a combination of individual, family, and group therapy, or look to other disciplines (e.g., social work in the case of vocational rehabilitation).

There are three principal routes to rapprochement or integration: technical eclecticism, theoretical integration, and common factors. Those who attempt to meld different or even disparate theories (theoretical integrationists), differ significantly from those who remain theoretically consistent but use diverse techniques (technical eclectics). And those who dwell on the common ingredients shared by different therapies (e.g., self-efficacy, enhanced morale, or corrective emotional experiences), are apt to ignore crucial differences while emphasizing essential similarities. Unfortunately, there are still many school adherents who refuse to look beyond the boundaries of their own theories for ideas and methods that may enhance their clinical acumen.

In essence, there appear to be no data to support the notion that a blend of different theories has resulted in a more robust therapeutic technique or has led to synergistic practice effects. It cannot be overstated that the effectiveness of specific techniques may have no bearing on the theories that spawned them. Techniques may, in fact, prove effective for reasons that do not remotely relate to the theoretical ideas that gave birth to them. This is not meant to imply that techniques operate or function in a vacuum. The therapeutic relationship is the soil that enables techniques to take root. Theories are needed to explain or account for various phenomena and to try to make objective sense out of bewildering observations and assertions. And it is precisely because social learning and cognitive theories are experimentally grounded that multimodal behavior therapy embraces them rather than any of the other theories in the marketplace. It makes sense to select seemingly effective techniques from any discipline without necessarily subscribing to the theories that begot them.

In multimodal behavior therapy, the selection and development of specific techniques are not at all capricious. The basic position can be summarized as fol-

lows: Eclecticism is warranted only when well-documented treatments of choice do not exist for a particular disorder, or when well-established methods are not achieving the desired results. Nevertheless, when these procedures, despite proper implementation, fail to prove helpful, one may resort to less authenticated procedures or endeavor to develop new strategies. Clinical effectiveness is probably in direct proportion to the range of effective tactics, strategies, and methods that a practitioner has at his or her disposal. Nevertheless, the rag-tag importation of techniques from anywhere or everywhere without a sound rationale can only result in syncretistic confusion. A systematic, prescriptive, technically eclectic orientation is the opposite of a smorgasbord conception of eclecticism in which one selects procedures according to unstated and unreplicable processes. It needs to be emphasized again that arbitrary blends of different techniques are to be decried.

The cognitive-behavioral literature has documented various treatments of choice for a wide range of afflictions including maladaptive habits, fears and phobias, stress-related difficulties, sexual dysfunctions, depression, eating disorders, obsessive-compulsive disorders, and posttraumatic stress disorders. We can also include dementia, psychoactive substance abuse, somatization disorder, multiple personality disorder and various other personality disorders, psychophysiological disorders, pain management, and diverse forms of violence. There are relatively few empirically validated treatments outside the area of cognitive-behavior therapy.

III. APPLICATIONS AND EXCLUSIONS

Multimodal behavior therapy is not a unitary or closed system. It is basically a clinical approach that rests on a social and cognitive learning theory, and uses technically eclectic and empirically supported procedures in an individualistic manner. The overriding question is mainly "Who and what is best for this client?" Obviously no one therapist can be well versed in the entire gamut of methods and procedures that exist. Some clinicians are excellent with children whereas others have a talent for working with geriatric populations. Some practitioners have specialized in specific disorders (e.g., eating disorders, sexual dysfunctions, PTSD, panic, depression, substance abuse, or schizophrenia). Those who employ multimodal behavior therapy will bring their talents to bear on their areas of special proficiency and employ the BASIC I.D.

as per the foregoing discussions, and, by so doing, possibly enhance their clinical impact. If a problem or a specific client falls outside their sphere of expertise, they will endeavor to effect a referral to an appropriate resource. For example, if a client who speaks only Spanish is to be treated by multimodal behavior therapy, obviously a therapist who is fluent in Spanish will be chosen. Thus, there are no problems or populations per se that are excluded. The only exclusionary criteria are those that pertain to the limitations of individual therapists.

IV. EMPIRICAL STUDIES

A crucial question is whether or not there is evidence that a multimodal approach is superior to more narrow or targeted treatments. During the 1970s and 1980s issues pertaining to focused versus combined treatment modalities were addressed in several quarters. Interestingly, for some disorders, specialized or highly focused interventions appeared superior to broad-spectrum approaches. For example, in weight-loss programs a specialized stimulus-control procedure was often favored over multidimensional treatments. Similarly, several other problem areas may respond better to specialized procedures: some phobias, compulsive disorders, sexual problems, eating disorders, some cases of insomnia, tension headaches, and the management of oppositional children.

On the other hand, a strong argument for combined treatments can be made for the treatment of alcoholism. Studies have shown that those treated only by aversion therapy were more likely to relapse than their counterparts who had also received relaxation training. And more recently, several studies have indicated that a combination of imipramine and exposure is more effective in treating panic disorder with agoraphobia than either exposure treatment or drug treatment alone.

In a carefully controlled outcome study conducted by Tom Williams in Scotland, multimodal assessment and treatment were compared with less integrative approaches in helping children with learning disabilities. Clear data emerged in support of the multimodal procedures. In Holland, M.G.T. Kwee and his associates conducted a multimodal treatment outcome study on 84 hospitalized patients suffering from obsessive-compulsive disorders or phobias, 90% of whom had received prior treatment without success, and 70% of whom had suffered from their disorders for more than 4 years. Implementing multimodal treatment regimens

resulted in substantial recoveries and durable 9-month follow-ups.

The main criticism of multimodal behavior therapy is that it is so broad-based, so flexible, so personalistic and adaptable that tightly controlled outcome research is virtually impossible. Thus, it depends too much on the artistry of the individual therapist. This reproach is only partly true. Multimodal behavior therapy endeavors first and foremost to apply empirically validated methods whenever feasible. Beyond the cognitive-behavioral parameters, there is suggestive evidence, rather than hard data, to confirm the clinical impression that covering the BASIC I.D. enhances outcomes and follow-ups. Similarly, although there is considerable clinical evidence that the multimodal approach keeps treatment on target and often brings to light issues that remain hidden from therapists of other orientations, there are no hard data to confirm these impressions.

Aside from outcome measures, there is research bearing out certain multimodal tenets and procedures. For example, multimodal clinicians often use a 35-item Structural Profile Inventory (SPI) that provides a quantitative rating of the extent to which clients favor specific BASIC I.D. areas. Factor analytic studies gave rise to several versions of the SPI until one with good factorial stability was obtained. The instrument measures the extent to which people are action-oriented (behavior), their degree of emotionality (affect), the value they attach to various sensory experiences (sensation), how much time they occupy with fantasy and day dreaming and "thinking in pictures" (imagery), how analytical they tend to be (cognition), how important other people are to them (interpersonal) and the extent to which they are healthy and health-conscious (drugs/biology). The reliability and validity of this instrument has been borne out by research conducted by Steven Herman. One of the most important findings is that when clients and therapists have wide differences on the SPI, therapeutic outcomes tend to be adversely affected.

V. CASE ILLUSTRATION

A case illustration should amplify and clarify all of the foregoing elements and details.

Ken, a 46-year-old accountant employed by a large corporation, suffered from bouts of depression, had problems maintaining an intimate relationship (he was twice divorced), expressed concerns about his relation-

ship with his son and daughter from his first marriage, and was unhappy at work. Previously, he had been in couples therapy, had seen various individual counselors and clinicians from time to time, but felt that he had derived minimal benefits from counseling and psychotherapy.

During the initial interview it was soon apparent that Ken tended to denigrate himself and seemed to have unrealistically high expectations for himself. These issues were broached and Ken agreed to read selected chapters of two books I handed him, one by Albert Ellis and the other coauthored by my son and myself. At the end of the initial interview, as is customary with literate clients who are not excessively depressed or otherwise too disturbed or distracted to focus on filling out questionnaires, Ken was handed the Multimodal Life History Inventory (LHI). This is a 15-page survey that covers the BASIC I.D. He was requested to complete it in his own time, but not to attempt to finish it in one sitting, and asked to bring the completed inventory with him to the next meeting. A depression inventory had also been administered and revealed that Ken's degree of melancholia fell within normal limits.

The therapist usually studies the LHI after session number 2, so by the time the client returns for the third session, the impressions gleaned from the inventory are discussed and treatment priorities are established. However, before perusing the entire document, it is my custom to turn to the bottom of page 4, which inquires about the client's "Expectations Regarding Therapy." Ken had written: "I want my therapist to remember the things I discuss with him. I also appreciate someone who will disclose pertinent things about himself. I am looking for someone to advise me, and point me in the right direction." Contrast this with another client's expectations. She had written: "A good therapist is an active listener who says little but hears all." It would be naive to assume that clients always know what they want and what is best for them. But without slavishly following their clients' scripts, if therapists had more respect for the notion that their clients often sense how they can best be served, fewer blunders might result.

In Ken's case, the therapeutic trajectory was clearly enhanced by my willingness to self-disclose. (I revealed strategies that I found helpful in my own marriage and with my own children, and I discussed problems that I had encountered in various work situations and tactics that had proved useful for me.) He took very kindly to the fact that I transcended the usual clinical boundaries by meeting him for lunch on a couple of occasions. He also appreciated the fact that I was quite forthright in

offering advice ("I don't see a down side to your asking for two things. (1) More challenging work. And (2) a raise.")

Several interconnected problems were brought to light. His behaviors were characterized by too much passivity; affectively, he was apt to depress himself needlessly; at the sensory level, generalized muscular tensions seemed widespread; his mental imagery was replete with pictures of his past failures; his cognitions were fraught with statements of self-denigration, perfectionism, and categorical imperatives; and his interpersonal relationships were characterized by unassertive and avoidant patterns.

Initially standard cognitive-behavior therapy strategies were employed: relaxation training, positive imagery exercises, cognitive restructuring (especially antiperfectionistic teachings), and assertiveness training. Ken made good progress across several dimensions but there seemed to be three sticking points: (1) Tensions between Ken and his woman friend were escalating; (2) he was feeling more resentful at work because his boss was so remote and unsympathetic; (3) his unsatisfactory relationship with his children remained a source of pain.

A Second-Order BASIC I.D. assessment was attempted by asking Ken to picture himself attaining some of his immediate goals—achieving harmony at home with his woman friend, coming to terms with his boss, mending fences with his son and daughter. These situations were addressed one at a time, and Ken was asked to discuss the repercussions in each modality.

It became clear that a few sessions with Ken and his significant other might prove beneficial and he agreed to ask Norma, his lady friend, to accompany him to our next session. Subsequently, during three meetings with Ken and Norma they were each able to express their specific complaints and learned how to derive more satisfaction from their relationship by avoiding traps into which they tended to fall. For example, Norma was inclined to dredge up negative events from the past, Ken was apt to say "No" too often even to simple requests, and they both rarely complimented one another. More intensive role-playing procedures were used to enable Ken to take the risk of approaching his boss and expressing his dissatisfactions. At his own initiative, Ken started actively pursuing a new job search.

With regard to his children, given they both lived too far for them to consider some family therapy sessions, Ken agreed to call them, express his love for them and his desire for a better relationship, and to continue a dialogue via letters and e-mail. These active methods

primed Ken to approach all problems now and in the future by deliberately cultivating a forthright, assertive, outgoing, and nonavoidant *modus vivendi*.

A. Outcome

Multimodal behavior therapists have no ironclad adherence to weekly sessions, especially when clients need time to practice homework assignments. Thus, Ken had 16 sessions over a period of 8 months. His gains were clearly evident. He no longer described himself as depressed, and as the result of his newfound nonavoidant behaviors he reported having greater levels of interpersonal satisfaction and closeness. At a follow-up interview 6 months later he mentioned that he had obtained a new job at a higher salary.

It is noteworthy that although Ken was not a resistant, or especially difficult, combative, or seriously disturbed individual, he could easily have continued to suffer needlessly for the rest of his life. Many strategies and tactics were covered in the 16 sessions (e.g., relaxation training, mental imagery methods, cognitive disputation, and assertiveness training), but significant psychosocial gains accrued only after he started taking interpersonal risks. Because the therapist–client relationship is the soil that enables the techniques to take root, it must be remembered that the therapeutic alliance was deliberately tailor-made to fit Ken's needs and expectancies.

VI. SUMMARY

Multimodal behavior therapy draws on the same principles of experimental and social psychology, as do other cognitive–behavioral therapies. It emphasizes that for therapy to be comprehensive and thorough it must encompass even discrete but interactive modalities—behavior, affect, sensation, imagery, cognition, interpersonal relationships, and drugs/biological considerations. The first letters of the foregoing dimensions yield the con-

venient acronym BASIC I.D. This results in broad-based assessment and treatment foci.

Whenever feasible, multimodal behavior therapy practitioners use empirically supported treatment methods. The therapeutic relationship is pivotal. Rapport and compatibility between client and therapist is the soil that enables the techniques to take root. It is also considered essential to fit the requisite treatment to the specific client.

Multimodal behavior therapy is technically but not theoretically eclectic. As has been emphasized by Lazarus and Beutler, one need not draw on any theoretical underpinnings that gave rise to a specific technique when borrowing that procedure and applying it in a different context. The multimodal approach makes effective use of methods from diverse sources without relinquishing its social learning and cognitive theoretical underpinnings.

See Also the Following Articles

Biofeedback ■ Integrative Approaches to Psychotherapy ■ Neuropsychological Assessment

Further Reading

- Keat, D. B. (1996). Multimodal therapy with children: Anxious Ashley. *Psychotherapy Private Practice*, 15, 63.
- Keat, D. B. (1999). Counseling anxious male youths. In A. M. Horne, & M. S. Kilelica (Eds.), *Counseling boys and adolescent males*. Thousand Oaks, CA: Sage.
- Lazarus, A. A. (1992). Multimodal therapy: Technical eclecticism with minimal integration. In J. C. Norcross, & M. R. Goldfried (Eds.), *Handbook of psychotherapy integration*. New York: Basic Books.
- Lazarus, A. A. (1997). *Brief but comprehensive psychotherapy: The multimodal way*. New York: Springer.
- Lazarus, A. A. (2000). Multimodal therapy. In R. J. Corsini, & D. Wedding (Eds.), *Current psychotherapies*. Itasca, IL: Peacock.
- Lazarus, A. A., & Beutler, L. E. (1993). On technical eclecticism. *Journal of Counseling & Development*, 71, 381.



Negative Practice

Theodosia R. Paclawskyj

The Johns Hopkins University School of Medicine
and The Kennedy Krieger Institute

Johnny L. Matson

Louisiana State University

- I. Description of Treatment
 - II. Theoretical Bases
 - III. Empirical Studies
 - IV. Summary
- Further Reading

GLOSSARY

affective variable A feeling or emotional response that follows a behavior or event.

habit Any learned way of living or fixed way of responding.

ideational variable Thought or belief regarding a behavior or event.

negative practice A technique in which a problem behavior is deliberately repeated or practiced by a patient to decrease the response in the long term.

paradoxical intention Therapeutic technique in which a patient suffering from a certain problem is encouraged to focus upon it and try to induce it rather than ignore it or avoid it.

reactive inhibition Principle which states that after any behavior there is an immediate increase in motivation not to perform the behavior.

I. DESCRIPTION OF TREATMENT

Negative practice is a technique in which a problem behavior is deliberately repeated, or practiced, by a patient to decrease the response in the long term. Nega-

tive practice has been used as a response reduction procedure primarily for habits, such as tics or nail biting; or in the treatment of specific types of anxiety. To treat nail biting, for example, clinicians prescribe scheduled practice sessions in which patients deliberately bite their nails until they learn to control the habit. Less often, negative practice has been used as a response reduction procedure for the modification of maladaptive behavior in persons with developmental disabilities.

II. THEORETICAL BASES

The origin of negative practice is associated with the work of Knight Dunlap, Ph.D. (1875–1949), Professor of Experimental Psychology at Johns Hopkins University. Dunlap published several critiques of imagery, consciousness, and instinct; however, his interests in neuropsychology and the impact of cognition on learning were closer to what is currently labeled as cognitive-behaviorism.

In 1928, Dunlap published a brief paper in *Science* in which he hypothesized that errors could best be corrected by repeatedly practicing those errors while acknowledging their incorrectness. He applied this technique to the correction of common typing errors (e.g., “hte” instead of “the”) and found that negative practice remediated the error more rapidly than positive practice. Dunlap then wrote a monograph entitled *Habits, Their Making and Unmaking* in 1932 that out-

lined both his views on the formation of habits and his method to decrease these behaviors. He defined a "habit" as any learned way of living or fixed way of responding. His innovative suggestion for treatment was to repeat deliberately the response to unlearn it, that is, to implement negative practice.

Dunlap discussed several classes of habits, including stuttering (inadequate speech habit) and tics (obsessive motor habits). Although previous methods prescribed simply stopping the habit, for Dunlap this was the end goal, not the means to an end. In Dunlap's conceptualization of negative practice, the patient must understand the inappropriateness of the habit and the benefits of breaking the habit, have the desire to break the habit, and commit to the effort required to break it. In short, both motivation and effort are essential treatment components. Although contemporary psychologists may see this approach as similar to the cognitive-behavioral orientation, at the time Dunlap labeled his methods atheoretical.

In his monograph, Dunlap further explained his methodology using the example of stuttering. He took what a person who stuttered could consistently do (stutter) and used it as the basis of the treatment by which the behavior could be modified. Dunlap felt that if the patient could voluntarily practice stuttering under the conditions of wanting to eliminate the habit, then the habit could be modified. Voluntarily stuttering was the initial part of the process of eliminating the habit. However, Dunlap said that it was the desire to eliminate the habit that was the foundation of the curative process. The patient was not to avoid stuttering but should voluntarily practice stuttering for at least 30 minutes daily. After three or four weeks of practice, most people could then attempt to practice normal speech. If stuttering resumed, negative practice should be reinitiated. Dunlap noted that after three months of treatment, many adolescents responded with no trace of stuttering.

Dunlap wrote that treatment of tics generally paralleled the treatment of stuttering. The treatment of tics may be more rapid, but relapses are more likely. After approximately a dozen deliberate movements, the tic itself may disappear for an hour or two. Sometimes a tic may be completely eliminated, but another may take its place (this should be treated concurrently). Initially, daily practice should be performed with a subsequent schedule to be determined by the psychologist. Dunlap also successfully treated other habits similar to tics, namely, thumbsucking in children and nail biting in college students. Dunlap proposed extending negative practice to a range of personal habits, such as eating noisily or laugh-

ing while telling a story. He believed that the key to negative practice was not to yield to the impulse but to initiate the practice voluntarily in the absence of the impulse. Negative practice was the beginning of the learning process of not performing the habit.

Knight Dunlap's use of negative practice was intended to bring an involuntary behavior under voluntary control. In his perspective, this shift occurred due to both affective and ideational variables. When patients practice the behavior, they do so with a different purpose (ideational variable) and experience the behavior with a different feeling (affective variable). Dunlap believed these variables were essential in achieving voluntary control over the behavior. In fact, the subjective state of the patient was seen as more important than the behavior of the clinician.

Negative practice has been compared to other techniques such as paradoxical intention and therapeutic paradox, both of which have their origins in analytic psychotherapy. Although the techniques vary by theoretical orientation, in each case patients are encouraged to continue their problematic behavior on a schedule established by the clinician. A major distinction between negative practice and these methods involves the role of the clinician: for paradoxical intention and therapeutic paradox, the patient-clinician relationship is seen as paramount; in negative practice, patient variables are considered essential to therapeutic success.

Whereas Knight Dunlap considered negative practice devoid of a theoretical basis, in 1959, Aubrey Yates suggested a formulation of negative practice based on Hullian learning principles of reactive inhibition. According to the principle of reactive inhibition, after any response there is an immediate increase in motivation not to perform the response. The repeated rehearsal of the target response would lead to reactive inhibition. The reduction of the aversive state of reactive inhibition achieved by not performing the tic would lead to conditioned inhibition of the tic.

In 1982, Richard Foxx offered a more parsimonious explanation of negative practice. Based on an applied behavior analytic perspective, he suggested that the high response effort of repeating the behavior served as a punisher for the behavior.

III. EMPIRICAL STUDIES

Although Knight Dunlap provided extensive descriptions of his procedure in his 1932 monograph, the first empirical evidence to support the effectiveness of

negative practice did not come until 1935. Winthrop Kellogg and colleagues compared the rate of maze learning across three conditions: in the first, participants were given no instructions regarding errors; in the second, participants repeated their errors (negative practice); and in the third, participants retraced a distance along the correct pathway that corresponded to the length of their error (positive practice). The negative practice group made significantly fewer errors than the original group and had a slight advantage over the positive practice group.

Since this time, negative practice has been researched periodically. Although initial studies showed successful results for repetitive behaviors and habits, positive outcomes tended to wane following the introduction of newer treatment approaches. This trend can be seen across research for the following behaviors.

A. Tics

Negative practice has been researched as a treatment for tics, although most studies used only one to two subjects. These studies were at least moderately successful in reducing tics such as eyebrow raising, eye blinking, mouth grimacing, head jerking, and multiple tics.

Frank Nicassio, Robert Liberman, Roger Patterson, and Eleanor Ramirez in 1972 used negative practice to treat successfully a single tic in one participant but had no success with a second participant who displayed multiple tics. In the case of the single tic, it subsided after 33 days of negative practice (approximately 16 hours total) and remained absent at 18-month followup. The second participant had multiple vocal and motor tics; three were targeted for intervention in a multiple baseline design. No reduction was observed in any of the tics, and rates remained at high at three-month followup. The authors suspected that this failure resulted from a lack of understanding of the complete behavioral complex (functions) of the multiple tics.

In 1974, Kenneth Knepler and Susan Sewall demonstrated rapid (80-minute) reduction of an eye-blink tic that maintained over a six-month period when smelling salts were paired with negative practice. The authors hypothesized that the use of smelling salts would accelerate the development of an aversive internal state. Negative practice was done as described by Aubrey Yates in 1958: five one-minute trials of practice interspersed with one-minute rest periods during clinic sessions.

Nathan Azrin, R. Gregory Nunn, and S. E. Frantz in 1980 compared negative practice to a newer procedure known as habit reversal. They found that habit reversal reduced tics by 92% by the fourth week, whereas nega-

tive practice only reduced tics by about one-third. Negative practice consisted of 30 seconds of practice every hour. With habit reversal, participants were taught to engage in a motor response incompatible with the tic.

Nathan Azrin and Alan Peterson (1988) reviewed the research to that date that had occurred with negative practice in the treatment of Tourette's Syndrome. Negative practice had a therapeutic effect in 10 out of 18 studies. For five studies with available data to analyze, there was an average of a 58% decrease in tics. Other studies showed an increase or recurrence in tics following treatment, and followup data indicated that the effect may not persist over time.

B. Nail Biting

Negative practice was used as an early treatment for nail biting by M. Smith, who eliminated the habit or markedly reduced it in about half of his sample of college students in 1957. During a two-hour session, the participants simulated nail biting in front of each other while telling themselves how ridiculous they looked. They were supervised by a therapist who explained the rationale, answered questions, and monitored practice. The participants were given instruction to practice nail biting for 30 seconds every hour until nail biting had been eliminated for four consecutive days. At that point, participants were to fade their practice schedule over a two-week period.

In 1976, however, John Vargas and Vincent Adesso found equal effectiveness between negative practice, self-imposed shock, and use of bitter taste. The effects for each of the three treatments were greater than those seen for self-monitoring (e.g., increased attention to the behavior) alone.

Nathan Azrin, R. Gregory Nunn, and S. Frantz in 1980 again compared habit reversal with negative practice in a study of treatments for nail biting. They found that habit reversal reduced nail biting by about 99%, whereas negative practice reduced it by only 60%, although both treatments had components of awareness, motivation to change, and repeated practice of a response. Negative practice within this study consisted of the identical method used by M. Smith in 1957. Azrin and colleagues then continued to pursue research on habit reversal, and subsequent studies of negative practice diminished in the research of treatments for this behavior.

C. Smoking

Negative practice has been used as a form of in vivo aversive conditioning to treat smoking. This procedure

was used by J. H. Resnick in 1968 and again by James Delahunt and James Curran in 1976. However, Delahunt and Curran compared four groups: (1) negative practice alone, (2) self-control alone, (3) a combined treatment package, and (4) a control group of nonspecific therapy. They found that each component separately did not differ from the control group, while the combined group had a significant reduction of 70% from baseline rates. The authors hypothesized that this effect was due to a combination of operant and respondent factors that were in effect in the combined treatments group; both factors appeared necessary to reduce smoking according to the body of research on the reduction of this behavior. The specific method of negative practice in Delahunt and Curran's study involved having subjects smoke 1.5 times more than their usual average for one day, a day of abstinence, smoking 2 times their baseline rate for one day, and then quitting.

Although early studies reported the success of negative practice in the modification of smoking behavior, subsequent studies demonstrated that the effect did not last in followup data and that this therapeutic technique led to relapse, as did most treatments for smoking at the time. In 1968, Edward Lichtenstein and Carolyn Keutzer conducted a followup study of 148 participants who were involved in a treatment study that compared breath holding, negative practice, and covert control (use of high-probability behaviors to reinforce covert thoughts). Although initial treatment gains were seen across all treatment groups at the end of treatment, by a six-month followup, the differences between treated and untreated groups were barely distinguishable. Richard O'Brien and Alyce Dickinson in 1977 compared negative practice, satiation, and control groups following one week of treatment. Initially, each treatment group had a significant decline in daily cigarette consumption. However, this effect was lost at three-month followup. This effect occurred despite manipulation of variables such as cigarette consumption within the negative practice and the baseline frequency of cigarette smoking.

D. Anxiety

In 1976, Richard M. O'Brien demonstrated that negative practice in the form of repeated exaggerations of anxious behaviors could decrease test anxiety and improve course grades in college students. A comparison group of students treated with group desensitization (graduated exposure to test-related stimuli paired with

relaxation training) reduced their anxiety but did not improve their grades. The students practiced for 10 minutes each hour on the first day, 10 minutes each 2 hours the next day, and 10 minutes three times per day for the remainder of a week. However, when Richard Levine and Richard O'Brien attempted to replicate these results with a control group and another test group of systematic desensitization in 1980, they saw no significant treatment effects for any condition. They hypothesized that since this group of participants had lower scores on a test anxiety measure, the negative practice schedule was not intense enough to produce the desired treatment effect.

Richard Wolff in 1977 employed negative practice to treat the compulsive checking rituals of a woman who feared the possibility of intruders in her home after enduring a rape attempt. The participant was a 20-year-old woman who had a 13-step checking ritual that she performed following each return to her apartment. The woman was instructed to repeat the ritual five times contingent on each incident of checking for two weeks. The ritual was eliminated and remained absent at 6- and 12-month followup.

E. Bruxism and Oral Habits

The use of negative practice to treat bruxism (teeth grinding) was first reported by William Ayer, who did his research in 1969, 1973, and 1976. In the 1976 study, he reported successfully treating a group of adults with bruxism by having them schedule negative practice sessions six times a day for a total of 30 to 45 minutes of practice during a two-week period. All participants reported a decrease in bruxism, and 75% remained free of the behavior at one-year followup.

Although Ayer reported successful treatment in the above studies, these data were limited to patient or spousal report of occurrence. In 1988 Ross Vasa and Holly Wortman conducted a single-case study with a 22-year-old woman in which they restricted the massed practice time intervals to the period before bed time. Practice sessions were faded to alternating nights once a treatment effect was observed. A 90% reduction was observed in 10 weeks' time.

Nathan Azrin, R. Gregory Nunn, and S. E. Frantz-Renshaw extended their previous work with negative practice and habit reversal to oral habits such as biting, chewing, licking, or pushing of cheeks, lips, teeth, or palate in 1982. Again, a single-session treatment with followup across 22 months resulted in significantly

greater reduction in the group treated by habit reversal (99%) as compared to that treated by negative practice (65%). The treatment method was identical to that used in their earlier studies treating tics. That is, a two-hour practice period was followed by 30 seconds of practice every hour until the behavior was eliminated. As previously mentioned, Azrin and colleagues proceeded to investigate habit reversal further and discontinued their work in negative practice.

F. Applications for Individuals with Mental Retardation

In all reported applications, negative practice has been used as a contingent procedure for persons with mental retardation. That is, following an occurrence of an inappropriate behavior, the procedure is implemented with the anticipation that it will serve as a punisher and thereby decrease the chance of recurrence. For example, following an instance of clothes ripping, an individual may be guided to repeatedly tear a rag for a specified period of time. When used in this context, negative practice typically is considered a moderately aversive procedure.

Richard Foxx described the use of negative practice with persons with mental retardation and autism. He cautioned that the applicability of this procedure with this population was limited for several reasons. First, negative practice as described in the general research literature requires a certain degree of motivation by the patient to eliminate a problem behavior, something that may not be present to the same level in persons with mental retardation. As a result, the use of negative practice would require physical guidance by a caregiver, which may lead to the patient becoming combative. Next, the treatment acceptability of this procedure may be low among caregivers. Both research and clinical observations have long held that if staff do not find a treatment acceptable, they will be less likely to implement it, resulting in less behavior change in the client. Finally, this procedure is limited to a subgroup of the wide range of problem behaviors that are typically exhibited by this population. It would not be appropriate, for example, to implement negative practice with aggressive behavior, self-injury, or destructive behavior that significantly disrupts a person's environment. The majority of these studies have shown effectiveness, especially when the problem behavior appeared not to be maintained by environmental consequences.

Lombana Durana and Anthony Cuvo in 1980 used negative practice in conjunction with differential reinforcement of other behavior (DRO) and restitution to

eliminate public disrobing in a woman with profound mental retardation. This treatment proved effective even though DRO plus restitution plus positive practice (repeatedly putting on clothes) failed to significantly reduce the behavior.

Pieter Duker and Monique Nielen in 1993 decided to use a response-contingent negative practice procedure to reduce the pica (ingestion of inedible items) of a 33-year-old woman with mental retardation. Pica is a behavior that is often resistant to intervention and is therefore rarely researched. Negative practice in this case consisted of a caregiver approaching the participant when she engaged in pica attempts and pressing the object she was attempting to chew to her lips for a two-minute period. Pica was significantly reduced, and the authors concluded that the contingent negative practice served as a punisher for pica behavior. The authors hypothesized that the continuous repetition of the behavior may have become aversive to the participant.

G. Unique Applications

Several isolated studies exist that describe the application of negative practice to unique topographies of behaviors. For example, in 1974, Howard Wooden described the case of a 26-year-old married man who reportedly displayed nocturnal headbanging for 25 years. After four nights of negative practice (carried out before bed until the patient subjectively experienced physical fatigue), the behavior dissipated and recurred only twice in six months on followup data.

The effectiveness of negative practice for improving spelling ability has been researched with mixed results. Constance Meyn and others in 1963 compared negative practice and positive practice as correction techniques when fourth grade students misspelled words in a research study. There was no difference in outcome between positive and negative practice techniques. Other studies reported both increased errors and improvement in correct spelling with negative practice.

Negative practice has been used in conjunction with other elements of a treatment package for treatment of fire-setting. Typically, the practice component would involve having the child set a fire (or as many fires as possible within a time period) while supervised by an adult who verbally reviewed fire safety procedures. The child would set the fire in a designated area and then be responsible for cleanup. The outcome of this study is difficult to discern because treatment was evaluated as a package and not by the individual components.

In summary, negative practice initially seemed promising as a treatment for many repetitive behaviors. As research progressed, however, most findings tended to show a lack of sustained effect in followup data or more beneficial effects from newer treatment approaches.

IV. SUMMARY

Negative practice is a therapeutic technique in which the patient deliberately repeats a problem behavior until the behavior is reduced or eliminated. Originally, it was hypothesized that negative practice functioned through the principle of reciprocal inhibition, a concept in Hullian learning theory. Due to a lack of supporting data, more recent hypotheses suggest that guided repetition of a behavior may lead to fatigue or another aversive state, thereby defining the technique as a punisher. Negative practice has been used to treat a limited number of symptoms with some success, although many of these symptoms (e.g., tics, smoking, anxiety) can be successfully treated with newer and

more comprehensive approaches. In some cases, it can be successfully applied to certain problem behaviors exhibited by persons with mental retardation.

See Also the Following Articles

Avoidance Training ■ Habit Reversal ■ Negative Punishment ■ Negative Reinforcement

Further Reading

- Azrin, N. H. & Peterson, A. L. (1988). Behavior therapy for Tourette's Syndrome and tic disorders. In D. J. Cohen, R. D. Bruun, & J. F. Leckman (Eds.), *Tourette's Syndrome and tic disorders: Clinical understanding and treatment*. New York: John Wiley & Sons.
- Dunlap, K. (1932). *Habits, their making and unmaking*. New York: Liveright.
- Fox, R. M. (1982). *Decreasing behaviors of persons with severe retardation and autism*. Champaign, IL: Research Press.
- Lehner, G. (1954). Negative practice as a psychotherapeutic technique. *Journal of General Psychology*, 51, 69–82.

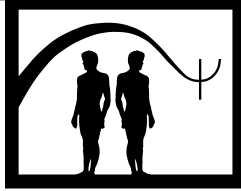

Negative Punishment

Alan Poling, John Austin, Susan Snyckerski, and Sean Laraway

Western Michigan University

- I. Description of Treatment
 - II. Theoretical Bases
 - III. Applications and Exclusions
 - IV. Empirical Studies
 - V. Case Illustration
 - VI. Summary
- Further Reading

GLOSSARY

aversive A nontechnical term often used to refer to punishment and negative reinforcement procedures.

behavior Any action of a living creature. Behavior can be overt or covert.

consequence An event that follows and is produced by a behavior.

environment The natural world in its entirety, including all events that occur inside and outside living creatures.

functional assessment Procedures that are used to identify the variables responsible for a problem behavior.

negative punishers Punishers that involve removing or preventing the delivery of a stimulus.

negative punishment A procedure (or process) in which the removal or prevention of the delivery of a stimulus as a consequence of behavior weakens (e.g., reduces the likelihood of) that behavior in the future.

operant conditioning A form of learning in which behavior is controlled primarily by its consequences.

positive punishers Punishers that involve adding something to an individual's environment.

positive punishment A procedure (or process) in which the presentation of a stimulus after a behavior weakens that behavior in the future.

punishers Consequences that weaken behavior.

response cost A negative punishment procedure that involves removing something of value from an individual after an inappropriate behavior occurs.

rules Overt or covert statements of relations among stimuli and responses. Rules describing the consequences of behavior can evoke behavior similar to that associated with direct exposure to those consequences.

stimulus A physical event.

time out A negative punishment procedure that involves the temporary removal of an individual from an environment in which positive reinforcers are available.

token economy A therapeutic system based on providing appropriate consequences for important behaviors.

Most human behaviors considered by psychologists as important are operant behaviors. That is, these behaviors operate on the environment to produce particular changes, called consequences. Consequences are reinforcers if they strengthen the behavior that produced them and punishers if they weaken it. Punishment occurs when a behavior is weakened by its consequences. In 1953, B.F. Skinner noted that punishment was the most common form of behavior control. He strongly opposed its use in clinical applications and in society in general, and many other prominent people have done likewise. Nonetheless, punishment continues to be ubiquitous in everyday life. It is also used systematically to improve behavior in therapeutic applications, although ethical, practical,

and legal considerations limit where, how, and with whom punishment can be utilized.

I. DESCRIPTION OF TREATMENT

Psychologists commonly distinguish between negative and positive punishment. Positive punishment occurs when the presentation of a stimulus, termed a positive punisher, weakens the behavior that caused this consequence to occur. In contrast, negative punishment occurs when the removal or prevention of delivery of a stimulus, termed a negative punisher, weakens the behavior that produced this consequence. As an everyday example of negative punishment, envision two friends who are sitting together having a friendly conversation when one makes a highly critical comment about a presidential candidate. The other person likes the candidate and is angered by the comment and abruptly gets up and walks away upon hearing it. If this results in fewer negative comments about the politician in the future, then negative punishment has occurred. In this hypothetical example, and in most cases, the response-weakening effect of punishment involves a decrease in the frequency of responding, although other changes in behavior (e.g., increased latency to respond or decreased intensity of responding) may be indicative of a punishment effect.

For negative punishment to be effective, the stimulus that is removed or avoided must have positive hedonic value. In general, such stimuli serve as positive reinforcers, which are stimuli that strengthen behaviors that produce them. Many writers describe negative punishment as a procedure that weakens a particular kind of behavior because that behavior removes a currently available positive reinforcer or prevents the delivery of an otherwise forthcoming positive reinforcer. Although this conception of negative reinforcement makes intuitive sense, stimuli that serve as negative punishers for a particular individual's behavior may never have served as positive reinforcers for that individual's behavior. For instance, a child who has been given CDs by family members may value them, and taking them away following an undesired behavior, perhaps cursing, might function as negative punishment. Thus, the CDs are negative punishers. But they were given to the child independent of her behavior, and no behavior was strengthened by their delivery. Thus, they have not functioned as positive reinforcers for any behavior of the individual in question. Whether they have the capacity to serve this function is not a

fixed characteristic of the CDs but depends on the context in which their presentation follows behavior.

Basic and applied studies demonstrate conclusively that the behavioral function of a given stimulus is not fixed but rather depends on historical and current circumstances. Although stimuli that serve as negative punishers often also serve as positive reinforcers, this is not always, nor necessarily, the case. Moreover, thinking of the stimuli that are removed or avoided as positive reinforcers may cause confusion about the behavioral effects of negative punishment. Reinforcement always strengthens behavior, and punishment always weakens it; this principle holds regardless of whether either procedure is "positive" or "negative." In addition, these terms refer only to whether the procedure involves adding something to an individual's environment or taking something away. They do not refer to the kinds of behavior that are affected or to the "goodness" of the consequences that are arranged.

Although the behavioral functions of stimuli are not fixed, they are not capricious, and it is usually possible for psychologists and others to predict with some accuracy whether an event will function as a negative punisher in a given context. Personal experience, scientific reports, and theoretical deductions are all useful in predicting that a specific event will punish behavior, although the ultimate test is to arrange the event as a consequence for the behavior that is to be reduced. Operations that fail to weaken behavior do not constitute punishment, even if the persons who designed and implemented them intended them to reduce responding.

When used therapeutically, negative punishment is used to weaken inappropriate target behaviors. The two most commonly used procedures that involve negative punishment are time out (also spelled timeout or time-out) and response cost. As discussed later, these procedures have been effective in reducing a variety of target behaviors in various settings with diverse client populations.

Time out generally involves temporarily removing an individual from an environment in which positive reinforcers are available whenever the behavior that is to be reduced occurs. That is, when the client performs the undesired behavior, she or he loses the opportunity to earn positive reinforcers. The two broad classes of time out are exclusionary and nonexclusionary. In exclusionary time out, the client is moved from a setting that provides many positive reinforcers to a setting that provides few, if any, positive reinforcers. For example, a child who misbehaves in a classroom may be moved from the classroom to an empty room for a two-minute

period as a form of exclusionary time out. If successful, this procedure would reduce the subsequent rate of occurrence of the undesired behavior.

Time out has been used most extensively in educational settings. In such settings (and some others as well), exclusionary time out commonly is implemented in one of three ways. In one, the client is required to spend the duration of the time out in a secluded time-out room whenever the behavior targeted for reduction (e.g., swearing) occurs. Time-out rooms should be well ventilated, well lit, and reasonably comfortable but should not contain obvious sources of positive reinforcement (e.g., toys, chairs that rock). If necessary, such rooms should be padded to protect clients from injuring themselves. Provision should be made for observing clients during time outs (e.g., through one-way mirrors) and intervening rapidly to terminate dangerous activities. Clients should not spend more than a few minutes in the time-out room. Long periods of time out do not necessarily reduce behavior more effectively than do short periods, and the former may be abusive to the client.

A second exclusionary time-out method uses a partitioning wall that separates the time-out area from the normal setting (e.g., a classroom). This method is similar to the use of a time-out room in that it involves a move from a more to a less reinforcing environment, but the client is moved to a place behind the partition instead of being moved to a separate room. One problem associated with the partition method is that disruptive clients can continue to disrupt normal activities from behind the partition. Furthermore, other individuals can still reinforce problem behaviors by laughing, making comments, or otherwise responding to the misbehavior.

A third, and perhaps the most popular, method of arranging exclusionary time out, involves taking the client to the hallway outside of the room where the problem behavior occurred. Although this method may be the only practical option for some situations, hallway time outs should generally be avoided because hallways typically contain many sources of positive reinforcement, such as other students, drinking fountains, windows into other rooms, bulletin boards, and posters.

To ensure the safety of students and to prevent them from running away, arrangements must be made for monitoring students placed behind partitions or in hallways during time out. These forms of time out, like all others, should be as brief as possible.

Exclusionary time out is likely to be effective in reducing behavior if four criteria are met. First, the time

out must involve a move from an environment that provides a relatively high frequency of positive reinforcers to an environment that provides a relatively low frequency of positive reinforcers. If the frequency and quality of reinforcers in the time-out environment are equal to or greater than those in the regular environment, then time-outs will not punish, and may even reinforce, the undesired behavior.

Second, time outs must occur immediately after the problem behavior occurs. Delays in implementing time outs are apt to reduce their effectiveness substantially. Third, time outs should be ended only when the individual is engaging in appropriate behaviors. If time outs end while the individual is behaving unacceptably, or immediately thereafter, termination of the time out and return to the normal environment could reinforce the undesired behavior.

Finally, time-out procedures should be clearly explained to the client. This allows for rules about the consequences of behavior, as well as direct exposure to those consequences, to affect the target response. Rules specify relations among stimuli and responses and can engender behaviors similar to those produced by actual exposure to those relations. Helping clients to formulate and follow appropriate rules is apt to increase the effectiveness of any intervention and should be part of almost all treatments. This includes response-cost procedures.

Sometimes it is not possible or desirable to remove a misbehaving client from the situation in which the misbehavior occurs. In such cases, nonexclusionary time out is often used. In nonexclusionary time out, the individual remains in the setting where the problem behavior occurred but loses the opportunity to earn positive reinforcers. For example, a teacher may briefly ignore a student who behaves inappropriately. Ignoring, in this case, prevents the student from earning social reinforcers from the teacher.

Psychologists have developed four general methods of nonexclusionary time out: time-out ribbon, planned ignoring, contingent observation, and prevention of preferred activities. The time-out ribbon provides an excellent example of nonexclusionary time out. This method requires that all clients receive a ribbon when they enter the treatment setting. Possession of the ribbon indicates that the individual is allowed to participate in the reinforcement system (usually a token economy, which will be described later). Whenever a client performs a behavior targeted for reduction, the ribbon is taken from the client, indicating that the client can no longer obtain reinforcers from staff for

some predetermined time. Unfortunately, this intervention is unsuited for reducing behaviors not maintained by staff-delivered reinforcers, or behaviors (e.g., self-injurious responding) maintained by staff attention that cannot be withheld for ethical or practical reasons.

As the name implies, planned ignoring involves having caregivers ignore predetermined problem behaviors. For example, in a therapy group designed to reduce interpersonal aggressive behaviors, the therapist (and others) may briefly ignore a client every time the client makes an aggressive remark (e.g., "I'm gonna kill you"). Planned ignoring tends to be most effective when the individual's social environment is highly reinforcing and when the therapist consistently implements the intervention. One problem with this intervention is that some behaviors are difficult or dangerous to ignore. Using the therapy group example, if a client actually engaged in an aggressive act against another person, it would be unethical simply to ignore this behavior. Another problem with planned ignoring is that this intervention is effective only if the client's behavior is maintained by social reinforcers that caregivers control.

Contingent observation is usually implemented in a group setting, such as a classroom. In contingent observation, a misbehaving client is asked to sit outside of a group of individuals and observe the group for a brief period of time (e.g., two minutes). During this time, the client cannot participate in group activities and, hence, cannot receive social reinforcers. In addition, the client observes others behaving appropriately and receiving reinforcers. Thus, this intervention uses negative punishment and modeling to achieve its effects. As with other time-out procedures, contingent observation requires that reinforcers are not available for the misbehaving client during observation periods and that the intervention be applied consistently and immediately after the problem behavior occurs.

A final nonexclusionary time-out procedure consists of preventing the client from engaging in a preferred activity, such as playing cards, whenever the target behavior occurs. For example, one study demonstrated that children's thumbsucking could be reduced by turning off the television the children were watching immediately following each incident of thumbsucking. In some cases, it may be appropriate and possible to reduce problem behaviors without clients' knowledge using this time-out technique. This may be important in situations where other behavior-weakening techniques have produced disruptive or aggressive behavior in clients.

There are obvious benefits and drawbacks to both exclusionary and nonexclusionary time out. Nonexclusionary time out is thought to be more beneficial to the client because he or she is allowed to remain in the educational (or therapeutic) environment. In addition, if the client does not have to be removed from the environment, there is less chance that he or she will become aggressive or hostile. As previously mentioned, however, nonexclusionary time out allows highly disruptive individuals to remain in the setting, providing them with the opportunity to disrupt further the ongoing activities. Exclusionary time out, on the other hand, has the virtue of removing disruptive individuals from the setting, allowing other clients to benefit from ongoing activities. Unfortunately, exclusionary time out removes from the instructional situation the very individuals who may need instruction the most. There is no obvious solution to these problems, and therapists must find a way to weaken inappropriate behavior while ensuring that clients receive the educational opportunities they require.

Whereas time out involves removing the opportunity for an individual to gain access to positive reinforcers, response cost involves taking valued stimuli away from an individual when misbehavior occurs. That is, response-cost interventions make problem behaviors "costly" in that the individual who emits these behaviors loses something of value. Put simply, the client has to pay for engaging in inappropriate behavior. Examples of response-cost procedures often appear in our daily lives in the form of fines and points lost in classroom settings. Implementing a response-cost procedure in no way guarantees that negative punishment will occur. In order for response cost to weaken behavior, the individual must lose something of greater value than whatever the individual gains by misbehaving.

Response-cost procedures are commonly implemented in four ways. First, response cost can be combined in a package intervention with procedures, such as differential-reinforcement-of-incompatible-behavior (DRI) schedules, that increase appropriate behaviors. Here, reinforcers earned under the DRI schedule for appropriate behavior would be lost if the undesired behavior occurred.

Second, response cost involving fines of specific amounts through loss of points, money, tokens, or quantifiable amounts of other valued stimuli already in the individual's possession can be used alone. Third, "bonus" or "free" reinforcers can be delivered at the start of the response-cost period and then removed if inappropriate behaviors occur. Finally, response cost

can be implemented for a group of clients such that inappropriate behavior on the part of one group member will result in the loss of valued items for the entire group. In this case, the response-cost procedure results in group members exerting “peer pressure” on other members to remain well behaved. Although such peer pressure can maintain appropriate behavior, it may be too stressful for some clients. Thus, group procedures should be monitored carefully.

Psychologists often implement time out and response-cost procedures in settings where token economies operate. Token economies are behavior management systems that provide tokens, such as poker chips or points, for appropriate behaviors. The tokens can then be traded for a variety of backup reinforcers, such as tangible items like candy, soda, and toys, or for privileges like going to the park or checking out a book at the library. As a result of being exchanged for a variety of backup reinforcers, the tokens eventually come to function as generalized conditioned reinforcers and effectively maintain appropriate behaviors. In this way, tokens allow the psychologist to deliver consequences immediately following the performance of target behaviors, thereby maximizing the likelihood of the desired behavioral effect.

In the context of a token economy, time out involves the restriction of a client’s ability to participate in the token system for a short period of time (e.g., two minutes) whenever the individual engages in an inappropriate behavior. Response cost in a token economy is relatively straightforward and involves the removal of a specified number of tokens whenever an individual engages in inappropriate behavior.

The implementation of a token economy requires: (a) specification of observable, easily measured behaviors to be reinforced or punished; (b) delivery or removal of tokens when the behaviors specified in (a) occur; (c) identification of effective backup reinforcers for which tokens can be exchanged; and (d) specification of rules by which the economy runs, including rules concerning exchange rates, magnitude of reinforcers and punishers, schedule of consequence delivery, and frequency of exchanges. In theory, token economies can be of any size if sufficient resources to manage the system are available.

Token economies must be flexible enough to support each client’s personalized treatment goals and to provide consequences that may differ widely across individuals. As systems become more individualized, however, they become more complex, which can result in staff performance problems. No token system will

function perfectly all of the time, so they should include mechanisms that allow treatment providers to monitor how well the system is performing and to correct any problems that arise. One way to increase the possibility that the token system will function smoothly is to obtain client’s cooperation and input when designing the system. Including clients in the system development process increases their involvement in the system and gives them a greater degree of control over their lives.

Regardless of whether or not response cost is implemented as part of a token economy, the procedure is not likely to be successful unless the undesired behavior leads rapidly and consistently to the loss of enough of a valued item to be of significance to the client. A potential problem with the procedure is that, if response cost is implemented repeatedly, there may be no more of the specified valued item to take away. This difficulty sometimes can be averted by arranging a number of “different costs” for a target behavior. For example, tokens might be taken away until none are left; then loss of a specified series of privileges could occur.

What might be termed intermittent response cost is regularly used in educational settings. Here, something of value is lost after the target behavior occurs a specified number of times. For example, a teacher might make a check mark on the board each time a student talks out in class. When the third check mark appears, the child loses access to the playground during the next recess period. Although this procedure is often effective, some students might “figure out the system” and misbehave twice before behaving appropriately. This outcome might or might not be acceptable to the teacher, depending on the nature of the undesired behavior.

The procedure described in the preceding example was presented as a response-cost manipulation; this is legitimate because the student lost something of value—access to recess—because of misbehaving. But the procedure could also be construed as time out because the child lost access to reinforcers associated with the playground dependent on misbehaving. Although it is of heuristic value to distinguish between time out and response cost, the distinction often blurs in everyday applications.

II. THEORETICAL BASES

Punishment has generated a great deal of theoretical interest, although positive and negative punishments characteristically are not distinguished in these discussions. From the earliest days of psychology as a formal

discipline, it has been widely acknowledged that consequences can weaken as well as strengthen behavior. For instance, Edward Thorndike pointed this out early in the 1900s in his famous Law of Effect. The version that appeared in his 1905 book, *The Elements of Psychology*, reads:

Any act which in a given situation produces satisfaction becomes associated with that situation, so that when the situation recurs the act is more likely than before to recur also [this is reinforcement]. Conversely, any act which in a given situation produces discomfort becomes disassociated from the situation, so that when the situation recurs the act is less likely than before to recur [this is punishment].

Over time, however, Thorndike became convinced that punishment did not produce enduring effects. This view was based on limited studies of positive punishment that he conducted. The preeminent behavioral psychologist B. F. Skinner supported this view in his 1953 book, *Science and Human Behavior*, and elsewhere. Skinner contended that not only does punishment typically fail to produce lasting response suppression, but it also characteristically engenders negative reactions, including aggression, escape, and attempts at countercontrol. Consequently, punishment (and negative reinforcement, claimed to have similar adverse effects) should be avoided in clinical applications and in society at large. Skinner described a society without aversive control in his utopian novel, *Walden Two*, published in 1948.

Despite arguing forcefully against the use of punishment, Skinner recognized that operant behavior was sensitive to both negative and positive punishment. In fact, throughout Skinner's long life, both were included as principles of behavior in his analysis of operant conditioning. Skinner did not argue that behavior could not be reduced by negative punishment. Rather, he argued on practical and ethical grounds that behavior should not be reduced in this way because there are better alternatives (e.g., positive reinforcement).

Arguments against the use of punishment similar to those first advanced by Skinner half a century ago have been repeated and extended in the ensuing years. Over this same period, laboratory studies with nonhumans and humans and clinical studies with various client populations have provided clear evidence that both negative and positive punishment can produce strong and enduring reductions in operant behavior. Insofar as theory in psychology should be based on data, there is substantial theoretical support for the effectiveness of procedures based on negative punishment.

Whether such procedures are appropriate for therapeutic use in general, or in specific cases, is another issue altogether. Some theoreticians argue for and against therapeutic techniques based on the principles of behavior that underlie their effects. They claim, for instance, that positive reinforcement is good and negative punishment (along with positive punishment and negative reinforcement) is bad. But in the everyday world of the clinic and classroom, and in courts of law, the acceptability of procedures is usually based on their details (who does what to whom, for what reason, and with what real or anticipated result?), not on their mechanism of action. In the following section, we discuss general restrictions on the use of negative punishment and discuss appropriate safeguards for the use of procedures that involve negative punishment. Although such procedures should always be used with care, mild and generally accepted interventions (e.g., teachers' use of nonexclusionary time out for classroom management) typically are not subjected to the same scrutiny as more unusual and potentially intrusive interventions (e.g., time out in a secluded room to reduce severe self-injury in a person with severe mental retardation).

III. APPLICATIONS AND EXCLUSIONS

Even though negative and positive punishment can be distinguished procedurally and arguments against punishment have focused on the latter, procedures involving both forms of punishment (and negative reinforcement) are commonly considered as "aversive" and relatively restrictive (harmful) interventions. Therefore, the use of negative punishment is limited by both ethical and legal considerations, although the extent of these restrictions depends on the specific procedure, client, problem behavior, and setting under consideration. Like all "aversive" interventions, procedures involving negative punishment may generate negative affective behavior (e.g., crying), aggression, and escape responding. Moreover, negative punishment procedures are easily misused by ill-informed or ill-intentioned caregivers, as when clients are placed in a time-out room for long periods for staff convenience.

In view of the foregoing considerations, negative punishment should not be used until less restrictive interventions have proven ineffective. As with positive punishment, a clear decision-making process regarding the use of negative punishment should be in place. Specific guidelines must be established regarding the

exact nature of the proposed punishment procedure, including who is to implement it and the specific standards of accountability. Unambiguous rules regarding the behavioral data that will support continuation, modification, and termination of punishment must be established and followed by a vigilant, expert, and caring treatment team before punishment is implemented. Input from clients, client's advocates, behavior-change experts, and the individuals responsible for implementing procedures is invaluable in formulating guidelines for the use of negative punishment in schools and other settings.

Before a negative punishment procedure is implemented, the treatment team, as Ray Miltenberger suggests in his excellent 1997 text *Behavior Modification*, should

1. Conduct a functional analysis to ascertain the consequences and other variables that are maintaining the problem behavior. This information is invaluable for planning effective interventions.
2. Determine whether the proposed intervention (e.g., time out or response cost) is practical in the present situation.
3. Determine whether the proposed intervention is safe.
4. Determine whether the client can readily escape from or avoid the proposed intervention.
5. Determine whether the intervention can be implemented consistently.
6. Determine whether all parties with a legitimate interest in the intervention find it acceptable.

Adhering to these guidelines often requires substantial time and effort. But doing so is essential to ensuring the well-being of clients.

In general, with the proviso that clients with special needs require special protections, issues of client diversity do not strongly enter into whether or not procedures based on negative punishment are appropriate. Interestingly, such procedures are frequently used with children and with adults with mental illness or mental retardation, and these are the very people most in need of special protections.

IV. EMPIRICAL STUDIES

The clinical literature relevant to negative punishment is sizable; numerous studies have shown that time out and response cost, if properly arranged, can effec-

tively reduce a wide range of target behaviors in numerous settings with a variety of client populations. Time out is the negative punishment procedure most often examined in published studies, and it has a long history of success in the treatment literature. Published studies have demonstrated time out to be effective in reducing cursing, off-task behaviors, stereotypic behaviors, thumbsucking, pica, self-injury, disruptive meal-time behaviors, tantrums, self-stimulation, perseverative speech, noncompliant behaviors, physical aggression, verbal abuse, hoarding, and rule violations. Settings in which time-out procedures have been successfully implemented include psychiatric hospitals, elementary and high schools, juvenile facilities, and day-treatment schools. Among the clients with whom time-out procedures have been effective are children with autism, people with mental retardation and other developmental disabilities, people with mental illness, and children, adolescents, and adults without disabilities.

Response-cost interventions have been shown to be effective in decreasing smoking, cocaine use, opiate use, rule violation, off-task behavior, hyperactivity, aggressiveness, psychotic speech, stuttering, overeating, tardiness, perseverative speech, anxious and depressive behavior, and self-injurious behavior. Furthermore, response-cost interventions have been effective in improving academic performance and vocational training activities.

The effectiveness of response-cost procedures has been demonstrated in a wide range of settings. The literature shows these procedures to be effective in settings such as preschools, middle schools, high schools, and vocational education schools, as well as in prisons, psychiatric hospitals, day-treatment facilities, and home settings. This intervention has been used successfully with many client populations, including children with autism, people with mental retardation and other developmental disabilities, people with mental illness, prison inmates, predelinquent boys, and people without diagnostic labels. Furthermore, therapists often use behavioral contracts with response-cost components to benefit married couples, families, teachers, and individual clients. Behavioral contracts are agreements among committed parties regarding the consequences of specified behaviors.

V. CASE ILLUSTRATION

The director of a residential treatment facility wished to reduce the relative frequency of episodes of

nonsensical speech in Ronald, a 15-year-old male diagnosed with schizophrenia. Ronald had engaged in nonsensical speech frequently over the past two years, and his statements usually centered around conversations with Ashtar, described by Ronald as the captain of an omnipotent space fleet. Because of his frequent episodes of nonsensical speech, other residents avoided Ronald. Indeed, nonsensical speech prevented Ronald from engaging in conversations with most people. In addition, the director realized that Ronald's bizarre speech interfered with the staff's ability to gather useful information about Ronald's needs. For example, when Ronald became ill, a reasonable description of symptoms might well facilitate his treatment, whereas statements concerning spacecraft and the beings who pilot them would be of no benefit whatsoever.

The director observed Ronald for five minutes at 30-minute intervals over a five-day period. During these baseline observations, the director recorded the percentage of intervals in which nonsensical speech occurred. In the process of collecting baseline observations, the director noticed that a few of the staff members spent time talking with Ronald about his conversations with Ashtar. From this, the director hypothesized that social reinforcers might help maintain Ronald's nonsensical speech.

The data indicated that Ronald engaged in nonsensical speech in 91% of the intervals. After collecting these data, the director met with Ronald's treatment team to discuss the results of the baseline observation. It was decided that a treatment package in which sensible speech was strengthened through positive reinforcement and nonsensical speech was weakened through a negative punishment component would be implemented. The positive reinforcement component consisted of a DRI schedule. The incompatible behavior that was reinforced was sensible speech (i.e., speech that did not contain references to Ashtar or the space fleet). Specifically, if Ronald spoke sensibly when a staff member came to observe him, then the staff member spent two minutes in conversation with Ronald and provided social reinforcers, such as smiles, eye contact, and questions about Ronald's interests. The negative punishment component consisted of a planned ignoring procedure in which the staff member turned and walked away when Ronald made a nonsensical remark.

After 10 weeks of treatment, the percentage of intervals in which Ronald made a nonsensical remark decreased from the baseline level of 91% to less than 25%. Unfortunately, in the eleventh week of treatment, volunteers from the local university visited the facility and

spent much time speaking with the residents. After the volunteers' visit, the relative frequency of Ronald's nonsensical speech increased to nearly 50% and remained at that level for three weeks but declined to around 20% after another month.

At this point, a decision was made to add token reinforcers to Ronald's treatment package. These tokens (poker chips) were delivered when Ronald spoke sensibly. When he spoke nonsensically, one token was taken away. Social reinforcers continued to be provided when Ronald spoke meaningfully, and staff interacted only minimally when taking the tokens, then walked away. This altered intervention reduced intervals with nonsensical speech to approximately 5%. At that point, the frequency of reinforcement was gradually reduced, although the response-cost component stayed in effect. Ronald continued to talk appropriately most of the time, and there was general agreement that the problem was solved.

VI. SUMMARY

Negative punishment refers to a procedure (or process) in which the removal or avoidance of a stimulus as a consequence of behavior weakens such behavior. Response cost and time out are two common clinical interventions based on negative punishment. Published studies have shown these interventions to be effective in reducing a wide variety of inappropriate behaviors in several client populations in a variety of settings. Nonetheless, procedures based on negative punishment are widely construed as aversive and restrictive, and both ethical and legal considerations limit their range of utility.

See Also the Following Articles

Aversion Relief ■ Conditioned Reinforcement ■
Functional Analysis of Behavior ■ Negative Practice ■
Negative Reinforcement ■ Positive Punishment ■ Positive
Reinforcement ■ Self-Punishment ■ Time-Out ■ Token
Economy

Further Reading

- Alberto, P. A., & Troutman, A. C. (1990). *Applied behavior analysis for teachers*. New York: Macmillan.
Coóper, J. O., Heron, T. E., & Heward, W. L. (1987). *Applied behavior analysis*. Columbus, OH: Merrill.
Kazdin, A. E. (1972). Response cost: The removal of conditioned reinforcers for therapeutic change. *Behavior Therapy*, 5, 533-546.

Klein, S. B. (1991). *Learning: Principles and applications*, 2nd ed. New York: McGraw-Hill.

Mazur, J. E. (1998). *Learning and behavior*, 4th ed. Upper Saddle River, NJ: Prentice Hall.

Miltenberger, R. (1997). *Behavior modification: Principles and procedures*. Pacific Grove, CA: Brooks/Cole.

Sidman, M. (1989). *Coercion and its fallout*. Boston, MA: Authors cooperative.

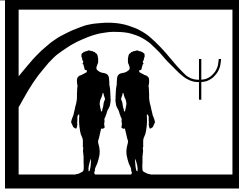

Negative Reinforcement

Alan Poling, Linda A. LeBlanc, and Lynne E. Turner

Western Michigan University

- I. Description of Treatment
 - II. Theoretical Bases
 - III. Applications and Exclusions
 - IV. Empirical Studies
 - V. Case Illustration
 - VI. Summary
- Further Reading

GLOSSARY

aversive A nontechnical term often used to refer to punishment and negative reinforcement procedures.

avoidance conditioning A procedure in which behavior postpones or prevents the delivery of an otherwise forthcoming negative reinforcer and is therefore strengthened.

behavior Any action of a living creature. Behavior can be overt or covert.

conditioned negative reinforcer An event that acquires its capacity to serve as a reinforcer through learning.

consequence An event that follows and is produced by a behavior.

environment The natural world in its entirety, including all events that occur inside and outside living creatures.

establishing operation An event that alters the reinforcing or punishing value of a consequence.

escape conditioning A procedure in which behavior terminates or reduces the intensity of an ongoing stimulus and is therefore strengthened.

extinction A procedure (or process) that reduces behavior by failing to reinforce a previously reinforced response.

functional assessment Procedures that are used to identify the variables that maintain a problem behavior.

negative reinforcement A procedure (or process) in which the removal or postponement of a stimulus after a behavior strengthens (e.g., increases the likelihood of) that behavior in the future.

operant A behavior that “operates” on the environment and is controlled by its consequences.

reinforcer A consequence that strengthens operant behavior.

respondent conditioning A procedure in which a previously neutral stimulus comes to control behavior by virtue of reliably preceding a stimulus that controls behavior at the onset of and throughout stimulus–stimulus pairings.

response A defined unit of behavior.

rules Overt or covert verbal descriptions of relations among stimuli and responses. Rules describing consequences can engender behavior similar to that produced by actual exposure to the consequences.

stimulus A physical event.

unconditioned negative reinforcer An event that does not require learning to serve as a reinforcer.

The term negative reinforcement refers to one of the basic principles of operant conditioning rather than to a specific therapeutic technique. Operant conditioning is a form of learning in which behavior is controlled primarily by its consequences, that is, by changes in an individual's environment that are produced by the behavior. When the consequences of behavior increase the future probability of that kind of responding occurring under similar circumstances, or otherwise strengthen behavior, the consequences are termed reinforcers and the process

(and procedure) through which responding is strengthened is called reinforcement. Although a number of prominent psychologists have argued against the practice, theoreticians and practitioners commonly distinguish between positive and negative reinforcement. The definitions and examples provided here illustrate the similarities and differences between them.

I. DESCRIPTION OF TREATMENT

When a stimulus (physical event) strengthens behavior by virtue of being presented (or increased in intensity) following the occurrence of such behavior, the stimulus is called a positive reinforcer and the procedure is termed positive reinforcement. For example, the behavior "bringing home flowers" is strengthened when a pleasantly surprised spouse says, "Thank you, sweetheart. You are really thoughtful." The positive reinforcer is the appreciative statement, and bringing home flowers is strengthened because the behavior resulted in its occurrence.

When behavior is strengthened because it terminates (or reduces the intensity of) a stimulus, or prevents or postpones the delivery of an otherwise forthcoming stimulus, the procedure is termed negative reinforcement and the stimulus is called a negative reinforcer. For example, a teenager who picks up his room thereby prevents or postpones his mother's angry lecture about responsibility and cleanliness. Picking up the room is strengthened because it results in a negative reinforcer. The negative reinforcer (i.e., the angry lecture) is also commonly called an aversive stimulus.

The designation aversive stimulus is also applied to stimuli that serve as positive punishers. Perhaps for this reason, many people confuse negative reinforcement with positive punishment. The two procedures can be distinguished on one primary basis. While negative reinforcers strengthen behavior, positive punishers weaken (decrease the rate or intensity) behavior when delivered as consequences. For example, a child reaches toward a sharp knife (behavior) and a watchful parent exclaims sharply, "no" (positive punisher). The surprised child draws the hand back and does not reach for sharp knives again (weakened behavior). Stimuli that function as a negative reinforcer in one context frequently serve as a positive punisher in similar contexts. Nonetheless, negative reinforcement and positive punishment are independent processes that produce opposite effects on behavior, and the terms should never be used interchangeably.

Two variants of negative reinforcement can be distinguished: escape conditioning and avoidance conditioning. When behavior terminates or reduces the intensity of an ongoing stimulus and is therefore strengthened, the procedure is called escape conditioning and the behavior is termed an escape response. The reader should note that with escape conditioning the aversive stimulus is ongoing and thus is always present when the escape response occurs. For example, a person who is listening to the radio when a program that she dislikes comes on may turn a knob on the radio labeled "OFF-ON" to the left, terminating the aversive sound. If turning the knob to the left terminates the sound and knob-turning is strengthened, escape conditioning is evident. Here, the response-strengthening effects of negative reinforcement would most likely be evident not as a progressive increase in the rate of turning off the radio over time, but rather as reliably doing so each time a disliked program was aired. Reinforcement increases the rate of responding initially and subsequently maintains established rates and patterns of behavior.

When behavior postpones or prevents the delivery of an otherwise forthcoming aversive stimulus and is therefore strengthened, the procedure is called avoidance conditioning and the behavior is termed an avoidance response. Because the avoidance response prevents or postpones the occurrence of the aversive stimulus, the aversive stimulus is not present when the avoidance response occurs. A child who regularly says "please" when making requests because failing to do so historically has led to parental reprimands provides a good example of avoidance conditioning. Here, if "please" is not included as part of a request, then a reprimand is forthcoming. If, however, the child says "please," there is no reprimand. These consequences cause the child to say "please" consistently, as an avoidance response when no aversive stimulus is present.

Some stimuli, termed unconditioned (or primary) negative reinforcers, "automatically" strengthen behavior as consequences. That is, no conditioning history is required for them to serve this behavioral function. High-intensity sensory stimulation in any modality (e.g., loud sounds, bright lights, forceful pressure on the skin, extreme heat or cold) characteristically serves as a primary negative reinforcer.

As their name implies, conditioned (or secondary) negative reinforcers require a particular conditioning (learning) history to strengthen behavior as consequences. Respondent conditioning, in which a previously neutral stimulus reliably and immediately

precedes presentations of an unconditioned negative reinforcer, can serve to establish the neutral stimulus as a conditioned negative reinforcer. So, too, can verbal mediation, as when a friend tells a person holding illegal drugs “that the guy in the brown sweater is a cop,” and the drug-holder subsequently avoids the officer.

II. THEORETICAL BASES

A large number of studies have examined escape and avoidance conditioning in laboratory animals and in humans under laboratory settings. These studies provide clear evidence of the effectiveness of negative reinforcement in initially increasing the rate of, and then maintaining, operant behavior. They also have revealed much about the variables that influence the effectiveness of negative reinforcement in strengthening behavior, and therapeutic applications of negative reinforcement are built on a solid experimental foundation.

Since B. F. Skinner's early writings, most behavioral psychologists have favored explanations of operant behavior based on its more-or-less immediate consequences. Such explanations, which are termed molecular, work well with respect to escape conditioning. The usual theoretical explanation of escape conditioning is that responses immediately terminate an aversive stimulus, and this change in the environment is responsible for the strengthening of behavior. This analysis is straightforward and poses no conceptual difficulties. Explanations of avoidance conditioning are conceptually more difficult and have occasioned some debate.

Two variants of avoidance conditioning, signaled and unsignaled, are commonly distinguished. In signaled (or discriminated) avoidance, presentations of a forthcoming aversive stimulus are preceded (signaled) by a warning stimulus. A response during the warning stimulus terminates the warning and prevents the occurrence of the aversive stimulus. In unsignaled (also termed free-operant or nondiscriminated) avoidance, no specific stimulus precedes delivery of the aversive stimulus.

Signaled avoidance is easy to explain theoretically in terms of a two-factor theory initially proposed by Mowrer in the late 1940s. The essence of this widely accepted account is that the warning stimulus, which is highly predictive of the aversive event, comes through respondent conditioning to elicit what is commonly termed “fear.” Fear is unpleasant. It ends when the warning stimulus ends, and this happens as soon as the avoidance response occurs. Therefore, the avoidance response does have an immediate consequence—it ter-

minates the aversive warning stimulus and the accompanying “fear.”

This account must be substantially modified to explain unsignaled avoidance, where there is no apparent warning stimulus. The general approach taken by molecular theorists is to posit that the passage of time since the last occurrence of the aversive stimulus, or of the avoidance response, serves as a warning stimulus that elicits fear. Occurrence of the avoidance response, which is never immediately followed by the aversive stimulus, terminates the fear, and it is this immediate outcome that strengthens responding. Although the results of some studies support this view, the results of others do not. Particularly troublesome for two-factor theories of avoidance are that (1) studies often fail to find unequivocal evidence of “fear” in subjects responding under avoidance procedures, and (2) studies regularly find that avoidance responding persists for long periods even though subjects never contact the aversive stimulus. This latter effect is evident when, for example, extinction is arranged for avoidance responding.

Unsignaled avoidance responding is notoriously slow to extinguish, in part because an individual who is efficient at avoidance responding never contacts the aversive stimulus either prior to or during extinction. Therefore, it is impossible to discriminate between the negative reinforcement and extinction conditions. This difficulty can be overcome by presenting the aversive stimulus regardless of whether or not the behavior that previously was an effective avoidance response occurs.

Because of the difficulties that molecular explanations of avoidance conditioning pose, molar, or one-factor, alternatives have been offered. The essence of these theories is that behaviors need not have immediate consequences to be strengthened by negative reinforcement, but need only produce a detectable reduction in the overall frequency of exposure to the aversive stimulus. Therefore, hypothesized fear produced through respondent conditioning is not necessary for unsignaled avoidance conditioning to occur.

Although the relative merits of various one- and two-factor explanations of avoidance responding have been debated for decades, and alternatives to both approaches have been offered, there is no general agreement as to which theory of avoidance conditioning is best. With respect to clinical applications, the matter is not of crucial importance, and the primary virtue of the debate has been in fostering a wealth of laboratory studies of avoidance conditioning.

III. APPLICATIONS AND EXCLUSIONS

Negative reinforcement is important clinically in two regards. First, procedures that involve negative reinforcement may be systematically arranged to strengthen desired behaviors of clients. Second, negative reinforcement may play a role in the genesis and maintenance of undesired behaviors. Therapeutic procedures that involve the direct (contrived) arrangement of negative reinforcement have not been used as often as procedures involving positive reinforcement because of the ethical considerations involved in presenting unpleasant stimuli to clients, just so those clients can learn appropriate behaviors that allow them to escape or avoid these stimuli.

More often than they arrange contrived negative reinforcement, therapists help clients to understand the role of negative reinforcement in controlling their own troublesome actions in naturally occurring aversive situations and assist such clients in developing appropriate escape and avoidance responses. For instance, many teenagers engage in risky behaviors (e.g., drinking and driving) in part to avoid criticism and ridicule from peers. A therapist may help the teenager by pointing out less dangerous response options (e.g., staying away from situations where risky behavior is encouraged and peers who encourage it) that also are effective avoidance responses.

Interestingly, as Brain Iwata points out in an excellent 1987 review, negative reinforcement appears to play a generally unrecognized role in a number of procedures generally construed as "positive." For example, an educator may arrange consequences such that (a) a student's incorrect responses to problems result in statements of disapproval or remedial trials and (b) correct responses lead to praise. The educator assumes that improvements in the student's performance occur because praise is a positive reinforcer. Although positive reinforcement may contribute to the improvements, correct responses may also be strengthened because they allow the student to avoid aversive statements (of disapproval) and repetitions of an unpleasant task. That is, negative reinforcement may play an important but unrecognized role in producing the treatment gains.

Similarly, a therapist may think that positive reinforcement stemming from social interaction is responsible for a married couple's self-reported completion of an instruction to spend a half-hour of quiet time alone each evening. Instead, negative reinforcement in the form of avoiding the therapist's disapproval may be responsible for the couple's inaccurate report that they

spent time together. In truth, unintended negative reinforcement is very common in therapeutic settings, as in everyday life.

Even though negative reinforcement is common, clinicians should be cautious about its use because of the potential for engendering negative emotional responding, aggressive behavior, and escape from or avoidance of the situation in which negative reinforcement occurs. In these regards, negative reinforcement is similar to punishment, and the two often are considered together as aversive and relatively restrictive (harmful) strategies for changing behavior. For example, throughout his long life the eminent behavioral psychologist B. F. Skinner argued against the use of both punishment and negative reinforcement in clinical settings and in general society, although he recognized their ubiquity. Similarly, Murray Sidman (1999) considers procedures based on negative reinforcement as well as punishment "coercive" and advocates nonaversive alternatives to them wherever possible. These views are shared by many therapists as well as theoreticians.

Issues of client diversity bear on the use of negative reinforcement primarily when clients who are unable to make informed choices regarding their own treatment are concerned. For example, children and people with substantial intellectual impairment require special protections with respect to aversive interventions, including punishment and contrived negative reinforcement. In brief, a clear decision-making process regarding the use of negative reinforcement should be in place. This process should recognize that negative reinforcement is a restrictive (harmful) intervention and adhere to the doctrine of the least restrictive alternative intervention, which states that other, less restrictive interventions must be evaluated and found ineffective before negative reinforcement is considered.

Clear guidelines must be established regarding the exact nature of the negative reinforcement procedure, including who is to implement it and the specific standards of accountability. Input from clients and client's advocates, as well as behavior-change experts, should play a crucial role in determining treatment details, including who is to arrange negative reinforcement and how its effects are to be monitored. Unambiguous rules regarding the behavioral data that will support continuation, modification, and termination of the negative reinforcement procedure must be established by a vigilant, expert, and caring treatment team before treatment is implemented. These rules must be followed unless the good of the client dictates otherwise in the

opinion of the team. When possible, negative reinforcement should be avoided entirely.

IV. EMPIRICAL STUDIES

Relatively few clinical studies have evaluated interventions that involved intentionally arranging aversive stimuli that clients could escape or avoid by emitting appropriate behaviors. Most of the studies that have appeared involve clients with mental retardation, although other client populations (e.g., people with schizophrenia, children and adults with no diagnostic label) have been studied. Several different target behaviors (e.g., slouching, naming pictures, recognizing objects, approaching adults, speaking appropriately, solving math problems, stretching burned joints, sitting quietly during dental procedures) have been increased through escape and/or avoidance conditioning. A variety of aversive stimuli have been used, including electric shock, unpleasant noises, dental procedures, and required work or exercise. Clearly, procedures that involve systematically arranging aversive stimuli that clients can escape or avoid can be effective in generating appropriate behavior. Unless, however, those stimuli are only mildly aversive and generally accepted as part of the client's everyday world (e.g., requiring a student to work on math during a study session, unless the assignment was completed during math class), the use of such procedures is widely restricted. Moreover, too little work has been done with specific procedures to allow for general statements regarding the costs and benefits of specific interventions based on negative reinforcement relative to alternative interventions.

In recent years, behavioral psychologists have emphasized that an important early step in the treatment of many troublesome operant behaviors is isolating the reinforcers that maintain those behaviors, as well as any events that reliably precede them. The term functional assessment refers to a variety of procedures used to identify important environmental variables that maintain behavior. Functional assessment provides a basis for developing rational interventions that directly address the causes of the troublesome behavior. As noted previously, naturally occurring negative reinforcement can be responsible for a variety of behavioral problems. Once this is recognized, it may be possible to plan effective interventions. Many different interventions have been used to treat troublesome behaviors maintained by negative reinforcement; we will make no

attempt to review this extensive literature. Instead, we will describe a single intervention strategy for dealing with inappropriate escape/avoidance responses.

This strategy involves teaching clients an appropriate alternative to inappropriate behaviors. It is exemplified by functional communication training, an intervention developed by Edward Carr and Mark Durand. This procedure has proven effective in reducing a variety of inappropriate behaviors acquired because they historically produced reinforcement. As a case in point: a student with a developmental disability may have learned to scream and strike out during demanding academic tasks because doing so terminated the tasks. Functional communication training involves arranging conditions so that the inappropriate behavior no longer produces reinforcement (i.e., extinction is arranged) and teaching the person an appropriate communication response that allows the individual to escape the aversive situation. For instance, the student in our example might be taught to raise a hand to "request help" with aversive schoolwork rather than to engage in disruptive behavior. The value of functional communication training and similar interventions has been demonstrated in a number of published studies.

Strategies that involve reducing the aversiveness of the situation that a client historically has escaped or avoided by emitting an undesired response also can be effective in reducing troublesome behavior. For example, a 1999 study by Jennifer Asmus and her colleagues determined through functional assessment the variables that influenced the problem behavior of children during academic tasks. The results were idiosyncratic for each child, but relevant variables included the novelty of the task, the person administering the task, and the setting in which the task was conducted. In a similar vein, Richard Smith and his colleagues reported in 1999 that task variables such as rate of presentation of demands, task novelty, and duration of task affected the rate of problem behavior. Any of these task variables could be altered to decrease the aversiveness of the instructional situation without diminishing educational opportunities. Typical interventions might involve interspersing easier tasks with more difficult tasks, altering the task to match the student's current performance level, decreasing initial task requirements, and allowing additional time to complete difficult tasks. Such interventions should serve as establishing operations, reducing the effectiveness of escape or avoidance of academic tasks as a negative reinforcer and reducing the probability of occurrence of responses that historically have produced this outcome.

The clinical literature regarding negative reinforcement is neither extensive nor focused. Brian Iwata contends that further research in the area is warranted, and he suggests three interesting directions for it to take:

First, negative reinforcement may provide an alternative means for establishing behavior when attempts to use positive reinforcement fail... If so, we will want to know the behaviors for which specific contingencies are useful and the conditions under which they should be applied. Second, it appears that the acquisition of adaptive behavior in our training programs is at least partially a function of negative reinforcement. Further research must evaluate the roles of escape and avoidance within the training context so that (a) we will have a proper estimate of the effectiveness of commonly used positive reinforcers (the results of this estimate may indicate that more potent reinforcers are needed), (b) we can determine whether procedures such as remedial trials, physical assistance, and so on, serve any useful function and if that function is one of negative reinforcement, and (c) we can base future training successes on the planned rather than the accidental use of negative reinforcement. A third promising application involves further elaboration of behavioral replacement strategies. If we are willing to entertain the assumption that it is impossible to eliminate all sources of aversive stimulation, the use of such stimulation to alter the topography of escape and avoidance behavior, from an undesirable one to a tolerable one, makes eminent sense from a clinical standpoint.... As with punishment, we should conduct research on negative reinforcement with great care and under the appropriate conditions to determine how it might be used effectively and humanely, its limitations, and its proper role within the larger realm of currently available treatment. (1987, p. 78)

Negative reinforcement may well be coercive and unappealing, but it is also ubiquitous. Better understanding of its role in the genesis and maintenance of behavior disorders, and of its current and ideal role in treating those disorders, can only benefit psychologists and their clients.

V. CASE ILLUSTRATION

A study published by Nathan Azrin and his colleagues in 1968 provides a clear example of the logic of negative reinforcement. They treated postural slouching in 25 adults through the use of an automated device that detected slouching and, when it occurred, produced an audible click followed three seconds later by

a loud tone. The click and tone could be avoided by standing upright (not slouching), and escape from the tone could be effected by standing upright after the tone had started. This procedure reduced slouching in all clients exposed to it. The aversive stimulation that they received was mild, and they agreed to its appropriateness. These factors helped to make negative reinforcement an acceptable intervention.

A study published in 1986 by Hegel, Ayllon, Vanderplate, and Spiro-Hawkins provides an excellent example of the therapeutic use of negative reinforcement in another kind of situation, one in which a necessary medical procedure caused pain. The clients treated were three men who were recuperating from extensive burn wounds in a hospital. As part of their rehabilitation, they were required to stretch burned joints to increase and maintain flexibility. The stretching, which was initially arranged as part of mandatory staff-directed physical therapy sessions held each day, was quite painful. None of the patients showed increased range of motion in the burned joint during the period of staff-directed physical therapy. Range of motion increased substantially in all of them in a subsequent condition, where staff-directed physical therapy sessions could be avoided by engaging in sufficient self-directed exercise to meet daily goals. If the client failed to meet a daily goal, he was required to participate in staff-directed exercise. Thus, self-directed exercise was maintained by negative reinforcement in the form of avoidance of staff-directed physical therapy. Although the exercise undoubtedly was painful, no alternative would produce the same long-term benefits for the client. Unfortunately, aversive situations and activities are sometimes an intrinsic part of the human situation.

VI. SUMMARY

Negative reinforcement, one of the basic principles of operant conditioning, is evident when behavior is strengthened because its occurrence results in the termination or avoidance of aversive stimuli. The technique is important clinically in two general ways. First, negative reinforcement can be responsible for the development and maintenance of both healthy and pathological behaviors. Knowing this can help therapists understand and, more importantly, develop effective interventions for their client's troublesome behaviors. Second, procedures that involve negative reinforcement can be systematically implemented to strengthen

the desired behaviors of clients. Ethical and practical considerations place substantial limits on the range of situations where it is appropriate to use negative reinforcement as part of therapy, and whenever it is used due caution and appropriate safeguards are necessary.

See Also the Following Articles

Conditioned Reinforcement ■ Covert Positive Reinforcement ■ Differential Reinforcement of Other Behavior ■ Functional Analysis of Behavior ■ Negative Practice ■ Negative Punishment ■ Operant Conditioning ■ Positive Punishment ■ Positive Reinforcement ■ Reinforcer Sampling

Further Reading

- Catania, A. C. (1998). *Learning*. Upper Saddle River, NJ: Prentice-Hall.
- Crosbie, J. (1998). Negative reinforcement and punishment. In K. A. Lattal & M. Perone (Eds.). *Handbook of research methods in human operant behavior* (pp. 163–189). New York: Plenum Press.
- Iwata, B.A. (1987). Negative reinforcement in applied behavior analysis: An emerging technology. *Journal of Applied Behavior Analysis*, 20, 361-378.
- Michael, J. (1993). *Concepts and principles of behavior analysis*. Kalamazoo, MI: Association for Behavior Analysis.
- Sidman, M. (1999). Coercion in educational settings. *Behavior Change*, 16, 79–88.

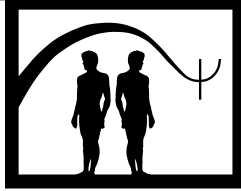

Neurobiology

Douglas S. Lehrer and Jerald Kay

Wright State University School of Medicine

- I. Introduction
 - II. Learning, Memory, and Neural Plasticity
 - III. The Biological Effects of Stress
 - IV. Evidence for the Biology of Psychotherapy
 - V. Conclusions
- Further Reading

GLOSSARY

amygdala A limbic system structure adjacent to the hippocampus that is responsible in part for regulation and valence of emotions (especially fear) and their related somatic expression.

brain-derived neurotrophic factor (BDNF) A molecule that is released by the targets of neurons and that promotes chemical alterations in the neuron responsible for its growth and maintenance.

explicit (or declarative) memory Learned factual knowledge and autobiographical information that requires conscious awareness and intact hippocampus.

glutamate An important excitatory neurotransmitter.

hippocampus The limbic system structure (extremely sensitive to high levels of stress hormones) responsible for significant aspects of both learning and memory.

hypothalamic-pituitary-adrenal (HPA) axis A feedback circuit between the hypothalamus, pituitary, and adrenal gland that regulates the release of glucocorticoids or stress hormones such as cortisol.

implicit (or nondeclarative) memory Nonconscious simple learning that although out of a patient's awareness, often has significant impact on behavior and perception.

neuronal plasticity The capacity of the central nervous system to strengthen and create neural connections (neurogenesis).

positron emission tomography (PET) A functional neuroimaging technique employing radioactive tracers that can demonstrate activation of brain regions through measurement of blood flow.

selective serotonin reuptake inhibitor (SSRI) A group of antidepressants that increase levels of the neurotransmitter serotonin in the synaptic cleft by impeding its degradation.

working memory A type of short-term memory, often referred to as the "blackboard of the mind," most often anatomically associated with the prefrontal cortex, that facilitates moment to moment perception, information processing, and explicit memory retrieval.

I. INTRODUCTION

Mental disorders and their treatments have long been viewed within a flawed intellectual framework, namely, that mental diseases are either biologically or psychologically based, and that treatment is best conducted with biological or psychotherapeutic tools, respectively. Many mental health professionals have adopted this view, as has an insurance industry that has often enforced criteria whereby treatment for "biological" illnesses (such as schizophrenia or bipolar disorder) is reimbursed while the treatment of "psychological" maladies (dysthymia or personality disorders, for instance) are less well supported. The very nature of professional

practice has been affected, with a dramatic reduction in the number of hours that psychiatrists or hospital-based (and sometimes community-based) nonpsychiatric clinicians spend in the performance of psychotherapy. Combined treatment with psychotherapy and medication, although a common practice, founders within this theoretical quagmire, often leaving practitioners without a logically consistent theoretical framework in which to skillfully and rationally deliver treatment.

This conceptual dichotomy is indeed ironic and unfortunate, for a careful review of the remarkable contributions from the neurosciences and cognitive psychology describe a very different intellectual framework, one in which psychology and biology are indistinguishable, and in which mental disturbances may be understood simultaneously on both levels in a heuristically harmonious manner. As Nobel laureate Eric Kandel asserted, “all mental processes, even the most complex psychological processes, derive from operations of the brain.” However, elucidating the neurobiological correlates of mental processes should not preclude the patient’s need for the psychotherapist to appreciate their unique meaning.

In this article, we will attempt to explain the relation of biology to psychotherapy. Current knowledge about certain critical brain functions, particularly learning and memory, which form the basis for our understanding of the biology and cognitive psychology of all psychotherapies, will be reviewed. We will discuss the remarkable capacity of the brain to adapt to environmental changes, expressed in the construct of neural plasticity and findings related to new cell growth in the adult brain, followed by a brief review of the effects of stress on the brain. Finally, we will conclude by offering evidence that psychotherapy does indeed exert measurable biological effects in the brain, findings that may ultimately guide therapeutic decision making.

II. LEARNING, MEMORY, AND NEURAL PLASTICITY

A. Phenomenology of Memory

Memory is not a unitary function of the brain. Indeed, memory can be categorized into at least two major functional and neurobiological categories, namely, explicit (or declarative) memory and implicit (or nondeclarative) memory. Explicit memory refers to factual knowledge such as place, people, things, and autobiographical information. Working memory is one variety of explicit memory that is distinct from long-

term explicit memory. Working memory refers to the short-term memory that facilitates active, conscious perceptual attention and initial processing of information, and later permits the purposeful retrieval of stored explicit memories. Implicit memory refers to the non-conscious effects of past behavior, and involves a heterogeneous set of abilities and knowledge, such as (1) associative learning (classical and operant conditioning); (2) procedural memory (learned skills and habits); (3) sensitization and habituation (exaggeration or attenuation, respectively, of behavioral responses to specific environmental stimuli); and (4) priming (enhanced recall aided by prior exposure to related stimuli, such as words or objects). In other words, and perhaps more germane to our understanding of psychotherapy, implicit memory refers to those past experiences that influence our current behavior even though we do not consciously remember them. Implicit memories form the rules that govern the interpretation of later life experiences. Because implicit knowledge is not readily available for conscious reflection, these rules self-perpetuate, even in the face of new life experiences that might demand a different (and more adaptive) perceptual bias.

As we might expect, there is an interaction between explicit and implicit memories that is utilized in psychotherapy. Implicit biases are examined and made explicit, creating an opportunity for conscious processing, reflection, and new experiences, hopefully leading to an adaptive change in the implicit memory system. To be more specific, the phenomenon of transference is understandable, for example, in light of the repetition of specific behaviors and beliefs that are governed by early experiences encoded in both implicit and explicit memories. In psychoanalytic psychotherapy, distortions that characterize transference within the doctor–patient dyad as well as throughout all sectors of a patient’s interpersonal world can be examined and interpreted within a safe, nonjudgmental, and empathic new relationship.

It is worth pointing out that this discussion of memory, particularly as it applies to our understanding of psychotherapy, is by necessity simplistic. Most notably it neglects the phenomenon of consciousness, the neurobiology of which would justify an entire article. (For such a treatise, please see the reference to Regina Pally’s work in the Further Reading section.) Consciousness, most often defined simply as awareness, probably represents a complex interaction between multiple brain functions and regions in the cortex and brain stem (at a minimum). Although a full elaboration of these systems and

relationships is beyond the scope of this article, several points of relevance to psychotherapy are worth mentioning. If conscious perception is the product of the shaping influences of our conscious belief systems on environmental reality, then we may resist not only unconscious material, but the conscious as well if it conflicts with our belief systems. Yet the essential function of consciousness is, according to Pally, to “provide ... a means by which we notice changes and can flexibly choose the most adaptive response to that change.” This is true of changes in the environment, as well as changes in our responses to those environmental events. Therefore, we simply cannot appreciate the processes of learning, growth, and therapeutic change without accounting for the role of conscious self-reflection.

Similarly, this article cannot address the broad field of human development as it relates to learning and memory. Questions about the relative stability versus alteration in these mechanisms at different stages in the individual's life cycle clearly have implications for clinical intervention as well as general understanding of learning and memory. This is a critically important area for further study.

B. Functional Neuroanatomy of Memory

An abundance of experimental data (human and animal, lesion and brain imaging studies) indicate that explicit and implicit memory depends on different brain structures and systems. Explicit memory relies on intact medial (i.e., inner surface) temporal structures, including the hippocampus, parahippocampal gyrus, and the entorhinal and perirhinal cortices, as well as association areas in the neocortex. New facts and event information are first processed in the association areas of the frontal, temporal, parietal, and occipital lobes. Working memory in particular relies on regions of left frontal lobes such as the prefrontal cortex. From the association cortices, information is conveyed to the parahippocampal and perirhinal cortices, and then to the entorhinal cortex, hippocampus, and adjacent structures (Fig. 1). Taken together, these steps represent the encoding and consolidation steps of memory formation. The specific functional tasks of each area remain unclear, and current investigations are under way to clarify the distinct roles. For example, the parahippocampal gyrus may support the encoding of information about the occurrence of an item, whereas the hippocampus may support the encoding of relationships between the item and its context.

The newly formed explicit memories return through the aforementioned systems back to the association cortices where long-term storage occurs. The fact that storage occurs in the association cortices explains why people and experimental animals that have bilateral lesions of the medial temporal lobes that damage the hippocampus are relatively unable to form new explicit memories but can recall previously stored (prelesion) knowledge. There is no single cortical storage area. Knowledge is distributed throughout the neocortex and is “reconstructed” into a single data set during the retrieval process.

The functional neuroanatomy of implicit memory, taken as a whole, is somewhat less well defined than that for explicit memory, in part because of the heterogeneity of cognitive phenomena collectively grouped as implicit memory, but also due to methodological problems involved in the study of implicit memory (preventing the “contamination” of implicit memory processing with conscious or explicit memory activation). However, it is fairly clear that the striatum, a component of the basal ganglia (a system of several nuclei, or functionally related collections of neurons, located deep within the cerebral hemispheres) is involved. The striatum actually includes several discrete nuclei: the caudate, putamen, and ventral striatum. The striatum plays a role in a variety of brain functions, including cognitive functioning, mood regulation, and motor and nonmotor behaviors. As with explicit memory, various areas of the neocortex are also involved with implicit memory.

Another brain structure of paramount importance to memory function, especially as it relates to our understanding of trauma and psychotherapy, is the amygdala. The amygdala sits in the anterior temporal lobe, just in front of the hippocampus. It plays a central role in the regulation of emotions, including the mediation of conscious emotional feelings (such as fear) with related somatic expressions (autonomic and motoric expressions). Electrical stimulation of the amygdala in humans results in feelings of fear and apprehension. Rare bilateral lesions of the amygdala disrupt the ability of the individual to apprehend fearful facial expressions and discern other fear cues in the environment.

The amygdala is involved in the encoding and consolidation of emotion-laden explicit and implicit memories. Emotional arousal activates the amygdala, resulting in the modulation of other memory regions influenced by the amygdala, thus regulating the strength and persistence of affectively charged memories. Larry Cahill, James McGaugh, and colleagues at the University of California, Irvine, have performed a

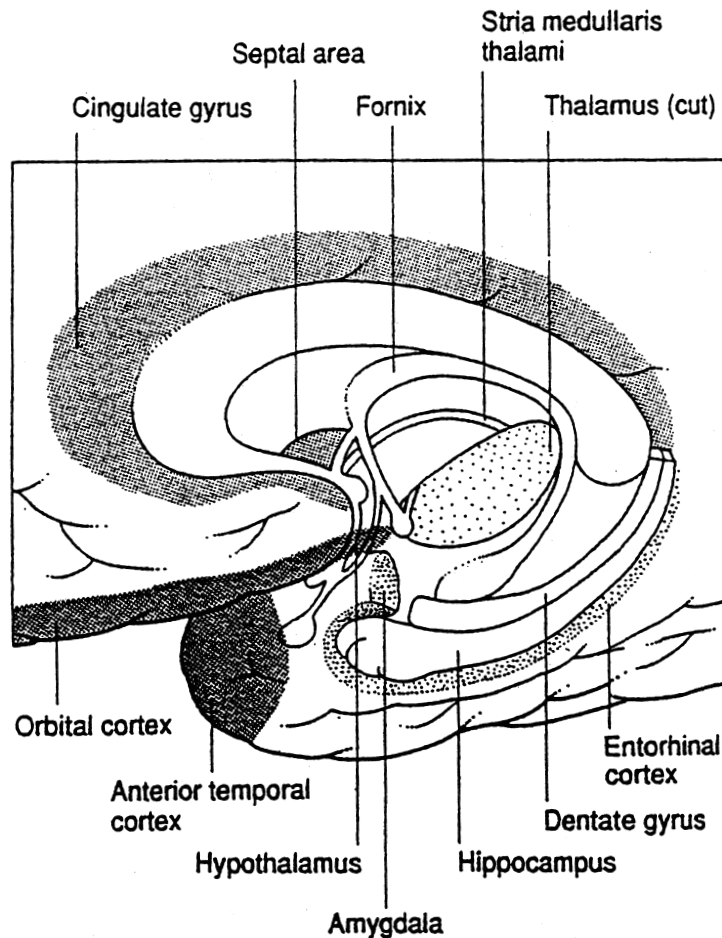

FIGURE 1 Medial view of cortical and subcortical limbic areas. From Fitzgerald (1992). "Neuroanatomy: Basic and Clinical," 2nd ed., W.B. Saunders Co.

number of experiments that demonstrate this phenomenon. For example, they showed emotionally neutral and emotionally arousing film clips to healthy volunteers who then underwent a functional brain imaging study (fluorodeoxyglucose positron emission tomography, or FDG PET) designed to demonstrate relative activation of various brain regions. The amygdala activated during viewing of the arousing films, but not the emotionally neutral clips. Later, the subjects were better able to recall the arousing clips, with the degree of amygdala activation correlating with the degree of recall.

The amygdala's memory role is therefore a selective one, with little involvement in the absence of emotional arousal. Furthermore, the amygdala is involved

only in memory encoding and consolidation (prestorage activities), not retrieval.

C. Cellular Mechanisms of Learning and Memory: Neural Plasticity

We have reviewed known elements of how the brain, as a collection of macroscopic brain regions, obtains and retains new knowledge. But how do the actual individual functional units of the brain, that is, the nerve cells (or neurons), facilitate these changes?

Neurons communicate with one another through a process of chemical signaling known as neurotransmission. An impulse (action potential) traveling down the outbound fiber (axon) of a neuron reaches its terminus

at the juncture between the signaling neuron and another nerve cell. This juncture is known as the synapse. The synapse may impinge on the body of the target neuron, or on one of its projections (an axon, or an inbound fiber, or dendrite). At the synapse, the “upstream,” or presynaptic neuron releases chemicals (neurotransmitters) into the synaptic space. The neurotransmitter diffuses across the space and comes into contact with special proteins (receptors) imbedded in the outer membrane of the “downstream” (postsynaptic) neuron. When the neurotransmitter interacts with the receptor in a chemical “lock-and-key” fashion, an excitatory or inhibitory effect is exerted on the postsynaptic neuron. The intended action of the signaling neuron is thus accomplished.

We now know that the brain possesses a remarkable capacity for structural change throughout the life cycle. This idea was first articulated in 1911 by the neuroanatomist Santiago Ramon Y Cajal, who postulated that repeated behavior must cause the neuron’s dendrites and axons to undergo structural changes, revising the preexisting pattern of neuronal interconnections. In other words, learning is the product of new or enhanced connections between nerve cells. The neurophysiologist Donald Hebb experimentally demonstrated this phenomenon in 1949, resulting in what has become known as “Hebb’s Rule.” Hebb wrote: “When an axon of cell A ... excites cell B and repeatedly or persistently takes part in firing it, some growth process or metabolic change takes place in one or both cells so that A’s efficiency as one of the cells firing B is increased.” Hebb asserted that this change is the result of a strengthening of the connections between neurons. This phenomenon is known as neural (or neuronal) plasticity, and represents the process whereby learning experiences are physically encoded.

Eric Kandel was awarded the 2000 Nobel Prize in Physiology or Medicine for demonstrating the molecular mechanisms of this process in the marine sea slug (*Aplysia californica*), an invertebrate with a relatively simple nervous system consisting of about 20,000 nerve cells. The structural simplicity of *Aplysia*’s nervous system facilitated Kandel’s demonstration of the mechanisms of implicit learning. A mild touch of the animal’s siphon (a structure used to expel waste and seawater) normally elicits a reflexive withdrawal of its gill and siphon. This reflex is known as the gill-withdrawal reflex. Repeated stimulation of the reflex leads to habituation, or attenuation, of the reflex. On the other hand, the administration of a noxious stimulus to its tail produces a sensitization, or exaggeration, of the

reflex. Briefly repeated trials of either kind of stimulus lead to a change in the reflex that is relatively short-lived (i.e., lasting minutes). However, the administration of four or five series of stimulations administered periodically over hours results in a change that lasts from days to weeks. Therefore, habituation and sensitization have short- and long-term forms. Kandel discovered that short-term habituation and sensitization result from a decrease or increase, respectively, in the amount of neurotransmitter released into the synapse (in the case of *Aplysia*, the connection between the sensory neuron bringing information about the stimulus and the motor neuron that mediates the withdrawal reflex). Importantly, although the exact mechanism of this alteration is unclear, changes in protein synthesis do not appear to be necessary.

Long-term alterations in the reflex were observed after repeated stimulus applications. It is noteworthy, although of little surprise to many behavioral scientists, that spaced training (small amounts of training spaced over many minutes or hours) produced substantially greater behavioral alterations than did massed training (a lot of training all at once). Long-term alterations were facilitated by changes in gene expression and the protein-manufacturing apparatus of the cell. This cascade of molecular events described by Kandel and subsequent investigators can be simplified as follows.

During repeated stimulation, a neurotransmitter known as glutamate accumulates in synapse. Activation of a subtype of the glutamate receptor, the so-called NMDA (*N*-methyl-D-aspartate) receptor, opens membrane channels that permit the entry of calcium into the neuron. In the interior of the cell, calcium triggers a series of enzymes (adenylate cyclase and protein kinases) to initiate gene expression in the nucleus of the cell. The activated genes encode proteins important for the regulation, growth, or elimination (pruning) of synaptic connections. When the cell’s protein synthesis apparatus is turned on, and regulatory or structural proteins are manufactured, new receptors or synaptic sites are created, or existing ones functionally or physically eliminated. The ultimate result is a long-term change in synaptic excitability, effectively altering the way in which the brain’s circuitry responds to later stimulation.

Evidence for anatomical changes in the brains of stimulated individuals is found in the work of Anita Sirevaag and William Greenough, who during the 1980s showed that different rearing conditions affect brain structure. Rats raised in a complex toy-rich environment showed indications of enhanced brain development compared to rats raised in isolated, uninteresting

conditions. Specifically, the stimulated rats' brains had a greater density of synaptic nerve endings (boutons), higher volume of dendrites per neuron (more complex branching, implying more neuron-to-neuron communication), and more support structures, indicating more active neuronal activity (more blood vessels, for instance).

The individual genetic traits of an individual modulate the robustness of the plastic cellular adaptations. For instance, Joe Tsien and colleagues at Princeton University bred a genetic strain of mouse (dubbed "doogie the supermouse") in which the postsynaptic NMDA receptor density was intentionally increased (overexpressed). Compared to unaltered control mice, the mutant mice showed superior abilities in learning and memory in various behavioral tasks, as would be predicted by the neural plasticity model.

D. Neurogenesis

In addition to the above scenario, another mechanism may explain the remodeling of the nervous system in response to life experiences. Until the 1960s, neuroscientists had long believed that the adult brain was incapable of generating new neurons. In 1965, Joseph Altman at MIT described the production of new neurons in the brains of adult rats. Inexplicably, little work was done to further the study of the remarkable phenomenon of neurogenesis until the past decade or so, when several investigators resumed work on this critically important area of neuroscientific study. Elizabeth Gould of Princeton University has studied factors that appear to regulate neurogenesis in various animals, including primates. One of the most important findings was that neurogenesis is stimulated by environmental complexity and learning. Experimental training activities resulted in increased formation of adult-generated nerve cells (granule cells) in the black-capped chickadee. Training conditions also enhanced the survival of those cells. Conversely, conditions of deprivation reduced the generation and survival of new cells. Another important finding was that adrenal hormones, normally released in greater quantity during times of stress, suppresses the formation of precursor cells. We will discuss other effects of stress on the brain later in this article.

Even after neurogenesis was demonstrated in a wide variety of animals, the scientific community was resistant to accept that neurogenesis occurs in humans. That changed when Fred Gage and his colleagues at the Salk Institute for Biological Studies in La Jolla, California,

studied the postmortem brains of cancer victims who had received a dosage of a diagnostic drug called bromodeoxyuridine (BrdU) before they died. BrdU is incorporated into the DNA of dividing cells and can be used as a marker for dividing and newly formed cells in the body. Gage found BrdU-containing cells in the studied brains, conclusively establishing that adult humans grow new neurons. Of great significance to our topic, the new cells were found in the hippocampus, already shown to be essential to learning and memory.

Last, although the exact mechanisms that regulate neurogenesis are still undetermined, existing work gives us every reason to believe that neurogenesis, like neural plasticity, results from interactions between experience and genes. Indeed studies by Liu and colleagues support that early life experiences can profoundly determine both brain structure and function. For example, high levels of maternal rat behavior promote hippocampal synaptogenesis, enhance memory and learning in adult offspring, and increase both NMDA receptors as well as brain neurotrophic factors that play a central role in the growth and maintenance of neurons. Conversely, rats experiencing maternal separation early in their postnatal development have decreased brain neurotrophic factors (BDNF) and in the presence of elevated levels of stress hormones that accompany acute stress, are unable to modulate BDNF as are sibs who are not separated from their mothers.

E. Implications

The implications of these findings about the biology of learning and memory are indeed broad. We now have an elegant scientific framework with which to understand the interaction between genes and environment. These models give us an idea why different individuals, with diverse genetic "blueprints," may respond to nearly identical environmental circumstances in strikingly different ways, including why some trauma victims may develop posttraumatic stress disorder (PTSD) whereas others survive with little detriment to their mental health. It also helps us to understand why identical (monozygotic) twins (with identical genetic content, but different life experiences) may have such divergent personal features. For example, we know that a monozygotic twin of an individual with schizophrenia—a mental disorder considered to be highly "genetic"—has no more than a 50% chance of developing the disease. Life experiences, through the previously described (and related) mechanisms, determine whether genetic predispositions and vulnerabilities are

realized, or whether they remain latent throughout our lives.

In the case of depression, Kenneth Kendler studied more than 2100 female twins over 17 months. The probability for those twins at lowest risk for major depression increased from 0.5% to 6.2% and those at highest risk from 1.1% to 14.6% if a twin had experienced stressors such as a recent death, assault, marital problems, and divorce or separation. David Reiss' work with more than 700 multiconfigured families has demonstrated that when a parent differentially and persistently relates to one adolescent in a conflictual or negative manner, nearly two thirds of the variance in the teenager's antisocial behavior and one third in his depressive symptomatology can be accounted for by the conflicted parent-child relationship. Life experiences through the previously described (and related) mechanisms determine whether genetic predisposition and vulnerabilities are realized, or whether they remain latent throughout our lives. Moreover, recent research appears to support the possibility that psychotherapy and medication may share salutary effects through moderating the genetic effects of those with vulnerable phenotypes.

III. THE BIOLOGICAL EFFECTS OF STRESS

Most people who seek psychotherapy, or any mental health treatment for that matter, do so during times of increased subjective life stress or following a highly stressful, even traumatic, life experience. Psychosocial stress has long been recognized as a major contributor to the onset of mental disorders and to the recurrences or exacerbations of those maladies. For that reason, any attempt to understand the neurobiology of psychotherapy requires some understanding of the biological effects of stress.

Biologists have long been fascinated by the natural phenomenon of animal population crashes. Typically, environmental conditions favoring the exponential growth of a particular species' population results in intra- and interspecies competition for food and mates, and territory. When the population exceeds the carrying capacity of the environmental niche, vast numbers of the affected community die, sometimes losing 90% or more of its members within a very short period of time. Examinations of population crash victims typically reveal multiple organ abnormalities, including enlarged adrenal glands—the small hormone-producing organs that sit on top of each kidney and secrete adren-

alin (also known as epinephrine) and corticosteroids. These substances are known collectively as the body's stress hormones.

Using less dramatic experimental and naturalistic research designs, many investigators have explored the consequences of stress in animal and human nervous systems. These investigations demonstrate that stress is associated with disruption or alteration of various mechanisms involved in learning and memory, and presumably, adaptation. We will illustrate this point with a description of selected findings.

A. Studies of Care-Related Stress

Stephen Suomi performed a series of experiments with rhesus monkeys that shed light on the interaction between genetic vulnerability, stress, and potentially corrective experiences. He first observed that infant monkeys separated from their mothers developed social anxiety-like behavioral responses. They were later reared by peers raised by the subject monkey's own mothers. The peer interaction resulted in some amelioration of the behavioral disturbance, but the subject monkeys remained prone to a return of the behavioral disturbance when placed in novel or stressful circumstances, accompanied by high levels of stress hormones (see later discussion). Suomi then observed that a minority of monkeys that were raised by their own mothers showed exaggerated separation disturbances that were similar to those shown by the original subject monkeys. This latter group of disturbed monkeys was placed in the care of highly nurturant foster monkeys. The change in rearing resulted in the relief of behavioral problems. But more surprisingly, the offspring that were "adopted" by the "supermothers" went on to rise to the top of the colony hierarchy, implying that the constitutional sensitivity of these monkeys was preserved in a way that conferred an attunement to the needs and cues of the colony, allowing them to respond in a socially adaptive and successful manner.

A more dramatic example of the deleterious effects of separation (without subsequent surrogate caregiver nurturance) can be found in René Spitz's historic study of infants of unwed mothers placed in foundling homes in the 1940s. In order to reduce infection risk to the infants, handling was kept to a minimum, and the infant's view of caregivers' faces was blocked by masks and sheets. Despite receiving sufficient nutrition and an attractive physical environment, almost all of the infants died or developed mental retardation within 1 to 2 years. Spitz contrasted this to the healthy,

normal outcomes of children raised by their mothers in a squalid prison environment. He concluded that nurturant human contact was as essential for growth and survival as was food and sanitary conditions.

Rosenblum and Andrews studied infant monkeys raised by either normal mothers or by mothers made anxious by an unpredictable feeding schedule. The monkeys with anxious mothers demonstrated social impairment and biochemical abnormalities (serotonin and norepinephrine abnormalities). Interestingly, the changes did not appear until adolescence, lending credence to clinical observations that early environmental disturbances may have long-ranging effects that do not manifest until later in life.

B. Role of Stress Hormones

The stress hormones have been an important focus of stress response studies. For the purposes of this discussion we will focus on the most important of the stress hormones—the category of corticosteroids known as the glucocorticoids—exemplified by cortisol. The glucocorticoids are involved in immune function and a number of other physiological processes as well as the stress response. Glucocorticoid release is regulated by a homeostatic feedback mechanism involving the hypothalamus, pituitary gland, and the adrenal glands (the hypothalamic-pituitary-adrenal, or HPA, axis). Many studies have examined the role of the HPA axis during stress, showing that glucocorticoid concentrations (and the levels of other brain chemicals that stimulate glucocorticoid production and release, such as adrenal corticotropin hormone [ACTH] and corticotropin releasing hormone [CRH]) go up during times of brief or prolonged stress. Elevated glucocorticoid levels are found in laboratory animals separated from their mothers or social groups, or otherwise placed in stressful conditions. Stress-related human cortisol elevations were demonstrated as long ago as the Korean War, when urinary cortisol levels of soldiers under random artillery bombardment were higher than during periods away from the battle zone.

The hippocampus, equipped with a high density of glucocorticoid receptors, is the principal target location in the brain for the glucocorticoids. The hippocampus is also an important inhibitory regulator of the HPA. Under conditions of modest stress, a resultant facilitation of hippocampal plasticity appears to enhance cognition. This is consistent with the observation that people tend to perform better when mildly or moderately challenged. However, major or prolonged stress

produces sustained high levels of glucocorticoids that seem to have deleterious effects in the brain, including cell loss. The mechanisms of glucocorticoid-mediated harmful effects are unclear, but may involve inhibition of the chemicals inside the neuron that turn on gene transcription and protein synthesis. The consequences may include inhibition of neural plasticity (with reduced dendritic branching and alterations in synaptic structure) and/or neurogenesis, a decreased rate of new neuronal survival, and actual neurotoxicity with permanent cell loss (i.e., a direct lethal effect on hippocampal neurons, possibly through mechanisms involving the neurotransmitter glutamate, resulting in activation of programmed cell death processes known as apoptosis). Animal studies and human brain imaging studies have demonstrated atrophy (shrinkage) of the hippocampus (and to a lesser extent, other brain regions) during prolonged periods of stress. As well, enduring hormonal changes throughout the life of an animal subjected to early maternal separation have been demonstrated. More will be said about the role of the HPA axis in depression and PTSD later in this article.

IV. EVIDENCE FOR THE BIOLOGY OF PSYCHOTHERAPY

In this section we will review present evidence that psychotherapy is a powerful tool that exerts its effects by changing the structure and function of the brain. Before presenting that evidence we will briefly describe background material regarding brain imaging methods, findings related to the biology of human emotions, and comments regarding the biology of personality.

A. Brain Imaging

It is beyond the scope of this chapter to attempt even a modest brain imaging primer. However, these tools have permitted the study of cognition and emotion, in normal and pathological states, to an extent that was previously impossible. A very brief description of imaging methods may therefore assist the reader as we subsequently present imaging data that inform the primary subject at hand.

Neuroimaging methods may be separated into structural and functional imaging techniques. Structural imaging methods provide information about the anatomy of the brain but say nothing about its present physiology. Many readers will be quite familiar with the two major structural imaging methods: computed tomography

(CT) and magnetic resonance imaging (MRI). Although CT has many valuable clinical applications, its resolution is inadequate to quantify the structural changes reflective of the processes described in this article. Therefore, research questions about brain structure are generally answered using MRI.

Functional imaging methods are less familiar to most clinicians as they have only recently found a limited role in clinical medicine. For now, their major role is still limited to research. These methods share a common theme: They provide information about the present physiology of the brain. Depending on the method chosen information about the metabolism or blood flow in a specific brain region (reflective of regional brain activity), and receptor and/or neurotransmitter levels, can be acquired. Brain activation studies may be performed under a variety of conditions, including a resting state, or when the subject is engaged in a specific sensory, cognitive, or emotional task. The most common functional imaging tools used to study emotional and cognitive function are positron emission tomography (PET), single photon emission computed tomography (SPECT), both of which involve introduction of a radioactive tracer into the subject's body, and functional magnetic resonance imaging (fMRI).

B. Functional Neuroanatomy of Human Emotions

Functional imaging tools can show us "real-time" information about brain activation during various emotional states and tasks. Eric Reiman performed a series of experiments with normal subjects and sufferers of panic or phobic disorders to characterize the biology emotions using functional brain imaging methods (PET), each constructed around a distinct mental task. His findings indicate that human emotional functioning is highly complex, involving multiple brain regions. To illustrate this point, we will present a selection of his findings.

A group of normal subjects underwent PET imaging while watching a series of silent film clips, some that were emotionally neutral and others that were emotionally arousing. He later performed a similar study using cognitive rather than visual stimuli. Subjects were instructed to recall (rather than view) happy and grievous events. A wide variety of regions again activated during the performance of both emotional tasks. However, when comparing the results of the studies, Reiman was able to make the following generalizations. Limbic areas (the hippocampal formation and amy-

dala) and paralimbic areas (anterior temporal cortex and parahippocampal gyrus) long thought to participate in emotion, while activated in both sets of subjects, were preferentially involved in the response to externally presented (film clips) emotional stimuli. In contrast, a region in the vicinity of the anterior insular cortex was preferentially involved in the response to distressing cognitive stimuli (recalled experiences).

Reiman concluded that the anterior insular region might serve as an internal alarm system, investing potentially distressing thoughts and bodily sensations with negative emotional significance. On the other hand, the anterior temporal region might serve as an external alarm system. Several structures activated in a way that indicated that they serve a general role in emotional response, irrespective of the quality or valence of the emotion. These areas included the thalamus and medial prefrontal cortex, the latter seeming to facilitate conscious experience of emotion, inhibition of excessive emotion, and monitoring of one's emotions in order to make personally relevant decisions.

Louis Gottschalk and Monte Buchsbaum also used PET to study the emotional phenomena of hope and hopelessness. Twelve healthy male volunteers were imaged during a state of silent, wakeful mentation. The thoughts that they experienced during the study were later rated using the "Gottschalk Hope Scale." As with Reiman's subjects, many regions activated during the mental task. The interesting conclusion made by the authors was that the metabolic changes associated with hope and hopelessness had some different regional locations and characteristics, indicating that from a neurobiological standpoint, hope and hopelessness are not simply opposite manifestations of a single emotional phenomenon.

It is too early to attempt a broad neurobiologically based explanation for mood and mood regulation. As can be surmised from the above discussion as well as earlier sections of this article (such as the role of the amygdala), the answer is likely to involve a complex interplay between numerous brain areas. In addition to those already mentioned, the anterior cingulate almost certainly plays a key role. John Allman at the California Institute of Technology has asserted that the anterior cingulate appears to be an area in which functions central to intelligent behavior, such as emotional self-control, focused problem solving, error recognition, and adaptive response to changing conditions, are juxtaposed with the emotions.

Whether mood disorders reflect a primary disturbance of the brain systems that control emotion, or involve dysregulation in other brain systems with secondary

“downstream” disruption of mood regulation, remains to be seen. For additional reading beyond this discussion or that found in Section D later, see the reference to Dennis Charney’s text in the Further Reading section.

C. Personality

If implicit learning is the result of experiential and genetic interactions, we are left to wonder about the biology of personality development. To what extent is personality already genetically directed at birth, versus a series of implicitly learned rules, perceptions, and emotional and behavioral responses? Anyone who has spent much time with infants has certainly observed the striking differences in behavioral responsiveness from one infant to another, yet we still traditionally think of personality as an acquired constellation of personal characteristics.

Robert Cloninger of Washington University has attempted to explain this conundrum with a psychobiological model of personality development. He suggests that personality consists of two independent multidimensional domains that he terms “temperament” and “character.” Temperament consists of four independent dimensions, including novelty seeking, harm avoidance, reward dependence, and persistence. Temperament involves automatic, preconceptual, or unconscious responses to perceptual stimuli, reflective of biases in information processing by perceptual memory systems. Temperamental factors are independently heritable, manifest early in life, and are highly stable over time. The factors may be observed in childhood and predict adolescent and adult behavior.

The dimensions of character are self-directedness, cooperativeness, and self-transcendence, or, respectively, identification as an autonomous individual, integral part of human society, and integral part of the universe. In contrast to temperamental factors, character factors are concept-based and less stable (i.e., more malleable) over time, although genetics may still play a role in character development. Someone low in the first two character traits is, according to the author, likely to suffer a personality disorder. Although the importance of self-transcendence is of questionable value to the person early in life, it takes on great importance during times of death, illness, and misfortune.

This model has implications for the treatment of personality disorders. For instance, it is possible that temperamental factors may be attenuated using certain medications (some of which have already found an effective adjunctive role in the treatment of certain per-

sonality disorder traits). On the other hand, the factors of character may be more productive targets for psychotherapeutic interventions. Clearly more work must be done to test the validity of this construct, particularly as it translates to clinical settings with disturbed individuals.

D. Depression

1. *Psychotherapy versus Antidepressant Medication: Imaging Findings*

Psychotherapy of depression in its various forms is among the most well-validated of all psychological treatments. Yet fundamental questions about which form of psychotherapy to apply, when, to which patient, and whether a depressed person should receive psychotherapy, medication, or both, remain largely unanswered. Information from the neurosciences may soon inform these issues, and is already offering exciting clues.

Two investigators performed functional neuroimaging with depressed people treated with psychotherapy or antidepressant medicine. In the first study, Arthur Brody and Lewis Baxter used pre- and posttreatment PET imaging to examine regional brain metabolism changes in 24 people suffering from major depression treated with 12 weeks of either paroxetine or interpersonal therapy (IPT). The posttreatment changes in brain activation were very similar, with both groups showing a normalization of excessive pretreatment activation in a variety of brain regions (the right dorsolateral prefrontal cortex, left ventrolateral prefrontal cortex, right dorsal caudate, and bilateral thalamus). Only the medicated group showed a significant reduction in the right ventrolateral prefrontal cortex, possibly reflecting the fact that the medicated subjects were less symptomatic pretreatment and experienced a proportionately more robust response to treatment.

In a study performed in the United Kingdom, Stephen Martin used SPECT to measure changes in regional cerebral blood flow (rCBF) in 28 depressed people who were treated for 6 weeks with either venlafaxine or IPT. The two groups had a similar degree of pretreatment symptoms, and again, the drug group showed a more robust improvement, although 6 weeks of treatment is minimally adequate for an antidepressant trial, but probably not for IPT. The imaging studies showed that both groups showed increased rCBF in the right basal ganglia. Only the IPT group showed increased rCBF in the right posterior cingulate, an ambiguous finding due to potential confounding effects.

A preliminary study by Viinamaki and colleagues in Scandinavia suggests that psychodynamic psychotherapy, as is the case with CBT and IPT, may change brain function. A patient with both depression and borderline personality disorder was treated for 1 year with psychoanalytic psychotherapy and compared to another patient with the same conditions who received no treatment, as well as with 10 normal controls. Pre- and posttreatment SPECT scans demonstrated normalization of serotonin uptake in the prefrontal cortex and thalamus of the treated patient but not in the untreated subject.

Although not an imaging study, it is worth mentioning work done by Russell Joffe in which he treated 30 mildly depressed people with 20 weeks of cognitive therapy (CT), 17 of whom responded to treatment. Blood was drawn from the subjects before and after treatment, and assayed for concentrations of thyroid hormone. Prior studies have shown that thyroid hormone, a general regulator of the body's metabolic activity, is elevated in many people with depression, and tends to normalize after effective treatment with antidepressant medicines. Joffe found that thyroid hormone levels came down in CT treatment responders, but not in nonresponders. Although the implications of abnormal thyroid function is unclear as it relates to depression and its treatment, this study provides another piece of evidence that psychotherapy resembles medication treatment in terms of biological changes that follow effective treatment.

From these very preliminary studies we may conclude that there is little neurobiological evidence of differential antidepressant medicine–psychotherapy treatment effects, suggesting that a unitary pathway for relieving depressive symptoms might exist, shared by antidepressant medicines and psychotherapy. Yet even if there is, on some level, a common biological antidepressant mechanism, that possibility does not help us to decide which treatment might best help a given patient. Biological markers that predict response to one treatment or another could help the patient and clinician rationally choose the most promising treatment. Better understanding of the involved pathways may also provide a biological basis for synergistic antidepressant–psychotherapy combinations, analogous to the strategy commonly used in anticancer chemotherapy in which drugs are combined that attack a common biochemical pathway at different steps in the sequence.

2. Sleep Studies

Sleep studies have been used to identify just such a marker. Michael Thase and others at the University of

Pittsburgh performed three studies of almost 300 depressed people treated with either antidepressant medication or psychotherapy (CBT in the first study; IPT in the subsequent studies). Prior to treatment, subjects underwent a sleep electroencephalogram (sleep EEG, or polysomnography). This test uses measurements of the brain's electrical activity to characterize a subject's sleep, in terms of the amount of actual sleep and the relative normalcy of the pattern of sleep stages. The investigators found that people with abnormal sleep profiles responded less well to CBT, and had a higher recurrence rate. Interestingly, the sleep EEG did not predict response to medication.

3. A Cellular Mechanism of Antidepressant Treatment

Hypotheses concerning the cellular mechanisms of effective psychotherapy are entirely conjectural at this time. However, the mechanisms of antidepressant medication action are being elucidated, and may offer us testable hypotheses about the mechanisms of action for psychotherapy.

Ronald Duman and colleagues at Yale University have studied the biology of mood disorders as well as possible cellular mechanisms of antidepressant treatments. Chronic administration of four different classes of antidepressant drugs and electroconvulsive shock increased levels of brain-derived neurotrophic factor (BDNF)—a chemical inside of the nerve cell that indirectly turns on gene transcription, and inhibits cell death pathways—in the hippocampus of unstressed rats. Furthermore, the antidepressant treatment blocked the expected downregulation of that chemical in response to stress. They concluded that antidepressant treatments might work by enhancing neural plasticity and supporting neurogenesis and neuronal survival. Although this offers a hypothetical cellular mechanism of action for antidepressant treatments, it also raises the intriguing prospect, albeit conjectural at this time, that psychotherapy may act in a similar fashion. Duman hypothesized that depression (and possibly other psychiatric conditions) may result from a failure of neural plasticity in various brain regions, particularly the hippocampus and prefrontal cortex. Might effective antidepressant therapies, somatic or psychotherapeutic, act by restoring normal neural plasticity?

E. Posttraumatic Stress Disorder

Human history quickly dispels any notion that tragedy and trauma can ever become infrequent occurrences. Despite the best of societal intentions, wars

rage, terror menaces, and trusted caregivers violate. Trauma survivors persevere in states ranging from health to mental debilitation. PTSD is a potential consequence of trauma that renders its victim chronically anxious and phobic, prone to awful reexperiencing episodes, avoidance behavior, and a range of behavioral, cognitive, and affective symptoms.

Our earlier discussion of the biology of stress is highly relevant to the study of PTSD. Douglas Bremner at Yale University has studied the biology of PTSD in combat veterans and victims of domestic violence. He and others have concluded that PTSD is associated with hippocampal defects that may result from the deleterious effects of stress-induced glucocorticoid exposure. Bremner showed that combat veterans had hippocampal volumes 8% smaller than control subjects. He also found that memory deficits correlated with hippocampal volume reduction. Later studies with abuse victims showed hippocampal volume reductions of 12 to 16% in people with abuse-related PTSD compared to abuse victims who did not develop PTSD. The age of traumatization (stage of development) may influence the nature of the memory deficits and hippocampal atrophy. For example, imaging studies of children who were maltreated demonstrate smaller hippocampal volumes than children who were not abused. Because of its central involvement in multiple memory- and stress-related functions, the hippocampus may also provide an anatomical explanation for the fragmented or delayed recall of highly stressful or traumatic memories.

Lisa Shin and Scott Rauch at Harvard University examined 14 Vietnam combat veterans, 7 with PTSD and 7 without, using PET. The subjects viewed pictures with various themes (emotionally neutral Vietnam-unrelated themes; emotionally negative Vietnam-unrelated themes; and emotionally negative Vietnam-combat-related themes). The PTSD subjects showed increased blood flow in the anterior cingulate gyrus and right amygdala when they were exposed to combat-related stimuli. They also had decreased blood flow in an important language area of the brain (Broca's area), which the authors conjectured "may be consistent with diminished linguistic processing while subjects with PTSD viewed and evaluated combat pictures." The subjects without PTSD did not show these changes.

Chris Brewin at the University College London has posited a novel "dual representation" theory of memory that he extends to understand PTSD and its behavioral treatment. He postulates the presence of two memory systems, which he terms verbally accessible memory (VAM) and strategically accessible memory (SAM).

VAM relates to ordinary autobiographical information. Memories stored in the VAM system can interact with the rest of autobiographical memory base, and deliberate retrieval is straightforward. On the other hand, SAM is characterized by the processing of information from "lower level perceptual processing of the traumatic scene and of bodily response to it." Perceptions stored as SAM memory undergo less initial conscious processing, and such memories (that may take the form of "flashbacks") are more detailed and affect-laden.

Brewin extends this construct to psychotherapy, asserting that "therapy assists in the construction over time of detailed, consciously accessible memories in the VAM system which are then able to exert inhibitory control over amygdala activation." The therapy process creates new representations of critical retrieval cues stored in the VAM system. The new, verbally processed, trauma-related cues are identified as belonging to a specific past event that does not now constitute an ongoing threat ("that was then, this is now"). Initially, memories in the SAM and VAM systems compete when the patient is confronted with trauma reminder. VAM may be given a retrieval advantage if treatment strategies are used to "make the new representation highly distinctive," which may lead to encoding effects that improve memory retrieval. Brewin hypothesizes that EMDR may do just that: the EMDR cue (therapist's finger, for instance) encodes a very distinctive attribute to the new VAM representation. "Imaginal reconstructions" (i.e., deliberate fantasies about acting differently in the trauma) may also lend a distinctive cue to the new representations. His hypothesis, while intriguing, awaits experimental validation.

F. Obsessive–Compulsive Disorder

Perhaps no mental disorder has so represented each of the conceptual poles of the psychological–biological dichotomy as obsessive–compulsive disorder (OCD). Only a few years ago OCD was considered the classic psychological disorder, requiring the rigorous application of psychoanalytic psychotherapy. In recent years it has been conceptually transformed into the prototype of a "biological" malady that can only be truly relieved with serotonin-elevating drugs, with or without the aid of adjunctive behavioral or cognitive psychotherapy. However, as we learn more about OCD, and pay heed to the robust therapeutic potency of psychotherapy or pharmacotherapy monotherapy (as well as combinations), both models are revealed to be simplistic distortions of a complex environment–genetic interactive

phenomenon (as we believe to be the case with the great majority of mental disturbances). Much research has been accomplished regarding the biology of OCD. We will concentrate on evidence for biologic change in response to psychotherapy.

Lewis Baxter and Jeffrey Schwartz at UCLA have published results from several experiments involving PET imaging of people treated for OCD. In their first study, they treated nine OCD sufferers with behavior therapy (BT) and nine with an SSRI antidepressant, fluoxetine (Prozac^R). Similar proportions from each group responded to treatment (6 of 9 BT, 7 of 9 fluoxetine). The responders' pre- and posttreatment PET images showed the same change, specifically a reduction in the metabolic activity of a part of the striatum called the caudate nucleus. They later treated nine more OCD patients with structured exposure and response-prevention behavioral and cognitive treatment. Again, PET scans showed a reduction in the metabolic activity in the caudate of responders, but not nonresponders. The shared ability of BT and SSRIs to reduce OCD symptoms may be partially explained by studies on classical conditioning in dogs. Injecting serotonin into the anterior limbic cortex of low-serotonin dogs decreases the effects of classical conditioning. Furthermore, high levels of conditioned and unconditioned reflexes in dogs are accompanied by low levels of serotonin in the blood. During exposure treatment, one tries to extinguish pathological, classically conditioned responses.

Baxter, Schwartz, and Arthur Brody conducted another study to attempt to identify a PET marker that might differentially predict response to BT or fluoxetine. They treated 27 OCD sufferers, 18 with BT and 9 with fluoxetine. Remarkably, the degree of pretreatment activity in a part of the left frontal lobe called the orbitofrontal cortex (LOFC) appeared to differentially predict response to the two treatments. Higher pretreatment activity in the LOFC was associated with a better response to BT, whereas lower LOFC activity was associated with response to fluoxetine. The investigators postulated that this effect can be explained by considering two of the (many) functions of LOFC. Specifically, the LOFC appears to (1) mediate behavioral responses to situations in which the affective value of a stimulus changes, and (2) mediate extinction. The authors pointed out that successful behavior therapy leads to a change in the affective value assigned to stimuli that had previously brought on compulsions. Subjects with higher pretreatment LOFC activity may possess a greater capacity to "change the assignment of affective value to stimuli and be better able to extinguish habitual, compulsive responses. These abili-

ties may lead to a better response to BT." This represented the first study in which a single biological marker provided an explicit guide to differential treatment planning.

G. Psychotherapy and Cancer

The study of the biology (and effectiveness) of psychotherapy need not be limited to psychiatric diseases. Fawzy I. Fawzy examined the outcomes of 80 people with malignant melanoma, an aggressive skin cancer with high mortality rate, who were treated at the John Wayne Cancer Clinic at UCLA. Some of the patients were enrolled in a 6-week supportive therapy group that provided education, stress management, enhancement of coping skills, and psychological support from group members and staff. The investigators compared the 6-year survival of the group-treated subjects and subjects who did not participate in the group. A significantly greater proportion of the group-treated patients were alive after 5 years than those who did not receive group therapy. Group-treated subjects also showed a trend toward lower recurrence rates.

David Spiegel studied 86 women with metastatic breast cancer. Fifty of the women participated in 1 year of weekly supportive group therapy, while 36 women did not. Because of the advanced stages of breast cancer in all subjects, most women (83 of 86) died within 10 years of participation. However, the mean survival time in the women who had group therapy was 36.6 months, whereas the control group lived for an average of 18.9 months.

Clearly, psychosocial factors influence the outcome of many (if not all) general medical illnesses. The mechanisms of this interaction deserve the attention of neuroscientists and psychotherapists alike.

V. CONCLUSIONS

We have sufficient evidence, some of which has been presented in this article, to reach certain neurobiological conclusions related to psychotherapy:

1. Psychotherapy is a powerful tool that produces functional and/or structural changes in our patients' brains.
2. These changes tend to reflect a relative normalization of the biological anomalies characteristically associated with the underlying illness.
3. Psychotherapy-induced changes occur in a variety of brain regions, including those involved in learning and memory.

4. Psychotherapy may exert its effects through the cellular mechanisms related to learning and memory, namely neural plasticity and possibly neurogenesis.
5. Psychotherapy may promote neural plasticity by inhibiting the cellular effects of stress.
6. Genetic diversity among individuals almost certainly contributes to the remarkable range of individual responses to stress, traumatic and nontraumatic life events, and to treatment.

Present knowledge and research tools (most notably brain imaging techniques) enable us to propose myriad testable hypotheses pertaining to psychotherapy and related topics. For instance, how is the interaction between implicit and explicit memory processes influenced or utilized by psychotherapy? Details about this interaction might guide the design of specific psychotherapeutic interventions.

Studies of stress and trauma raise many critically important issues. It is quite foreseeable that psychotherapy might be used to protect the brain from the deleterious effects of stress. Identification of the environmental conditions that are most likely to produce “toxic stress” (traumatic and subtraumatic) can facilitate that eventuality. As we clarify the interactions between genes and the environment, we may be able to identify genetically at-risk individuals to whom we could target our preventive approaches. Used in that manner, psychotherapy might reduce the likelihood of symptomatic mental illness (new onset or recurrence) during or following times of stress. It is worth noting that recent evidence indicates that critical incident stress debriefing (CISD) may not be as effective as we had thought in reducing the incidence of posttraumatic psychopathology in people who have recently experienced traumatic events. Thus, effective prophylactic psychotherapies must be as carefully tailored, delivered, and validated as therapies for existing mental disturbances.

Another important consideration involves the refinement of psychotherapies to best address specific mental diagnoses or symptoms. The scientific basis for selecting one psychotherapy over another is still weak, relying, at best, on empirical evidence that a particular type of therapy did or did not work in a particular sample population. A time may come when we will be able to rationally design optimal psychotherapy based on the neurobiology of the mental disease and the proposed treatment. On a related note, we hope that Cloninger’s theories of personality development (or similar work) will be refined in a way that might also guide specific psychotherapeutic strategies.

Research described earlier in this article involving sleep EEG (in depression) and PET (in OCD) provides

a tantalizing glimpse at the potential of diagnostic tools to identify predictors of treatment response. Brain imaging methods, HPA axis parameters, and other biological markers may someday offer accurate and practical ways to monitor progress in psychotherapy.

Substantial advancement in the effectiveness of combined psychotherapy and pharmacotherapy will certainly require additional research. Important questions concerning strategies for optimizing combined treatment abound. Ideally, combined therapies would offer synergistic, rather than redundant or even antagonistic mechanisms of action.

Do different psychotherapies act on different parts of the brain? Some have suggested that psychoanalytically oriented psychotherapy may have greater influence on the lateral hemispheres since this type of treatment focuses on internal representation and expectations of others. In contrast, behavioral therapy often focuses on simpler forms of learning and memory that may involve more directly the amygdala, hippocampus, and basal ganglia.

The healing professions have long paid insincere homage to the biopsychosocial model of human cognition, emotion, health, illness, and behavior. A true integration of biology and psychology into a coherent conceptual framework, subscribed to by medical and nonmedical clinicians and researchers, is essential if we hope to take full advantage of the remarkable healing power of psychotherapy and move from a reductionistic mind–brain dichotomy in understanding our patients in health and illness.

See Also the Following Articles

Biofeedback ■ Collaborative Care ■ Comorbidity
 ■ Neuropsychological Assessment ■ Organic Brain
 Syndrome ■ Psychopharmacology: Combined Treatment

Further Reading

- Charney, D. S., Nestler, E. J., & Bunney, B. S. (1999). *Neurobiology of mental illness*. New York: Oxford University Press. For information about the biology of mood disorders, see in particular chapters 23 and 31.
- Cloninger, C. R. (1993). A psychobiological model of temperament and character. *Archives of General Psychiatry*, *50*, 975–990.
- Gabbard, G. O. (2000). A neurobiologically informed perspective on psychotherapy. *British Journal of Psychiatry*, *177*, 117–122.
- Kandel, E. R., Schwartz, J. H., & Jessell, T. M. (Eds.). (2000). *Principles of neural science* (4th ed.). New York: McGraw-Hill.

- LeDoux, J. (1996). *The emotional brain: The mysterious underpinnings of emotional life*. New York: Simon & Schuster.
- Liggan, D. Y., & Kay, J. (1999). Some neurobiological aspects of psychotherapy. A review. *Journal of Psychotherapy Practice and Research*, 8, 103–114.
- Pally, R. (1997). Consciousness: A neuroscience perspective. *International Journal of Psycho-Analysis*, 79, 971–989.
- Reiman, E. M. (1997). The application of positron emission tomography to the study of normal and pathologic emotions. *Journal of Clinical Psychiatry*, 58(Suppl. 16), 4–12.

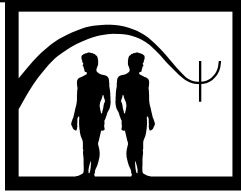

Neuropsychological Assessment

Linda Laatsch

University of Illinois College of Medicine at Chicago

- I. Description of Assessment
 - II. Case Illustration
 - III. Theoretical Bases
 - IV. Applications and Exclusions
 - V. Empirical Studies
 - VI. Summary
- Further Reading

GLOSSARY

- dominant hemisphere** The hemisphere of the brain dominant for language functioning.
- frontal/prefrontal lobe:** The area of the brain anterior (in front of) the precentral gyrus.
- intelligence** Measures of overall capacity to process external and internal stimuli.
- neuroimaging tools** Nuclear medicine tools used to picture the functional and structural components of the brain in a systematic manner.
- neuropsychological assessment (NPA)** Systematic evaluation of the brain-behavior relationships in an individual.
- neuropsychologist** Clinician with specialized training in neuropsychology and involved in neuropsychological assessment.
- normative sample** Sample from population of interest with no known neurological impairments.
- pathognomonic approach** Use of a variety of measures that are designed to identify symptoms associated with characteristics of a particular disease.
- premorbid ability** Abilities prior to the neurologic event resulting in brain injury.

referral question The question for which the client was referred for the evaluation.

I. DESCRIPTION OF ASSESSMENT

Neuropsychological assessment (NPA) is the systematic evaluation of the brain-behavior relationships in an individual. The purpose of an NPA is to define the client's specific cognitive strengths and weaknesses and to identify the relationships between the neuropsychological findings and the client's medical and psychiatric condition. Tools used to complete the NPA are measures of cognition and intelligence that have been standardized on a neurologically normal sample. By administering the measures in the identical, systematic manner, as described in the instruction manual for the testing instrument, the evaluator can compare the individual's performance on the measure to the performance of a normative sample. It is optimal if the normative sample is subdivided by gender, age, and years of education. In that way a very specific comparison can be made. Neuropsychological test performance has been generally shown to vary according to gender, age, and years of education in control samples.

Localization of brain injury was the intent of neuropsychological testing in the 1970s but with current functional and structural neuroimaging tools, there is a reduction in the need to "localize" the brain injury. The purpose of neuropsychological evaluation is currently

multifaceted and often is dependent on the referral question. A complete NPA helps the client, clinician, and referral source gain an understanding of the client's cognitive processes such as memory, language, and perception. In addition it can assist in diagnosis and identification of difficulties in cognition that might be related to psychiatric conditions and motivation. Finally, a thorough NPA can help to determine rehabilitation potential by identifying pathways for compensation and extent of cognitive involvement.

II. CASE ILLUSTRATION

The NPA report and raw data shown below provide an example of a case referred by a neurologist. This 55-year-old man was referred because, during a standard mental status evaluation, visual perceptual problems were observed.

A. Neuropsychological Testing Report

1. *Relevant Past History*

Dr. C is a right-handed, 55-year-old, Caucasian male, previously employed as an optometrist. Dr. C reported that he first noticed changes in his cognition while on an out-of-town visit. He became disoriented and he reported that he got lost for many hours while driving to a known location. He reported that he is happily married and has two children who have been very successful in their own vocations. Both his mother and father are deceased. His father died recently from a series of illnesses, including a bowel obstruction and pneumonia. His mother died in 1985 of Alzheimer's disease. Dr. C reported a recent fall from a horse while on a vacation, but he denied receiving a head injury from it, only reporting minor bruises. He also reported that last summer he was camping and his dog was exposed to ticks. He is concerned that the current problems that he is having may be related to Lyme disease. Dr. C denied other significant stressors in his life and continues to remain active, playing tennis regularly. He is on no medications.

2. *Behavior During Evaluation*

Dr. C arrived late for the interview because he was unable to find the location of the room. He was very guarded during the initial interview and overtly frustrated during some of the more difficult portions of the evaluation. Mood was observed to be slightly depressed

but toward the end the session Dr. C was able to talk more freely and seemed to become more relaxed. His attention and effort were adequate and the current evaluation is thought to be an accurate measure of his current abilities.

3. *Tests Administered*

Tests administered included the Wechsler Adult Intelligence Test-R, Wechsler Memory Scale-R, Wide Range Achievement Test (Reading subtest), Stroop, Trails A & B, and the Adaptive Category Test.

4. *Results of the Evaluation*

Dr. C's full-scale intelligence was estimated to be within the very high average range but a significant discrepancy was noted between his verbal abilities and his visual-perceptual skills (Full-Scale IQ 124, Verbal IQ 130, Performance IQ 110). Dr. C demonstrated an exceptional vocabulary and understanding of the world around him. His speech was fluent and detailed, and no signs of expressive speech limitations were observed. When presented with visual stimuli Dr. C had difficulty identifying missing essential details within a visual percept. Dr. C also had great difficulty reproducing visual spatial designs. He was unable to segment accurately the design and work on parts to complete the whole design. Graphic motor speed was high average and he was able to copy simple figures accurately and rapidly. It is expected that, given his educational background and his vocation's emphasis on visual perception, his current visual perceptual skills represent a significant decline for him.

Speed of processing was found to be average and high average given simple material. Verbal short-term attention was average for his age. Dr. C was able to maintain seven digits in his head and present them forward. When asked to recall the numbers in reverse order, he was only able to recall four digits. Simple reading speed was average. In addition, Dr. C was able to keep a strategy in mind while he quickly read given words. When asked to scan for specific numbers and letters Dr. C demonstrated greater difficulty and he was unable to accurately alternate between number and letters. His performance on a difficult task requiring sustained attention and visual scanning with interference was significantly impaired.

Memory abilities were also variable and his pattern of performance is reflective of his memory complaints. Verbal memory skills are within the high average to superior range given his age. He was able to recall lengthy stories (98th percentile and 92nd percentile) immediately after

presentation and again report the stories 20 minutes later accurately. He was also able to rapidly learn pairs of words. Dr. C had more difficulty recalling visual material presented. He was unable to encode essential details of the visual stimuli and his recall of the given visual designs was between the 25th percentile and 33rd percentile. Once he had learned the material, Dr. C was able to accurately reproduce the visual information even given a significant delay. His visual memory impairments are most likely related to his recent difficulty getting lost when not using a map. In addition, his memory is hampered by his difficulty identifying essential details and visual-spatial relationships in abstract visual percepts.

The complex visual problem-solving task administered on the computer was also difficult for Dr. C. He was inefficient in his ability to develop effective problem-solving strategies to apply to the sets of figures presented. He demonstrated difficulty planning and tended to act impulsively in response to the presented stimuli. This task was frustrating for him and his performance was severely impaired. Dr. C demonstrated excellent verbal abstraction abilities when he was given uncommon proverbs as part of the intelligence test.

Dr. C was administered the Symptom Checklist 90-R and denied all types of psychiatric symptoms. On this survey form, he did not acknowledge difficulty in thinking or a change in his appetite even though he had recently gained 65 pounds. His response pattern on the checklist and during the interview indicates that Dr. C is unable to fully acknowledge the significance of his cognitive changes. When his difficulties were pointed out, Dr. C had a tendency to use his excellent verbal skills to externalize the existing problem.

5. Summary

Dr. C has experienced significant neuropsychological changes that involve moderate visual-perceptual and visual-spatial impairments, moderate visual memory limitations, and moderate impairments in problem solving. In contrast, Dr. C continued to demonstrate exceptional verbal skills and verbal memory. Dr. C denied problems with mood or the recent occurrence of psychiatric symptoms.

Because of the importance of memory and visual-perceptual abilities in his work, it is not recommended that Dr. C return to his current job. It is recommended that Dr. C consider cognitive rehabilitation therapy to help him learn to compensate for his current limitations. In rehabilitation there will be an attempt to help him learn to use his verbal skills to compensate for his

visual memory limitations. Because Dr. C displayed limited insight regarding his difficulties, his family will need to be involved in helping him learn to use compensation strategies. Supportive psychotherapy for himself and family members is also recommended.

Dr. C meets the criteria of dementia because of a decline in visual memory and problem solving. It is suspected that Dr. C is experiencing degeneration in both the right temporal and frontal lobes. This may be associated with frontal-temporal dementia. Repeated testing in 6 months will determine if the condition is progressive.

TABLE I
Neuropsychological Testing Scores

<i>Wechsler Adult Intelligence Test-R</i>			
Verbal Tests		Performance Tests	
Information	15	Picture Completion	8
Digit Span	10	Picture Arrangement	9
Vocabulary	16	Block Design	7
Arithmetic	14	Object Assembly	9
Comprehension	15	Digit Symbol	13
Similarities	14		

Verbal IQ = 130 Performance IQ = 110 Full-Scale IQ = 124

Trail Making A: T = 38 *Trail Making B:* T = 36

Stroop Word T = 57, *Color* T = 55,
Color Word Interference T = 57

Wechsler Memory Scale-R

Logical Memory I	98th percentile
Logical Memory II	92nd percentile
Visual Reproduction I	25%
Visual Reproduction II	33%

Symptom Checklist 90-R
All 90 questions responded with "0" score.

Adaptive Category Test
Total Adaptive Error Score = 122

III. THEORETICAL BASES

Russia was one of the first countries in the world to begin NPA. In the early 1900s, A.R. Luria used a flexible, clinical evaluation approach in his work with patients who had brain injury. His model of brain functioning, published in English in 1970, outlined

“three principal functional units of the brain ... a unit for regulating tone or waking, a unit for obtaining, processing and storing information ..., a unit for programming, regulating and verifying mental activity.” Luria defines the purpose of NPA as being twofold: “to pinpoint brain lesions responsible for specific behavior disorders ... provide us with a factor analysis that will lead to better understanding of components of complex psychological functions” (p. 66).

In the United States in 1986 Donald T. Stuss and Frank Benson provided a behavioral anatomical theory of brain functioning to guide NPA. They stressed the global influence of the frontal/prefrontal lobe on mental activity. In their theory, executive functioning attributed to the frontal/prefrontal lobes of the brain provides conscious direction and efficient processing of internal and external stimuli. The second unit of the brain is associated with the posterior region of the brain and involves attention, visual-spatial processing, language, sensory perception, memory, motor, and emotional status. In their theory they create a hierarchy of brain functioning and they identify *self-awareness* as the highest cognitive attribute of the frontal lobes. Although many individual mental functions, assessed by neuropsychological tests, can be maintained without prefrontal and frontal participation, the responses are automatic and insight and planning are lacking. Adequate frontal/prefrontal functioning is essential for control of intelligence, consciousness of self, and independent thinking.

It has not been possible for neuropsychologists to develop specific measures that are 100% diagnostic of any type of brain injury. Instead most neuropsychologists now use a pathognomonic approach. This approach involves the use of a variety of measures that are designed to identify symptoms associated with characteristics of a particular disease. In the United States most neuropsychologists use a flexible battery approach. Instead of using standardized test battery in its entirety, a selection of tests from a variety of batteries and separate, individual tests are utilized. Standardized batteries that have been developed over the years are the Luria-Nebraska Neuropsychological Battery and the Halstead-Reitan Neuropsychological Battery. A flexible battery approach allows the clinician to match the referral question and the examinee's pattern of abilities to the test battery. It is the aim of the neuropsychologist to understand the reason for the evaluation, the questions being presented by the individual being evaluated, and the functional implications of the symptoms in making decisions concerning

the assessment tools to be used in the evaluation. Although NPA batteries may differ, generally, a core set of assessment tools are used in each case. This core is included because the psychologist is most familiar with these assessment tools, understands the cognitive component skills that are part of the measure, and has appropriate normative data available. Flexibility in the NPA derives from the needs of the individual being evaluated. Clinical neuropsychologists regularly address a large range of referral questions, clinical behaviors, and patients with very disparate capacities. So although there is an overall structure to the NPA, there is significant diversity in the details of each NPA.

Generally a measure of intelligence is administered as part of the NPA battery. By administering a measure of overall general abilities such as an intelligence test, the clinician can compare overall level of functioning to specific cognitive skills such as memory, attention, and problem solving. Examination of the subtests may also provide clues to premorbid functioning. Most NPA batteries also include measures of expressive and receptive language, visual perception, visual scanning, and visual-spatial processing. A variety of measures of attention and memory are commonly included. Finally tests of executive processing such as problem solving are administered. Also included in an NPA will be at least a basic measure of emotional or psychiatric status. Because depression and anxiety can influence cognitive abilities, a measure of psychiatric symptoms needs to be administered to determine if there is an emotional component to the client's current cognitive status.

The battery of tests will generally be preceded by a clinical interview. Background information concerning the client's social history, present life circumstances, medical history and current medical complaints, and reasons for referral are obtained.

Information regarding social and medical history, psychiatric history, drug and alcohol abuse history, neurotoxin exposure, history of head injury, a list of current medications, family psychiatric and dementia history, and client's social, employment, and educational history should be obtained because these factors can influence test interpretation. The NPA will include an observation of the client's general appearance, ambulation, sensory limitations, and behavior. In an NPA the examiner needs to observe attention, distractibility, and motivation on all tests administered.

The entire test battery may require anywhere from a few hours to a day or two to complete, depending on the client's attention and stamina.

IV. APPLICATIONS AND EXCLUSIONS

NPA is most often not attempted in children younger than the age of 4 years. Normative data are available for the geriatric population on a select number of neuropsychological tests. Therefore, NPA is possible in individuals between the ages of 5 to 95 years.

Currently relatively few NPA tools used in the United States have been translated to languages other than English. The Wechsler Intelligence tests for children and adults are available in Spanish. Since the intelligence tests are some of few tests translated and normed for Spanish-speaking individuals, full NPA often takes place using informally translated NPA tools. It is very important to consider ethnic variations in administering NPA tools to individuals outside the normative sample on which standardization took place. Fortunately, many countries have developed NPA tools within their own culture.

NPAs vary extensively in length. Length of the testing will vary depending on the referral question, finances of the individual being evaluated, and complexity of the presenting symptoms or neurological condition. Therefore, testing is limited to individuals able to tolerate the interpersonal and lengthy testing situation. NPA is managed by a clinical psychologist trained in NPA but in many environments a student in clinical psychology or a testing technician may give some of the assessment tools. Because the assessment tools used in NPA are standardized in their administration, students and technicians can be trained to administer many of the tests. Close supervision is essential because the clinical neuropsychologist needs to be available if problems arise and to ensure that the tests are administered in the standardized manner.

As can be surmised, a psychologist involved in NPA needs to have extensive expertise. Generally specific neuroscience training while in a school of clinical psychology is required. Classes concerning normal child and adult brain functioning and neuropathology (neuroanatomy and neurophysiology principles) should be part of the student's experience. The clinician completing the NPA needs to have a broad understanding of brain function and its neuroanatomical correlates. Clinical experience in assessment of both neurologically normal and impaired individuals needs to be extensive. Given the complexity of each examinee's cognition and emotional status at the time of the evaluation, every NPA completed offers new learning experiences to the student in training. Currently graduating

clinical psychologists are asked to continue their supervised experience for 2 years after completing an internship specializing in neuropsychology. This further training is called postdoctoral training in neuropsychology. The division of neuropsychology within the American Psychological Association offers these specialized training opportunities.

V. EMPIRICAL STUDIES

In 1981 Heaton and Pendleton completed one of the earliest studies of the predictive abilities of neuropsychological testing on everyday function. They reviewed the relationship between neuropsychological testing results and various aspects of everyday life: self-care, independent living skills, and academic and vocational achievement. They found that intelligence tests scores relate to the clients' ability to care for themselves and their understanding of everyday routine situations. The Category Test from the Halstead-Reitan battery was related to judgment and decision making in routine daily activities. Memory measures were related to learning capacity and forgetfulness in everyday functioning.

There is a continuing need for neuropsychologists to effectively address functional questions after the neurologic diagnosis has been established. Central to the success of NPA is its ability to present useful and valid information regarding issues for everyday living. Neuropsychologists, using the NPA, need to be able to identify the client's individual cognitive strengths and deficits. It is especially important for the NPA to identify residual strengths that can be used to improve everyday functioning within work and home situations. NPA should address the client's ability to function safely and efficiently within an existing or new work environment, assess ability to perform adequately in school, and determine whether the client is able to remain at home without supervision. These are just a few of the many questions needing to be addressed in a thorough NPA.

VI. SUMMARY

NPA is an applied science involving systematic measurement of brain-behavior relationships. It involves the complete and detailed assessment of behavioral expression of brain dysfunction. It is generally a lengthy process involving a clinical interview, a flexible battery of standardized cognitive measures, and measures of

psychological functioning. The time and effort required of the client is compensated by the clinical neuropsychologist's careful consideration of questions concerning cognitive strengths and weaknesses, rehabilitation strategies, work and educational potential, and safety within home and outside environment.

See Also the Following Articles

Behavioral Assessment ■ Collaborative Care ■ Comorbidity ■ Formulation ■ Medically Ill Patient: Psychotherapy ■ Neurobiology ■ Projective Testing in Psychotherapy ■ Trauma Management Therapy

Further Reading

- Heaton, R. K., & Pendleton, M. G. (1981). Use of neuropsychological tests to predict adult patients' everyday functioning. *Journal of Consulting Clinical Psychology, 49*, 807.
- Lezak, M. D. (1995). *Neuropsychological assessment*, 3rd ed. New York: Oxford University Press.
- Luria, A. R. (1983). *The working brain*. New York: Penguin Books.
- Stuss, D. T., & Benson, D. F. (1986). *The frontal lobes*. New York: Raven Press.
- Walsh, K., & Darby, D. (1999). *Neuropsychology: A clinical approach*. Edinburgh: Churchill Livingstone.



Nocturnal Enuresis: Treatment

Henry S. Roane, Cathleen C. Piazza, and Mary A. Mich

The Marcus and Kennedy Krieger Institutes and the Johns Hopkins University School of Medicine

- I. Introduction
 - II. Description of Treatment
 - III. Theoretical Bases
 - IV. Empirical Studies
 - V. Summary
- Further Reading

GLOSSARY

classical conditioning Learning that occurs when a response is elicited by a particular stimulus. This process occurs when a previously neutral stimulus (e.g., a tone) occurs in conjunction with another (unconditioned) stimulus (e.g., food presentation) that results in a unconditioned response (e.g., salivation). Over repeated pairings, the neutral stimulus obtains the properties of the unconditioned stimulus and elicits the same response. The neutral stimulus is then referred to as the conditioned stimulus and the response is referred to as the conditioned response. Also known as Pavlovian conditioning.

dry bed training An intensive treatment for nocturnal enuresis that involves a combination of procedures, including urine alarm, retention training, and practice of correct toilet skills.

negative reinforcement Form of operant conditioning that occurs when a behavior is immediately followed by the removal of a stimulus that results in an increase in the future likelihood of the behavior.

nocturnal enuresis Repeated voiding of urine in one's bed or clothing at night that is inappropriate at a given age (5 years). Can be classified as primary (child has never been

continent) or secondary (child previously has been continent). Also referred to as bedwetting.

operant conditioning Learning that occurs based on the consequences that follow a response. This process occurs when a behavior is emitted and the resulting consequences either increases or decreases the likelihood of the behavior occurring in the future.

positive reinforcement Form of operant conditioning that occurs when a behavior is immediately followed by the presentation of a stimulus that results in an increase in the future likelihood of the behavior.

punishment Form of operant conditioning that occurs when a behavior is immediately followed by a consequence such that there is a decrease in the future likelihood of the behavior.

retention training Treatment involving a gradual increase in bladder capacity by delaying urination for successively longer periods of time.

urine alarm Common treatment for nocturnal enuresis involving a pad placed on the child's bed and an alarm that is activated when the child urinates. Also known as the "bell-and-pad" treatment.

I. INTRODUCTION

Enuresis, the repeated voiding of urine into one's bed or clothing, is a fairly common childhood behavior problem. Based on the criteria described in the *Diagnostic and Statistical Manual, Fourth Edition*, a diagnosis of enuresis is appropriate if incontinent voiding has occurred for a minimum period of 3 months, and the

child must be at an age where appropriate continence is expected (i.e., 5 years). The diagnosis of enuresis is divided into three types: diurnal, nocturnal, and combined, with the most frequently diagnosed type being nocturnal enuresis. Because of the frequency of the diagnosis, the majority of this article focuses on nocturnal enuresis.

As implied by the name, nocturnal enuresis refers to incontinent urination at nighttime. More commonly, the behavior is referred to as "bedwetting." Nocturnal enuresis can be classified as either primary or secondary, depending on the child's history of continence. If the child has never been continent, primary enuresis is diagnosed; conversely, secondary enuresis is diagnosed if the child previously has experienced a period of continence.

Nocturnal enuresis is a relatively common childhood problem. Prevalence estimates for the disorder vary widely; however, the occurrence of the behavior tends to decrease with age such that approximately 20% of 5-year-olds display the behavior compared to 10% of 10-year-olds. In addition to the variation with age, the prevalence of nocturnal enuresis varies with gender with an approximate 3:2 male to female ratio. Enuretic children often have an immediate family member who also displayed bedwetting. As noted by Shaffer this relationship is poorly understood. That is, it is unknown if this relationship is genetic in origin or if the families of enuretic children are more permissive in their views of the behavior (i.e., parents who displayed enuresis are more accepting of its occurrence).

Several hypotheses have been reviewed regarding the development of enuresis. A psychodynamic hypothesis posits that enuresis is related to the presence of an unresolved internal conflict. Psychological stressors (e.g., parental separation, poor academic performance) might also be related to the occurrence of enuresis. Some researchers have hypothesized that enuretic children have smaller bladder capacities than their nonenuretic peers. Finally, in some cases, it appears that enuretic children simply have not learned correct bladder control. The latter opinion is perhaps the most tenable hypothesis given that the teaching of correct skills has been shown to lead to a decrease in enuresis and other toileting accidents.

II. DESCRIPTION OF TREATMENT

As with all childhood behavior problems, the treatment of enuresis should begin with a comprehensive medical and psychological examination. Friman and

Jones described several factors to consider in the assessment of enuresis. Examples of these factors include parental beliefs about the severity of the problem, parent and child motivation to implement treatment, and the child's concerns over the bedwetting. Knowledge of these factors may predict treatment efficacy in some cases. For example, Butler, Brewin, and Forsythe found that children who are not concerned with their enuresis are more likely to demonstrate treatment relapse than children who are concerned. Finally, it is recommended that the assessment of nocturnal enuresis include data collection prior to the onset of treatment. Such baseline data will assist in identifying the frequency of the behavior as well as other dimensions of the behavior (e.g., the time at which wetting occurs). In some cases, additional assessment procedures such as direct observation may be used to develop treatment alternatives.

Following assessment, treatment development should occur in accordance with the desires and needs of the child and the caregivers. That is, treatments of enuresis may vary in terms of caregiver vigilance in implementation or the occurrence of behavioral side effects. In addition, caregivers may find certain therapies unacceptable and may be less likely to implement the procedures. Regardless of the type of intervention employed, treatment application and its effectiveness should be monitored by either the prescribing physician or psychologist.

In general, treatment of nocturnal enuresis consists of medication or behavioral intervention. Among medications, the most frequently prescribed for the treatment of enuresis are the antidepressants, particularly imipramine. Imipramine has been shown to produce an immediate reduction in enuresis in many cases; however, withdrawal of the medication may produce a relapse in treatment in over 60% of cases as well as behavioral side effects (e.g., nausea, drowsiness). In addition, the use of imipramine and other medications does not teach the child appropriate toileting skills.

Behavioral interventions have been the focus of many empirical investigations and have been demonstrated to be effective in reducing nocturnal enuresis. Thus, the remainder of this article summarizes the procedures and empirical support for the use of behavioral interventions in the treatment of nocturnal enuresis.

III. THEORETICAL BASES

Some research suggests that the occurrence of enuresis may be due to the improper learning of bladder retention

and toileting skills. Thus, interventions that teach new skills (i.e., behavioral interventions) generally are more effective than pharmacological interventions. Various behavioral interventions have been described in the extant literature, with the most commonly employed procedures consisting of the urine alarm, bladder retention training, and dry bed training.

In general, the effectiveness of the various behavioral interventions has been attributed to both classical and operant conditioning. For example, it was initially hypothesized that classical conditioning was responsible for behavior change when using a urine alarm. That is, the alarm was conceptualized as the unconditioned stimulus, passing of urine was the condition stimulus, and waking was the conditioned response. More recently, an operant hypothesis has been used to interpret the learning mechanism that occurs with the urine alarm. Specifically, the alarm is an aversive stimulus and a full bladder or urine release is a stimulus associated with the activation of the alarm. The child awakens when the bladder is full and urinates in the toilet to avoid the activation of the alarm. Successful avoidance of the alarm increases the future likelihood that the child will urinate when internal cues (i.e., a full bladder) are present.

Successful retention training and dry bed training have been attributed to a combination of operant mechanisms. For example, the use of extrinsic reinforcers (contingent on bladder control) functions as positive reinforcement for bladder retention in both retention training and dry bed training. Waking and urinating in the toilet at night may function as negative reinforcement through the elimination of a full bladder and the avoidance of wet clothing and bedding. Finally, repeated practice of correct toilet skills and the changing of clothing and bed linens as a component of dry bed training may alter behavior through punishment.

IV. EMPIRICAL STUDIES

A. Urine Alarm

The urine alarm, also known as the bell-and-pad procedure, is one of the most well known and commonly used treatments for enuresis. Although there are variations of the treatment, the basic procedure is similar to that originally described by Mowrer and Mowrer. The child sleeps on a specially constructed pad covered by two foil outer shells. The top layer of the pad has holes, which are separated by an absorbent paper connected to a buzzer. The presence of urine on the absorbent paper

activates an electric circuit that produces an alarm (e.g., a buzzer). Presumably, the alarm quickly awakens the child and teaches the child to associate a full bladder with awakening. The alarm may also inhibit additional urination as the bladder contracts. The child then progresses to the toilet and finishes urinating.

To produce maximum treatment effects, several manipulations should occur prior to the child's going to bed and following activation of the alarm. Before going to bed, the child should drink extra amounts of fluid. The buildup of fluid in the child's bladder throughout the night increases the probability that he or she will contact the "wetness equals alarm" contingency during the initial stages of treatment. In addition, the child should be put to bed with minimal clothing to ensure that only a small amount of urine is necessary to activate the alarm. That is, as less urine activates the alarm, the child awakens with more fluid in the bladder thus enhancing the training by teaching the child to associate a relatively full bladder with awakening. Other training procedures should be implemented following activation of the alarm. For example, if a child is clothed, he or she may be required to clean the soiled clothing or change into clean clothing. In addition, the child should be required to change the bed linens and wash the pad before going back to sleep. Finally, in an attempt to decrease the probability of relapse, an intermittent schedule of alarm activation has been effective in some cases (e.g., alarm activation on 50% of trials).

It is essential that parents become actively involved in the implementation of the treatment. For example, parents should be responsible for collecting data following each accident. Data may be collected on the frequency of accidents per night or week, the time of the accident, or the diameter of the wet spot. Such data are useful in determining minute treatment gains following repeated exposure to the alarm. In addition to data collection, parents should be responsible for reinforcing the absence of bedwetting and the occurrence of correct elimination in the toilet. For example, in our clinical practice, we often suggest that parents provide access to a highly preferred item or activity following no incontinence for a period of time (e.g., one or two nights, or one week). Toward this end, it is recommended that the supervising therapist conduct an assessment with the child and parents to identify potential reinforcing stimuli.

Training with a urine alarm is relatively brief and the results are relatively durable. In addition, the procedures implemented in urine alarm training are also easily modified for training skills in other settings. For example, one common modification involves the attachment of an

alarm to a child's underwear. The alarm is connected to a pad that, when wet, sounds the alarm. Using a similar method, Edgar, Kohler, and Hardman successfully reduced the occurrence of urinary incontinence in 8 of 10 participants with profound mental retardation. More recently, Friman and Vollmer used a modified urine alarm to treat one girl's diurnal enuresis. Results showed that the use of the alarm produced an immediate reduction in enuresis; however, Friman and Vollmer noted that the participant experienced some social embarrassment on activation of the alarm.

B. Retention Control Training

It has been hypothesized that enuretic children have a smaller bladder capacity than nonenuretic children. Retention control training involves gradually increasing the bladder capacity of the child. As reviewed by Friman and Siegel and Smith, retention training involves a child drinking an amount of fluid (e.g., 8 oz.) and delaying urination for a set amount of time (e.g., 3 min) or for as long as possible after the initial urge to void. On subsequent days, the child is encouraged to refrain from urination for a longer period of time (e.g., progressing from 3 to 5 min). Successful bladder control should be reinforced through the use of extrinsic reinforcers. During the training, parents should collect data on the latency to urination after drinking and on the amount of urine emitted. Across successive days, the child holds the urine for longer periods of time, thereby increasing bladder capacity. Increasing bladder capacity within the course of a day indirectly may reduce the enuresis at night.

Retention control training does not yield as high of a success rate as does the urine alarm. However, this procedure may be preferred to the urine alarm because it does not require nighttime awakenings, and new bladder control skills are mastered.

C. Dry Bed Training

Dry bed training consists of a combination of the urine alarm and retention control training procedures. Due to the combination of these two practices, in addition to the incorporation of several other procedures, dry bed training is the most labor-intensive treatment for nocturnal enuresis. Dry bed training consists of a therapist coming into the child's home during at least the first night of treatment. In addition to the basic retention training and urine alarm procedures, Azrin and colleagues also suggested presleep practice of correct toileting skills, practice

of changing clothes, and practice of changing the bed linens. That is, prior to going to bed, the child is exposed to the events that will take place should he or she wet the bed. Scheduled nighttime awakenings (e.g., once each hour) combined with prompts to go to the bathroom, checks for wetness, and additional fluids are incorporated into the treatment as well. At each waking, the child is reminded what will occur if the bed is wet. If the child appropriately urinates in the toilet when awakened, parents provide effusive praise. By contrast, if the bed is wet, the child is responsible for repeatedly practicing appropriate urination and is made responsible for cleaning all bedding and clothing. For each night without an accident, a reinforcement-based component is included such that the child receives access to a highly preferred reinforcer and praise contingent on appropriate bladder control. Using these procedures, Azrin and colleagues reported a 100% success rate in training 24 children within 7 days. It should be noted that almost 30% of the children relapsed following treatment; however, once the treatment was reimplemented, accidents decreased again. Finally, Azrin and colleagues found that the multicomponent dry bed procedure was more effective than the more commonly used urine alarm.

V. SUMMARY

In this article, several potential treatments for nocturnal enuresis were reviewed. One consistent finding in the literature is that behavioral treatments (i.e., urine alarm, retention control training, dry bed training) are generally as effective as pharmacological treatments. For these reasons, behavioral treatments represent the best practice for the treatment of nocturnal enuresis.

Initial implementation of behavioral treatments varies across children, with most children requiring several weeks of exposure before significant treatment gains are noted. Thus, the length of treatment exposure, combined with the treatment procedures that must be implemented by the parent and child, make behavioral interventions relatively labor intensive relative to medication. However, the relapse rate of children treated with behavioral interventions generally has been lower than relapse associated with medication. Finally, the focus of a medication-based treatment is the amelioration of enuresis, whereas the focus of behavioral treatment is the amelioration of enuresis plus the acquisition of appropriate replacement skills

Follow-up data suggest that behavioral treatments produce very durable effects. For example, Gustafson exposed 50 children to urine alarm treatment as described by Mowrer and Mowrer. All children were referred for the treatment of primary nocturnal enuresis, and each participant had displayed the behavior for at least 6 years. Results showed that 90% of the participants were trained successfully following one to three exposures to the treatment procedures. Furthermore, only five of the trained participants (11%) were reported to show relapse (defined as one or two wet nights) in the year following treatment. These results suggest that the use of the urine alarm is an effective and long-lasting method for treating nocturnal enuresis.

Regardless of the type of intervention used, practitioners should be aware of their patients' goals and their willingness to engage in various treatments. If caregivers find it unacceptable to awaken multiple times per night, or if they feel that certain procedures are unfair to the child, treatment with medication may be indicated. By contrast, if the child and caregivers are interested in teaching new skills with the lower probability of relapse, behavioral treatments should be prescribed.

One final consideration in treatment development should be the willingness of the caregivers or child to collect objective data on the occurrence of enuresis. Observational data can be graphed to yield a pattern of behavior that can be visually reviewed to determine the child's progress toward continence. In addition, data collection may facilitate child and caregiver implementation of a rather strenuous treatment (e.g., dry bed training) such that a visual representation of improvement may directly reinforce these behaviors.

See Also the Following Articles

Arousal Training ■ Bell-and-Pad Conditioning
 ■ Primary-Care Behavioral Pediatrics ■ Retention Control Training

Further Reading

- American Psychiatric Association. (1994). *Diagnostic and statistical manual of mental disorders* (4th ed.). Washington, DC: Author.
- Azrin, N. H., & Foxx, R. M. (1971). A rapid method for toilet training the institutionalized retarded. *Journal of Applied Behavior Analysis*, 4, 89–99.
- Azrin, N. H., Sneed, T. J., & Foxx, R. M. (1974). Dry-bed: Rapid elimination of childhood enuresis. *Behavior Research and Therapy*, 12, 147–156.
- Butler, R., Brewin, C., & Forsythe, I. (1990). Relapse in children treated for nocturnal enuresis: Prediction of response using pre-treatment variables. *Behavioral Psychotherapy*, 18, 65–72.
- Edgar, C. L., Kohler, H. F., & Hardman, S. (1975). A new method for toilet training developmentally disabled children. *Perceptual and Motor Skills*, 41, 63–69.
- Finley, W. W., Wansley, R. A., & Blenkarn, M. M. (1977). Conditioning treatment of enuresis using a 70% intermittent reinforcement schedule. *Behavior Research and Therapy*, 15, 419–427.
- Fisher, W. W., Piazza, C. C., Bowman, L. G., & Amari, A. (1996). Integrating caregiver report with a systematic choice assessment to enhance reinforcer identification. *American Journal on Mental Retardation*, 101, 15–25.
- Friman, P. C. (1995). Nocturnal enuresis in the child. In R. Ferber & M. H. Kryger (Eds.), *Principles and practice of sleep medicine in the child* (pp. 107–114). Philadelphia: Saunders.
- Friman, P. C., & Jones, K. M. (1998). Elimination disorders in children. In S. Watson & F. Gresham (Eds.), *Handbook of child behavior therapy* (pp. 239–260). New York: Plenum.
- Friman, P. C., & Vollmer, D. (1995). Successful use of the nocturnal urine alarm for diurnal enuresis. *Journal of Applied Behavior Analysis*, 28, 89–90.
- Gadow, K. D., & Poling, A. G. (1988). *Pharmacotherapy and mental retardation*. Boston: College-Hill Press.
- Gustafson, R. (1993). Conditioning treatment of children's bedwetting: A follow-up and predictive study. *Psychological Reports*, 72, 923–930.
- Hagopian, L. P., Fisher, W. W., Piazza, C. C., & Wierzbicki, J. J. (1993). A water-prompting procedure for the treatment of urinary incontinence. *Journal of Applied Behavior Analysis*, 26, 473–474.
- Luiselli, J. K. (1997). Teaching toilet skills in a public school setting to a child with pervasive developmental disorder. *Journal of Behavior Therapy and Experimental Psychiatry*, 28, 163–168.
- Mark, S. D., & Frank, J. D. (1995). Nocturnal enuresis. *British Journal of Urology*, 75, 427–434.
- Mowrer, O. H., & Mowrer, W. M. (1938). Enuresis: A method for its study and treatment. *American Journal of Orthopsychiatry*, 8, 436–459.
- Rushton, H. G. (1993). Older pharmacologic therapy for nocturnal enuresis. *Clinical Pediatrics*, 31, 10–13.
- Shaffer, D. (1985). Enuresis. In M. Rutter & L. Hersov (Eds.), *Child and adolescent psychiatry: Modern approaches* (pp. 465–481). Oxford: Blackwell.
- Siegel, L. J., & Smith, K. E. (1991). Somatic disorders. In T. R. Kratochwill & R. J. Morris (Eds.), *The practice of child therapy* (pp. 222–256). Boston: Allyn and Bacon.
- Starfield, B. (1967). Functional bladder capacity in enuretic and non-enuretic children. *Journal of Pediatrics*, 70, 777–782.



Object-Relations Psychotherapy

Frank Summers

Northwestern University

- I. The Origins of Object-Relations Theory
 - II. Developmental and Ethological Evidence
 - III. Clinical and Theoretical Basis
 - IV. The Object-Relations Model of Psychotherapy
 - V. Summary
- Further Reading

GLOSSARY

borderline syndrome A severe form of character pathology characterized by a high degree of instability, low frustration tolerance, impulsivity, demandingness, and little regard for others.

ego The part of the psyche charged with the responsibility of mastering competing pressures while maintaining the functional capacity of the organism.

narcissism An early state of infancy, often carried into adulthood in pathological states, in which the child is organized around the self and self-pleasures with little awareness of the desires of others.

object relation A relationship to an other seen from the viewpoint of the experiencing participant; includes both the way of relating to the other and the experience of the other in fantasy.

psychoanalytic therapy Any of a variety of psychotherapeutic approaches that seeks to uncover unconscious material and, thereby, achieve a depth understanding of the psyche.

resistance The tendency of psychotherapy patients to defend against the therapeutic process to protect against the uncovering of painful, unconscious material.

transference The unconscious tendency of psychotherapy patients to perceive the therapist in ways similar to important figures of the past, such as parents.

Object-relations psychotherapy is a growing and commonly used branch of psychoanalytic therapy. Beginning with the roots of this form of psychoanalytic therapy and its deviation from the classical model, this article shows the fundamental developmental principles on which this form of therapy is based and then demonstrates the basic concepts that define this therapeutic approach. Finally, the contributions of object-relations therapy to psychoanalytic treatment will be reviewed.

I. THE ORIGINS OF OBJECT-RELATIONS THEORY

When Sigmund Freud developed psychoanalytic theory and therapy, he did so on the basis of his view that repressed childhood memories were the source of neurotic symptoms, especially hysteria, the most prevalent form of psychopathology of his day. When he changed his view of pathogenesis from actual memories to fantasies, or wishes, he shifted psychoanalytic theory to a drive model. That is, Freud believed that the child's sexual wishes for the parent were the repressed material, rather than events. Freud's belief in the ubiquity of childhood sexual longings for the parent of the opposite sex led him to a drive-based view of human motivation. The eventual addition of the aggressive drive did not alter his view that our adult behavior manifests either repression or sublimation of our endogenous drives. These drives are biological in origin, seek satisfaction via tension relief, and have a fixed quantity of energy. The object of the drive is

the means for its satisfaction. The child becomes attached to figures who provide this tension relief. Interpersonal relationships, for Freud, are motivated by tension relief. The child is born under the sway of the pleasure principle, the need for tension relief, and gradually, through the necessary frustrations of life, becomes adapted to the reality principle, the recognition that the world will not provide the gratification of drive pressures whenever and wherever the need is felt. Out of this frustration, the ego, the adaptive capacity of the organism, is born, and in the healthy personality, the ego is primarily in charge of the individual's relationship to both drives and the world.

W. D. R. Fairbairn was the first psychoanalyst to question the drive basis of human motivation and propose an alternative based on object relationships. Fairbairn contended that the baby is not pleasure seeking as Freud thought, but "object seeking." Fairbairn believed that Freud's theory ignored the role of the self's relationship to the object. That is, the ego can grow only through satisfactory object relationships. If the parental figures do not provide good care, the ego cannot develop, and pathology results. Consequently, according to Fairbairn, the child seeks relationships before pleasure. Indeed, he pointed out that one sees pure pleasure seeking only in states of severe pathology in which the ego is "fractionated." Fairbairn pointed out that children, and even adults, prefer painful relationships to none at all. This would not be the case were the child governed by the pleasure principle, as Freud thought. Part of Fairbairn's evidence was the behavior of abused children. According to the pleasure principle, children should not attach to their abusers. However, in fact, as Fairbairn and others have found in their work with such children, they actually attach more stubbornly to their abusers than other children do to their caretakers. Fairbairn took this as evidence of the primacy of object attachments over pleasure in human motivation. On this basis, Fairbairn developed a theory of the personality as formed from attachments to early figures. These object relationships, not reducible to drive gratification or any other motive, are, according to Fairbairn, taken in, or "internalized" in the form of objects. That is, the child makes a part of the psyche the images of the caretakers, and these images become the blueprint for all later relationships.

The idea of internalization was not new with Fairbairn or object-relations theory. Psychoanalytic theory since Freud had seen the ego as formed from the legacy of early relationships. The decisive difference between Freud and object-relations theory is that the latter does not see the motivation to internalize early relationships as reducible to any other motive, whereas for Freud the child internalized the image of the parent in an effort to

master the frustration of childhood desires. That is, according to Freud, when the child finally realizes that longings will not be fulfilled, the child abandons the desire for the parent and internalizes the object to manage the loss. By contrast, object-relations theory sees internalization as motivated by the needs for self-development and a guide to navigate the interpersonal world.

II. DEVELOPMENTAL AND ETHOLOGICAL EVIDENCE

Fairbairn's intuitive insight that the infant seeks objects rather than tension reduction has now been substantiated by controlled empirical investigations. As early as 1960, Harry Harlow reported his famous experiment that baby monkeys attach to a cloth monkey that provides no nourishment rather than a wire monkey that gives them milk. At about that time John Bowlby began reporting ethological studies showing that subhuman primates will attach to whatever figure is available, even a different species, irrespective of whether the figure has a role in tension reduction. Bowlby also concluded that the available evidence indicated that human children also will attach to figures who have no role in the meeting of biological needs. Since this early pioneering work, a great deal of carefully controlled empirical investigations by a variety of researchers such as Daniel Stern and Beatrice Beebe has shown that the human child is "prewired" for a relationship with the caretaker. Distinguishing mother's voice and face from others in the early days of life, the child seeks interaction with others and shows pleasure when it is attained. This desire takes place irrespective of the meeting of drive reduction needs. The infant will learn tasks for the sole purpose of interacting with others. Furthermore, child and mother tend to form a relationship based on an interactional pattern from the inception of life. Independent of the meeting of tension reduction needs, the child not only seeks and helps to form and sustain this rule-based interactional system but also expects it. If the established patterns are not followed, the child becomes distressed. This evidence is but a small sampling of the data substantiating Fairbairn's claim that object relationships are autonomously motivated.

III. CLINICAL AND THEORETICAL BASIS

Since Fairbairn's pioneering work, a large group of psychoanalytic clinicians have adopted a clinical stance

based on the primacy of object relationships. These psychotherapists follow a psychoanalytic model in that they believe in the importance of unconscious motivation, the patient's defenses against awareness of unconscious motivation, and the uncovering of underlying meaning. However, they are decisively different from classical psychoanalysts in that they do not adhere to the drive model. Rather, they see the human organism as autonomously motivated to form object relationships and personality formation as a product of the object relationships internalized in the developmental process. This theoretical shift, based on clinical findings and an abundance of experimental results, has led to the development of a variety of clinical approaches built on the importance of object relationships. Each theory within the object-relations model has a somewhat different emphasis, but each is built on the principle that object relationships are the primary building blocks of the psyche.

Object relationships are interpersonal relationships seen from the point of view of the experiencing participant. They differ from interpersonal relationships in that they are not the relationship viewed in terms of its external behavior as seen from the viewpoint of a third person. For example, a third party might describe two people as having a "good" or "friendly" relationship, or a "bad" or "hostile" relationship, but an object relationship is the experience of one party to the relationship. So, while an observer might say two people have a "bad" relationship, one person might experience the self as trying to please an implacable other whom this person regards as possessing exceptional qualities. That is the object relationship. As can be seen from this example, an object relationship always includes a self-state, an "object," who is the target of the experience, and an affective link between the two. The object relationship tends to be complex, including unconscious motives and affects and complex interplays between participant and object. As long as the relationship is viewed from the viewpoint of the experiencing participant, it is an object relationship.

Because of the overriding importance of the attachment to the caretaker, the child will do whatever is necessary to secure this attachment. If the relationship requires the suppression of aspects of the self, those potential components of the self are arrested, thus crippling self-development. For example, if the caretaker will not tolerate aggressive feelings and requires that the child avoid all angry or aggressive expression, the child will learn not to feel or act in an aggressive manner. The aggressive component of the personality will be arrested, thus crippling all areas that rely on aggression,

such as self-assertion, ambition, and competitiveness. In this way, the object-relations viewpoint replaces the Freudian theory of symptom formation as rooted in internal defenses against drives with the conflict between the need for the object and the development of the self. What appears to be the repression of a drive is the child's burial of those potential aspects of experience that the child fears will be threatening to early caretakers. To some degree, such adaptations are an expectable part of life, as all caretakers require some adaptation from the child that does not allow for full self-development. However, when such accommodations interfere with the development of crucial components of the self, such as excitement, interest, enjoyment, aggression, and sexuality, the self will be fundamentally split in a way that arrests the development of essential components of the self. Winnicott called this division the split between the "true self" and the "false self." Those buried aspects of the self continue to seek expression and will gain it only through symptom formation. To continue with our example, the aggressive component of the self may seek veiled expression as a somatic pain or become part of a sadomasochistic sexual fantasy life.

From the object-relations viewpoint, all psychogenic pathology is a function of self-arrest induced by anxiety-driven object attachments. Pathological differences being due to the phase, degree, and type of arrestation, object-relations theory does not make decisive distinctions among causes and types of pathology. This view puts all psychopathology on a spectrum and makes distinctions among types of pathology a matter of degree.

All object-relations theories are built on the principle that development and psychopathology are a product of the object relationships internalized in the developmental process. However, theorists from various schools differ in emphasis and in details. For example, followers of Melanie Klein, known as Kleinians, tend to see drives as important to the formation of object relationships even if they see object relationships as the building blocks of all development beginning in early life. Kleinians view problems with the aggressive drive as fundamental to pathological states, although they acknowledge that all drives are seen only within object relationships. Fairbairn, as mentioned earlier, sees no role for drives in development or pathology. In contrast to the Kleinians, Fairbairn saw the child's most fundamental motive to be the need to love and have that love accepted by the caretaker. Donald Winnicott, a primary English object-relations theorist, saw the child's dependence on the mother and the phases of its relinquishment to be the most important variable in development and psychopathology. According to Winnicott, each infant is born with potential that cannot be

changed, but can be either facilitated or interfered with by caretakers. Impingement by the caretaker interferes with the maturational process, and this arrest in the development of the true self is the source of psychopathology, including the most severe forms. Many followers of Winnicott, such as Mhasud Khan, Margaret Little, and Andre Green, have used his work to apply object-relations concepts to the treatment of severe character and even psychotic disorders, thus broadening the scope of psychoanalytic therapy beyond the neurotic patients who tend to be the target of classical technique to the treatment of more severe emotional disorders.

Christopher Bollas, a contemporary Winnicottian, has shown how the mother's ministrations to the infant are taken in or "internalized" by the growing child. Bollas has pointed out that the original mother-child relationship becomes embedded in the psyche of the child in a way that results in a unique personal idiom the growing child and adult is unaware of, but always knows is there. Bollas calls this personal idiom the "unthought known."

Heinz Kohut developed a school of psychoanalysis that has come to be known as self psychology. In Kohut's view, the child is born with a nascent self that comes to fruition as a function of the interplay between the child's "nuclear program of the self" and the caretaker's ministrations. The child's experience of a caretaker is called a self-selfobject relationship. A selfobject is an other experienced as a provider of functions for the self. The degree to which the selfobject provides necessary functions abets the development of the nuclear program via a process of "transmuting internalization," a microscopic "taking in" of the selfobject until the internalizations replace the archaic forms of narcissism characteristic of infancy and early childhood. Disruptions in the self-selfobject relationship cause vulnerabilities in the emerging self and the need to protect this vulnerability by splitting off the original narcissistic state that, being unresolved, continues its influence on the personality. Although self psychologists prefer to regard their theory as wholly unique in psychoanalytic thought, the fact is that their view of self-development as a function of the relationship to early objects and the internalization process fits this school into the object-relations rubric. It is true that self psychology differs from other object-relations theories in its emphasis on the importance of self-esteem in normal development and vulnerabilities to self-esteem in psychopathology. However, this uniqueness exists within the object-relations paradigm that views self-development as a product of the relationship between self and object and the internalization of the latter by the former. Each form

of object-relations theory has a unique emphasis; that is why there are different viewpoints within the object-relations model.

Whatever the particular differences in detail and emphasis, each object-relations theorist sees the child's absorption of the early relationships with caretakers to be fundamental to the growing personality of the adult. These internalizations are the legacy of the early object relationship and are often referred to as "internalized object relationships." From an object-relations viewpoint, who we are is fundamentally a product of our internalized object relationships. It is important, however, to emphasize that these internalizations are not regarded as copies, as though the mind is composed of the wholesale absorption of the childhood view of the early figures. What the child takes in from the parental figures is a complex creation based on the child's experience with the figures. If this were not the case, people would be photostatic copies of their caretakers. The child's internalized images of the parents are based on the child's experience with the caretaker, but the child creates meaning from this experience that cannot be reduced to the parental behavior. Again, this view of internalization is substantiated by developmental research. Virginia Demos, who researches affective development, has found that the child does not take in the parents' behavior, but makes meaning out of it, and this meaning is the legacy of the parent-child interaction. The lasting impact of the relationship on the child has been referred to by Christopher Bollas as "the shadow of the object." These "shadows" form the template of the child and growing adult's pattern of interpersonal behavior.

When the early caretakers do not meet the child's needs well, the child will experience the caretaking figure as traumatizing. To master the trauma while maintaining attachment to the traumatizing figure, the child will internalize the figure as a "bad object." These internalized bad objects become the source of psychic distress, self-abuse, and many forms of psychopathology. For example, the child may internalize the caretaker's attacks. Treating himself as he was treated, the child has an internalized bad object that may be relentless in flagellation of the self for every mistake or peccadillo. Such a patient will complain of being "hard on myself," or being a "perfectionist." Or, to take another example, the bad object may be projected onto others resulting in a paranoid stance to the world. These are just two of many possible outcomes. Whatever the result of the bad object experience, it will result in some form of pathological expression. All of this has far-reaching clinical implications.

IV. THE OBJECT-RELATIONS MODEL OF PSYCHOTHERAPY

This object-relations theory of development and pathology has direct implications for the conduct of psychoanalytic therapy. Due to its emphasis on the importance of attachments and the legacy of the child's interactions with caretakers, the focus of an object-relations clinical approach is the object-relations structure that gives rise to the symptoms or inhibitions. Consequently, the goal of any object-relations approach is to uncover the object relations internalized in childhood and early life and help the patient relinquish them and create a new object-relations structure that fosters self-development. Thus, in the object-relations model the traditional emphasis on discrete affects is replaced by a focus on the structure of the self.

Object-relations therapy looks at each symptom as an outgrowth of an anxiety-driven object relationship. For example, in the case discussed earlier of the patient who had to disavow any aggressive expression to secure the tie to the early caretaker, the emphasis in object-relations therapy would not be as much on "repressed aggression" as on the object relationships that required the disavowal of aggressive experience. In this case, the caretaker was threatened by aggressive expression, a threat that led to an internalized object relationship in which aggression threatens relationships. The developmental origins of the child's relationship with the caretaker who could not permit aggression would be a first critical step in the understanding of the patient's fear of her aggressive feelings. The internalized object relationship in which aggression is a threat to the object would then be the source of the aggressive inhibition. The consequence of this inhibition is an arrest of the patient's self-development that interferes with all aspects of life that require aggression, such as self-assertion, ambition, and competitiveness.

A. Resistance

One of the most vexing problems in any form of psychotherapy is the strength and resilience with which patients tend to cling to their painful and dysfunctional patterns. From the object-relations viewpoint, the patient's relational patterns reflect an underlying object-relational structure. Therefore, to relinquish the current patterns, no matter how painful or dysfunctional they may be, is tantamount to separating from the objects of the past. If the patient gives up the internalized bad mother, she has yielded the only tie to the mother of her

childhood. This is an intense, painful loss for the patient. One might wonder why the loss is so painful and so strenuously avoided given that the object is "bad," painful. This is one of the great ironies of object relationships and the human condition: As mentioned in the first section of this article, the more painful the early relationships, the stronger is the clinging to the object. As Fairbairn pointed out a long time ago, the painful early relationships create anxiety and the need to attach ever stronger to the abusive object. The abused child is more attached to the abusive parent than is the healthy child to his parent. Similarly, the adult subjected to abuse and pain by an early caretaker holds on tenaciously to the internalized bad parent, whereas the child raised in a healthy environment tends to more easily separate from the internalized parental figures. Patients who suffered from abusive, painful parental relationships are filled with anxiety that leads them to cling desperately to bad internalized objects. This is why such patients are so difficult to treat.

Furthermore, this object-relations structure forms the fabric of the self. To give up the object is in a very real sense to give up the self. As Fairbairn pointed out many years ago, every internalized object is a piece of self-structure, so that to yield the object is to relinquish a part of the self, a loss that evokes annihilation anxiety, the dread of nonexistence. In this way, the object-relations approach makes a unique contribution to understanding the patient's attachment to painful and dysfunctional patterns.

It follows that a critical step in the resolution of pathological patterns lies in the understanding of the origin of the patient's unconscious object-relationship structure. The therapeutic task in each case is to identify and help the patient relinquish the object-relations structure that underlies the symptom or inhibition. For example, many depressed and masochistic patients will berate themselves mercilessly for seemingly trivial mistakes, and some will unconsciously seek out punishment for peccadilloes. They know that their behavior toward themselves creates pain, but they are unable to break free from their patterns. Even after the patient is well aware of the origins and meaning of her self-abuse, she is unable to control it. The object-relations model understands the patient's self-flagellation as an internalized bad object; the unconscious need to be punished is a product of a feeling of badness that originates in such an object. To change her self-abusive behavior is to separate from the abusive figure of the past. This example is prototypical of the object-relations interpretive emphasis on anxiety-driven early attachments and the resulting object-relations

structure that strangulates self-development, in contrast to the classical emphasis on defenses against endogenous drives or discrete affects.

However, awareness of the object-relational structure in itself tends to have limited mutative effect. Here the object-relations model makes a contribution to the time-honored problem of “resistance.” Clinicians from Freud to the present day have found that even after patients seem to have a good understanding of the underlying motivations and developmental origins of their problems, they tend to remain frozen in their patterns. They know what they are doing, but continue to do it anyway, and seem unable to control their repetitive patterns. Freud and generations of subsequent analysts have identified the problem of the persistence of pathological patterns despite insight, a problem classical analysts call “resistance.” From this perspective, resistance is motivated by the patient’s fear of knowing specific information regarding his wishes or past experiences. Here again the object-relations viewpoint has a unique contribution to make. The object-relations perspective sees the patient’s attachment to these patterns as a reflection of an underlying object-relations structure woven into the fabric of the self. As we have seen, the patient is clinging to old objects and the sense of self. Awareness, no matter how meaningful, can have little mutative impact on the structure of the self. Therefore, from an object-relations viewpoint, the recalcitrance of patterns even after awareness is a product of a clinical strategy that: (a) focuses on understanding affects and “impulses” without appreciating the underlying self structure and (b) relies exclusively on interpretation. Because interpretation cannot alter the object-relations structure, pathological patterns will remain stubborn until the therapeutic relationship provides an alternative to the old, familiar patterns. The therapist is often opposed, or even disliked or hated, because she represents the effort to loosen the patient’s bond to the object and thereby threaten the self. The patient’s adherence to the bad object is not treated as resistance, but an anxiety-driven attachment that the therapist will understand and interpret. So, “resistance” from this viewpoint is not resistance at all, but clinging to a desperately needed object.

B. The Patient–Therapist Relationship

Although interpretation is important for making the patient aware of her object-relations structure, awareness by itself does not create new structure. Consequently, in most object-relations approaches to psychotherapy, mak-

ing conscious the patient’s early experience is considered necessary but not sufficient to effect lasting therapeutic change. It is here that the relationship between patient and therapist becomes crucial. The therapeutic relationship must create the conditions in which the patient can create new, more adaptive, authentic, and meaningful object relationships to form the basis for new psychic structure. Object-relations theorists vary in the emphasis they put on the therapeutic value of the patient–therapist relationship, but all, including Kleinians who have traditionally emphasized interpretation, see a critical role for the therapeutic relationship in the patient’s ability to create a new object and healthier psychological structure.

Winnicott viewed the psychotherapeutic relationship as a “transitional space” akin to the child’s use of a transitional object, such as a blanket or teddy bear. Winnicott pointed out these attachments are transitional between the world of omnipotent fantasy life of early infancy in which the child has the delusion that she meets her needs by their very existence and the later appreciation for the world of objective reality in which the child recognizes that people and material objects exist apart from her, outside of her control. There is a third world, according to Winnicott, between fantasy and objective reality, that must be traversed before the child can accept objective reality. In this transitional world, the child knows objects exist outside of her control but treats them as though they are part of her. Transitional experience is the basis for play, creativity, and aesthetic experience. To play one must know what objects are but treat them according to illusions of one’s own creation. The clay is molded into a shape the child calls a “fish.” The child knows the clay is not a fish but puts it in the water to swim. It is equally important that the child adapt to the materials at hand. The child must mold the clay for the play to work. The limitations of the materials differentiate play as a transitional experience from fantasy. If she tries to mold wood, or water, she will not see a “fish.”

Winnicott viewed the psychotherapeutic relationship as a transitional space in which the therapist provides the conditions the patient can use to create new ways of being and relating. The patient has to operate within the objective constraints of the setting, analogous to play materials, but within that boundary creates the relationship she needs. What is created between therapist and patient is unique to the pair. The success of the therapeutic enterprise is a function of the degree to which the created relationship facilitates the development of the true self. Thus, it is not interpretation that is ultimately mutative for Winnicott, but what

the patient creates in the transitional space of the therapeutic relationship. In object-relations therapy, the patient's use of the therapist is decisive for therapeutic outcome rather than the therapist's understanding. The therapist's role is not so much to offer information about the patient as to create the kind of relationship the patient can use to create something the patient has never had before. The therapist's role, then, is to adapt to the patient's needs, rather than find the correct understanding of the patient's unconscious. This adaptation is different for each patient, but it always includes the provision of a space that the patient can use to create something new. This conception of the therapeutic process is decisively different from the classical model in which the assumption is made that understanding is sufficient to produce the desired changes.

The therapeutic action, then, is the patient's use of the analytic space to create a new object relationship with the therapist that facilitates the articulation of arrested aspects of the self. Endemic to the therapeutic process is the creation of new ways of being and relating. This point requires emphasis because it is regarded by object-relations theorists as a major advantage over the classical psychoanalytic model in which the analyst is limited to interpreting the unconscious, and the patient's role is confined to receiving the analyst's understanding or "taking in" the analyst in the form of internalization. What the patient passively receives from the therapist may or may not be meaningful or authentic, but what the patient creates is the articulation of buried aspects of the self that are deeply authentic and meaningful because the patient created them.

In this model the concept of transference is broadened beyond the patient's projection of a past image onto the therapist. Just as in any other relationship, the patient forms the relationship she needs based on a variety of factors, one of which is past object relationships. Because this relationship is based on the patient's hopes and desires, adaptation to the current situation, defenses against the anxiety it causes, as well as the patient's history, this creation is rarely a simple copy of early relationships. This relationship will be a complex amalgam that shifts as the relationship evolves. Most object-relations theorists have a concept of transference broader than the traditional notion that includes the patient's creation of something new with the therapist, so that the transference is regarded as a complex blend of past images and present adaptations. That is to say, transference is not reduced to the repetition of past patterns; it includes the patient's contributions, often developed for the first time in the therapeutic process. For

example, an inhibited patient may eventually explode with rage at the therapist, not because she is repeating an early relationship, but because she feels safe enough with the therapist to risk including an aggressive component in the relationship, an element that may be wholly new in the patient's experience. Or, sometimes the patient who feels cheated by having a weak father will idealize the therapist to create a relationship that he desires but never had. This type of object relationship has its own problems, but its very existence indicates that the transference is not the clear repetition depicted by classical psychoanalysis.

C. The Creation of a New Object Relationship

Like the classical psychoanalytic therapist, the object-relations therapist interprets the transference, but she is not prone to reduce every aspect of the therapeutic relationship to the patient's past experience. The object-relations therapist tends to search not only for the roots of the relationship in the patient's past, but also the adaptive function of the relationship in the present. Perhaps the patient idealizes the analyst because such an idealizing object relationship provides the protection lacking in the early caretaker relationship. The therapist interprets not only the lack of protection in the past, but also the safety afforded by the creation of an idealized therapeutic relationship. However, the object-relations therapist is never satisfied with interpretation alone. The therapist interprets the idealizing transference as a means toward helping the patient relinquish it so that a new type of object relationship may be formed. She then provides the opportunity for the patient to form a relationship that does not repeat the patterns of the past. In our example of the idealizing transference, the therapist attempts to facilitate the formation of a safe, protective relationship so that the patient may be able eventually to have this relationship without the unrealistic idealizing perception of the therapist. To use another example: The therapist helps the inhibited patient include aggression in his therapeutic relationship without feeling threatened that the aggressive expression will damage the relationship.

The therapist will include with interpretation the facilitation of a new relationship with the patient to replace the internalized bad object. Fairbairn referred to this new therapeutic relationship as the "beneficent parental figure." Some Winnicottians refer to the "good enough mother/therapist," and self-psychologists emphasize the provision of "selfobject functions."

Whichever nomenclature is used, all these terms signify the therapist as offering a new, different kind of relationship. The purpose of this relationship is to adapt to the patient so that the patient has the opportunity to create a more positive, benevolent object than the bad object it replaces. This active provision of a new, different relationship is one of the decisive differences between the object-relations model of psychotherapy and the classical psychoanalytic viewpoint. From the latter perspective, the therapist should never become a different object but rather interpret the patient's desire for her to become such an object. From this viewpoint, the object-relations strategy is a gratification of the patient's wishes and, therefore, is a technical error. By contrast, the object-relations model sees the fabric of the personality as consisting of internalized objects and the health or pathology of the individual as a direct product of the nature of these objects. Therefore, from this viewpoint, anything the therapist can do to facilitate the relinquishing of old, negative objects and their replacement with new, good objects is beneficial to the therapeutic process and the goals of the therapy. Having said that, it needs to be emphasized that the object-relations model does not believe that simply "being different" will effect the desired therapeutic effect. The old object-relations structure forms the very fabric of the self and will not be easily given up. This is why a new relationship in the patient's life will rarely affect lasting psychological change. In fact, often patients enter psychotherapy because they are in danger of damaging a potentially positive relationship by operating in accordance with their long-standing patterns. If psychotherapy is necessary, that is because a new relationship is insufficient to produce change and may even be threatened by the patient's old pathological patterns. As mentioned earlier, the object-relations structure formed in early childhood tends to be resilient because the patient is attached to not only her internalized objects but also her sense of self derived from them. The patient's object-relations patterns must be interpreted so that she can see their origins and damaging consequences before the therapist's influence as a new object can be experienced. The former allies the object-relations model with the classical psychoanalytic perspective, and the latter decisively separates it from the traditional viewpoint.

D. The Widening Scope of Psychoanalytic Therapy

A major advantage of this model is that it applies to a wide variety of patients, including many who were believed to be inaccessible to in-depth psychotherapy from the classical perspective. According to the latter view-

point, the crux of psychoanalytic therapy is the resolution of intrapsychic conflicts caused by the repression of forbidden wishes. Consequently, patients for whom the very structure of the psyche is malformed were considered unsuitable for in-depth psychotherapy. The object-relations model blurs this either/or distinction between intrapsychic conflict and character pathology. If a conflict requires treatment, then the conflict has not been mastered by the structure, resulting in a symptomatic outbreak. Even the mildest case of neurosis must have some defect in the structure of the personality for the conflict to have erupted in a symptom. The distinction between intrapsychic conflict and character disorder is a matter of degree, as every patient has each to some extent. Consequently, the psychic structure must be addressed in every case. In terms of clinical strategy the implication is that both types of problem are resolved with a combination of interpretation and the provision of a new relationship. By including the importance of the therapeutic relationship in the therapeutic action, the object-relations model has found a way to address character issues, even primitive characterological expressions, with a psychoanalytic framework.

This widening scope of psychoanalytic therapy is one of the most profound implications of the object-relations approach to treatment. By addressing the object-relations structure of the personality via interpretation and the inclusion of the provision of a new relationship, psychoanalytic therapy becomes accessible to severe psychopathology. In the case of the most severe form of non-psychotic character pathology, the borderline syndrome, object-relations therapists have devised strategies designed to address the primitive needs and demands of those patients. Again, Winnicott was a primary leader in this movement. Following an object-relations model that sees the borderline patient as an arrest in the early development of the self, Winnicott responded to the expressed desires of such patients, rather than "setting limits" on them. His reasoning was that the patients' needs were not responded to in childhood, leading to a defensive protective response on the patient's part. This defensive shell buries the early needs and leads to the demandingness so typical of borderline patients. The hostility and oppositionalism of the borderline patient is seen as part of the protective posture. In fact, the patient defends against all needs and desires for others because the intensity of those needs is painful, frightening, and shameful. However, precisely because the needs are so intense, the patient is hungry and demanding. What makes these patients so difficult and perplexing to the clinician is the combination of the intensity of their longing and avoidance of all contact.

Winnicott's clinical strategy was to take seriously the patient's longings and respond to them any way he could. He regarded the therapist's responsiveness to the patient's needs to be far more important than interpretation in the treatment of such patients. He let the patient take the lead in where the treatment would go. If the patient needed to rage at him, he would allow that and "hold" the rage. If the patient needed to regress to infantile needs, he would allow the patient to curl up, hold a blanket, wander around the room, sleep, or do whatever the patient felt she needed. Any such patient behavior, if spontaneous and authentic, he regarded as an expression of a developmentally arrested state that must be met by the therapist's active responsiveness. He allowed the patient to determine what happened because in this way the development of the patient's arrested true self was facilitated. He conceptualized the therapist's role as the facilitation of the resumption of arrested growth. As can be seen, this is not a conflict model, but a model based on developmental arrest. Winnicott believed that such arrests required the meeting of the early needs in some way to stimulate arrested growth. Interpretation alone could never accomplish this type of renewal.

From this example of Winnicott's treatment of the borderline patient, one can see that the object-relations model is based on responsiveness to needs, rather than always interpreting them, a limitation of the classical viewpoint. According to object-relations theory, such gratification of the patient is not only called for but is a necessary ingredient of the treatment. Whereas for a neurotic patient, this meeting of "regressed needs" may be unnecessary or at most play only a small role in the process, with the borderline patient it is the essence of therapeutic action. Although this meeting of early needs can never replace what is missing from the past, it gains a responsiveness in the patient that allows for a new beginning, a beginning in which the patient can begin to live in accordance with her authentically experienced self. This meeting of regressive needs and the willingness of the therapist to allow the patient to stay in the regressed state as long as necessary is the crux of therapeutic action with severely disturbed patients, according to Winnicott. Harry Guntrip, a foremost object-relations therapist, called this process "meeting the needs of the regressed ego." Even contemporary Kleinians, such as Herbert Rosenfeld, see the relationship and the needs it meets for the patient as the most crucial factor in the therapeutic action with patients who are severely disturbed. The key for Winnicott as for most object-relations therapists is that the patient determines the depth and length of regression, and therapist's role is to be responsive to the patient. The elucidation of this treatment approach to

character pathology, including substance abusers, food disorders, narcissistic personalities, and depression, among others is one of the seminal contributions of object-relations psychotherapy to psychoanalytic therapy and psychotherapy in general. There are many cases reported in the literature of successful psychotherapy conducted by object-relations therapists with borderline and other patients with character disorders.

SUMMARY

Object relations psychotherapy is built on the principle that the child's relationships with early figures are autonomously motivated. The child meets the parental ministrations with innate affective dispositions to form a unique personal idiom. This parental relationship is internalized by the child as internalized object relationships that form the character structure. The degree to which the child's innate direction is facilitated by the environment is the extent to which the personality becomes healthy. Impingements that interfere with the maturational process force the child's maturational process away from this inborn direction to a self protective stance that arrests the articulation of the personal idiom. If significant aspects of the self are blocked, this buried self will seek veiled expression as a symptom. Consequently, object relations therapy is directed both to understanding the defensive constellation and facilitating the articulation of buried affective dispositions that lie beneath it. Emphasis is placed on insight into the transference and the patient's creation of a new object relationship with the therapist. Thus, both interpretation and the therapeutic relationship are mutative factors in this type of psychotherapy. Insight helps to understand the patient's defenses and current character patterns, and the therapeutic relationship fosters the development of alternatives based on authentic affective experience. Consequently, the therapeutic relationship is given considerable weight in the therapeutic action of object relations psychotherapy. This model widens the scope of psychoanalytic treatment beyond neurotic conditions to characterological disturbances.

See Also the Following Articles

Character Pathology ■ Couples Therapy: Insight Oriented ■ Humanistic Psychotherapy ■ Oedipus Complex ■ Projective Testing in Psychotherapeutics ■ Rational Emotive Behavior Therapy ■ Sullivan's Interpersonal Psychotherapy ■ Working Alliance

Further Reading

- Fairbairn, W. R. D. (1952). *Psychoanalytic studies of the personality*. London: Tavistock.
- Greenberg, J., & Mitchell, S. (1983). *Object relations in psychoanalytic theory*. Cambridge, MA: Harvard University Press.
- Guntrip, H. (1969). *Schizoid phenomena object relations and the self*. New York: International Universities Press.
- Guntrip, H. (1971). *Psychoanalytic theory, therapy, and the self*. New York: Basic Books.
- Kernberg, O. (1976). *Object relations theory and clinical psychoanalysis*. New York: Jason Aronson.
- Modell, A. (1968). *Object love and reality*. New York: International Universities Press.
- Summers, F. (1994). *Object relations theories and psychopathology*. Hillsdale, NJ: The Analytic Press.
- Summers, F. (1999). *Transcending the self*. Hillsdale, NJ: The Analytic Press.
- Winnicott, D. (1965). *Maturational processes and the facilitating environment*. New York: International Universities Press.
- Winnicott, D. (1975). *Through paediatrics to psychoanalysis*. New York: Basic Books.

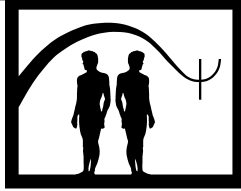

Objective Assessment

James N. Butcher

University of Minnesota

- I. Introduction
 - II. Treatment Planning
 - III. Providing Test Feedback to Clients in Psychotherapy
- Further Reading

GLOSSARY

Butcher Treatment Planning Inventory (BTPI) An objectively derived, self-report, structured personality inventory that endeavors to obtain and organize relevant personality and symptomatic information into a cohesive picture to be used for treatment.

Minnesota Multiphasic Personality Inventory-2 (MMPI-2) A comprehensive, objective, self-report, personality inventory that provides the tester or practitioner with a general picture of the client's symptoms, beliefs, and attitudes.

multimodal therapy An approach to planning and delivering psychotherapy that takes into consideration a variety of different domains of functioning, including behavior, affective processes, sensation, images, cognitions, interpersonal relationships, and biological issues. These functions also relate to therapeutic techniques.

I. INTRODUCTION

Mental health professionals conducting psychotherapy are initially faced with the question of how to de-

sign a treatment regimen that suits the unique needs of the client. Clinicians must identify the patient's problem areas that need to be addressed and evaluate the client's personal qualities and strengths needed to solve the present problems. Regardless of the mode of psychological intervention, whether it is psychodynamically oriented psychotherapy or behavior therapy, the mental health practitioner must appraise the client's problems, motivations, strengths, and limitations if the intervention is to proceed toward a successful outcome. In an effort to understand these pertinent "patient variables" many therapists rely on personality and symptom information from psychological evaluations to accomplish this important task.

The assessment process typically involves using objective psychological tests that provide the practitioner with clues to the psychological and environmental characteristics involved in the problems and identify factors that might contribute to a positive outcome. Effective psychological assessment in pretreatment planning can add considerably to the likely success of psychotherapy by providing the therapist with an objective appraisal of the client's problems, psychological resources, and potential treatment failures due to resistance. Moreover, psychological test results can also be effectively incorporated into the treatment process as a medium for facilitating change in therapy.

There are several reasons why psychological assessment should be incorporated into the early stages of psychological treatment planning:

1. It is important in the early stages of therapy to assess the severity of the patient's mental disorder to ensure that the treatment focus is appropriate and effective for the client;

2. Obtaining an objective personality evaluation can also help the therapist uncover personality factors that could lead to treatment resistance. For example, some clients rely on psychological defense mechanisms such as projection and avoidance of blame to deal with conflict;

3. In the early stages of therapy it is also important to appraise the client's strengths that can be drawn on in crisis situations or circumstances that require change; and information on the client's personality characteristics in the early stages of therapy can be employed to facilitate the treatment process through providing personality feedback to the client.

II. TREATMENT PLANNING

Three assessment strategies used in pretreatment assessment are described briefly to illustrate the information that can be obtained in the assessment process. The assessment strategies described in this article are not tied to a particular treatment orientation or limited to a specific psychotherapeutic approach but address the important task of assessing the client's symptoms, motivations for treatment, and likely patterns of treatment resistance.

A. Multimodal Therapy

Although its initial focus and orientation was strictly behavioral in nature multimodal therapy has developed into a model in which all treatment orientations can be included. Lazarus noted in 1981 that its goal is not to fit clients to the "treatment," but rather to illustrate precisely how to fit the therapy to the requirements of the client. This approach by Lazarus employs a model of human personality that is composed of the following component behaviors, affective processes, sensations, images, cognitions, interpersonal relationships, and drugs (more accurately termed "biological functions"). Each of these areas of functioning must be understood before effective treatment can be initiated. The practitioner pays clear attention to excesses and deficits in each assessment area. The practitioner uses several approaches to assess these attributes, for example, interviews, observations, and questionnaires. Multimodal therapy begins with assessment, which traditionally has

been considered to be the most important step in the process.

In terms of assessing behaviors in pretreatment planning, the therapist and client must consider what the client is doing or not doing that is interfering with his or her life. The therapist and client need to come to terms with what behaviors should be increased and decreased in frequency for therapy to be successful. For the assessment of the second area for multimodal therapy, affect, the therapist needs to determine what situations or events elicit different emotional responses in the client. What negative feelings, such as depression or anxiety, is the client experiencing. The third area to assess, sensation-related concerns, involve the clients' preferences for what they hear, see, smell, taste, and touch. Are they experiencing any particularly negative sensations, such as tension, dizziness, pain, or tremors? Next comes the assessment of images that require an evaluation of the effects particular images have on the clients' behaviors, affect, and sensations. The focus of the next assessment domain, cognitions, include opinions, values, beliefs, and attitudes. Do the patients hold any irrational beliefs or ideas that interfere with their functioning? An extremely important area to assess in pretreatment planning is the quality of the patient's interpersonal relationships. The final step in the assessment involves an assessment of the client's physical health including substance use or abuse. This task involves appraisal of the client's current use of alcohol, illicit drugs, and prescription medications.

Once the therapist has acquired the necessary relevant information, the next step in the process is to develop a modality profile, which provides a "blueprint" for establishing the goals of treatment and allowing both the patient and therapist input into what treatment will entail. In addition to being used to formulate treatment goals, the profile may also enable the client to aid the therapist in selecting the most appropriate psychotherapy strategies. Lazarus advocates the use of a wide variety of principal techniques representing a broad range of theoretical orientations, with particular emphasis given to behavioral therapy, rational-emotive therapy, and cognitive therapy.

B. Minnesota Multiphasic Personality Inventory (MMPI-2)

The most widely used personality measure used in pretreatment evaluation is the Minnesota Multiphasic Personality Inventory (MMPI). This inventory was developed in the 1940s as a means of evaluating mental

health problems in psychiatric and medical settings. The original test developers considered it crucial in evaluating patients' problems to ask them about what they felt and thought. The MMPI is a self-report personality scale that includes a very broad range of problems and was developed according to rigorous empirical research methods. The MMPI was revised and updated in 1989 and provides a broader range of clinical information than the original test.

The MMPI-2 is a comprehensive objective self-report personality inventory that provides the practitioner with a general picture of the client's symptoms, beliefs, and attitudes. The MMPI-2 contains 567 true-false questions addressing mental health symptoms, beliefs, and attitudes that are grouped into scales (clusters of items) that address specific clinical problems such as depression or anxiety. An MMPI scale allows the clinician to compare the responses of the client with those of thousands of other people. To gain a perspective on what the patient's test results mean, the MMPI-2 scores are compared to the normative sample, a large representative sample of people from across the United States. This comparison allows the interpreter to determine if the person's responses are different from people who do not have mental health problems. If the patient obtains scores in the extreme ranges, for example on the Depression scale (compared with the normative sample) then they are likely to be experiencing problems comparable to the clinical samples of depressed clients that have been studied. The MMPI-2 results provide the practitioner with a clearer understanding of the patient's symptoms and personality features and help to identify possible areas to explore in therapy.

C. Butcher Treatment Planning Inventory (BTPI)

The BTPI was created for the purpose of incorporating objectively derived, self-report information into the treatment process when a tactical therapeutic approach is being formulated and time is crucial. The BTPI assists the therapist by obtaining and organizing relevant personality and symptomatic information into a cohesive picture early in the treatment process.

The BTPI is a structured personality inventory that takes about 30 min. to administer. It contains several empirically validated scales that were developed to provide treatment-relevant information about clients. Three types of scales are included: validity or response attitude measures, treatment-related attitudes, and major symptom areas. The first cluster of scales assesses the client's cooperativeness with the personality evalua-

tion. Four scales address different test-taking strategies presenting an overly positive self-view, symptom exaggeration, inconsistent symptom presentation, and non-compliant treatment attitudes. The second BTPI cluster consists of five scales that assess specific treatment-related issues: problems in relationship formation, somatization of conflict, low expectation of benefit, self-oriented narcissism, and lack of perceived environmental support. The third symptom cluster addresses the following symptom areas: anxiety, depression, anger-in, anger-out, and psychotic thinking.

The practitioner obtains a summary of the client's likely cooperativeness in engaging into the therapy process, clues with respect to several areas of treatment resistance, and an indication of the extent to which anxiety, depression, anger, or unusual thought processes are likely to be encountered in the treatment process.

III. PROVIDING TEST FEEDBACK TO CLIENTS IN PSYCHOTHERAPY

Clients who are provided test results in the early stages of psychotherapy tend to improve as a result of the test feedback process. This strategy, referred to as "assessment therapy," is a procedure in which the therapist uses a feedback model to review psychological test information with the client and thereby promote the process of behavioral change. Several studies have shown that providing psychological test results to clients early in therapy can have powerful effects in terms of lowering symptomatic status and increasing self-esteem in patients. Research on assessment therapy has shown that providing psychological test feedback is an effective means of engaging the client in the treatment process early in the therapy and produces positive treatment effects by informing the client of likely problems, personality characteristics, and strengths.

In summary, psychological assessment in the early stages of psychotherapy can provide the clinician with a great deal of valuable, objective information concerning the clients problems and strengths. Moreover, the judicious incorporation of the test results into the therapy by using test feedback can facilitate the treatment by engaging the client in the process early in therapy.

See Also the Following Articles

Behavioral Assessment ■ Behavioral Case Formulation ■ Cultural Issues ■ Functional Analysis of Behavior ■ Individual Psychotherapy ■ Multimodal Behavior Therapy ■ Neuropsychological Assessment ■ Outcome Measures

Further Reading

- Ben-Porath, Y. S. (1997). Use of personality assessment instruments in empirically guided treatment planning. *Psychological Assessment, 9*, 361–367.
- Butcher, J. N. (1998). *The Butcher treatment planning inventory (BTPI): Test manual and interpretive guide*. San Antonio, TX: Psychological Corporation.
- Finn, S. E., & Martin, H. (1997). Therapeutic assessment with the MMPI-2 in managed health care. In J. N. Butcher (Ed.), *Personality assessment in managed health care: Using the MMPI-2 in treatment planning* (pp. 131–152). New York: Oxford University Press.
- Finn, S. E., & Tonsager, M. (1992). Therapeutic effects of providing MMPI-2 test feedback to college students awaiting therapy. *Psychological Assessment, 4*, 278–287.
- Graham, J. R. (2000). *MMPI-2: Assessing personality and psychopathology* (3rd ed.). New York: Oxford University Press.
- Lazarus, A. A. (1989). *The practice of multimodal therapy: Systematic comprehensive, and effective psychotherapy*. Baltimore: Johns Hopkins University Press.
- Perry, J. N. (2002). Assessment of treatment resistance via questionnaires. In J. N. Butcher (Ed.), *Clinical personality assessment* (2nd ed.,) (pp. 96–108). New York: Oxford University Press.

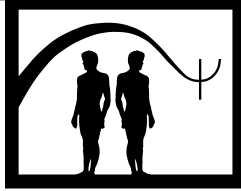

Oedipus Complex

Jodi H. Brown

The Institute of the Philadelphia Association
for Psychoanalysis

Alan Sugarman

San Diego Psychoanalytic Society and Institute, and
University of California San Diego

- I. Historical Context
 - II. Current Clinical Relevance
 - III. Conclusion
- Further Reading

GLOSSARY

castration complex A universal unconscious fantasy that women are castrated and inferior because they do not possess a penis. Castration refers to real or fantasied loss or injury to the genitals of either gender in general psychoanalytic usage.

compromise formation Any mental phenomenon that is the product of internal conflict and that expresses all components of the conflict.

conflict Opposition between mental forces. These forces can be instinctual or Freud's structures of the mind (id, ego, superego).

defense The methods used by the ego to master and control id impulses or superego injunctions.

ego The hypothetical construct defined in Freud's structural model to enable the mind to organize its various components and to adapt to the external world.

ego ideal A set of functions within the superego. These include ideal representations of the self and idealized representations of the love object.

fixation Persistent, infantile modes of gratification, object relations, and defenses are thought to be fixed in the mind and available to be regressed to at later moments of stress.

identification The process by which a person borrows his or her identity from someone else through internalizing aspects of the other person into the self-representation. Identifi-

cation is often seen as the most mature level of internalization by modern psychoanalysts.

infantile neurosis A confusing psychoanalytic concept that, at times, is used to refer to the childhood neurosis that is assumed to antedate all adult neuroses and, at other times, to the intrapsychic conflict that occurs during the Oedipus Complex.

libidinal wishes Wishes infused with affectionate or sexual urges thought to be ubiquitous in human functioning.

libido The hypothetical psychic energy attached to the sexual instincts.

narcissistic injury Experiences of having one's self-esteem lowered that are accompanied by painful affects of sadness, embarrassment, or humiliation.

neurosis Refers to psychological symptoms that develop from mental conflict that is primarily unconscious and derived from experiences in childhood.

object relations Refers to relationships to other people. In psychoanalysis, it is the internal representations of self and others that are important in motivating and mediating interpersonal interactions. A developmental distinction is often made between dyadic and triadic object relations. The former refers to relationships modeled on pre-Oedipal experiences where the major goals of the child revolve around need satisfaction by the mother. Triadic relations are seen as more mature, implying Oedipal engagement and the increasing mental complexity implicit in being aware of needs and wishes toward one parent vis-a-vis the other parent.

psychosexual Based on Freud's early finding that all aspects of mental functioning are affected by infantile sexual development and the wishes that derive from these experiences. The term is usually used as an adjective to imply

that some mental or behavioral action is influenced by oral, anal, phallic, or genital urges.

regression A key psychoanalytic concept that thoughts, emotions, or behaviors can involve a return to developmentally immature levels. It also refers to a defense mechanism. Regression can occur along any developmental line.

signal anxiety Freud's second theory of anxiety stated that mental maturity brings with it the ego's ability to anticipate the danger of unconscious mental content becoming conscious so that appropriate defenses can be mobilized. Signal anxiety refers to the affective sense of danger that stimulates defense.

structural model Freud's final model of the mind introduced in 1923 in *The Ego and the Id*. The mind was conceived of having three structures (the id, ego, and superego). Interaction between these three structures is thought to account for all mentally mediated behavior.

sublimation This concept refers to mental contents or processes being separated from the drives that might have influenced their origins. As socially more acceptable motives affect these contents and processes, defenses are no longer needed against them.

superego The mental structure that creates and maintains ideals, values, prohibitions, and commands. It observes and evaluates the self's compliance with these ideals and generates affects to encourage compliance.

transference The process by which the patient displaces onto the therapist or analyst feelings, impulses, attitudes, or defenses derived from important interactions in the past.

"The Oedipus Complex" is a concept in which psychoanalytic history, theory, and clinical work converge. Freud described the Oedipus complex as a universal aspect of human psychological development. He found that in the life of every child, there comes a juncture at which the child strives for sexual union with the parent of the opposite sex, wishes for the death of the same-sex parent, and consequently fears retaliation. In short, Freud believed each of us has once been "a budding Oedipus" with fantasies of incest and murder. Since Freud, the Oedipus complex has been reexamined, reconceptualized, and integrated into different developmental theories of psychoanalysis. Though much of Freud's assertions have been reformulated, especially with respect to the development of the female, many psychoanalysts maintain that the Oedipus complex is a cornerstone in development, the "shibboleth" of psychoanalysis, the watershed of individuation, and one of the most influential and fundamental psychic organizers of mental life.

Currently, the Oedipus complex can be defined as a configuration in which the child's attachments to par-

ents become infused with sexual feelings leading the child to compete with each parent for the attention of the other. With these emerging sexual strivings and their connection to the parents, fantasies form and shift, identifications deepen, interpersonal conflict becomes internalized, intrapsychic conflict results, and internal compromise formations become possible. This psychic organizer occurs between the 3rd and 6th years of life, at the height of "the infantile genital" or "phallic" phase: a phase that follows the oral and anal phases and that overlaps with the pre-Oedipal and Oedipal phases of development. Intense love and hate, envy and rivalry, fears of loss of love and bodily injury, a growing capacity to differentiate between fantasy and reality, and a new awareness of morality characterize a child in the midst of the Oedipus complex. Developmentally, the Oedipus complex is thought to signal a pivotal maturation, not only in the instinctual drives, but also in the ego and object relations. One cannot think about the Oedipus complex today without exploring the concepts of superego formulation, Oedipal and pre-Oedipal object relations, infantile neurosis, and differences in male and female development.

I. HISTORICAL CONTEXT

How Freud came to discover the Oedipus complex requires tracing his thoughts back before his conceptualizations of libido, dual-drives, and structural concepts to his famous 1887 note to Fliess. In that note Freud explained how his self-analysis led him to a radical revision of his seduction-trauma hypothesis. Exploring his own internal world brought the startling realization that the sexual experiences and seductions reported by some of his patients were really fantasies containing wishes, not actual memories. This turning point in his theory resulted from a discovery in himself of the fantasy he saw depicted in Sophocles' *Oedipus Rex*. In the play, the gods place a plague on Thebes for the murder of King Laius. "Oedipus" had been abandoned at birth by Laius and Jocasta for being defective. Oedipus means "clubbed foot." Now married to the widowed queen Jocasta after having solved the riddle of the Sphinx, Oedipus searches for the murderer only to find that he, himself, is not only the murderer but the murderer of his own father and the lover of his mother. In fact, in *The Interpretation of Dreams* (1900), in which Freud first published his formulation of what later he would call the Oedipus complex, he referred to the Greek myth of Oedipus as confirmation of the

profound and universal power of the incest–parricide fantasy. Though it was not until his “Contribution to the Psychology of Love” in 1910 that Freud first used the term, “Oedipus complex,” and not until a 1920 footnote added to *Three Essays on the Theory of Sexuality* in 1905 that he gave his first synopsis of the complex, from 1897 onward the discovered fantasy was already destined to be linked to the tragedy bearing the name of “Oedipus.”

Though it percolated through his thoughts from 1887 onward, nowhere did Freud give a systematic account of the Oedipus complex. For Freud, the Oedipus complex was inseparable from sexuality, and, in his writings from 1905 to 1940, Freud integrated the Oedipal fantasy with his discovery of infantile sexuality and his understanding of psychosexuality. While Freud continued to develop, reassess, and revise his theories and models, the basis idea of the Oedipal fantasy remained a constant. However, the specifics of the Oedipus complex in relation to intrapsychic development were transformed as Freud’s thinking and theories evolved. Prior to the formation of the structural model in 1923, Freud’s understanding of development was influenced by his conviction that sexual and aggressive urges, otherwise referred to as “instinctual drives,” provided most of the motivation for psychic function. These drives were mental representations or a “psychical representative of an endosomatic continuously flowing source of stimulation” and not simply somatic entities. In *Three Essays on the Theory of Sexuality*, Freud linked instinctual drives to erogenous body zones and proposed that a sequential progression occurred as the child matured. At birth the libidinal drives seek gratification through oral means. Later the anal arena becomes the focus of pleasurable sensations. Finally, in the infantile genital or phallic phase, the source of drives resides in the genitals, and, at this juncture, children show evidence of the Oedipus complex. While introducing a wealth of data on infantile sexuality that related to the Oedipus complex, Freud did not explain the complex as a whole until the addition of the earlier mentioned 1920 footnote that referred to the Oedipus complex as “the nuclear complex of the neurosis” representing “the peak of infantile sexuality” and the “shibboleth that distinguishes the adherents of psycho-analysis from its opponents.”

Freud elaborated his understanding of infantile sexuality and development following his analysis of Little Hans in *On the Sexual Theories of Children* and *Analysis of a Phobia in a Five-year-old Boy*. He introduced the role of “castration threat” and “the castration complex”

as well as fantasies of fertilization through the mouth, of birth through the anus, and of the woman having a penis in these writings. In *Totem and Taboo*, Freud linked the Oedipus complex to the cultural institution of totemism. He viewed the primitives’ ban on killing the totem animal as an external representation of an intrapsychic prohibition against killing the father. In this way Freud elevated the Oedipus complex to a primary role in the origin and evolution of human psychic development. Freud further elaborated on the connection between castration and the Oedipus complex in his *Introductory Lectures*. Unfortunately these ideas were contaminated by his incorrect assumption that there was little difference in the early sexual development between boys and girls.

In *The Ego and the Id*, Freud broadened his theory by putting more emphasis on the environment and external experience as organizers of psychological development. Freud proposed that three hypothetical psychic structures—id, ego and superego—organized experience. The instinctual drives were subsumed into the metapsychological structure of the id. The ego was the psychological structure that synthesized and organized the personality by mediating between internal and external experience. The superego, referred to interchangeably in the 1923 paper as the ego ideal, was the structure that contained internalized real and fantasied approvals, criticism, threats, moral standards, and ideals of parents. Freud now expanded the idea of shifting developmental progression of erogenous zones to include the shifting progression of related wishes and fantasies with the structural model. And, perhaps most important, the structural model brought two new concepts to Freud’s understanding of the mind: (a) the idea that these wishes and fantasies were connected not only to drives but also to objects and the child’s shifting relationships to those objects, and (b) that these relational configurations were internalized. The Oedipus complex was further refined and highlighted in a new way within the structural model.

In 1923, Freud used the concept of identification in the context of the Oedipus complex to explain how the ego, like the rider on the horse, is able to rein in the drives of the id. First Freud wrote of the side-by-side existence of the “positive Oedipus complex” and the “inverted negative Oedipus complex.” The former included the child’s libidinal wishes for the opposite sex-parent and rivalrous feelings toward the same-sex parent. The latter referred to libidinal wishes towards the same-sex parent and rivalrous feelings toward the opposite-sex parent. Freud explained that the complete

Oedipus complex was “twofold, positive and negative ... due to the bisexuality originally present in children.” He described a precipitate forming in the ego resulting in a special modification when mother and father identifications unite. This newly formed identification-based aspect of the ego was called the ego ideal or superego. Because this higher order structure was the means by which the child relinquished infantile sexual wishes, Freud declared the superego to be the “heir” to the Oedipus complex. Infantile sexuality would be left behind, and infantile omnipotence would now be denied by a new sense of reality that included inner reality and Oedipal identifications with the development of the new “heir.” The Oedipus complex became a developmental landmark signaling a further and fundamental structuralization of the mind that resulted in the child’s initiation into a moral order and an individuation founded on the basis of intrapsychic conflict.

Freud extended his theory on how the child resolved an Oedipal conflict 1 year later in *The Dissolution of the Oedipus Complex*. He emphasized the relinquishment of libidinal attachment to Oedipal objects and their substitution by identifications with parental authority. Freud spoke of the desexualization and sublimation of these Oedipal striving, and he stressed the importance of the ego’s defense against castration anxiety. For the first time, Freud delineated different paths for the Oedipus complex in boys and girls. He emphasized that boys were driven to resolve their Oedipal longings after seeing the female genitals. With the sight of the female “castrated” genitals “the loss of his own penis became imaginable and the threat of castration takes its deferred effect.” Fear of castration and guilt motivated the boy to identify with and internalize the father’s moral rules and standards. In contrast, the girl’s dissolution of the Oedipus complex requires the acceptance of her castrated state as an accomplished fact, something that occurred prior to the formation of the Oedipus complex. Freud had already elaborated on the weaker state of the female superego and, in 1924, he asserted that the dissolution of the Oedipus complex in the girl is never fully accomplished.

Freud’s struggle to explain female development continued in *Some Psychological Consequences of the Anatomical Distinction Between the Sexes* in 1925 wherein he posited a developmental sequence for female Oedipal development. The core of this scheme centered on the vicissitudes of the questionable “penis-envy” phenomenon that Freud had first mentioned in *The Sexual Theories of Children* in 1908. The sequence was described as follows: (a) the girl discovered her lack of penis; (b) the

discovery of her castrated state gave rise to feelings of inferiority, penis envy, and anger at her mother for not providing a penis; (c) consequently there is a loosening of the libidinal ties toward mother and a turning to father; and (d) the father is then looked to as a provider of a penis and a baby to compensate. Freud added a caveat at the end of the paper that his opinions could be wrong because they were based on a handful of cases, and that further observation was needed to validate his findings. Unfortunately, despite his own caveat and others’ questions, these ideas became enshrined as the classical position on female sexuality for several decades.

Freud collaborated with Ruth Mack Brunswick prior to his death to write *The Preoedipal Phase of the Libido Development* that was published posthumously in 1940. In his final work, Freud wrestled with the importance and impact of pre-Oedipal attachment to the mother and clarified the fantasy of the “phallic mother.” He had considered the girl’s pre-Oedipal attachment to her mother earlier in *Female Sexuality* in 1931. In the 1940 paper, Freud rebutted those authors (Klein, Horney) who challenged his view of the female Oedipus complex. After discovering the Oedipus fantasy in himself, after dedicating years to understanding how the complex formed, how it evolved differently in boys and girls, how it may or may not resolve, and how it intensified to yield the superego, in the end Freud turned back developmentally. Although still holding to his shibboleth of psychoanalysis, Freud moved back toward that “dark continent” with which he was far less familiar to seek what nodal fantasies might be hidden beneath the Oedipal wish.

II. CURRENT CLINICAL RELEVANCE

Despite Freud holding his discovery of the Oedipus complex to be the “nucleus of neurosis”, contemporary psychoanalysts continue to question its relevance to contemporary theory and practice. For a patient to have a successful analysis must today’s analyst continue to whisper the Freudian shibboleth of “Oedipal fantasies” or “Oedipal conflicts?” Research on early childhood development in the decades following Freud has yielded findings that not only have resulted clearly in the redefinition of the Oedipus complex but have also led to a shift in the centrality of the Oedipus complex. Infant and child observational studies have provided new information about gender identity formation, female psychology, and sexuality. Freud’s assumptions about the timing of several phenomena crucial to his

theory that the Oedipus complex is the nucleus of psychological development have been challenged. For example, Freud was wrong when he stated that the discovery of the anatomical differences between the sexes occurred during the phallic phase. We now know that this discovery is made between 16 to 24 months, during the 2nd year of life. Freud was also inaccurate when he assumed that boys' and girls' development were the same up until the phallic years. We now know that gender identity (one's sense of whether one is a boy or a girl) is determined by the time the child reaches age 2 to 3. Such research has allowed analysts to rethink the concepts of penis envy, the negative Oedipal complex, and superego formation, and how they apply to both the boy's and the girl's psychological growth.

Penis envy was a concept which originated with Freud and became pivotal in his understanding of female psychology. This clinical concept of penis envy is manifested in an unpleasant feeling of inadequacy associated with and triggered by a covetous wish for the phallus. Freud asserted several ideas about penis envy: (a) the child discovered that the boy has a penis and the girl has no penis in the phallic phase; (b) the discovery led to castration anxiety and superego formation in the boy; and (c) in the girl, this discovery led to narcissistic injury with hostility toward the mother and subsequent turning to the father for a baby to replace the missing penis. The idea of penis envy in girls has been reconsidered and questioned as being a masculine or "phallogocentric" perspective as psychoanalytic researchers have gained a greater understanding of female development. At the same time, clinicians have become more sophisticated in their attempts to understand clinical material about the penis and a wish for it in female patients. It is common these days for analysts to interpret such material as defensive against more pervasive feelings of inadequacy or as a desire for the penis to fulfill feminine needs (such as the wish to be penetrated). Rarely is penis envy interpreted as a primary issue. The concept of primary femininity was not available to Freud. Primary femininity implies an inborn sense of femaleness which predates penis envy, castration anxiety and the Oedipus complex. That is, femininity is innate and, at least in part, biological rather than simply a reaction to a disappointed inability to be masculine. Nonetheless, femininity is still subject to conscious and unconscious conflict and identifications with father as well as mother. Analytic observation of girls had led certain analysts to ask whether the phallic phase occurs at all in girls. If a phallic phase equivalent exists in girls, it is quite different from that of boys.

Penis envy is now recognized as occurring in both sexes. It means different things in boys and girls depending on a variety of factors including biology, environmental experiences with both parents, and fantasy formation. Boys have been observed to suffer from penis envy when they discover that an older male has a larger organ than they do. Some, but certainly not most, girls develop a fantasy that they have been castrated. Penis envy occurs in some girls but not in others. When it does occur it is dependent on the girl's preexisting feminine identity and the experiences that formed it. Restitutive fantasies of a girl's illusory penis can occur in both sexes. Analysts have also wondered whether penis envy can cover a defensive devaluation of an all-powerful mother in both sexes. Penis envy in this context correlates with the feelings of smallness and helplessness with which every child must contend. The universal fantasy of the "phallic mother" can serve to deny castration or helpless vulnerability in a small child. Some analysts have suggested that shifts in fantasy content can be caused by cultural changes so that penis envy will decline and breast and womb envy will increase as gender roles continue to evolve in modern society. In summary, penis envy and narcissistic injury are no longer thought to be necessary factors initiating the girl's entry into the Oedipus complex. Neither is the female superego deemed to be "weak" or deficient. To date, however, penis envy remains part of the clinical vernacular of psychoanalysis though its meaning in girls and boys has been greatly amended and enlarged from Freud's original notions.

Penis envy is not the only aspect of Freud's concept of the Oedipus complex that has been reviewed and revised. New knowledge of gender identity and closer examination of the complexity of both male and female development has raised questions about the concept of the negative Oedipus complex. Freud had posited the negative Oedipus complex originally as a way to reconcile mixed identifications: The child, regardless of gender, identifies with both parents. Unlike penis envy, the negative Oedipus complex is not widely used in clinical contexts. Psychoanalytic writers have speculated that the diminished usage of the concept reflects the fact that it does not easily or even accurately fit observable clinical evidence. Some analysts have studied and questioned the negative Oedipus complex in girls, others in boys. Focusing on the girl, Edgcombe asked whether the negative Oedipus complex was a normal phase of Oedipal development if it existed at all. Others have reassessed negative Oedipal material and found it better explained in terms of a regression from an Oedipal to a pre-Oedipal

level of object relations. What some label negative Oedipal material is seen by others as a wish to be nurtured, fed, and protected by mother: The girl relates on the basis of dyadic pre-Oedipal wishes rather than relating to the mother in an erotic way with rivalrous feelings toward the father. It remains an empirical question whether girls go through a normal negative Oedipal stage of development. Some analysts have reported finding such material only in women with histories of an absent father and a neglectful, depressed mother.

Blos is one of the few analysts who have examined the negative Oedipus complex in boys in his studies of the relationship of boys and their fathers. He prefers to use the terms "isogender dyadic and triadic complex" rather than "negative Oedipus complex." He prefers these terms because he challenges the idea that dyadic relationships are prerequisites for triadic ones. He views early male bonding as more complex than the boy's erotic love for the father as interpreted by concepts such as the Oedipal constellation. Blos emphasized that the boy's early relationship with the father not only consolidates gender identity but also provides a sense of security and safety. Furthermore, the boy's closeness with his father is not necessarily feminine or passive even if it has erotic components. For these reasons he views the term negative Oedipus complex as both misleading and pejorative. Another conceptual problem with the negative Oedipus concept involves whether to consider it as a defense against a positive Oedipus complex, a regression or fixation to a preoedipal level of development, or as pathological in its own right. Complicating the matter is the difficulty of differentiating clinically between oedipal and preoedipal. Furthermore, these two levels of object relatedness can co-exist in a superimposed, simultaneous manner. As a result the concept of the negative Oedipus complex does not appear often in psychoanalytic writings emanating from the United States.

Despite revisions in the way we understand the role of penis envy and negative Oedipus complex, the Oedipus complex remains alive and well in psychoanalytic theory and practice. Many psychoanalysts continue to conceptualize the Oedipus complex and the Oedipal phase as the developmental stage during which the mind either does or does not organize in a new and vital way: namely, a way that is defined as "neurotic." Neurotic mental organization refers to a special and unique structuralization that is thought to occur during the Oedipal phase. Such structuralization is a concept used to describe a reordering of mental functioning. This developmentally advanced mode of organization includes such new capacities as the integration of drives with tri-

adic (rather than dyadic) objection relations, more selective identifications, and a more refined and differentiated sense of morality and authority. It is the most developmentally advanced level of organization available to the human mind. Psychoanalysts believe that the boundary between neurosis and normality is only quantitative, not qualitative. In "good-enough" circumstances, there is a nodal shift from the interpersonal to the intrapsychic that characterizes a neurotic organization. The danger of retaliation for wishes is no longer external but internal. The feared punishment is not in the form of the parent's action or attitude but involves guilt experienced as a failure to adhere to one's internalized ego ideal. This achievement of a capacity for guilt and intrapsychic danger reflects the maturation of the superego as a psychic structure that can regulate the individual's behavior. Most analysts believe that it is through the Oedipus complex, and during the Oedipal phase, that the superego, "heir to the Oedipus complex," is functionally consolidated. Many analysts correlate the formation of the superego with the Oedipus complex and, thus, couple the capacity for neurotic conflict with the Oedipus complex and Oedipal conflict. These analysts tend to view the Oedipus complex as what Spitz called the "fourth psychic organizer."

Spitz described three "critical periods" of psychic organization while applying embryological theory to ego development. These periods were defined by the emergence of new behaviors that Spitz took to indicate that different mental functions were brought into a new relation with one another. The result was new psychological growth manifested not only through a new behavior but also by a new affective expression. The three shifts that Spitz thought signaled a new level in psychic structuralization are: (a) the social smile, (b) stranger anxiety, and (c) the "no" gesture. Those who conceptualize the Oedipus complex as the fourth psychic organizer regard Oedipal conflict as evidence of a new level of organization; the ego now functions "neurotically," making internal compromises and becoming increasingly independent of the external environment. Many psychoanalysts equate Oedipal conflict with neurotic conflict and the infantile neurosis and, consequently, use Oedipal material in the patient's associations to assess whether psychic structure is neurotic or not. Thus, the presence of Oedipal conflicts in the patient's history takes on diagnostic significance. Oedipal content indicates neurotic symptoms or personality traits according to this equation. This diagnosis carries with it the treatment prescription that psychoanalysis is the treatment of choice. Likewise, patients whose conflicts are pre-Oedipal should be treated with psychotherapy according to adherents of this view.

However, child observation suggests that Freud was wrong in the timing of his central Oedipus complex. Not only do the discovery of anatomical differences and gender identity occur long before the emergence of the Oedipus complex, but, so too, does the formation of the superego. Precursors of superego development (along with the capacity for intrapsychic conflict) have been noted in the 2nd year of life, before the phallic and Oedipal phases. Ironically, they can occur during the critical period described by Spitz as the third organizer, “the no gesture.” Occurring at the anal-rapprochement phase (a combination of Freud and Mahler’s developmental theories), “the no gesture” initiates the child’s struggle with compliance to mother’s demands. Compliance indicates the beginnings of internal controls and internalized conflict. Margaret Mahler described the rapprochement subphase as the 3rd in the 4 stages of what she called the separation–individuation process. It is marked by notable ambivalence and the attainment of object constancy. Hence, the early superego arises in the context of ambivalence. When the child begins to say “no” to himself or herself the inchoate makings of the superego are unconsciously at work. If intrapsychic conflict and superego formation can begin in pre-Oedipal years, where does this leave the Oedipus complex? How can Oedipal conflict be a litmus test for presence of the capacity for intrapsychic conflict? Psychoanalysts have begun to wrestle with these questions.

If neurosis is thought to be an indication of superego modulation of intrapsychic conflict, our most recent knowledge of development indicates that neurotic internal structure begins before the appearance of the Oedipus complex. Thus, pre-Oedipal conflicts do not necessarily mean the mind is not organized neurotically. Similarly, the assumption that all Oedipal conflict is evidence of neurotic character structure is problematic. Psychoanalysts regularly bear witness to the fact that all that is Oedipal clinically—including manifestations of an Oedipus complex—is not necessarily indicative of neurosis. Symptomatology that could be viewed as a sign of neurosis (such as phobias or obsessional symptoms) may occur in individuals with borderline or narcissistic character structures. Moreover, Oedipal content can be observed regularly in the thoughts of patients organized at a borderline or psychotic level. It seems most reasonable to conclude, then, that psychoanalysis is indicated when the patient’s symptoms or character traits are part of a personality structured at a neurotic level. Neurotic personality structure is characterized by internalized conflicts that arouse anxiety to which the ego responds with signal anxiety mobilizing appropriate defenses and/or compromise formations.

The content of the wishes, fantasies, or conflicts that would lend themselves best to psychoanalytic treatment may be either Oedipal or pre-Oedipal, about either competing for the opposite-sex parent or seeking the security of mother. Likewise, a transference neurosis, often considered a *sine qua non* of psychoanalysis proper, does not absolutely require that its content be embedded in Oedipal themes. It is the mental structure and not the mental content that is most clinically significant.

In assessing whether to recommend psychoanalysis versus psychotherapy, the psychodynamically trained physician should assess the adaptability of the ego’s functioning, not evidence of an Oedipus complex. One can be led to erroneous treatment recommendations if one looks for signs of Oedipal conflict, castration anxiety, penis envy, rivalrous wishes toward the same-sex parent object, and an eroticized transference. Though it provides one of the most complex conflicts to the developing mind, the Oedipus complex is not always proof of neurosis. Oedipal wishes can be organized in psychosis or borderline ways. The clinician should instead assess for autoplasmic (rather than alloplastic) modes of conflict resolution. Autoplasmic means that the individual’s psychic structure allows for psychic shifts to be made so that conflicts are resolved “internally” rather than by attempting to make the world accommodate to the self (alloplastic). Furthermore, the capacity for affect regulation (specifically signal affects), a sense of self-responsibility, and a superego that controls impulses before they are expressed behaviorally should be looked for as core indicators of neurotic structure.

III. CONCLUSION

In conclusion, although the Oedipus complex and the Oedipal phase of development remain indelible in the history of psychoanalysis, vital to contemporary theory and practice of psychoanalysis, and nuclear to the formation and understanding of unconscious mental structure, the Oedipus complex and Oedipal conflict are no longer necessarily central to the diagnosis of neurosis. The clinician who blindly holds the Oedipus complex as the unshakeable shibboleth of psychoanalysis is in as precarious a position as was Oedipus on the road to Thebes.

See Also the Following Articles

Alderian Psychotherapy ■ History of Psychotherapy
 ■ Intrapsychic Conflict ■ Jungian Psychotherapy
 ■ Object-Relations Psychotherapy ■ Psychoanalysis and Psychoanalytic Psychotherapy: Technique ■ Structural

Theory ■ Topographic Theory ■ Transference Neurosis ■ Unconscious, The

Further Reading

- Blanck, G. (1984). The complete Oedipus complex. *International Journal of Psycho-Analysis*, 65, 331–340.
- Blos, P. (1987). Freud and the father complex. *Psychoanalytic Study of the Child*, 42, 425–442.
- Calogeras, C., & Schupper, F. (1972). Origins and early formulations of the Oedipus complex. *Journal of the American Psychoanalytic Association*, 20, 751–775.
- Edgecombe, R. (1976). Some comments on the concept of the negative Oedipal phase. *PSC*, 31, 35–61.
- Moore & Fine. (1990). *Psychoanalytic terms and concepts*. New Haven, CT: Yale University Press.
- Simon, R. (1991). Is the Oedipus complex still the cornerstone of psychoanalysis? *Journal of the American Psychoanalytic Association*, 39, 641–668.
- Tyson, P. (1990). Neurosis in childhood and in psychoanalysis: A developmental reformulation. *Journal of the American Psychoanalytic Association*, 44, 143–165.
- Tyson, P., & Tyson, R. L. (1990). *Psychoanalytic theories of development*. New Haven, CT: Yale University Press.

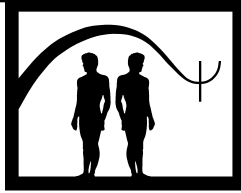

Omission Training

Ruth Anne Rehfeldt

Southern Illinois University

- I. Description of Treatment
- II. Theoretical Bases
- III. Empirical Studies
- IV. Summary
- Further Reading

time out An intervention in which an individual is removed from sources of positive reinforcement for a specified period of time.

GLOSSARY

differential reinforcement of incompatible behaviors Reinforcement is provided contingent on an individual's engaging in behaviors that are incompatible with an undesirable target behavior.

differential reinforcement of other behaviors Reinforcement is provided contingent on an individual's engaging in behaviors other than an undesirable target behavior.

extinction Decrease in behavior following the removal of reinforcement.

overcorrection An intervention in which an individual is required to improve the setting beyond the way in which it appeared before a disruptive behavior was emitted, or to repeatedly practice behaviors that are alternative to the disruptive behavior.

punishment A contingent relationship between a behavior and a consequence such that the consequence causes the particular behavior to decrease in frequency.

reinforcement A contingent relationship between a behavior and a consequence such that the consequence causes the particular behavior to increase in frequency.

stimulus generalization The spread of the effects of reinforcement to settings different from that in which the original procedure was conducted.

I. DESCRIPTION OF TREATMENT

Omission training is a procedure that is used to reduce or eliminate behaviors that are deemed undesirable. Omission training is typically used to reduce behaviors that occur at a moderate-to-high rate. In general, the procedure requires that a time interval be established, and, if at the conclusion of that time interval, the target behavior has been "omitted," a reinforcer is delivered. Reinforcement is thus provided contingent upon the absence of the target behavior. The name omission training is for this reason often used synonymously with the term DRO schedule, or differential reinforcement of zero rates of the target behavior. As an example, consider an elementary school-aged child who gets up out of his or her seat at a high rate during the teacher's lessons. To implement an omission training procedure, the teacher might first determine the longest duration of time that the child can sit without getting up out of the seat during lesson time and establish this as the specified time interval. The teacher may then observe the child during that time interval, and if the child refrains from getting up out of the seat, the teacher may reinforce the child with a gold star, to be later exchanged for additional recess time. After a sufficient number of reinforcers are earned,

the teacher may gradually and successively increase the length of time for which the child is required to refrain from getting up out of the seat to earn a gold star. This omission training procedure is likely to be effective in reducing the rate with which the child gets up out of the seat during lesson time.

There are a number of advantages associated with the use of omission training. First, because all that is required is that an interval of time be recorded, an observation be made as to whether or not the target behavior occurred, and, if it did not occur, a reinforcer is delivered, this procedure is fairly easy to implement. Teachers, parents, or human service agency staff who wish to reduce a behavior need only a rudimentary understanding of behavioral principles. In 1979, for example, Howard Hughes, Anita Hughes, and Hardy Dial reported the successful use of an omission training procedure by parents of a 4-year-old child who engaged in excessive thumb sucking. Likewise, in 1980 Edward Barton and Jennifer Madsen demonstrated that teachers' aides could effectively use omission training to reduce the extreme drooling exhibited by a child with severe mental retardation.

Second, ethical issues that are raised with other behavior reduction procedures are not of the same magnitude of concern here. Providing reinforcement contingent on the absence of a response is considerably less intrusive than other frequently utilized procedures, such as overcorrection and time out. A third and related advantage is that omission training does not produce the undesirable side effects (such as frustration, aggression, or other emotional behaviors) that are often observed with more intrusive behavior reduction procedures. Fourth, several studies have shown that the deceleration in the rate of the target behavior often occurs rapidly following the onset of an omission training procedure. This makes omission training a desirable procedure to use for reducing behaviors that are particularly disruptive. Fifth, the effects of omission training have been shown to be relatively long lasting, and to generalize to settings other than that in which the original treatment was implemented.

II. THEORETICAL BASES

Omission training as a treatment poses some theoretical difficulties. Specifically, the definition of reinforcement is an increase in the rate of a behavior when that behavior reliably produces some consequence; reinforcement hence describes the contingent relationship between a behavior and its consequence. One might ask, how can this same relationship hold with the absence of a

particular behavior, as is the case in omission training? One way of reconciling this dilemma is by acknowledging that while the individual is refraining from engaging in the target behavior during the specified time interval, that individual is engaging in other behaviors. It is the other behaviors that are correlated with reinforcement, and hence, the other behaviors that increase in rate. For example, in our previous example, while the child is refraining from getting up from the seat, the child may be playing with a pencil, drawing on the desk, or listening attentively to the teacher. The gold star deliveries might serve to increase the rate of these other behaviors. Omission training, then, might conceivably be regarded as differential reinforcement of other, or alternative, behaviors.

Because behaviors occurring during the specified time interval may increase in rate due to their correlation with reinforcement, it is possible for other undesirable behaviors to increase in rate. For example, it would certainly not be beneficial if the omission procedure was successful in reducing the child's getting up out of the seat, but also in increasing the rate of the child's talking to a neighbor. For this reason, it is important to specify socially appropriate behaviors in which it is believed to be beneficial for the individual to engage. If behaviors that were deemed desirable for the individual to engage in during the specified time interval were determined and reinforcement was provided contingent on their omission, an increase in desirable behaviors would occur concomitant with the decrease in the undesirable behavior. This procedure could be conceptualized as a differential reinforcement of incompatible behavior, or a DRI, schedule. For example, if the child was provided with gold stars for listening attentively during specified time intervals, this behavior is incompatible with getting up out of the seat and would be expected to increase in rate. So, it may be useful to gradually fade a DRO schedule into a DRI schedule, so that desirable behaviors are specified and increased. It is also important that the individual's opportunities for reinforcement be maximized. The omission training procedure must begin with a specified time interval during which baseline levels of behavior suggest that the target behavior will not occur. When a certain number of reinforcers have been acquired, the time period can be gradually increased.

III. EMPIRICAL STUDIES

A. Use of DRO to Reduce Self-Injurious Behavior

In 1990, a dramatic demonstration of omission training was reported by Glynnis Cowdery, Brian Iwata, and

Gary Pace. The procedure was used to reduce the frequency of severe self-excoriation (scratching or rubbing) that was displayed by a boy who was not developmentally disabled. Functional analysis results revealed that the boy's self-injurious behavior was maintained by automatic reinforcement. A treatment plan was established in which pennies, tokens, or social praise were delivered following periods of time during which the boy refrained from scratching. Initially, the interval was set at 2 min, which was the longest amount of time the boy had been observed to refrain from scratching. As the boy met the criterion for reinforcement, the time interval was gradually increased to 18 min, and eventually expanded to where the boy was able to leave the facility in which he lived to visit his parents. Four months of treatment were required to reduce the boy's self-injurious behavior to less harmful levels; it was never completely eliminated.

B. Effects of Omission Training as Compared to Extinction

In some situations, caregivers may wish to determine what function a maladaptive behavior is serving, or what specific reinforcer is maintaining the behavior. When that has been identified, it seems reasonable to expect that withdrawing that reinforcer should extinguish the behavior, or cause it to decrease. For this reason, some investigators have compared the effectiveness of omission training to extinction. For example, in 1975, F. Dudley McGlynn, William B. Miller, and John Fancher established a key-pressing response by individuals with chronic schizophrenia. For one half of the participants, key pressing was then put on extinction, while the other one half of the participants received reinforcement contingent on not pressing during specified periods of time. Response rate was shown to decrease more rapidly for participants in the extinction condition; extinction was also shown to result in overall more response suppression than omission training. In 1976, Jeff Topping, Helen Thompson, and Billy Barrios reported slightly different results using a similar procedure with institutionalized individuals with Down's syndrome. Neither procedure was more effective in reducing response rate initially, but greater overall suppression resulted from omission training. The degree to which these results would also be obtained in clinical settings is not clear from either of these reports.

C. Durability and Generality

The effectiveness of an intervention can be evaluated on the basis of durability and generality. Durability refers

to the degree to which the effects of the intervention persist over time after treatment has been terminated. For example, Brian Iwata and Andrew Lorentzson showed in 1976 that the effects of an omission training procedure in controlling seizure-like behavior persisted for 13 weeks following treatment withdrawal. Generality refers to the degree to which the effects of the treatment are shown to generalize to settings different from that in which the original procedure was implemented. In the study described previously by Cowdery, Iwata, and Pace, treatment was conducted in an institutional setting, but the effects were shown to generalize to the child's home when he visited his parents. As with most behavioral interventions, generalization of treatment effects is likely when the settings in which the intervention is performed in are varied, the frequency of reinforcement in the original training situation is reduced sufficiently so that the training situation more closely resembles the natural environment, and when common stimuli are programmed between settings.

D. Side Effects

As mentioned previously, omission training does not produce the worrisome side effects that other procedures might. However, emotional responses may still occur. Cowdery and his colleagues noted that emotional behavior (e.g., crying) did occur when the boy did not earn his scheduled reinforcers. Thus, an individual may experience frustration if scheduled reinforcers are not earned, but such effects would seem to be a by-product of any reinforcement-based intervention. Such effects are presumably of a lesser magnitude than those resulting from more intrusive procedures. It must be noted, however, that there may be clinical situations in which the target behavior poses such concern, either because it is harmful to others or harmful to oneself, such that caregivers do not have time to wait for omission training to take its effect. In fact, more harm may be caused if the behavior is allowed to continue to occur. In such situations, a more intrusive procedure may be warranted.

IV. SUMMARY

Omission training has been shown to be an effective procedure for reducing or eliminating undesirable behavior. It is not as intrusive as other behavior reduction procedures and produces few side effects. Its effects may be seen relatively soon after its onset and may be relatively durable over time. The reduction in the rate of the undesirable behavior can be expected to occur in settings different from that in which the original train-

ing was conducted. Omission training is an easy procedure to implement and will be most successful if opportunities for reinforcement are maximized, and if a DRI schedule is gradually implemented.

See Also the Following Articles

Chaining ■ Extinction ■ Differential Reinforcement of Other Behavior

Further Reading

Catania, A. C. (1997). *Learning*. Englewood Cliffs, NJ: Prentice Hall.

Cooper, J. O., Heron, T. E., & Heward, W. L. (1990). *Applied behavior analysis*. Upper Saddle River, NJ: Prentice Hall.

Homer, A. L., & Peterson, L. (1980). Differential reinforcement of other behavior: A preferred response elimination procedure. *Behavior Therapy, 11*, 449–471.

Kazdin, A. E. (2000). *Behavior modification in applied settings*. Belmont, CA: Wadsworth Publishing Co.

Martin, G., & Pear, J. (1999). *Behavior modification: What it is and how to do it* (6th ed.). Upper Saddle River, NJ: Prentice Hall.

Sulzer-Azaroff, B., & Mayer, G. R. (Eds.). (1991). *Behavior analysis for lasting change*. Orlando, FL: Holt, Rinehart, & Winston.

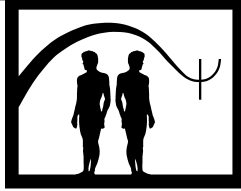

Online or E-Therapy

Zebulon Taintor

New York University School of Medicine

- I. Description of Treatment
 - II. Guidelines
 - III. Disadvantages of Unmet E-Therapy
 - IV. Advantages of E-Therapy
 - V. Indications for E-Therapy
 - VI. Contraindications of E-Therapy
 - VII. Future of E-Therapy
- Further Reading

GLOSSARY

e-therapy Doing therapy by electronic communication.

online Generally is used to denote the subset of e-therapy done in real time, aiming for pauses between messages that are as brief as those between two people in the same room.

unmet e-therapy E-therapy where client and therapist have not met.

webcam A camera used in conjunction with a personal computer for video communication via the Internet.

E-therapy is doing therapy by electronic communication. At present this means exchanging text messages. Web sites offering e-therapy sometimes do not distinguish between therapy and counseling. E-therapy has evolved empirically because of the availability of technology, which includes both e-mail for communication, and the Internet, where therapists' web sites attract potential clients. There are no controlled studies of efficacy, although anecdotal testimonials abound. It is

derived from older technologies (letters, telephone, facsimiles) that did not achieve the status of distinct therapies. E-therapy has emerged as yet another way the Internet may alter radically the way we do things. Although most professional associations agree e-therapy is not as effective or safe as when the therapist and patient are in the same room, proponents argue it is more convenient and can reach out and involve those who cannot or will not meet a therapist bodily. E-therapy is better than no contact for certain populations and may lend itself to frequent contacts in some forms of therapy. Potential disadvantages abound. Future use is likely as an adjunct to therapy that includes meeting in the same room, but unmet e-therapy depends on the ability to achieve adequate evaluations, and overcoming negative trends in liability, regulations, and reimbursement.

I. DESCRIPTION OF TREATMENT

The Internet, established in 1969 at the University of Southern California for national defense uses, has emerged as a major form of communication, with unanticipated qualities and effects. Electronic mail was used for years among users of terminals of main frame computers. Specialized offers to certain customers date to 1973 with Lexis legal information services available to clients of Mead Data Central. CompuServe began the first online access service for customers in 1979. E-mail has been increasingly accepted

in general medicine, especially for anything a patient might have to write down if told on the telephone, such as test results, written instructions, directions, phone numbers, and so on. E-mail messages can be linked to web sites for patient education. Increasing use has been recommended by the Institute of Medicine's report, "Crossing the Quality Chasm."

E-mail can be contrasted to older technologies, long used in therapy.

A. Letters

An e-mail is basically a letter, the most ancient regular form of communication across distance. Even between people who know and see one another, letters can be used to develop and give a particular form to relationships. Many teenagers have pen pals, often in a distant country, that they do not meet for years. There are published exchanges of letters of people who have and have not met, in which the correspondence was more important than face-to-face encounters. For instance, Tchaikovsky and Najda von Meck corresponded for decades while living in the same city. They chose never to meet by plan, although reacting in their letters to their chance sightings of one another. Numerous examples show the process of therapy in traditional letter writing. Sigmund Freud developed several therapeutic correspondences. There is a rich literature of therapeutic exchanges, which typically took weeks. The big advantages of e-mail over letters are seen at every stage of the process: ease of composition by typing or dictating onto a screen, editing on screen, speed of delivery, ease of retrieval, legibility, ease of response, and storage. Retrieval can be so quick as to allow a conversation in real time, or at one's leisure, which means that the recipient is likely to be in a mindset favorable for communication. Cost per communication is insignificant in that monthly charges through Internet service providers usually provide unlimited e-mail for a monthly fee of \$20 or less. These advantages are so self-evident and overwhelming that no studies have had to be done to quantify these advantages.

B. Telephone

Calls have been used to help people feel better since the invention of the telephone in 1885. They are immediate, and convey nonverbal data through pauses, tone of voice, inflections, and so on. Usually costs are charged by the amount of time taken, so telephone calls tend to be brief. However, therapists have routinely scheduled long sessions with patients when one or the

other is traveling. Unless recorded, they are not retrievable, which may or may not be an advantage. If recorded, playback speedup is essential to achieve evaluation times that can match the ease with which written exchanges can be scanned. Telephone rings tend to be intrusive, and may not catch the recipient in a receptive mind set. Leaving messages on answering machines frustrates the very urgency that led to the call and is complained about as "telephone tag."

There is extensive experience with telephone therapy in the form of suicide prevention centers and other "hot lines." Answerers are always available. The caller and answerer have not met previously. Suicide prevention centers were once publicized extensively and were busy, answering many calls and serving many people in a crisis mode. Studies showed suicide prevention centers did not reduce suicide rates in the cities they served, a phenomenon attributed to the likelihood that more seriously suicidal patients did not call but killed themselves instead. Generally callers used hot lines once or twice. They got support and were urged to go to services where they could be seen and helped. Some of those served did so immediately, others used crisis hot lines and emergency rooms for months or years before getting involved in more regular treatment, and others did not progress beyond use of crisis hot lines. Crisis hot lines are widely used in emergencies and are accepted as one part of the range of services. Some proponents of e-therapy argue from the hot line experience that some people in need of therapy will get involved via the Internet because of its convenience and anonymity. However, web sites offering unmet e-therapy do not resemble crisis hotlines in avoiding diagnosis, treatment, and ongoing relationships.

C. Facsimile Transmission (Fax)

The fax offers a chance to preserve the handwritten, sometimes illustrated, letter format while using the electronic speed of immediate delivery. The novelist Isabel Allende described writing a letter to her mother daily for 30 years, in recent years by fax. She and her mother tie each year's faxes with a ribbon and store them in a closet. Although the writer knows of patients and therapists who communicate by fax, there are no scientific reports. Fax communication is closest to e-mail in that it can occur in real time, but uses the telephone system rather than the Internet and is stored as an image rather than retrievable text. Use of the computer as a facsimile machine may increase as therapists grapple with the regulatory issues described below.

Although the above forms of communication have been available for years, physicians in almost all training programs in all specialties receive no specific education in how to use them.

E-mail poses the following problems:

1. *Junk*: The problem of junk e-mail (spam) can be worse than junk mail, since there is no cost for paper, postage, or handling. For less than \$20, a marketer can purchase a CD with millions of e-mail addresses. In April 2001 more than 10,000 “spam attacks” were launched daily. The estimated annual cost of spam is \$8.5 billion, even though it can be sent without postage to a large number of addresses. Responding to spam, however negatively, actually provokes more, since it shows there is a live person behind the address.

2. *Volume*: Many therapists are on professional and other mailing lists, getting some of 6.1 billion e-mail messages sent daily.

3. *Loss of contact*: E-mail addresses and service providers, which may not reflect a person’s name or location, are changed easily by people, often to avoid getting so much mail. Addresses may be upper or lower case sensitive, multiple (used for different purposes by one or more people), and can change without notice. That mail went undelivered is not always known by the sender; that mail was delivered to the wrong recipient is known by the sender only when the recipient takes the trouble to write back. Most e-mail users report having received someone else’s mail.

These problems can be eased by getting an unpublished address only for e-therapy using a service provider easily accessed from any Internet browser. An ongoing relationship should include ways of contacting the client other than through e-mail.

4. Less easily resolved is *Disinhibition and projection*: The very ease with which e-mail can be sent quickly to anyone results in quick messages and responses before feelings have cooled. The improbability of any local, real-life repercussions in virtual communities on line is disinhibiting. Miscommunication, distortion, emotionality, and projection abound, thought to be a result of the lack of social cues and context. Angry messages constitute a greater percentage of e-mails than of regular letters. “Flaming” and other angry outbursts have led to the development of “netiquette,” which may have its own class distinctions in various settings that provide a further complication. Proponents for e-therapy argue that spontaneity in online therapy is helpful. E-therapists practicing asynchronously garner praise for taking time to think about their responses. E-therapists will have to be able to

write well, expect to be misunderstood, and deal with unexpected feelings stirred up by messages.

E-mail has evolved beyond simple transmission of text. It is possible to send images (e.g., remote art therapy) as an accompanying file, but this is rarely done. Voice dictation is used increasingly, but longer messages tend to slow interaction, and those using it find themselves employing longer words. Some proponents argue that the problem of the lack of physical cues can be overcome by using webcams, but video phones have been available for years without becoming popular. Use of webcams would change the modality to teleconferencing, which has emerged as a clearly defined therapy with limited reimbursement. At present e-mail belongs to the typists. For data gathering purposes this trades whatever can be gained from scrutinizing handwriting, itself the subject of a formidable literature, for legibility and retrievability.

II. GUIDELINES

E-therapy is a subset of patient–therapist electronic communication, so it must proceed within the general guidelines developed for such communication. These have been developed as follows.

The first comprehensive set of guidelines for physician–patient communication was developed by a committee within American Medical Informatics Association and adopted and published in 1998. The guidelines were passed on to the American Medical Association, which modified them slightly and adopted them in its assembly in June 2000. The American Psychiatric Association (APA) assembly adopted the guidelines in November 2000 and requested the APA Board of Trustees to accept the guidelines pending the adoption of APA guidelines. The APA Trustees did so in March 2001. Guidelines have been developed by the Psychiatric Society for Informatics (also highly derivative of the AMIA guidelines) and submitted to the APA. The guidelines adopted thus far are given here in their entirety.

The AMA Board of Trustees recommends:

1. That for those physicians who choose to utilize e-mail for selected patient and medical practice communications, the following guidelines be adopted.

Communications guidelines

A. Establish turnaround time for messages. Exercise caution when using e-mail for urgent matters.

- B. Inform patients about privacy issues. Patients should know:
 - Who besides addressee processes messages during addressee's usual business hours and during addressee's vacation or illness; and
 - That the message may be included as part of the medical record, at the discretion of the physician. [The AMA subsequently stated this decision should be joint between patient and physician, while the Clinton administration privacy guidelines, barely modified (so far) by the Bush administration, offer no choice, stating such messages are to be part of the patient's record.]
- C. Establish types of transactions (prescription refill, appointment scheduling, etc.) and sensitivity of subject matter (HIV, mental health, etc.) permitted over e-mail.
- D. Instruct patients to put the category of transaction in the subject line of the message for filtering prescription: prescription, appointment, medical advice, billing question.
- E. Request that patients put their name and patient identification number in the body of the message.
- F. Configure automatic reply to acknowledge receipt of messages.
- G. Send a new message to inform patient of completion of request.
- H. Request that patients use autoreply feature to acknowledge reading clinician's message.
 - I. Develop archival and retrieval mechanisms.
 - J. Maintain a mailing list of patients, but do not send group mailings where recipients are visible to each other. Use blind copy feature in software.
- K. Avoid anger, sarcasm, harsh criticism, and libelous references to third parties in messages.

Medicolegal and administrative guidelines

- A. Develop a patient-clinician agreement for the informed consent for the use of e-mail. This should be discussed with the patient and documented in the medical record. Agreement should contain the following:
 - Terms in communication guidelines (stated above).
 - Provide instructions for when and how to convert to phone calls and office visits.
 - Describe security mechanisms in place.
 - Hold harmless the health care institution for information loss due to technical failures.
 - Waive encryption requirement, if any, at patient's insistence.

- B. Describe security in place, including:
 - Using a password-protected screen saver for all desktop workstations in the office, hospital, and at home.
 - Never forwarding patient-identifiable information to a third party without the patient's expressed permission.
 - Never using patient's e-mail address in a marketing scheme.
 - Not sharing professional e-mail accounts with family members.
 - Not using unencrypted wireless communications with patient-identifiable information.
 - Double checking all "To" fields prior to sending messages.
- C. Perform at least weekly backups of e-mail onto long-term storage. Define long term as the term applicable to paper records.
- D. Commit policy decisions to writing and electronic form.
 - 2. That the policies and procedures for e-mail be communicated to patients who desire to communicate electronically.
 - 3. That the policies and procedures for e-mail be applied to facsimile communications, where appropriate.
 - 4. That the Board of Trustees [AMA, APA] revisit "Guidelines for Patient-Physician Electronic Mail" when the proposed HIPAA guidelines, encryption, and pertinent federal laws or regulations have been proposed or implemented.

The American Psychiatric Association has issued no statements on e-therapy, but has on telepsychiatry. These guidelines do not deal per se with special demands of the therapeutic process, but do show some of the regulatory burden involved in e-therapy. Subsequently the Health Insurance Portability and Accountability Act (HIPAA) regulations of 2000, themselves the subject of so much controversy as to have generated more comment than any other proposed regulation, have been adopted. They specifically provide for the protection of "notes recorded (in any medium) by a healthcare provider who is a mental health professional documenting or analyzing the contents of a conversation during a private counseling session or a group, joint, or family counseling session" as well as defining "covered professionals" as those who

engage in electronic transactions. As of this writing, the requirement is that all e-mails must be included in the patient's record. The AMA and APA have asked that the physician and patient have the option of including e-mail or not. While protection for such notes is reckoned in advance, it may be difficult for an e-therapist to comply with all parts of the regulation at once.

Although the HIPAA regulations do not distinguish between counseling and psychotherapy notes and counseling in medicine may not be related to psychotherapy and still need to be confidential (e.g., genetic counseling might be of interest to insurers), the term "psychotherapy" has been avoided in statements issued by professional associations. The Ethics Committee of the American Psychological Association (www.apa.org/ethis/stmnt01.html) issued statements in 1995 and 1997 relating to its existing ethics code. While noting that there are no rules prohibiting electronically provided services as such, the statement refers to existing standards on practicing within one's boundary of competence, assessment, therapy, structuring the relationship, informed consent, doing no harm, and others. Most online therapists are marriage and family counselors and psychologists, with almost half possessing PhDs, so it is not surprising that other guidelines refer to counseling, particularly those adopted by the American Counseling Association in 1999 (www.counseling.org/gc/cybertx.htm) and the National Board of Certified Counselors in 2001 (www.nbcc.org/ethics/webethics.htm). "Suggested Principles for the Online Provision of Mental Health Services" were adopted in 2000 by the International Society for Mental Health Online, a self-constituted group of online therapists (mostly psychologists) founded in 1997 in conjunction with the Psychiatric Society for Informatics (mostly psychiatrists) (www.ismho.org/suggestions.html). Requirements include disclosure of credentials, performing an "adequate" evaluation, informed consent, performing within one's general competence (not dealing with any problem online one would not handle face-to-face), procedures to be followed in an emergency (the therapists should have the name of a local health care provider who can be contacted in an emergency), and so on.

The word "therapy" cannot be found in the suggestions or any other document cited earlier, since their framers see psychotherapy as requiring assessments and protections that are not possible without face-to-face meetings. Teleconferencing does not avoid such concerns, having been granted reimbursement mostly for consultations. A California law requires that whatever services are reimbursed when rendered in person

be reimbursed as well when provided electronically, but third-party payers have indicated a willingness to deny claims for e-therapy on the grounds that it is not an equivalent service. Proponents of e-therapy urge reimbursement, but are accused of trying to have things both ways: avoiding liability by describing what they do as counseling, but wanting reimbursement for medically necessary psychotherapy. Persons needing psychotherapy must have some impairment to be reduced by treatment, yet patients with serious problems cannot be evaluated adequately on the basis of remote exchanges of text.

At least one professional organization unequivocally has opposed the practice of unmet e-therapy. The Clinical Social Work Federation voted to do so in its 2001 annual meeting, citing concerns about efficacy, liability, and jurisdiction. Its press release says, in part

This area is totally unregulated and potentially very dangerous for clients and therapists alike. ... This new, very powerful medium blurs all the usual boundaries. Most organizations believe that it cannot or should not be evaluated by well-accepted professional standards. That just is not the case. The standards developed by the U.S. Department of Health and Human Services and Coordinated by the Office for the Advancement of Telehealth, are used by the federal government to assess federal policy on an ongoing basis. ... We have yet to see the first law suits in this area, but we know they're coming. Our concern with establishing a position on the delivery of online therapy services is in absolute alignment with the mission of state licensing boards ... the protection of the consumer. The standards used to analyze the growing area of text-based counseling include principles related to confidentiality, informed consent, quality of treatment, competence of the therapist, and basic ethical and professional requirements. These standards cannot be ensured when the client and therapist know each other only from a text on a screen. Assessment is the first phase of psychotherapy and frequently significant information about the client is based on nonverbal cues. Psychotherapy has at its heart a profoundly human connection, a connection that is, in itself, the major vehicle for change. Healing and restoration occur when the therapist and the client together find the bridge leading back, and forward at the same time, to the true self. Alienation from others and the self will not be healed through a virtual connection in cyberspace, a connection that is fraught with risks and hazards for both clients and clinicians.

Despite these cautions, it is clear that many online therapy practitioners are social workers not bound by

the strictures above. This writer appeared on local television in tandem with a social worker treating a ballerina online for \$80 per hour. They said they did not meet face-to-face because of the inconvenience, although separated only by a few blocks in midtown Manhattan. A marriage and family counselor confidently treated a patient he had never met, as they were separated by 2,100 miles. The press release correctly describes most other professional organizations as neutral about unmet e-therapy, but this does not reflect the intraorganizational debates, which turn on three variables: (1) "adequate evaluation", (2) data reduction, and (3) priorities for the underserved (those who cannot come for meetings in person. There is no controversy about the usefulness of e-therapy where therapist and client meet regularly.

III. DISADVANTAGES OF UNMET E-THERAPY

A. Deception

Michael Lewis has chronicled various deceivers, including teenagers who posed as a stockbroker and a lawyer. The first would pick any obscure stock that struck his fancy, promote it in chat rooms, and sell into the resulting victims's rally. The second passed online as a legal expert until he was exposed, after which demand for his advice continued. Lewis sees these young people as leaders in a populist electronic revolution, but they offer good examples of massive deception and an ongoing demand for advice in a climate that is not likely to be regulated soon. In New York State, as in most, anyone can call themselves a psychotherapist, just as anyone can call himself or herself a fortune teller, astrologist, or palm reader. Periodically newspapers report crimes in which the victim was lured into a meeting after meeting the perpetrator on the Internet. Investigations of those offering online services found many did not give their professional credentials or offered incomplete ones (e.g., "M.S." in a context that implies it is in counseling when it may not be). Similarly, potential clients often give themselves fictional names. Not all deception is deliberate. Couples who met on the Internet have appeared to get married only to discover they mistook one another's sex. Tom Hanks, in the film "You've Got Mail," showed how a person's nature as expressed in e-mail can be very different from that expressed in the face-to-face workaday world. This problem is minimized when the patient and therapist

have met enough in the same room for adequate evaluation and development of a therapeutic alliance.

B. Data Capture

Text-based messages leave out too much to be the sole basis of an evaluation for therapy. The data captured in e-mail are a complete set of a narrow band of communication. Although controlled studies show patients divulge facts more rapidly and completely to computers, most of the studies were done with substance abusers before the Internet and rise of confidentiality concerns. Computer-based assessments have not replaced live interviews because communication of facts still does not convey how a person thinks or feels about them.

C. Confidentiality

E-mails leave copies of themselves in almost all servers through which they pass. In this respect e-mail is less of a sealed letter than a postcard copied at each post office through which it passes. Although the regulations and guidelines included above require attention to confidentiality, they should be understood as raising the bar of difficulty of access to content. It is reasonable to assume that a highly motivated, intelligent person with enough time and other resources can eventually access all files. Thus confidentiality is likely to be sacrificed to the determined hacker.

D. Safety

Although the Internet seems well-enough dispersed to survive most catastrophes, both the Baltimore Tunnel fire and World Trade Center disaster either demolished cables or switching stations that help the Internet and e-mail to flow well. On the other hand, the World Trade Center disaster included such destruction that regular phone lines were out or overcrowded and cell phones highly variable, especially as cell towers atop the buildings were lost. E-mail was extremely effective in reassuring the worried, offering chances to send the same message to many people in one's address book. But systems crash, computers fail, and service can be interrupted by failure of any link in the chain. Other safety issues in e-therapy are, in some cases, a derivative of the deception issue in that text carries so little affect compared to a person's actual presence that most thoughtful therapists fear missing depression, especially suicidal intent. Safety concerns highlight the undesirability of doing e-therapy with a patient not evaluated face-to-face.

E. Liability

As of August 2001 only one lawsuit has been brought, but 31% of state regulatory agencies have had complaints about e-therapists. Not following the guidelines stated earlier would weaken a therapist's defense. Practicing across state lines to patients located where the therapist is not licensed is an added risk, especially as the local means for handling a crisis will also be remote. California legislation, likely to be replicated in other states, requires that anyone providing mental health services to its citizens be licensed in California. Liability is judged in art on the expectations created in plaintiffs, and web sites are careful to avoid statements that diagnosis and therapy are being offered, instead offering help with "problems, stress," and so on. More court tests are likely.

F. Lack of Definition, Standards, and Controlled Studies

This emerging field is not defined. Perhaps it is only a technology, perhaps a new technique, or some blend. It does not have standards per se; professional association standards are cautionary. The International Society for Mental Health Online maintains a web site of reported studies (94 as of September 17, 2001). Most reports are how-to-do-it anecdotes and testimonials to the promise of e-therapy. There are no controlled studies. Although some web sites have been set up by disappointed patients to describe negative experiences with e-therapy, such opinion tends to be reflected more in newspaper articles. In contrast, telemedicine, videoconferencing, telepsychiatry—anything in which video and spoken words are used—is being subjected to controlled studies with random assignment of subjects.

IV. ADVANTAGES OF E-THERAPY

E-therapy is best practiced when the patient and therapist feel comfortable in a progressing relationship that has clearly defined shared goals and objectives. Within this context, the disadvantages cited earlier can be minimized and the following advantages realized.

A. Distance

The Internet and e-mail know no distance, since they are available at any computer, any time, usually for the cost of a local telephone call.

B. Time

E-therapy can be done in real time or through a more leisurely back-and-forth exchange of messages. In real time there is an intensity and density of exchange very much like (although less expensive and slower than) a telephone call. One misses the affect a voice can convey. On the other hand, a record is produced (that must be encrypted for any hope of confidentiality) that can be useful for both patient and therapist later. A more leisurely exchange is more like an exchange of letters and can include elements of a journal kept by the patient with comments by the therapist. Cognitive therapy often proceeds well this way. Supportive therapy is enhanced by the therapist providing another means of access than the telephone, which is more intrusive than e-mail.

C. Convenience

E-therapy can be done without the trouble of travel, dealing with one's appearance, or taking other trouble.

D. Written Record

E-therapy can be used to generate a written record of exactly what texts were exchanged. Present regulations require this or inclusion of e-therapy exchanges in an electronic medical record or computerized patient record.

E. Stigma

There is a general impression that e-therapy carries less stigma because visits to a therapist's office are reduced, and one need not be identified. Because e-mail is fashionable, some of its cachet may spill over to e-therapy.

V. INDICATIONS FOR E-THERAPY

Proponents argue that e-therapy is particularly well-suited for the following:

1. Those who would not otherwise get involved. The Internet indeed attracts many people who are looking online for relationships. One indication is the number of people looking for mates, as evidenced by the membership numbers of the major services: Match.com (1 million), AmericanSingles.com (1.3

million), Matchmaker.com (40,000 new members each week), Jdate (150,000), Blacksingles.com (20,000). The impression that “the Net is packed with depressed people” is supported by at least one study showing an association with heavy Internet use and depression. There are many anecdotes of patients becoming involved in therapy as they developed relationships over the Internet, and outreach programs on the Internet may be useful.

2. Anyone who would benefit from having a written record of patient-therapist exchanges. This writer has routinely given copies of whatever he writes about patients to them. Patients report that it helps them remember what has happened and to see the process of treatment.

3. Those who live in remote places, are physically handicapped, suffer from severe agoraphobia, or communicate already by keyboard, the hearing impaired already communicating by text.

4. Cognitive-behavioral therapy. This form of therapy, which tends to emphasize intellect over affect, with its use of daily journals, labeling and categorizing thoughts, correcting cognitive distortions, and so on, is well-suited for a written record that can be parsed for insight and reinforcement.

5. Supportive therapy. The immediate availability and ease of communication via e-therapy allows ongoing contact as often as indicated and is reassuring.

VI. CONTRAINDICATIONS OF E-THERAPY

Contraindications of e-therapy include:

1. Patients who prefer to have no written record of treatment. Although such patients are rare and always pay themselves without making insurance claims, they have a variety of reasons for wanting no record. A therapist may merely make a note that it was agreed that no record would be kept. Because current regulations stipulate that electronic communication become part of a patient's record, maintaining no record would be a violation.

The following contraindications are “relative” in that they depend on the amount of electronic communication versus the amount of time meeting face-to-face. The crucial variable is maintenance of the therapeutic relationship.

2. Patients for whom nonverbal communication is important. This problem is related not only to patient expressive difficulties but also to what data a therapist

would need to understand what a patient might be feeling. Here the problem is that “high tech” does not substitute for “high touch.” Meeting face-to-face involves many nuances of body language, facial expression, eye movement, and so on. Therapists who can get a good idea of how patients are feeling when meeting with them in the same room often find that patients may not come across as clearly via e-mail, a communication problem resulting from insufficient data.

3. Patients requiring more than text can provide. Anecdotal evidence from therapists who have attempted to provide a presence through electronic communication indicates that it is insufficient for some patients who need to be in the same room as the therapist. This is a therapist problem of matching a high return for patients who need it.

4. Combined psychotherapy and psychopharmacology. Pharmacotherapy requires routine physical assessment of signs, which by definition may be different from the symptoms patients report. It is unethical to prescribe medication without baseline observations and periodic examinations.

5. Psychodynamic therapy. Psychodynamic therapy typically involves mobilization and communication of affect, which is difficult for most people when exchanging texts.

There are many forms of psychotherapy. Those previously mentioned because the special requirements of an approved residency in psychiatry that took effect January 1, 2001 stipulate that a graduate be assessed as competent in each before graduating. It will be interesting to see if the teaching of these forms evolves to include the use of electronic text communication. This may parallel development of the interpersonal and communication skills that are one of the six competencies required of all physicians.

Other forms of therapy available on the Internet include chat rooms, self help groups, and support groups moderated by mental health professionals. Family and group therapy have been reported.

VII. FUTURE OF E-THERAPY

In the late 1990s there were many rosy predictions for what seemed to be an unstoppable Internet revolution that would reach into all aspects of our lives. An example of hype: “the hottest and certainly the most controversial new trend in therapy” with only five therapists practicing on-line in 1996 (a 1997 study found

275) and more than 500 in 2001 (the American Psychological Association panel in August noted many had left the field). Advantages cited include: "It's tailor made for business travelers and employed parents who find it hard to carve out daytime hours or keep appointments in one city. It costs less. E-mails average \$25 to \$50 each. ... Even rates of \$90 an hour fall below typical therapy charges of \$125 to \$165. It can work faster. There is evidence that people self-disclose more quickly to a computer than face-to-face. ... It may attract those too embarrassed to face a therapist: childhood sexual-abuse victims, the obese, those with physical deformities or painful secrets." But many changes predicted as a result of the Internet have not come to pass. Here are some that affect e-therapy.

A. Political Upheaval

Politics seemed changed in 1994 when Thomas Foley, Speaker of the United States House of Representatives with many years of incumbency, was upset by an unknown candidate waging his campaign through e-mail and the Internet. The Internet was touted as democratizing the political process, by offering direct democracy, more information available free to anyone interested, and a venue in which groups unable to afford conventional communication could be heard. However, politics has been documented as relatively unchanged after all, as established political forces have adapted to the new medium and incumbents have continued to be re-elected, often having more resources to devote to the Internet as well as other media. Therapy has its own political upheavals, and an e-therapy revolution connotes a therapeutic revolution, with all sorts of new types of therapy and therapists, a la the heady days of the community mental health center era. This seems no more likely than overall political change.

B. Dot Com Failures

It seemed that e-therapy might be part of the on-line shopping revolution, which fell short as the buying public has continued to want to experience potential purchases up close and making money on the Internet has proved to be difficult. In 1999 there were hundreds of sites offering e-therapy services to anyone who wanted to get involved. Many of these sites are no longer active, including here2listen, which had attracted large amounts of venture capital. Commercial failures in e-therapy have been attributed to unrealistic business plans, difficulty in sustaining growth, massive infrastructure costs, and dif-

ficulty in communicating benefits. However, although businesses have trouble making money on it, the Internet continues to grow and is expected to be a \$20 trillion industry by the year 2020.

C. Paperless Offices and E-Books

Although the rise of the Internet, local area networks, and e-mail were expected to lead to a paperless office, use of paper has been expanding rapidly in the Internet's go-go years. Studies show e-mail, in particular messages over half a page in length, tends to be printed and that people retain roughly 30% more of what they read on paper than on computer screens. Paper documents are easier to annotate and compare. Ink on paper, for example from a laser jet printer at 600 dots per inch, has six times the resolution of computer screens. Hewlett Packard estimates laser jet printers spewed out 1.2 trillion sheets of paper in 2001, a 50% increase in 5 years. Canadian exports of printing and writing paper to the United States grew 14% in 2000.

Although e-books were expected to replace paper, and it was predicted that books published only on the Internet would account for 10% of all book sales by 2005, only one book has been commercially successful when published on the web, and sales of handheld devices for reading such books have been very disappointing. People prefer to be reading something they have in their hands. At least it is unlikely that e-therapy manuals and other materials will exist solely in electronic form and there may be resistance to much use of e-therapy. E-therapy notes will almost certainly be printed and stored as paper, especially with the current interpretation of the need to maintain documentation under HIPAA.

On the other hand, telemedical consultations have mushroomed in specialized sectors and now account for 30% of all consultations done in prisons, where security and incarceration make direct access laborious. Telemedicine is beyond the scope of this article, except to say that (1) the remoteness of the patient from the therapist often leads to e-mail contacts as additional input, and (2) telemedicine and telepsychiatry have gained some reimbursement through being evaluated in controlled studies that find it worthwhile, despite loss of some of the input gained in face-to-face meetings.

The future of e-therapy depends on regulation (too much regulation will put it beyond the reach of all but highly committed therapists willing to invest the resources required to meet the regulatory requirements), clarification (Is it a conversation continuing by other means or separable from other therapies?), and its

eventual reimbursement (present pressures for nondiscrimination [parity] in health insurance may create an atmosphere of cost containment that would preclude reimbursement for e-therapy). Technical advances are likely to take it beyond its present definition.

See Also the Following Articles

Alternatives to Psychotherapy ■ Confidentiality ■ Engagement ■ Outcome Measures ■ Tele-Psychotherapy ■ Virtual Reality Therapy

Further Reading

- Ainsworth, M. (2000). The ABC's of Internet counseling [Online] Available: <http://www.metanoia.org/imhs>
- Bloom, J. R., & Walz, G. R. (Eds.). *Cybercounseling and cyberlearning: Strategies and resources for the millenium*. Alexandria, VA: American Counseling Association.
- HIPAA (2000). 45 CFR Subtitle A, Subchapter C, 164.501, as reported in the *Federal Register*, Vol. 65, No. 250, Dec 28, 2000, at 82805.
- Institute of Medicine. (2001). Crossing of the quality chasm: A new health system for the 21st century. Report issued March 21, 2001 <www.iom.edu>
- International Society for Mental Health Online. (2000). Guidelines for therapists and consumers communicating online. <www.ismho.org>
- International Society for Mental Health Online. (2001). Studies of e-therapy. <www.ismho.org>
- Kahn, R. E. (1994). *Realizing the internet future: The internet and beyond* (pp. 20–30). Washington: National Academy Press.
- Kane, B., & Sands, D. (1998). Guidelines for the clinical use of electronic mail with patients. *Journal of American Medical Informatics Association*, 5, 104–111. It can be accessed at <mail@mail.amia.org>
- King, S. A., & Moreggi, D. (1998). Internet therapy and self help groups—the pros and cons. In J. Gackenbach (Ed.), *Psychology and the internet: Intrapersonal, interpersonal and transpersonal implications* (pp. 77–109). San Diego, CA: Academic Press.
- Rothchild, E., McMahon, D., Taintor, Z., Alessi, N., Jones, B., & Hilty, D. APA resource document on telepsychiatry via videoconferencing (adopted by Board of Trustees 5/98) URL: www.psych.org/pract_of_psychiat/telepsychiatry.html
- TelehealthNet. (2001). <http://www.telehealth.net/articles/essays.html>
- Yellowlees, P. (2000). *Your guide to e-health*. Brisbane, Australia: University of Queensland Press. Available through <http://www.ebooks.com>

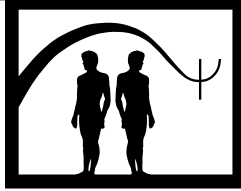

Operant Conditioning

Alan Poling, James E. Carr, and Linda A. LeBlanc

Western Michigan University

- I. Introduction
 - II. Theoretical Bases
 - III. Applications and Extensions
 - IV. Empirical Studies
 - V. Case Illustration
 - VI. Summary
- Further Reading

GLOSSARY

antecedent An event that precedes a behavior.

behavior Any action of a living creature. Behavior can be overt or covert.

consequence An event that follows and is produced by a behavior.

differential reinforcement A procedure used to establish stimulus control in which a particular behavior is reinforced in the presence, but not the absence, of a particular stimulus.

discriminative stimulus An antecedent stimulus that (a) given the momentary effectiveness of some form of reinforcement, (b) increases the frequency of occurrence of a particular behavior because, (c) historically, that kind of behavior was more successful in producing reinforcement in the presence of that stimulus than in its absence.

environment The natural world in its entirety, including all events that occur inside and outside living creatures.

establishing operation An event that alters the reinforcing or punishing value of a consequence.

extinction A procedure (or process) that reduces behavior by failing to reinforce a previously reinforced response.

fading An intervention that is used to transfer stimulus control from one discriminative stimulus to another.

functional assessment Procedures that are used to identify the reinforcer for a problem behavior.

negative punishment A procedure (or process) in which the removal of a stimulus after a behavior weakens (e.g., reduces the likelihood of) that behavior in the future.

negative reinforcement A procedure (or process) in which the removal or postponement of a stimulus after a behavior strengthens (e.g., increases the likelihood of) that behavior in the future.

operant A class of responses that “operate” on the environment to produce particular consequences. These consequences affect the future likelihood of occurrence of members of that response class.

positive punishment A procedure (or process) in which the presentation of a stimulus after a behavior weakens (e.g., decreases the likelihood of) that behavior in the future.

positive reinforcement A procedure (or process) in which the presentation of a stimulus after a behavior strengthens (e.g., increases the likelihood of) that behavior in the future.

response A defined unit of behavior.

rules Overt or covert verbal descriptions of relations among stimuli and responses.

stimulus A physical event.

stimulus control Control of behavior by an antecedent stimulus that is evident when some characteristic of a response (e.g., its rate, magnitude, or probability of occurrence) differs in the presence and absence of a particular stimulus.

stimulus equivalence A phenomenon in which stimuli that share no physical resemblance come to evoke the same behavior. If verbal humans are taught that $A = B$ and $B = C$, the relationship $A = C$ emerges without formal training.

stimulus generalization The spread of the effects of reinforcement (and other behavior-change operations) in the

presence of one stimulus to other stimuli that differ from the original stimulus along one or more dimensions.

token economy A therapeutic consequence system, based on conditioned reinforcement, that is frequently used in hospitals.

verbal behavior A behavioral term for language and related phenomena. The defining feature of verbal behavior is that other people mediate its effects on the environment.

The term operant conditioning does not refer to a specific technique for dealing with behavioral problems. Instead, the term, which was coined and popularized by the late B. F. Skinner, refers to a form of learning, or conditioning, in which behavior is controlled primarily by its consequences. Skinner called the new learned responses *operants* to emphasize that they operate on the environment to change it in some way: that is, to produce consequences.

I. INTRODUCTION

Edward Thorndike's work with cats in puzzle boxes, performed in the closing years of the 19th century, is a good example of operant conditioning. In those experiments, Thorndike placed individual cats in large crates from which they could escape by either pulling a string that was tied to a latch on the crate's door, or by pushing down on a pedal that would likewise open the door. If either response was made, the cats, which were mildly deprived of food, could get out of the box and get food. Thorndike found that all cats eventually made the response that opened the door, and on successive trials, it took progressively less time for the response to occur. Eventually, escape from the box occurred very quickly.

After many experiments with different animals in puzzle boxes yielded similar findings, Thorndike formulated one of the first psychological laws, the law of effect. It stated: Of the many responses made to a situation, the ones that are closely followed by satisfaction will be strongly connected to the situation and will be more likely to recur in that situation, while those that are followed by discomfort will be less likely to recur. The law of effect emphasizes that the historical consequences of a particular behavior in a given context are the primary determinant of current behavior in that context. Cats that previously escaped from a puzzle box and secured food by pulling a string do so rapidly and reliably when placed in such an apparatus. In contrast, cats without that history do not reliably pull the string.

B. F. Skinner did not use puzzle boxes. Instead, he developed a device known as an operant conditioning chamber, or Skinner box. The first such device, used with food-deprived rats, was a small box that contained a metal lever and a small cup into which food pellets could be delivered. Depressions of the lever were counted as responses, and food was delivered as a consequence for such responses. In Skinner's experiments, a rat could press the lever at any time and at any rate, and Skinner manipulated observable variables (e.g., degree of food deprivation, frequency of food delivery) to determine how they affected the rate and pattern of responding. For example, he compared responding when food followed every response and every 20th response, and he observed what happened when food was no longer delivered.

By observing the effect of changes in events before and after specified responses on the rate and pattern of recurrence of such responses, Skinner demonstrated the fundamental orderliness of operant behavior and determined how many different variables affected such behavior. In *The Behavior of Organisms*, published in 1938, Skinner reported the results of his early experiments and described several behavioral processes including reinforcement, extinction, discrimination learning, and punishment. In that book, he also drew a clear distinction between operant and respondent (or classical) conditioning. The fundamental distinction is this: operant behaviors are controlled by their consequences whereas respondent behaviors are controlled by stimulus-stimulus pairings. This distinction may be clarified by contrasting the arrangements used by Skinner to study learning in rats with that used early in the 20th century by the famous Russian physiologist, Ivan Pavlov, to study learning in dogs.

Pavlov observed that food placed in the mouth of a food-deprived dog reflexively elicited salivation. When he arranged conditions so that the sound of a metronome immediately preceded food delivery, after several pairings the sound also elicited salivation, although it did not initially do so. Here, the capacity of the sound to control salivation depended on the pairing of two events, or stimuli: the sound of the metronome and the presentation of food.

Although he did not overlook the importance of respondent conditioning in his well-known book titled *Science and Human Behavior*, Skinner emphasized the importance of operant conditioning in the genesis and maintenance of inappropriate as well as appropriate human behaviors. He also argued that an understanding of operant conditioning provides an excellent basis for

developing rational and effective treatments for a wide variety of behavioral problems. His argument has proven to be valid. From the 1950s to the present time, interventions based on principles of operant conditioning have been demonstrated in controlled studies to benefit people with many different clinical problems. For example, a task force commissioned by Division 12 (Clinical Psychology) of the American Psychological Association reviewed the entire psychological treatment outcome literature. Their findings, which were reported in 1995, indicated that the vast majority of successful interventions were either behavioral or cognitive-behavioral in orientation. Such interventions rely heavily on the principles of operant conditioning.

The fundamentals of operant conditioning are presented in the following sections. The key to understanding operant conditioning is the premise that operant behavior is determined in large part by its historical consequences under particular conditions. Therefore, the probability that such behavior will occur under current circumstances depends on (a) the nature of the historical consequences of the behavior, (b) the extent to which current conditions resemble the historical conditions under which particular consequences occurred, and (c) the current importance to the individual of the events that historically were consequences.

II. THEORETICAL BASES

B. F. Skinner repeatedly pointed out the similarity between operant conditioning and natural selection. In both cases, processes of variation, selection, and retention are apparent. Neither Darwin nor Skinner was able to specify the mechanisms underlying these processes. Skinner believed, however, that changes in physiology were responsible for the control of behavior by its consequences. In recent years, some progress has been made in understanding the physiological processes responsible for positive reinforcement and other principles of operant conditioning. For example, there is evidence that synaptic change is involved in learning via operant conditioning. Future work by neuroscientists may provide a detailed account of the proximal mechanisms that underlie operant conditioning, and in that sense, explain why environmental events affect behavior in particular ways. Some scholars hold the view that there can be no adequate “theory” of operant conditioning until this occurs.

Others, however, hold the view that operant conditioning is itself an adequate theory, insofar as the work

of Skinner and others has led to a system of principles and assumptions that are useful for explaining and predicting behavioral observations. We hold this view. There are a great number of specific interventions based on operant conditioning, and those interventions usually are closely tied to its basic principles. For this reason, in this section procedures are introduced at the time that the behavioral principles that form their basis are explained.

A. Consequences of Behavior

Operant behavior is primarily controlled by its consequences, which are events (stimuli) that are produced by (and follow) such behavior. A behavior's consequence(s) can either increase or decrease the future likelihood of the behavior occurring under similar circumstances. The term reinforcement is used to refer to the former relation (i.e., increased likelihood), whereas punishment is used to describe the latter (i.e., decreased likelihood).

1. Reinforcement

Reinforcement is evident when a response is followed by a change in the environment (reinforcer) and is thereby strengthened. The response-strengthening effects of reinforcement typically involve an increase in the future rate of the response, although other changes in behavior (e.g., an increase in response intensity) may also be indicative of a reinforcement effect. It is important to recognize that, by definition, reinforcement always strengthens targeted behaviors. If a behavior is reliably followed by a consequence and its future likelihood is not increased, then the consequence was not a reinforcer.

Psychologists have traditionally classified reinforcers according to whether they are added to (e.g., presenting food) or subtracted from (e.g., turning off a loud noise) the environment. When a stimulus strengthens behavior by virtue of being presented as a consequence, the stimulus is termed a positive reinforcer, and the outcome is termed positive reinforcement. A spouse who responds with sympathetic statements to a mate's complaints about feeling “down and worthless” is positively reinforcing the occurrence of such statements, if such consequences increase the likelihood of such statements occurring in the future. In this case, the effects of the spouse's attention would be both unintentional and undesirable. Unintentional positive reinforcement frequently plays a role in the development and maintenance of psychopathological behaviors.

Clearly, the “positive” in “positive reinforcement” does not mean “good”; instead, it refers to a stimulus being “added” to the environment. For example, abused drugs (e.g., alcohol, heroin, the nicotine in tobacco) are positive reinforcers for the behavior of people who abuse them, but they cause untold suffering for those individuals and others.

Of course, in many cases, positive reinforcement is used intentionally and to good effect. Praising a young girl when she says “Da Da” when her father picks her up is an example of such positive reinforcement. Here, praise occurs dependent on the child’s vocalization, and the relationship between the response and the outcome constitutes positive reinforcement if the behavior is strengthened as a result of that relationship. A response-strengthening effect probably would not be evident after praise followed “Da Da” on a single occasion, however. The effects of reinforcement are cumulative, and a reinforcer often must be delivered on multiple occasions before behavior changes noticeably. Moreover, once an operant behavior is well established, the effects of reinforcement are primarily to maintain, not to increase, responding. There are obvious limits on how reliably and how rapidly a child can say “Da Da” when picked up by dad and, for most children, those limits are reached fairly quickly.

Like positive reinforcement, negative reinforcement also strengthens behavior, but it does so because behavior (*a*) postpones or prevents the delivery of an otherwise forthcoming stimulus, or (*b*) terminates or reduces the intensity of a stimulus that is currently present. The former relation (*a*) is termed avoidance conditioning and the latter relation (*b*) is termed escape conditioning. A spouse who calls home to say “I’m sorry, but I’ll be working late tonight” before going to a motel with a lover is emitting an avoidance response, if so doing prevents unpleasant interactions on returning home and is for that reason strengthened. A person who terminates aversive questions regarding fidelity by saying “Don’t be silly, you’re the only one I want and love; a bunch of us just stopped for beers after work” is emitting an escape response if the questions stop and such responding is therefore strengthened. Although both responses are incompatible with having an honest and healthy marriage, and may well be maladaptive in the end, their historical short-term consequences are sufficient to maintain them. This is often the case with respect to troublesome operant behaviors, regardless of whether they are maintained by positive or negative reinforcement. Neither positive nor negative reinforcement is intrinsically good or bad. Both processes can foster and

maintain pathological as well as adaptive actions. Moreover, both processes can be used clinically to alter troublesome behaviors that do emerge.

An important early step in the treatment of many troublesome operant behaviors is isolating the reinforcers that maintain those behaviors, as well as any events that reliably precede them. This process, termed functional assessment, can be performed in a number of different ways and provides a basis for developing rational interventions. Consider a child diagnosed with mental retardation who sometimes loudly taps a pencil on a classroom desk. Observation suggests that teachers attend to the child each time this occurs. This relation suggests, but does not prove, that attention from teachers is a positive reinforcer that maintains the troublesome behavior. If this is the case, teaching staff not to attend to the child’s pencil tapping, and to attend to some incompatible and appropriate activity, such as working on assigned materials, might well be an effective intervention.

Although the distinction between positive and negative reinforcement is simple logically (see Figure 1), in practice it can be hard to tell the two apart. For example, does a person adjust the tuning on a blurry television because doing so in the past has produced a clear image (positive reinforcement), or because doing so historically has removed a blurry image (negative reinforcement)? Because of such difficulties, and the possibility of confusing negative reinforcement with punishment, there is good justification for not differentiating positive and negative reinforcement, although the practice remains common.

A variety of environmental changes (i.e., stimuli) can serve as reinforcers. Unconditioned (or primary) reinforcers strengthen behavior in people without any particular history. Many primary reinforcers are of direct biological significance. Air, food, and water are examples of positive reinforcers that fit into this category. Primary negative reinforcers, which organisms will escape (respond to terminate) or avoid (respond to postpone), include high-intensity stimulation in most modalities (e.g., loud noises, extreme temperatures).

In contrast to primary reinforcers, conditioned (or secondary) reinforcers gain their ability to strengthen behavior through learning. Conditioned reinforcers can be established through respondent conditioning, that is, by being paired with (i.e., immediately preceding the delivery of) primary reinforcers or other established conditioned reinforcers. They also can be established through verbal mediation. Money is the prototypical example of a conditioned reinforcer.

	<u>Consequence is presented</u>	<u>Consequence is removed</u>
<u>Behavior is Strengthened</u>	Positive reinforcement	Negative reinforcement
<u>Behavior is Weakened</u>	Positive punishment	Negative punishment

FIGURE 1 Operant Conditioning.

The stimuli that serve as conditioned reinforcers vary substantially across people because of differences in their conditioning histories. For instance, certain kinds of painful stimulation (e.g., being struck with a leather belt) are in some situations positively reinforcing for people labeled as masochists, but not for other individuals. This is probably because such stimulation historically preceded a powerful positive reinforcer, most likely sexual stimulation, for some people, but not for others. Being struck with a belt initially was not positively reinforcing, but it eventually came to be so by virtue of reliably preceding sexual stimulation. Like other conditioned reinforcers, it will maintain its reinforcing ability only if it continues to be paired (actually or verbally), at least occasionally, with some other reinforcer. Once a conditioned reinforcer is no longer paired with another reinforcer, it loses the ability to strengthen behavior.

Although reinforcers typically are construed as stimuli, in some cases it is the opportunity to behave in certain ways that a stimulus affords, not the stimulus per se, that is important. For instance, access to food allows eating and access to a beverage allows drinking. During the 1950s, David Premack developed a response-based model of reinforcement that emphasizes that the opportunity to engage in a more preferred behavior will reinforce a less preferred behavior, a relationship known as the Premack principle. In this context, preference refers to the relative amount of time that an individual will engage in the behaviors if unconstrained. If, for example, an eighth-grade student is given a

choice between playing basketball and doing math problems and spends more time playing basketball, then that behavior is the more preferred one. If this is so, then according to the Premack principle the opportunity to play basketball (the more preferred behavior) will be an effective reinforcer for solving math problems. Parents could use this relation to increase the time that their child spent working on math. That is, in order to play basketball for a given period, the child first must solve a specified number of math problems.

Environmental events may reinforce responses that precede them even if the response does not actually produce the reinforcer. For instance, a pool player shooting the nine ball may say “roll fast, sweetheart” as the nine ball slowly approaches a pocket. The player is apt to repeat the phrase under similar conditions in the future if the ball drops, winning the game, even though there is no plausible mechanism whereby the verbal response could influence the ball or table. This type of reinforcement, termed superstitious or adventitious, may control behaviors that appear counterintuitive. It should be noted, however, that explaining a behavior as being superstitiously reinforced begs the question of how the behavior is actually controlled, unless the nature of the superstitious reinforcement is apparent.

a. Variables That Influence the Effectiveness of Reinforcers Several factors affect the degree to which reinforcing consequences strengthen behavior. Four factors are especially important.

1. The quality and magnitude of the consequence. Stimuli differ in their effectiveness as reinforcers across people and within people across circumstances. Isolating effective reinforcers for clients often is an important part of therapy, and specific procedures have been developed for identifying reinforcing objects and activities. For example, objects that will positively reinforce behavior in a person with mental retardation can be isolated by presenting putative reinforcers (e.g., a car, a whistle, and a toy dog) and determining which, if any, object the person contacts. If, for instance, a child regularly selects and plays with the stuffed dog, it is reasonable to assume that the toy will serve as a positive reinforcer for that person's behavior. The car and whistle might do likewise, but they probably will be less effective as reinforcers. In general, reinforcer effectiveness tends to increase with the magnitude or intensity of a given stimulus. For example, \$20 is a more effective reinforcer than \$2 for most people's behavior. Ultimately, however, reinforcer effectiveness must be directly assessed, not simply inferred.

2. The level of motivation relevant to the consequence. The importance of this variable, which is discussed in detail later, is evident if one considers the reinforcing effectiveness of a given kind of food (e.g., a hamburger) as a function of how recently and how much one has eaten.

3. The delay between the response and its consequence. In the absence of verbal mediation, delaying consequences substantially reduces their effectiveness as reinforcers.

4. The schedule of delivery of the consequence. Many different relations, termed *schedules* (or, if behavior is strengthened, *schedules of reinforcement*), can be arranged between consequences and the events that produce them. For example, under a continuous reinforcement schedule every response produces the reinforcer. Behavioral interventions are typically implemented initially on continuous schedules and eventually the schedule is changed to some type of intermittent reinforcement schedule. The term *intermittent reinforcement* indicates that some instances of the behavior result in reinforcement whereas others do not. Most human interactions occur under intermittent schedules. For example, the gambling of individuals who play slot machines is maintained under an intermittent reinforcement schedule. Not every coin dropped into the slot results in a payoff. In fact, most do not; but eventually one of the coins is followed by a reinforcing payoff. Casino operators program this arrangement, which would be technically described as a *variable-ratio schedule*, because it generates a high rate of responding that persists for a relatively long time, even if no reinforcers are forthcoming.

The schedule of reinforcement that is arranged is one variable that determines response effort, which is the amount of force, exertion, or time required to execute a response, or to earn a reinforcer. Research has shown that (a) response rates generally decrease as response effort increases, (b) behavior weakens more rapidly during extinction as effort increases, (c) individuals will escape from situations that require particularly effortful responding, and (d) individuals prefer lower-effort responding to higher-effort responding. Knowing these effects of response effort can be of benefit in dealing with clients' troublesome behaviors.

As a case in point, broken health care appointments are a major problem in medicine. Something in the neighborhood of 10 to 30% of appointments are broken, and in such cases patients fail to receive needed services, and the schedules of service providers are disrupted. One strategy for reducing the number of appointments that patients miss is to reduce the effort required to keep an appointment. This tack was taken in the 1980s by Pat Friman and his associates, who mailed a parking pass and a reminder to patients who had scheduled appointments at pediatric clinic. Their notion was that the reminder made it easier to remember the appointment and the parking pass made it easier to park, therefore, the effort required to keep the appointment was reduced. This cheap and simple intervention was effective, insofar as it reduced missed appointments by approximately 20%.

As the preceding example illustrates, understanding of schedules can be used to good advantage in dealing with some clinical problems. Consider as a second example, a child diagnosed with autism who often flaps his hands in front of his face during school sessions. The behavior is considered undesirable because it interferes with educational activities. A possible strategy for reducing hand flapping to acceptable levels is to arrange conditions such that access to some reinforcing activity or object depends on the passage of a specified interval during which hand flapping does not occur. If the response occurs, the interval is reset. Initially, only a short time without hand flapping is sufficient to earn reinforcement. Over time, and only when hand flapping is adequately controlled, the interval without responding required for reinforcement is increased. Such procedures, which often are termed *differential-reinforcement-of-other-behavior* (DRO) schedules, have been used to good advantage in reducing various problem behaviors.

But how is it that behavior can be reduced by reinforcement, which by definition always strengthens behavior? The answer is that the unit of behavior that is

reinforced under DRO schedules is an interval of not responding. For instance, if the child in our example were exposed to a DRO 5-min. schedule, 5 min. must elapse without hand flapping for the reinforcer (e.g., teacher attention) to be delivered. If the child is sensitive to this arrangement, 5-min. (or longer) intervals without hand flapping will increase in frequency. When this occurs, incidents of hand flapping will decrease. People can learn through reinforcement to omit as well as to emit particular responses.

2. Punishment

When laypeople think of learning-based procedures for reducing responding, they often think of punishment. Punishment occurs when behavior is weakened by its consequences, which are termed punishers. Many psychologists differentiate between positive and negative punishment, and the basis for the distinction is the same as that for distinguishing between positive and negative reinforcement (see Figure 1). If behavior is weakened because such responding adds something to an individual's environment, positive punishment is involved. If, however, behavior is weakened because such responding removes (or decreases the intensity of) some stimulus, the procedure is termed negative punishment.

Like reinforcers, punishers can be conditioned or unconditioned. The same processes that establish stimuli as conditioned reinforcers are also effective in establishing neutral stimuli as conditioned punishers. A common example of a conditioned punisher is the word "no." Without any prior training, a toddler will not have any specific reaction to "no." However, early in the life of most English-speaking people, the word is paired with unconditioned punishers and is thereby established as a conditioned punisher. For example, a young child may touch an electrical outlet in the presence of his parents. A quick, forceful grab of the child's arm (an unconditioned punisher), accompanied by a stern "no," will likely decrease the probability of the child touching outlets in the future. It will also be an initial step toward establishing "no" as an effective punisher. Of course, several pairings with another punisher may have to occur before the word alone has a response-reducing function. Once it does, the word can be used as a positive punisher to reduce various undesirable behaviors emitted by the child.

Relatively few people object to parents saying "no" to prevent their child from electrocution. But there has been considerable controversy about the use of punishment in therapeutic settings. Many therapists advocate the use of reinforcement-based procedures and consider

punishment-based procedures unnecessarily intrusive. Others maintain that clients have a right to effective interventions and, if reinforcement-based procedures have failed, then other interventions that have been proven efficacious in similar cases, including punishment, should be used. A substantial literature documents the efficacy of punishment-based procedures when other interventions have failed, although applications have been largely limited to dangerous behaviors, such as self-injury, exhibited by people with developmental disabilities in controlled settings. When punishment is used, it typically is incorporated into an intervention package that also includes reinforcement procedures.

In general, negative punishment is better accepted than is positive punishment. When negative punishment is arranged, the consequence of an undesired behavior is that a person loses access to something of value. For example, exceeding the speed limit may result in a financial loss when the cost of a speeding ticket is paid. If the person is less likely to speed in the future as a result of receiving a ticket, negative punishment has occurred.

Two common procedures based on negative punishment are timeout and response cost. Timeout refers to the removal of access to positively reinforcing objects and activities for a preset time when a specified behavior occurs. For instance, when a child has broken a family rule (e.g., hit a sibling), the parents may arrange timeout by placing the child in a corner of the room with no access to interaction or toys for 3 min. If the behavior is weakened, negative punishment has occurred. Response cost typically involves removal of a specified amount of a reinforcer when an unwanted behavior occurs. Being fined for a traffic violation as described earlier is an example of response cost.

Overcorrection is another procedure based on punishment principles. It is based on the notion, originally advanced by David Premack and sometimes included as part of the Premack principle, that forcing an individual to engage in a less preferred behavior as a consequence of a more preferred behavior will punish the more preferred behavior. As an example of overcorrection, a child who has had a tantrum and thrown food on the dining room floor (a more preferred behavior) might be required to pick up the food and scrub the floor (a less preferred behavior). This procedure is apt to reduce the future likelihood of food being thrown and is appealing to many people because it is restitutional in nature—the child repairs the damages caused by inappropriate behavior. The primary problem with overcorrection is that it can be difficult to force people to engage in nonpreferred activities.

Critics sometimes argue that the effects of punishment are short lived. This may or may not be true and depends on specifically how punishment is arranged. Moreover, the effects of reinforcement also are short lived, in the sense that the changes in behavior produced by reinforcement eventually disappear when reinforcement no longer occurs. In general, operant conditioning procedures affect behavior only so long as they are in place, regardless of the specific nature of the procedures.

Other criticisms are that punishment produces undesirable emotional behavior, as well as escape from and avoidance of the individual who delivers the punisher. In addition, punishment may produce a generally passive and unresponsive individual. Although all of these adverse effects may occur, they are most probable with severe positive punishment. Mild punishment, both positive and negative, is a common and accepted part of human interactions that also occurs in many therapeutic contexts. For instance, a therapist treating a depressed client may say, “no, that’s no really true – you’re not that way at all” when the client describes him- or herself as helpless and unwanted. The intent is to reduce the future likelihood of the client making such statements. If the intent is realized, punishment has occurred, and the client has probably benefited.

In general, the same kinds of variables that influence the effectiveness of reinforcement also determine the effectiveness of punishment. Therefore, maximal response reduction is apt to occur when strong punishers are delivered after each occurrence of an undesired response. Making available an alternative and appropriate response that produces the same reinforcer that maintains the undesired response also increases the effectiveness of punishment. In practice, it often is difficult to arrange effective punishment for troublesome behaviors. For example, many people drive over the speed limit, although doing so may result in expensive tickets. They do so because the likelihood of receiving a ticket for a given instance of speeding is low, and the cost of the ticket is not great relative to most people’s income. If every motorist received a ticket costing one month’s pay each time they drove over the speed limit, and if this relation were assured, there would be few speeders.

3. Extinction

As long as a behavior produces an effective reinforcer, that behavior will recur. However, when responding no longer produces the reinforcer that once maintained it, the behavior eventually ceases. This process, and the pro-

cedure used to arrange it, is called extinction. The example described previously in which a child’s striking of a desk with a pencil was eliminated by having teachers stop attending to the behavior is an example of extinction. Reducing abusers’ intake of heroin by treating them with the drug naltrexone is another example of extinction. Here, naltrexone blocks the subjective and physiological effects of heroin, so that when a person takes the drug, there are no reinforcing consequences. Under these conditions, heroin self-administration eventually ceases. A serious problem, of course, is that individuals can stop taking naltrexone, ending the pharmacologically induced extinction.

Responses that have an extended history of reinforcement are likely to persist for a substantial period despite failing to produce a reinforcer. In fact, when extinction is first implemented, an individual may respond at higher rates or intensities than usual. This is known as extinction-induced bursting. Emotional responding and increases in the variability of behavior also commonly occur during extinction. As examples of these phenomena, consider what happens when a person puts a dollar in a vending machine, pushes a button in a manner that historically has produced a favored soda, and gets nothing. She or he is likely to curse, pound the machine, and push other buttons. The individual may even put more money in the machine. Eventually, however, machine-related behavior ceases.

The overall persistence of responding when reinforcement is no longer available is called resistance to extinction and is one measure of response strength. Even when responding falls to near-zero levels during extinction, the behavior remains in the organism’s repertoire and may return quickly to previous levels if reinforcement once again becomes available. More interesting, when motivation relevant to a particular kind of reinforcer is high and responses that recently have produced that reinforcer are unavailable or ineffective, previously extinguished responses often occur. This phenomenon is termed resurgence.

Avoidance responses often persist for long periods, even indefinitely, in the face of extinction. In large part, this is because it is difficult for an individual to ascertain that conditions have changed. Successful avoidance responses prevent an event from occurring, and that event does not occur during extinction, unless extinction is arranged so that the event that served as a negative reinforcer is now presented repeatedly regardless of whether the historical avoidance response occurs or not. Under the latter condition, responding weakens relatively quickly.

4. Complex Consequence Systems: Token Economies

Both in everyday and therapeutic settings, consequences typically do not occur as single events in isolation. Instead, complex consequence systems may be implemented for several different behaviors simultaneously. One of the most common and effective therapeutic consequence systems is the token economy. Ted Ayllon and Nathan Azrin developed token economies in the mid-1960s as an intervention for chronic psychiatric patients. Since then, token economies have become widely accepted and are included as a standard part of many inpatient hospital treatment programs. A token economy typically allows a person to earn rewards and privileges (positive reinforcers) for emitting appropriate behaviors, such as attending therapy sessions and attending to personal hygiene. Typically, privileges are lost (i.e., negative punishment is arranged) when inappropriate behaviors, such as hoarding items or stealing, occur.

A token economy has three vital components: (a) tokens, (b) backup reinforcers that can be obtained with a certain number of tokens, and (c) schedules for reinforcement, punishment, and token exchange. The tokens function as conditioned reinforcers. Conditioned reinforcers have no intrinsic value, but they acquire the capacity to function as positive reinforcers because they can be exchanged for highly preferred items or for access to preferred activities. Generally, a person may earn tokens throughout a day or week and then trade them in for backup reinforcers at a preset exchange time and rate. Once appropriate behavior is established under stringent conditions, schedules can be altered to better approximate those that clients will encounter outside the inpatient setting.

B. Antecedent Influences on Behavior

The previous sections have considered how events that occur after operant behaviors (i.e., consequences) affect such responding. The following two sections discuss how operant behaviors are affected by prior, or antecedent, events.

1. Stimulus Control

As Thorndike suggested with the law of effect, the effects of reinforcers and punishers are relatively situation specific. That is, the behavioral effects of reinforcement (or punishment) that occurs in one context may not be evident in another context. Because of this, an individ-

ual's behavior often differs substantially across settings. Consider our previous example of a girl who has learned to say "Da Da" when picked up by her father. Initially, the same response might occur when another person, perhaps her mother, picked her up. However, before long mom would not evoke "Da Da," although dad would continue to do so. Another verbalization, probably "Ma Ma," might well occur when the mother picked up the daughter. In this situation, the person who holds her determines what the baby says and the child's verbal behavior is controlled by an antecedent stimulus, that is, by an event (i.e., the presence of the father or mother) that occurs before the behavior.

In general, stimulus control is evident when some characteristic of a response (e.g., its rate, magnitude, or probability of occurrence) differs in the presence and absence of a particular stimulus. Stimulus control can be excitatory or inhibitory. In the former case, the likelihood of the response occurring is higher in the presence of the stimulus than in its absence. In the latter, the likelihood of the response occurring is lower in the presence of the stimulus than in its absence.

Stimulus control is ever present in everyday life. It can be established through respondent conditioning, but most of the stimulus control that is evident in human behavior occurs as a result of operant conditioning, in which the consequences of behavior differ in the presence and absence of a stimulus. For example, in the example of the girl responding differently to her two parents, saying "Da Da" was reinforced (probably by attention, praise, and cuddles) in the presence of the father, but not the mother. Saying "Ma Ma," in contrast, was reinforced when mom, but not dad, picked up the child. As a result, the two people evoked different responses in their daughter.

In the context of operant conditioning, excitatory stimulus control typically occurs with discriminative stimuli. The term discriminative stimulus (S^D) is used to refer to a stimulus that (a) given the momentary effectiveness of some form of reinforcement, (b) increases the frequency of occurrence of a particular behavior because, (c) historically, that kind of behavior was more successful in producing reinforcement in the presence of that stimulus than in its absence. The mother and father are S^D s in our example of the child learning to talk. Other examples of S^D s controlling behavior include saying "4" when presented with " $2 + 2 = __$," beginning to play a musical instrument when a conductor's baton is raised, and taking food from an oven when the timer rings. In each case, doing so has "paid off" (i.e., been reinforced) in the past. A history of success in the presence

of an S^D gives that stimulus the capacity to control behavior. Behaviors controlled by S^D s continue to be so controlled only if reinforcement is at least occasionally arranged for those behaviors. If not, stimulus control eventually disappears.

If the historical consequences of behavior are punishing in the presence of a particular stimulus, then that stimulus is likely to acquire inhibitory control over such responding. Consider, for instance, two college students at a party who are talking about their favorite TV show. An influential professor, who in the past has criticized (punished) their comments about TV, approaches them, and they stop talking about TV. This is inhibitory stimulus control—if the professor were not around, comments about TV would occur more frequently. Stimuli present during extinction, as well as during punishment, also may acquire inhibitory control over behavior.

In clinical situations, it is often important to identify the S^D s that operate in a client's environment and, if possible, to manipulate those stimuli to evoke appropriate behavior. Assume, for instance, that a functional assessment revealed that a child made rude noises in class primarily because the student sitting in the next seat laughed appreciatively when such sounds occurred. Given this, it is reasonable to assume that the laughter reinforces the noisemaking, and that the child who laughs is an S^D for the other child's disruptive behavior. If so, moving the noisemaker to a seat where the other child could not be readily seen would be a simple, and probably effective, intervention. It would be made even stronger if the noisemaker was seated beside another classmate who was an S^D for working quietly on tasks.

In some cases, establishing appropriate stimulus control is an important therapeutic goal. Consider, for example, the treatment of a convicted date rapist. It may be the case that such an individual has not learned to respond appropriately to social stimuli, such as a potential partner moving away, or saying "that's enough." Persisting in the face of such stimuli may have resulted in sexual gratification in the past. Establishing appropriate stimulus control of sexual behavior would be a necessary part of the treatment of the rapist. Practical and ethical considerations, however, probably would make this task relatively difficult to accomplish, and verbal mediation or contrived feedback in controlled settings, not direct exposure to consequences in a dating setting, would have to be used to establish stimulus control. A potential problem with such procedures is that the stimulus control established in the therapeutic setting might not generalize to actual dating situations.

In some cases, simply presenting a stimulus under conditions where responding is reinforced may be insufficient to establish stimulus control. Suppose you were trying to teach a child how to learn math facts with flashcards. Your instruction might include presenting a flashcard (e.g., $10 \div 2 = \underline{\quad}$), requesting the answer, and providing error correction or praise, depending on the response. You would probably consider the child successful if the answer were correct following three consecutive presentations of the card. In addition, you would probably assume that the child "knew" the answer to " $10 \div 2$." Suppose, however, that the child merely guessed at the correct answer initially and subsequently provided it not in response to the actual numbers printed on the card, but instead in response to the size and color of the numerals. Therefore, the answer "5" would be given to any set of two black numbers printed in 12-point font, not just to " $10 \div 2 = \underline{\quad}$." This example illustrates the problem of "attention" in stimulus control. Individuals occasionally respond to unintended features of an antecedent stimulus, such that effective stimulus control is not developed. To counteract this effect, it is crucial to correlate differential consequences with the presence of the specific antecedent stimulus features that should control the behavior. In our example, the child would need to be exposed to other flashcards bearing problems different from " $10 \div 2 = \underline{\quad}$," but of the same size and color. The response "5" would be reinforced only when it was appropriate to the numbers presented, and in this way attention could be focused on that dimension of the flashcard, which is the sole relevant dimension in this example.

As this example illustrates, discrimination training can be used to establish behavior so that it only occurs in the presence of a specific S^D . In discrimination training, only instances of the target behavior that occur in the presence of the target S^D are reinforced. All other behaviors are placed on extinction in the presence of the S^D . In addition, the target behavior is placed on extinction in the presence of all antecedent stimuli except the S^D . The degree to which you reinforce only the target behavior determines how "tight" the stimulus control becomes (i.e., the degree of stimulus discrimination). For example, a classroom in which student questions are answered following both hand raising and calling out would most likely appear somewhat chaotic. If, however, the instructor only answered the questions of students whose hands were raised, and the answers were reinforcing, then the class would appear more orderly. In other words, tight stimulus control over the students' behavior would be achieved.

In some cases, consequences occur only when two or more stimuli, or stimulus dimensions, are present, and as a result a conditional discrimination is formed. For example, a child asking (behavior) his parents (antecedent) for money (consequence) only on or after payday (conditional antecedent) constitutes a conditional discrimination. The behavior occurs only when both antecedents (i.e., parents and payday) are present because, historically, that was the only time that the behavior was reinforced.

2. Antecedent Stimulus Classes

The stimulus control of human behavior is subtle and complex. In many cases, a number of different stimuli control equivalent behaviors in the same person. That is, they are members of the same stimulus class and are functionally equivalent.

One way in which different stimuli can acquire the same function is through stimulus generalization, which can be conceptualized as the counterpart to stimulus discrimination. Generalization occurs when antecedent stimuli that share a physical resemblance with an established S^D control the behavior evoked by that S^D . For example, suppose a child learns to say “dog” in the presence of a dog. The child might later say “dog” in the presence of a cat, not because this behavior was previously reinforced, but instead because dogs and cats share certain physical similarities (e.g., four legs, fur, tails).

A second way in which stimuli can come to control the same behavior is by being correlated with the same consequences for that behavior. For example, a stop sign, a red traffic light, and a traffic control officer with an outstretched palm may constitute a functionally equivalent class of S^D s for stopping a car. These physically different antecedents acquired the same stimulus control properties because of a shared history of reinforcement for stopping.

A third way in which functionally equivalent stimuli can be established is through a phenomenon known as stimulus equivalence. Stimulus equivalence is thought to be a product of learning certain conditional discriminations. Specifically, individuals learn that $A = B$ and $B = C$. As a result of such learning, the transitive relation “ $A = C$ ” automatically emerges, although it is not specifically trained. After the relation emerges, the stimuli A and C are functionally equivalent. For example, a person may learn that Jessie is a Harvard graduate, which can be construed as learning $A = B$ (Jessie = Harvard graduate). That same person may also learn that Harvard graduates are exceptionally intelligent people, which can be construed as $B = C$ (Harvard

graduate = very intelligent person). As a result of learning these two relationships, the person would “automatically” know that Jessie was a very intelligent person and would respond to her by emitting whatever behaviors that person historically had learned to emit in the presence of “very intelligent people.” Similar behaviors would be occasioned by anyone described as a Harvard graduate and, depending on the history of the person responding to them, a wide range of behaviors may occur in their presence. Some people, for instance, learn to avoid highly intelligent people. Others ridicule them, whereas some seek them out as companions. Stimulus equivalence plays an extremely important role in determining how humans behave, and researchers have demonstrated the relevance of the concept to areas as broad as language development and adult psychopathology.

3. Fading

A common intervention that achieves its effects due to stimulus control is fading. The purpose of fading is to transfer stimulus control from an S^D that currently evokes the desired behavior to a new S^D that should evoke the behavior. In a fading procedure, the S^D for a particular behavior is gradually removed while the new S^D is gradually introduced. Thus, the target behavior occurs throughout the procedure, only the S^D s are altered. This can be beneficial in that the individual frequently contacts reinforcement for the behavior. There are two general categories of fading.

Prompt fading occurs when a response prompt is physically removed from an individual’s environment. For example, an individual in rehabilitation for a traumatic brain injury might initially require physical assistance to walk. In this case, the individual is walking, although dependently, at the onset of rehabilitation. As therapy progresses, the physical assistance is gradually removed so that the patient walks independently. In this example, stimulus control was transferred from the S^D of physical guidance to the S^D of physical independence through prompt fading.

Stimulus fading occurs when a stimulus prompt is physically removed from an individual’s environment. For example, a teacher might use ruled (lined) paper when teaching a child how to write. The lines could eventually be lightened and/or spaced closer together such that the child learns to write smaller and straighter text. In this case, the child’s writing is reinforced throughout the fading procedure. Stimulus control was transferred from the S^D of dark/wide lines to lighter/narrower lines through stimulus fading.

4. Motivational Control

One factor mentioned, but not discussed, in the section dealing with variables that influence the effectiveness of reinforcers, is the level of motivation relevant to the consequence. In operant conditioning, “motivation” is often explained in terms of a behavior’s reinforcer. That is, if an individual is “motivated” to perform a behavior, then there is most likely a reinforcer available for that behavior. Although this approach has been useful, an adequate account of motivation must include antecedent influences on behavior. The previous section described how events that occur immediately before behavior can influence responding. However, some events that occur immediately or long before a response can also affect its occurrence, as well as the value of its consequences (i.e., motivation). Such events are the focus of the next section.

5. Establishing Operations

In general, an establishing operation (EO) is an antecedent event that produces two effects. One is a function-altering effect, which momentarily changes the value of a reinforcer or punisher. The other is an evocative effect, which momentarily alters the likelihood of occurrence of behaviors that have been previously reinforced or punished. As an example of a function-altering effect, a period without any interpersonal interactions might make a conversation more reinforcing. In other words, we might say that deprivation (i.e., lack) of social interaction establishes a conversation as a reinforcer. Social deprivation probably also would have an evocative effect: in addition to establishing conversation as a reinforcer, it also increases the probability of behaviors that have been previously reinforced with attention (e.g., making a telephone call to a friend). Thus, EOs alter the effectiveness of reinforcers (or punishers) and alter the likelihood of occurrence of behaviors that have produced those reinforcers in the past.

It is important to note that an EO can make an event either more or less reinforcing (or punishing). For example, food deprivation increases the reinforcing effectiveness of food, but free access to food reduces its reinforcing effectiveness. It is also important to note that an EO’s effects usually are not permanent. EOs characteristically produce relatively short-lived effects; such is the nature of “motivation.”

EOs can be either conditioned or unconditioned effects. Unconditioned establishing operations (UEOs) produce their effects in the absence of any particular learning history. A clinically relevant example of a UEO is the duress that a person who is physically dependent

on heroin experiences during withdrawal from the drug. During the highly unpleasant withdrawal syndrome, the effectiveness of heroin as a positive reinforcer increases, as does the likelihood of occurrence of behaviors that have produced heroin in the past.

In contrast to UEOs, conditioned establishing operations (CEOs) are developed through several different associative processes. That is, they are learned. An example of a CEO is the host of a TV game show saying to the audience, “I’ll give \$1,000 for every broken pencil you can show me.” Following that statement, but not prior to it, broken pencils would have substantial reinforcing value. Behaviors likely to produce broken pencils (e.g., rummaging through purses), therefore, would be far more likely to occur.

One example of a clinical intervention that most likely achieves its effects via EOs is noncontingent reinforcement (NCR). NCR has recently been used to treat the undesired behavior (e.g., self-injury) of individuals with developmental disabilities. Before NCR is implemented, the reinforcer responsible for maintaining the behavior is identified through functional assessment. This reinforcer is subsequently delivered to the individual on a time-based schedule regardless of whether or not the undesired behavior occurs. In other words, the individual receives “free” access to the reinforcer. Hence, the “motivation” to engage in the behavior is reduced. In this case, the free delivery of the reinforcer is an EO that results in a reduced probability of undesired behavior.

Methadone maintenance treatment of heroin abusers is another example of a treatment with an EO component. Methadone “substitutes” for heroin, reduces the likelihood of withdrawal occurring, and decreases the reinforcing value of heroin and the likelihood of occurrence of behaviors that in the past produced heroin. Because many of those behaviors are harmful to the heroin abuser, as well as to other members of society, this is a desirable effect. So, too, is reduced contact with heroin.

C. Verbal Behavior

Humans are like other animals in many regards, but verbal behavior makes humans unique. Verbal behavior is the term that B. F. Skinner used to refer to what many people call language. In his 1957 book, *Verbal Behavior*, and in other writings, Skinner emphasized that talking, writing, and signing is operant behavior that affects the world indirectly, through the mediation of someone else’s behavior. In contrast, nonverbal operant behavior affects the world directly. For example, consider a thirsty 3-year-old girl who is sitting in the living

room playing with her father. She can gain access to water by walking to the kitchen, getting a glass, and filling it with water from the tap. She can achieve the same outcome by saying, "Dad, please get me a glass of water." In the first case, the girl's actions directly produce water. Therefore, her behavior is nonverbal. In the second case, the girl's actions cause her father to behave in a way that produces water. Because of this mediation by another person, her behavior is verbal.

Verbal behavior is like nonverbal operant behavior in that it is acquired and maintained as a result of its effects on the environment. The specific environment that is affected by verbal behavior is a social one comprising other people. Verbal behavior is developed and maintained because it is reinforced by the actions of a social community that is taught, although not formally, to reinforce such behavior. Because different people reinforce different patterns of verbal responding, relatively strong audience control of verbal responding is common. As an example, consider how differently most people talk to friends, parents, lovers, employers, clergy, and police officers.

In general, verbal behavior allows speakers to ask for things (e.g., "Please get me a glass of water") and to describe the environment for others (e.g., "The tap in the kitchen isn't working"). Asking for things benefits the speaker, who often gets them, and may benefit the listener, insofar as they provide an indication of how the speaker is likely to behave. A speaker's description of relations observed in the environment, however, is apt to be especially useful for listeners. These descriptions may involve only stimuli ("When the stove is red, it's very hot"), antecedent stimuli and responses ("When the phone rings, answer it"), or antecedent stimuli, responses, and consequences ("When you hear a Beatles' song, be the first person to call in, and win \$5,000"). Skinner called descriptions of relations among stimuli and responses rules.

Rules specify relations among stimuli and responses and usually change the behavioral function of those stimuli. For instance, after hearing a disc jockey say, "When you hear a Beatles' song, be the first person to call in, and win \$5,000," a person who hears a Beatles' tune may well call the radio station. Absent the announcement, however, calling the station is highly unlikely. In this example, the announcement gives the Beatles song a capacity to control behavior similar to that of an S^D . The song is not an S^D , however, because the person has no previous history of calling in and winning. What she or he has, instead, is a history wherein following rules is generally productive. Whether or not a par-

ticular rule is followed by a given individual depends in large part on her or his prior experience with respect to the rule giver (and similar people) and the accuracy of similar rules provided in the past. We learn through operant conditioning to follow rules or to refrain from following them. For instance, a parent says to a child, "Don't touch the stove; it's hot and you'll get burned." Despite the rule, the child touches the stove and gets burned. As a result of the correspondence between real and described consequences, the future likelihood of rule following increases. If, however, the child touches the stove but is not burned, the future likelihood of rule following decreases.

The most important characteristic of rules is that listeners can learn from them. For example, a person can acquire new behavior, with very little effort, through rules such as "To get to the barbeque at my house, turn left on Main, turn left at the second light, and it's the fourth house on the right, 3117 Market Street." Without the rule, the listener would have to learn appropriate behavior through direct exposure to the environment. Imagine how difficult it would be to find 3117 Market Street in a large city with no map or directions. A rule makes doing so much easier. In fact, rules mimic the effects of classical and operant conditioning by allowing people to be affected by environmental relations that they have never directly experienced. Rule-governed behavior is of crucial importance to humans because it (a) provides for very rapid behavior change and (b) enables people to behave effectively without requiring direct exposure to environmental events that might prove harmful or ineffectual. Rules also can increase the effectiveness of delayed consequences. These are important, and often beneficial, effects.

Rules can interact with the consequences of behavior in three major ways. First, as noted earlier, rules can alter the behavioral function of consequences. A person who is exercising to improve health in the presence of a personal trainer may be told, "No gain without pain, make it hurt" while doing bench presses. This rule might alter the function of mild pain in the pectorals from punishing to positively reinforcing. In many cases, people who behave in the face of what appear to be unpleasant consequences are following rules that modify the behavioral function of those consequences.

Second, rules can alter the range of behaviors that are available to contact naturally occurring consequences. A depressed person who is repeatedly told to "Call your sister; she'll be glad to hear from you" probably is more likely to make the call, during which any of a variety of desirable verbal responses might be reinforced.

Third, rules can alter a person's sensitivity to consequences that are contacted. In general, if a rule accurately specifies the consequences of a particular kind of behavior, then sensitivity to those consequences increases. If, however, the rule is inaccurate with respect to actual consequences, then sensitivity to those consequences decreases. Rules can foster a kind of behavioral rigidity, wherein a person responds in a manner consistent with the rule, almost regardless of the consequences of so doing. Because of this, it is crucial that accurate descriptions of operant interventions be provided before those interventions are put in place. A token economy, for example, is apt to produce faster and greater improvements if the schedules it comprises are clearly stated to participants than if they are not.

Rules can be covert as well as overt; "talking to one's self" is behavior that is not fundamentally different from talking aloud. Rules also can be self-generated as well as provided by others. In either case, they sometimes provide inaccurate descriptions of relations among events in a person's environment. For instance, a person with anorexia may say, "When I weigh over 100 pounds, people think I'm fat and ugly." In fact, this is untrue. People think (i.e., say) that the client is seriously underweight at 100 pounds and that 130 would be a far better, and more attractive, weight. Were the higher weight to be attained, the actual consequences are very different from those described by the client. By following an erroneous rule, however, the client will never encounter those consequences. Moreover, even if they are encountered, other "bad" rules might change their function. If, for instance, the client got up to 125 pounds and several friends offered compliments, the client might well say "Everyone humors a fat person," or "That's what they say to my face; behind my back they're laughing." Either rule would prevent the compliments from functioning as a reward.

Most humans are verbal organisms, and most outpatient therapies are based heavily on verbal interactions between patients and therapists. In many cases, the aim of those interactions is to alter the client's rule-governed behavior, although they are not always conceptualized in this manner. In recent years, Steven Hayes and his colleagues have developed a comprehensive analysis of the role of verbal behavior, and of rules specifically, in human psychopathology. For example, Hayes and Ju offer the following explanation of suicide:

The purposeful act of taking one's own life is an instance of rule-governed behavior based on derived relations involving time and the verbal construction of

expected consequences of action ... For example, "death" can participate in if ... then verbal relations with many other events that have acquired desirable functions both directly and through the transformation of stimulus functions tied to direct events, such as, "If I am dead, I will no longer suffer, everyone will be happier, they will all be sorry for what they've done to me, I will finally be at peace," and so on ... [Death therefore] becomes a verbal consequence of importance ... Once death becomes a verbal consequence of importance, rules can be followed that give rise to it ... However, the impact of such rules as "If I die, then I will be at peace" depends upon the degree to which they conflict with other functional rules, such as "Suicide is an offense against God." It is for this reason that the psychotherapies and religious institutions around the world strive to create meaning, values, and purpose in the lives of individuals.

Hayes and his colleagues have developed a therapeutic technique, "acceptance and commitment therapy" (ACT), that is intended to overcome unhealthy forms of verbal control and to foster healthy forms. Although relatively new, ACT appears to hold promise for treating a variety of serious behavioral problems in clients for whom direct control of the environment is impossible.

Although altering the rules that an individual generates and follows can be a valuable therapeutic technique, it is important to realize that these activities are themselves influenced by their consequences. If there is nothing in a client's everyday social or nonsocial environment to support (i.e., reinforce) appropriate rule-governed behavior, then such behavior usually will not endure over long periods. In some cases, naturally occurring consequences in the client's everyday environment are sufficient to support appropriate behaviors that emerge. In other cases, however, contrived consequences may be needed. A significant problem in providing treatment for outpatients is arranging such consequences.

III. APPLICATIONS AND EXTENSIONS

The behavior of essentially all people is sensitive to operant conditioning, and procedures based on operant conditioning have proven useful in dealing with an enormous range of problems in clients with a wide variety of diagnostic labels. Many of the early therapeutic applications of conditioning principles involved children or people with developmental disabilities, and a few skeptics have argued that consequences do not

affect the behavior of verbal adults. This contention is patently untrue. What is true, however, is that it often is difficult or impossible to arrange effective consequences for the behavior of adult humans unless they are in tightly controlled settings (e.g., inpatient treatment wards), which rarely occurs. Procedures based on operant conditioning obviously can be effective only when they can be consistently implemented, and they cannot be effectively implemented for some clients in some settings. When this occurs, therapists must attempt to alter rule-governed behavior and hope that naturally occurring consequences are sufficient to maintain any appropriate behaviors that are generated.

Moreover, in verbal individuals rules can diminish sensitivity to consequences. This may make it appear that these individuals are not affected by the consequence of their actions but, in fact, they are—the primary reason that they follow rules today is that behaving in similar fashion paid off in the past. Rule-governed behavior, which is indirectly controlled by consequences, is just as important as is behavior directly controlled by its consequences. Effective therapists work to change the two in parallel.

With certain clients, procedures based on operant conditioning may be more effective as adjuncts than as primary treatments. For example, antipsychotic drugs typically are first-choice treatments for schizophrenia and related conditions, even though operant interventions are useful in dealing with specific behavior problems in individuals with these conditions. Combined pharmacological and conditioning treatments also are useful in treating behavior problems in people with conditions other than schizophrenia, including depression and attention-deficit/hyperactivity disorder (ADHD).

Client diversity is not a consideration with respect to procedures based on operant conditioning in general, although appropriate sensitivity to this issue is required to evaluate the acceptability and probable effectiveness of specific interventions. Some clients object to interventions based on the manipulation of consequences as unnatural, controlling, or contrived, and such objections must be overcome if treatment is to have any hope of success.

IV. EMPIRICAL STUDIES

A great deal has been written about operant conditioning and clinical interventions based on it, and many research articles have been published. For example, a recent search of the psychological literature

(using the PsycINFO database) with the keywords “operant conditioning” yielded 7,844 publications. It is very difficult to summarize this vast literature, save to point out that procedures based on operant conditioning are useful in treating a wide range of behavioral problems in many different kinds of clients in a variety of settings. As noted previously, results of a 1995 evaluation of the entire treatment outcome literature in clinical psychology indicated that the vast majority of successful interventions rely heavily on the principles of operant conditioning.

Such interventions have been used to good avail in dealing with behavioral problems in children and adults without diagnostic labels, in people with developmental disabilities, and in individuals with various mental disorders (e.g., ADHD, schizophrenia, depression, anxiety disorders, eating disorders). People with brain injuries and other medical problems (e.g. obesity, hypertension) also have responded favorably to operant interventions. Of course, not all clients respond favorably to a given intervention, and no client is helped by an ill-conceived treatment, regardless of its alleged theoretical basis. Over the years, poorly trained and misguided caregivers have placed children in closets for long periods as a kind of “timeout.” Others, equally misguided, have deprived people with mental retardation of clothes and food, which they had to work to earn back, as a kind of “reinforcement.” Such treatments cannot be justified and would not be recommended by any legitimate clinician.

V. CASE ILLUSTRATION

Jack is a 15-year-old male diagnosed with ADHD. He currently participates in outpatient therapy with his parents to address a variety of their concerns regarding his behavior. The presenting concerns include inappropriate behaviors at home (e.g., noncompliance, disrespectful language, breaking curfew) and at school (e.g., noncompliance, fighting, failure to complete homework). Most of these inappropriate behaviors have developed and worsened in the 2 years since Jack started high school.

The behavior therapist has decided to use a token economy to both increase appropriate behaviors (e.g., homework completion, compliance) and decrease inappropriate behaviors (e.g. fighting, breaking curfew). The token economy includes the following components: (a) tokens, (b) backup reinforcers, and (c) schedules for token delivery and removal and an exchange

rate. In addition, the token economy provides consequences for clear, observable behaviors and provides unambiguous criteria for delivering those consequences. The token economy was developed through collaboration among the parents, therapist, and Jack. Jack's parents had final approval on the details of the treatment program.

The tokens used for Jack are points recorded in a check register by his parents. Only his parents can deliver or remove points, and they keep track of all delivery and exchange. Jack can earn a preset number of points each time he completes certain behaviors and he can lose a preset number each time he engages in other behaviors (see table 1). Points are exchanged on Saturday morning for a variety of activities and privileges (i.e. backup reinforcers) for Saturday and the next week. The list of these backup reinforcers was generated by having Jack provide a list of items and activities for which he would like to work, which ensured a variety of potentially effective reinforcers. His parents then either eliminated items (e.g. a new stereo) or approved items (e.g., watching movies) from Jack's list and established a point exchange rate for the Saturday exchange (see table 1). Each week in session the therapist reviewed the targeted behaviors and assessed Jack's progress and helped the family make changes in the token economy when necessary. Jack's progress was tracked by counting the number of points earned each week and counting the number of appropriate and inappropriate behaviors occurring each week.

The baseline condition indicates that Jack had high rates of problem behavior before the implementation of the token economy. The first week of the operant treatment resulted in a decrease in problem behavior and an increase in appropriate behaviors. Jack earned several points and was able to trade them in on the first Saturday for a delayed curfew (60 min.) on Saturday night and the opportunity and funds to see a movie. His progress continued in the next 3 weeks of treatment with even greater decreases in problem behaviors. The family continued to use a version of this token economy successfully and eventually Jack's behaviors remained at a satisfactory level as the treatment system was stopped.

Several principles of operant conditioning are evident in this case example. First, there is a schedule of reinforcement included in the token economy. Occurrences of an appropriate target behavior resulted in a positive reinforcer in the form of points delivered under a specified schedule. These points are conditioned reinforcers because they have no inherent reinforcing value but acquire such value because they can be exchanged for the backup reinforcers (i.e., items from the menu). A

TABLE 1
Token Economy Targets, Point Schedule,
and Reinforcer Menu

<i>Target behaviors</i>	
A. <i>Complete homework assignment</i> : An assignment is defined as all task materials due the next day in one particular class (e.g., algebra, biology). The assignment must be completed by 9:30 p.m.	
B. <i>Meeting curfew</i> : Jack must be inside the house by 9 p.m. with no arguing, complaining, or prompting from his parents.	
C. <i>Following instructions</i> : If Jack is instructed to do something (e.g., set the table, clean up your room, put away your shoes, lower the stereo), he will complete the task (e.g., turn down the stereo) or initiate completion of the task (e.g., cleaning room) within 5 min.	
D. <i>Fighting</i> : Fighting is any activity that is called fighting by school personnel.	
E. <i>Using respectful and disrespectful language</i> : Respectful language includes "please," "thank you," "yes/no maam/sir," and other phrases in an appropriate tone and volume of voice. Disrespectful language includes name calling and agreed-on statements (e.g., "shut-up," "leave me alone," "no way.")	
<i>Point schedule</i>	
<i>Appropriate behavior</i>	<i>Points earned</i>
Completion of each homework assignment	1
In house by 9 p.m. (curfew)	3
Following instructions within 5 min.	1
Respectful language	1
<i>Inappropriate behavior</i>	<i>Points lost</i>
Fighting	15
Disrespectful language	5
<i>Back-up reinforcer menu</i>	
<i>Item/activity</i>	<i>Point cost</i>
Extended curfew (1 hour/1 day)	40
Movie (paid by parents)	25
Driving range with Dad on Sunday	25
\$5 and trip to video arcade	25
Rent 2 movies	15
(This menu will be edited every 2 weeks)	

variety of reinforcers, selected by Jack, is available to ensure high quality reinforcers and to prevent satiation (i.e. maintain motivation). The number of points gained or lost for performing a behavior depends on the importance of that behavior. Because each occurrence of an inappropriate target behavior resulted in the immediate

removal of points, a schedule of negative punishment is in effect. Finally, the relations between behavior and its consequences are explained carefully to Jack in the interest of generating appropriate rule-governed behavior and maximizing the sensitivity of his behavior to its consequences.

VI. SUMMARY

“Operant conditioning” does not refer to a single therapeutic technique. Instead, the term refers to an important form of learning, or conditioning, in which behavior is primarily controlled by its consequences. The consequences of a particular kind of behavior in one setting can either increase or decrease the probability of such behavior occurring in similar settings in the future. Descriptions of the consequences of behavior, called *rules*, can have similar effects. A great deal is known concerning how consequences affect behavior, and this knowledge has been put to good use in designing interventions shown to be effective across a wide range of client populations, behavior problems, and settings.

See Also the Following Articles

Classical Conditioning ■ Conditioned Reinforcement ■ Differential Reinforcement ■ Extinction ■ Fading ■ Functional Analysis of Behavior ■ Negative Punishment ■ Negative Reinforcement ■ Positive Punishment ■ Positive Reinforcement ■ Token Economy

Further Reading

- Catania, A. C. (1998). *Learning* (4th ed.). Upper Saddle River, NJ: Prentice Hall.
- Clayton, M. C., & Hayes, L. J. (1999). Conceptual differences in the analysis of stimulus equivalence. *Psychological Record*, 49, 145–161.
- Cooper, J. O., Heron, T. E., & Heward, W. L. (1987). *Applied behavior analysis*. Columbus, OH: Merrill.
- Hayes, S. C., & Ju, W. (1998). Rule-governed behavior. In W. T. O'Donohue (Ed.), *Learning and behavior therapy* (pp. 374–391). Boston: Allyn and Bacon.
- Kazdin, A. E. (1982). The token economy: A decade later. *Journal of Applied Behavior Analysis*, 15, 431–445.
- Michael, J. (1993). *Concepts and principles of behavior analysis*. Kalamazoo, MI: Association for Behavior Analysis.
- Miltenberger, R. (1997). *Behavior modification: Principles and procedures*. Pacific Grove, CA: Brookes/Cole.
- Sakai, K., & Miyashita, A. (1991). Neural organization for the long-term memory of paired associates. *Nature*, 354, 152–155.
- Skinner, B. F. (1953). *Science and human behavior*. New York: Macmillan.
- Skinner, B. F. (1957). *Verbal behavior*. New York: Appleton-Century-Crofts.
- Skinner, B. F. (1984). Selection by consequences. *The Behavioral and Brain Sciences*, 7, 477–510.
- Task Force on Promotion and Dissemination of Psychological Procedures. (1995). Training in and dissemination of empirically-validated psychological treatments: Report and recommendations. *The Clinical Psychologist*, 48, 3–23.
- Tryon, W. W. (1995). Synthesizing animal and human research via neural network learning theory. *Journal of Behavior Therapy and Experimental Psychiatry*, 26, 303–312.

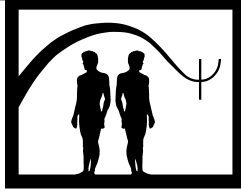

Organic Brain Syndrome: Psychotherapeutic and Rehabilitative Approaches

Avraham Schweiger

Academic College of Tel Aviv, Israel

Jason W. Brown

New York University Medical Center

- I. Overview of Organic Brain Syndromes
- II. Description of Traumatic Brain Injury
- III. Diagnostic Issues
- IV. Theoretical Basis of Treatment
- V. Cognitive Therapy and Psychotherapy in Organic Brain Syndromes
- VI. Review of Treatment Efficacy
- VII. Summary
Further Reading

quences of traumatic injuries to the brain (such as an injury sustained in a motor vehicle accident, or as a result of a gunshot wound). TBI is contrasted with other forms of brain pathologies, such as tumors, strokes, infections, and degenerative conditions, that do not result from a sudden, violent event, although the latter's consequences can be no less traumatic to the individual.

GLOSSARY

cognitive therapy/remediation Refers to several forms of rehabilitation/treatment addressing the cognitive and behavioral consequences of brain damage. This treatment involves procedures that address impaired functions by using a variety of computer programs, as well as other exercises. In addition, cognitive therapy involves the teaching of a variety of compensatory strategies to increase functioning despite residual impairments. Cognitive therapy may include supervised practice of real-life situations outside the office. Cognitive therapy refers to treatment of individuals with brain damage and is distinguished from the psychotherapeutic technique by the same name.

organic brain syndromes (OBS) Refer to dysfunctions in the intellectual/cognitive, behavioral, social or emotional spheres, whose primary effective cause is brain pathology. These syndromes are defined in contrast to dysfunctions in the same spheres, whose etiology is believed to be primarily emotional or psychological.

traumatic brain injury (TBI) A category of OBS, used to describe the cognitive, emotional, and behavioral conse-

I. OVERVIEW OF ORGANIC BRAIN SYNDROMES

The term organic brain syndrome (OBS) refers in the literature to both organic mental disorder and organic brain disorder. This reflects the dualist mind-body distinction, which gave rise to it. That is, it implies a distinction between "physical" and "mental" causes of behavioral-emotional-cognitive dysfunction. The latter are also known by the general term psychopathology, but can there be an organic mental disorder, or even normal behavioral/cognitive functioning that is not related to brain function (try functioning without it)? And can there be a brain disorder that is not "organic," in the sense that it refers to something other than normal or impaired function of brain tissue? Current knowledge suggests a negative answer to both questions. There is a long tradition of dualism in psychiatry of "functional" and "organic" disorders (expressed in the diagnosis of OBS) that reflects the belief that some behavioral abnormalities originate in brain pathology, whereas others result from "psychological" or "functional" factors, such as

maladjustment in the domains of emotional, social, and familial function.

Today it is recognized that a variety of medical conditions can cause the full range of psychiatric syndromes and symptoms. Therefore, many diagnostic categories of psychiatric symptoms resulting from specific medical conditions are recognized and are typically classified together with other clinical entities with similar clinical manifestations. When applied judiciously, OBS has important diagnostic, prognostic, and therapeutic implications: it implies that the appropriate strategy for dealing with the symptoms is to attend to the underlying brain pathology, whereas the behavioral-affective manifestations may be of secondary concern. To the extent that OBS is secondary to some underlying brain pathology, and to the extent that this pathology is treatable, the treatment of choice is medical intervention. However, for various forms of OBS (for example, degenerative disease), medical intervention may be limited to the pharmacological management of symptoms related to behavioral problems. For other subcategories of OBS, such as mild to moderate TBI or strokes, medicine offers little beyond symptomatic relief, and it is left for other professions to provide rehabilitation of impaired functions. It is therefore important that practicing clinicians consider the various forms of OBS in their differential diagnoses, because brain pathology can give a spectrum of psychiatric symptomatology, and because many of these disorders may be reversible with medical intervention. For similar reasons, the presence of documented brain pathology, in the context of psychiatric symptoms, may preclude common psychotherapeutic approaches. Thus, for example, insight-oriented psychotherapy for a patient whose insight is impaired by frontal lobe damage is quite ineffective.

As brain tissue does not regenerate to an appreciable extent, damage resulting in OBS, is in a sense "irreversible." Thus, many forms of OBS result in permanent dysfunction. In cases of degenerative conditions, the dysfunction gets worse. But in many other forms, such as in cases of TBI, various infections, and strokes, when occurring in the context of otherwise healthy individuals, where some form of new learning can still take place (which may be well into the 7th or 8th decades of life), functional improvement can take place. In such cases, motivation to exert the effort required, therapeutic intervention and environmental support are the main ingredients in turning the consequences of OBS around, and returning the individual back to his or her premorbid level of functioning, as

quickly as possible. In this article, the focus is on the consequences and treatment of TBI, but it should be emphasized that these are appropriate for all other forms of OBS where there is a potential for recovery.

II. DESCRIPTION OF TRAUMATIC BRAIN INJURY

Traumatic brain injuries (TBI) do not form a well-defined category of symptoms, as injuries vary in their severity and location within the brain. This category of syndromes is the leading cause of OBS among young people and is the form of OBS most likely to come to the attention of psychotherapists. TBI include a large variety of syndromes, with varying degrees of disabling symptoms and pathologies. There is a considerable body of research on the topic, and space allows for only introductory discussion. TBI can result in a wide range of psychiatric and cognitive symptoms. No two traumatic injuries are alike, and the clinical picture following brain injury, as well as long-term adjustment, are always a combination of premorbid personality, psychological adjustment, intelligence, and the extent and location of the injury, together with the availability and quality of treatment and the patient's social support system. Thus, any prior history of drug or alcohol abuse, in itself a risk factor for TBI, may complicate both diagnosis and return to "normal" functioning. In part due to the age of the population with head injuries, there is typically significant recovery, albeit rarely back to the premorbid level of functioning.

Brain traumata are usually classified into cases of severe, moderate, or mild injuries, according to scores on the Glasgow Coma scale (GCS, a 15-point assessment tool, using measures of verbal, motor, and eye-opening responses), and on the length of time the individual has been unconscious. Roughly speaking, loss of consciousness for less than 20 min and a GCS of 13 to 15 are considered to reflect a "mild" injury. Any history of coma beyond 6 hr with a GCS of 3 to 8 is considered to indicate "severe" injury. However, there are substantial variations in the severity of symptoms and outcomes that do not respect the classification described earlier. Most often the injured person has amnesia for the injury, and depending on the severity of impact to the brain, there is often retrograde amnesia as well (amnesia extending from the onset of injury backward in time). The length of retrograde amnesia varies among injuries but does not correlate well with severity. There is often posttraumatic amnesia as well, referring to the

period following onset of injury, during which the patient is alert but for which the patient later exhibits amnesia. Posttraumatic amnesia provides a measure of the severity of the impact to the brain and gives some indication of the prognosis (although variations are common). In addition, short-term memory deficits and impairment in new learning following brain injury are ubiquitous and are referred to as anterograde amnesia.

Traumatic brain injuries can result from a penetrating foreign body (as from a gunshot wound). They can result from acceleration–deceleration of the head, as in cases of motor vehicle accidents, falls, or from a blunt blow to the head, in which case they are referred to as closed head injuries. The mechanism of injury to brain tissue is different in each type, and from one situation to another. In some cases intracerebral bleeding occurs, and in some cases focal tissue damage can be seen on brain imaging. But almost always there is diffuse injury as well, involving disruption of cell membranes, especially in the brainstem and shearing of neuronal processes (axons). In addition to actual tissue damage, TBI may result in other pathological processes that may affect cognition, such as tissue swelling (edema). TBI can result in clinical pictures ranging from persistent vegetative state to a seeming absence of residual neurological symptoms. When the injury is severe, the individual usually does not return to premorbid functioning and may need lifelong assistance in all aspects of living, even after a long course of rehabilitation. In moderate and mild cases, a fast return to functioning is often possible, although residual deficits may, and often do, remain for the rest of the person's life, as damaged brain tissue does not regenerate.

Occasionally, the brain injury impairs the patient's insight (expressed as the inability to monitor and judge one's own behavior and/or thought process), so that the patient is not aware of the deficits and may even deny them altogether. This impairment makes intervention and rehabilitation much more difficult, as the patient sees no reason for the rehabilitation efforts, and cooperation may be limited. Nevertheless, intervention with the aim of improving overall functioning may still be necessary. Needless to say, when insight is impaired by TBI, or any other brain damage, any attempt to treat the disorder with insight-oriented therapy is doomed to failure (see later for more details on treatment).

Mild TBI can present a challenge to the clinician, because such injuries are often dismissed as representing either exaggeration of symptoms for secondary gains (especially when litigation is involved), or outright malingering. Such cases often received psychiatric di-

agnoses in the past, because the typical symptoms were headaches, concentration problems, memory loss, depression, mood lability, and even personality changes, among others. Nevertheless, research over the past 30 years indicates that between 5 to 10% of mild TBI, despite only brief loss of consciousness, or merely short alteration in consciousness, and without any symptoms of major impairment in thought processes, intellectual ability, or language skills, do not return to normal functioning. This symptomatology has been supported by techniques of functional imaging of the brain, such as positron emission tomography, and by research in patients who are not involved in litigation, where financial incentive may seem the basis for the complaints. Such disability was found to be due to residual symptoms of poor short-term memory, reduced attention/concentration (especially on tasks of divided attention), impaired organization, and reduced speed of cognitive processing, together interfering with cognitive performance. This clinical presentation is known as the postconcussion syndrome (PCS). This subtype of TBI can be seen in the absence of litigation, and there is evidence that microscopic changes do take place in the brains of these individuals, such as axonal shearing. The microscopic changes, however, are too subtle to be visualized by any imaging technique, and most often a general neurological evaluation produces no focal findings.

Deficits associated with the PCS can only be documented on comprehensive neuropsychological testing. In addition to the cognitive deficits mentioned earlier, patients with the PCS often suffer from headaches for many months, sleep disturbances, fatigue, and depression. Occasionally, a change in personality is noted, and symptoms of anxiety, irritability, dizziness, and apathy are present. Individuals who had been high functioning prior to the injury are particularly disturbed by PCS, even when their test performance is still in the normal range for the general population. That is due to their intact insight, so they are acutely aware of their deficits. Patients with the PCS frequently have the added burden of “convincing” their families that something is wrong with them; it is not obvious, given the relative minor nature of their injury, that they indeed sustained a lasting injury to their brain (see later for further discussion of treatment and diagnosis of PCS).

Recovery from any TBI is most rapid in the first 6 months following the injury, with continuing noticeable recovery up to about 1 year. Over the first year, the rate of recovery decreases gradually. Beyond 1 year, additional recovery may still take place, albeit at a frus-

tratingly slow pace. Depending on the age at the time of the TBI, patients have shown recovery for several years postinjury, especially with regard to increased independent functioning. However, the latter depends to a significant extent on the social support system of the patient, availability of rehabilitation, and motivation.

One of the most significant, and almost universal, consequences of TBI and any other form of brain damage is affective disturbance. Most commonly, depression is seen, but other mood disorders can result as well. Thus mood swings, anxiety, phobias, hypomania and even posttraumatic stress disorder have been reported following TBI. Sometimes mood disorders reflect the effects of brain damage directly; in other cases, affective symptoms (mostly depression) are secondary and reactive to the cognitive deficits. A combination of both etiologies together is also possible. Mood disorders themselves in TBI can impair normal functioning, and therefore they require professional attention.

III. DIAGNOSTIC ISSUES

In cases of severe TBI, there is little question as to the presence of underlying brain damage. However, in cases of mild to moderate head injuries, especially where brain imaging reveals no positive findings of damage, and the neurological evaluation also produces no pathological findings, the diagnosis of TBI requires a different approach. Such diagnosis is crucial when litigation is involved, as motivation becomes part of the clinical question of diagnosing brain damage. It is also essential when the injury is mild, but the individual complains of persisting problems in function.

The most effective approach to identify the presence of cognitive deficits and determine their extent, to date, is the neuropsychological evaluation. The neuropsychological assessment, through the use of standardized tests, provides the most accurate, noninvasive, picture of the functional status of the individual, which in turn allows the inference of brain dysfunction, if present. Neuropsychological testing utilizes a comparison between the estimated premorbid, intact intellectual function of the individual, against his or her present performance on cognitive testing. This comparison is done under the assumption that the overall cognitive performance on different cognitive tasks of a given individual is fairly uniform within a certain range of variations. Therefore, an observed large deviation from the expected performance in a given skill, relative to the estimated intellectual functioning of the individual,

raises the suspicion of impairment. If such a deviation is consistent with similar findings in other cognitive skills, the latter known from research to be readily affected even by mild brain damage, a diagnosis of TBI (or PCS) is made. Because TBI involves, by definition, pathology of brain tissue, it is likely that even if the presenting symptoms of TBI seem to be psychiatric (say, depression, mood swings, or poor concentration), some cognitive deficits will be present as well. These are most likely to be short-term memory and attentional deficits. In fact, despite the prevailing notion that depression results in cognitive deficits on testing, recent research on this topic has found little, if any, correlation between scores on neuropsychological tests and depression. Problems with daily and occupational functions, however, can be and often are seen with depression. As neuropsychological assessment identifies the presence or absence of brain pathology, positive findings on neuropsychological testing greatly increase the likelihood that the underlying cause of the patient's complaints is brain pathology. Neuropsychological testing is appropriate in mild to moderate cases of TBI, and where brain damage is known to be present (e.g., in cases of severe TBI with damage seen on brain imaging). The neuropsychological assessment should also be used to determine the extent of dysfunction and to aid in developing an optimal treatment plan.

IV. THEORETICAL BASIS OF TREATMENT

The World Health Organization formulated a part model to conceptualize deficits following TBI: impairment, disability, and handicap. Impairment refers to deficits in the actual underlying cognitive skills (such as memory, attention, fluency, inhibition of action). Impairments are detailed on the neuropsychological evaluation. Disability refers to deficits noted in the injured individual's function in everyday life (for example, memory impairments may cause problems in carrying out the task of shopping for food, keeping appointments, etc.). Handicap refers to difficulties imposed on the injured person by the demands of the outside world (e.g., a return to work may be impossible due to disability in dealing with more than one thing at a time). Within this framework, improvement in disabilities may not necessarily result from improvement in impairments: using a list for shopping can lead to improvement in performance of this task without any change in the underlying memory impairment. Nor is

an improvement in a disability by itself a guarantee for progress of a handicap: the use of a list may not suffice to overcome the memory demand required by taking an oral examination at school. The goals of treatment in TBI are improvements in both disabilities and handicaps, although often impairments are targeted as well, especially within the initial phase of treatment.

Any therapeutic approach must be based on the presumption of a potential for recovery. Indeed, it is a common observation that people after TBI recover to some extent or other, often even spontaneously, in the absence of intervention. What does this recovery represent in terms of brain functions? TBI results in several pathophysiological (i.e., abnormal) processes in brain tissue that have been identified experimentally. Some of them (e.g., swelling, or edema) in and of themselves may cause disruption in normal functions beyond the effect of the brain damage itself. Thus, when swelling resolves, for example, it is accompanied by some recovery of TBI symptoms. As brain tissue does not regenerate, further functional recovery involves, most likely, (1) some measure of reorganization in tissue functions (perhaps the assumption of function by a healthy tissue heretofore not specialized for the impaired function), combined with (2) the residual function of damaged neuronal networks. But beyond the recovery of basic perceptual, conceptual, memory, attention, and motor skills, functional recovery observed can, and often does, reflect (3) the development of compensatory strategies. Various combinations of these three processes most likely form the basis for observed improvement following injury.

What we know from functional brain imaging about the neuroanatomical substrate of recovery is that reorganization takes place shortly after an injury to brain tissue. New neuronal networks seem to take over functions that premorbidly were subserved by the now-damaged tissue. But in addition, new learning can take place in neurologically intact individuals even into the seventh decade of life, albeit at a reduced rate and extent. Thus, there are good reasons to believe that as long as healthy, viable tissue remains after trauma, the individual may still be able to learn new tasks, or be capable of doing old tasks in new ways (i.e., compensation for deficits). Such new learning involves, quite likely, formation of new synapses (contacts among nerve cells), changes in membrane properties and firing characteristics of nerve cells, as is the case with learning in general. It is true, however, that even mild TBI is likely to reduce the overall capacity of the nervous system, so that any new learning requires more time and effort, depending on the extent of injury.

The general principles forming the basis for recovery outlined earlier cannot provide detailed guidelines for addressing a specific impairment or disability in a specific way. As individuals present with different injuries, different premorbid abilities, occupational background and adjustment, as well as varying psychosocial and familial contexts, treatment must be tailored to the individual needs of the patient. Individualizing treatment implies that long-term goals and specific treatment plans are synthesized from all the factors known to affect the outcome of treatment. Treatment approaches may include, in addition to individual therapy, group treatment when appropriate. Group therapy, whether as a form of cognitive treatment or psychotherapy, can have an important role in promoting recovery. Indeed, several rehabilitation programs around the world are based on group treatment approach (see later for details). Another implication of the knowledge we have on reorganization in the brain is that initiation of therapy should be as soon as the injured individual can participate in treatment. When treatment is initiated early, reorganization can incorporate easier new approaches to old tasks, and patients better adapt to new learning. During the first year following a TBI, the majority of recovery takes place. Beyond that, progress is far slower. Individuals with TBI who begin treatment a year following onset or later, may actually have to unlearn ineffective compensatory strategies they have acquired on their own during the initial phase following injury. This is an unnecessary burden.

V. COGNITIVE THERAPY AND PSYCHOTHERAPY IN ORGANIC BRAIN SYNDROMES

A. Cognitive Treatment

Cognitive treatment (CT) must address the complete range of skills involved in normal functioning, in the context of psychosocial, cognitive, occupational, and emotional readjustment. In reality, cognitive, occupational, physical, group, and psycho -therapies are intertwined in the process of assisting an injured individual to negotiate a return to normal functioning. Improvement in functioning can be observed even when test performance of basic skills does not change. This happens when treatment aims to improve the actual functioning in the context of real-life occupational and psychosocial settings.

In general, CT is said to be “restorative” when it addresses cognitive impairments directly by, say, rote

repetitions of tasks involving impaired skills. Therapy is regarded as “compensatory” when new skills are taught to patients, such as procedures designed to reduce disabilities despite persistent cognitive impairments. Cognitive treatment follows the general knowledge acquired through more than half a century of research on principles of cognitive learning. Examples include strategies in improving memory functions (e.g., through the use of mnemonics), attention and visual scanning training, the utility of distributed versus concentrated practice, and so on. These principles are used but extended beyond the clinic in CT, through generalization into real life situations.

Any systematic activity that requires the purposeful use of the brain can be utilized as CT, as long as it is part of an effort to reduce impairment, disability, or handicap. Thus, anticipating and responding to a target on a computer screen, making a supervised trip from the home to the clinic using public transportation, interacting socially in a group moderated by a therapist, are all forms of cognitive treatment. Cognitive treatment might take the form of sensory stimulation for a partially comatose patient and ends with assisting an injured lawyer with strategies for reading and preparing legal briefs. A great deal of material exists commercially which can be used for CT: computer software, videos, tapes, workbooks, reading material, games, puzzles, and so on. Elaborate guidebooks and materials for addressing specific areas of problems can be purchased commercially (such as, for example, the Attention Process Training designed by McKay Moore Sohlberg & Catherine Mateer, 1989, and many other computer-based programs). But the resources are limitless, as many other, even daily encountered objects and situations can serve the same purpose of increasing functioning. Thus the home environment may be modified to provide an injured person with the structure necessary to stimulate recovery and reduce disability. Material from the patient’s premorbid occupation may serve as context for developing specific compensatory strategies for skills needed for work; so can environmental objects serve the same therapeutic purpose for better functioning in daily life. For example, the pictures at a museum may serve to exercise both attentional and expressive purposes; searching topics on the Internet can provide exercises of attention, reading, visual-spatial and abstract skills, and so on. In short, the range of tools used in cognitive treatment is only limited by the therapist’s imagination. In our center, for example, it is not unusual for patients to go shopping with a therapist, play a musical instrument, practice

the use of public transportation, or attempt work at a local store, all as part of an individualized treatment plan. The only requirement is that any therapeutic activity is aimed at specific functional goals, appropriate for the individual’s needs, and that it is executed with sights on actively challenging the patient.

Cognitive therapy must be performed at a specific level for the individual TBI patient: it cannot be too easy, as boredom will be quick to set in. Equally problematic is CT that aims too high for the patient: frustration and even a catastrophic reaction may ensue. Treatment must be just challenging enough for the individual, within a rather narrow window of difficulty, so that progress will take place without undue negative reactions. This requires constant, careful monitoring of both the mood and performance of the patient. For this reason, treatment plans for a CT session can never be rigidly adhered to. Fluid movement from one level of difficulty to another, or from one task to another may be required when unanticipated reaction from the patient renders the plan obsolete. It must be emphasized that individuals with brain damage may often exhibit not only shorter attention span than intact people, but also lower tolerance for frustration and a more rigid approach to problem solving. These abnormal reactions in themselves may become the focus of treatment.

Although the therapist–client relationship is somewhat different in the context of CT than it is in regular psychotherapy, rapport and trust are important elements of treatment. Eliciting cooperation requires, at times, a great deal of skill on the part of the therapist. For instance, clients may be profoundly depressed and feel hopeless, anxious, embarrassed or they may believe nothing is wrong with them. All these reactions to brain damage, and many more, may result in minimal motivation to cooperate in treatment. Cajoling a TBI patient to participate in therapy may call for the most elaborate inducements and reinforcements. Often it is necessary to recruit the assistance of family or significant others to promote participation. Group treatment can also be effective, provided the discrepancy in patients’ abilities within the group is not too large. Thus, symptoms of impaired social functioning can be addressed in a group setting, where members’ interactions provide both stimulus for and context of therapy. Other cognitive symptoms can be addressed well in a group settings, such as expression and comprehension skills, attentional deficits, sequencing, self-monitoring, and turn taking. Needless to say, psychosocial issues, such as acceptance of deficits, can be addressed well in group therapy (see later for more on this issue).

Survivors of brain damage present with an infinite variety of symptoms, and no two patients are quite alike. Premorbid adjustment and psychosocial factors influencing recovery are never at the control of the therapist. Therefore, understanding the totality of both symptomatology and psychosocial background must form part of the treatment plan. Whether a TBI patient lives alone, with parents or with spouse, will have bearing on the goals of treatment. Therefore it is always important to involve the family, or significant others, in the therapeutic process. At times, CT may take the form of educating the injured person's family regarding the altered cognitive status, the abilities and disabilities of their loved one. A family may hinder or facilitate the individual's recovery process, depending on their attitude toward the cognitive/behavioral changes they face.

B. Psychotherapy

Throughout human development, changes from infancy to childhood, into adulthood, and later maturation into old age are gradual. The process is slow, allowing ample opportunity for making such adjustments so as to preserve some sense of the individual's continuous identity. Thus, a person perceives himself or herself as possessing the same identity across significant changes in size and cognitive abilities. Brain damage, in contrast, is abrupt in TBI, and the demand for readjustment is both substantial and immediate, and always in the direction of reduced capacity (that is, it results typically in negative emotional response). Therefore, brain damage is a devastating event in all spheres of human experience, creating bewilderment and often a sense of loss. It may profoundly shake the person's sense of identity. Even in cases of mild impairments, awareness of reduced cognitive proficiency can injure the individual's sense of self. The experience, common after mild brain damage, of forgetful episodes, difficulties with handling more than one thing at a time, or reduced stamina, will require significant adjustment on the part of the patient. Typically, the more severe the damage, the more adjustment will be required; not only in terms of recovering of premorbid functions, but in the demand for emotional adjustment in the face of irreversible changes.

The most common presentation of psychological reaction to brain damage is problems of acceptance. These problems may appear as lack of awareness of deficits (especially with more severe injuries), over which the patient has no volitional control. In cases where awareness is intact, accepting the changes fol-

lowing brain damage presents a serious challenge, as it entails viewing oneself as less competent than before. High- and overachievers have particular difficulties with this kind of readjustment, which requires psychotherapeutic intervention. Reduced self-esteem and depression are very often the consequence of awareness of cognitive deficits. The role of psychotherapy is, then, to facilitate acceptance and the readjustment process, so that recovery and return to functioning are maximized. Without acceptance, people with brain damage can rarely negotiate the compensation needed for good adjustment. The process of acceptance includes grieving, as in a real sense individuals with brain damage must deal with the loss of part of their identity.

Psychotherapy should include educating patients concerning the effects of brain damage, so as to reassure them that their experience of changes is not unique. For example, mood swings, irritability, fatigue, bursts of uncontrolled anger (all common symptoms following TBI) in heretofore friendly and patient individuals can be very alarming, but understanding of such symptoms in and of itself can have a calming effect. Supportive psychotherapeutic techniques should be combined with more directive approaches to assist patients with the use of new strategies to deal with changes. For example, using a behavioral self-monitoring log to comprehend and control undesired anger outbursts can be taught to individuals exhibiting such symptoms. Families, when available, must be part of the adjustment process, as they, too, need education regarding the changes in their loved ones, support, and guidance in assisting the injured family member. Several approaches have been used with reported positive results, such as the cognitive therapy of Aaron Beck in addressing depression, cognitive-behavioral therapy, and even psychodynamically based intervention. Often psychotropic medications, such as antidepressants, are indicated and should be used as an adjunctive to psychotherapy.

In some cases of impaired insight, behavioral management techniques with the injured individual may be the only effective intervention. In such cases, substantially reduced abstract thinking ability and limited awareness render insight-oriented psychotherapy totally ineffective. As in dealing with individuals with dementia, in such cases it is the caregivers who are usually the focus of intervention, through counseling and teaching them behavioral management techniques to facilitate life at home.

Group therapy is quite effective in affecting what Irvin Yalom called "universality": the feeling that one is

not unique in his or her experience of cognitive deficits. Group therapy is also useful in creating a context for social support from others who understand the changes following brain damage. It provides an opportunity to try new compensatory behaviors in a safe environment, with immediate supportive feedback. Patients who require relearning of social skills will do so better in a group setting.

Unlike traditional psychotherapy, the therapist working with individuals with brain damage must take a more directive role in the therapeutic process, as noted earlier. In addition to educating the client, the therapist may provide alternative approaches to a variety of problem-solving demands on the client, who may now be showing deficits of insight, initiative, and abstract abilities. Thus, not only is the patient devastated emotionally in the face of catastrophic changes, the patient now lacks efficient means of dealing with them. Merely supporting and facilitating grieving of loss, although important in the initial stages of recovery, may not be sufficient in the stages of returning to society at large.

Cognitive deficits do not have to prevent a survivor from returning to work. Thus, memory and attentional deficits can be circumvented using a variety of compensatory strategies. But, as noted earlier, to utilize these strategies, it is crucial for the individual to accept this new condition and recognize the necessity for compensation. For example, in our center we commonly recommend the use of organizers (electronic or not), as a compensatory strategy of dealing with memory deficits. But to make it useful, the individual must use the organizer. Again and again we observe patients who superficially accept the strategy but do not implement it in daily life. Using it presupposes accepting the need for it and, therefore, admitting to reduced cognitive ability.

It is very common to encounter individuals with mild brain damage who think "they are going insane" due to the perceived changes in function. This is especially common following TBI where patients are told they will get better in about 6 to 8 weeks, but no relief is experienced. In such cases, psychiatric referral may result, with the unfortunate implication that the patient has "neurotic" problems, or else, when litigation is involved, is greatly exaggerating the symptoms for financial gains. When the latter is not the case, such implications only serve to exacerbate emotional symptoms and hinder recovery.

Although the consequences of brain damage will be expressed in many forms, both cognitive deficits and emotional problems are often seen. Whereas mood dis-

orders can result directly from impairment to the brain processes involved with affective responses, they can also be secondary to awareness of cognitive deficits. In turn, these psychological symptoms will intensify the symptoms of dysfunction that originally resulted from damage to brain tissue. Thus, it is necessary to treat both the cognitive and psychological symptoms observed in individuals with brain damage as they are inextricably entangled following injury. For this reason, overall improved functioning can be seen in survivors of brain damage when either cognitive or psychological symptoms improve.

VI. REVIEW OF TREATMENT EFFICACY

What is the role of cognitive therapy in promoting the rate of recovery and its final steady state? There are inherent methodological difficulties in assessing outcome of cognitive treatment. To mention a few, it was already noted that no two individuals with brain damage are alike, either in their life history, premorbid adjustment, support system, extent, and location of injury. In addition, defining and measuring outcome is very difficult, in a manner similar to that encountered in research on the effectiveness of psychotherapy. Recovery may be measured on a neuropsychological test battery, or in terms of returning to work and/or function in the family or the community. Each aspect of recovery has its place but may not correlate highly with each other, thus making the study of treatment outcome very complex. Despite the difficulties, the research evidence to date provides general support for the efficacy of cognitive treatment (CT). Thus large, multicenter studies indicate that rehabilitation in general will result in better functional recovery, higher rate of return to gainful employment, and better psychosocial adjustment, even when residual symptoms remain. In contrast, studies on the effect of CT that addresses just the basic cognitive processes, outside the context of functional utilization in the real world, are not as encouraging. The inference is that treatment should focus on disabilities in real life, that is, at work and in the psychosocial environment.

The efficacy of psychotherapy in the population with brain damage has not been well studied on a large scale, but many rehabilitation centers report positive effects of therapy in many, although not in all, individuals with brain injuries. This might be expected, given that patients with brain damage do not choose to receive

psychotherapy, as do clients who turn to psychotherapy on their own. Such patients do not always recognize their own needs as a result of the injury, nor do they always have the cognitive wherewithal to form therapeutic alliance and benefit from the psychotherapeutic process. Often the effects of brain damage require pharmacological intervention before any adjuvant psychotherapy can have any effect. At other times, impaired memory, attention, and concentration do not permit good carryover from one session to the next, requiring a repetition of material dealt with before.

For these reasons, and due to the variability of the population with brain damage in general, no definitive information on efficacy is available. Yet any one who works in treatment with persons with brain injuries can attest to the dramatic positive responses, the improvement in psychosocial functions exhibited by some patients, with less remarkable effectiveness in others. Given the effects of brain damage on psychosocial functions, and the negative effects of the emotional consequences of brain damage on functioning, it would be unethical to await results of large-scale efficacy study of psychotherapy, and not provide intervention as needed.

VII. SUMMARY

Brain damage results in a wide variety of cognitive, affective, psychosocial, and occupational symptoms. Depending on the location and extent of damage, as well as on the developmental history, premorbid adjustment, overall intelligence, motivation, and available support system, the consequences can range from mild impairments with a full return to function, to total disability. Therapy for the symptoms must address the needs of the individual in all possible spheres, as they overlap and interact to produce a clinical picture of disability. Therefore, cognitive treatment, psychotherapy, psychosocial and vocational intervention all must form

part of a comprehensive treatment plan if positive outcome is to be achieved. A return to normal function does not require a complete remission of deficits, something rarely achieved in this clinical population. Instead, it is contingent on acceptance of irreversible changes, emotional adjustment, and the integration of compensatory strategies that allows functioning despite residual impairments. For this purpose, the totality of the injured person's cognitive, social, physical, and emotional spheres (in short—the identity) must be readjusted in the process of treatment, to accommodate the new changes in the most adaptive fashion within the individual's life.

See Also the Following Articles

Collaborative Care ■ Comorbidity ■ Medically Ill Patient: Psychotherapy ■ Vocational Rehabilitation

Further Reading

- Dixon, R. A., & Backman, L. (Eds.). (1995). *Compensating for psychological deficits and declines: Managing losses and promoting gains*. Mahwah, NJ: Lawrence Erlbaum.
- Luria, A. R. (1963). *Recovery of function after brain injury*. New York: Macmillan.
- Prigatano, G. P. (1991). Disordered mind wounded soul: The emerging role of psychotherapy in rehabilitation after brain injury. *Journal of Head Trauma Rehabilitation*, 6(4), 1–10.
- Raskin, S. A., & Mateer, C. A. (Eds.). (2000). *Neuropsychological management of mild traumatic brain injury*. New York: Oxford University Press.
- Uzzell, B. P., & Stonnington, H. H. (Eds.). (1996). *Recovery after traumatic brain injury*. Mahwah, NJ: Lawrence Erlbaum Associates.
- Wilson, B. A. (2000). Compensating for Cognitive Deficits Following Brain Injury. *Neuropsychology Review*, 10(4), 233–243.
- World Health Organization. (1980). *International classification of impairments, disabilities, and handicaps: A manual of classification relating to the consequences of disease*. Geneva.

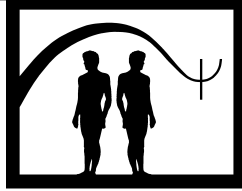

Orgasmic Reconditioning

Nathaniel McConaghy

University of New South Wales

- I. Description of Treatment
 - II. Theoretical Bases
 - III. Empirical Studies
 - IV. Applications and Exclusions
 - V. Summary
- Further Reading

GLOSSARY

expectancy effects Responses that follow a treatment but are not specific results of the treatment but are placebo responses due to the participant's expectancy of improvement. They can be difficult to exclude from specific effects in studies of psychological therapies that use placebo procedures as controls, because the treatment may appear to the participants to be more likely to be effective than the placebo.

multiple-baseline design Employed in single-case studies with the aim of demonstrating that the change following a treatment is a specific effect of the treatment. Frequency or intensity of a number of behaviors is assessed at baseline. Treatment aimed at changing only one of the behaviors is introduced. If that behavior and none of the others change following treatment it is considered that the treatment has specifically produced the change. The procedure can be repeated with a treatment aimed at changing a second behavior and so on. The design will not control for expectancy effects if the treatment appears to the participant to be more likely to affect the behavior targeted than the other behaviors.

I. DESCRIPTION OF TREATMENT

Orgasmic reconditioning, also termed masturbatory reconditioning, was introduced for the treatment of participants seeking modification of their sexual preference. In early studies they were mainly homosexual men but in last two decades they have been mainly male sexual offenders. In their 1991 review, Laws and Marshall described four forms of orgasmic reconditioning that had been reported in the literature. Combinations of the four could be regarded as a fifth form.

A. Thematic Shift

In thematic shift the participant is instructed when he masturbates to use his habitual "inappropriate" or deviant fantasy to produce an erection and to maintain sexual arousal. At the point of ejaculatory inevitability he is instructed to switch his fantasy to one of an "appropriate" nature, thus pairing that fantasy with orgasm. Over time the participant is to introduce the nondeviant fantasy earlier and earlier during masturbation. If following the thematic shift he begins to lose arousal he is to shift back briefly to the deviant fantasy to regain high arousal and then shift again to the nondeviant fantasy. Ultimately he is expected to always masturbate using appropriate fantasies.

B. Fantasy Alternation

It was considered by some workers that as thematic shift was usually carried out by the participant without direct supervision he may not maintain the required temporal relationships between deviant and nondeviant fantasy. They changed the procedure to make it easier for the participant to follow. Rather than shift the thematic content in each session of masturbation, he was instructed to use alternate sessions, in one of which he used deviant fantasies exclusively and in the other, nondeviant fantasies exclusively.

C. Directed Masturbation

With this form of orgasmic reconditioning, the participant was instructed to masturbate exclusively to nondeviant fantasies and to totally avoid masturbating to deviant themes.

D. Satiation

In satiation as described by Marshall and Lippens in 1977 and subsequently termed verbal satiation by some authors, the participant under auditory supervision masturbated continuously beyond ejaculation for a prolonged period, usually about an hour, while fantasizing aloud every variant he could think of on his deviant activities.

Subsequently it was reported the procedure could also be carried out by the participant at home, where he recorded his verbalizations, for the therapist to check he was following the instructions.

E. Combined Directed Masturbation and Satiation

A subsequent development was for the participant to commence with directed masturbation until ejaculation and then employ satiation. This was further modified by the participant repeating directed masturbation until he was completely unresponsive to sexual stimuli and then commencing satiation while masturbating a flaccid penis. Laws and Marshall commented that duration of satiation with this procedure was brief, usually 20 min. Another variant was for the participant to initially masturbate to slides and audiotapes considered appropriate, then following ejaculation, to masturbate a second time while listening to a relaxation tape under instructions to avoid any sexual fantasy, then masturbate a third time when refractory, while exposed to deviant slides and audiotapes for 1 hr.

II. THEORETICAL BASES

Thorpe, Schmidt, and Castell in their 1963 report of the treatment of a homosexual man by showing him the picture of an attractive scantily dressed woman as he reached orgasm, described the procedure as a positive conditioning technique. Presumably it was expected that the sexual arousal associated with orgasm would by conditioning occur to women. Laws and Marshall in their 1991 review considered orgasmic reconditioning was based on the assumption inherent in conditioning accounts of sexual deviation that the content of masturbation fantasies guided the overt expression of sexual behavior. They stated that Marquis in 1970, though not the first to use the technique of thematic shift, provided the first theoretical rationale for its employment. The aim was to maintain the nondeviant fantasy as continuously as possible throughout the masturbatory sequence until ejaculation. The repeated pairing of sexual arousal and orgasm with appropriate fantasies was expected to initiate conditioning processes that would alter sexual desires in an appropriate direction. Thoughts of appropriate sexual acts with appropriate partners would become attractive. In addition, through the discontinuation of pairing deviant thoughts with masturbation, deviant acts would lose their attraction by simple extinction. Laws and Marshall commented of directed masturbation that it was not clear if it was expected to reciprocally reduce deviant arousal. However, as with the procedure, participants avoid masturbating to deviant themes, simple extinction should operate to reduce this arousal as with thematic shift.

Laws and Marshall stated that satiation was based on the concept that continuous unrewarded repetition of an undesired behavior will lead to its extinction. They cited the 1977 report of Marshall and Lippens that many of their clients had told them their masturbatory fantasies often became boring and they changed them to maintain arousal. Marshall and Lippens reasoned that the continued repetition of favored masturbatory themes during a period when the client was in a low state of sexual arousal should lead to a reduction in the arousing properties of those themes.

III. EMPIRICAL STUDIES

A. Penile Circumference Response Assessment of Outcome

Most of the empirical studies of orgasmic reconditioning report its use in one or a few patients with no or

inadequate controls. They usually rely for assessing change in the individual participant's sexual preference by measuring his penile circumference responses (PCRs) to appropriate and deviant stimuli prior to and following the procedure. The validity of these responses as measures of sexual preference has been increasingly questioned. As early as 1971 Bancroft reported that though the mean PCRs of 30 homosexual men as a group were greater to pictures of nude men than nude women, in only 14 of the 30 as individuals were correlations between their "erection" and ratings of arousal statistically significant. In 1975 Mavisakalian, Blanchard, Abel, and Barlow found the mean PCRs to pictures of a nude young woman failed to discriminate as groups, six homosexual from six heterosexual men. In articles published by McConaghy in 1989 and 1991 and reviewed along with further evidence in 1998 the lack of consistent findings in studies attempting to discriminate groups of rapists or pedophiles from controls by their mean PCRs to deviant stimuli was pointed out. Evidence was also advanced of the ability of their penile volume responses unlike their PCRs to discriminate heterosexual and homosexual men as individuals rather than as groups.

To support the validity of PCR assessment Lalumiere and Quinsey in 1994 reported that meta-analysis of the findings of selected studies investigating the PCRs of rapists demonstrated that the assessment did discriminate rapists from nonrapists, as groups. Hence it was necessary to combine the responses of several groups of rapists and nonrapists by meta-analysis to obtain convincing statistical evidence that PCR assessment discriminated the two groups. This indicated it could weakly discriminate as groups men who differed in sexual preferences, but certainly not as of individuals.

Nevertheless the authors considered the result supported the use of the assessment in individual men. In 1996 Marshall commented that

for a test to have merit, it must be shown that it is in a standardized form that is broadly acceptable, that it is reliable and valid, and that either it is resilient to faking or faking can be reliably discerned. Unfortunately, the available data on phallometric assessments (i.e. PCR assessment of sexual preference) do not meet any of these empirical and technical requirements ... the wisest course of action may be to withdraw its clinical use until more adequate data are available.

Subsequently in 1998 Lalumiere and Harris decided it was unclear whether changes in participants' PCRs following treatment should be thought of as changes in

sexual preference or changes in men's ability to control arousal, a suggestion made previously by Quinsey and Earls in 1990.

In their 1991 review Laws and Marshall accepted that changes in PCRs of individual men to pictures of nude males and females were valid measures of change in their sexual preference that demonstrated the effectiveness of orgasmic reconditioning. Penile volume assessment though consistently demonstrated to validly assess the sexual preference of individual men has not been used to evaluate orgasmic reconditioning.

B. Thematic Shift

In their 1963 report of thematic shift orgasmic reconditioning of a homosexual man Thorpe and his colleagues stated that following the procedure his masturbatory fantasy remained entirely homosexual. The procedure was then alternated with electrical aversive therapy to pictures of nude males, after which he reported great reluctance to use homosexual fantasy with masturbation. Following treatment he had "occasional homosexual patterns" of behavior but continued the new pattern of masturbating to female pictures and fantasies. In a subsequent study Thorpe and colleagues used directed masturbation, instructing a homosexual man to masturbate as often as possible using heterosexual fantasies only. Initially he took a long time to reach orgasm, but later the time decreased, and he reported satisfying fantasy. He was then treated with aversion relief. The participant was said to have experienced heterosexual interest for the first time in his life during and following treatment.

In their 1991 review Laws and Marshall pointed out that unlike these and other early studies in which orgasmic reconditioning required some form of aversive therapy to dampen the attractiveness of the deviant stimuli, in his 1970 study Marquis reported its effective use alone. In the uncontrolled study 12 of 14 participants treated for a variety of sexual deviations reported that they were much improved or cured. Marshall relied on use of PCR assessment in a 1973 study that included thematic shift in 12 clients of mixed diagnoses but pointed out that as aversive therapy was used also causal inferences could not be made.

Ten years after introduction of orgasmic reconditioning Conrad and Winzce in 1976 pointed out the evidence of its efficacy had not gone beyond the case study level. They investigated use of thematic shift in three homosexual men who received this procedure alone and one in whom its use was followed by aversive therapy.

In evaluating their results they attached importance to failure of the participants' reported improvement, PCRs, and their written records of sexual feelings to change in relation to the periods of withdrawal and reintroduction of the treatments. As discussed by McConaghy in his 1977 review expectation that treatment effects would disappear when treatment was withdrawn was accepted at the time in applied behavior analysis theory. That this meant that treatment effects would be evanescent was overlooked. McConaghy concluded the study could be considered an uncontrolled report of a positive response to orgasmic conditioning in three patients, and a negative response in a fourth, who subsequently responded to aversive therapy. Conrad and Winzce accepted the validity of the individual participants' PCR assessments and considered they may have reported changes they did not feel and that both treatments were unsuccessful. Laws and Marshall in their 1991 review decided the study was the only well-controlled study of thematic shift and accepted the authors' interpretation that it failed to demonstrate any effects for the procedure.

C. Fantasy Alternation

Laws and Marshall reviewed the use of fantasy alternation in studies with one to four subjects that used self-report and PCR assessment as outcome measures. Some studies attempted to causally relate the treatment to outcome using a multiple-baseline design. This design relies on demonstrating that the introduction of the treatment targeting one behavior modifies only that behavior and not others that were not targeted. If this occurs it is accepted that the modification is a specific effect of the treatment. This methodology ignores the possibility that the targeting of one behavior has induced an expectancy effect in regard to that behavior and not the others not targeted. In any case in a study cited of a bisexual pedophile, though arousal to female children was targeted and declined, that to male children declined without having been targeted. Laws and Marshall attached significance to one study of four confused, apparently ego-dystonic homosexuals, in two of whom the procedure produced increase rather than decrease in deviant arousal as assessed by their PCRs. They also pointed out that from the theoretical basis of orgasmic reconditioning use of masturbation to deviant fantasies as in fantasy alteration would increase rather than decrease the ability of such fantasies to excite sexual arousal. They con-

cluded it was hard to see any justification for further investigation of the procedure.

D. Directed Masturbation

Laws and Marshall considered there was some evidence that directed masturbation might be effective. At the same time they raised the issue of whether it was appropriate to attempt to reduce men's sexual arousal to deviant fantasies by encouraging them to masturbate exclusively to nondeviant fantasies if they were already strongly sexually aroused by such fantasies. The evidence they cited supporting the procedure was again that of single-case uncontrolled studies using either self-report and/or PCR circumference assessments. It is difficult to see how this evidence was stronger than that supporting the efficacy of thematic shift, which they considered inadequate.

E. Satiation

Laws and Marshall cited single-case studies evaluating satiation, which were also uncontrolled and used participants' self-report and PCR changes as outcome measures. In one a multiple-baseline design was used in which PCR assessed reductions in sexual arousal occurred to stimulus categories targeted in sequence by the satiation procedure. Laws and Marshall did not discuss the possible confounding influence of expectancy effects and/or the ability of the participant to consciously or unconsciously modify his penile responses. Men's ability to modify their PCRs had been well documented by the time of their study. They considered satiation was clearly responsible for the reduction in inappropriate arousal that they considered had been demonstrated by the change in the participant's PCRs. The participant's assessed arousal to adult females showed only a modest increase. In another participant satiation produced marked decline in deviant arousal and a modest increase in arousal to adult women, as assessed by his PCRs. The participant had previously failed to respond to self-esteem enhancement and electrical aversive conditioning. Laws and Marshall criticized single-case studies evaluating combinations of directed masturbation and satiation as providing inadequate data concerning the outcome, or lacking appropriate control. Gray in 1995 reported a comparison study of verbal satiation alone and directed masturbation followed by ammonia aversive therapy in 28 participants, 14 nonrandomly allocated to one or other procedure. Outcome was assessed by participants' PCRs to audiotapes of sexual interactions with adults

and children. Seven of those who received satiation and six of those who received the combined procedure showed reduction in assessed arousal to appropriate stimuli, a finding not discussed by the author. Significant reduction in assessed arousal to deviant stimuli followed the procedure incorporating aversive therapy but not satiation, and it was concluded the former was more effective.

F. Conditioning Theory Basis of Orgasmic Reconditioning Questioned

Accepting the theoretical basis of orgasmic reconditioning that pairing of sexual cues with orgasm would increase sexual arousal, Marshall and Eccles in 1993 concluded concerning pedophiles that

Each time the offender has sex with a child, he obviously pairs heightened sexual arousal with vivid, realistic visions of children and the proprioceptive stimuli produced by his own actions. These contacts provide powerful conditioning trials, and if repeated often enough, should entrench a growing attraction to sex with children even in the absence of masturbating to children.

Evidence that would appear to question this belief was provided by McConaghy in a 1978 study that has been consistently ignored. Using the valid penile volume assessment of the sexual preference of individual men, the arousal to moving films of nude men as compared to that to films of nude women was determined in 181 men seeking treatment for compulsive homosexual feelings. Married men who had repeatedly experienced orgasm in the presence of female cues, namely their wives, but had not had intercourse with other women showed no evidence of increased penile volume arousal to films of women or decrease to films of men, compared to single men with no history of heterosexual intercourse. If all the married men utilized exclusive homosexual fantasies during their intercourse with their wives, it could be argued that these fantasies inhibited the effect of any physical cues from the bodies of the women with whom they were in intimate physical contact. However fewer than 20% of these men reported that they used homosexual fantasy during intercourse with their wives. All had sought treatment to cease homosexual activity and wished to continue the relationship with their wives with whom they frequently stated they were in love. Most said they were sexually aroused by thoughts of their wives, though they felt no sexual

attraction to other women. It is possible that in men who report no sexual arousal to women generally, the repeated experience of heterosexual intercourse with one woman does condition sexual arousal to her, but it does not generalize to other women.

G. Need for Penile Volume Response Assessment of Effects of Orgasmic Reconditioning

The finding that the orgasmic reconditioning procedure experienced regularly by married homosexual men produced no change in their validly assessed sexual preference strongly indicates the need for valid empirical evidence of the ability of the procedure to modify the sexual preference of sex offenders, in whose treatment it remains widely used. The empirical research evaluating it in uncontrolled case studies using self-report and PCR assessment has been conducted in participants most of whom wish to experience or to report changes in their sexual orientation either for their own emotional comfort or to impress therapists who may be influential in regard to legal decisions concerning them. Given the superior validity of penile volume responses to films of nude males and females in assessing sexual preference, studies utilizing it to evaluate the various forms of orgasmic reconditioning used in current sex offender programs would seem urgently required. As stated earlier, Lalumiere and Harris suggested in 1998 that treatments which induce change in PCR assessments may do so not by changing men's sexual preference but by increasing their ability to control inappropriate arousal. If so, orgasmic reconditioning procedures that involve prolonged or repeated masturbation on instruction would seem to require comparison with more acceptable procedures that increase this ability. These include alternative behavior completion (imaginal desensitization), demonstrated in placebo-controlled studies to do so. The conclusion of Laws and Marshall that the combination of directed masturbation and satiation needs to be evaluated in a systematic study could stimulate a randomized controlled comparison of the combination with alternative behavior completion. Unfortunately this seems unlikely.

H. Incorporation of Orgasmic Reconditioning in Multimodal Approaches

As various forms of orgasmic reconditioning are now usually combined with a variety of treatments in multi-

modal approaches, research evaluating any forms alone is unlikely to be carried out. Quinsey in 1986 reported the response of self-referred sex offenders treated with covert sensitization and masturbatory satiation, cognitive restructuring, social and assertiveness skills and sex education; 89% of 44 contacted at 6 months and 79% of 19 contacted at 12 months under confidential conditions reported no recidivism. Travin, Bluestone, Coleman, Cullen, and Melella in 1985 reported a somewhat lower rate of recidivism over a shorter follow-up period with similar therapy in more highly selected sex offenders. These results were not superior to those reported by McConaghy and colleagues in 1985 and 1988 with therapy using alternative behavior completion combined with brief nonstructured counselling carried out during follow-up interviews. However comparisons of the results of these studies cannot be accepted to be meaningful in view of the lack of control of participant differences. McConaghy and colleagues treated all participant who sought treatment for deviant urges they could not control in a cost-free program tailored to allowed those employed to continue to work. The selection procedures and cost of the other programs was not specified, as is common. A further indication that research evaluating individual behavioral procedures is unlikely to be conducted is implicit in the comment of Quinsey and Earls in 1990. They considered that cognitive therapies for sex offenders may not require the addition of behavioral approaches, as the variety of behavioral treatments used to modify sexual arousal patterns all appeared to be at least somewhat effective, and hence all may act nonspecifically.

IV. APPLICATIONS AND EXCLUSIONS

Orgasmic conditioning procedures would appear to have been abandoned in the management of participants reporting problems in relation to homosexual feelings by some therapists because they consider that changing sexual preference by these and other methods is impossible, and others because they consider such attempts are unethical. The American Psychiatric Association in 1998 issued a statement opposing reparative therapy, that is, attempts to change homosexual preference. Currently orgasmic conditioning procedures are used in men with paraphilias, mainly sex offenders. Such men are under considerable social and often legal pressure to comply with treatment. The use of procedures that encourage them to masturbate particularly

for long periods would seem likely to be experienced as demeaning by many such participants whose self-esteem is usually already low. In view of the lack of evidence of the effectiveness of the procedures in changing the sexual preference of men with paraphilias in an appropriate direction, they would seem unlikely to encourage them to form appropriate social relationships. It would seem acceptable to encourage men with paraphilias when they do masturbate to attempt not to use deviant fantasies. However to instruct them, particularly if they are under legal pressure to comply, to masturbate as a therapeutic procedure could be considered unethical when no acceptable evidence has been advanced of its value.

V. SUMMARY

Orgasmic reconditioning aims to change participants' sexual preference so they are more aroused by persons deemed appropriate in age, sex, and ability and willingness to consent, and less by those deemed inappropriate. The various forms that are or have been used are described, and their theoretical bases discussed. Associating pictures, verbal descriptions, or fantasies of appropriate persons with orgasm was considered to act by conditioning to increase arousal to the group to which such persons belonged. Associating similar representations of inappropriate persons with reduction of sexual arousal by repeated masturbation producing satiation was considered to inhibit arousal to the group to which such persons belong. Empirical research considered to support the value of the procedures lacked validity as it was based on self-report and/or change in treated participants' penile circumference responses to representations of appropriate or inappropriate subjects. Penile circumference responses unlike penile volume responses lack validity as measures of individual men's sexual preference. Using penile volume to assess their sexual preference, it was no different in married homosexual men who had repeatedly experienced orgasm with their wives compared to single homosexual men who have never had heterosexual intercourse. This finding casts considerable doubt on the theoretical basis of orgasmic reconditioning and indicates a need for valid research evaluating the procedures that remain in widespread use in the treatment of sex offenders. Until such evidence is produced as the procedures could be experienced by the subjects treated as demeaning, their use particularly by legal compulsion could be considered unethical.

See Also the Following Articles

Arousal Training ■ Bioethics ■ Electrical Aversion ■
Emotive Imagery ■ Multimodal Behavior Therapy ■ Sex
Therapy ■ Thought Stopping

Further Reading

- Lalumiere, M. L., & Harris, G. T. (1998). Common questions regarding the use of phallometric testing with sexual offenders. *Sexual Abuse: A Journal of Research and Treatment, 10*, 227–237.
- Laws, D. R., & Marshall, W. L. (1991). Masturbatory reconditioning with sexual deviates: an evaluative review. *Advances in Behavior Research and Therapy, 13*, 13–25.
- Marshall, W. L. (1996). Assessment, treatment, and theorizing about sex offenders. *Criminal Justice and Behavior, 23*, 162–199.
- McConaghy, N. (1977). Behavioral treatment in homosexuality. In M. Hersen, R. M. Eisler, & P. M. Miller (Eds.), *Progress in behavior modification* (pp. 309–380). New York: Academic Press.
- McConaghy, N. (1998). Assessment of sexual dysfunction and deviation. In A. S. Bellack & M. Hersen (Eds.), *Behavioral assessment: A practical handbook* (4th ed.) (pp. 315–341). Boston: Allyn and Bacon.

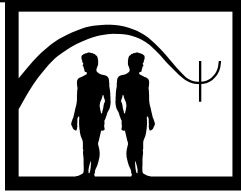

Outcome Measures

Michael J. Lambert and Dean E. Barley

Brigham Young University

- I. The Purpose of Outcome Measures
 - II. Multidimensional Nature of Client Change
 - III. Experimental Design and Outcome Measures
 - IV. Brief Historical Review and Common Outcome Measures
 - V. Categorizing Outcome Measures
 - VI. Characteristics of Good Outcome Measures
 - VII. Future Research Possibilities
 - VIII. Summary
- Further Reading

GLOSSARY

clinical significance Refers to the relevance or meaning of change for the individual client. This is in contrast to statistical significance, which refers to the differences between group means on a measure.

efficacy research Designed to determine the success of specific treatment interventions for a particular disorder.

effectiveness research Intended to discover the overall success of interventions with typical clients in the usual clinic setting.

patient-focused research Centers on observing the individual client's progress throughout the course of therapy to determine how that particular client is responding.

reliable change index The least number of units a score can change on a measure to be certain that the change was not a chance fluctuation due to measurement error inherent from the reliability of the instrument.

Outcome measures are procedures used to document client functioning before, during, and after participat-

ing in psychotherapy. These can include self-report questionnaires, therapist and clinician rating scales, scales completed by the clients' relatives, or even records such as school, medical, insurance, or employment history.

I. THE PURPOSE OF OUTCOME MEASURES

The accurate measurement of clients' responses to psychotherapy is vital in order to (1) improve psychotherapy services both at the individual clinician level and at the level of establishing viable treatment protocols for specific disorders; and (2) demonstrate the effectiveness, including cost-effectiveness, of clinical interventions to interested parties (i.e., consumers, clinicians, researchers, third-party payers, administrators, and those who develop policy).

II. MULTIDIMENSIONAL NATURE OF CLIENT CHANGE

The accurate measurement of client response to psychotherapy is complex due to the multidimensional nature of change. For example, a group of clients who meet the diagnostic criteria for depression may experience to a different degree each of the clinical symptoms (i.e., sadness, suicidal ideation, and so forth). In addition to these distinctions, clients may also experience

variations in other areas such as interpersonal difficulties, physical problems, financial concerns, work impairment, or substance abuse. These various difficulties are frequently the focus of therapeutic interventions, and proper assessment of a client's response to therapy requires that these areas also be evaluated. Hence, outcome measures by necessity must focus on many different areas of performance to give a complete picture of client functioning. Various researchers have proposed that outcome measures could conceivably evaluate aspects of client functioning such as (1) psychological symptoms, (2) interpersonal functioning in close relationships, (3) social role functioning in work or school, (4) physical health, (5) the cost of care and treatment utilization, (6) reduction in public health and safety threats, (7) client satisfaction, and (8) global well-being or quality of life.

III. EXPERIMENTAL DESIGN AND OUTCOME MEASURES

The purpose of an outcome study influences the type of outcome measures used. Efficacy research is designed to determine the relative success of specific treatment protocols for a particular disorder. This type of research uses experimentally controlled conditions with homogeneous populations. Different treatment interventions are given to the experimental and control groups. The responses of the experimental and control groups to the different interventions are measured with scales designed for that population and/or disorder. For example, a study exploring the response of clients to different interventions for depression might use the Beck Depression Inventory (BDI, a short self-report instrument that the client completes), the Hamilton Depression Rating Scale (HDRS, a rating scale completed by a clinician), a structured diagnostic interview, a client self-report scale to assess cognitive distortions, and so on. Differences between the experimental group and the control group on such scales are compared. Conclusions concerning the relative efficacy of interventions are based on tests of statistical difference between the means of the experimental and the control groups.

Effectiveness research measures the mean response of a more heterogeneous group of clients in naturalistic clinic settings. This type of research is designed to discover the overall success of interventions with typical clients in the usual clinical environment. Outcome measures in such studies often evaluate a wider range

of difficulties because clients are not screened and come with more diverse problems. Examples could include instruments with a wider range of symptoms such as the Symptom Checklist 90-Revised (SCL-90-R, a 90-item self-report instrument completed by the client), program evaluation surveys, or client satisfaction questionnaires.

Patient-focused research centers on observing the individual client's response throughout the course of therapy and afterward. This approach determines how each particular client is responding in therapy. Outcome measures that sample a wide range of symptoms are also appropriate for this kind of study. Patient-focused research concentrates on the clinical significance of the individual client's responses to interventions rather than just the statistical significance of differences between group averages as is common in efficacy and effectiveness studies. Establishing the clinical significance of change reveals not just the magnitude of change but also the meaning of change for the individual client.

The most commonly accepted method of defining clinical significance has two components. First, a cutoff point that distinguishes between the "normal" and "dysfunctional" populations on the outcome measure is established. For example, the cutoff point could simply be defined as one standard deviation above the mean of the "normal" group on the measure (or below, depending on which way is more dysfunctional). The second step is to determine the reliable change index (RCI). The RCI is the minimal number of units the client's score must change between administrations to reliably say that the change is not due to chance fluctuation. The RCI is calculated by dividing the absolute change between two scores on the same instrument by the standard error of measurement for that instrument. For a clinically significant positive change to occur by this two-part definition, a client's change in score between the initial administration and subsequent administrations of the scale would have to (1) move from the "dysfunctional" side of the cutoff point into the "normal" range, and (2) move at least as many units as the RCI to ensure that the change was not due to measurement error. Cutoff points and RCIs have been established for many of the most commonly used outcome instruments. For example, on the BDI a client's total score after the initial administration would have to be under 14 (the cutoff score to be in the "normal" population), and would have to be at least 7 points lower than the initial administration in order to comply with this definition of a clinically significant change.

IV. BRIEF HISTORICAL REVIEW AND COMMON OUTCOME MEASURES

The theoretical orientation of researchers has historically influenced the type of instruments used to measure client change. For example, due to the influence of Freudian dynamic psychology, early measures such as the Thematic Apperception Test and the Rorschach Ink Blot Test attempted to measure changes in unconscious processes as a result of participation in psychotherapy. Later, measures such as the Q-Sort Technique were used because of their congruence with client-centered theory. Such procedures are no longer used due to poor psychometric qualities, dependence on inference, and the amount of time and cost required to administer and score them. Measures consistent with behavioral theory (behavioral monitoring) and cognitive theories (e.g., Irrational Beliefs Inventory) have also been used with interventions consistent with those theories.

Early efforts to document client outcome also relied heavily on unstandardized procedures and therapists' ratings of the clients' general improvement in one dimension. More recent efforts have focused instead on measuring outcome in many areas of functioning from a variety of viewpoints. This could include samples from the client, outside observers, relatives, physiological indices, and institutional information such as employment of school records. Current outcome measures have also improved in that they focus on specific symptoms without being theory-bound. Some measures can be used to examine patterns of change over time because they are brief and can be repeated many times through the course of therapy.

Several reviews have demonstrated which instruments have been most frequently used in outcome studies over the past three decades. The most frequently used standardized self-report measures include the State-Trait Anxiety Inventory (STAI), the Minnesota Multiphasic Personality Inventory (MMPI), the Rotter Internal-External Locus of Control, the S-R Inventory of Anxiousness, the BDI, and the SCL-90. A more recent measure, the Outcome Questionnaire-45, (OQ-45, a 45-item self-report questionnaire that measures the clients symptoms and self-distress, functioning in close interpersonal relationships, and social role functioning in society) has been used in a variety of studies to examine patterns of change in psychotherapy. The Hamilton Rating Scale for Depression (HRSD) is the most common scale used by therapists or expert raters, and the Locke-Wallace Marital Adjustment In-

ventory has been used most frequently with significant others to describe changes in relatives participating in therapy.

Unfortunately, researchers studying client outcome in psychotherapy have more frequently created their own unstandardized measures to study client response to treatment. The use of unstandardized measures results in difficulty in communicating, interpreting, and integrating findings between treatment approaches and across studies. Many researchers have therefore proposed the notion of individualizing outcome measures. This usually entails creating specific treatment goals for clients and rating their progress on a graded series of possible outcomes from least to most desirable. The Target Complaints Measure and Goal Attainment Scaling are examples of this type of approach. These approaches have not yet produced valid, reliable, unbiased measures of outcome with findings that are easily integrated across studies.

V. CATEGORIZING OUTCOME MEASURES

As has been mentioned, client outcome to psychotherapy is complex due to (1) the different purposes of outcome research and the resulting variations in research design (efficacy, effectiveness, and patient-focused research; statistical vs. clinical significance); (2) the multidimensional nature of client change; (3) the diversity in psychological theories and approaches to treatment (4) the lack of consistent use of standardized instruments; and (5) the need to evaluate outcome from a variety of viewpoints (such as the therapist, patient, and significant others). One way to bring order to this complexity is to categorize outcome measures on four dimensions: content, temporality, source, and technology. It is possible to categorize any outcome measure on each of these dimensions.

The content dimension refers to the aspect of functioning that is being sampled. This could include intrapersonal events (affect, cognitions, behaviors, symptoms), interpersonal events within close relationships, and the fulfillment of social roles through the client's interaction with society at large (i.e. work and/or school performance).

The temporality category refers to two aspects of a measure. First, it can reflect whether the instrument measures unstable state-like constructs that are expected to show change as a response to psychotherapy versus stable trait-like constructs that are more likely to remain

consistent. Second, the temporality category also calls attention to the number of times the researcher uses the instrument during the course of the study. Some researchers administer an instrument both before and after therapy, whereas others utilize repeated administration throughout the course of therapy to establish a pattern of change both during and following treatment.

The source dimension refers to who completes the instrument: the client, the therapist, relevant others, trained observers, or a social where records are maintained. This dimension is a continuum moving from those most involved with therapy to those least involved. A robust finding is that studies using measures of outcome from different sources do not always yield consistent results. For example, treatment of a phobia may produce a reduction in behavioral avoidance as rated by observers, but it may not produce a decrease in levels of self-reported discomfort. This highlights the need for careful consideration of the source of outcome data in discerning the true impact of therapeutic intervention.

The technology dimension refers to the method or process of data collection. For example, this could include subjective global retrospective ratings of improvement at the end of therapy by the therapist or the client, more careful descriptive procedures that pinpoint specific symptoms at the time of the assessment, frequency counts of observed behaviors by trained observers, or measures of physiological status (e.g., electrodermal response, heart rate). The type of technology used influences the findings of outcome studies. For example, studies using measures that are more open to bias, such as posttherapy retrospective global ratings of change, will produce larger treatment effects than studies that use measures that are less susceptible to rater bias. Scales that are less susceptible to bias, such as those requiring descriptions of specific symptoms at the time of the administration of the instrument, lead to smaller estimates of treatment effect sizes. Thus researchers and consumers of outcome research need to consider carefully the type of technology used in the study when interpreting the findings.

The most common outcome instruments sample intrapersonal content (symptoms or distress) with descriptive technology (assessing current functioning at the time of administration) using self-report as the source. On the temporality dimension, the instruments are usually used as both pre- and posttherapy measures, and are intended to measure state-like client characteristics that hopefully change as a response to therapy. This means that the typical outcome instrument requires that the client rate his or her own behavior, feelings, and symptomatic distress on a

paper-and-pencil measure. This would include instruments such as the BDI, the SCL-90-R, or the OQ-45.

VI. CHARACTERISTICS OF GOOD OUTCOME MEASURES

Researchers have often called for the creation of a “core battery” of outcome instruments to facilitate the comparison and integration of research findings. No such battery has materialized, but the following guidelines in outcome research and the use of instruments have evolved: (1) Specify clearly what is being measured to facilitate replication; (2) examine client functioning from diverse perspectives; (3) use a variety of type of scales and methods; (4) utilize symptom-based atheoretical instruments; (5) examine patterns of change over time with repeated administrations of the measure; (6) instruments should be inexpensive, and should be easy to score and administer; (7) scales should be appropriate for clients with a variety of diagnoses; (8) instruments must be psychometrically sound (standardized, reliable, and valid) and be sensitive to change; (9) instruments must be less susceptible to bias by focusing on the current functioning of the client; (10) they should have enough items in the “normal” and “dysfunctional” range to correct for possible floor and ceiling effects; and (11) they should sample a variety of content areas such as symptoms, interpersonal functioning, and performance in social roles.

VII. FUTURE RESEARCH POSSIBILITIES

With cutoff points and reliable change indexes available on many of the most commonly used instruments, clinicians can now use repeated administrations of brief symptom-oriented measures to see how well clients are progressing in therapy. Both clients and clinicians could be given feedback on how the client is responding, and studies could examine how such immediate feedback improves the outcome and process of therapy. In addition to this, normal patterns of change or “recovery curves” that typify the usual progress of clients during therapy could be formulated for specific outcome instruments. The progress of the individual client could then be compared with the usual progress of clients with the same initial level of disturbance. If patients are not progressing as well as their cohorts, therapists could use that information to reassess and restructure therapeutic interventions.

With sound outcome measures, therapeutic effectiveness could be established for specific disorders, interventions, programs, and even individual providers. Questions concerning “dosages of therapy” for different patient subtypes or disorders could be explored. Further work could be performed linking client outcome with the process of psychotherapy. It would be possible to correlate client progress with specific behaviors during therapy. It would also be possible to study the relationship between clients’ pretherapy characteristics and their distinct responses to therapeutic interventions. This would help answer the question of which types of clients respond best to which kinds of interventions or processes.

With sound outcome measures, the target of defining cost-effective treatment becomes more attainable. This would entail identifying which interventions, therapists, and therapeutic processes result in the best outcomes for which kinds of clients suffering from which kinds of disorders for the least expenditure in time and money.

The wise use of solid outcome measures can give feedback to clinicians about how to help improve their own practice. Master clinicians who repeatedly produce better outcomes can be studied so that other practitioners can learn from their procedures.

VIII. SUMMARY

Outcome measures examine the client’s response to psychotherapy. The use of such measures can improve psychotherapy services and can inform the decisions made by all parties involved in the process. Client change is multidimensional (i.e. personal distress, interpersonal functioning, social role fulfillment), and needs to be assessed from a variety of viewpoints (such as the therapist, the client, and significant others).

Different experimental designs (efficacy, effectiveness, patient-focused research) have different purposes and require different types of outcome measures. Patient-focused research centers on the clinical significance of a change for the individual client rather than on the statistical significance of a difference between group means on a scale score. One definition of clinical significance is that (1) the client move from the “dysfunctional” to the “functional” range on the measure; and (2) the client’s change is greater than a chance fluctuation due to the measurement error of the instrument (is greater than the reliable change index).

Early outcome measures were linked more heavily to theoretical trends of the day, and may have relied more

heavily on therapist global retrospective ratings of client improvement. More recent measures are atheoretical, pinpoint a wider variety of specific symptom complaints at the time of the administration, are brief, and can be administered repeatedly to examine patterns of change. The widespread use of unstandardized measures in the past has resulted in difficulty coordinating and integrating findings.

Outcome measures can be classified according to the dimensions of content (the aspect of client functioning sampled), temporality (the degree to which the measure focuses on state or trait characteristics, and the utility of the instrument in being administered repeatedly), source (who completes the instrument), and technology (the process by which the information is gathered). The type of instrument chosen influences the reported effect sizes of the interventions. Careful researchers need to pick the type of outcome measure that will best answer their research question, and that will most clearly add to the body of growing outcome literature. “Core batteries” of outcome measures have not been established, but the characteristics of a good outcome measure have been identified. As good measures are utilized, future research could more clearly examine what interventions work best with which types of clients and disorders. Cost-effectiveness of interventions can be more clearly investigated, client progress can be monitored during the course of therapy, and clinicians can more easily learn from each other.

See Also the Following Articles

Economic and Policy Issues ■ Effectiveness of Psychotherapy ■ Efficacy ■ Individual Psychotherapy ■ Objective Assessment ■ Research in Psychotherapy ■ Termination

Further Reading

- Lambert, M. J., & Finch, A. E. (1999). The Outcome Questionnaire. In M. E. Maruish (Ed.). *The use of psychological testing for treatment planning and outcome assessment*, 2nd ed. Mahwah, NJ: Lawrence Erlbaum Associates.
- Lambert, M. J., & Hill, C. E. (1994). Assessing psychotherapy outcomes and processes. In A. E. Bergin, & S. L. Garfield (Eds.). *Handbook of psychotherapy and behavior change*, 4th ed. New York: John Wiley & Sons.
- Lambert, M. J., & Lambert, J. M. (1999). Use of psychological tests for assessing treatment outcome. In M. E. Maruish (Ed.). *The use of psychological testing for treatment planning and outcome assessment*, 2nd ed. Mahwah, NJ: Lawrence Erlbaum Associates.
- Ogles, B. M., & Lunnen, K. M. (1996). Assessing outcome in practice. *Mental Health*, 5, 35.

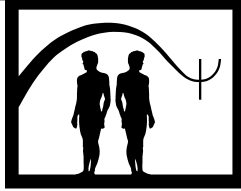

Overcorrection

Steven A. Hobbs, Benjamin A. Jones, and Julie Stollger Jones

Georgia School of Professional Psychology

- I. Description of Treatment
- II. Theoretical Bases
- III. Empirical Studies
- IV. Summary
- Further Reading

GLOSSARY

graduated guidance Adjustment of the amount of force applied to the client's body to provide the minimum amount of physical assistance necessary for completion of required movements.

manual guidance Therapist placement of hands on the client's body to physically assist the client through required movements.

stereotyped behavior Repetitive acts that have no apparent functional effect on the environment.

Overcorrection is a diverse set of treatment techniques that involve contingent delivery of aversive consequences following undesirable behavior. The unique element of overcorrection is that the aversive consequences involve correct forms of behavior directly related to the undesirable act. This use of topographically similar responses is regarded as the critical feature that distinguishes overcorrection from other punishment techniques.

I. DESCRIPTION OF TREATMENT

Overcorrection procedures involve the contingent use of aversive consequences that are directly related in form (i.e., topographically similar) to the undesirable behavior they follow. In a 1982 review of overcorrection research, Richard M. Foxx and D. R. Bechtel identified several other important features of overcorrection.

1. The client is made to experience the effort that would be required of other individuals to correct the personal or environmental effects of the client's undesirable behavior.

2. The client also is required to rapidly perform overcorrection procedures, thereby increasing the effort involved.

3. Physical or manual guidance is employed to ensure client cooperation with, and completion of, the overcorrection procedures.

4. Manual guidance is graduated in that it is adjusted according to the degree to which the client voluntarily responds to directions to perform the required overcorrection acts.

The sequence of procedures used in overcorrection involves several important steps. Initially, the client is informed of his or her inappropriate action. Then the client receives brief verbal instruction regarding the overcorrection responses required. If the client does not immediately initiate the instructed responses,

graduated guidance is provided. Finally, graduated guidance is terminated when the client complies with and/or completes the overcorrection procedure.

Originated in the early 1970s by Nathan H. Azrin and Richard M. Foxx, overcorrection procedures were classified by their developers as consisting of either restitutional or positive practice procedures. Restitutional overcorrection is employed in the treatment of maladaptive behaviors that result in disturbance to the environment (including harm to the client). Such procedures require an individual who demonstrates a maladaptive target behavior to restore the environment and him- or herself to a state that is vastly improved in comparison with conditions prior to the maladaptive behavior. The objective of overcorrecting environmental effects is achieved after first identifying the specific and general disturbances created by the misbehavior and identifying the behaviors needed to greatly improve the consequences of the disturbance. The individual then is required to perform corrective actions in the appropriate context whenever the undesirable behavior occurs. Useful examples of restitutional overcorrection procedures from Foxx and Azrin's initial studies include procedures referred to as oral hygiene training and household orderliness training. Oral hygiene training was employed as a consequence for repetitive mouthing, a behavior that may cause self-infection. The procedure involved verbal instruction and physical guidance directing the client to cleanse the teeth, gums, and lips with mouthwash for a period of 10 min. Household orderliness training was employed as a consequence for acts involving property damage. After throwing or overturning furniture, the client was required to spend 30 min or more wiping tables, emptying ashtrays, and rearranging magazines as well as returning the furniture to its original position.

Positive practice overcorrection is employed in the treatment of maladaptive behaviors that result in no apparent disturbance to the environment or harm to the client. Positive practice procedures require the individual who demonstrates a maladaptive target behavior to repeatedly practice appropriate responses that are relevant to the maladaptive behavior and the context in which it occurred. This objective, repeatedly practicing correct forms of relevant behavior, is achieved after first identifying appropriate behaviors that should be practiced. The client then is required to perform the correct behaviors after each occurrence of the target behavior. In Azrin and Foxx's initial applications, positive practice overcorrection procedures referred to as functional movement training were used to treat forms of self-

stimulatory behaviors such as stereotyped head weaving and repetitive hand clapping. The procedures involved physically restraining either the client's head or hands and then verbally instructing and physically guiding the client through a series of head or hand movements for a period of 5 min.

Overcorrection procedures have been employed in the treatment of self-injurious behaviors, inappropriate toileting, and undesirable social and academic behaviors, as well as inappropriate oral behaviors, aggressive-disruptive behaviors, and self-stimulatory behaviors such as those cited in the preceding examples. Incorporating correct forms of behavior that are topographically similar to a wide range of target behaviors, numerous procedural variations of restitutional and positive practice overcorrection have been developed. In addition to oral hygiene training, household orderliness training, and functional movement training procedures, clinicians have developed overcorrection procedures labeled as medical assistance training, cleanliness training, quiet training, personal hygiene training, personal appearance training, social apology/reassurance training, required relaxation, hand control and awareness, autism reversal, and theft reversal.

Due to potential confusion that may arise from the various procedural labels used to characterize overcorrection treatments, Richard Foxx and D. R. Bechtel have recommended the elimination of all procedural terms and labels, including restitution and positive practice. These authors contended that overcorrection procedures consist of consequences that should be individually designed for each specific target behavior. Accordingly, overcorrection procedures should be described on a case-by-case basis, thus limiting the usefulness of procedural terms and labels.

Foxx and Bechtel noted that the use of the term positive practice has resulted in erroneous inferences regarding the inclusion of negative practice and positive reinforcement as components of overcorrection. It is important to recognize that overcorrection procedures do not include either of these elements. Overcorrection procedures are different from negative practice, a procedure whereby the client is asked to repeatedly practice the undesirable behavior. Moreover, the inclusion of positive reinforcement as a component in overcorrection procedures would alter the aversive nature of these procedures and possibly lead to increases in the target behavior. In those overcorrection studies in which positive reinforcement has been employed, such reinforcement was administered for appropriate behaviors that occurred during times when overcorrection

was not delivered, rather than for correct forms of behavior that were required as part of the overcorrection sequence.

II. THEORETICAL BASES

As aversive stimuli that produce decrements in the behaviors they follow, overcorrection techniques clearly function as punishment procedures. When delivered immediately following undesirable behavior, overcorrection also includes timeout from positive reinforcement, as the client's ongoing behavior is interrupted and opportunities to obtain reinforcement from the environment are eliminated during overcorrection. Negative reinforcement, in the form of removal of manual guidance and termination of the overcorrection procedure, also occurs for the individual's compliance with and completion of the required overcorrection acts.

Overcorrection procedures have been regarded as unique compared with other punishment procedures because of their use of correct forms of behavior that are topographically similar to the maladaptive target response. Whether this element of topographical similarity results in behavioral outcomes that are different from outcomes of other punishment procedures is a question that has not been adequately addressed. Several studies have demonstrated that variations of overcorrection that employ topographically dissimilar forms of behavior can also produce suppression of target behaviors. Moreover, few studies have included data or anecdotal reports of increases in appropriate behavior associated with the use of topographically similar overcorrection procedures. Accordingly, Foxx and Bechtel have recommended the elimination of terms referring to the "educative" and "training" functions of overcorrection. Thus, researchers are left with the question of whether overcorrection entails anything more than an elaborate, albeit effective (as is discussed in the next section), set of punishment procedures.

III. EMPIRICAL STUDIES

Although overcorrection procedures have been utilized most commonly with persons with mental retardation in institutional settings, these procedures also have been employed in the treatment of autism, emotional disturbances, and behavior disorders in a variety of settings. Although many of the treatment studies have focused on children, significant numbers of studies have

been conducted with adults as well. In their 1982 review of 97 overcorrection studies, Foxx and Bechtel classified the maladaptive behaviors treated with overcorrection techniques into categories of aggressive-disruptive behaviors, self-stimulatory behaviors, self-injurious behaviors, toileting behaviors, inappropriate oral behaviors, and educational-social development behaviors. Historically, the vast majority of applications of overcorrection have occurred with aggressive-disruptive, self-stimulatory, and toileting behaviors.

The initial application of overcorrection procedures occurred as a method of toilet training individuals with mental retardation in institutional settings. An extensive set of procedures known as dry-bed training was used following bowel and bladder accidents. The procedures usually consisted of mopping the floor, cleaning wet and soiled items, redressing oneself in clean clothing and replacing bed linens, and repeatedly walking to the toilet and performing a series of responses (pulling pants down, sitting, etc.) involved in appropriate toileting. These procedures later were modified for application to normal children with greater emphasis placed on the positive practice component (i.e., repeatedly walking to the toilet and rehearsing appropriate toileting behaviors). Similar procedures have been applied to children diagnosed with enuresis or encopresis. Despite some variation across studies and populations treated, the duration of overcorrection with toileting behaviors usually has been 30 min or greater, often ranging up to 45 min. Because overcorrection procedures usually have been combined with other effective procedures such as Mowrer and Mowrer's bell-and-pad training and reinforcement for appropriate voiding, it is not possible to determine the relative contribution of overcorrection to the successful outcomes reported in such multicomponent treatment programs. However, reductions of greater than 80% in wetting and/or soiling usually have been reported, with near 100% reductions often being achieved within 1 to 3 months and maintained at 2- to 18-month follow-up.

With aggressive-disruptive behaviors, overcorrection has been employed rather extensively in treating relatively mild problems, such as out-of-seat behavior or talking out, as well as in treating more extreme acts, such as hitting, biting, and assaultive sexual behavior. Typical overcorrection procedures for aggressive-disruptive behaviors include picking up thrown or ripped items, apologizing to the victim, and/or assisting in medical care of the victim. In a few studies, overcorrection has involved requiring the aggressor to lie down, to pat and stroke the victim, or to engage in a series of arm

movements. The duration of these overcorrection procedures has ranged from less than 1 min to 2 hr, with the most frequent durations being 5 to 10 min. In relatively few of these studies has overcorrection been used as the only treatment procedure. Instead, many studies have combined overcorrection with procedures such as verbal warnings and positive reinforcement during periods when the client was not engaged in overcorrection acts. Using DRI (differential reinforcement of incompatible behaviors) or DRO (differential reinforcement of other behaviors) procedures, positive reinforcement has been made contingent either on responses that are incompatible with the target behaviors or on the absence of aggression or disruption for specified intervals. In investigations of overcorrection treatments, reductions of greater than 85% have been observed within 2 weeks to 2 months for most aggressive-disruptive behaviors, with a large number of researchers reporting reductions of near 100%. Maintenance of behavior change has been reported in most studies, with follow-up periods ranging from 5 weeks to 1 year.

In a large number of studies, overcorrection has been used to treat a variety of self-stimulatory behaviors including hand flapping and posturing, stereotyped vocalizations, rocking, hair pulling, and mouthing objects. Behaviors most frequently treated have been hand flapping, rocking, and mouthing. The most commonly used overcorrection procedures for these responses consist of required movement of the body parts involved in the self-stimulatory behaviors. Other common procedures have included enforced toy play and required toothbrushing. The duration of the overcorrection procedures for self-stimulatory behavior has ranged from 30 sec to 20 min, with a typical duration of 2 min. Relatively few treatments for self-stimulatory behaviors have employed overcorrection alone, as most combine overcorrection with other procedures. Additional treatment procedures have included verbal warnings, prevention of self-stimulatory behavior by physical restraint or other means, and/or positive reinforcement (i.e., DRI or DRO procedures). Nearly all investigators reported reductions in target behaviors of greater than 80%, with near 100% reductions observed in the majority of studies. However, follow-up data have been reported in very few studies, with maintenance of behavior reductions rarely reported for longer than 1 to 3 months.

Self-injurious behaviors, such as face slapping, head banging, hand biting, and eye poking and gouging also have been the focus of a relatively small number of overcorrection studies. The most frequently treated

self-injurious behaviors have been head banging and biting. Overcorrection procedures for these behaviors usually have consisted of required movement of the body part involved in the self-injury, sometimes combined with required toothbrushing for self-biting, hair combing for head banging, required bed rest, and applying medication or cream to the affected area. The duration of these overcorrection procedures typically has ranged from 5 to 10 min. Overcorrection has been utilized as the only treatment procedure in most studies but has been combined with positive reinforcement of alternate behaviors in a few instances. Reductions in self-injurious behaviors of 95 to 100% have been reported in less than 1 week of treatment for most cases. The majority of studies have reported follow-up data, with maintenance of treatment effects being demonstrated for 4 to 33 months posttreatment.

A handful of investigations have addressed maladaptive oral behaviors in individuals with mental retardation. This category of behaviors includes drooling, vomiting, rumination (the repeated rechewing and swallowing of regurgitated food), pica (the ingestion of nonnutritive substances such as paper or cigarette butts), and coprophagia (the ingestion of fecal material). Overcorrection procedures have consisted of picking up trash, required practice in correct vomiting, cleaning of vomited matter from various surfaces including walls and floors, and required handwashing, toothbrushing, and mouth wiping. Durations for such procedures have varied considerably, often involving periods of less than 2 min for rumination, drooling, and pica as contrasted with 20 min to 2 hr for coprophagia and vomiting. Brief durations of overcorrection have been used most often combined with other procedures such as DRO and positive reinforcement for appropriate behaviors. Except for drooling, near 100% reduction in these maladaptive oral responses has been reported at posttreatment. The majority of studies conducted follow-up assessments and reported maintenance of these reductions at 3 to 12 months posttreatment.

A limited number of studies have addressed various responses identified by Foxx and Bechtel as educational-social development behaviors. Maladaptive responses in this broad category include errors on academic-related tasks (e.g., oral reading, spelling, writing proficiency, manual signing) and failure to comply with directions/demands to stay on-task, attend class, share with other children, make eye contact, vocalize, eat appropriately, and perform tasks with adequate speed. Overcorrection procedures for these behaviors typically have consisted of requiring

clients to repeatedly correct academic errors, complete written academic tasks, comply with verbal instructions, and engage in required movements of specific body parts (e.g., hand movements with eating utensils or puzzle pieces, head movements in the direction of the therapist). Modeling and reinforcement procedures often have been included as treatment components in these studies. Combinations of these procedures usually have resulted in significant decrements in maladaptive responses, as well as significant improvements in compliance with instructions and accurate responding. However, relatively few studies examining the use of overcorrection procedures with social-academic behaviors have addressed issues of maintenance of behavior change.

As with other punishment procedures, the literature on overcorrection is replete with numerous reports (usually anecdotal in nature) of positive and negative side effects. The majority of studies that have provided data-based observations of side effects have examined stereotyped behaviors of a self-stimulatory or self-injurious nature. Associated with overcorrection have been reported increases in prosocial behaviors such as compliance, cooperation, and appropriate toy play, as well as increases in negative responses such as aggression, emotional outbursts, and nontargeted self-stimulatory behaviors.

IV. SUMMARY

In general, overcorrection represents a response-suppression method that has been demonstrated as highly effective in the treatment of a variety of maladaptive behaviors. Especially when combined with treatment procedures that promote appropriate behaviors, overcorrection has resulted in near elimination of aggressive and disruptive behaviors, self-injurious behaviors, inappropriate oral behaviors, and inappropriate toileting, as well as impressive decrements in self-stimulatory be-

haviors. Brief (i.e., 5 min or less), as well as extended, administrations of overcorrection have been demonstrated to suppress maladaptive behaviors with nearly equal effectiveness. As with most punishment procedures, many studies have reported positive and/or negative side effects with the use of overcorrection. Although a number of single case studies suggest the superiority of overcorrection when compared with other behavioral treatments, methodological problems inherent in these studies severely limit the conclusions that can be drawn from such comparisons. For this reason as well as ethical and practical considerations, inclusion of brief durations of overcorrection are recommended as a component of treatment protocols that provide positive reinforcement for incompatible responses and for alternate forms of appropriate behavior.

See Also the Following Articles

Aversion Relief ■ Positive Punishment ■ Positive Reinforcement ■ Retention Control Training ■ Self-Punishment

Further Reading

- Axelrod, S., Brantner, J. P., & Meddock, T. D. (1978). Overcorrection: A review and critical analysis. *Journal of Special Education, 12*, 367–391.
- Fox, R. M., & Bechtel, D. R. (1982). Overcorrection. In M. Hersen, R. M. Eisler, & P. M. Miller (Eds.), *Progress in behavior modification* (Vol. 13, pp. 227–287).
- Hobbs, S. A. (1976). Modifying stereotyped behaviors by overcorrection: A critical review. *Rehabilitation Psychology, 23*, 1–11.
- MacKenzie-Keating, S. E., & McDonald, L. (1990). Overcorrection: Reviewed, revisited and revised. *The Behavior Analyst, 13*, 39–48.
- Marholin, D. H., Luiselli, J. K., & Townsend, N. M. (1980). Overcorrection: An examination of its rationale and treatment effectiveness. In M. Hersen, R. M. Eisler, & P. M. Miller (Eds.), *Progress in behavior modification* (Vol. 9, pp. 49–80). New York: Academic Press.



Pain Disorders

Douglas A. Songer

Wright State University

- I. Types of Pain
- II. Cognitive-Behavioral Therapy for Pain Disorders
- III. Other Therapies
- IV. Combined Treatment of Pain and Psychiatric Disorders
- V. Summary
Further Reading

ment of pain a priority for all hospitalized patients. Clinicians treating pain need to consider factors such as the duration and intensity of the pain, its psychosocial context, and its associated psychiatric comorbidity. This article will examine the treatment of pain in a biopsychosocial framework, concentrating on psychotherapy as a tool to help treat the pain patient.

GLOSSARY

- acute pain** Pain from an obvious nociceptive source. It is generally self-limited and short-lived.
- automatic thoughts** Spontaneous and rapid, often inaccurate, interpretation of a situation.
- biofeedback** The technique of making unconscious, physiological processes perceptible to the senses through the use of a monitoring device in order to manipulate them by conscious mental control.
- chronic pain** Over 6 months, the original nociceptive cause can no longer explain the duration or severity of the pain.
- continuous pain** Long-standing pain from an obvious source (e.g., cancer pain).
- hypnosis** Induction of a state of selective attention, usually through a combination of imagery and relaxation techniques.
- nociceptor** A specialized peripheral nerve receptor the function of which is to receive pain stimuli.

The treatment of pain is a difficult challenge for all physicians. Recently, JCAHO has made adequate treat-

I. TYPES OF PAIN

A. Overview

Pain was initially perceived as being purely a sensory event, resulting from tissue damage. The fact that patients respond to the same pain-generating stimulus in vastly different manners suggests that such an explanation is much too simplistic. Pain should more appropriately be viewed as a perceptual phenomenon rather than a sensory one. In a perceptual framework, both sensory and psychological factors are incorporated, and there is a much greater recognition of the importance of the attentional, cognitive, affective, and social components to the pain experience.

Physicians often question whether their patients are experiencing “real pain” or not. Such concern is generally useless, as it views pain solely as a sensory rather than a perceptual experience. Accepting patients’ pain complaints as real is important; treatment can then be based on the sensory and psychological experience unique to that patient. Pain is often described as acute,

continuous, or chronic in nature. Table I examines the differences between these types of pain.

B. Acute Pain

In most instances, the treatment of acute pain is uncomplicated. Adequate pharmacological analgesic relief is the first guiding principle. Physicians have often been leery of using narcotic medications even for severe pain because of a fear of the patient becoming addicted. This fear is grossly exaggerated, and narcotics can be used when clinically appropriate with minimal risk of addiction. Patients occasionally do not respond as well as expected to standard pharmacological analgesic treatment, and, in these instances, psychiatric consultation is sometimes requested. Psychosocial components to the pain should be explored in depth, and nonpharmacologic interventions can often be quite helpful. Many of these interventions will be described below.

C. Continuous Pain

Patients suffering from continuous pain pose very different challenges. For example, a patient with bone metastases may suffer some degree of pain no matter how aggressively he or she is treated with narcotic medications. The goal in managing pain in these patients is to help the patient learn to accommodate to the pain. A variety of psychotherapies can accomplish this task and may also permit the patient to decrease the dose of pain medication, minimizing the overall side effect burden. Biofeedback, cognitive-behavioral therapy, and hypnosis have all been demonstrated to be effective in such patients and will be described in further depth below.

D. Chronic Pain

Psychiatric consultation is most frequently requested for patients suffering from chronic pain. In these pa-

tients, the original nociceptive cause of the pain is no longer sufficient in explaining the current level of pain that the patient is experiencing. Pain behavior demonstrated in chronic pain patients often leads the physician to question the veracity of the pain complaints. The patient may complain of being in agonizing pain, but appear quite comfortable, or he may only cry out in pain only when the health care professional walks past his hospital room. Such behavior happens when the patient begins adapting to the pain. If the physician questions whether the pain is real because of this, then the patient may feel he needs to prove that his pain is real. Often, the disruption of the doctor-patient relationship that may ensue in such instances may further complicate the treatment. Patients need to be assured that their pain is real, and that the request for a psychiatric consult does not mean that the physician believes the pain is "all in their head." The consulting psychiatrist should emphasize that the goal of treatment is not cure of the pain, but instead to help the patient deal with it better. Aggressive treatment of underlying psychiatric conditions such as depression or anxiety that are often present in patients with chronic pain is necessary. Pharmacologic treatment must address both the pain and the underlying psychiatric issues to be successful. Psychotherapy interventions must do the same.

II. COGNITIVE-BEHAVIORAL THERAPY FOR PAIN DISORDERS

A. Overview

Cognitive-behavioral therapy has been shown to be effective in patients suffering from either continuous or chronic pain. Patients are taught skills such as distraction, imagery techniques, and calming self-talk, and learn to decrease negative, catastrophizing thoughts that are present in pain patients. Restructuring the patients'

TABLE I
Differences in Pain Types

<i>Pain type</i>	<i>Obvious nociceptive source</i>	<i>Response to narcotics</i>	<i>Time course of symptoms</i>	<i>Associated with psychological symptoms</i>
Acute	Yes	Good	Short, generally 1 month or less	No
Continuous	Yes	Good	Over 6 months	Sometimes
Chronic	No	Fair to poor	Over 6 months	Frequently

cognitive approach to pain is important. Beliefs about their condition, their expectations for the future, and cognitive distortions must all be examined. A catastrophic, overly negative view of the future has been found to be correlated to more intense pain reports. Helping the pain patient to have a more realistic assessment of the future may enable him or her to deal with the pain in the present.

B. Automatic Thoughts

Discovering the automatic thoughts that are present can enable them to be replaced with more realistic thoughts. For example, when the pain becomes worse, an automatic thought may be triggered such as “I’m never going to get better” or “I can’t do anything.” Such automatic thoughts often lead to more emotional distress, and increased physical and psychological dysfunction. Challenging the patients’ inaccurate automatic thoughts can provide the patient with a more realistic and adaptive view of the problem. These same cognitive-behavioral techniques can also be used to treat the comorbid depression and anxiety that are often found in patients with pain.

C. Homework

Homework assignments are always an important part of cognitive-behavioral therapy. In patients with pain disorders, homework assignments may include asking patients to keep track of which specific thoughts, actions, and behaviors exacerbated or helped the pain. Homework can also be used to aid the patient in utilizing the coping strategies discussed in the therapy session. Homework should start easier and get progressively harder as the therapy continues. When easier tasks can be accomplished, the patient is more likely to be motivated to attempt to accomplish the more difficult tasks.

D. Relaxation Training and Imagery

Relaxation training and imagery are important components of cognitive-behavioral therapy for pain patients as well. Progressive muscle relaxation, stretch-based relaxation, and breathing relaxation are all techniques that have been shown to be beneficial. Progressive muscle relaxation involves tensing a muscle group for several seconds, passively focusing on how the tensed muscle feels. The tensed muscles are then released, with passive focus of attention on how the muscles feel as the relaxation

takes place. This sequence is then applied to the major muscle groups of the body.

Stretch-based relaxation is utilized when tensing muscle groups exacerbates the pain. In stretch-based relaxation, series of muscles are very gently stretched without the tensing and relaxing techniques utilized in progressive muscle relaxation. For patients immobilized by their pain, stretch-based relaxation rather than progressive muscle relaxation is often utilized. Once patients become more mobile, progressive muscle relaxation techniques can begin to be used in combination with a stretch-based program.

Breathing relaxation focuses on slow, patterned abdominal breathing. Patients are instructed to inhale slowly and deeply through the nose, allowing the abdomen to expand. With inhalation, the abdomen rises, and the diaphragm moves downward. As the breath continues, the lower part of the chest expands and eventually the upper part of the chest does so as well. When the breath is completed, the patient is instructed to hold the breath for approximately 1 second, and then begin exhaling. The process is reversed with exhalation. The breath is slowly released as the abdomen is drawn back in and the diaphragm is lifted back up. The previously expanded chest now relaxes and exhalation is completed. The empty lungs are held this way for 1 second, and the cycle is again repeated. The entire process should take approximately 8 to 10 seconds, with inhalation and exhalation each lasting 3 to 4 seconds, and pauses following the completion of inhalation and exhalation lasting 1 second.

The use of imagery is often a part of cognitive-behavioral treatment as well. Patients can imagine returning to a calm, relaxing place. For pain patients, this allows their attention to be taken away from their pain. Imagery can also be more specific to the pain. The patient who suffers stabbing, intense trigeminal neuralgia pain, may imagine a knife stabbing into his cheek and can then be guided in therapy into imagining the knife becoming duller, and then ultimately becoming a blunt piece of wood. Other patients may be asked to focus intently on their pain, paying particular attention to its character. Pain does not remain at a constant level, but worsens significantly at times. When the patient becomes more aware of the pain and its inconstant nature, they can be more successful in utilizing imagery to help decrease the pain.

E. Coping Skills

Cognitive-behavioral therapy also involves the practical application of techniques enabling better coping

with day-to-day pain. Diversional techniques such as reading or listening to music can be encouraged. Finding an appropriate pace for activities is equally important. Patients frequently alternate between doing too much, then being nearly immobilized from pain as a result. Encouraging activity, but in a restrained manner that is not likely to exacerbate the pain, is crucial for these patients. Other patients may be too inactive for fear of worsening their pain. Setting concrete, attainable goals may enable them to slowly become more active.

Cognitive-behavioral groups are utilized frequently in hospital-based pain programs. These groups often have a coping skills training component. Coping skills emphasized in such groups often emphasize assertiveness training, acknowledging and expressing feelings appropriately, and self-acceptance. When patients can hear from other fellow pain patients possible coping strategies, they are more likely to utilize them. Groups also offer the benefit of allowing patients to realize that they are not facing their problem alone.

F. Relapse Prevention

Relapse-prevention and maintenance of the learned skills in dealing with pain is an important part of cognitive-behavioral therapy as well. When patients have a flare-up of pain, especially when they have been relatively pain-free for a while, they will often become quite distressed, and feel that they need to “start all over” or that they will never get better. They frequently can forget the coping strategies and cognitive-behavioral techniques described above and can benefit from a short “refresher course.” Emphasizing that one bad day does not undo all the good days that came before it is important as well. Patients can often benefit from a systematic approach to identifying the cause of the increased pain and discovering ways to prevent future flare-ups.

III. OTHER THERAPIES

A. Operant-Behavioral Therapy

In the operant-behavioral approach to the patient with pain, the goal is simply to change behavior by reinforcing well behavior and ignoring pain behavior. The operant model pays particular attention to the role that the patient's family may play in contributing inadvertently to pain behavior. Pain behavior may have been reinforced by providing attention, or permitting the patient to avoid undesirable activity. The family of

the pain patient is told to ignore pain behaviors such as lying in bed moaning, while even small steps toward increased function are strongly reinforced. Homework assignments for both the patient and the family are often a part of the treatment. When both the family and the treating physician are involved, the benefits of this approach are magnified. An operant-behavioral approach to pain is often used in conjunction with a cognitive approach for additional therapeutic benefit.

B. Biofeedback

Biofeedback has often been used for a variety of pain complaints, including chronic tension headaches, low back pain, temporomandibular pain, fibromyalgia, and arthritis pain. Patients undergoing biofeedback become adept at monitoring physiological processes such as heart rate, muscle tension, and galvanic skin response. Patients learn to control these processes and thereby control overall physiological arousal. Biofeedback treatment often involves 10 to 20 sessions in which a physiological monitoring device is attached to the patient. The patient is then instructed to do whatever possible to alter the physiological parameter (e.g., skin temperature) in the specified direction. Biofeedback training typically includes training in specific relaxation strategies, such as progressive muscle relaxation or diaphragmatic breathing to aid patients to better control their physiological processes. The success of biofeedback is greatly dependent on the patient continuing to use the techniques learned in the biofeedback sessions at home.

C. Hypnosis

Hypnosis can also be a useful psychotherapeutic tool in the management of the pain patient. It has been shown to be effective in alleviating the chronic pain associated with cancer, irritable bowel syndrome, tension headaches, temporomandibular disorders, and a variety of other chronic pain disorders. Hypnosis is defined as the induction of a state of selective attention, typically through relaxation and imagery techniques. Hypnosis has both presuggestion and postsuggestion components. The presuggestion component involves attentional focusing through the use of imagery, distraction, or relaxation, and has features quite similar to relaxation techniques discussed earlier. During the suggestion component, the specific goal is introduced (e.g., a change in the nature of the pain from intolerable to mildly annoying). The postsuggestion phase involves continued use of the new behavior after hypnosis is terminated.

The hypnotherapist can, at times, teach patients to hypnotize themselves. Self-hypnosis has the potential to be an effective method for controlling both acute and chronic pain as well, especially for the motivated patient that will practice the technique at home. While not all patients can master this technique, benefits for those who can may include an increased sense of control over their illness and less dependency on the health care system. As with any pain treatment technique, hypnosis works best when it is employed early in the pain cycle, before the pain has become severe enough to impair concentration.

Meditation serves a similar function to hypnosis or self-hypnosis for patients but does not involve suggestion, autosuggestion, or the induction of a trance state. Mindfulness meditation focuses on development of an awareness of bodily sensations and mental activities in the present moment to allow the body to relax and the mind to calm. Chronic pain patients generally feel at the mercy of their illness and are quite frustrated by how much their pain controls their life. Offering tools such as meditation and self-hypnosis that patients may utilize on their own empowers them and allows patients to feel that they are once again in control of their life.

Biofeedback, hypnosis, and meditation are often used in conjunction with cognitive-behavioral therapy. As described earlier, the relaxation techniques utilized in cognitive-behavioral therapy are used in biofeedback to aid the patient in garnering more control over physiological processes, and used in the presuggestion phase of hypnosis. There is an underlying presumption in cognitive-behavioral therapy, biofeedback, and hypnosis that it is possible to attenuate the effects of pain through the use of the mind. Each of these therapies requires active intervention on the part of the patient, especially when self-hypnotic techniques are added to regular hypnotherapy. The patient must take not only an active part in his or her therapy, but must continue

to do so once at home to ensure that gains made will be sustained. Table II describes the similarities and differences in cognitive-behavioral therapy, operant-behavioral therapy, biofeedback, and hypnosis.

IV. COMBINED TREATMENT OF PAIN AND PSYCHIATRIC DISORDERS

Patients with pain disorders often have comorbid psychiatric disorders. Patients who have either continuous or chronic pain are very likely to develop depression. Other psychiatric disorders, including anxiety and somatoform disorders, can frequently be found as well. The psychotherapist treating the patient who has a pain disorder must be alert to the likelihood of psychiatric disorders and ensure that they too are aggressively treated. A better treatment outcome is likely when both the comorbid psychiatric illness and the pain disorder are treated, rather than exclusively focusing on one or the other.

Many of the therapeutic methods utilized to treat the comorbid psychiatric illnesses can also be helpful in treating the pain disorder. Pharmacologic approaches such as antidepressants are often used as adjunctive agents in the treatment of pain disorders, as well as being a primary method in the treatment of depression. Anticonvulsant medications such as carbamazepine and gabapentin have often been used in a variety of pain disorders and are considered useful as augmenting agents in the treatment of anxiety or depression.

Cognitive-behavioral therapy techniques useful in the treatment of pain disorders are also helpful in the treatment of depression and anxiety. Relaxation therapy techniques utilized in the treatment of pain disorders are also frequently used in the treatment of anxiety disorders. Other cognitive-behavioral techniques, such

TABLE II
Therapies for Pain Disorders

Therapy	Automatic thoughts	Relaxation techniques	Homework	Family involvement	Monitor physiological process	Induction of state of selective inattention
Cognitive-behavioral	Yes	Yes	Yes	Yes	No	No
Operant-behavioral	No	No	Yes	Yes	No	No
Biofeedback	No	Yes	Yes	No	Yes	No
Hypnosis	No	Yes	No (except in self-hypnosis)	No	No	Yes

as cognitive restructuring and changing automatic thoughts, are common to the treatment of pain disorders, depression, and anxiety. The patient who has learned these techniques in one context should be able to more easily apply them when the other illness is being treated.

When treatment for the comorbid psychiatric illness is initiated, the therapist must be careful not to imply that this means that the therapist feels that the illness is “all in the patient’s head.” Most patients will readily accept the concept that psychiatric illness and pain disorders amplify each other’s effects. For example, when a patient’s pain becomes worse, this will often worsen a depression. A worsened depression makes it even harder to handle the pain, and this can lead to further pain, and even more depression. If the depression can be treated, then the patient’s capacity to tolerate pain may increase as well.

In a similar vein, anxiety disorders must be appropriately treated as well. Patients with anxiety disorders frequently suffer from muscle tightness and have a constant low-grade muscle tenseness. For the chronic pain patient, this constant tension can be a source of additional discomfort. Treatment of anxiety with psychotropic medications or psychotherapy is necessary for complete treatment of the underlying pain.

V. SUMMARY

The treatment of the patient with a pain disorder poses a significant challenge for any clinician. Patients often resent being referred to a mental health professional, and are hesitant to accept that there may be an emotional overlay to their pain complaints. Clinicians need to take care not to suggest that the pain experienced is anything less than real, but also need to treat the comorbid psychiatric illnesses that are often present in the chronic pain patient population.

Psychotherapeutic approaches that have been shown to be effective in the treatment of patients with pain disorders include cognitive-behavioral therapy, operant-behavioral therapy, biofeedback, and hypnosis. Relaxation techniques such as progressive muscle relaxation are often used in cognitive-behavioral therapy, biofeedback, and hypnosis and are an important component of the treatment of pain disorders. Patients with psychiatric disorders such as anxiety or depression can often benefit from a psychotherapeutic approach that utilizes many of the features found in the treatment of pain disorders.

See Also the Following Articles

Biofeedback ■ Comorbidity ■ Medically Ill Patient: Psychotherapy ■ Somatoform Disorders ■ Stretch-Based Relaxation Training

Further Reading

- Bone, R. C. (Ed.). (August 1996). Management of chronic pain part II. *Disease-a-Month*, 42, 459–506.
- Brose, W. G., & Spiegel, D. (1992). Neuropsychiatric aspects of pain management. In S. C. Yudofsky & R. E. Hales (Eds.), *The American Psychiatric Press textbook of neuropsychiatry* (2nd ed., pp. 245–275). Washington, DC: American Psychiatric Press.
- Eimer, B. N. (2000). Clinical applications of hypnosis for brief and efficient pain management psychotherapy. *American Journal of Clinical Hypnosis*, 43, 17–40.
- Gaupp, L. A., Flinn, D. E., & Weddige, R. L. (1994). Adjunctive treatment techniques. In C. D. Tollinson, J. R. Satterthwaite, & J. W. Tollison (Eds.), *Handbook of pain management* (2nd ed., pp. 108–135). Baltimore: Williams & Wilkins.
- National Institutes of Health. (1996). Technology Assessment Panel on Integration of Behavioral and Relaxation Approaches into the Treatment of Chronic Pain and Insomnia. *Journal of the American Medical Association*, 276, 313–318.
- Turk, D. C., & Rudy, T. E. (1994). A cognitive-behavioral perspective on chronic pain: beyond the scalpel and syringe. In C. D. Tollinson, J. R. Satterthwaite, & J. W. Tollison (Eds.), *Handbook of pain management* (2nd ed., pp. 136–151). Baltimore: Williams & Wilkins.

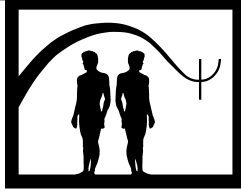

Panic Disorder and Agoraphobia

Stefan G. Hofmann

Boston University

- I. Description of Treatment
- II. Theoretical Bases
- III. Empirical Studies
- IV. Summary
- Further Reading

GLOSSARY

agoraphobia Significant anxiety about places or situations from which escape might be difficult or in which help might not be easily available in the event of having a panic attack. Approximately one-third of patients with panic disorder meet this additional diagnosis.

panic disorder An anxiety disorder that is characterized by recurrent and unexpected panic attacks, which are discrete episodes of intense fear that are accompanied by a number of typical somatic and cognitive symptoms. Approximately 3% of the population is affected by this disorder over the course of a lifetime.

This article presents the therapeutic techniques, the theoretical basis, and the empirical evidence of cognitive-behavior therapy, an empirically supported intervention for the treatment of panic disorder and agoraphobia.

I. DESCRIPTION OF TREATMENT

The most effective psychological treatment for panic disorder with agoraphobia to date is cognitive-behavior

therapy (CBT). This treatment is usually delivered in 12 weekly 60-min individual treatment sessions but can also be conducted in a small group format consisting of two therapists and between four and seven patients. Between each session, the patients are given clearly specified “homework” assignments to practice the newly acquired skills that are discussed in treatment. In addition, patients are expected to complete daily monitoring forms in order to identify specific panic attack triggers. These monitoring forms also serve the purpose of monitoring the patients’ progress throughout treatment and of enhancing the patients’ sense of predictability and controllability.

One of the best-studied CBT manuals for panic disorder is the Panic Control Treatment protocol (PCT) developed by David H. Barlow and his colleagues. The treatment consists of the following components: (a) education about the nature of anxiety and panic; (b) training in slow breathing; (c) cognitive restructuring; (d) interoceptive exposure exercises; and (e) *in vivo* situational exposure exercises for individuals with high levels of agoraphobia.

A. Education about the Nature of Anxiety and Panic

During the first two sessions, patients are taught about the nature and function of fear and its nervous system correlates. The fear response is presented as a normal and generally protective state that enhances the individual’s

ability to survive. Panic attacks are conceptualized as inappropriate fear reactions arising from spurious, but otherwise normal, activation of the body's fight-or-flight response system. Like other fear reactions, panic attacks are portrayed as alarms that stimulate the person to take immediate defensive action. Because the individual normally associates the fight-or-flight response with the presence of danger, panic attacks typically motivate a frantic search for the source of threat. When none is found, the treatment model assumes that the person looks inward and interprets certain bodily symptoms as signs of a physical or psychological catastrophe (e.g., "I'm dying of a heart attack," "I'm losing my mind").

In addition to normalizing and demystifying panic attacks, the educational component of PCT provides patients with a model of anxiety that emphasizes the interaction between the mind and body and provides a rationale and framework for the skills to be taught during treatment. A three-component model is utilized, in which the dimensions of anxiety are grouped into physical, cognitive, and behavioral categories. The physical component includes bodily changes (e.g., neurological, hormonal, cardiovascular) and their associated somatic sensations (e.g., shortness of breath, palpitations, lightheadedness). The cognitive component consists of thoughts, images, and impulses that accompany anxiety or fear (e.g., thoughts of dying, images of losing control, impulses to run). The behavioral component contains behaviors that are associated with anxiety (e.g., pacing, carrying a safety object, or simply avoiding or escaping the situation). These three components are described as interacting with each other, often with the result that anxiety is heightened. The therapist then explains that the goal of treatment is to learn skills for controlling each of the three components of anxiety. To manage some of the physical aspects of anxiety, such as sensations due to hyperventilation (e.g., lightheadedness and tingling sensations) or muscle tension (e.g., trembling and dyspnea), patients are taught slow, diaphragmatic breathing. To reduce anxiety-exacerbating thoughts and images, patients are further taught to critically examine, based on past experience and logical reasoning, their estimations of the likelihood that a feared event will occur, the probable consequences if it should occur, and their ability to cope with these consequences. In addition, they are assisted in designing and conducting behavioral experiments to test their predictions.

B. Breathing Retraining

Beginning with Session 3, patients are taught a breathing technique that encourages slow, diaphragmatic

breathing over fast chest breathing. When introducing this treatment component, the patients are usually asked to first voluntarily hyperventilate by standing and breathing fast and deeply, as if blowing up a big balloon, for approximately 1 min. This exercise typically induces intense and unpleasant bodily sensations (e.g., racing heart, dizziness, tingling sensations in hands and feet), which often resemble some of the sensations that patients experience during a panic attack. Once the symptoms have abated, the therapist educates the patients about the physiological basis of hyperventilation and suggests that this may often be associated with panic attack episodes. It is then suggested that chronic hyperventilation, which may be caused by relatively fast and shallow chest breathing, might lower the threshold and therefore increase the risk for experiencing recurrent panic attacks.

In the next step, the therapist introduces a breathing control technique, which encourages patients to rely on the diaphragm rather than on chest muscles when breathing. In addition, patients are instructed to concentrate on their breathing by counting their inhalations and thinking the word "relax" on exhalations. The therapist models the suggested breathing patterns and then provides corrective feedback to patients while they practice this technique in the office setting. In Session 4, patients are further taught a technique to slow the rate of breathing with the goal of comfortably spanning a full inhalation and exhalation cycle over 6 sec. Again, the therapist models and then provides corrective feedback as practice is conducted during the session. As part of the homework assignment, patients are instructed to practice diaphragmatic breathing at least two times a day, for at least 10 min for each of the remaining sessions.

C. Cognitive Restructuring

The PCT manual introduces this treatment component in Session 4 by suggesting that thoughts are hypotheses or guesses rather than facts. The therapist explores the patients' thinking errors that are typically associated with panic attacks. Two main types of cognitive errors are described. The first error is probability overestimation, or jumping to negative conclusions and treating negative events as probable when in fact they are unlikely to occur. The second error is catastrophic thinking, or blowing things out of proportion.

The method for countering overestimation errors is to question the evidence for probability judgments. Typical probability overestimations are: "The feeling of dizziness are caused by a brain tumor," or "the feeling

of breathlessness is a sign of a heart attack.” Patients are encouraged to examine the evidence for these predictions, while considering alternative, more realistic hypotheses. This is best done in a Socratic style (i.e., leading questions) so that patients examine the content of their statements and reach alternative explanations.

Similarly, the method of countering catastrophic thinking is best done by using Socratic questions. This type of error typically arises from viewing an event as “catastrophic” when, in actuality, it is not. Typical kinds of catastrophic thoughts are “If I faint people will think that I am weak and this would be unbearable,” or “If people notice my anxiety, I will make a fool of myself and I could not deal with this.” By challenging and modifying these catastrophic thoughts (“decatastrophizing”) the patients begin to realize that the actual occurrences are not as “catastrophic” as originally assumed because there are ways to cope with these situations.

D. Interoceptive Exposure

To change maladaptive anxiety behaviors, patients learn to engage in graded therapeutic exposure to cues they associate with panic attacks. The exposure component (interoceptive exposure) focuses primarily on internal cues, specifically, frightening bodily sensations. The rationale for needing to perform interoceptive exposure exercises is very important for facilitating generalization from in-session practices to daily exposures. For this purpose, the therapist explores the way in which avoidance of feared sensations serves to maintain fearfulness. Activities that are avoided because of the associated physical sensations may not be immediately obvious to patients. They may include physical exercise, emotional discussions, suspenseful movies, steamy bathrooms, drinking coffee, and other arousing activities.

The purpose of these interoceptive exposure exercises is to repeatedly induce sensations that are feared and to weaken the fear response through habituating and learning that no actual danger results. In addition, the repeated inductions allow practice in applying the cognitive techniques and breathing strategies. As a result, fear of physical sensations that occur naturally is significantly reduced.

During exposure, patients deliberately provoke physical sensations like smothering, dizziness, or tachycardia by means of exercises such as breathing through a thin cocktail straw, hyperventilating, spinning, or strenuous physical exercise. These exercises are done initially during treatment sessions, with therapist modeling, and subsequently by patients at home. As patients become less afraid of the sensations, more naturalistic activities

are assigned, such as drinking caffeinated beverages, watching suspenseful movies, or going to a sauna.

E. In Vivo Situational Exposure

An optional situational exposure component can be added for patients with significant agoraphobic avoidance. As currently administered, exposure therapy typically begins with the construction of a hierarchy of feared situations, which the patients are encouraged to enter repeatedly, starting with easier ones, and remain until anxiety diminishes. Sometimes the therapist accompanies the patients initially, but ultimately they are expected to do the task alone.

The most challenging aspect of this treatment component is to motivate the patients to engage in these exposure exercises without using any avoidance strategies. Before conducting the exercises, the therapist needs to thoroughly explore any forms of avoidance and anxiety-reducing strategies that patients typically use, some of which might be more obvious (e.g., carrying medication or a cell phone) than others (e.g., carrying quarters for a public phone, sunglasses, or chewing gum). Ideal situations at the beginning of the exposures are situations that are under the therapists’ control and in which escape and avoidance strategies are difficult (e.g., leaving patients alone in a shopping mall). Once the patients have successfully mastered those situations, the therapist will then choose situations that are less controllable by the therapist (e.g., driving long distances in the car alone).

II. THEORETICAL BASES

A. History of Diagnosis and Treatment Models

Panic disorder was first officially recognized as a distinct diagnostic entity after a series of pharmacological experiments conducted by Donald Klein and his collaborators in the late 1950s and early 1960s. Klein and his colleagues observed that imipramine, an antidepressant, was effective against spontaneous panic attacks, but not against chronic and anticipatory anxiety. Klein concluded that panic and anticipatory anxiety reflect two qualitatively different underlying biological processes. By the 1980s, the efficacy of pharmacological treatment with imipramine in patients with panic disorder had been well established, and imipramine became the pharmacological criterion standard for the treatment of panic disorder for more than 20 years, until the emergence of the selective serotonin reuptake inhibitors.

Prior to including panic disorder as a distinct type of anxiety disorder in *DSM-III* in 1980, psychological therapies tended to focus primarily on the behavioral pattern of situational avoidance that frequently occurs in patients with panic attacks. During the 1960s and 1970s, systematic desensitization, consisting of imaginal exposure to feared situations paired with muscle relaxation, was the principal form of treatment. That approach was preferred to *in vivo* exposure, because it was thought the latter might engender too much anxiety for patients to manage. However, subsequent studies showed that *in vivo* exposure was superior to systematic desensitization for treating agoraphobia. During the 1980s, paralleling with the increasing recognition of the importance of fear of panic attacks as a factor in the development and progression of panic disorder, investigators began to experiment with treatments aimed more specifically at patients' experiences of anxiety related to panic and somatic sensations. These treatments are now called exposure therapy, behavior therapy, cognitive therapy or cognitive-behavioral therapy, depending on the theoretical orientation of the clinician or the emphasis placed on the treatment components, although in practice there is considerable overlap among them.

Researchers today generally agree that a combination of cognitive and behavioral strategies is the most effective psychological treatment for panic disorder and agoraphobia. Some researchers believe that exposure therapy primarily targets agoraphobic avoidance, whereas CBT either enhances the efficacy of exposure therapy or specifically addresses the panic attacks and associated features. Others assume that the treatment effects are primarily due to either exposure therapy or CBT.

B. Contemporary Psychological Models

The most popular psychological model of panic and agoraphobia today is the cognitive model. This model assumes that preexisting beliefs about the harmfulness of bodily sensations predispose people to regard them fearfully. Panic attacks are therefore viewed as resulting from the catastrophic misinterpretation of certain bodily sensations, such as palpitations, breathlessness, dizziness, and so on. An example of such a catastrophic misinterpretation would be a healthy individual perceiving palpitations as evidence of an impending heart attack. The vicious cycle of the cognitive model suggests that various external stimuli (i.e., the feeling of being trapped in a supermarket) or internal stimuli

(i.e., body sensations, thoughts or images) trigger a state of anxious apprehension if these stimuli are perceived as threatening. It is assumed that this state is accompanied by fearful bodily sensations that, if interpreted in a catastrophic fashion, further increases the apprehension and the intensity of bodily sensations. Moreover, this model states that the attacks appear to come from "out of the blue" because patients fail to distinguish between the triggering body sensations of the subsequent panic attack and the general beliefs about the meaning of an attack.

Another popular psychological model is the anxiety sensitivity hypothesis by Steven Reiss and Richard J. McNally. Anxiety sensitivity denotes the tendency to respond fearfully to anxiety symptoms and is based on beliefs that these symptoms lead to harmful consequences. Similar to the cognitive model, the anxiety sensitivity hypothesis assumes that beliefs about the harmfulness of bodily sensations predispose people to respond fearfully. In contrast to the cognitive model, however, the anxiety sensitivity hypothesis does not require that patients misconstrue anxiety as something else (such as a heart attack). Instead, the model assumes that people with high anxiety sensitivity may be well aware of what causes the feared bodily sensations. Rather, patients believe that the high arousal itself might eventually lead to heart attacks, insanity, or other catastrophes.

C. Contemporary Biological Models

Biological models of panic assume that the disorder is associated with the dysregulation of a number of different biological systems. One of the most popular biological models today is the suffocation alarm hypothesis by Donald Klein. This model assumes that panic disorder is characterized by a pathologically low threshold for firing of an evolved "suffocation alarm," which can be activated by a number of biological (e.g., carbon dioxide inhalation) and psychological challenge procedure (e.g., feeling of being trapped) that signal impending loss of oxygen.

III. EMPIRICAL STUDIES

The efficacy of CBT has been demonstrated in numerous clinical studies. For example, it has been shown that PCT is superior to a relaxation condition or alprazolam, a frequently prescribed benzodiazepine to treat panic attacks. More recently, the PCT protocol was compared to imipramine, an antidepressant, which is often considered to be the gold standard pharmacological

treatment for panic disorder. This study compared the efficacy of imipramine, a pill placebo, and combinations of PCT with imipramine or a pill placebo in a large, multicenter trial conducted by David H. Barlow and his colleagues. A total of 312 panic disorder patients with mild or moderate agoraphobia were randomly assigned to imipramine, PCT, PCT plus imipramine, PCT plus placebo, or placebo only. Participants were treated weekly for 3 months. In addition, responders were seen monthly for 6 months and then followed up for an additional 6 months after treatment discontinuation. The results of this study showed that combining imipramine and CBT had limited advantage acutely but more substantial advantage in the longer term: Both imipramine and PCT were superior to placebo on some measures for the acute treatment phase and even more pronounced after the 6 monthly maintenance sessions. Six months after treatment discontinuation, however, people were more likely to maintain their treatment gains if they received PCT, either alone or in combination with a pill placebo. Individuals who received imipramine were more likely to relapse than those who did not receive the antidepressant.

Similar results were also reported with a CBT protocol that focuses more on cognitive restructuring. For example, a study by David M. Clark and his colleagues compared cognitive therapy, applied relaxation, imipramine, and a wait-list control group. At posttreatment, 75% of the cognitive therapy patients were panic free, compared with 70% in the imipramine condition, 40% in the applied relaxation condition, and 7% in the wait-list control condition. Cognitive therapy was superior to the wait-list control group on all panic and anxiety measures, whereas imipramine and applied relaxation were better than the wait-list control group on approximately one-half of the measures. At 9-month follow-up, after imipramine had been discontinued, the panic-free rates were 85% for cognitive therapy, 60% for imipramine, and 47% for applied relaxation. These results are consistent with reviews and meta-analyses of treatment outcome studies utilizing *in vivo* situational exposure, suggesting that 60 to 75% of treatment completers experience clinical improvement with fairly stable treatment gains at treatment follow-ups.

It is not known at present which components of CBT are most important for treatment efficacy or whether they all contribute uniquely to efficacy. Panic patients with high levels of agoraphobia seem to respond best to *in vivo* situational exposure. Patients with moderate or mild agoraphobia seem to respond best to CBT protocols that combine cognitive restructuring, psychoedu-

cation, interoceptive exposure exercises, and breathing retraining and relaxation exercises. Unfortunately, except for the use of a relaxation control condition in some studies, direct comparisons of the various components are lacking. However, there is some indication in the literature that repeated interoceptive exposure practices alone are effective in reducing panic attacks even without any explicit cognitive restructuring techniques. Similarly, *in vivo* situational exposure practices seem to be effective in treating panic disorder and agoraphobia without explicit cognitive interventions. Thus, although CBT for panic disorder and agoraphobia is clearly effective, little is known about the most important active ingredients in treatment and the mechanism of treatment action.

IV. SUMMARY

Panic disorder is a debilitating disorder that is characterized by recurrent and unexpected panic attacks. Approximately 3% of the population is affected over the course of a lifetime, and one-third of those individuals also develop agoraphobia, usually within 1 year of the initial occurrence of the panic attacks.

A number of biological and psychological models of the disorder have been proposed. A prominent biological model, the suffocation alarm hypothesis, assumes that panic disorder is the result of a pathologically low threshold for firing of a "suffocation alarm." The two most prominent psychological models are the cognitive model and the anxiety sensitivity model. The cognitive model assumes that panic attacks result from the catastrophic misinterpretation of certain bodily sensations. The anxiety sensitivity hypothesis does not assume that all panic attacks are caused by catastrophic beliefs. Instead, this hypothesis is based on the assumption that individuals with panic disorder have inherited a tendency to respond fearfully to anxiety symptoms.

CBT and *in vivo* exposure therapy are the most effective treatments for panic disorder with agoraphobia. A typical CBT protocol combines education about the nature of panic attacks, controlled breathing procedures, cognitive restructuring, interoceptive exposure exercises, and situational exposure practices. The treatment is usually delivered in 12 weekly 60-min individual sessions. The efficacy of this treatment protocol is well documented. Controlled studies show that this intervention is more effective than relaxation techniques and at least as effective as alprazolam or imipramine. Cognitive restructuring, interoceptive exposure practices, and

in vivo situational exposure exercises all seem to be important components for the treatment of panic disorder and agoraphobia. However, it remains unclear which component is most effective for treating the disorder and what the mechanism of action of treatment is.

See Also the Following Articles

Anxiety Disorders ■ Applied Relaxation ■ Breathing Retraining ■ Complaints Management Training ■ Exposure *in Vivo* Therapy ■ Homework ■ Relaxation Training

Further Reading

- Barlow, D. H. (2002). *Anxiety and its disorders* (2nd Ed.). New York: Guilford Press.
- Barlow, D. H., Gorman, J. M., Shear, M. K., & Woods, S. W. (2000). Cognitive-behavioral therapy, imipramine, or their combination for panic disorder. *Journal of the American Medical Association*, 283, 2529–2536.
- Clark, D. M. (1986). A cognitive approach to panic. *Behavior Research and Therapy*, 24, 461–470.
- Hofmann, S. G., Bufka, L., & Barlow, D. H. (1999). Panic provocation procedures in the treatment of panic disorder: Early perspectives and case studies. *Behavior Therapy*, 30, 307–319.
- Hofmann, S. G., & Spiegel, D. A. (1999). Panic Control Treatment and its applications. *Journal of Psychotherapy Practice and Research*, 8, 3–11.
- Klein, D. F. (1964). Delineation of two drug-responsive anxiety syndromes. *Psychopharmacologia*, 5, 397–408.
- McNally, R. J. (1994). *Panic disorder: A critical analysis*. New York: Guilford Press.
- Reiss, S. (1991). Expectancy model of fear, anxiety and panic. *Clinical Psychology Review*, 11, 141–153.
- Taylor, S. (1999). *Anxiety sensitivity: Theory, research, and treatment of the fear of anxiety*. Mahwah, NJ: Lawrence Erlbaum.

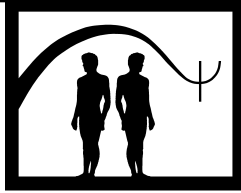

Paradoxical Intention

L. Michael Ascher

Philadelphia College of Osteopathic Medicine

- I. Description of Treatment
 - II. Theoretical Considerations
 - III. Applications and Exclusions
 - IV. Empirical Studies
 - V. Case Illustration
 - VI. Summary
- Further Reading

GLOSSARY

fear-of-fear The concern that anxiety will result in the experience of negative physical consequences; these consequences can range from life threatening (e.g., cardiac arrest) to seemingly innocuous (e.g., perspiration).

logotherapy An existential approach to psychotherapy—developed by Viktor Frankl—that postulates meaning in one's life is a basic human need and that the failed search for such meaning underlies much neurotic distress.

recursive anxiety An extreme form of social phobia that is based on the concept of fear of fear and the additional suggestion that a self-maintaining process contributes to the experience of excessive anxiety.

reframe A common therapeutic procedure that involves changing the valence of a reported event from negative to positive without changing the facts.

Although paradoxical intention has been popularly identified with Frankl's logotherapy, and with family therapy, more recently the procedure has gained some

favor with behavior therapists. As a behavioral strategy, it is typically presented as a directive by the therapist to an individual who is experiencing a problem associated with activity of the sympathetic nervous system—usually within a social context. For example, a person may complain about perspiring in public. In general, the behavioral difficulty is exacerbated by the anxiety about the effects of anxiety (i.e., fear of fear) and with the attempt to take voluntary control of this anxiety to avoid these unwanted effects. The paradoxical intention directive generally contains two elements common to most other paradoxical procedures: It is unexpected and counterintuitive (i.e., contrary to common sense) and it requires the individual to maintain the discomforting focal behavior as it is presently being experienced. Thus, an effected person might be told to seek as many opportunities as possible in which he or she might expect to perspire and, once in the situation, to try to become anxious and perspire.

I. DESCRIPTION OF TREATMENT

Paradoxical intention (PI) is one of a group of—not easily differentiated—techniques and strategies all of which are classified under the rubric of therapeutic paradox. It is an approach employed in a variety of schools of psychotherapy, especially family and Gestalt therapy—although its name was coined by Viktor Frankl whose use of the technique in logotherapy, an existential

approach to psychotherapy, predates these. This article is confined to its use as a behavioral procedure.

Paradoxical intention is generally employed with responses that are impeded by recursive anxiety—a concept associated with fear of fear. A typical example would involve individuals complaining of anxiety when giving a public address. If a behavioral analysis suggested that discomfort were associated exclusively with factors external to the speaker (e.g., the size of the audience, aspects of the attendees, effect of the speaker on those assembled), then conventional behavioral procedures would be appropriate (e.g., systematic desensitization *in vivo*). In contrast, if discomfort were largely related to internal factors associated with anxiety, then paradoxical intention would be the treatment of choice. A characteristic complaint would be “I am afraid that when giving a public address, I will become very anxious and my heart rate will increase to the point that I will have a heart attack.” The core instruction administered to such a client—provided within the context of a behavioral program, which would include procedures designed to support the paradoxical intervention—would be to make a presentation while focusing on, and attempting to augment, the most salient aspect of sympathetic activity—in this case, “try to increase your heart rate.”

The role of PI is that of assisting individuals with recursive anxiety to enhance their desired performance by circumventing the goal of remaining calm. To do this, clients are directed to enter those situations in which they experience recursive anxiety, focus on the most salient aspect of sympathetic discomfort, and attempt to augment that process. Then they are instructed to remain in the situation until they have regained their composure. Thus a person who is afraid of blushing in front of others at work would be asked to participate in as many of these discomforting circumstances as possible and “really try to blush—turn as red as a traffic light—become so bright red that people will have to turn away to avoid being blinded by the light.”

Naturally, a great deal of collateral work must be done to support these individuals in engaging in behavior that may at least be seen as dreadfully embarrassing and at most, life threatening. Frankl, and before him, Allport, discussed the role of humor in neutralizing anxiety. They believed that neurotic clients had taken a significant stride toward their therapeutic goals when they could laugh at their neurotic complaints. Frankl therefore considered humor to represent an important part of PI with respect to both its administration and its effectiveness. In fact, one of the components of PI that

is a necessary part of humor is the opposition to expectation: the element of surprise. Practically speaking, before individuals consult a psychotherapist, they generally seek formal and informal guidance from a variety of acquaintances, both nonprofessional and those in relevant professions (e.g., a family physician). The longer the problem is extant, the more advice and counseling they accumulate. They combine all this information with their own preconceived notions and bring the result to the therapist. The therapist, applying PI gives them instructions that are counter to that which they expect, that is, in essence: Remain the way you are, stop trying to change.

Of course, as with most therapeutic procedures, considerable rapport must first develop. In addition, the manifestation by the therapist of great confidence in the procedure is necessary. These are the very minimal aspects required to form a supporting basis for the successful use of PI in the behavioral approach to recursive anxiety. Finally, paradoxical procedures have commonly been employed to enhance cooperation. In this context, clients are generally not provided with information about the techniques. In contrast, PI when utilized as the behavioral treatment of choice for problems associated with recursive anxiety requires, like any conventional behavioral technique, that the therapist provide the client with as many details as possible regarding the operation of the procedure (e.g., suitability of PI for the specific problem, available research, the experience of the therapist with the procedure, full instructions on intersession self-administration). The client and therapist are seen as equally important members of the team that must first formulate and then administer treatment to a successful conclusion. Therefore, the client must be as informed as is the therapist.

II. THEORETICAL CONSIDERATIONS

The myriad descriptions of the effective use of paradoxical interventions as a group, and especially PI, that are replete throughout the literature of psychotherapy are accompanied by an equal abundance of explanations for this efficacy. Because the scope of this article does not permit a survey of these hypotheses, discussion is confined to an explanation of the operation of PI from a behavioral perspective. Within that context, PI is presented as the treatment of choice for behavior that is impeded by recursive anxiety.

Fear of fear refers to concern about possible negative physical effects of anxiety on oneself. This phenomenon

is typically associated not with all anxiety but with that experienced in specific locations or situations. Such an individual who is afraid of crowded places may notice an increase in cardiac rate at such times and can become afraid that the anxiety experienced under these circumstances will result in a rising cardiac rate that eventually reaches a level that produces a heart attack. So although most people with phobias attribute their anxiety to aspects of the external environment on which they remain focused, those with fear of fear shift their attention from external factors to internal stimuli and to the effects of anxiety on the functioning of certain physiological processes.

Recursive anxiety that is based on the concept of fear of fear adds two additional complications. The first concerns the sympathetic mechanism that maintains these individuals at a high level of anxiety. Suppose that circumstances require the person in the earlier example to participate in an event that involves a crowd. This individual will become apprehensive and will begin to focus on that aspect of the sympathetic syndrome that is of most concern. In the case of individuals who fear having a heart attack, that sympathetic component would be heart rate. As the time for the presentation draws near, anxiety will increase and the cardiac rate will be elevated. This in turn will be associated with a further increase in anxiety and a consequent additional elevation of the cardiac rate. The resulting pernicious circle is self-maintaining because it is based on this recursive process.

The second complication associated with recursive anxiety refers to observations of Michael Ascher, Tom Borkovec, Diane Chambless, and Alan Goldstein, among others, who have written about processes related to recursive anxiety. They have emphasized the significant role of social anxiety and have suggested that *in vivo* exposure to the social environment is of considerable importance. Ascher has further hypothesized that no matter what the person with recursive anxiety initially reports fearing—heart attack, passing out, losing bladder control, going crazy—the basic concern is loss of control. Such loss of control will result in emitting embarrassing behavior that will engender the negative evaluation of observers. The consequence will be a significant negative life change.

Individuals with recursive anxiety generally exhibit low-self esteem. They focus on what they believe to be substantial deficits in the qualities or skills necessary to maintain significant aspects of their lives. Because of their perceived inadequacies, people with recursive anxiety feel that they must depend on others for sup-

port and therefore place a great deal of importance on these interpersonal relationships.

At work, for example, affected people may attend to negative aspects of their skill, education, or performance profile, infusing these presumed inadequacies with disproportionate importance. They believe that by maintaining themselves in their positions they are perpetrating a fraud—no matter what evidence exists to the contrary. They, like Blanche DuBois, must rely on the kindness of strangers or, in this example, colleagues, both to assist them in the performance of their responsibilities and to maintain their—self-determined—fraudulent facade.

Thus, the person in our example who is anxious in crowds may be concerned that while participating in a business meeting at which the attendance of a large number of people is required, he or she will become very anxious and, fearing a heart attack, may run out of the room at an inopportune time. The horrible soap opera continues with all of those in attendance assuming that the departure had negative associations (e.g., “_____ was obviously psychotic.” or “_____ is certainly not “executive material” and should leave the firm”), and the CEO will demand resignation from their highly compensated position. In the final scene, the loss of this income and status results in the rapid deterioration of lifestyle, divorce, and finally descent into alcoholism and homelessness.

Because of their perceived dependency on these relationships, individuals with recursive anxiety will devote extraordinary effort to developing and nurturing associations with people deemed to have a significant role in their lives. They do this by advancing themselves as “nice” people and will do all that is necessary to support this perception. They believe that people who are “nice” are more likely to garner assistance when necessary and to have their shortcomings overlooked.

All individuals who perform goal-directed behavior have as their object the satisfactory achievement of the ostensible purpose of these actions. Those giving public addresses, for example, aim to educate or influence their audience in an entertaining manner. Or, supermarket shoppers wish to fill their grocery lists as efficiently as possible. Again, individuals driving across bridges simply want to get from one side to the other without encountering any difficulties or delays. Of course, those with recursive anxiety aim for the same goals as everyone else. However, they also have a second goal that is of more immediate concern: that of remaining calm while attempting to accomplish the ostensible goal.

They must remain calm to avoid the hypothesized disastrous consequence (e.g., heart attack, going crazy, looking foolish to others). This latter objective is difficult, if not impossible to accomplish. Moreover, in any case, attempts to remain calm subvert the professed aim of the performance by diverting the attention and effort necessary for accomplishing the ostensible goal.

Recursive anxiety represents a significant impediment over and above that resulting from simple phobias (i.e., those that are confined to aspects of the environment external to the individual). Thus people who exhibit simple public-speaking phobia are uncomfortable when giving a public lecture, but they remain largely concerned about the quality of their performance and direct their effort toward improving their presentation. Those with public-speaking phobia complicated by recursive anxiety initially attend to external aspects of their performance. But, at high levels of anxiety, they shift their focus to internal stimuli and begin to worry about the possibility of emitting some embarrassing behavior in front of an audience (e.g., freezing, vomiting, losing bladder control). They believe that this would be disastrous, and it therefore becomes vital that they remain free of anxiety to preclude this disaster. Remaining calm, then, becomes their primary commitment.

A number of hypotheses have been offered in an attempt to explain the efficacy of this procedure with recursive anxiety. Most recently, Ascher has advanced a proposal that combines his position on recursive anxiety with some of the formulations of Daniel Wegner. To understand Ascher's suggested explanation, it is first necessary to briefly describe Wegner's view of cognitive control.

Wegner describes the process of cognitive control by postulating a bimodal system. When individuals wish to exercise cognitive control (e.g., when there is a wish to inhibit specific classes of disconcerting, distracting thoughts in order to fall asleep or study or work on last year's taxes), activity on the part of the "operating" system (OS)—the active, effortful cognitive regulator—is initiated to ensure this control. A complementary "monitoring" system (MS) is an effortless component that is constantly searching for cognitions in opposition to the desired state of control. When the MS detects an errant thought it acts to bring this thought into the focus of attention of the OS and initiates the OS to control the incompatible cognition. In the normal individual, under ordinary circumstances, cognitive control by the OS generally occurs smoothly and effectively.

In contrast, when the person is under cognitive stress, the OS can become overloaded and increasingly

less effective. In addition, if sufficiently bereft of resources, the OS will be able to do nothing with the incompatible thought that has now been released into the individual's focus of attention. In this way, a thought that is in opposition to the specific goal of cognitive control is very likely to be expressed.

Ascher hypothesizes that the difference between individuals who experience phobias with and without a recursive anxiety component is that the former attempt to control their cognitive state, whereas the latter are more concerned with the characteristics of the external situation. In addition, when recursive anxiety is associated with the phobic system, the result is the development of a "fundamental" fear of a significant negative life change. This would seem to add a considerable degree of stress and, therefore, cognitive load, relative to those exhibiting a simple or "common" phobia.

Thus, individuals with a simple public-speaking phobia, for example, would be absorbed in monitoring and enhancing their performance while observing audience response to measure their success. In contrast, those with recursive anxiety complicating their public-speaking phobia would be engaged in controlling their cognitive environment. They would attempt this by monitoring their thoughts and related emotional experiences in an effort to minimize stimuli incompatible with their objective of remaining calm. The more significant they deemed this goal of calmness to be—this depends on the details of the hypothesized disastrous consequence—the more cognitive load is generated, and the weaker becomes the OS. The result would be an increasing frequency of incompatible thoughts brought by the MS to the attention of the powerless OS that would be permitted to remain unmodified. This bimodal explanation of cognitive control is also compatible with the self-maintaining recursive component of the fear-of-fear process. That is, awareness of incompatible, anxiety-provoking thoughts increases cognitive load and decreases the ability of the OS to control them, thus permitting further discomforting thoughts, additional cognitive load, and continuing deterioration of the OS.

Combining the bimodal explanation with PI suggests the utility of the procedure with recursive anxiety. Paradoxical intention is based on instructions—to relinquish control and to accept whatever cognitive and physical experiences are present, but primarily—to try to protract the duration and the degree of discomfort of the most unpleasant of these symptoms. In such cases, the MS would be engaged in seeking thoughts that are incompatible with the goal of attempting to generate

more profound discomforting symptoms—that is, thoughts of calmness and control, and also neutral, distracting thoughts. These cognitions enter the OS and become the focus of attention because these individuals begin their presentations with an already weakened OS. The thoughts that are incongruous with the PI are compatible with diminished stress and reduced cognitive load in situations that are uncomfortable for the individual with a public-speaking phobia and recursive anxiety. The result is a more positive experience for these affected individuals.

III. APPLICATIONS AND EXCLUSIONS

As a conventional behavioral procedure, PI for disorders associated with recursive anxiety and similar processes is appropriate for most groups of individuals. However, because of its counterintuitive nature, it may not be practical for those with cognitive developmental disabilities. At the very least, considerable repetition of instructions will be necessary. In addition, supervision of the *in vivo* practice conducted by family members, or others, can be a valuable adjunct to therapy and increase the probability of success with this population.

Although a careful behavioral analysis is the necessary preparation for the administration of any behavioral program, when the therapeutic program includes PI as its central focus, the behavioral analysis takes on an even more crucial role. As Ascher has written on several occasions, and demonstrated in his recent study with public-speaking phobia (described in the next section), it is important to differentiate between those experiencing simple phobias and those whose phobias are complicated by recursive anxiety. Simple phobias are adequately addressed by systematic desensitization, and covert conditioning, among a host of conventional behavioral strategies. But, the use of PI with simple phobias has been shown not only to be less useful than the established treatments of choice, but actually to impede the course of therapy and thereby protract its length in many cases.

In contrast, when the phobia is complicated by recursive anxiety, then PI becomes the treatment of choice, behavioral procedures devoid of the *in vivo* exposure to the interpersonal milieu tend to provide less satisfactory results.

Finally, it seems almost unnecessary to caution against the use of paradoxical procedures with individuals who are severely depressed or suicidal or with

those attempting to control maladaptive approach responses (e.g., sexually offensive behavior, difficulties with alcohol, drugs, or tobacco).

IV. EMPIRICAL STUDIES

Since Viktor Frankl began writing about PI in the 1920s, many case studies have been published demonstrating its effectiveness with a wide variety of behavioral problems. Of course, uncontrolled case studies are of very limited value, at best.

In 1978, Michael Ascher and Jay Efran published the first controlled investigation of the procedure. They used a multiple-case study design with clients whose latency to sleep onset did not diminish as the result of a standard 10-week behavior therapy program appropriate for this problem. Subsequent to this 10-week segment, these clients were exposed to PI instructions. By the end of the next 2-week period, all clients reported that their sleep onset latency had reached a satisfactory level.

Rather than presenting an exhaustive review of the numerous experiments that followed the work of Ascher and Efran, many based on designs incorporating sophisticated controls, this section is intended to present a survey of studies that exemplify the research associated with paradoxical intention.

The first study to utilize the random assignment of subjects to groups in testing the efficacy of paradoxical intention was conducted in 1979 by Ralph Turner and Michael Ascher. In this study, PI was compared to two treatments of choice for reducing clinically significant levels of latency to sleep onset (relaxation, stimulus control). Two control groups were also included (attention-placebo and waiting-list). Analysis of the results failed to find any significant differences among the three treatment groups, each of which was significantly superior to the control groups. No differences were found between the two control groups. In a partial replication of their study, Ascher and Turner in 1979 confirmed the efficacy of PI with sleep onset insomnia.

When administered like any conventional behavioral technique, all aspects of the procedure and its goals are fully disclosed to the client. However, when used in other contexts (e.g., family therapy) this is not always the case. Then, PI, used to reduce resistance, is presented in a more obscured manner. In 1980, Ascher and Turner investigated the relationship of these two methods for administering PI. They randomly assigned volunteers who complained of clinically significant levels

of sleep onset insomnia to all groups. These conditions included two treatment groups (PI with veridical or obfuscated instructions) and two control groups (attention-placebo and waiting-list). Clients receiving the veridical instructions showed significantly greater treatment effects than did the group from whom the purpose of the procedure was obscured.

Ascher went on to conduct controlled multiple-case study investigations of PI with the travel restriction associated with agoraphobia and with psychogenic urinary retention. The results of these studies supported the hypothesis that PI, when administered as a conventional behavioral procedure, could be an effective component of a treatment program.

Subsequent to Ascher's study, Matig Mavissakalian, Larry Michelson, and a number of co-workers conducted a series of large-sample randomized groups experiments. Their target behavior was agoraphobia, and one of the treatment strategies in which they were interested was PI. This research extended from 1983 through 1986 and produced variable results with all treatment groups. One conclusion that might have been drawn from their final study was that although randomized assignment of clients to groups was a powerful method of control, it might have distorted the actual relationship of the treatment with the specific clinical profile of the client. That is, were a clinician to assign individuals with agoraphobia to treatment groups following a behavioral analysis, the results might have been more consistent, and of more benefit to the individual. Such clinically focused assignment might also reduce the variability of the resulting treatment data.

In 1999, Ascher tested this hypothesis with groups that had public-speaking phobias. Using a 2x2 design, he randomly assigned individuals with a simple phobia or with a phobia complicated by recursive anxiety to one of two treatment groups. One treatment condition involved a standard behavioral approach to public-speaking phobia, the other, added PI to the standard behavioral program. The results supported the idea that a better outcome was possible when clients are paired with treatment on the basis of clinical criteria as opposed to random assignment. Those with simple public-speaking phobia showed significantly greater improvement when the standard behavioral treatment program did not include PI. When this technique was added, the course of therapy was greatly protracted. The reverse was the case with clients exhibiting recursive anxiety. When their treatment included PI, their performance improved significantly relative to those

who did not receive PI instructions. Of course, this selective assignment is fraught with design problems that can only be adequately addressed with sophisticated controls. However, a more valid picture of clinical operations may possibly be the outcome.

The body of research investigating the efficacy of PI from Ascher and Efran's study in 1978 through the mid-1980s grew in frequency and in sophistication of design. It generally suggested that PI was an effective procedure with a variety of behavioral complaints. The results were not uniform, nor were they based on designs that were above criticism. The data do support the impression that in the hands of an experienced clinician, PI viewed as a conventional behavioral procedure can be a useful and effective addition to the behavior therapist's repertoire.

V. CASE ILLUSTRATION

A 30-year-old, married, white male complained of becoming anxious and experiencing tremors at inopportune times. He was a psychologist who worked in the student health center of a private university. Each morning all members of the counseling section were required to participate in a meeting whose general focus was case presentation and case management. During the course of these meetings, coffee and cake were available; the coffee was served in ceramic cups on saucers (it was a well-endowed university). It was under these daily circumstances that the client experienced the most disconcerting occurrence of the problem.

He was afraid that if he were experiencing tremors when he removed his cup from the saucer, the resulting tapping would be noticed by others. On the basis of this behavior, the other members of the counseling team would conclude that the client had a serious mental health problem that would preclude him from continuing to work in the center. This information would become available to those in the mental health field at large, and he would be permanently denied employment in his profession.

He had been at the student health center for more than one year. He enjoyed his work and seemed to be doing well. He was popular with his student clients, had been commended by his supervisor on several occasions, and appeared to have the respect of his colleagues. Yet he felt that he could not quite meet the standard that was expected by these colleagues. As he explained it, this deficit was because all the professionals in the center had degrees in clinical psychology

whereas his was in counseling psychology—which he deemed to be inferior.

Each workday he would be awakened early by what he described as an anxiety attack. He would monitor himself for tremors, squeezing his hands tightly into fists or around objects in an effort to moderate these attacks. His anxiety would remain fairly high until he entered the conference room for the morning meeting, whereupon his anxiety would increase markedly. Along with the anxiety would appear sporadic, mild intention tremors. His thoughts would shift from strategies for dealing with these tremors to their catastrophic consequences. He attended most meetings and did not generally leave before their conclusion. However, each meeting was an ordeal that never seemed to diminish.

Because the social phobic component of these complaints was immediately manifest and clear to the client, a good deal of the preparation generally necessary with cases involving recursive anxiety was precluded. The PI instructions are greeted by most people as counterintuitive and anxiety provoking. They are not only told to do something that may be in opposition to what they thought would be useful but are directed to do exactly what they fear. Here again, the client's professional training proved to be helpful. He was able to grasp the reason for the paradoxical suggestion and, rather than viewing it as counterintuitive, could understand its underlying logical structure.

With the assistance of the client, the therapist composed a hierarchy of anxiety-provoking, social situations. Emphasis was placed on those circumstances in which the client had experienced tremors or feared that he might have such an experience. Of course, the top of the hierarchy was occupied by the daily clinic meetings. The client was then encouraged to enter a situation that was of a lower degree of discomfort and to "try to become anxious. Practice exhibiting your tremors." He was not to exaggerate them, but to attempt to display them as realistically as possible. He first practiced them in the office but had a great deal of trouble making the tremors look realistic. They were jerky and spastic, and he devoted considerable effort to producing authentic tremors that, in so doing, served to create a good deal of attendant entertainment for both the client and the therapist. The client left the office in apparent good spirits and with a professed sense of confidence based on his new perspective.

On returning the following week, the client reported that he had practiced the procedure in a social situation, midway on the hierarchy, and he indicated his pleasure with his performance. He went with the expectation of acting as though he had tremors, he felt

quite calm, and found it difficult to produce them in a realistic fashion.

It is important when using PI with recursive anxiety that the therapist not reinforce clients for success, because an effusive response on the part of the therapist will generally serve to impede progress. The reasons for this vary with the client. One common possibility is that it places additional pressure on acquiescent clients to meet what they consider to be the expectations of their therapists. The safest thing for the therapist to do is to reflect clients' positive emotion associated with their demonstration of efficacy. In this way, the therapist can remain relatively neutral and thereby reduce his or her role in client's *in vivo* activities. In the present case, the therapist encouraged the client to discuss his uncharacteristic comfort in the party that he had attended, and how it contributed to his enjoyment of the evening. In another effort not to bring the client's expectations to an unrealistic level, the therapist cautiously introduced the point that the client still had a good deal of work to do in this area, and that although it was pleasant that he was able to begin with a successful experience, impediments and setbacks were certain to appear sporadically. The instructions were repeated, and the client selected his next target.

During the next three sessions, the client continued to report improvement, but on the fourth session, he described an encounter that resulted in considerable anxiety and what the client described as a failure. The therapist reframed the event to support a more positive view and suggested that perhaps the client went into the situation with too much confidence. Possibly he was not prepared to allow his anxiety-free reign and to display his tremors. Maybe he thought that he was "cured" and was no longer in need of such preparation. The therapist reaffirmed the idea that the client should assume that he would be employing the paradoxical strategy in social situations for a considerable length of time. This seemed to have the desired effect, because the client's progress in dealing with his social anxiety resumed its positive trend in subsequent weeks.

With regard to his comfort during the morning meetings at the student counseling center, the client began to feel more comfortable after his first reported success in another social context. For some time, however, he was unwilling to take the chance of "trying to become anxious" in that most difficult setting. Finally, after some weeks, having gained some confidence in the PI procedure, and experiencing somewhat less anxiety at these morning meetings, he began to apply the procedure in the counseling center and found it to be quite helpful.

The focus of this case description was intended to rest on the administration of PI with recursive anxiety. Naturally, substantial ancillary activity was necessary to support the paradoxical intervention. In addition, other significant aspects of the client's life were addressed. Very often in the past, case studies illustrating the efficacy of PI emphasized this procedure to the point that its role in the therapeutic process was unrealistically exaggerated. PI as a conventional behavioral treatment of choice for recursive anxiety is, like other behavioral procedures, administered in an appropriate behavioral context.

VI. SUMMARY

Paradoxical intention as described in this article is a conventional behavioral treatment of choice for recursive anxiety—a phenomenon associated with fear of fear that reflects extreme social anxiety. Individuals who complain of anxiety about exhibiting the secondary aspects of anxiety in public (e.g., flushing, perspiration, tremors, urinary frequency or retention) represent good examples of this behavior. The paradoxical instruction, administered within the context of a standard behavioral program, requires clients to increase the frequency of that which they would prefer to inhibit, or to inhibit that which they would prefer to increase. Thus, a woman who has been avoiding public places for fear of being embarrassed by blushing would

be advised to seek as many opportunities as possible to blush in front of others. Such suggestions often have the effect of reducing some of the anxiety that the person associates with interpersonal contact.

See Also the Following Articles

Family Therapy ■ Gestalt Therapy ■ Logotherapy

Further Reading

- Ascher, L. M. (1989). *Therapeutic paradox*. New York: Guilford Press.
- Frankl, V. E. (1975). Paradoxical intention and dereflection. *Psychotherapy: Theory, Research and Practice*, 12, 226–237.
- Frankl, V. E. (1985). Logos, paradox, and the search for meaning. In M. J. Mahoney & A. Freeman (Eds.), *Cognition and psychotherapy* (pp. 259–277). New York: Plenum.
- Haley, J. (1973). *Uncommon therapy: The psychiatric techniques of Milton H. Erickson, M.D.* New York: Norton.
- Seltzer, L. F. (1986). *Paradoxical strategies in psychotherapy: A comprehensive overview and guidebook*. New York: John Wiley and Sons.
- Watzlawick, P., Weakland, J., & Fisch, R. (1974). *Change: Principles of problem formulation and problem resolution*. New York: Norton.
- Weeks, G. R., & L'Abate, L. A. (1982). *Paradoxical psychotherapy: Theory and practice with individuals, couples, and families*. New York: Brunner/Mazel.
- Wegner, D. M. (1994). Ironic processes of mental control. *Psychological Review*, 101, 34–52.

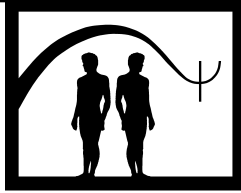

Parent–Child Interaction Therapy

Brendan A. Rich, Jane G. Querido, and Sheila M. Eyberg

University of Florida

- I. Description of Treatment
- II. Theoretical Bases
- III. Empirical Studies
- IV. Summary
- Further Reading

PCIT, which draws from both attachment theory and social learning theory in teaching parents to interact with their child in new ways to change the child's behavior. Finally, we review the PCIT outcome studies and the directions for future research.

GLOSSARY

clinically significant The extent to which the effect of an intervention makes an important difference to the individual or has practical or applied value.

negative reinforcement The removal of a negative stimulus (e.g., child whining) contingent on the occurrence of a behavior (e.g., parent yelling), which causes the behavior to occur more often.

prevalence rate Percentage of cases in the general population at one time.

Parent–child interaction therapy (PCIT) is a psychosocial treatment for preschoolers with conduct problems and their parents. In this article we describe the assessment procedures that guide the course of treatment and the treatment procedures in each major phase of treatment: (1) the child-directed interaction (CDI) phase in which parents learn play therapy skills, and (2) the parent-directed interaction (PDI) phase in which parents learn discipline skills. We address the significance of conduct problem behavior for children and families and present the theoretical foundation of

I. DESCRIPTION OF TREATMENT

A. Assessment in PCIT

Parent–child interaction therapy is an assessment-based treatment in which progression through treatment is guided at every point by the data. To begin treatment, the PCIT therapist must have a thorough understanding of the child's problem behaviors and the context in which they occur. This information is obtained by an assessment approach that involves multiple methods and informants, including parent interviews, parent and teacher ratings scales, and behavioral observations in the clinic and school or day care setting.

The initial clinical interview with the parent is designed to establish rapport and obtain information about the child's family that will impact treatment planning, including the parents' attitudes and beliefs about child rearing and their goals and expectations for treatment. Family factors known to present barriers to treatment, such as transportation problems for low-income families, are discussed with the family as well, so that they can be resolved immediately. Following the clinical

interview, a structured diagnostic interview is conducted to determine whether the child meets criteria for oppositional defiant disorder. Children whose behavior problems are less severe may not require a treatment as intensive as PCIT. The diagnostic interview is also important for the identification of comorbid disorders that must be considered in tailoring PCIT to the specific needs of the child and family.

The Eyberg Child Behavior Inventory (ECBI) is a 36-item parent rating scale of disruptive child behavior used initially as a baseline measure and regularly throughout PCIT to assess the child's progress. Richard Abidin's parent self-report scales, the Parenting Stress Index—Short Form and the Parenting Alliance Measure, are given as baseline measures at the initial assessment session as well, to enable assessment of the effects of treatment on the parents' functioning.

The Dyadic-Parent Child Interaction Coding System-II, developed by Sheila Eyberg and colleagues, is used to assess parent–child interactions during three brief, structured play situations in which the degree of control required by the parent is varied. These initial observations provide baseline data for comparison throughout treatment, and specific situations are coded at the beginning of the treatment coaching sessions to monitor change in the parents' skills, to provide direction for the coaching, and to determine when the parents are ready to move to the next phase of treatment.

For children who present behavior problems at school or day care as well as at home, their teachers are asked to complete the Sutter-Eyberg Student Behavior Inventory—Revised, a measure of oppositional and inattentive behavior in the classroom. In addition, classroom observations are often conducted to assess disruptive behavior using the Revised Edition of the School Observation Coding System (REDSOCS). These measures are repeated at the end of treatment to assess the degree of generalization of treatment effects to the school.

B. The Format of PCIT

Treatment sessions begin as soon as the initial assessment is completed. PCIT is typically conducted in 1-hour weekly sessions and is usually completed within 9 to 16 weeks. The first phase of treatment, CDI, is focused on developing the parents' use of prosocial skills, and the second phase of treatment, PDI, emphasizes the parents' use of consistent disciplinary techniques. The principles and skills of each interaction are first presented to the parents alone during a single didactic session using modeling and role-play, and the subsequent sessions in each phase involve direct coaching of

the parents to use the skills with their child. During these coaching sessions, the parents take turns being coached by the therapist as they interact with their child while the other parent observes the coaching.

1. Child-Directed Interaction

In CDI, parents learn to follow their child's lead in play by avoiding commands, questions, and criticism, and using the nondirective "PRIDE" skills: Praising the child, Reflecting the child's statements, Imitating the child's play, Describing the child's behavior, and being Enthusiastic during the play. The parents learn to manage the child's behavior by directing the PRIDE skills to the child's appropriate play and ignoring the child's inappropriate behavior. Parents are asked to practice CDI skills at home for 5 minutes each day. Handouts summarizing the CDI skills are given to parents for their review (see Table 1), and additional handouts on topics of relevance to individual families, such as social support or modeling appropriate behavior, are provided to parents during the course of CDI as needed.

Each of the CDI coaching sessions begins with a 5-minute observation of the interaction, coded by the therapist, which indicates the primary focus of the session. During coaching, the therapist prompts and reinforces the parents' use of the PRIDE skills and points out their positive effects on the child's behavior. The therapist uses this time to encourage and shape reciprocal interactions and responsive parenting. The CDI phase of treatment continues until the parents meet criteria for skill mastery: 10 behavioral descriptions, 10 reflective statements, 10 labeled praises, and no more than 3 questions, commands, or criticisms within the 5-minute interval. The criteria also include ignoring the child's inappropriate behavior.

2. Parent-Directed Interaction

During PDI, parents continue to use their CDI skills, but they also learn to direct their child's behavior using effective commands and specific consequences for compliance and noncompliance. Parents first teach the child to mind using "running commands," which are commands to perform a specific behavior immediately. Parents are taught the eight rules of effective commands (see Table II) and the precise steps that must be followed after a running command is given to the child (see Fig. 1). Parents are taught to give a labeled praise if the child obeys or to initiate the time-out procedure if the child disobeys.

During the PDI didactic session, the entire time-out procedure is role-played with each parent, and the parents are asked to review handouts summarizing PDI techniques prior to the next session. Parents are

TABLE I
CDI Skills Handout

Child		
Rules	Reason	Examples
Praise your child's appropriate behavior	<ul style="list-style-type: none"> • Causes your child's good behavior to increase • Lets your child know what you like • Increases your child's self-esteem 	<ul style="list-style-type: none"> • Good job of putting the toys away! • I like the way you're playing so gently with the toys.
Reflect appropriate talk	<ul style="list-style-type: none"> • Shows your child that you are listening • Demonstrates that you accept and understand your child • Improves your child's speech 	<ul style="list-style-type: none"> • Child: The doggy has a black nose. • Parent: The dog's nose is black.
Imitate appropriate play	<ul style="list-style-type: none"> • Shows your child that you approve of the activity • Shows that you are involved • Teaches your child how to play with others and take turns 	<ul style="list-style-type: none"> • Child (drawing circles on a piece of paper) • Parent: I'm going to draw circles on my paper just like you.
Describe appropriate behavior	<ul style="list-style-type: none"> • Shows your child that you are interested • Teaches your child concepts • Models speech for your child • Holds your child's attention on the task 	<ul style="list-style-type: none"> • You are putting together Mr. Potato Head. • You put the girl inside the fire truck.
Be Enthusiastic	<ul style="list-style-type: none"> • Lets your child know that you are enjoying the time you are spending together • Increases the warmth of the play 	<ul style="list-style-type: none"> • Parent: You are REALLY being gentle with the toys.
Avoid Commands	<ul style="list-style-type: none"> • Takes the lead away from your child • Can cause unpleasantness 	<p><i>Indirect commands:</i></p> <ul style="list-style-type: none"> • Could you tell me what animal this is? <p><i>Direct commands:</i></p> <ul style="list-style-type: none"> • Please sit down next to me.
Avoid Questions	<ul style="list-style-type: none"> • Leads the conversation • Many questions are commands and require an answer • May seem like you are not listening to your child or that you disagree 	<ul style="list-style-type: none"> • We're building a tall tower, aren't we? • What sound does the cow make? • What are you building? • You're putting the girl in the red car?
Avoid Criticism	<ul style="list-style-type: none"> • Often increases the criticized behavior • May lower your child's self-esteem • Creates an unpleasant interaction 	<ul style="list-style-type: none"> • That wasn't nice. • I don't like it when you make that face. • Do not play like that. • That animal doesn't go there.
Ignore negative behavior (unless it is dangerous or destructive)	<ul style="list-style-type: none"> • Helps your child to notice the difference between your responses to good and bad behavior • <i>Consistent</i> ignoring decreases many behaviors 	<ul style="list-style-type: none"> • Child: (sasses parent and picks up toy) • Parent: (ignores sass; praises picking up)
Stop the play time for aggressive and destructive behavior	<ul style="list-style-type: none"> • Teaches your child that good behavior is required during special play time • Shows your child that you are beginning to set limits 	<ul style="list-style-type: none"> • Child: (hits parent) • Parent: (CDI STOPS.) Special play time is stopping because you hit me.

TABLE II
Eight Rules for Effective Commands

Rule	Reason	Examples
1. Commands should be <i>direct</i> rather than indirect	<ul style="list-style-type: none"> Leaves no question that child is being told to do something Does not imply a choice or suggest parent might do the task for child. Is not confusing for young children 	<ul style="list-style-type: none"> Please hand me the block. Put the train in the box. <i>instead of</i> Will you hand me the block? Let's put the train in the box.
2. Commands should be <i>positively stated</i>	<ul style="list-style-type: none"> Avoids criticism of child's behavior Provides a clear statement of what child should do 	<ul style="list-style-type: none"> Come sit beside me. <i>instead of</i> Don't run around the room!
3. Commands should be given <i>one at a time</i>	<ul style="list-style-type: none"> Helps child remember the command Helps parent determine if child completed entire command 	<ul style="list-style-type: none"> Put your shoes in the closet. <i>instead of</i> Put your shoes in the closet, take a bath, and brush your teeth.
4. Commands should be <i>specific</i> rather than vague	<ul style="list-style-type: none"> Permits child to know exactly what is to be done 	<ul style="list-style-type: none"> Put this lego in the box. <i>instead of</i> Clean up your room.
5. Commands should be <i>age-appropriate</i>	<ul style="list-style-type: none"> Makes it possible for child to understand the command 	<ul style="list-style-type: none"> Draw a square. <i>instead of</i> Draw a hexagon.
6. Commands should be given <i>politely and respectfully</i>	<ul style="list-style-type: none"> Increases likelihood child will listen better Teaches child to obey polite and respectful commands Avoids child learning to obey only if yelled at 	<ul style="list-style-type: none"> Child: (Banging block on table) Parent: Please hand me the block. <i>instead of</i> Parent: (Said loudly) Hand me that block this instant!
7. Commands should be explained <i>before</i> they are given or <i>after</i> they are obeyed	<ul style="list-style-type: none"> Avoids encouraging child to ask "why" after a command as a delay tactic Avoids giving child attention for not obeying 	<ul style="list-style-type: none"> Parent: Go wash your hands. Child: Why? Parent: (Ignores, or uses time-out warning if child disobeys). Child: (Obeyes) Parent: Now your hands look so clean! It is so good to be all clean when you go to school!
8. Commands should be used <i>only when necessary</i>	<ul style="list-style-type: none"> Decreases the child's frustration (and the amount of time spent in the time-out 	<ul style="list-style-type: none"> Child: (Running around) Parent: Please sit in this chair. (Good time chair)to use this command) <i>instead of</i> Parent: Please hand me my glass from the counter. (Not a good time to use this command)

Copyright Sheila Eyberg, 2000.

instructed to spend the following week faithfully practicing their CDI skills at home, so that the child's first "time-outs from CDI" will be especially salient. Parents are coached through their first PDI with the child in the clinic so that the therapist will be avail-

able to provide the parents with emotional support during the initiation of the time-out procedure.

As the family progresses in PDI, the child's rate of compliance increases rapidly. Parents' homework assignments gradually expand their use of running com-

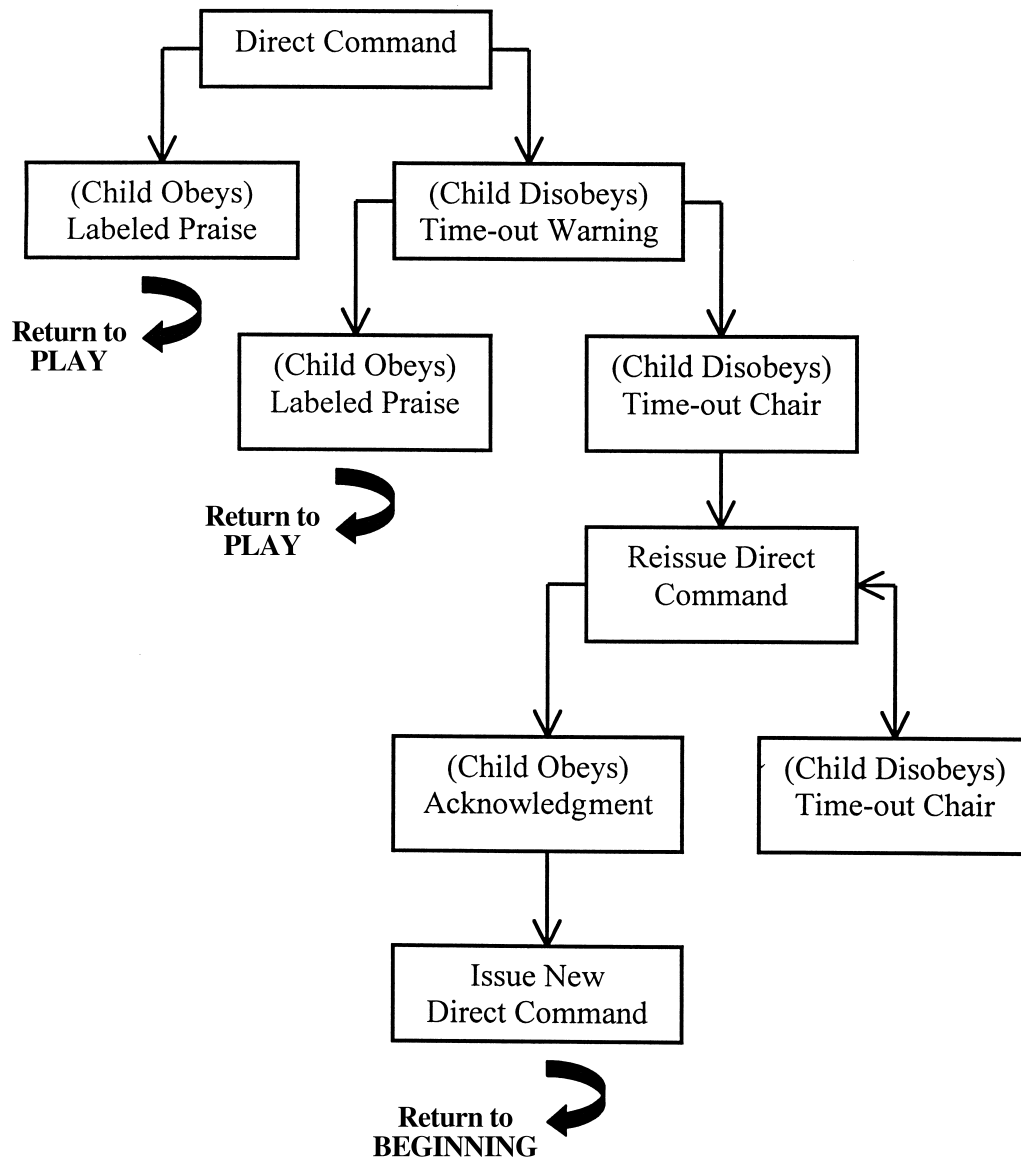

FIGURE 1 Parent-directed interaction diagram. (Copyright Sheila Eyberg, 2000).

mands to address specific problems that were identified during the assessment. For example, to encourage the child's use of words to indicate wants, the parent might give a command directing the child to say the name of the object the child is pointing to, and then follow the child's compliance with an enthusiastic labeled praise that explains the reason that the behavior is important, such as, "Nice job of using your words! Now that I know you want me to hand you the hat, I can give it to you really fast without guessing."

3. House Rules

As they progress in PDI, parents frequently want help with their child's aggressive behavior that is not decreased by parental ignoring and is not easily corrected with running commands. After a child's compliance to running commands is under control, parents may be introduced to the house rules procedure, which is a "standing command" variation of PDI. In teaching this procedure, parents are instructed first to label the target behavior problem for the child for 3 days to en-

sure that the child is aware of the label and the specific behavior it refers to, before a house rule to decrease that behavior is put into effect. For example, each time the child hits another person, the parent would say "You are hitting. Starting on Sunday, each time you hit, you will go to time-out." Once a house rule is in effect, the parent must use the time-out procedure when the targeted behavior occurs and must praise the child for behaviors incompatible with the target behavior, for example, "Good job of keeping your hands to yourself when she messed up your track." Parents keep a record of each house rule and the daily frequency of rule violations so that the effectiveness of the technique can be evaluated by the therapist. A new house rule may be added when the child shows improvement in an earlier target behavior, although a child should have no more than two active house rules at a time.

4. Public Behavior

Toward the end of PDI, another problem that may remain for some children is disruptive behavior in public places. To apply the PCIT principles to this situation, parents are advised to describe to the child their expectations for the child's behavior prior to entrance into the public area. Parents are then prompted to think of ways to give positive attention to the child's appropriate public behavior and ways to implement a time-out procedure for unacceptable behavior that cannot be ignored. The parent is given the opportunity to practice the new strategy with coaching as the therapist accompanies the family to public areas, such as a waiting room or parking lot.

Mastery of the PDI skills is demonstrated during clinic observations when 75% of the parents' commands are effective commands that allow the child time to obey, and when the parent follows through correctly at least 75% of the time after the child responds to a command, either with praise after compliance or initiation of time-out after noncompliance. The final PCIT session includes specific discussion of ways to maintain treatment gains and methods to deal with setbacks or new problems that arise in the future.

5. Follow-Up

Follow-up strategies are important to ensure the maintenance of parenting skills and the child's improved behavior. Maintenance techniques range from letters from the therapist reminding the family of the importance of daily practice sessions, to booster sessions in the clinic. One promising model of maintenance treatment currently under empirical study is an aftercare model in

which the therapist continues contact with the parent with short, monthly telephone calls to monitor maintenance and determine the level of intervention indicated, if any. Three levels of intervention are used during the maintenance period, with Level 1 consisting of supportive services. A Level 2 intervention includes the components of Level 1 in addition to the implementation of a problem-solving approach for an identified problem. A Level 3 intervention is a clinic session and is indicated for significant problems or crisis situations. The components of a Level 3 intervention include support, problem solving, clinic observations of parent-child interactions followed by coaching, and the development of a plan for problem resolution. The goal of the maintenance model is to monitor treatment gains and intervene immediately at the first sign of new or recurrent problems so as to prevent relapse.

II. THEORETICAL BASES

A. Conduct Problem Behavior in Preschoolers

In young children, the prevalence of clinically significant conduct problems is thought to be rising. Recent studies have found as many as 23% of preschool children in the general population score in the clinically significant range on parent-rating scales of externalizing behavior problems. Not surprisingly, conduct problems are the most common reason for referral to child mental health services.

Although once dismissed as a transient phase of children's development, we now know that, without treatment, conduct problem behavior that begins in early childhood tends to persist and worsen with time. Evidence indicates that early parent-child interactions have a powerful influence on the development of conduct problems, particularly in children with difficult temperaments, and parenting practices continue to play an important role in the maintenance of conduct problem behavior throughout the child's development. Fortunately, evidence has also shown that parent training interventions with young conduct-disordered children can reverse their behavior and may produce lasting change.

Parent training programs for young children with conduct problems have historically taken either a relationship enhancement approach, as exemplified by Bernard Guerney in 1964, or a behavioral approach, as exemplified by Robert Wahler in 1965. In relationship enhancement therapies, parents are trained to use

nondirective play therapy techniques to strengthen the parent–child bond, foster greater independence and self-acceptance on the part of the child, and increase parental acceptance of the child. In contrast, behavior therapies train parents in the application of learning principles to alter specific child behavior problems. In 1969, Constance Hanf developed a behavioral model of therapy that focused on coaching parents *in vivo* as they played with their child. Her treatment consisted of two stages, in which parents were first taught to change their child's behavior by using differential social attention, which involves ignoring inappropriate behavior and attending to positive behavior. In the second stage, parents were trained to change their child's behavior by giving direct commands, praising compliance, and punishing noncompliance with time-out.

Parent–child interaction therapy is a parent–child treatment for young children with behavior problems that places a dual emphasis on relationship enhancement and behavioral parent management training. The goal of PCIT is to create a nurturing, secure relationship by teaching parents to increase their child's prosocial behaviors while decreasing their child's inappropriate behaviors. Like the Hanf model, PCIT includes two primary phases in which parents are coached in the treatment skills as they play with their child. Goals of the first phase, CDI, are to strengthen the parent–child relationship, increase positive parenting, and increase child prosocial behavior. Goals of the second phase, PDI, are to decrease child noncompliance and defiance by improving parents' ability to set limits and be fair and consistent in disciplining their child. PCIT is most distinct from the Hanf model in its emphasis on teaching parents to use traditional play therapy techniques and the skills of reciprocal interaction in the first phase, and, in the second phase, on teaching parents to use problem-solving skills to apply general discipline paradigms to problem behavior, with an overarching objective to improve the quality of parent–child interactions.

B. Theoretical Underpinnings of PCIT

PCIT draws on both attachment and social learning theories. Children's optimal emotional, behavioral, and social development is enhanced by a secure, stable attachment and healthy interaction patterns with their parents. Attachment theory asserts that attentive and sensitive parenting during infancy leads children to develop a cognitive-affective model that their parents will be responsive to their needs. Children whose parents

are cold, distant, and unresponsive to their child's needs are likely to develop a maladaptive attachment with their parents and peers, display increased aggression, and have poor self-esteem, coping skills, and social competence. The CDI emphasizes responsive parenting to establish or strengthen a secure attachment relationship as the foundation for establishing effective child management skills.

Gerald Patterson's coercion theory also provides a transactional account of early disruptive behavior in which children's conduct problems are inadvertently established or maintained by negative reinforcement in the parent–child interaction. Dysfunctional interactions must be interrupted by a change in parent behavior involving clear limit-setting that is consistently enforced early in the child's life. PDI incorporates these social learning principles by teaching parents a highly structured algorithm of positive and negative consequences to follow once they have issued a command or set a rule in place.

III. EMPIRICAL STUDIES

Parent–child interaction therapy outcome research has demonstrated significant findings in the treatment of conduct-disordered behavior of preschool children, including improvements in children's behavior at the end of treatment on parent and teacher rating scales and direct observation measures and significant changes on parents' self-report measures of psychopathology, personal distress, and parenting locus of control. Important changes in the interactional styles of fathers and mothers in play situations with the child, such as increased reflective listening, physical proximity, and decreased criticism have also been demonstrated at treatment completion. Treatment effects have been found to generalize to the school setting and to untreated siblings. Comparison studies have found PCIT superior to wait-list control groups and other treatments including parent group training.

Several studies have addressed the issue of maintenance of behavioral improvements following completion of PCIT by examining the short- and long-term recurrence of conduct problems for study participants in later childhood. In a study conducted by Toni Eisenstadt and her colleagues in 1993, short-term maintenance of treatment effects for 14 families was found on parent ratings of behavior problems, activity level, and maternal stress, and observational measures of parenting skills and child compliance. Two years later, 13 of

these families were located for follow-up, and 9 (69%) of these families had maintained treatment gains on measures of behavior problems, activity level, and parenting stress at the same level as found at the end of treatment. Most of the children (7 of 13 or 54%) also remained free of diagnoses of disruptive behavior disorders. Recently, maintenance of treatment gains in child behavior and parenting confidence at 4 to 6 years after treatment have been found.

Daniel Edwards and colleagues examined differences in long-term outcomes between 23 PCIT dropouts and 23 PCIT completers. Ten to 30 months after their pre-treatment assessment, mothers of children who dropped out of PCIT reported significantly more symptoms of the disruptive behavior disorders and higher levels of parenting stress than did those who completed treatment. The follow-up scores for dropout families showed no differences from their scores before treatment started, whereas follow-up scores for the families who completed treatment showed no differences from their scores at the end of treatment. These data suggest that PCIT can alter the developmental path of disruptive behavior for those young children and families who complete treatment, and they also highlight the problem of attrition.

Addressing attrition must become a research priority. The rate of attrition from PCIT has ranged from 0 to 32% in recent studies, which compares favorably to the average 40% to 60% attrition rate typically found in child clinic samples. Neither the poorest families nor the children with the most severe problems drop out more than other families, but maternal distress has been identified as a significant predictor of dropout from PCIT. Such findings indicate the necessity of addressing broader contextual issues in treatment to prevent attrition in the high-stress families of conduct-disordered children. In particular, attention to the parents' personal concerns will need even greater emphasis in PCIT.

Further attention to treatment maintenance is a second research priority. Although long-term maintenance of PCIT effects has been documented, the effects of treatment do not last for every family. Given the persistent and recurrent nature of early-onset conduct disorder, it may be unrealistic to expect that the current models of short-term treatment, which end immediately on initial resolution of the presenting problems, will lead to lasting changes in child and family behavior as the child develops and the family faces new challenges. In addition to testing promising models of maintenance treatment, it will be important to examine both the course and the predictors of long-term maintenance to identify the factors related to long-term be-

havior change, which will help in designing more effective interventions for all families.

IV. SUMMARY

Parent-child interaction therapy is a treatment for preschool-age children with conduct problems and their families. This treatment is theoretically based, assessment driven, and empirically supported. During PCIT sessions, parents play with their child while the therapist coaches them to use specific skills to change their child's behavior. In the first phase of treatment parents learn the CDI skills, designed to strengthen the parent-child attachment relationship and to increase positive parenting and the child's prosocial behavior. In the second phase, parents learn the PDI skills, designed to decrease child noncompliance and aggression by improving parents' ability to set limits and be fair and consistent in disciplining. Treatment ends when parents demonstrate mastery of these relationship enhancement and child management skills with the child and report that the child's behavior problems are within normal limits on standardized measures. Studies have clearly demonstrated the effectiveness of PCIT in decreasing disruptive behavior and increasing prosocial behavior of the child and improving the psychological functioning of the parents. The early long-term follow-up studies suggest that the changes seen at the end of treatment tend to last for most children and families, although further study of both maintenance and attrition is imperative.

See Also the Following Articles

Animal-Assisted Therapy ■ Child and Adolescent Psychotherapy: Psychoanalytic Principles ■ Communication Skills Training ■ Family Therapy ■ Home-Based Reinforcement ■ Primary-Care Behavioral Pediatrics ■ Therapeutic Storytelling with Children and Adolescents ■ Transitional Objects and Transitional Phenomena

Further Reading

- Brestan, E., & Eyberg, S. M. (1998). Effective psychosocial treatments for conduct-disordered children and adolescents: 29 years, 82 studies, and 5272 kids. *Journal of Clinical Child Psychology, 27*, 179-188.
- Eisenstadt, T. H., Eyberg, S., McNeil, C. B., Newcomb, K., & Funderburk, B. W. (1993). Parent-child interaction therapy with behavior problem children: Relative effectiveness

- of two stages and overall treatment outcome. *Journal of Clinical Child Psychology*, 22, 42–51.
- Eyberg, S. M., & Boggs, S. R. (1998). Parent-child interaction therapy for oppositional preschoolers. In C. E. Schaefer & J. M. Briesmeister (Eds.), *Handbook of parent training: Parents as co-therapists for children's behavior problems* (2nd ed., pp. 61–97). New York: Wiley.
- Eyberg, S. M., Edwards, D., Boggs, S. R., & Foote, R. (1998). Maintaining the treatment effects of parent training: The role of booster sessions and other maintenance strategies. *Clinical Psychology: Science and Practice*, 5, 544–554.
- Foote, R., Eyberg, S. M., & Schuhmann, E. (1998). Parent-child interaction approaches to the treatment of child conduct problems. In T. Ollendick & R. Prinz (Eds.), *Advances in clinical child psychology*. New York: Plenum.
- Funderburk, B. W., Eyberg, S. M., Newcomb, K., McNeil, C., Hembree-Kigin, T., & Capage, L. (1998). Parent-child interaction therapy with behavior problem children: Maintenance of treatment effects in the school setting. *Child and Family Behavior Therapy*, 20, 17–38.
- Hembree-Kigin, T., & McNeil, C. (1995). *Parent-child interaction therapy*. New York: Plenum.
- McMahon, R. J., & Estes, A. M. (1997). Conduct problems. In E. J. Mash & L. G. Terdal (Eds.), *Assessment of childhood disorders* (3rd ed.). New York: Guilford.
- Querido, J. G., Bearss, K., & Eyberg, S. M. (in press). Theory, research, and practice of parent-child interaction therapy. In T. Patterson & F. Kaslow (Eds.), *Comprehensive handbook of psychotherapy, volume two: Cognitive/behavioral/functional approaches*. New York: Wiley.
- Schuhmann, E. M., Foote, R. C., Eyberg, S. M., Boggs, S. R., & Algina, J. (1998). Efficacy of parent-child interaction therapy: Interim report of a randomized trial with short-term maintenance. *Journal of Clinical Child Psychology*, 27, 34–45.

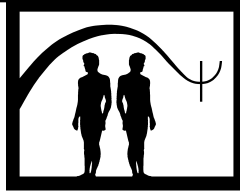

Patient Variables: Anaclitic and Introjective Dimensions

Sidney J. Blatt

Yale University

- I. The Austen Riggs-Yale Study
- II. The Menninger Psychotherapy Research Project (MPRP)
- III. The Treatment of Depression Collaboration Research Program (TDCRP)
- IV. Summary
Further Reading

GLOSSARY

anaclitic A developmentally-oriented perspective on traits, behaviors, capacities, psychological structures, and psychopathological configurations that emphasizes relatedness, interpersonal relations, and attachments across the spectrum of maturity. The term is derived from the idea of “leaning upon.”

introjective A developmentally-oriented perspective on traits, behaviors, capacities, psychological structures, and psychopathological configurations that emphasizes the establishment and maintenance of a sense of self. It literally means, “to take in.”

Psychotherapy research usually assumes an homogeneity among patients and treatments. A number of research methodologists and psychotherapy investigators have questioned these assumptions and have noted the need to differentiate among patients and to examine systematically the role of the patient in the treatment process. As observed by the distinguished research

methodologist, Lee Cronbach almost a half century ago, differences in the effects of various forms of therapeutic intervention may be a function of the congruence of certain characteristics of the patient with particular aspects of the treatment process. Rather than assuming that all patients respond to treatment in the same way, it may be more productive to distinguish among patients and to examine interactions between types of treatment and types of patients expecting some patients to respond more effectively to one form of treatment whereas other patients might respond more effectively to another form of treatment. Jerome Frank, a major figure in initiating systematic psychotherapy research, noted in 1979 that research consistently suggests that “major determinants of therapeutic success appear to lie in aspects of the patients’ personality and style of life.” He saw as crucial the development of better criteria for the assignment of different types of patients to different therapies. He suggested that patients who conceptualize their subjective worlds in greater complexity might do better in unstructured situations whereas less conceptually complex patients may respond better to a more structured therapy. Mardi Horowitz and colleagues, in a study of brief therapy for bereavement in 1984, found that patients with developmentally more advanced levels of self-concept had better outcome in insight-oriented treatment, whereas patients with developmentally lower self-concept responded better to supportive techniques.

In an analysis of data from the National Institute on Mental Health (NIMH) sponsored Treatment of Depression Collaborative Research Program (TDCRP), Stuart

Sotsky and colleagues in 1991 identified several pretreatment characteristics of patients that were predictive of treatment outcome. Higher social functioning predicted a generally favorable outcome (completion of treatment and reduction of severity of depression at termination), particularly in responsiveness to interpersonal therapy (IPT). Higher cognitive functioning also appeared to predict good outcome, (i.e., reduction of severity of depression), especially to cognitive-behavior therapy (CBT). Patients with both impaired social and work functioning responded best to medication (imipramine) plus clinical management (i.e., reduction of depression severity and completion of treatment). These findings led the authors to suggest that “each psychotherapy relies on specific and different learning techniques to alleviate depression, and thus each may depend on an adequate capacity in the corresponding sphere of patient function to produce recovery with the use of that approach.” Patients with relatively good social functioning are better able to take advantage of interpersonal strategies in IPT to recover from depression, whereas patients with relatively less cognitive impairment are better able to utilize cognitive-behavioral techniques to reduce depression. In a 1994 review of attempts to predict therapeutic outcome from a host of patient personality variables (e.g., rigidity, ability to feel deeply, ego strength, coping capacities, extroversion, and neuroticism), assessed via both objective and projective procedures, Sol Garfield concluded that “although a number of investigations have reported some positive findings, most of the relationships secured between personality variables and outcomes have been of limited strength.”

The study of the interactions of patient characteristics with process and outcome variables in psychotherapy research was initially proposed by Lee Cronbach in 1952 in his demonstration that differential efficacy of various teaching procedures was a consequence of the congruence of particular educational procedures and teacher's style with characteristics of the individual student. As Cronbach noted, these findings not only have implications for educational psychology, but they have important implications for psychotherapy research in their suggestion that the investigation of patient-treatment (PT) and patient-outcome (PO) interactions may provide a more productive methodology for psychotherapy research. The investigation of the interaction between patient characteristics with aspects of the treatment process might facilitate the investigation of the efficacy of various types of treatment, as well as the exploration of possible differences in treatment outcome and process. Different types of treatment may not only be differentially effective with different individuals, but different individuals may

experience different, but equally desirable, outcomes with the same therapeutic intervention. The identification of patients' characteristics that interact with particular therapeutic modalities and different outcomes could provide fuller understanding of important aspects of the therapeutic process.

The view that different types of patients might have differential responses to different types of therapy has been discussed since Cronbach's initial observations, more recently emphasized in a 1991 special issue of the *Journal of Consulting and Clinical Psychology* devoted to this topic. Donald Kiesler noted in 1966 that among the most salient obstacles to the development of methodologically sophisticated psychotherapy research are the assumptions of “patient and therapist uniformity.” Patient uniformity is based on the assumption that “patients at the start of treatment are more alike than they are different.” Kiesler stressed the need to abandon these uniformity myths in favor of “designs that can incorporate relevant patient variables and crucial therapist dimensions so that one can assess which therapist behaviors are more effective with which type of patients.” Later in 1991, Larry Beutler called for more specific operational definitions of therapy and of patient characteristics if we are to develop effective predictive models. However, he stressed that the inclusion of PT and PO interactions in psychotherapy research requires conceptual models to identify the personality variables that might mediate the responses to different types of treatment and result in different types of therapeutic outcome.

The primary difficulty in developing this line of research is the identification of certain qualities, out of the infinite array of possible personal characteristics of patients, that might be relevant to the treatment process. Research not guided by theoretically derived or empirically supported principles could lead investigators into a “hall of mirrors” because of the complexity of the potential interactions. Cronbach noted in 1975, “One can avoid entering (this) hall of mirrors by exploring the interactions between theoretically meaningful ... variables” that are grounded in conceptual models. The choice of patient qualities needs to be theory driven and include dimensions relevant to the processes that are assumed to underlie psychological change. One possible model for introducing patient variables into psychotherapy research is the theory of personality development and psychopathology that articulates two primary dimensions in personality development—interpersonal relatedness and self-definition—and notes their differential role in different forms of psychopathology as well as their possible impact on the treatment process.

Sidney Blatt and colleagues beginning in 1974 proposed a theoretically derived and empirically supported model of personality development and psychopathology that has the potential to facilitate the introduction of patient variables into psychotherapy research. Blatt and colleagues conceptualized personality development as involving two fundamental developmental lines: (a) a relatedness or anaclitic line that involves the development of the capacity to establish increasingly mature and mutually satisfying interpersonal relationships, and (b) a self-definitional or introjective line that involves the development of a consolidated, realistic, essentially positive, differentiated, and integrated self-identity. These two developmental lines normally evolve throughout the life cycle in a reciprocal or dialectic transaction. An increasingly differentiated, integrated, and mature sense of self is contingent on establishing satisfying interpersonal relationships, and, conversely, the continued development of increasingly mature and satisfying interpersonal relationships is contingent on the development of a more mature self-concept and identity. In normal personality development, these two developmental processes evolve in an interactive, reciprocally balanced, mutually facilitating fashion throughout life.

These formulations are consistent with a wide range of personality theories ranging from fundamental psychoanalytic conceptualizations to basic empirical investigations of personality development. Sigmund Freud, for example, observed in *Civilization and Its Discontents*, that

the development of the individual seems ... to be a product of the interaction between two urges, the urge toward happiness, which we usually call "egoistic," and the urge toward union with others in the community, which we call "altruistic." ... The man who is predominantly erotic will give the first preference to his emotional relationship to other people; the narcissistic man, who inclines to be self-sufficient, will seek his main satisfactions in his internal mental processes.

Freud also distinguished between object and ego libido and between libidinal instincts in the service of attachment and aggressive instincts necessary for autonomy, mastery, and self-definition. Hans Loewald, a distinguished psychoanalytic theorist, noted that the exploration of

these various modes of separation and union ... [identify a] polarity inherent in individual existence of individuation and "primary narcissistic union"—a polarity that Freud attempted to conceptualize by various approaches but that he recognized and insisted upon

from beginning to end by his dualistic conception of instincts, of human nature, and of life itself.

John Bowlby from an ethological viewpoint considered striving for attachment and separation as the emotional substrate for personality development. Michael Balint, from an object-relations perspective, also discussed these two fundamental dimensions in personality development—a clinging or connectedness (an ocnophilic tendency) as opposed to self-sufficiency (a philobatic tendency). Shor and Sanville, based on Balint's formulations, discussed psychological development as involving a fundamental oscillation between "necessary connectedness" and "inevitable separations" or between "intimacy and autonomy." Personality development involves "a dialectical spiral or helix which interweaves these two dimensions of development." A wide range of more general personality theorists including David Bakan, David McClelland, and Jerry Wiggins have also discussed relatedness and self-definition as two primary dimensions of personality development.

Various forms of psychopathology can be conceptualized as an overemphasis and exaggeration of one of these developmental lines and the defensive avoidance of the other. This overemphasis defines two distinctly different configurations of psychopathology, each containing several types of disordered behavior that range from relatively severe to relatively mild forms of psychopathology. Based on developmental and clinical considerations, anaclitic psychopathologies are those disorders in which patients are primarily preoccupied with issues of relatedness, ranging from symbiotic and dependent attachments to more mature relationships, and utilize primarily avoidant defenses (e.g., withdrawal, denial, repression) to cope with psychological conflict and stress.

Anaclitic disorders involve a primary preoccupation with interpersonal relations and issues of trust, caring, intimacy, and sexuality, ranging developmentally from more to less disturbed, and include non-paranoid schizophrenia, borderline personality disorder, infantile (or dependent) character disorder, anaclitic depression, and hysterical disorders. These patients utilize primarily avoidant defenses like denial and repression. In contrast, introjective psychopathology includes disorders in which the patients are primarily concerned with establishing and maintaining a viable sense of self ranging from a basic sense of separateness, through concerns about autonomy and control, to more complex and internalized issues of self-worth. These patients utilize primarily counteractive defenses (projection, rationalization, intellectualization, doing and undoing, reaction formation,

overcompensation) to cope with conflict and stress. Introjective patients are more ideational and concerned with establishing, protecting, and maintaining a viable self-concept than they are about the quality of their interpersonal relations and achieving feelings of trust, warmth, and affection. Issues of anger and aggression, directed toward the self or others, are usually central to their difficulties. Introjective disorders, ranging developmentally from more to less severely disturbed, include paranoid schizophrenia, the schizotypic or overrideational borderline, paranoia, obsessive-compulsive personality disorders, introjective (guilt-ridden) depression, and phallic narcissism.

The distinction between these two broad configurations of psychopathology can be made reliably from clinical case records. In contrast to the atheoretical diagnostic systems established in the diagnostic and statistical manuals of mental disorders developed by the American Psychiatric Association based primarily on differences in manifest symptoms, the diagnostic differentiation between anaclitic and introjective pathologies is based on dynamic considerations, including differences in primary instinctual focus (libidinal vs. aggressive), types of defensive organization (avoidant vs. counteractive), and predominant character style (e.g., emphasis on an object vs. self-orientation, and on affects vs. cognition).

The theoretical model of personality development and psychopathology based on the polarity of relatedness and self-definition provides a theoretically grounded, empirically supported, conceptual framework for introducing personality variables into psychotherapy research. Differences in the nature of therapeutic outcome and in the treatment process between anaclitic and introjective patients were examined in three different research programs: (a) in the study of therapeutic change in the long-term, intensive, psychodynamically oriented inpatient treatment of patients who are seriously disturbed and treatment resistant (the Riggs-Yale Project), (b) in the comparison of the therapeutic efficacy of psychoanalysis and long-term supportive-expressive outpatient psychotherapy (the Menninger Psychotherapy Research Project), and (c) in the comparison of four different, brief (16-week), outpatient interventions for major depression (the NIMH-sponsored TDCRP).

Sidney Blatt and colleagues demonstrated that the distinction between anaclitic and introjective patients facilitated the identification of important differences in the processes of clinical change in long-term intensive treatment with both inpatients and outpatients. The results of these two studies indicate that anaclitic and in-

trojective patients have different needs, respond differentially to different types of therapeutic interventions, and demonstrate different treatment outcomes. Analyses of the data in these two studies based on more conventional diagnostic differentiations (e.g., psychosis, severe borderline, and neurotic psychopathology) were not as effective in identifying differences in change over the course of treatment. This conclusion is consistent with earlier findings that patient characteristics based on psychodynamic indices, as compared to symptomatic and descriptive distinctions, seem to have greater utility in predicting aspects of the therapeutic process and outcome.

I. THE AUSTEN RIGGS-YALE STUDY

Therapeutic change was studied in young adult inpatients who were seriously disturbed and treatment resistant in long term (at least 1 year), intensive, psychodynamically oriented treatment, including at least four times weekly individual psychoanalytic psychotherapy, in an open therapeutic facility. The differentiation of anaclitic and introjective patients was based on a review of admitting clinical case reports prepared during the first 6 weeks of hospitalization. Two judges made this differentiation from the case records at a high level of reliability. Systematic differences were found in the response of anaclitic and introjective patients on a number of measures of therapeutic change reliably derived from clinical case records and independent psychological test protocols that had been obtained at the outset of treatment and again after, on average, 15 months of inpatient treatment and, on average, 10 months prior to discharge from the clinical facility. Patients generally demonstrated significant improvement across these multiple independent assessments. Introjective patients, however, had greater overall improvement than did anaclitic patients on many of the measures. Independent of the degree of therapeutic gain, anaclitic and introjective patients expressed their therapeutic change (progression and regression) in different ways. Introjective patients expressed therapeutic change primarily through changes in their clinical symptoms, as reliably rated from clinical case reports and in their cognitive functioning, as independently assessed on psychological tests—in thought disorder on the Rorschach and in intelligence as assessed on the Wechsler Adult Intelligence Test. In contrast, anaclitic patients expressed change primarily in the quality of their interpersonal relationships, as reliably rated from clinical case reports, and in their representation of the human form on the Rorschach. Thus, anaclitic and introjective patients

changed primarily in the dimensions of their basic concerns and preoccupations. Anaclitic patients changed primarily on measures of interpersonal relatedness; change in introjective patients was found primarily in measures of cognitive functioning and of clinical symptoms.

II. THE MENNINGER PSYCHOTHERAPY RESEARCH PROJECT (MPRP)

The Menninger Psychotherapy Research Project compared the therapeutic response of outpatients in 5-times weekly psychoanalysis with patients in long-term, psychodynamically oriented, twice-weekly, supportive-expressive psychotherapy. Extensive prior analyses of the clinical evaluations and psychological test assessments, conducted both before and after treatment, have repeatedly failed to find any significant differences in the therapeutic response of patients to these two types of therapeutic intervention. Significant differences between psychotherapy and psychoanalysis, however, were found when patient variables were introduced into the data analyses. Anaclitic and introjective patients were reliably differentiated by two judges who reviewed the pretreatment case reports. Independent evaluation of psychological test data gathered at the beginning and the end of treatment indicated that anaclitic patients had significantly ($p < .05$) greater improvement in psychotherapy than they did in psychoanalysis. Introjective patients, in contrast, had significantly ($p < .05$) greater improvement in psychoanalysis than they did in psychotherapy. Not only were these differences between the two types of treatment significant within each type of patient, but the patient-by-treatment interaction was a significant ($p < .001$) cross-over interaction. Thus, the relative therapeutic efficacy of psychoanalysis versus psychotherapy was contingent, to a significant degree, on the nature of the patient's pathology and pretreatment character structure. It seems consistent that the dependent, interpersonally oriented, anaclitic patients were more responsive to a therapeutic approach that provided more direct interaction with the therapist. It also seems consistent that the more ideational introjective patients, preoccupied with separation, autonomy, and independence, would be more responsive in psychoanalysis.

The findings of both these studies—the comparison of outpatients in two different forms of treatment and the therapeutic response of inpatients who are seriously disturbed and treatment resistant in long-term, intensive treatment—clearly indicate that aspects of patients' personality interact with dimensions of the

therapeutic process to determine the nature of therapeutic change and the differential response to different therapeutic modalities. Patients come to treatment with different types of problems, different character styles, and different needs, and respond in different ways to different types of therapeutic intervention.

III. THE TREATMENT OF DEPRESSION COLLABORATIVE RESEARCH PROGRAM (TDCRP)

The availability of the empirical data from the large-scale, multicenter, treatment program for depression, the TDCRP, sponsored by The National Institute of Mental Health (NIMH), provided opportunity to explore the role of patient dimensions in the brief outpatient treatment of depression. The NIMH TDCRP was a comprehensive, well designed, carefully conducted, collaborative, randomized clinical trial that evaluated several forms of brief (16-week) outpatient treatment for depression. Two hundred thirty-nine patients were randomly assigned to one of four treatment conditions: cognitive-behavior therapy (CBT), interpersonal therapy (IPT), imipramine plus clinical management (IMICM) as a standard reference, and pill placebo plus clinical management (PLA-CM)¹ as a double-blind control condition. It seemed particularly appropriate to explore patient differences in the TDCRP with regard to the fundamental polarity of relatedness and self-definition, given the considerable evidence by Aaron Beck in 1983 and Sidney Blatt in 1974 that indicated the reliability and validity of the distinction between anaclitic and introjective forms of psychopathology, especially in the study of depression.

Patients were nonbipolar, nonpsychotic, seriously depressed outpatients who met RDC criteria for major depressive disorder and had a score of 14 or greater on a modified, 20-item, Hamilton Rating Scale for Depression (HRSD). Among patients who began treatment, 70% were female, 38% were definitely endogenous by RDC criterion, and 64% had had one or more prior episodes of major depression. The average age was 35.

Patients were systematically assessed at intake, at 4-week intervals until termination at 16 weeks, and again at three follow-up evaluations conducted 6, 12, and 18 months after termination. Assessments included an interview and a self-report measure of depression HRSD

¹ Clinical management (CM) was a 20-min nonspecific supportive interaction.

and Beck Depression Inventory [BDI], respectively), an interview and a self-report measure of general clinical functioning (Global Assessment Scale [GAS] and Hopkins Symptom Checklist [HSCL-90], respectively), and an interview assessment of social adjustment, the Social Adjustment Scale (SAS). In addition, patients, therapists, and independent clinical evaluators (CEs) rated various aspects of therapeutic progress during treatment, at termination, and at the three follow-up assessments (therapists did not participate in the follow-up assessments). Prior analyses of the TDCRP data indicated some differences in therapeutic outcome at termination among these brief treatments for depression; IMI-CM and IPT, but not CBT, were more effective than PLA-CM, but only with patients who were more severely depressed. Though at midtreatment, IMI-CM resulted in more rapid reduction of symptoms than CBT and IPT, no significant differences in the extent of symptom reduction were found among the three active treatment conditions in the TDCRP (CBT, IPT, and IMI-CM) at termination. In addition, no significant differences in the intensity of symptoms were found among all four treatment condition at the three follow-up assessments conducted at 6, 12, and 18 months. However, Blatt and colleagues found significant differences between the two psychotherapy conditions and the medication condition at the follow-up evaluations in the degree to which patients thought treatment had a constructive impact on their development of adaptive capacities to deal with interpersonal relationships and their experiences and symptoms of depression.

The development of these adaptive capacities early in the follow-up period, at the 6-month follow-up assessment, significantly moderated the degree to which subsequent stressful life events resulted in increases in depressive symptoms at the final follow-up assessment conducted 18 months after the termination of treatment. Thus, despite frequent claim of the efficacy of the medication condition in the TDCRP, analyses of data from all three follow-up assessments, including the last assessment conducted 18 months after termination, indicate that patients in the two psychotherapy conditions, CBT and IPT, reported greater satisfaction with their treatment and that their treatment had significantly greater positive effect on their life adjustment in a number of important areas—in their ability to deal with interpersonal relationships and their experiences and symptoms of depression than did patients in the medication condition. The development of these adaptive capacities decreased patients' vulnerability to subsequent stressful life events. These findings raise questions about the relative value of

reduction in symptoms versus reduction of vulnerability as measures of therapeutic progress.

A. Impact of Patient Variables on Therapeutic Outcome

To introduce patient variables into analyses of data from the TDCRP, an experienced judge reviewed the intake clinical evaluations to see if he could differentiate anaclitic and introjective patients but found that these clinical case reports contained primarily descriptions of patients' neurovegetative symptoms and lacked sufficient detail about aspects of the patients' lives to allow the judge to discriminate reliably between anaclitic and introjective patients. Fortunately the Dysfunctional Attitudes Scale (DAS) had been included in the TDCRP protocol, primarily to assess the effects of treatment on dysfunctional cognitions. A factor analysis conducted on the pretreatment DAS in the TDCRP data set, consistent with several prior studies, indicated that the DAS is composed of two primary factors—need for approval (NFA) and perfectionism (PFT) or self-criticism. Prior research indicated that NFA factor on the DAS assesses primarily the relatedness or anaclitic dimension whereas the PFT factor in the DAS assesses primarily the self-definitional or introjective dimension. Thus, the pretreatment DAS provided the basis for introducing differences among patients on the dimensions of relatedness and self-definition into analyses of data from the TDCRP.

Pretreatment PFT significantly ($p = .032$ to $.004$) predicted negative outcome, assessed by all five primary measures of clinical change in the TDCRP (HSRS, BDI, GAS, SCL-90, and SAS across all four treatment groups. Factor analysis of the residualized gain scores of these five outcome measures at termination revealed that these measures all load substantially ($p > .79$) on a common factor with an eigenvalue of 3.78, accounting for 75.6% of the variance, indicating that this factor is a consistent measure of therapeutic change. Pretreatment PFT had a highly significant ($p < .001$) negative relationship to this composite residualized gain score at termination. NFA, in contrast, had a marginal, but consistently positive, relationship to treatment outcome as assessed by each of these five outcome measures and by the composite outcome measure ($p = .11$).

Pretreatment PFT also had a significant negative relationship to outcome ratings made by therapists, independent CEs, and the patients at termination. This negative impact of perfectionism on the therapeutic process persists even as late as the last follow-up assessment, 18 months after termination. Pretreatment

PFT correlated significantly with follow-up ratings by CEs of poorer clinical condition and a need for further treatment, and with ratings by patients of dissatisfaction with treatment. Perfectionistic patients gave poorer ratings of their current condition, said that they experienced less change in treatment, and said that treatment had less impact on their general life adjustment and their coping skills (i.e., dealing with relationships and their ability to recognize and deal with their symptoms of depression).

It is important to note that not only did patients with elevated pretreatment PFT feel subjectively less satisfied with treatment and report less impact of treatment on the ability to develop adaptive capacities, but ratings by the therapists (at termination) and CEs indicated a significant negative relationship between patients' pretreatment PFT scores and ratings of the degree to which they thought the patients improved at termination and at the 18-month follow-up, independent of the type of treatment the patient had received. Thus, introjective personality traits significantly interfered with patients' capacity to benefit from short-term treatment, whether the treatment was pharmacotherapy (IM-ICM), psychotherapy (CBT or IPT), or placebo. These findings of impaired response of introjective (perfectionistic) patients in short-term treatment stand in contrast to the findings of more positive responses of introjective patients in the long-term, intensive treatment of inpatients who are seriously disturbed at the Austen Riggs Center and in the long-term, intensive treatment of outpatients evaluated in The Menninger Psychotherapy Research Project.

B. Impact of Patient Variables on the Therapeutic Process

The extensive data gathered as part of the NIMH TDCRP also provided Blatt and colleagues the opportunity to examine some of the dynamics of brief treatment and to identify when and how introjective personality characteristics interfere with the therapeutic process.

Therapeutic gain in the TDCRP was assessed every 4 weeks until termination, and thus it was possible to evaluate when in the treatment process pretreatment PFT began to disrupt therapeutic outcome. PFT significantly disrupted therapeutic progress primarily in the last one half of the treatment process. Until midtreatment at the 8th week, no significant differences were found in therapeutic gain between patients at different levels of PFT. Beginning at midtreatment, however, only patients in the lower one third of the distribution

of PFT continued to make significant progress. When two thirds of the patients, those with higher pretreatment levels of perfectionism, approach the end of treatment, they seem to experience a sense of personal failure, dissatisfaction, and disillusionment with treatment. Even further, perfectionistic (introjective) individuals are very concerned about maintaining control and preserving their autonomy. Thus, another factor that may disrupt the therapeutic progress in the last one half of the treatment process of the more perfectionistic (introjective) patients in the TDCRP may be the unilateral, external imposition of an arbitrary, abrupt termination date.

Not only were we able to identify when introjective personality qualities began to disrupt therapeutic progress, but we were also able to discover some of the mechanisms through which this disruption occurs. Janice Krupnick and colleagues in 1996 had used a modified form of the Vanderbilt Therapeutic Alliance Scale (VTAS) to assess the contributions of patient and therapist in establishing an effective therapeutic alliance in the TDCRP. Judges rated videotapes of the 3rd, 9th, and 15th treatment sessions. They found that the VTAS comprised two factors: (a) a patient factor that assessed the extent to which the patient was open and honest with the therapist; agreed with the therapist about tasks, goals, and responsibilities; and was actively engaged in the therapeutic work; and (b) a therapist factor that assessed the extent to which the therapist committed self and skills to helping the patient and the degree to which the therapist acknowledged the validity of the patient's thoughts and feelings. The contribution of patients to the therapeutic alliance, but not that of the therapist, significantly predicted treatment outcome. Therapeutic outcome across treatment groups was predicted by the degree to which the patient became increasingly involved in the treatment process.

Using these ratings of the therapeutic alliance made by Krupnick and colleagues, David Zuroff and colleagues recently explored the impact of the pretreatment levels of PFT on the development of the therapeutic alliance and found that PFT significantly impedes the capacity of patients to develop a therapeutic alliance, particularly in the latter one half of treatment. Thus, not only were we able to identify when in the treatment process perfectionism disrupts therapeutic progress, but we also discovered how introjective personality traits impede patients' capacity to gain from the brief treatment of depression. Patients who make therapeutic progress usually become increasingly involved in a constructive collaborative relationship with their therapist,

but this increased involvement in treatment is moderated by the patient's pretreatment level of perfectionism, independent of the treatment they were receiving. Increases in therapeutic alliance were significantly smaller or absent in patients at higher levels of perfectionism, particularly in the latter one half of the treatment process.

Perfectionistic individuals generally have limited capacities for developing open, collaborative relationships, and therefore it may take a more extended period of time for them to establish an effective therapeutic alliance. The effects of pretreatment PFT on therapeutic outcome is not only moderated by the quality of the therapeutic alliance, but, as Golar Sharar and colleagues demonstrated, it is also moderated by the extent to which patients are able to establish and maintain external social support during treatment and the follow-up period. Thus, the disruptive effects of pretreatment PFT on the treatment process is primarily the consequence of the disruptive effects of perfectionism on interpersonal relatedness both in the treatment process and in interpersonal relationships more generally.

Blatt and colleagues in 1996 also tried to identify aspects of the treatment process that could facilitate treatment outcome with these patients who are more difficult and highly perfectionistic. The TDCRP research team, using the Barrett-Lennard Relationship Inventory (B-L RI), asked patients, at the end of the second treatment session, to rate the degree to which they thought their therapist was empathic and caring. The B-L RI includes subscales to assess patient's perception of the therapist's emphatic understanding, level of positive regard, and congruence—qualities of the therapist that Carl Rogers believed were the necessary and sufficient conditions for therapeutic change. Prior studies demonstrated that the B-L RI was significantly related to treatment outcome at termination.

Overall, the degree to which patients in the TDCRP perceived their therapist as empathic and caring at the end of the second treatment session had a significant ($p < .05$) positive relationship to therapeutic outcome. However, this facilitating therapeutic effect of the patients' early view of the therapist as empathic and caring was very much contingent on the patients' level of perfectionism. An initial positive view of therapist had only marginal effects on treatment outcome at low and high levels of PFT ($ps < .10$ and $.15$, respectively). Patients who are highly perfectionistic did relatively poorly in treatment whereas patients low in perfectionism had relatively better outcome, independent of how they perceived the therapist early in treatment. However, at the middle level of PFT, the patient's early view of the therapist

had a highly significant ($p < .001$) impact on treatment outcome. At the middle level of perfectionism, an early view of the therapist as empathic and caring significantly reduced the disruptive effects of perfectionism on treatment outcome, whereas a negative view of therapist significantly compounded these disruptive effects. Thus at the middle level, the effect of perfectionism on treatment outcome is significantly contingent on the degree to which the patient, very early in the treatment process, perceived the therapist as empathic and caring.

In sum, analyses of brief treatment of depression in the TDCRP indicate that therapeutic outcome is significantly influenced by pretreatment characteristics of the patient—by pretreatment level of perfectionism or self-criticism—independent of the type of treatment provided. This negative effect of pretreatment PFT on outcome occurs primarily in the second one half of the treatment process, as patients approach termination. This impact of pretreatment PFT on outcome occurs in large part through interference with patients' capacity to continue to be involved in interpersonal relationships both in the therapeutic alliance, particularly as termination approaches, as well as in interpersonal relations external to the treatment process. This negative impact of perfectionism on treatment outcome is significantly reduced, but only at middle levels of perfectionism, if the patient initially perceives the therapist as empathic and caring.

IV. SUMMARY

A fundamental polarity of relatedness and self-definition, central to many of Freud's theoretical formulations, as well as to those of many other psychoanalytic and non-psychoanalytic investigators, provides a basis for articulating a model of personality development: A model that involves a complex, mutually facilitating, dialectic transaction between the development of interpersonal relationships and of self-definition throughout the life cycle. This polarity also provides a basis for identifying two major types of depression: an anclitic or dependent and introjective or self-critical depression. This polarity also provides a way for understanding a wide range of psychological disturbance, from schizophrenia to the neuroses, as emerging from disruptions in the dialectic development of the two fundamental developmental lines of relatedness and self-definition. This differentiation of two primary configurations of psychopathology—anaclitic and introjective—is based, not on differences in manifest symptoms, but on fundamental dimensions of personality organization: differences in primary instinctual focus (sexuality vs.

aggression), type of defensive organization (avoidant vs. counterphobic), and personality style (e.g., emphasis on relationships vs. a self-orientation and an emphasis on feelings and emotions versus cognition). This conceptual model of two major configurations of psychopathology developed by Blatt and colleagues facilitates an appreciation of the continuities between personality development and normal variations in personality or character style, as well as among various forms of psychopathology.

This conceptual model of personality development and psychopathology facilitated the introduction of personality dimensions into the study of therapeutic outcome and process in both short- and long-term treatment. These analyses demonstrated that anaclitic and introjective patients come to treatment with different capacities, needs, and problems, are differentially responsive to different types of treatment, and change in different, but equally, desirable ways. These theoretical formulations about a fundamental polarity of relatedness and self-definition provided a fuller understanding of personality development and the nature of psychopathology and facilitated a fuller exploration of important aspects of the therapeutic process and the nature of therapeutic change.

The introduction of patient variables into research on therapy outcome and process enables investigators to begin to identify factors that impede or facilitate therapeutic change. Even further, the inclusion of patient characteristics in research designs enables investigators to examine more systematically aspects of the therapeutic process and to identify when and how in the treatment process particular characteristics of the patients facilitate or impede therapeutic progress as well as identify particular aspects of the therapeutic process that can facilitate therapeutic change with patients who are treatment resistant.

See Also the Following Articles

Behavioral Assessment ■ Integrative Approaches to Psychotherapy ■ Neuropsychological Assessment ■ Outcome Measures ■ Projective Testing in Psychotherapeutics ■ Research in Psychotherapy ■ Therapeutic Factors

Further Reading

- Bakan, D. (1966). *The duality of human existence: An essay on psychology and religion*. Chicago: Rand McNally.
- Beutler, L. E. (1991). Have all won and must all have prizes? Revisiting Luborsky et al.'s verdict. *Journal of Consulting and Clinical Psychology, 59*, 226–232.
- Blatt, S. J. (1974). Levels of object representation in anaclitic and introjective depression. *Psychoanalytic Study of the Child, 29*, 107–157.
- Blatt, S. J. (1992). The differential effect of psychotherapy and psychoanalysis on anaclitic and introjective patients: The Menninger Psychotherapy Research Project revisited. *Journal of the American Psychoanalytic Association, 40*, 691–724.
- Blatt, S. J. (1995). Representational structures in psychopathology. In D. Cicchetti & S. Toth (Eds.), *Rochester Symposium on developmental psychopathology: Vol. 6. emotion, cognition, and representation* (pp. 1–33). Rochester, NY: University of Rochester Press.
- Blatt, S. J., & Felsen, I. (1993). “Different kinds of folks may need different kinds of strokes”: The effect of patients’ characteristics on therapeutic process and outcome. *Psychotherapy Research, 3*, 245–259.
- Blatt, S. J., & Ford, R. (1994). *Therapeutic change: An object relations perspective*. New York: Plenum.
- Blatt, S. J., & Zuroff, D. C. (1992). Interpersonal relatedness and self-definition: Two prototypes for depression. *Clinical Psychology Review, 12*, 527–562.
- Cronbach, L. J. (1953). Correlation between persons as a research tool. In O. H. Mowrer (Ed.), *Psychotherapy: Theory and research* (pp. 376–389). New York: Ronald.
- Kiesler, D. J. (1966). Some myths of psychotherapy research and the search for a paradigm. *Psychological Bulletin, 65*, 110–136.
- Sotsky, S. M., Glass, D. R., Shea, M. T., Pilkonis, P. A., Collins, J. F., Elkin, I., Watkins, J. T., Imber, S. D., Leber, W. R., Moyer J., & Oliveri, M. E. (1991). Patient predictors of response to psychotherapy and pharmacotherapy: Findings in the NIMH Treatment of Depression Collaborative Research Program. *American Journal of Psychiatry, 148*, 997–1008.
- Zuroff, D. C., Blatt, S. J., Sotsky, S. M., Krupnick, J. L., Martin, D. J., Sanislow, C. A., & Simmens, S. (2000). Relation of therapeutic alliance and perfectionism to outcome in brief outpatient treatment of depression. *Journal of Consulting and Clinical Psychology, 68*, 114–124.

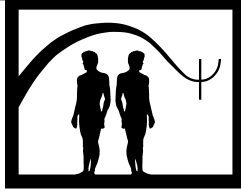

Positive Punishment

Alan Poling, Kristal E. Ehrhardt, and Ruth A. Ervin

Western Michigan University

- I. Description of Treatment
 - II. Theoretical Bases
 - III. Applications and Exclusions
 - IV. Empirical Studies
 - V. Case Illustration
 - VI. Summary
- Further Reading

GLOSSARY

aversive A nontechnical term often used to refer to punishment and negative reinforcement procedures.

conditioned punisher An event that acquires its capacity to serve as a punisher through learning.

negative punishers Punishers that involve removing something from an individual's environment.

negative punishment A procedure (or process) in which responding is weakened by its consequences, which involve removing something from an individual's environment.

negative reinforcement A procedure (or process) in which behavior is strengthened as a function of its consequences, which involve terminating a stimulus that is present or postponing (or preventing) the delivery of an otherwise forthcoming stimulus.

positive practice overcorrection A procedure that reduces the frequency of undesired behavior by having an individual emit appropriate relevant behaviors repeatedly each time the troublesome behavior occurs.

positive punishers Punishers that involve adding something to an individual's environment.

positive punishment A procedure (or process) in which responding is weakened by its consequences, which involve adding something to the individual's environment.

Premack principle A lower-probability behavior may be reinforced by allowing an individual to engage in a higher-probability behavior after the lower-probability behavior occurs. Conversely, a higher-probability behavior may be punished by requiring an individual to engage in a lower-probability behavior after the higher-probability behavior occurs.

punishers Consequences that weaken behavior.

punishment A procedure (or process) in which responding is weakened by its consequences, which are termed punishers.

respondent conditioning A procedure in which a previously neutral stimulus comes to control behavior by virtue of reliably preceding a stimulus that controls behavior at the onset of and throughout stimulus–stimulus pairings.

restitutional overcorrection A procedure that reduces the frequency of undesired behavior by requiring a person to repair the damage done by that behavior and to make the relevant parts of the world better than before the misdeed occurred.

simple correction A procedure that reduces the frequency of undesired behavior by having an individual emit appropriate relevant behaviors a single time after the troublesome behavior occurs.

stimulus An environmental event.

unconditioned punisher An event that does not require learning to serve as a punisher.

Many people consider punishment to be any attempt at disciplining a person by harming that individual, either physically or psychologically, when misbehavior occurs. When it is defined in this way, whether punishment increases, decreases, or has no effect on the future

likelihood of occurrence of the misbehavior is irrelevant. Thus, spanking a child for cursing would be considered as punishment, regardless of whether the child curses more, less, or equally often after being spanked. When punishment is construed in this way, the behavioral function of the procedure is unclear and what stands out is that punishment is intended to hurt the person exposed to it. Not surprisingly, people who view punishment in this way typically object to its therapeutic use, although they may support it as retribution for heinous misdeeds.

To increase clarity and to avoid the negative connotations associated with “punishment” as the term is used in ordinary language, many behavioral psychologists define punishment not in terms of the intent of the person who implements it, but instead in terms of the nature of the operation and its effects on behavior. Specifically, punishment occurs when behavior is weakened by its consequences, which are termed *punishers*. The nature of those consequences, the intent of the person who administers them, and whether they harm the individual exposed to punishment are irrelevant to this definition, which we prefer. What is relevant is that the consequences of a particular behavior make it less likely that such behavior will occur in the future.

I. DESCRIPTION OF TREATMENT

It is convention to distinguish between positive and negative punishment. Positive punishment occurs when a response adds something to an individual's environment and is therefore weakened. If, for example, a parent says “don't poke your brother” when an older sibling jabs a toddler, and the subsequent rate of jabbing decreases as a result of this consequence, then the procedure is positive punishment. Negative punishment, in contrast, occurs when a response takes something away from an individual's environment and is therefore weakened. If, for example, the older sibling loses access to TV after poking the toddler, and the subsequent rate of jabbing decreases as a result of this consequence, then the procedure is negative punishment. In almost all cases, as in these examples, the response-weakening effects of punishment involve a decrease in the rate of responding. Other changes in behavior, however (e.g., an increase in response latency), can also be indicative of the response-weakening effects of punishment.

Positive punishment procedures can be divided into two general categories, those that involve presenting an external stimulus to a client and those that entail re-

quiring the client to engage in nonpreferred (i.e., low-probability) behaviors. It is usual practice to refer to events that serve as positive punishers as “aversive” stimuli and to consider punishment as an “aversive” intervention. Unfortunately, these same terms also are often applied to negative reinforcers and negative reinforcement procedures, respectively, which is a source of confusion. Negative reinforcers are events that, when removed as a consequence of a particular kind of behavior, strengthen that behavior (e.g., pressing the “off” button on an alarm clock is strengthened by removal of the sound). Reinforcers always strengthen behavior, punishers always weaken it, and events that serve as negative reinforcers do not always serve as positive punishers. In addition, in everyday language “aversive” means “unpleasant” or “noxious,” but the subjective effects of punishment are not a part of its technical definition. Punishment is defined functionally, in terms of how it affects behavior (i.e., it weakens it), not in terms of how it makes people feel. For these reasons, little is gained by labeling punishment as “aversive,” although the practice is very common.

Positive punishment by presenting an external stimulus to a client when misbehavior occurs requires two steps. First, an effective positive punisher must be isolated and, second, conditions must be arranged so that this stimulus consistently and immediately follows the behavior that is to be reduced.

Positive punishers can be unconditioned (unlearned, or primary) or conditioned (learned, or secondary). Unconditioned punishers, which include events that provide extreme stimulation of any sensory system (e.g., loud sounds, bright lights, extreme cold or heat, strong pressure on the skin), suppress behavior automatically. That is, their delivery following a behavior reduces the likelihood that such behavior will recur in similar settings regardless of the history of the person in question. Events that serve as unconditioned positive punishers are similar across people. Moderate to intense electrical stimulation (shock) applied to the skin is a good example of such a punisher.

Unlike unconditioned punishers, conditioned positive punishers acquire their capacity to reduce responding through learning. This can occur through respondent conditioning when an established punisher reliably and shortly follows a neutral stimulus. For example, if a tone of moderate intensity that is not initially punishing occurs just before a person is shocked on a number of occasions, the tone eventually will acquire a punishing function. This function will be maintained so long as the tone is at least occasionally paired with the shock.

Conditioned punishers also can be established through verbal mediation. Consider, for instance, a music teacher who is giving voice lessons to a highly motivated student who is practicing singing on-key. The teacher says, “When you go too high, I’ll raise my forefinger.” By virtue of a unique learning history, the student is motivated not to sing at a pitch beyond that targeted by the teacher, that is, to “not go too high,” and doing so is punishing. So is any indication that this is occurring, like the teacher’s raised forefinger. Barring the teacher’s explanation, the raised finger would not punish (i.e., reduce the future likelihood of) singing off-key in this student. In addition, unless their histories were similar to that of the student in our example, the teacher’s raised finger would not serve as a positive punisher for the behavior of other people.

Once an effective unconditioned or conditioned punisher that is practical and ethically acceptable is isolated or established—which is an essential first step that can be difficult to accomplish—effective reduction of the targeted behavior is most likely to occur if:

1. The punisher immediately follows each occurrence of the behavior that is to be reduced.
2. The punisher is introduced at its optimum intensity initially, rather than being gradually increased in intensity over time.
3. The conditions of punishment are explained accurately to the client, if she or he has the verbal skill to understand them.
4. The reinforcer that maintains the troublesome behavior is made available for an alternative, desirable response.

As explained in later sections, positive punishment through the delivery of an external stimulus is not a common therapeutic procedure. More common, although still controversial, is requiring an individual to engage in a low-probability behavior when a high-probability, but troublesome, behavior occurs. This form of punishment is based on the Premack principle, which was devised by David Premack in the 1950s. It states that (a) the opportunity to engage in a higher-probability behavior will reinforce a lower-probability behavior, and (b) the requirement of engaging in a lower-probability behavior will punish a higher-probability behavior.

Premack measured the probability of different incompatible behaviors by allowing an individual unconstrained opportunity to engage in them and measuring the amount of time spent in each activity. For example, a middle-school student on the playground during a

30-min recess would be given the opportunity to play soccer or softball, two independent activities that cannot occur together. If the student spent 24 min playing softball and 6 min playing soccer, then playing softball is the higher-probability, or preferred, activity. The Premack principle suggests that one could increase the amount of time the child played soccer by requiring this behavior to occur before the opportunity to play softball was provided. Conversely, the amount of time spent playing softball could be reduced if the child was required to play soccer for a considerable period after playing softball for a short time. In this case, however, neither behavior is necessarily undesirable and, unless they loved soccer and loved softball, there would be no reason for parents or teachers to punish playing softball in this manner. In other cases, however, the higher-probability behavior is clearly undesirable and the lower-probability behavior desirable (or innocuous), and the Premack principle of punishment can be used to good advantage. This is the case with overcorrection, a procedure that Richard Foxx and Nate Azrin developed in the early 1970s to reduce aggressive and other disruptive behaviors exhibited by clients with mental retardation living in an institutional setting.

In essence, overcorrection requires a client to engage in a low-probability (nonpreferred) behavior each time a higher-probability, but troublesome, behavior occurs. Two versions of overcorrection are distinguished, depending on the nature of the nonpreferred behavior that the client is required to perform. In positive practice overcorrection, the client is required to emit appropriate relevant behaviors repeatedly each time the troublesome behavior occurs. For example, a child who kicks a chained dog passed on the way to school might be required to walk the block on which the dog lives 10 times without approaching (or kicking) it.

A procedure similar to positive practice overcorrection is simple correction, in which the individual is required to emit appropriate relevant behaviors once after the undesired behavior occurs. For instance, the hypothetical child who kicks a chained dog would be required to walk past the dog once without approaching it.

In restitutive overcorrection, or restitution, each time the problem behavior occurs the client is required to repair the damage done by that behavior and to make the relevant parts of the world better than before the misdeed occurred. If, for instance, a child spits on the kitchen floor, she or he would be required to not only clean up the spittle, but also to mop and dry the entire kitchen floor. An advantage of restitution is that it has an educational, as well as a punishing, function.

Although they are not typically construed as overcorrection, a number of other interventions make use of the Premack principle to reduce inappropriate responding. One such procedure is contingent exercise, where a client who rarely exercises is required to do so when an undesired response occurs. Another is guided compliance, where a client who misbehaves while performing a task is physically guided through the task until it is completed. If, for instance, a child who is asked to turn off and put away a tape player begins to whine and argue (the undesired behavior), the parents may physically guide the child in performing the requested activity. Here, as in all cases involving punishment by requiring clients to engage in nonpreferred activities, when physical guidance is provided the stimulation resulting from such guidance may be punishing.

In some cases, it is difficult or impossible to get an individual to engage in nonpreferred activities, and attempts at doing so can create a host of problems. Among them are inconsistent application of the intervention and physical harm to the client, the therapist, or other people. In general, punishment based on the Premack principle is best used with compliant and easily managed individuals. One would not, for instance, attempt to physically guide a large, strong, and angry client in performing a task she or he abhorred.

II. THEORETICAL BASES

As discussed in the entry for operant conditioning, operant conditioning has been likened to natural selection in that both involve processes of variation, selection, and retention. Punishment “selects out” operants that produce certain consequences. Studies by neuroscientists may reveal the physiological mechanisms through which this occurs and, if so, contribute to a comprehensive theory of punishment. No such theory is currently available, which perhaps has contributed to widespread misunderstanding of what punishment entails.

Psychologists have been concerned with punishment from the discipline’s early days. Although Edward Thorndike made no mention of what we now call punishment in the earliest versions of his well-known law of effect, by 1905 when his book *The Elements of Psychology* appeared, he recognized that the consequences of behavior could have bidirectional effects. That is, they could make it either more or less likely that such behavior would recur. Thorndike wrote:

Any act which in a given situation produces satisfaction becomes associated with that situation, so that

when the situation recurs the act is more likely than before to recur. [This is reinforcement.] Conversely, any act which in a given situation produces discomfort becomes disassociated from that situation, so that when the situation recurs the act is less likely than before to recur. [This is punishment.]

Later in life, Thorndike came to believe that punishment was not effective in reducing behavior. This belief was fostered by the results of studies conducted with college students learning to match English words with Spanish synonyms. Thorndike found that saying “Right” after correct matches facilitated learning, therefore, reinforcement was effective. But saying “Wrong” after incorrect matches had no effect on subsequent performance, therefore, punishment was ineffective. Although Thorndike’s results are subject to alternative explanations, his view of punishment as ineffective was popularized in the lay press with respect to child-rearing practices.

B. F. Skinner greatly extended Thorndike’s research and theorizing regarding the effects of consequences on behavior. Skinner acknowledged punishment as a principle of behavior, but throughout his life he argued that the effects of punishment are short lived and that, in general, punishment should not be used therapeutically or in the culture at large. Skinner’s position regarding the short-lived effects of punishment were supported by his research findings with rats, and by the findings of his student, William Estes. In one study, Estes initially rewarded (reinforced) rats’ lever presses with food. After the response was occurring reliably, food was no longer available, and each lever press produced an intense electric shock delivered to the rat’s feet. This procedure reduced responding to near zero levels. If, however, a substantial period of time passed without the rats being tested, they would resume lever pressing. Thus, punishment did not eliminate behavior but only suppressed it so long as the punishment procedure was in effect.

Results such as these, as well as philosophical considerations, caused Skinner to have strong negative opinions regarding positive punishment. For example, the chapter in his 1953 book *Science and Human Behavior* that deals with punishment is titled “A questionable technique.” He argues therein that (a) punishment does not produce lasting effects, (b) punishment often is used abusively, (c) punishment often engenders strong and negative emotional responding, (d) punishment engenders escape from and avoidance of stimuli associated with the experience, and (e) viable alternatives to punishment are available. He acknowledged,

however, that relatively little research had been conducted on the effects of punishment and suggested that further work in the area was necessary.

Laboratory research concerning punishment by the delivery of aversive stimuli increased dramatically during the 1960s, but interest in the area soon waned. The studies that were conducted revealed a great deal about the variables that influence the degree of response suppression produced by positive punishment and also provided evidence that punishment could eliminate, or substantially reduce, behavior over long periods. In fact, after summarizing the research literature, Nate Azrin and William Holz concluded in 1966 that:

As a reductive procedure, punishment appears to be at least as effective as most other procedures for eliminating responses. . . . If we have not overlooked the effects of [important] variables, there is every reason to believe that our punishment procedure will be completely effective in eliminating the undesired response. The emotional state or enduring behavioral disruption of the punished subject are not necessarily undesirable outcomes of punishment, nor are the severity of the response reduction or the behavioral generalization of the punishing effects undesirable.

They suggest that disruption of social interactions, caused by the tendency of the individual exposed to punishment to avoid or react aggressively toward the person who inflicts punishment, is the major disadvantage of using punishment. Although Azrin and Holz' influential chapter is by no means a glowing endorsement for therapeutic applications of positive punishment, the studies reviewed therein make it clear that punishment can be effective in reducing behavior. These laboratory studies, which dealt with the application of external stimuli as punishers, provided an empirical basis for therapeutic applications of positive punishment during the 1960s and 1970s.

Although many theoreticians construe punishment as a process that is similar to reinforcement, but with opposite effects on behavior, there is an alternate view. From this perspective, the response reduction produced by punishment is due to passive avoidance responding. That is, organisms learn that emitting certain responses produce undesired (i.e., punishing) consequences and, because of this, they withhold such responses even though variables are present that would otherwise cause those responses to occur. Behavioral psychologists do not agree as to whether or not experimental data provide solid support for either the passive avoidance or direct response reduction theory of pun-

ishment. Although the issue is of theoretical significance, it does not appear to have important implications for clinical applications of positive punishment.

Most basic laboratory research in the area of positive punishment has involved delivery of aversive stimuli, and most theorizing has concerned the effects of such stimuli. There have, however, been some extensions of Premack's work concerning punishment by requiring the performance of low-probability (nonpreferred) activities. It is now generally accepted that forcing an individual to engage in a higher-probability behavior can punish a lower-probability behavior, so long as the individual is forced to engage in the higher-probability behavior for a longer period than would occur normally. Although this finding is interesting, it is of little clinical significance.

III. APPLICATIONS AND EXCLUSIONS

Restrictions on the use of positive punishment depend on the specific procedure under consideration. In general, ethical and legal considerations severely limit the use of positive punishment as a primary intervention in therapeutic settings. There is, however, debate about whether positive punishment should ever be used with protected populations (e.g., children, people with mental retardation).

No legitimate therapist recommends positive punishment as a first-line intervention, and advocates of "non-aversive" interventions contend that the procedure should never be used. Advocates of the right to effective treatment also acknowledge that positive punishment is a restrictive (harmful) intervention. They contend, however, that it may be appropriate to use the procedure to deal with serious behavioral problems that have not responded favorably to other, less restrictive, interventions. In fact, some argue that it is unethical to withhold a potentially valuable, although momentarily unpleasant, intervention if doing so maintains the client in a dangerous or uncomfortable state.

As a rule, the use of unusual unconditioned punishers (e.g., electric shock, aromatic ammonia) is more strongly restricted than are procedures that deliver common conditioned punishers (e.g., verbal reprimands) or that require clients to perform generally accepted, but (for them) low-probability behaviors. For instance, in 1990 the American Association on Mental Retardation condemned "aversive procedures which cause physical damage, pain, or illness" and procedures "which are

dehumanizing—social degradation, verbal abuse and excessive reactions.” Common forms of conditioned punishment, as described in the example of the music teacher’s raised finger, are common in many human interactions, including therapeutic interchanges in which clients and therapists talk to one another. Such interchanges are not, however, based primarily on punishment or generally considered as punishment procedures.

If punishment is to be used systematically as a part of therapy, it is important that appropriate safeguards be put in place to protect both clients and staff. In general, a clear decision-making process regarding the use of punishment should be in place. This process should recognize that punishment is a restrictive (harmful) intervention and adhere to the doctrine of the least restrictive alternative intervention. This doctrine states that other, less restrictive, interventions must be evaluated and found ineffective before punishment is considered.

Clear guidelines must be established regarding the exact nature of the punishment procedure, including who is to implement it and the specific standards of accountability. Input from clients and client’s advocates, as well as behavior-change experts, should play a crucial role in determining the details of punishment, including who is to administer it and how its effects are to be monitored. Unambiguous rules regarding the behavioral data that will support continuation, modification, and termination of punishment must be established by a vigilant, expert, and caring treatment team before punishment is implemented, and these rules must be followed unless the good of the client dictates otherwise in the opinion of the team. Whenever possible, positive punishment should be avoided entirely.

IV. EMPIRICAL STUDIES

Most of the published studies of therapeutic applications of positive punishment involve attempts to reduce harmful behaviors in people with mental retardation and other developmental disabilities. A well-known example of research in this area concerns Ivaar Lovaas’s successful use of electric shocks during the 1960s to reduce pernicious self-injury in children with autism. Other researchers replicated his findings concerning the effectiveness of electric shock punishment in reducing self-injury and also demonstrated that the procedure could be used to reduce other harmful behaviors to acceptable levels.

Several unconditioned primary punishers have been evaluated in published studies, including water mist

sprayed in the face, ice cubes placed against the jaw, lemon juice squirted in the mouth, and aromatic ammonia held close enough to the client to be smelled. These stimuli have proven to be effective in reducing self-injury and other troublesome behaviors when presented immediately after such behavior occurred. In short, published studies provide clear evidence that punishment via the delivery of aversive stimulation can provide rapid, strong, and enduring suppression of target behaviors.

Even people who argue strongly against the use of punishment via the delivery of aversive stimuli generally acknowledge the procedure’s efficacy. They point out, however, that the procedure can produce several harmful side effects, including aggression, undesirable emotional responses (e.g., crying), establishment of the person who delivers the punisher as a conditioned punisher, and general suppression of behavior. Although such effects certainly can occur, reviews of the research literature suggest that punishment is at least as likely to produce positive side effects, such as increases in social behavior, improved affect, and reductions in the problem behavior outside the treatment setting. Nonetheless, negative side effects remain a real concern.

So, too, is the possibility that caregivers may use punishment excessively and inappropriately in treating people with developmental disabilities, and that children who see punishment being used are likely to use punishment themselves. Such effects are documented in the literature, although they do not inevitably occur. Finally, because punishment is generally recognized as restrictive and is considered by many people as intrinsically dehumanizing, efficacy alone does not justify its use. When nonaversive alternatives are available, they are preferable. Although it is clear that such procedures have been used to manage a wide range of problem behaviors in protected populations, there is ongoing debate as to whether effective nonaversive alternatives to punishment via the delivery of an aversive stimulus are always available.

Positive punishment by requiring an individual to engage in nonpreferred activities has been evaluated in a substantial number of studies, most concerned specifically with overcorrection. In brief, such procedures, used alone or in combination with other strategies, have been effective in reducing a substantial range of behaviors emitted by a wide variety of persons in diverse settings. Among the behaviors that have been successfully controlled are self-injury, aggression, stereotypy, disruption, in-class masturbation, oral reading errors, oral spelling errors, writing errors, and failure to make eye

contact. Although positive side effects, including decreased crying and increased smiling and social interactions have been observed in some studies, negative side effects also have been reported. These include aggression, avoidance of the setting in which the procedure is applied, screaming, and stereotypical responding. As noted previously, difficulties can arise in getting a client to perform low-probability behaviors. Moreover, selecting appropriate low-probability behaviors can be difficult in some settings.

Positive punishment by requiring individuals to engage in nonpreferred activities has engendered some controversy but appears to be generally accepted so long as the required behaviors are appropriate and the measures taken to get clients to perform them are humane. Positive punishment by the delivery of aversive stimuli, in contrast, is highly controversial and is best viewed as a treatment of last resort. Nonetheless, various forms of positive punishment are ubiquitous in everyday life and in therapy. They may teach people what not to do and be of value for that reason. But they do not establish appropriate behaviors, and they are unpleasant, and for these reasons many thoughtful people minimize their use.

V. CASE ILLUSTRATION

A study published by Thomas Sajway, Julian Libet, and Stuart Agras in 1974 provides a straightforward example of positive punishment through the delivery of an aversive stimulus. They treated a severely malnourished and dehydrated 6-month-old girl who regurgitated each time she was fed. As they described it, after being given food (e.g., milk in a bottle), she “would open her mouth, elevate and fold her tongue, and vigorously thrust her tongue backward and forward,” which caused her to throw up the food she had just ingested. There was no sign of duress during these activities, and physicians could isolate no cause for their occurrence.

To reduce regurgitation, Sajway, Libet, and Agras squirted unsweetened lemon juice into the girl’s mouth immediately after the tongue movements occurred. This procedure rapidly reduced regurgitation and, after 12 days of exposure to it, the vigorous tongue movements and regurgitation had totally disappeared. As a result, the girl’s weight increased dramatically—by 50% in 2 months—and she became healthy. No untoward effects were observed, and it is no exaggeration to say that exposure to the mild punishment procedure saved the girl’s life.

A study published by Richard Foxx and Nate Azrin in 1972 clearly illustrates punishment by requiring a person to emit nonpreferred behaviors. The client in this study was a 50-year-old woman with mental retardation who lived in an institution. Prior to treatment, for over 30 years she regularly (more than 10 times per day) upset furniture and engaged in other destructive acts on her ward. To reduce these destructive and high-probability behaviors, Foxx and Azrin used a restitutional overcorrection procedure in which the woman was required to correct immediately any damage caused by her actions and, in addition, to emit other behaviors that improved the quality of the ward. For instance, if she upset a bed, she was required to set it upright and make up the covers, and also to fluff the pillows on all of the other beds in the ward. (These were low-probability activities for the woman.)

Overcorrection rapidly reduced destructive acts. Within 1 week, fewer than four acts occurred per day. After 11 weeks of overcorrection, the behavior was totally eliminated. No adverse effects of the procedure were noted. Here, a behavioral problem that had existed for over 3 decades was solved by requiring the client to make amends for the damage caused by her inappropriate actions.

VI. SUMMARY

Positive punishment refers to a procedure in which a particular kind of behavior is weakened (decreased in rate) because a stimulus is presented, or the individual is required to engage in nonpreferred activities, as a consequence of that behavior. Positive punishment is effective in reducing a wide range of behaviors, but ethical and practical objections broadly restrict its therapeutic use.

See Also the Following Articles

Aversion Relief ■ Conditioned Reinforcement ■ Extinction ■ Functional Analysis of Behavior ■ Negative Practice ■ Negative Punishment ■ Negative Reinforcement ■ Operant Conditioning ■ Overcorrection ■ Positive Reinforcement ■ Self-Punishment

Further Reading

Axelrod, S., & Apsche, J. (1983). *The effects of punishment on human behavior*. New York: Academic Press.

Dinsmoor, J. A. (1998). Punishment. In W. O’Donohue (Ed.), *Learning and behavior therapy* (pp. 188–204). Boston: Allyn and Bacon.

- Guess, D., Helmstetter, E., Turnbull, H. R., III, & Knowlton, S. (1986). *Use of aversive procedures with persons who are disabled: An historical review and critical analysis*. Seattle, WA: Association for Persons with Severe Handicaps.
- Matson, J. L., & DiLorenzo, T. M. (1984). *Punishment and its alternatives: A new perspective for behavior modification*. New York: Springer.
- Matson, J. L., & Taras, M. E. (1989). A 20 year review of punishment and alternative methods to treat problem behaviors in developmentally disabled persons. *Research in Developmental Disabilities, 10*, 85–104.
- Miltenberger, R., & Fuqua, R. W. (1981). Overcorrection: Review and critical analysis. *The Behavior Analyst, 4*, 123–141.
- Repp, A. C., & Singh, N. (1990). *Perspectives on the use of nonaversive and aversive interventions for persons with developmental disabilities*. Sycamore, IL: Sycamore Publishing Company.
- Sidman, M. (1989). *Coercion and its fallout*. Boston: Authors Cooperative.
- Singer, G. H. S., Gert, B., & Koegel, R. L. (1999). A moral framework for analyzing the controversy over aversive behavioral interventions for people with severe mental retardation. *Journal of Positive Behavior Interventions, 1*, 88–100.
- Van Houten, R., Axelrod, S., Bailey, J. S., Favell, J. E., Foxx, R. M., Iwata, B., & Lovaas, O. I. (1988). The right to effective behavioral treatment. *Journal of Applied Behavior Analysis, 21*, 381–384.

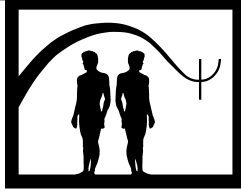

Positive Reinforcement

Alan Poling and Edward J. Daly III

Western Michigan University

- I. Description of Treatment
 - II. Theoretical Bases
 - III. Applications and Exclusions
 - IV. Empirical Studies
 - V. Case Illustration
 - VI. Summary
- Further Reading

GLOSSARY

chaining Reinforcing discrete responses in sequence so that all the behaviors occur as a single cohesive unit.

conditioned reinforcers Stimuli that acquire reinforcing properties through learning.

differential reinforcement of incompatible behavior A procedure in which a desired behavior that is incompatible with an undesired behavior is reinforced. The procedure is used to decrease undesired behavior and simultaneously increase desired behavior.

differential reinforcement of other behavior A procedure in which a reinforcer is delivered when a prespecified period passes without occurrence of an undesired response. The procedure is used to decrease undesired behavior.

primary positive reinforcers Stimuli that have reinforcing capacity in the absence of a special learning history.

prompt A verbal or physical antecedent that indicates to an individual how to respond in order to obtain reinforcement.

shaping Reinforcing successively closer approximations to a terminal, desired response.

Desirable as well as undesirable human behaviors often are operant responses, that is, they primarily are controlled by their consequences. Consequences are events (stimuli) that follow and are produced by a particular behavior. When the consequences of behavior make it more likely that such behavior will occur in a similar future context, or otherwise strengthen the behavior, the consequences are termed reinforcers and the process whereby responding is strengthened is termed reinforcement. Negative reinforcers strengthen behavior when responding removes them from the individual's environment, or prevents their occurrence. Positive reinforcers, in contrast, strengthen behavior when responding leads to their presentation.

Positive reinforcers can be learned (called conditioned or secondary) or unlearned (called unconditioned or primary). Stimuli that serve as primary positive reinforcers typically are of direct biological significance (e.g., food, water). Stimuli that serve as conditioned reinforcers do so because they precede the delivery of other reinforcers, or because of verbal mediation. Because people differ in their learning histories, the stimuli that serve as conditioned reinforcers differ substantially across people.

In a general sense, positive reinforcement comprises all procedures in which operant behavior is strengthened through the response-produced presentation of an object or event. Procedures based on positive reinforcement are useful in treating many kinds of behavioral problems in a wide range of client populations.

Moreover, understanding the role of reinforcement in the genesis and maintenance of inappropriate behavior is critical for understanding human psychopathology and for treating it effectively.

I. DESCRIPTION OF TREATMENT

Troublesome human behaviors generally can be categorized into those that involve the presence of inappropriate responses and those that involve the absence of appropriate responses. Because reinforcement by definition increases, or otherwise strengthens, responding, procedures based on positive reinforcement have an obvious role in treating individuals who fail to emit desired behaviors. To deal with such problems, a clinician typically begins by defining the desired behavior and selecting a measurement system that allows the behavior to be accurately quantified. Goals for performance of the desired behavior also are established at this point.

Next, a determination is made as to whether the absence of desired behavior involves a skill deficit or a performance deficit. In the former case, the client has not learned to perform the response. In the latter case, the client knows how to perform the response, but fails to do so. Often, the reason is that the desired behavior is not consistently reinforced in the client's everyday environment.

In many cases, planned reinforcement is used to treat performance deficiencies. For instance, an adult with mental retardation living in a group home may not regularly dress herself, even though she knows how to perform the task and does so on occasion. Making something valuable to the woman—perhaps tokens that can be exchanged for favored objects and activities—available only if she dresses herself appropriately each morning would in all likelihood lead to consistent self-dressing.

Treating a skill deficit typically begins with a task analysis, which involves breaking a complex behavior into its component parts. Dressing one's self, for example, begins with recognizing and laying out appropriate clothes and ends with fastening the final accouterment in place. Between the beginning and end of this chain of responses are many specific actions that depend on exactly what the person will be wearing. Several different procedures, all involving positive reinforcement, might be used in teaching a person to perform a new behavior, like dressing herself. Among them are shaping, modeling, prompting, chaining, and providing verbal instruction.

In shaping, successively closer approximations to the desired response are reinforced until the target (desired)

behavior emerges. To teach a person to pull up a zipper, for instance, one might ask the person to do so then observe their performance. If they grasped the tab and pulled the zipper halfway up, praise (a positive reinforcer) would be provided. On the next trial, however, praise would be withheld until the zipper was pulled more than halfway up. This process would be repeated until the zipper was fully closed. At that point, another response in the self-dressing sequence would be taught.

In prompting, physical or verbal guidance in performing a desired response is provided. If the woman in our example were verbal, the therapist might say, "Keep pulling hard," as the zipper was raised. The therapist might also place a hand over the client's hand and help her to pull the zipper. In modeling, someone performs the target (desired) response while being observed by the individual who is to learn that behavior. Our therapist might operate a zipper one or more times before asking the client to do so.

In chaining, discrete responses are reinforced in sequence to form complex behaviors that eventually occur as a single cohesive unit. The completion of one response provides a cue (i.e., a discriminative stimulus) for performing the next response in the sequence and, eventually, reinforcement is provided only when the chain of responses is complete. By the time the client has learned to dress herself, she might earn praise only at the end of a long and integrated sequence of responses.

Verbal instructions can serve as prompts but also can specify relations among stimuli (events and objects) and responses, thereby changing the function of those stimuli and responses. The therapist might, for instance, tell the client "Your green top and your black slacks really go well together—I love how you look in them." This statement might establish the top and slacks combination as a positive reinforcer, which the client values and will work to get to wear. Absent the therapist's statement, or given another kind of statement, such as "Your green top and your black slacks look crappy together—I hate how you look in them," wearing the top and slacks together would not serve as a positive reinforcer.

In many cases, a behavior that is appropriate in one context is not appropriate in another. Therefore, once new behavior is established under conditions where it is appropriate, steps often must be taken to ensure that it does not generalize to other, inappropriate, contexts. This can be accomplished through differential reinforcement, which entails reinforcing behavior in contexts where the behavior is appropriate, and failing to reinforce that behavior in other contexts. Teaching multiplication tables to a child labeled with a learning disability in mathematics provides a good example of differential

reinforcement at work. The child's saying "ten" is correct, and positively reinforced with praise ("that's right, good") when the child is reacting to " $5 \times 2 = \underline{\quad}$." But that response is incorrect and is followed by corrective feedback that is not reinforcing ("no, that's wrong") when the child is reacting to " $3 \times 2 = \underline{\quad}$." In this fashion, " $5 \times 2 = \underline{\quad}$ " is established as a discriminative stimulus for the verbal response "10." Differential reinforcement is used to establish stimulus control such that a particular response appears in the presence of appropriate stimuli, but not in their absence. In verbal humans, descriptions of appropriate stimulus control can sometimes be used as a substitute for actual differential reinforcement.

Positive reinforcement always strengthens the behavior that is reinforced, therefore, it may seem odd that procedures based on positive reinforcement can be used successfully to weaken undesirable behaviors. Two procedures that are frequently used in this way are called differential reinforcement of incompatible behavior (DRI) and differential reinforcement of other behavior (DRO) schedules. The DRI schedule makes use of the fact that some behaviors cannot occur simultaneously, therefore, increasing the rate of occurrence of one of these behaviors by reinforcing it also reduces the rate of occurrence of the other behavior. A client with a phobia cannot, for instance, simultaneously walk toward and avoid a feared object. So, by reinforcing approach responses, one can reduce avoidance responses.

The DRO schedule provides a reinforcer dependent on the passage of a specified period of time during which the behavior to be reduced does not appear; each time the behavior does occur, the interval is reset. If, for example, a DRO 5-min schedule is arranged to reduce self-stimulatory hand flapping by a person with autism, some positive reinforcer (perhaps a point on a counter that later could be exchanged for access to preferred music) would be delivered each time five consecutive minutes passed without a hand flap. This procedure should reduce the frequency of hand flaps relative to the preintervention level. But how can this be a reinforcement effect? The answer is that the unit of behavior that is strengthened is an interval of 5 min or longer without a hand flap. These units increase under the DRO and, as a result, incidents of hand flapping are reduced.

II. THEORETICAL BASES

A great deal is known about positive reinforcement. As discussed in the entry for operant conditioning, B. F. Skinner compared the selection of behavior by its con-

sequences to natural selection and emphasized that both entail processes of variation, selection, and retention. Studies by neuroscientists may reveal the physiological mechanisms through which these processes allow behavior to be strengthened by its consequences. Attempts have also been made to explain at other levels of analysis why certain stimuli are positively reinforcing under certain circumstances. None of these attempts is universally accepted.

Be that as it may, over the past 50 years thousands of studies have documented the importance of positive reinforcement in controlling behavior in nonhumans in laboratory settings, and in humans in laboratory settings, in everyday life, and in clinical applications. Positive reinforcement directly or indirectly plays a crucial role in the production of an incredible variety of human behaviors, both healthy and pathological. The variables that influence positive reinforcement have been studied extensively and clinical applications of positive reinforcement are for the most part based on the resultant knowledge. Put simply, there is unequivocal theoretical support for the clinical application of procedures based on positive reinforcement.

III. APPLICATIONS AND EXCLUSIONS

As noted in the previous section, positive reinforcement can be used in a variety of ways to increase desired behaviors and to arrange for those behaviors to occur only in appropriate contexts. Arranged in other ways, positive reinforcement can be used to reduce or eliminate undesired behavior. Given this breadth of application, positive reinforcement is potentially useful in dealing with the behavioral problems of all clinical populations. Issues of client diversity do not limit the general use of positive reinforcement, which is widely accepted, but particular cultures and individuals may object to specific procedures based on positive reinforcement. Moreover, cultures may vary with respect to the behaviors that they deem acceptable and unacceptable, and in the objects and events that serve as positive reinforcers.

Some individuals object to contrived reinforcement procedures, that is, those that do not occur naturally, as a form of bribery. Bribery is rewarding an individual so that she or he will behave in a corrupt way that benefits the person who delivers the reward. Therapeutic applications of positive reinforcement are intended to benefit the person whose behavior is reinforced, and the behavior that is reinforced is appropriate responding,

not unethical conduct. Positive reinforcement is not equivalent to bribery.

But, even if positive reinforcement is not bribery, certain critics claim that the purpose of using it is to control people's behavior, which to the critics is objectionable. It is true that the sole intent of therapists who use positive reinforcement, or, for that matter, any other psychological or psychiatric intervention, is to improve and in that sense "control" the client's behavior. But the control effected is such that the client's behavior, and as a result the quality of his or her life, improves. Moreover, the targeted changes in behavior characteristically are selected in consultation with the client, if she or he has the capacity to participate meaningfully in such decisions. If positive reinforcement is unacceptable because it controls clients, so are all therapeutic strategies.

Related to the foregoing concern is a third criticism of positive reinforcement, which is an ethical objection to rewarding people for doing "what they should do anyway." For example, Steve Higgins and his colleagues recently have had good success in treating cocaine abusers by paying them to produce drug-free urine samples. Although the procedure is relatively cheap as well as effective, some detractors claim that it is wrong to pay people not to engage in illegal behavior. People who raise this concern typically believe that individuals have the freedom to behave as they choose, and that those who behave inappropriately are ethically flawed and should be punished, not rewarded, for their shortcomings. Although this conception of human behavior has precedent in Western philosophy, theology, and jurisprudence, people who emphasize that much of human behavior is learned see it as little more than "blaming the victim."

A fourth criticism of positive reinforcement, one made popular by Edward Deci, is that the use of extrinsic reinforcers reduces an individual's "intrinsic motivation" to emit appropriate behavior. Such an effect has been demonstrated in a small number of studies in which children performed a task with no systematic reinforcement, then were reinforced for performing the task, and finally were retested with no systematic reinforcement. They worked less hard in the third condition than in the first, which is taken as evidence that extrinsic rewards (or reinforcers) reduced intrinsic motivation. In fact, the "intrinsic" motivation was acquired in large part as a result of prior reinforcement—people learn to do what they are asked to do because, historically, doing so was reinforced. In addition, the overwhelming majority of studies provide no evidence that positive reinforcement reduces people's intrinsic interest in tasks.

If the criticisms of positive reinforcement discussed earlier have little merit, why were they accorded so

much space? Only because behavior-change interventions based on positive reinforcement should be used even more widely than they are. Paul Chance makes this point very nicely in an anecdote related in his 1998 book, *First Course in Behavior Analysis*:

Once, when I was at a PTA meeting, the parents and teachers were discussing the problem of what to do about student misbehavior, which was getting worse and worse each year. The discussion focused on the kinds of punishment to provide for various offenses. They had compiled a list of student offenses and the consequences each offense should have. I made an innocent observation. "No one," I offered, "has said anything about what happens when a student behaves well. What about providing some *positive* consequences for *good* conduct?"

Some parents strongly opposed the idea. "Nobody gave *me* anything for behaving myself when I was in school," said one. But the fact that schools haven't been very good about reinforcing desirable behavior does not mean that they should not do so now. Their schools never used to use computers, but that hasn't kept us from putting them in the schools.

IV. EMPIRICAL STUDIES

A very large clinical literature has documented the efficacy of positive reinforcement, alone and in combination with other strategies, in treating behavior disorders. Because of the size of this literature, and because positive reinforcement plays a role in such a wide range of interventions, it is impossible to provide a simple and meaningful summary of the efficacy of "positive reinforcement procedures." It is, however, the case that procedures based primarily on positive reinforcement have been shown to be effective with a wide range of settings, target behaviors, and client populations.

A good understanding of the principles of operant conditioning is required to design effective positive reinforcement procedures. Although they are rarely reported in the literature, failed attempts at using positive reinforcement are common in the everyday world of education and clinical practice. These attempts fail when the events selected as positive reinforcers do not, in fact, have this function, and when the intervention team cannot control the delivery of events that do serve as reinforcers. They also fail when reinforcement is too delayed or too inconsistent, and when the rules that a person follows regarding the consequences of his or her behavior reduce sensitivity to these consequences. Occasionally, positive reinforcement procedures fail because of

their “side effects,” that is, the negative emotional responding, aggression, escape, and avoidance that poorly designed procedures can engender. Although people characteristically enjoy positive reinforcement, such adverse reactions can occur when response requirements are substantial and reinforcers are few.

V. CASE ILLUSTRATION

Positive reinforcement is an equal opportunity employer. In other words, it is responsible for maintaining both appropriate and inappropriate behaviors. When the natural environment fails to provide sources of reinforcement for appropriate behaviors, inappropriate behaviors may emerge through the same mechanisms that govern adaptive behaviors. That is, the same behavioral processes that support appropriate behaviors may engender inappropriate behavior. This is the case in the following example that, although fictitious, is representative of many studies demonstrating the reinforcing properties of social attention in the classroom.

Imagine a second-grade classroom where children are busily filling out their math worksheets. The teacher is going around the room, checking on the children’s work and assisting them as they need help. All of a sudden, there is an outburst. One of the children yells, “Give that back to me!” The teacher looks up and quickly becomes exasperated. Once again, Tommy is bothering another child. This time, he took Sarah’s pencil. Tommy looks in the direction of the teacher. The teacher says, “Tommy, you give that back to Sarah right away! Get back to work!” A sly grin crosses Tommy’s face. He complies, however, giving the pencil to Sarah and turning toward his paper. Tommy then looks at his blank paper. The numbers are almost as foreign to him as the crosses and dashes next to the numbers. He couldn’t write the correct answer even if he wanted to.

After about 2 min, Tommy gets out of his seat. The teacher is on him this time. He is barely one step away from his desk when the teacher yells, “Get back in your seat! You know that you are not allowed out of your seat without my permission.” Tommy begins to argue. He says, “My pencil is broken and I need to go to the bathroom,” whereupon many of the other students snicker audibly. The teacher responds by reciting the rules for Tommy. She then comes over to his desk to make comments about his incomplete school work. In some cases, a scenario like this can last all day long. It is no wonder that teachers reach their frustration limits sometimes. An understanding of the variables controlling Tommy’s behavior, however, may help

Tommy to get his work done and reduce his class disruptions. It also will probably make the teacher’s life easier if she is able to come up with an intervention that weakens or counteracts the primary controlling variable, social attention.

In this case, Tommy’s inappropriate behavior is strengthened by teacher attention, which functions as a positive reinforcer. Unfortunately, virtually all of the attention given to Tommy is dependent on inappropriate behavior. In the scenario described earlier, there was not a single instance where social attention followed appropriate behavior. Every instance of inappropriate behavior, in contrast, produced attention. Therefore, we can conclude that Tommy’s disruptive behavior is maintained by positive reinforcement in the form of teacher attention, and perhaps peer attention. One common, erroneous assumption is that positive reinforcement is “positive” in an evaluative sense. It is not.

In the case example, if the teacher is reflective or refers to a consultant who is knowledgeable about principles of behavior, she might be able to distribute her attention differently to promote more productive classroom behaviors. For example, she might praise Tommy for attempts to solve problems while ignoring (i.e., arranging extinction for) his inappropriate behaviors. In the process, she will probably discover that Tommy can’t do the problems without assistance. Therefore, some additional instruction may be necessary. If she is consistent and if Tommy receives social attention for appropriate behaviors (e.g., numbers written on the page, holding his pencil appropriately) frequently enough to compete with the reinforcing effects of peers’ attention for inappropriate behavior, the teacher may witness an increase in appropriate behavior and a decrease in inappropriate behavior.

It will be important for the teacher to keep in mind that Tommy’s problem behaviors were strengthened over time and that they may be resistant to extinction for a period. In fact, they may increase briefly if the teacher stops providing social attention for inappropriate behavior. This fact alone is often the reason why adults stop an intervention quickly and conclude, “I tried that but it didn’t work.”

VI. SUMMARY

Positive reinforcement comprises all procedures in which behavior is strengthened through the response-produced presentation of an object or event. Such procedures can be used to increase desired behavior and to cause it to occur only in appropriate circumstances.

They also can be used to decrease undesired behavior. Thousands of studies document their efficacy with a wide range of clients and target behaviors in many different settings. Although they are not panaceas, positive reinforcement procedures are widely and effectively used by applied behavior analysts and other clinicians.

See Also the Following Articles

Chaining ■ Classical Conditioning ■ Extinction ■
Negative Punishment ■ Negative Reinforcement ■
Operant Conditioning ■ Positive Punishment

Further Reading

- Carton, J. S. (1996). The differential effects of tangible rewards and praise on intrinsic motivation: A comparison of cognitive evaluation theory and operant theory. *The Behavior Analyst, 19*, 237–255.
- Catania, A. C. (1998). *Learning* (4th ed.). Upper Saddle River, NJ: Prentice Hall.
- Eisenberger, R., & Cameron, J. (1996). Detrimental effects of reward: Reality or myth? *American Psychologist, 51*, 1153–1166.
- Sulzer-Azaroff, B., & Mayer, G. R. (1991). *Behavior analysis for lasting change*. Fort Worth, TX: Holt, Rinehart, & Winston.



Posttraumatic Stress Disorder

Ann E. Norwood and Robert J. Ursano

Uniformed Services University of the Health Sciences

- I. Introduction
 - II. Psychodynamic Therapies
 - III. Cognitive Behavioral Therapies
 - IV. Summary
- Further Reading

GLOSSARY

cognitive-behavioral therapies A wide range of programs including anxiety management, exposure treatments, cognitive restructuring, and combinations of these.

cognitive processing therapy A treatment designed especially for female sexual assault victims and uses features of exposure therapy and cognitive therapy.

diagnostic and statistical manual A manual of psychiatric diagnoses and statistics that has been published in multiple editions by the American Psychiatric Press, Inc.

eye-movement desensitization/reprocessing therapy A treatment in which trauma survivors are asked to recall disturbing elements of the trauma while the therapist invokes saccadic eye movements.

exposure therapy A form of therapy that consists of exposure to anxiety-provoking stimuli.

impact of events scale A scale that assesses PTSD symptoms.

stress inoculation training A treatment in which patients learn to manage anxiety that is conditioned at the time of the trauma and then generalized to many situations.

I. INTRODUCTION

The diagnosis of posttraumatic stress disorder (PTSD) was introduced into the *Diagnostic and Statistical Man-*

ual (DSM) as an anxiety disorder in 1980. In the current *DSM* (fourth edition), there are six major diagnostic criteria for PTSD. First, the person must be exposed to a traumatic event in which they experienced or witnessed an event that involved the threat of death or serious injury, and the individual must have experienced significant fear, helplessness, or horror in response to the event. The major symptom criteria are persistent reexperiencing of the event, persistent emotional numbing and avoidance of stimuli associated with the trauma, and persistent arousal symptoms. The duration of the symptoms must be 1 month or more and must cause significant distress or impairment.

Traumatic events occur more often than one might expect. For example, it has been estimated that 7% of the U.S. population is exposed to a major trauma on an annual basis. Lifetime trauma exposure rates in populations are often 50 to 80%. Those who have been exposed to a traumatic event are at risk for developing PTSD and other major psychiatric disorders. Epidemiological studies have found that one-third of women who were sexually assaulted experienced PTSD at some point in their lifetime. Similar rates were found for lifetime PTSD in Vietnam veterans.

A variety of treatments have been used for PTSD. Recent neuroimaging, neurophysiological, and neuroendocrine studies have suggested that PTSD creates biological alterations. These findings have prompted clinicians to investigate the usefulness of pharmacological interventions. However, psychotherapy remains

the primary treatment of most PTSD, particularly acute PTSD. This chapter focuses on psychotherapeutic interventions for PTSD. Work on group psychotherapy and debriefing are less systematic and are not reviewed.

II. PSYCHODYNAMIC THERAPIES

A. Description of Treatment

In their 2000 review, Harold S. Kudler, Arthur S. Blank Jr., and Janice L. Krupnick summarized the theoretical basis and research findings of the use of psychodynamic psychotherapy in the treatment of PTSD. They note that brief psychodynamic therapy, as developed by James Mann, can be particularly useful in work with trauma survivors to explore issues of separation and loss. Mardi Horowitz developed a brief psychodynamic psychotherapy specifically for the treatment of trauma survivors. It is a transference-based, 12-session model that focuses on the ways in which the trauma survivor's preexisting personality style and psychological defenses interact with the traumatic experience to affect relationships especially in the context of the therapeutic relationship. Later, Charles Marmar and Michael Freeman developed a brief treatment based on Horowitz's ideas to manage narcissistic regression in the face of trauma. Also building on Horowitz's work, Daniel Brom, Rolf Kleber, and Peter Defares developed a manual on brief psychodynamic psychotherapy for PTSD. Horowitz recently revised his manual on brief psychodynamic therapies for stress response syndromes. His technique is a multimodal brief approach. In this model, systematic case formulations guide decisions on when to use behavioral techniques, cognitive techniques, and/or supportive and expressive dynamic techniques.

In supportive psychotherapy, which is built on the principles of psychodynamic psychotherapy, the therapist's knowledge of defensive structures and transference informs his or her work with PTSD. The defenses against intrusive withdrawal and arousal are strengthened through education, identification of successful defense operations, and attention to interpersonal withdrawal.

Interpersonal therapy is a time-limited, manualized treatment, which incorporates supportive elements into a psychodynamic approach. Rather than focusing on the transference, the therapist explores the patient's relationship with other people as the avenue to identify distress and interpersonal withdrawal. Work is underway to use interpersonal therapy as a group treatment for women with PTSD following sexual or physical assault/abuse.

B. Theoretical Bases

Josef Breuer and Sigmund Freud, in their 1895 *Studies in Hysteria*, proposed that psychological trauma can create psychiatric illness. They hypothesized that if the traumatic memory could be found and removed, the patient would be cured. Later, Freud speculated that hysterical patients defended against their traumatic memories by maintaining them outside of conscious awareness (repression). Physical and psychological symptoms represented a compromise that partially expressed the memory and also expressed the ego's defense against the memory and the feelings accompanying it. Influenced by World War I, Freud attributed psychological trauma to a breakdown in a psychic stimulus barrier in *Beyond the Pleasure Principle*. Trauma survivors' intrusive and avoidant symptoms (essential features of PTSD) were viewed as biphasic attempts to cope with the trauma. Freud hypothesized that survivors repeated the memories in the hope of mastering them (repetition compulsion). Both world wars compelled many therapists to further develop theoretical models and treatments. Abreactive techniques using sodium amytal and hypnosis were paired with support and psychoeducation to treat combat fatigue. Henry Krystal and Robert Jay Lifton documented that overwhelming life events could result in a kind of "death in life." Krystal developed an information-processing model of trauma that postulated that overwhelming events can disable the psyche's ability to use anxiety as a signal for the mobilization of defense. Once this system is disrupted, anxiety and other affects fail to serve psychic needs. Affect may become muted, overwhelming, or inappropriate. The ego, without its normal signal processing, is virtually defenseless. One possible outcome described was alexithymia (a profound disconnection between words and feelings).

More recent approaches focus on psychodynamic psychotherapy's attempt to understand and work through the meaning of symptoms. Reminders represent meaningful fears. Psychodynamic therapy also focuses on the experience of guilt, shame, and interpersonal avoidance. These feelings usually carry associated memories of early life experiences that have become attached to the recent events. Even events after the traumatic event, such as a diagnosis of cancer, can enter the meaning network and become a primary source of sustaining the PTSD symptoms. Attention to the meaning network and its anxiety, defense and transference patterns can aid in dissecting the symptoms from their sources. Attention to the complex countertransference responses

of the therapist when treating trauma victims is a major theoretical perspective adopted by all psychotherapies of PTSD.

C. Empirical Studies

Empirical studies of psychodynamic psychotherapy of PTSD are few. During 1993–1995, Mardi Horowitz and his colleagues published work that examined the hypothesis that trauma survivors experienced heightened intrusive and avoidant symptoms related to traumatic memories and themes. The brief psychodynamic psychotherapy that was provided was manualized. They found that when a topic linked to the traumatic event was discussed, it was accompanied by intrusion and avoidance, warding off behaviors, stifling of facial emotional expression, emotionality, and fragmentation of important ideas.

In 1997, Susan Roth and Ronald Batson evaluated a year-long psychodynamic treatment of six adult female survivors of childhood incest with PTSD. There was significant clinical improvement in their diagnoses, trauma themes, and PTSD symptoms.

In 1989, Daniel Brom, Rolf Kelber, and Peter Defares compared the efficacy of trauma desensitization, hypnotherapy, and a brief psychodynamic therapy (based on Horowitz's model) in reducing PTSD symptoms of intrusion and avoidance in 112 survivors of associated traumas and wait-list controls. One limitation of the study was that not all subjects met *DSM-III* criteria for PTSD. They found a reduction in symptoms on the Impact of Events Scale (IES) using desensitization that was higher than the improvement in the other treatments, but was not statistically significant.

D. Clinical Studies

In 1988, Jacob Lindy reported on 37 Vietnam combat veterans, who were treated for PTSD that met *DSM-III* diagnostic criteria. The participants' psychological function and combat experience were assessed. These combat veterans were compared to a volunteer sample of Vietnam veterans who were recruited from clinical and nonclinical sources ($n = 200$). There was no placebo comparison group, and assignment was not randomized. Treatment was manualized and consisted of opening, working through, and termination phases. Twenty-three of the participants completed the treatment. Significant changes were noted on the Psychiatric Evaluation Form (based on clinical ratings made by independent clinicians, on global ratings made by

both patients and therapists), and on the Symptom Checklist-90, the Impact of Events scale, and the Cincinnati Stress Response Schedule).

In 1993, Daniel S. Weiss and Charles Marmar described a 12-session, manualized psychodynamic treatment for adult survivors of single traumatic events. Systematic outcome measures were not used. They reported on results in work with over 200 patients.

E. Summary

Psychodynamic psychotherapy remains a major part of the psychotherapy of PTSD, particularly complex chronic PTSD in which meanings of the trauma have been generalized to the individual's past and present. The unique focus of psychodynamic psychotherapy on the complex countertransference experience with PTSD patients has been widely adopted across all psychotherapies. Psychodynamically informed supportive psychotherapy is perhaps the most widely used form of treatment in severe chronic PTSD with multiple comorbid disorders and in which psychopharmacologic agents are important symptom-reducing factors.

III. COGNITIVE-BEHAVIORAL THERAPIES

Cognitive-behavioral therapies (CBT) have been used widely in the treatment of PTSD and are the most rigorously studied to date. CBT encompasses a wide range of programs, including anxiety management, exposure treatments, cognitive restructuring, and combinations of these. Edna Foa has been instrumental in the use of CBT for PTSD and strengthening research methodologies of psychotherapeutic treatment of PTSD.

A. Exposure Therapy

1. Prolonged Imaginal and in Vivo Exposure Therapy

a. Description of Treatment Exposure therapy consists of exposure to anxiety-provoking stimuli. The core feature of all these methods is that the person is confronted by the frightening stimuli until his or her anxiety dissipates. There are a number of different techniques, which vary in terms of whether the stimulus is real or imaginal; whether the length of the exposure is short or long, and how much anxiety the subject experiences during the exposure (e.g., high for flooding, moderate to low for desensitization). Generally, a

hierarchy of anxiety-causing stimuli is developed. Two types of exposures are employed, imaginal and *in vivo*. Imaginal exposure generally consists of the patient talking about the trauma as if it is happening in the present. In contrast, *in vivo* exposure entails the patient confronting situations that are objectively safe, but have been avoided due to fear generalized from the original trauma. For example, if a person were robbed on the subway and continued to avoid it, the goal of exposure would be for the person to ultimately return to the subway. Flooding begins with exposure to the strongest anxiety-provoking item, whereas other systematic desensitization begins with items of low intensity. Exposure therapy is often used in combination with other components such as relaxation training.

b. Theoretical Basis Exposure therapy is based on learning theory. It has been used very successfully in the treatment of phobias. Because PTSD shares features of phobic disorders, it was hypothesized that exposure therapy would be of benefit for PTSD. Elements of PTSD are believed to be conditioned. Using the classical conditioning paradigm, the trauma (unconditional stimulus) is paired with a neutral stimulus, for example darkness. The previously neutral stimulus, darkness, now becomes a conditioned stimulus associated with a conditioned fear response. Operant conditioning maintains the fear as the traumatized individual used avoidance (e.g., not going out after dark) to diminish anxiety and fear. The avoidant behavior, itself, perpetuates the fear and anxiety. By forcing the traumatized individual to face the conditioned stimulus (threat), the patient learns that the conditioned stimulus no longer needs to be avoided.

c. Empirical Studies There have been 12 studies on the use of imaginal and *in vivo* exposure therapy for PTSD, 8 of which meet the most stringent criteria for methodology. Four well-controlled studies and two uncontrolled studies of the use of exposure therapy with Vietnam veterans have been conducted. All found positive results. There have been two well-controlled studies examining the effects of exposure therapy with female rape victims, which also found improvement in symptomatology. In addition, four studies have examined exposure therapy's efficacy for a variety of other traumas.

d. Summary Studies of exposure therapy have demonstrated the strong data supporting efficacy of exposure treatments for PTSD. Imaginal exposure has generally become a part of all psychotherapies as the therapist frequently brings the patient back to the traumatic event to talk, recall, reconstruct, and reexperience in a safe controlled manner the events and their subsequent consequences. It has been important to recognize that a traumatic event is rarely a single moment in time. Therefore, identifying the traumatic event as it extended over time means exposure can be more complex than it may first appear.

matic event to talk, recall, reconstruct, and reexperience in a safe controlled manner the events and their subsequent consequences. It has been important to recognize that a traumatic event is rarely a single moment in time. Therefore, identifying the traumatic event as it extended over time means exposure can be more complex than it may first appear.

2. Eye-Movement Desensitization/Reprocessing (EMDR)

EMDR, developed by Francine Shapiro in 1995, incorporates elements of imaginal exposure therapy. In this treatment, trauma survivors are asked to recall disturbing elements of the trauma while the therapist moves a finger back and forth in front of the patient's eyes. The resultant saccadic eye movements in conjunction with the disturbing images are hypothesized to result in neural reprocessing of the trauma and symptom resolution. There has been substantial controversy surrounding this treatment, focusing primarily on the theoretical basis regarding the role of eye movements. Research findings have been mixed on its efficacy but have suggested that improvement is more likely due to the exposure therapy elements rather than the eye movements.

3. Systematic Desensitization

a. Description of Treatment Systematic desensitization is a form of exposure therapy developed by Joseph Wolpe in 1958. Based on reciprocal inhibition, it posits that an individual cannot be relaxed and anxious simultaneously. A hierarchy of the patient's fears is developed. In the first part of the therapy, the patient is taught relaxation training. Once proficiency in relaxation is attained, the patient is gradually exposed to the trauma-related items that frighten him or her, starting with the least feared situation object or memory. The patient is instructed to note the onset of anxiety symptoms, and the treatment is paused while the patient initiates relaxation techniques. When the patient has regained a sense of comfort, the exposure resumes. This cycle continues until the patient can tolerate all the stimuli on the fear hierarchy without anxiety.

b. Empirical Studies While there have been six studies of systematic desensitization for the treatment of traumatic stress reactions, however, only the 1989 study by Daniel Brom, Rolf Kleber, and Peter Defares (described earlier) was well controlled.

c. Summary Although several studies have found that systematic desensitization was effective in reducing

trauma-related symptom, the studies suffer methodological problems. Most researchers have moved away from systematic desensitization, preferring exposure therapy. These two approaches have much in common and emphasize the importance of understanding and working with the actual events of the trauma and the cognitive and emotional responses.

B. Cognitive Therapy

1. Description of Treatment

Cognitive therapy was developed in 1976 by Aaron Beck for the treatment of depression and was later applied to the treatment of anxiety. Beck theorized that it is the individual's appraisal or interpretation of an event, rather than the event itself that determines mood states. "Automatic thoughts" are dysfunctional thoughts that interpret events with a negative bias that, in turn, contribute to negative feelings such as anxiety, depression, anger, and shame. In cognitive therapy, patients are taught to identify these automatic thoughts, challenge those that are unhelpful or inaccurate, and replace them with more accurate or beneficial thoughts. For patients with PTSD, it has been postulated that patients see the world as a dangerous place and view themselves as incompetent to navigate it. In order to be successful, treatments for PTSD are believed to need to change these distorted cognitions. Treatment programs are particularly focused on patients' self-concepts and appraisal of safety. A specific form of cognitive therapy, cognitive processing therapy, for sexual assault victims with PTSD has been suggested. This model focuses on correcting dysfunctional cognitions thought to be common in rape victims related to self-esteem, safety, trust, power, and intimacy.

2. Empirical Studies

One well-controlled study found that cognitive therapy, exposure therapy, and the combination of the two were all equally effective but more effective than relaxation therapy for patients who had sustained various traumas. Another study comparing cognitive therapy and systematic desensitization with wait-list controls, found cognitive therapy and systematic desensitization to be equally effective and superior to the wait-list controls. A third study found cognitive therapy to be as effective as exposure therapy in producing improvement relative to pretreatment for survivors of a variety of traumas.

3. Summary

Two controlled studies have demonstrated that cognitive therapy is effective in reducing trauma-related

symptoms. Cognitive therapy focuses on the effects of the traumatic event as it spreads through time and across personality dimensions. In general, the cognitive therapies and the psychodynamic therapies often overlap on their goal to alter appraisals although their techniques differ.

C. Cognitive Processing Therapy

1. Description of Treatment

Cognitive process therapy (CPT) has components of exposure therapy and cognitive therapy. Patricia Resick and Monica Schnicke developed CPT specifically for rape-related PTSD. The exposure element consists of developing and reading a detailed history of the rape. This narrative is used to discover "stuck points," elements of the rape that challenge previously held beliefs or are especially difficult to accept. These "stuck points" are then addressed in the cognitive component. The cognitive component teaches patient skills in examining and challenging distorted cognitions, for example, self-blame, and attempts at "undoing" the event.

2. Empirical Studies

In 1992, Resick and Schnicke reported that cognitive processing therapy was effective in reducing PTSD and related symptoms in 19 female sexual assault survivors compared to a wait-list control group. This study was not randomized.

3. Summary

Cognitive processing therapy has only been used with women who have been sexually assaulted. Because it was designed specifically for this population, it requires modification for use in other settings.

D. Anxiety Management Therapies

In contrast to the other therapies described in this chapter, anxiety management therapies do not aim to change underlying beliefs or structures that maintain PTSD. Rather, their goal is to teach patients to manage their symptoms.

1. Stress Inoculation Training

a. Description/Theory In 1974, Donald Meichenbaum developed stress inoculation training (SIT) as an anxiety management treatment. SIT assists patients in learning to manage anxiety that is conditioned at the time of the trauma and then generalizes to many situations. Dean Kilpatrick, Lois Veronen, and Patricia

Resick modified the program to treat victims of sexual assault. Their program included training in muscle relaxation and breathing, education, guided self-dialogue, and thought stopping.

b. Empirical Studies All four studies of stress inoculation training have used women who have been sexually assaulted as subjects. Two studies had excellent methodology whereas two were less well controlled. As noted earlier in this chapter, Edna Foa has performed some of the most rigorous studies in the field. She and her colleagues have found that nine 90-min sessions of stress inoculation training were effective in reducing PTSD. SIT was also found to be as effective as peer counseling in a study by another group. A study comparing SIT with supportive therapy and assertiveness training, found them all to be equally effective.

c. Summary Although stress inoculation training has been shown to be efficacious in treating women who have been sexually assaulted, it is unclear whether this finding can be generalized to other trauma populations. In general, SIT is often seen as a combination of cognitive, behavioral, and relaxation elements.

2. Biofeedback and Relaxation Training

Biofeedback and relaxation therapy have also been used as techniques for managing anxiety for patients with PTSD. In biofeedback, patients learn to control their physiological responses. They learn to decrease muscle tension by watching their electromyographic (EMG) activity change on a monitor. Only one study has examined biofeedback in a controlled design, comparing it to eye-movement desensitization and reprocessing (EMDR) plus milieu and to relaxation therapy plus milieu. Biofeedback was not found to be effective. EMDR in conjunction with milieu therapy was more effective. Another group used a combination of biofeedback and relaxation training to treat six Vietnam veterans with PTSD. They reported symptom improvement on all measures. Biofeedback was also found to be helpful in reducing muscle tension, nightmares, and flashbacks in another group of Vietnam veterans.

IV. SUMMARY

The psychotherapeutic treatment of PTSD is increasingly studied with rigorous methodological designs. No studies have rigorously evaluated combined psychotherapeutic and medication treatments. Across the psychotherapies, there is a developing consensus on the need to attend to the specifics of the traumatic event. The interpersonal experience over time after the event, the meaning of the traumatic event, distortions of interpersonal and emotional perspective that derive from the experience of the trauma and for therapists to be alert to the countertransference issues in these often profoundly terrorized patients. The complex comorbidity often seen in PTSD also means that multiple therapeutic modalities are often needed in treatment.

See Also the Following Articles

Anxiety Disorders: Brief Intensive Group Cognitive Behavior Therapy ■ Biofeedback ■ Cognitive Behavior Therapy ■ Exposure ■ Eye Movement Desensitization and Reprocessing ■ Relaxation Training ■ Self-Control Desensitization ■ Trauma Management Therapy

Further Reading

- Foa, E. B. (2000). Psychosocial treatment of posttraumatic stress disorder. *Journal of Clinical Psychiatry*, 61(5), 43–48.
- Foa, E. B., Keane, T. M., & Friedman, M. J. (2000). *Effective treatments for PTSD*. New York: Guilford Press.
- Fullerton, C. S., & Ursano, R. J. (Eds.). *Posttraumatic stress disorder: Acute and long-term responses to trauma and disaster*. Washington, DC: American Psychiatric Press.
- Lindy, J. (1988). *Vietnam: A casebook*. New York: Brunner/Mazel.
- Raphael, B. & Wilson, J. P. (2000). *Psychological Debriefing*. Cambridge, England: Cambridge University Press.
- Saigh, P. A., & Bremner, J. D. (1999). *Posttraumatic stress disorder: A comprehensive text*. Boston: Allyn and Bacon.
- Sonnenberg, S. M., Blank, A. S., & Talbot, J. A. (1985). *The trauma of war*. Washington, DC: American Psychiatric Press.
- Young, B., & Blake, D. (Eds.). (1999). *Group treatments for posttraumatic stress disorder*. New York: Brunner/Mazel.

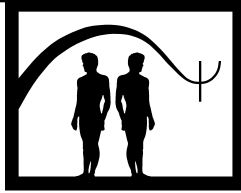

Primary Care Behavioral Pediatrics

Patrick C. Friman

University of Nevada, Reno

Nathan Blum

Children's Seashore House
of Children's Hospital of Philadelphia

- I. Description of PCBP Treatment
 - II. Theoretical Bases
 - III. Applications and Exclusions
 - IV. Empirical Studies
 - V. Case Illustration
 - VI. Summary
- Further Reading

within series ABAB experimental design An experimental method applied to single subjects wherein the subject is intermittently exposed to treatment and no-treatment conditions. Differences in behavior observed during the varying conditions form the basis for conclusions about the effectiveness of treatment.

GLOSSARY

Berkson's bias The tendency in clinical research to study clinical populations with compound problems, especially hospitalized populations. The findings from the pertinent study are skewed because of the severity of the study groups.

encopresis Frequent fecal accidents occurring after the age of 5 and not due to an organic condition.

enuresis Frequent urinary accidents occurring after the age of 5 and not due to an organic condition.

incontinence Urinary or fecal incidents that occur in clothing or bedding.

primary care Branch of medicine devoted to prevention and early intervention.

temperament An aspect of a person's behavioral style that is more inherited than learned. Temperamental characteristics involve dispositions toward emotional reactions, mood shifts, and sensitivity to stimulation.

Tourette's syndrome An impulse control disorder involving the habitual emission of vocal sounds and motor movements referred to as tics. The tics sometimes involve obscene gestures or words.

trichotillomania Habitual hair pulling preceded by a mounting urge to pull and accompanied by detectable hair loss.

Behavioral pediatrics is the branch of pediatrics that addresses child behavior problems that populate the intersection between clinical child psychology, child psychiatry, and pediatric health care. Although problems of importance to behavioral pediatrics occur across all domains of medicine, the field upholds the longstanding tradition in pediatric medicine of emphasizing prevention over treatment or rehabilitation. In the words of Stanford Friedman, an early architect of the field of behavioral pediatrics, "curative and rehabilitative orientation (is) always second best to preventing the disease or defect in the first place...". This chapter focuses on the evaluation and treatment of child behavior problems that initially, and often only, present in primary care. We will refer to this as primary care behavioral pediatrics (PCBP). PCBP is an eclectic field but most practitioners are either primary care pediatricians who take a special interest in the management of behavior problems in their practices or pediatric psychologists whose practice includes close collaboration with their clients' primary care physicians.

I. DESCRIPTION OF PCBP TREATMENT

The term psychotherapy may not be appropriate for PCBP; it is grounded in a context of psychopathology or mental illness and is thus inconsistent with the preventive context of PCBP. Many definitions for psychotherapy exist but the most traditional and widely held involve primarily verbally based, processed-oriented treatment the goal of which is remediation of psychopathology or mental illness. In many cases the behavior problems seen in primary care are not indications of child psychopathology or mental illness. Rather they arise out of problematic interactions between children and their environment. For example, confident, experienced parents with abundant social support may not view their 8-week-old child's crying for 2 to 3 hours a day, which is less than one standard deviation above the expected mean for daily duration of crying for children this age, as a problem. However, less confident, experienced, and supported parents may interpret the same amount of crying in their similarly aged child not only as a serious problem but also as indictment of their parenting skills. These less experienced parents, however, might be unconcerned if the crying averaged only 1 to 2 hours a day (slightly less than the expected mean). Thus it would be inappropriate to assume that the crying, the average daily duration of which is above the mean but well within the range of normal, is an indication of psychological disturbance in the child or skill deficiencies in the parents. Providing health education about the extent to which behaviors such as extended crying are part of the normal variations in a child's life is an important part of PCBP practice and one we will discuss in greater detail later in the chapter.

Having emphasized that many behavior problems seen in PCBP are not reflective of psychopathology, it is also important to note that PCBP acknowledges the existence and importance of child psychopathology. The PCBP view, however, is that although the presence of psychopathology is always accompanied by behavior problems, the reverse is not necessarily true, especially for problems initially presenting in PCBP. Nonetheless, at least some of the problems presenting in PCBP are reflective of psychopathology and thus PCBP practitioners must be able to recognize when children have major disorders and be willing to refer those children to specialists. Moreover, a fundamental reason PCBP is viewed as preventive care is based on the belief that persistence of problematic interactions between chil-

dren and their environment increases the likelihood that psychopathology will develop. The care provided for problems presenting in PCBP involves two intersected kinds of intervention, supportive counseling and prescriptive behavioral treatment.

A. Supportive Counseling

The primary goals of supportive counseling in PCBP are to provide emotional support and health education. To be effective, practitioners must be able to communicate care and compassion for parents of children exhibiting problem behaviors and an appreciation for the distress and disharmony those problems cause the family. Additionally, practitioners must have informative and persuasive answers for the parents' questions about the problems and a prime function those answers must serve is demystification. Parents want to know why their child is exhibiting the problematic behaviors and typically the answers they obtain on their own are overly pessimistic. Fortunately, many troubling aspects of childhood are actually normal and expected. For example, extended crying in the first 3 months, although stressful, is normal. Incontinence in children younger than 5, although unpleasant, is normal especially for boys. Limit testing, although exasperating, is common throughout early childhood. Separation anxiety spikes between 11 and 14 months, negativism is common in the second and third year, and thumb sucking is prevalent and harmless up to age 4. There are many other examples. The successful PCBP practitioner is knowledgeable about most or all of these and can communicate that knowledge in a respectful, accepting, and compassionate way.

In some cases supportive counseling is sufficient to address the presenting complaints. PCBP practitioners can reassure parents of a child presenting with behavior problems by informing them that the problems are not unusual at their child's age and are likely to resolve within specified age limits. For example, separation anxiety diminishes after 14 months in most children. However, if the problems persist (or emerge) beyond these age limits, substantially worsen, or begin to cause health concerns, supportive counseling is supplemented by prescriptive behavioral treatment recommendations.

B. Prescriptive Behavioral Treatment

When a child behavior problem presents in PCBP, practitioners place it in its appropriate developmental and prognostic context via supportive counseling (as in-

licated above). If the problem does not involve one of the major psychiatric conditions (e.g., major depression) at the boundary of PCBP, practitioners recommend a series of therapeutic steps to be followed at home (or school) to address the problem. The therapeutic advice typically emphasizes procedure over process and most procedures recommended are derived from the more pragmatic parts of the behavioral sciences, particularly those focused on learning and development. For example, according to Edward Christophersen, another major architect of the field, "Behavioral pediatrics is the application of the principles and procedures of the behavioral sciences to the prevention or resolution of problems encountered in the practice of pediatrics." Prescriptive behavioral treatments are the primary methods PCBP practitioners employ to remedy behavior problems. Treatments that work are valued for their own sake and their importance is not diminished because they are at odds with this or that theory. Efficiency, effectiveness, and acceptance are valued over and above theoretical consistency, precision, and scope. Furthermore, PCBP treatment, although predominantly verbal and thus consistent topographically with traditional child psychotherapy, differs from it in at least two important ways.

First and perhaps most fundamental, parents (or primary caregivers) rather than children are the direct recipients of treatment (i.e., supportive counseling and the recommendations that make up the prescriptive behavioral treatment regimens). Children are, of course, the ultimate recipients of PCBP treatment, regardless of its form and they are often present during its discussion and even participate in its preparation. But the most common vehicle for PCBP treatment is educational and prescriptive advice pertaining to the parent portion of parent-child interactions. Although the comparison is not perfect, it may be helpful to view PCBP treatment as a specialized form of parent training. The critical point, however, is that although child problems are the reason for PCBP treatment, parents are the proximal recipients of the therapeutic advice pertaining to those problems. Thus PCBP treatment is fundamentally different from traditional child psychotherapy wherein the child is the direct recipient of treatment.

Second, because of limitations on time and the emphasis on procedure in pediatric settings, PCBP treatments are often brief and protocol driven. In this respect they differ dramatically from the process-based, time-intensive interventions that characterize traditional child psychotherapy. PCBP treatment, however, is consonant with the increasing emphasis on empirically supported treatment and manualized practice in

contemporary psychotherapy. The therapeutic armamentarium of the PCBP practitioners includes a variety of procedures each with abundant empirical support including (but not limited to) time out, contingency management, home-school notes, simple point systems, and various procedures for simple habits, chronic incontinence, bedtime struggles, and feeding problems.

C. More on the Practitioners

Because of the preventive emphasis in PCBP, clinical expertise in the treatment of major psychiatric problems of childhood is not a prerequisite for practitioners in the field. PCBP therapists, however, must have a strong appreciation for the variations commonly seen in normal child development, which then allows them to distinguish behavior problems that are best viewed as interactional from those that represent psychopathology. For example, hair play, twirling, and pulling in toddlers, although potentially problematic and certainly important enough to address in a PCBP visit, is not necessarily reflective of psychopathology or indicative of true trichotillomania. But compulsive hair pulling of long standing in a 12-year-old girl is a much more serious condition, one typically requiring more intensive care than that provided in PCBP. Thumb sucking in preschoolers is more likely a benign source of self-soothing than a malignant sign of oral fixation or regressive personality disorder. But chronic sucking in a school-aged child can be a serious problem and should, at a minimum, be regarded as a threat to optimal social development. Soiling in young children is much more likely to result from constipation than from psychic mechanisms such as resentment, regression, or anal fixation. Yet soiling in older children unaccompanied by constipation is likely to be the result of potentially serious psychogenic variables and unlikely to respond to a procedure-based PCBP treatment. There are many other examples.

Another important qualification for PCBP therapists is working knowledge of the biologic variables that are functionally related to child behavior problems. Many of the behavior problems managed in PCBP have important biologic dimensions (e.g., enuresis, encopresis, recurrent abdominal pain). To be effective, PCBP practitioners must at a minimum have a rudimentary understanding of variables such as bowel and bladder function, sleep physiology, and pain sensation.

Because the child problems that are appropriate for PCBP are diverse, the field is professionally eclectic. Thus primary care physicians (e.g., pediatricians, family

practitioners) can specialize in behavioral pediatrics just as readily as pediatric, school, and clinical child psychologists or psychiatrists. And there are a growing number of specialized training programs for these various types of professionals. The limited emphasis on psychopathology and the eclectic makeup of the field make the PCBP orientation to child behavior problems a novel, perhaps even unusual, but nonetheless important candidate for an encyclopedia on psychotherapy.

Generally PCBP will favor those whose orientation to practice is guided by science more than art, whose claim to expertise is predicated on empiricism more than clinical or ex cathedra authority, and whose methods are typified more by procedure than process. Thus, there are similarities between therapists in PCBP and those in some branches of psychology (e.g., behavior therapy, applied behavior analysis, pediatric psychology) but not those in others (e.g., psychoanalysis, existentialist psychology, human potential psychology).

II. THEORETICAL BASES

Coverage of all the theoretical bases that underlie PCBP is beyond the scope of this chapter. Because of its inherent pragmatism and largely agnostic stance toward most psychological theories, virtually all of the principles of behavior, learning, and development that could be exploited for therapeutic benefit are potentially part of the theoretical base. Rather than providing shallow coverage of a large number of relevant principles, we will more fully cover four basic assumptions that are pertinent to supportive counseling and central to prescriptive behavioral treatment: (1) individual differences and temperament are real and important; (2) effective use of behavior change language is critical to effective management of behavior problems; (3) effective management of behavior problems requires more emphasis on what children do than on what they say; (4) child learning is governed largely by repetition leading to experiential contrast.

A. Individual Differences and Temperament

As emphasized above, the origin of behavioral problems presenting in PCBP usually involves an interaction between child characteristics and environmental variables. Although psychopathology is possible, it is infrequently present. A more accurate and less stigmatic perspective involves child behavior that is safely within

the wide range of normal variation in development and/or behavioral style but that is outside of, or at odds with, environmental (e.g., parental) expectations. As stated by Stella Chess and Alexander Thomas, pioneering researchers in the area of individual variation, a good fit between an individual and the environment occurs.

when the properties of the environment and its expectations and demands are in accord with an organism's own capacities, motivations, and style of behavior. When this consonance between organism and environment is present, optimal development in a progressive direction is possible. "Poorness of fit" involves discrepancies and dissonances between environmental opportunities and demands and the capacities and characteristics of the organism so that distorted development and maladaptive functioning occur.

In other words, misinterpretation of child skill level (i.e., under or over) and misunderstanding of normal individual differences cause discrepancies between what parents expect of a child and what the child can and does do. These discrepancies, in turn, result in problematic parent-child interactions and, pertinent to this chapter, many of the problems presenting in PCBP. For example, overinterpretation of children's cognitive abilities is widespread (and is discussed later in the section on effective use of behavior change language).

Variations in developmental processes can also contribute to the onset of child behavior problems. For example, variations in the development of sleep architecture can contribute to a range of potential bedtime problems such as infant night waking and sleep terrors in toddlers. Variations in child sensitivity to bladder distension, especially during sleep, can contribute to enuresis. Variations in appetite, especially the decreases that often accompany the natural reduction in growth rate during the second year of life, can lead to difficulties at mealtime. These, and many other examples not mentioned, underscore the theoretical assumption of PCBP that the process of development and its variation clearly influences the behavioral concerns likely to be seen in PCBP.

Elevated parental concern also contributes to child behavior problems and when variations in child behavioral style or temperament conflict with parental lifestyles, elevated concern is very likely. For example, a child with a low activity level may concern active athletic parents, but may not be a concern to less active parents. A toddler who is hungry or sleepy at irregular times may concern parents who are committed to a regimented schedule but may not concern parents in a less

tightly scheduled family. The cluster of temperamental characteristics that is most likely to conflict with preferred lifestyles, especially for new parents, includes irregular biologic rhythms, frequent withdrawal from new stimuli, slow adaptation, frequent negative mood, and high intensity responding. This cluster is believed to occur in approximately 10 to 15% of children and its presence significantly increases the probability of parental concern and correspondingly, the probability of reportable behavior problems. But its presence in some children is of minimal concern to parents and correspondingly, the probability of behavior problems is substantially reduced.

The capacity to recognize and describe how variations in child behavioral style and temperament can conflict with parental expectations and lifestyles is a critical component of supportive counseling. Use of this capacity can help parents understand why some of their attempts at management (e.g., those recommended by family, friends, the media) have failed with their child. It can also provide relief for parents who have been on the receiving end of the widespread tendency to view child behavior problems as reflective of poor parenting and/or child psychopathology. The science of temperament helps explain why some obviously caring and talented parents sometimes have difficult children. These explanations and interpretations are necessary but sometimes insufficient for successful outcomes, however, and interventions that improve the interaction between child temperament, family environment, and parent teaching style are sometimes needed.

These interventions usually involve a combination of modifying the learning environment and teaching the child the behaviors necessary for meeting environmental requirements. For example, parents of an inattentive 4-year-old could be taught to use good eye contact and one-step instructions when teaching the child (a modification of the environment) while the child could be taught to follow the one-step instructions. A child who has tantrums when instructed to change activities (e.g., come to dinner) may have a temperamental difficulty of adapting to transitions. Teaching parents to provide warnings for incipient transitions may help their child cope with the changes and comply with the related commands. But the child would still need to be taught that a tantrum is not an acceptable response to an upsetting situation. There are many other examples that underscore the importance role theory and research on individual differences and temperament play in the practice of PCBP.

B. Effective Use of Behavior Change Language

From the earliest stages of human life, language is such a ubiquitous presence that subtle but powerful aspects of its unfolding development are widely missed or at least largely misunderstood. The result is a high likelihood of mismatches between parental assumptions about child knowledge and what the children actually understand. Fortunately, due to developmentally beneficial processes such as modeling, the mismatches are beneficial in many parent-child interactions. But when the interactions involve parental attempts to change child behavior (e.g., discipline), these mismatches can frustrate parental attempts to teach, thwart child efforts to learn, perpetuate established behavior problems, inaugurate new problems, and deteriorate parent-child relations. There are multiple behavior-relevant aspects of child language development and we will cover the two that emerge most frequently in PCBP, the capacity to conserve and instructional control.

1. Conservation

Although many child researchers have demonstrated the incremental nature of language development, perhaps the first, and if not, certainly the most authoritative, was Jean Piaget. Among his many discoveries was the relatively slow development of the child's ability to meaningfully understand abstractions and abstract relations. Piaget's studies and related theories in this regard are too multifaceted and systemized for a full discussion here, but his concept of conservation is sufficiently general to serve as vehicle for our purposes. Conservation is largely synonymous with abstraction; it involves the capacity to conserve a quality of an object or event and meaningfully apply to another object or event. The capacity to do so when objects or events closely resemble each other emerges early but when they do not, when the objects or events are formally or contextually dissimilar, the capacity to conserve emerges late (averaging between 5 and 7 years) and does not fully develop until the teen years.

Piaget (and other investigators) conducted numerous studies that demonstrated the young child's limited capacity to conserve. For example, when asked to hold a pound of lead and a pound of feathers and then asked which weighed more young children usually said the lead. When in the presence of two containers with identical volume capacities but different forms (e.g., one tall and thin the other short and fat) and asked which held more water young children usually said the tall one.

When shown two similar apples, one cut into fourths and one cut into eighths, and asked which they preferred, young children picked the one with eighths (“because there was more apple”). When shown five quarters in a bunch and five quarters in a row and asked which grouping had more quarters children usually said the row. There are many other examples. Those above generally pertain to children younger than 7 years of age. But there are also related tests that have been conducted with older children and they too underscore the difficulty children have in seeing sameness in the presence of manifest topographical or contextual difference.

One example involves the water level task. Typically the test includes four pictures of containers, holding an identical amount of water, arrayed in a row. There are usually several such rows and in each row the containers are positioned at different angles. The angles are different within rows and identical across rows. In each container a line depicts the level of water within. One row accurately depicts what happens to the water level when the angle of the container changes (i.e., the water level remains the same, parallel to the bottom of the container, regardless of the position of the container). In the other rows water levels are inaccurately depicted (e.g., they change with the angle of the container). Tests of the water level task have revealed that even early teens will sometimes fail to identify the row with the accurately depicted water levels. In conclusion, children—especially younger children—have difficulty seeing sameness in objects or events that have substantially different physical or contextual characteristics.

Conservation is important to PCBP because the effectiveness of behavior change language heavily depends on the child’s capacity to discern similarity in differing behavioral episodes. No two episodes are completely alike and thus, to learn conduct-relevant relations between combinations of episodes, children must be able to conserve aspects that form the basis of the relevancy. For example, the inception of a disciplinary event often includes a parental attempt to forcefully assert similarities between a current and a previous behavioral episode (e.g., “Isn’t that the same thing I warned you about yesterday?” “Didn’t your father tell you not to do that last week?”). There are at least two conservation-based assumptions implicit in parental comments of this kind: (1) the child should have been able to see conduct-relevant sameness in the indicated behavioral episodes; and (2) the child can currently see the sameness because the parent has pointed it out verbally. But if conservation is weakly developed, which is true of most children younger than 7

years, there is a good chance both assumptions are incorrect. For example, if children have a difficult time seeing quantitative sameness between five quarters in a row and five quarters in a bunch, it seems safe to say they would have much more difficulty seeing conduct-relevant sameness between something they have just done and something they did hours or even days ago. Furthermore, the test situations with quarters are simple and uniform with the exception of the differing arrangement of the quarters. Behavioral episodes, however, are often very complex and differ in many ways including time frames, persons present, and physical locations.

Additionally, when conducting tests of conservation capacities in the laboratory, investigators exhibit calmness, acceptance, perhaps even gentleness. As much as possible, investigators attempt to expunge any hint of disappointment, judgment, or possible punishment. Most children respond in kind (e.g., by cooperating, trying their best). But in the prototypical disciplinary event, parents demonstratively exhibit disappointment, judgment, and sometimes anger and the possibility of punishment is always implicit and often very explicit. Many (probably most) children respond emotionally (e.g., by crying, yelling, denying). A large scientific literature shows that high levels of emotional arousal substantially diminish cognitive functioning. While in an intensely emotional interaction with their parents, children are probably functioning cognitively at a level much lower than their chronological age. Thus even children who exhibit a developed capacity to conserve in routine situations may be unable to do so in disciplinary situations.

2. Instructional Control

Many child behavior problems involve children failing to do what they are told to do by their parents and many of these failures occur because parental instructions are unclear and/or too complex. Similar to the discussion on conservation, mismatches between parent expectations and child understanding are the central problem. These mismatches are generally the result of parental overestimates of the clarity of their instructions and/or of their children’s capacity to follow those instructions. Three decades of research on parent–child interactions and on parent training programs has shown strong correlations between vague instructions and delayed development of child instructional control. A representative (but not exhaustive) list of exemplar vague instructions includes those that are question-based (e.g., “Are you going to put that away?”), indirect (e.g.,

“You know you should really be getting ready for school”), veiled (e.g., “Somebody left the door open”), or multistep (e.g., “Go down stairs, pick up your clothes, sort out the dirty ones, put them in a basket, and bring them here”). It is important to note that instructional control is not necessarily achievable through a focus on clarity alone. Everyday exchanges between parents and children necessarily involve diminished clarity and it is ultimately necessary for children to learn to understand and follow instructions that are vague, offhand, imbedded in other grammatical structures (e.g., questions), or communicated through vocal inflection more than through word arrangement. To become proficient at following instructions in their everyday form, however, children must first have abundant practice at following instructions that are in a clear, simple, direct form. Without this preliminary practice, many children are slow to develop optimal instructional control skills and more likely to exhibit problem behavior as a result.

Two related findings from developmental psychology are among the more ironic and counterintuitive aspects of early child language and they are also directly relevant to the language of behavior change (especially for children between 2 and 4 years of age). The first is that children respond to instructions that involve action onset (i.e., “do” or “start” commands) more readily than to instructions that involve action offset (i.e., “don’t” or “stop” commands). The ironic aspect is that parents are much more frequent users of “don’t” or “stop” than of “do” or “start” instructions. The counterintuitive aspect is that telling a child to do something (i.e., other than what they are currently doing) can be a more effective way to halt the activity than actually telling them to stop.

The second finding is that young children often respond more to vocally intensified components within an instruction than to its semantic content. For example, when issuing an instruction such as “whatever you do, don’t drop that cup” a parent may say the last three words much more intensively than the first four, resulting in a simple instruction, ostensible for the child, to drop the cup, inside of a more complex instruction, intended by the parent, to do the exact opposite. The ironic aspect is that attempts to ensure instructional compliance through selectively placed vocal intensity can result in noncompliance with the instructions issued. The counterintuitive aspect is that this noncompliance actually reflects instructional control, albeit with the instructions understood by the child and not the ones intended by the parent.

In conclusion, mismatches between parental assumptions (and expectancies) about child knowledge

and actual child understanding are common, especially in early childhood. These mismatches, reflected in the language used by parents in their interactions with their children, set the occasion for problems especially when the interactions involve parental attempts to modify child behavior. A theoretical assumption of PCBP is that the mismatches play an important part in the inauguration and perpetuation of child behavior problems. A core goal in PCBP is to train parents to use language more effectively, especially when attempting to establish and enforce rules, implement discipline, and manage behavior problems. A major emphasis is placed on use of simple language, but care is taken to explain that use of complex language when the parental goal is not child behavior change is not problematic, that it can be beneficial. For example, modeling new and/or complex language can expedite children’s ability to use and understand it. The purpose of behavior change interactions, however, is to teach children to exhibit appropriate behavior in everyday life (e.g., not to leave the house without asking) not to expand their command of complex language. To enhance effectiveness of behavior change language, especially in the early stages of child training, clear, simple, and direct should be the rule not the exception.

C. Emphasis on Doing

Another theoretical assumption of PCBP rests on a distinction between two types of knowing, knowing how to do and knowing how to say (or to specify verbally what is to be done). Although not the first to draw this distinction, the philosopher Gilbert Ryle most effectively brought it widespread attention with publication of his book, *The Concept of Mind* in 1949. The distinction has been drawn in many other ways since then (e.g., cognitive knowing versus behavioral knowing, knowing a rule versus behaving consistent with the rule, theory versus practice). The distinction is the basis for a theoretical assumption of PCBP that has three fundamental components: (1) knowing how to say does not entail knowing how to do; (2) adult attempts to change child behavior typically emphasize saying much more than doing; (3) the combination of 1 and 2 is an important source of child behavior problems.

For example, during toilet training it is routine to ask 2- and 3-year-old children if they have to go to the bathroom. Accurately answering the question can be difficult for such young children. First they must determine whether the question refers merely to a change in location (i.e., just going into the bathroom) or to an act

of elimination. When (more accurately if) the children ascertain that the question involves elimination, an accurate answer requires that they examine their own bodily responses and determine whether their bowel is full and/or their bladder is distended and therefore that an act of elimination is imminent. If imminence is determined, the children then have to decide whether it is in their best interests to say so. Children in the early stages of toilet training are typically in Pampers or Pull-ups, both of which protect them from discomfort that would otherwise result from wetting or soiling themselves. In the absence of a toilet training program that reprograms the natural contingencies, most young children would typically rather eliminate in the Pampers or Pull-ups than stop what they are doing, go into the bathroom, take off their clothes, sit on the toilet, and attempt elimination there.

Thus the difficulty occasioned by the question “do you have to go to the bathroom?” is potentially problematic in at least five ways. First, the question places emphasis on an answer about toileting and not on a toileting action. In other words it calls for children to say, not to do. Second, the developmental limitations of 2- and 3-year-old children, coupled with the contingencies that typically prevail in interactions involving toileting, dramatically decrease the chances of an affirmative answer even when elimination is imminent. Third, nonaffirmative answers in such situations (e.g., child says “no” and has an accident shortly thereafter) set the occasion for punishment (or at least unpleasant parent–child interactions) because such answers make it seem as if the child has misbehaved (e.g., by being dishonest, stubborn, or stupid). Fourth, as a result of punishing exchanges during or following toileting episodes, toileting situations and behavior can acquire aversive properties. Fifth, young children will tend to avoid such situations and behavior in the future, resulting in delayed development of toileting skills.

A focus on doing instead of saying at the beginning of parent–child interactions involving toileting can obviate these problems and expedite training. For example, when timing (i.e., time elapsed since last act of elimination) or child responses (e.g., shifting weight from foot to foot) suggest elimination is imminent, rather than making an inquiry about toileting urge, parents should instead issue a toileting instruction requiring that their child make an attempt to eliminate in the toilet, guide them as they do so, and praise performance and any success achieved. This method removes the focus on saying and places it on forms of doing that are central to toileting. Additionally, by focusing on toileting instructions, this method con-

tributes not just to development of toileting skills, but also to development of instruction control skills in general. Because it is easier for children to follow simple instructions (such as those that accompany successful toilet training programs) than to answer complex questions (such as those about toileting need), a focus on instructions (rather than inquiry) reduces the potential for contention between child and parent during the process.

From a slightly different perspective, the scientific literature on toileting supports the instruction-based approach by showing that children generally do not acquire the ability to succeed with an inquiry-based approach (i.e., respond accurately to questions about whether they have to go and independently conduct the act if they do) until late in their third or early in their fourth year. But the inquiry-based approach is widely used with much younger children resulting in many toileting problems that are ultimately brought to PCBP.

A focus on doing more than saying is also important for other reasons. For example, in many domains of children’s lives their ability to say what they should do is learned before their ability to do it. That is, children can often readily say what they are supposed to do (or what they should have done) but lack the actual skill necessary for accomplishing the task. For example, they can easily say they should share their toys and yet not have the slightest inclination to do so because they lack the social and emotional skills that are essential for proficient sharing. Unfortunately, many adults assume that if children can say they should share it means they actually know how. For these adults, the children’s subsequent failure to share is much more likely to be interpreted as evidence of a flawed character than of a skill deficit.

That a disparity between saying and doing exists and differential emphasis is more productively placed on doing is no surprise, at least where adults are concerned. Tell-tale examples are legion in everyday life. For example, all golfers know they should keep their head down during the golf swing but many (most) routinely lift their head up. Or more generally, lovers say they should look before they leap, readers say a book should not be judged by its cover, and fools say they should not rush in. Yet lovers often leap, readers frequently judge by the cover, and fools typically rush in all because their knowledge involves a facility for saying far more than it does a capacity for doing what has been said. Many proverbs, aphorisms, and epigrams make similar points and underscore the importance of doing over saying (e.g., “put your money where your mouth is”). The importance of doing over saying also suffuses the marketplace. As an example, the January

2001 issue of *Wired Magazine* included a symposium on marketing in the new millennium in which David Kelley, a prominent participant, said, "If you listen to the customers, they can't tell you anything. You have to *watch* the customer to really learn something. That's how you get at what they think and feel."

The surprise is actually how little this disparity is recognized where children with behavior problems are concerned and how minimally it is incorporated into attempts to modify those problems. As indicated above, children can often readily say what they should or should not do (e.g., not suck their thumb, pick on smaller children, take things without asking) but their ability to exhibit the requisite behaviors often lags far behind their ability to enunciate them. The related mistaken assumptions about what children know results in at least three sources of child behavior problems and corresponding difficulties. The first involves parental teaching efforts undermined by overemphasis on saying and underemphasis on doing, resulting in delayed child learning of behavioral skills (e.g., instructional control) critical to successful home and school life. The second involves the frequency of punitive discipline used with behavior problem children whose ability to say what they are supposed to do greatly exceeds their ability to do it. The third involves a widespread cultural tendency to interpret child behavior problems as a reflection of psychopathology rather than skills deficits. A fundamental assumption of PCBP is that the strength of these sources of problems and complications is substantially reduced when teaching focuses more on child doing than on child saying.

D. Repetition Followed by Experiential Contrast

The final theoretical assumption underlying PCBP that we will discuss involves how children derive meaning from the teeming multitude of events that compose their day-to-day life, how they learn to exhibit appropriate and inappropriate behavior, or more generally, how they learn. A century of research on learning with major contributions by eminent scientists such as John Watson, Edward Thorndike, B.F. Skinner, Albert Bandura, and Sydney Bijou shows that child learning largely results from the emergence of functional relations between what children do, what happened before they did it, and the change or contrast in experience generated by what they have done. The second theoretical assumption underlying PCBP we discussed dealt with antecedents or events occurring before children do things.

Antecedents (e.g., instructions, rules) that compose a major portion of child teaching (e.g., by parents) were discussed, and the importance of salience, clarity, and simplicity as well as an emphasis on doing was stressed. The final theoretical assumption involves how children make adaptive (i.e., preferred by parents) connections between these types of antecedent events and what they subsequently do. Specifically, the assumption is that the connections result from repetition of behavior that follows the antecedent events and the changes or contrast in child experience that follows the behavior.

In very general terms, there are four classes or categories of experiential events that establish learning-based connections, two that make repetition of behavior more likely and two that make it less likely. The two classes that make behavior more likely are (1) contact with experientially pleasant or preferred events and (2) avoidance of, or escape from, experientially unpleasant or nonpreferred events. The two classes that make behavior less likely are (1) contact with experientially unpleasant or nonpreferred events and (2) disconnection from, or loss of contact with, pleasant or preferred events. An important corollary of the final assumption is that the number of repetitions necessary for children to make meaningful connections is governed by the amount of the experiential contrast that follows what they do. The more contrast, the fewer repetitions necessary for learning a meaningful relationship between a behavior, its antecedents, and its experiential consequences.

For example, flame or fire is a very salient (and attractive) antecedent event (e.g., the primary purpose of most fireplaces is for viewing fire, not for heating homes) but also very dangerous for children. Very young children who initially encounter fire are typically unaware of its dangers but are enthralled with its beauty and if unsupervised, they will often try to touch it. As a result a very important lesson (i.e., meaningful connection) is instantly learned. The learning results from the presence of fire (antecedent event), behavior that brings the child into contact with fire (touching), and the experiential (unpleasant, nonpreferred) consequences of that contact (being burned). These experiential consequences involve so much contrast (i.e., temperature of the body versus flame) that an instance of one-trial learning generating caution around fire occurs and it typically lasts a lifetime (i.e., the child will be unlikely to deliberately place his or her hand in open flame again). This is not to say that children who have been burned will not be burned again, but as the saying goes "once burned, twice shy." If the temperature of fire were lower, if it were much closer to skin temperature (e.g.,

102°F), many repetitions (and probably some supplemental aversive—disciplinary—consequences) would be necessary to establish a level of caution similar to that generated from flame.

The power of learning resulting from such extraordinary levels of experiential contrast is revealed by some parents who, after being unsuccessful in using other methods to teach their toddlers to avoid breakable household objects, achieve temporary success warning them that the objects are hot. A child with some experience of being burned and who has learned a connection between that experience and the antecedent event of hearing a parent say “hot” will often avoid, albeit temporarily, objects so described.

Critical to this discussion of learning is the logical necessity of incorporating the obverse of the primary point made above. That is, if behavior followed by high experiential contrast requires few repetitions to result in the learning of meaningful connections, responses followed by low experiential contrast will usually require many repetitions to result in a similar amount of learning. Numerous everyday examples corroborate this second point.

For example, many parents report high rate use of tactics such as nagging, reminding, warning, and threatening when attempting to teach their problem children appropriate behavior. Each of these tactics is a class of topographically similar antecedent events and in most teaching situations the events are repeated multiple times before a parent takes any further action, if indeed any action is taken at all. The reason for the repetition is that the children (who have been repetitiously nagged, reminded, warned, or threatened) have presumably not responded to the parent (i.e., they ignored their parent). Each instance of these parental tactics (e.g., each warning) sets the occasion for a learning trial in which the child actually learns to continue ignoring the parent. This unwanted and unfortunate result occurs for two reasons related to the theoretical assumption we are discussing here. First, the ignoring typically fails to generate the type (unpleasant) and the amount of experiential contrast necessary to reduce the likelihood of ignoring in the future. Second, the ignoring generates a consequential event of the type (avoidance of unpleasant or nonpreferred activity—i.e., whatever the parent wants the child to do or not do) that makes ignoring more likely to be repeated in the future.

Another type of learning trial that strengthens the learning of ignoring parents even further often accompanies the first type. In this second type of trial parents ignore or respond minimally when children actually do

what they are told. That is, the tendency to ignore the parent, established by frequent parental warnings with no followup, is made even more likely when the child complies with the parent and still receives no followup. More generally, the learning of inappropriate behavior (e.g., ignoring as described above) is often accompanied by learning trials in which appropriate alternatives (e.g., compliance) are not followed by the type (pleasant, preferred) or the amount of experiential contrast necessary to increase the likelihood of the alternatives. In conclusion, many child behavior problems result from a confluence of learning trials where inappropriate behavior receives more of an experiential payoff for the child than its appropriate alternatives.

Making matters even worse is the devolution in parent teaching tactics that can result from these problematic teaching and learning processes. Many parents, frustrated by the extent to which their instructions and rules are ignored, resort to highly punitive consequences, especially yelling and sometimes even spanking. These consequences produce high levels of experiential contrast and thus readily instigate learning, but their potential benefits are outweighed by several potential risks. For example, children habituate to yelling and spanking quickly so more is gradually needed, an escalatory process that can lead to abusive child treatment. Additionally, frequent use of punishing tactics often creates so much distress for child, parent, and family that the quality of the family environment is usually diminished as a result. The effects of highly punitive tactics on child behavior are also reductive and so they are less likely to teach new skills than they are to increase avoidance and escape. Lastly, the tactics can cause unwanted side effects (e.g., fear, retaliation) that can worsen the parent–child relationship even further. For these reasons, the use of highly punitive consequences are neither recommended nor endorsed in PCBP.

1. The Experience of Nothing

For most disciplinary purposes, an alternative approach to discipline, derived from the fourth theoretical assumption of PCBP (i.e., repetition with contrast) as well other fundamental aspects of human life, is employed instead. Specifically, the approach involves the strategic use of the experience of nothing. Events in which very little stimulation occurs involve the type of experience (unpleasant, nonpreferred) that reduces the probability of behavior that produces it. Faced with the extended experience of nothing, children (and indeed most humans) prefer events that produce something, even if those events involve unpleasantness. Said

slightly differently, most children ultimately prefer negative over nothing. Unfortunately, from a theoretical perspective nothing is hard to define and from an empirical perspective it can be difficult to document. But fortunately, from a procedural perspective experiences involving nothing, not much, or very little can be programmatically arranged, as we will discuss below.

a) Sensory Deprivation The importance of nothing as an experience is predicted on humans as sentient beings whose senses must be stimulated in order to maintain perceptual integrity and ultimately life itself. If one or more sensory modalities are cut off (e.g., through blindness or deafness) the acuity of those that remain increases substantially. It is as if a requisite amount of stimulation is necessary for humans to maintain perceptual health. An illuminating example of the power of the experience of nothing involves enclosure within sensory deprivation chambers. In the chambers persons lie in water the temperature of which is identical to that of the body. There is no light or sound and there is nothing to taste or smell. In other words, in sensory deprivation chambers the stimuli available for differential perception are held to a profound and potentially life-threatening minimum. In the short term, enclosure in the chambers has been associated with such experiences as exhilaration, relaxation, and awareness enhancement. In the long term, however, enclosure in the chambers has been associated with such experiences as hallucination, hyperventilation, and panic. Extended stays (e.g., more than an hour) are thought to be dangerous especially for novices. The point of this discussion is not to review sensory deprivation but rather to use a brief description of it to illuminate a correlate of the fourth theoretical assumption of PCBP. Specifically, programmed (i.e., planned contingent use of) consequences generating the experience of nothing powerfully reduce the likelihood of behaviors that produce those consequences.

We used the deprivation chamber example to reveal a very important dimension of the experience of nothing, the experiences where very little external stimulation occurs. Another equally important dimension is the experience of not being able to do anything about it (e.g., being powerless to provoke a reaction in a parent). In other words, situations in which there is nothing going on and nothing one can do about it are aversive for humans and particularly for children. One feature of the deprivation chamber that makes it tolerable is that the person within can readily terminate the experience and produce some external stimulation. Re-

moving this feature, however, makes the experience highly aversive, one that few persons would willingly seek. There are many other examples that, although less exotic than the deprivation chamber, can be just as reflective of the influence the experience of nothing can have on learning and behavior, for example, parents on the telephone and the use of time out.

b) Parents on the Telephone The influence the experience of nothing can have on learning is often in evidence when young children are alone with a parent who takes an extended telephone call. Escalated child misbehavior and demonstrative child upset are two common results and both can puzzle parents. Viewed from the perspective of our discussion of nothing, however, there is little mystery here. The most treasured source of external stimulation for young children is usually the parent and during telephone calls the parent is mostly psychologically (and physically) unavailable; that is, they provide their child little or nothing. In the unlikely event that children behave appropriately during the call, for example, they sit on the couch and look at picture books, the likely consequence for them will be an extension of the call. When children are behaving appropriately there is no compelling reason for a parent to terminate an activity and attend to them. The unfortunate result for the children, however, is an extended experience of nothing, at least as far as the parent as a source of stimulation is concerned. In other words, appropriate child behavior occurring while a parent is on the telephone usually produces nothing for the child. Extended telephone calls in the presence of a young child, however, are not neutral from a learning perspective. They are learning trials in which appropriate behavior is followed by experiential consequences (i.e., nothing) that are of the type (unpleasant, nonpreferred) that make the behavior less likely to occur in the future.

Making matters worse is that inappropriate child behavior, especially of a highly escalated sort, can and often does terminate parental telephone calls. When this happens, parents are likely to express frustration or anger and possibly even impose some discipline. Despite this quite logical parental approach to the problem, child misbehavior during telephone calls often subsequently increases rather than decreases. Although counterintuitive, from a PCBP perspective this outcome is readily explained. Although the parental response to the child appears to involve unpleasant consequences, these consequences are something (experiential) and from the typical child's perspective as we have argued,

something is better than nothing. Through misbehavior the child is, in effect, able to neutralize both of the dimensions of the experience of nothing that make it aversive. The first (nothing going on) is neutralized as soon as the parent interacts with the child because something begins to happen. The second (nothing the child can do about it) is neutralized by the instrumental quality of the misbehavior (i.e., it causes the parent to respond). More generally and from the perspective of the fourth theoretical assumption of PCBP, attempts to discipline child misbehavior that occurs in the context of nothing (as we have discussed it here) are more likely to increase than decrease the misbehavior. The reason is that when the disciplinary consequences occur, the context of nothing transforms them into the type (preferred) that make the behavior that generated them more likely in the future.

c) Time Out Another example of the role the experience of nothing can play in a child's life is a very common disciplinary procedure called time out. Time out, an abbreviation for Time Out From Positive Reinforcement, established in basic science experiments years ago, has become the most used method for disciplining children in this country, with the possible exception of verbal reprimands. A disclaimer, frequently heard in PCBP, is that time out has been tried and it did not work. The implicit assumption is that what was done in the name of time out closely resembles the procedure developed in the laboratory long ago. Unfortunately, close resemblance is the rare exception rather than the rule. In the laboratory, time out conditions involve what we have been referring to as the experience of nothing. Specifically the subject could not make contact with events that would be reinforcing, rewarding, stimulating, or interesting. In other words for laboratory subjects, a time out meant there was nothing going on, and for a specific period of time, there was nothing they could do about it. This laboratory experience, however, differs dramatically from the typical experience called time out in homes and schools across the country.

During the typical time out children are taken to a specific location, usually a chair, lectured briefly on the nature of their offense, and told they must sit quietly for a certain amount of time. A timer is often placed in the child's visual and/or auditory range so that the youngster can keep track of time passing. Verbal components such as warnings, rationales, and commands are frequently directed at the child. Children in time out are also often allowed to bring favored objects (e.g., teddy bear, book) with them. The location of the time

out is often near rich sources of external stimulation such as the television or a picture window. So in terms of the first dimension of the experience of nothing, specifically nothing going on, most time outs often fail.

Also detrimental to the process is the ease with which children can do something about their situation, thereby neutralizing the intended effects of the time out experience. For example, simply calling out, crying out, or coming out of time out (without permission) are very successful means of fully engaging the attention of parents and thereby undermining the effects of time out. Other types of inappropriate behaviors (e.g., profanity, disrobing) also typically engage parental attention. The attention thus engaged is usually negative but, because it is delivered when the child is in time out, resulting in a temporary escape (the instant attention is delivered, time out functionally ends) it is more likely to increase rather than decrease the inappropriate behavior. In other words, negative attention is something and for children in time out, something is usually better than nothing.

Not surprisingly, helping parents to strategically apply the experience of nothing (e.g., time out, planned ignoring) as a disciplinary alternative to raising their hands or voices is an important part of PCBP. Much of this assistance involves helping them eliminate sources of social stimulation (e.g., warnings, criticisms, expressions of parental anger) that often occur while children are in time out. Perhaps even more important is assisting them to see that the experience of nothing is relative phenomenon. If little external stimulation is available for a child (e.g., they are bored because nothing is happening) time out, even when done well, produces little experiential contrast. Needed is an experience, resulting from an act of discipline, that is unpleasant or nonpreferred and that stands out starkly from what was happening before the discipline was imposed. Yelling or spanking can serve this purpose but we have already discussed the problems associated with their use. Time out is much more subtle but it can serve the purpose very well if three conditions are met: (1) sources of social stimulation are eliminated during the time out (as above); (2) the child's inappropriate attempts to terminate time out are ignored outright; and (3) the child's life was generally interesting and fun before time out was imposed. In other words, time out must be devoid of social interaction and must occur in a context called time in.

d) The Role of Time In As indicated, in order for time out to have desired effects, it must represent a change in the experience of the child and if nothing was going on before the time out occurred, and the

child is then put in a situation with nothing going on, not much contrast and thus not much learning occurs. Actually, this principle applies to virtually any form of discipline. For example, if parents usually talk to their children with stern voices and then use a stern verbal reprimand for discipline, the reprimand produces little contrast and thus little possibility of learning. However, if parents usually talk to their children in soothing, affectionate, or emotionally positive ways and then use a stern verbal reprimand, the stark contrast between the typical parent-child interaction and the stern one increases the probability of children learning an important connection between what they have done and the parents' reaction to it. In honor of this principle, PCBP therapists are unlikely to recommend any form of discipline without first recommending ways for parents to increase the positive aspects of their child's daily life. Said slightly differently, PCBP practitioners routinely recommend procedures to increase time in, the functional opposite of time out, wherein multiple sources of preferred external stimulation (e.g., physical affection, parental participation in child activities,) are made available to children as well as a variety of minimally effortful methods accessing those sources.

In conclusion, a large part of PCBP involves provision of procedural advice generally based on developmental and behavioral science and specifically on the four theoretical assumptions we described above. That is, this advice almost always involves some combination of (1) consideration and explanation of child behavioral style; (2) more effective use of behavior change language; (3) a focus on doing; and (4) the arrangement of teaching circumstances that result in the type and amount of experiential contrast necessary to produce children's learning of appropriate behavior.

III. APPLICATIONS AND EXCLUSIONS

Some children resist most, and most children resist some, key aspects of the socialization and education processes in this culture and a vast number and array of child behavior problems is the result. For example, nutritional and maturational health is predicated on food preferences that include the major food groups and yet some children, whose behavioral style may include slow adaptability and approach to new experience, resist parental attempts to introduce new tastes and textures into the daily diet. Adaptive child performance during the day is dependent on receipt of adequate sleep at night, yet children with slow adaptability or irregularity

in sleep cycles may resist parental efforts to establish a reasonable bedtime. Most parents, preschools, and many day care programs require full toilet training during the third year of life, yet many children resist parental training efforts. Success in most life situations requires a reasonable amount of instructional control yet many children resist following important adult instructions. There are many other examples and they generally emerge in situations in which the requirement for adherence to family, school, or societal standards or requirements is not well matched with aspects of the child's behavioral style and/or learning history.

There are also a large number of child problems pertinent to PCBP that do not involve child resistance as much as they do child inability to emit, maintain, reduce, or cease important behavior. Although many of these problems are clinically unremarkable and resolve with time and routine parental efforts, some do not and require professional assistance for complete resolution. Furthermore, some of these problems resemble or, if unresolved, can lead to more serious conditions and thus they require some level of professional assessment prior to intervention. For example, simple tics and other child habits involving repetitive but nonadaptive behavior are common yet difficult for children to stop and highly resistant to routine parental efforts to help. In addition, tics may be an early sign of serious clinical conditions (e.g., Tourette's syndrome). Urinary and/or fecal incontinence is common, even in school-age children, yet without professional help incontinence can become a threat to physical and psychological health. School problems involving excesses or deficits of various behaviors critical to school performance (e.g., attention, activity) are common, stubborn, and absent effective intervention, can lead to serious problems later (e.g., school failure). There are many other examples and they generally emerge in situations requiring inhibition of potentially maladaptive behavior and increased exhibition of adaptive behavior.

The PCBP perspective on types of problems described above is that most are more productively viewed as a skill or performance deficit than as psychopathologies. Nonetheless, the problems are usually serious enough to warrant a professional opinion and sufficiently complex enough to require professional assistance for resolution. Psychopathology, however, is rarely the appropriate interpretive context for the assessment or the assistance warranted by these problems. As indicated, the problems emerge as a function of the friction between child style, preference, and/or skill level and the requirements inherent in socialization and education processes.

This “otherwise normal” perspective, unfortunately, is at odds with the vast majority of psychology and psychiatric literature on child behavior problems, which is focused almost entirely on detection of psychopathology with minimal regard for detection of child health. In fact, very few clinical assessment instruments are even designed to detect behavioral health. Behavior assessment instruments used in clinical research and practice on child behavior ask questions about symptoms or behavior problems and the typical intent is to determine whether a given child has significantly more than children of a similar age in the group used to norm the instrument. In other words, the *de facto* definition of child behavioral health within clinical child psychology and psychiatry is a composite of symptoms and problems that are below a threshold established for psychopathology, not a composite of healthful behaviors.

Perhaps the best way to view the PCBP approach to behavior problems is as early intervention. By providing parents and families with supportive counseling and prescriptive recommendations sufficient to improve interactions between children and their learning environment, PCBP aims to facilitate adaptive child development and behavior and thus prevent more severe problems in the future. For example, inadequate sleep leads to behavioral deterioration during the day and PCBP advice on how much sleep is needed and how to produce it can prevent these problems. Incontinence poses a number of risks to child health and development and PCBP advice on when and how to start toilet training can eliminate them. Resistance to adult instructions places children at risk for perpetuated conflict with adults. PCBP advice on instructional control can reduce child noncompliance with adult authority. The list of other examples is very long. They typically involve mild to moderate child behavior problems, most of which are responsive to changes in practices by parents (or teachers). Although some of the problems may meet diagnostic criteria for clinical conditions (e.g., enuresis, encopresis, simple phobias) the problems are usually in their early stages and are much more responsive to changes in teaching or training practices than problems that have been chronic for years. Thus even though PCBP provides treatment, the context of care is still characterized as preventive rather than curative or rehabilitative.

In conclusion, PCBP focuses on mild to moderate behavior problems exhibited by children who initially present in primary care. The context of care is one of prevention (preservation of health) much more than it is treatment (restoration of health) or rehabilitation (minimization of illness). Adopting this context, how-

ever, does not mean that PCBP denies the possibility of psychopathology or mental illness in children. Rather, the position taken is that children are deemed psychologically well until proven otherwise. Forms of such proof include resistance to PCBP treatment, an initial severe presentation, or incontrovertible assessment-based evidence; if any of these occur, cases are referred to appropriate specialists. PCBP, however, is an appropriate form of care for the vast array and number of child behavior problems presenting initially, and often only, in primary care settings.

IV. EMPIRICAL STUDIES

As emphasized, an important portion of PCBP involves educating parents about childhood and what to expect socially, emotionally, and behaviorally from their children. Thus virtually all child and developmental research is potentially relevant to PCBP. Three categories of this research are particularly relevant, however, the first two because they supply some justification for the well child focus of PCBP and the third because it reveals the size of the empirically supported armamentarium of the PCBP practitioner. The first category involves research on child temperament and individual differences, the second involves research assessing whether mild to moderate child behavior problems necessarily involve psychopathology, and the third involves research on PCBP appropriate treatments (pragmatic, procedure-based, outcome oriented, and time-limited) developed for various mild to moderate child behavior problems.

A. Temperament and Individual Differences

The expanding role of temperament or behavioral style in the professional approach to child behavioral problems is due in no small measure to the work of Stella Chess and Alexander Thomas and their colleagues working on the New York Longitudinal Study. This landmark research identified nine characteristics of temperament: activity level, rhythmicity (regularity of physiologic functions such as sleep, hunger, etc.), adaptability, intensity, mood, approach-withdrawal (to new stimuli), persistence, distractibility, and sensory threshold. There is, however, variation in the opinions of other researchers on the number and nature of the dimensions that compose variations in temperament, with more recent views favoring fewer dimensions.

These differences of opinion notwithstanding, there is consensus that dimensions of temperament do exist, play a significant role in behavioral expression, and are relatively stable over time.

Two other potent influences have contributed to the expanding role of temperament in the theoretical assumptions of PCBP. The first influence involves neonatal assessment of temperament, most notably with the instrument developed by T. Berry Brazelton. Related studies show that long before environmental influences could produce major changes in behavioral responses, substantial differences in behavioral expression exist in newborn children. The second influence involves assessment of temperament across early and later childhood, authoritatively (but not solely) documented in the papers and books authored by William Carey. The evolution of temperament from theory and basic science (e.g., Chess, Thomas) to routine assessment in a hospital setting (e.g., Brazelton) to routine assessment in a private pediatric practice setting (e.g., Carey) has contributed greatly to its current important role in PCBP practice.

B. Testing for Psychopathology

The second category of research is unfortunately small for reasons we have discussed briefly. For example, most of the research conducted on child behavior problems involves attempts to detect psychopathology and failure to do so usually means a failed experiment. As another example, children who do not exhibit psychopathology are much less likely to interest professionals (e.g., clinical child psychologists and psychiatrists) whose careers are focused on the study of it than children who do. Thus essentially healthy children are rarely the focus of clinical research.

There is, however, a small group of child studies whose group data were more reflective of clinical normality than psychopathology, despite presenting problems often interpreted as evidence of an underlying disorder. Examples include studies on children exhibiting problems such as enuresis, encopresis, chronic hair pulling, and thumb sucking. Note that these types of problems are very likely to present in primary care and thus are directly pertinent to this chapter. In these studies, the majority of children studied did not exhibit a sufficient number of clinical symptoms other than the target problem (e.g., enuresis) to justify a label of psychopathology. Rather, with the exception of the presenting problems, the groups appeared to be appropriately located within a spectrum of normality. There were extreme cases within the groups, but they were in a small minority.

Unfortunately for the empirical base of PCBP, however, the extreme case is much more likely to be the source of data for published papers than the routine case. This publication practice, sometimes referred to as selection bias (e.g., Berkson's bias), is typical not just of clinical psychology and psychiatry but also of clinical medicine. A long line of research shows that in any field of clinical science, extreme cases (multiple presenting problems) are more likely to be used for research and teaching than otherwise normal cases (one presenting problem). From the standpoint of professional education, this bias makes sense; the extreme case or the textbook case, as it were, provides a richer source of teaching material than the routine case. Yet the institutionalized practice of basing professional teaching mostly on extreme cases has its limitations. For example, the practice can result in the overinterpretation of routine cases, especially in clinical settings. Additionally, it probably diminishes incentives to study routine cases.

There are three important implications for PCBP to draw from the extant research on child behavior problems. First, a small but growing body of directly relevant research, as well as a long line of indirect study (e.g., on selection bias) supports our assumption that the initial evaluation and treatment of children with mild to moderate behavior problems is appropriate for PCBP. Second, it is incumbent upon PCBP practitioners to ably distinguish between routine and severe cases in order to make appropriate referrals. Third, the historical mainstream emphasis on the search for psychopathology in children with behavior problems and the resulting differential emphasis on extreme cases is a research opportunity for PCBP (e.g., research exploring the spectrum of normality in populations of children with bona fide psychological and behavioral problems is needed).

C. Evaluation of Treatments

The growing research on hair pulling in children is a good bridge from tests of psychopathology to research on treatment of behavioral problems presenting in PCBP. Reviews of the literature on chronic hair pulling or trichotillomania have shown that there is a spectrum of severity and that in many individuals, especially young children (i.e., younger than 10), hair pulling is a relatively simple habit (albeit with potentially serious consequences) similar in function and situational presentation to other simple habits such as thumb sucking. This point is not intended to downplay the seriousness of classic cases of trichotillomania where those afflicted experience frequent powerful urges to pull their own

hair, psychological satisfaction when they do so, and cosmetically significant hair loss. Although effective therapy exists for such cases, its dependence on specialized knowledge and its inherent complexity places it well beyond the bounds of PCBP. Such cases are at the pathologic end of a spectrum of severity in which mild and moderate cases also exist. In fact, as research on trichotillomania evolves, mild and moderate cases may ultimately be classified in other ways, leaving only the more serious cases in the diagnostic category. Regardless, the children in the mild and moderate portions of the spectrum are indeed pulling their own hair and many present with serious hair loss. In support of the position we have taken, multiple published papers have described many cases of child hair pulling that resolved with treatments suitable for use in PCBP. Our case illustration (described below) will describe one of these cases. We used hair pulling for the case illustration because it, perhaps more than any other child problems appropriate for initial evaluation and treatment in PCBP, is believed by most clinicians to be reflective of psychopathology and in need of specialty care. Below we will briefly discuss some of these other problems with particular attention paid to the success of PCBP appropriate treatments that have been used with them.

1. Risky Infant Behavior

Crawling, cruising, and early walking infants explore their worlds with enthusiasm and tenacity. Although essential to healthy development, these explorations often lead to danger (e.g., electrical outlets, fireplaces, swallowable nonedible objects). Informed parents can minimize risks to their infants by “childproofing” their home, but no home is risk free. The parental task remaining after risks have been reduced involves actually teaching children to avoid the dangerous objects and situations that remain. Typical tactics include redirection, stop commands, warnings, threats, and even mild corporal punishment (e.g., slight slap on the hand). Despite use of these tactics, risky infant behavior often continues and sometimes even increases. From the theoretical perspectives of PCBP, this perpetuation of risky behavior is readily explained. Infants explore mostly when they are otherwise not engaged and most of their exploratory behavior produces little adult attention. When the behavior becomes risky, however, adult attention is quickly engaged, redirection and/or mild discipline is employed, and experiential contrast is produced for the infant. But because adult attention is such a powerful incentive for infants, and because the contrast it produces in these instances typically occurs

in a context involving little or no social stimulation for infants, it can strengthen rather than weaken the infants’ risky tendencies.

An important study, derived from this interpretation, was conducted with teenage mothers who had been reported for abusing their 1-year-old children. In the study, the mothers were taught to use language more effectively (e.g., eliminate threats, reasoning), focus on doing rather than on abstract personality traits (e.g., “you are so stubborn”), establish “time in” (e.g., by increasing physical affection, using more pleasing voice tones, more play times), and to use a brief time out (i.e., a few moments in a playpen) when their child engaged in risky behavior. Risky infant behavior dropped to near zero levels and mother–child interactions improved dramatically. Although some special training was necessary for these mothers, this approach is readily taught to older, more experienced mothers who bring their concerns to primary care.

2. Bedtime Problems

One of the most common presenting problems in PCBP involves resistance to bedtime (e.g., some combination of crying out, calling out, and coming out from the bedroom after bedtime). Several aspects of behavioral style may contribute to this difficulty. Children who are persistent and slow to adapt may resist and prolong the bedtime routine. Children with a low rhythmicity of relevant biologic processes may develop an erratic sleep schedule and not be tired at bedtime. Regardless of origin, bedtime resistance often generates experiential contrast of the type (e.g., contact with the parents) that perpetuates problem behavior.

Several PCBP appropriate treatments have been shown to be effective at curtailing resistance and establishing reasonable bedtimes. They achieve their success by modifying parental responses to achieve a more effective use of language, a focus on doing, an increased child experiential payoff for compliance, and a decreased experiential payoff for resistance. The bluntest form of PCBP treatment for bedtime problems involves ignoring the children altogether after they have gone to bed and extending appreciation for the night thus spent in the morning when they get up. This procedure is controversial because it can produce severe “bursts” of crying, especially in persistent children with slow adaptability to change and these bursts can be very difficult to manage even for confident, experienced parents. A more modulated version of this approach involves graduated ignoring (e.g., ignoring for 5 minutes the first night, 10 the second, and so on). An apparently equally effective

(as indicated by comparative published research) less controversial technique involves establishing pleasant bedtime routines that occur when children comply with bedtime procedures and suspending the procedures when they do not.

A final technique was the subject of a recent scientific report and it is a classic demonstration of PCBP treatment as an early intervention. The technique is called the bedtime pass and it involves providing children with a pass, constructed by the parents, for use as an exchange for one trip out of the bedroom after bedtime. During the trip the children are allowed to make one request of their parents that can be satisfied readily with an action (e.g., request to use the bathroom, have a drink, obtain a hug). Once the action is satisfied, the children surrender the pass and return to bed. The recent report showed the program was highly effective with children who were routinely disruptive at and after bedtime. Additionally, the pass was deemed more acceptable than ignoring or the family bed by groups of pediatricians and parents.

3. Routine Oppositional Behavior in Younger Children (1 to 7 years)

Oppositional behavior in younger children is common. Instructional control is not an inherent trait; it is a learned skill and although children whose behavioral style is marked by easy adaptability, positive mood, and low intensity may learn it with minimal effort on the part of parents or teachers, other children learn it much more slowly. Relevant to the PCBP view, there is a very large literature, including numerous scientific papers and books that derive their message from those papers, on how to teach instructional control skills to younger children. The fundamental method emphasized in this literature involves the tactics we have discussed here. Specifically these include effective use of language, heightened focus on what the children do, increased time in, and imposition of experiential consequences that increase the likelihood of appropriate behavior and decrease the likelihood of inappropriate behavior. Detailed examples of this kind of child training are provided in a selection of books in our recommended reading section.

4. Routine Oppositional Behavior in Older Children (7 to 12 years)

As the social environment of children expands, the potential for direct parental control contracts. Said differently, as children's important social relationships increasingly develop outside their home and family, social influences that compete with parental influence mount

and the possibilities for opposition to parental authority increase. As with younger children some of the opposition occurs in the home (e.g., chores undone) but increasingly with age some occurs outside the home (e.g., poor grades, school rules broken, curfew violations). Multiple studies have shown that effectively managing routine opposition in these older children involves the general tactics used with younger children (e.g., effective use of language). The critical difference involves the composition of the experiential consequences used to increase and decrease behaviors of concern. Whereas various forms of time out are usually sufficient for younger children, tactics such as contingent access to family and home resources (television, telephone, bike, etc.) and contingent permission to leave the home are needed, in addition to time out, for success with older children.

For example, an early (1972) study demonstrated that a simple home point system, where points earned or lost contingent upon appropriate and inappropriate behavior were used to "purchase" special privileges, dramatically improved the behavior problems of a group of misbehaving older children. Since then, many studies using similar tactics, although often in a less elaborate form (e.g., without a point system), have been used to successfully reduce opposition to parental authority in older children. Directly pertinent to this chapter is the fact that these methods can be prescribed readily in PCBP sessions.

5. Nocturnal Enuresis

Nocturnal enuresis involves nighttime urinary accidents that occur in children over the age of 5 who do not have a causal organic condition. The National Health Examination Survey estimated that as many as 25% of first-grade boys and 15% of first-grade girls were enuretic and not surprisingly, given its high prevalence, enuresis is one of the most frequent presenting problems in PCBP. Pertinent to this chapter is a voluminous body of scientific evidence showing the effectiveness of the urine alarm, a treatment for enuresis that is entirely consistent with the theoretical assumptions of PCBP and well suited to its practice. The alarm displaces the ineffective use of language (threats, reasoning, etc.) that often accompanies enuresis before it is seen professionally. Bedwetting children cannot be talked, threatened, or reasoned into continence. If they could, enuresis would be much more rare. The alarm is connected to a moisture-sensitive switching system and as little as one drop of urine completes the connection and turns it on. The alarm emits an unpleasant stimulus but the child

can easily turn it off and thus continence-based learning occurs on two fronts. First, accidents produce the alarm (i.e., unpleasant experiential consequence) which reduces their likelihood. Second, turning off the alarm produces pleasant (or at least preferred) experiential consequences (escape from the alarm) that increase the likelihood of waking after or during the accidents. Initially the latency between the onset of urination and the alarm is large but it reduces over time until escape from the alarm segues into avoidance of it altogether (i.e., the latency ultimately decreases to the point where accidents do not occur and the alarm does not go off). This explanation of how the alarm works is accurate but highly simplified. The fundamental point is that the alarm can be used readily in PCBP and it works. The alarm has not just been shown to be effective; it has been shown to be more effective, in terms of continence achieved and relapse avoided, than any other treatment used for enuresis including all other behavioral approaches and a variety of medications.

6. Habit Disorders

Habitual repetitive behaviors are common in young children. For example, between 25% and 50% of children younger than 4 exhibit habitual thumb sucking. Smaller, but substantial, percentages of children exhibit other habitual behaviors such as head banging, body rocking, nose picking, fingernail biting, or hair pulling. These habits are typically benign in young children and the PCBP service offered is usually supportive counseling. But perpetuated (beyond specified age norms) or singularly intense practice of the habits places children at risk and in need of prescriptive behavioral pediatric treatment. A large collection of studies document the effectiveness of treatments, based on assumptions of PCBP (e.g., time in, simplified instruction, targeted consequences), for a broad range of problematic habits in young children (see case illustration below).

Effective treatment of habit problems in older children usually involves more complex approaches and more active participation of the child than treatment for young children. The most outstanding example of such treatment is habit reversal, a habit treatment package based on the assumptions underlying PCBP, suitable for use in PCBP, and more empirically supported for treatment of a broad range of habits (from tics to tantrums) than any other approach described in the literature. In its conventional form, habit reversal is a multicomponent procedure that includes relaxation training, self-monitoring, situations (where habits are likely to occur) review, awareness training, review of

consequences (of the habit), social support, and competing response exercises. Although the number of components in habit reversal may make it seem impractical for some PCBP practitioners, especially those whose sessions are short (e.g., pediatricians), streamlined versions have been shown to be just as effective as the full package. For example, a recently published study showed that an abbreviated version of habit reversal, including only brief relaxation and competing response exercises, eliminated habitual mouth biting in a 16-year-old boy. The biting was a long time habit that occurred almost “unconsciously” especially when the boy was nervous or bored. Treatment was delivered in one session and results were produced almost immediately. This study (and many others like it) supplies the empirical basis for our conviction that habit reversal is a valuable part of the PCBP armamentarium.

7. Other Problems

The examples above represent only a small sample of empirically supported treatments for problems presenting in PCBP. Successes with similar treatments (i.e., PCBP appropriate) have been documented for many problems not mentioned, including difficulties with feeding, encopresis, recurrent abdominal pain, other “learned illnesses,” early onset anxiety, simple phobias, other mild anxiety problems, attentional problems, and school problems. Collectively the breadth of the problems, and the extent of the evidence showing their successful treatment, supplies a major part of the empirical basis for the rapidly expanding view that PCBP is a highly appropriate and important approach to mild and moderate child behavior problems.

V. CASE ILLUSTRATION

A 3-year-old girl was seen for chronic hair pulling of 1 year's duration. The hair pulling had resulted in abnormal hair loss on the crown of her head (approximately a 13 × 8 cm patch). The hair pulling occurred mostly during sedentary activities or during the onset to sleep. She did not exhibit other significant behavior problems and was described by her parents as happy, compliant, and highly intelligent. The parents had tried several procedures to stop the hair pulling with no success. These included scolding, reasoning, hats, edible rewards for not pulling, and spanking.

The treatment for hair pulling involved three components: (1) increased nurturing (i.e., time in) was provided by asking each parent to increase physical touching

by 50 touches per day and to play with their daughter at least 10 minutes per day, providing frequent praise and avoiding questions, commands, or criticisms. In addition, the usual bedtime routine was extended by 15 minutes. (2) The child was placed in time out for 3 minutes contingent on observed hair pulling. (3) Response prevention was used to help the child limit her hair pulling. The child agreed to select a pair of loose fitting cotton socks (hand socks) to be placed over her hands if she was observed pulling her hair while in time out. She also wore the hand socks to bed at night. Three days per week one parent observed the child for the presence or absence of hair pulling during 5 high-risk 1-hour time intervals. The percentage of intervals during which hair pulling occurred was recorded for each day.

A within-series withdrawal of treatment (ABAB) experimental design was used to assess the effects of treatment. This design involves periods of no treatment baseline (A) and periods of treatment (B). Experimental effects are determined based on differences between the A and B periods. For example, high levels of the target behavior during the baseline (A) periods contrasted with low levels during the treatment (B) periods are strong evidence that the treatment works (reduces the target behavior). During the initial baseline period in this case, hair pulling occurred in 76% percent of the observation intervals (see Figure 1). During the first treatment period, hair pulling reduced to 22% of intervals. During the second baseline period, hair pulling resumed at the original baseline levels and during the second treatment period it reduced to zero levels, where it stayed. The use of hand socks at bedtime was stopped after 2 months, but the parents continued the use of increased time in. Six months after the study, hair pulling was still at zero levels, and at a 2-year follow-up the child had a full head of hair, approximately 14 inches in length.

This case is a classic demonstration of PCBP, for at least three reasons. First, it involves a behavior problem, chronic hair pulling, that it is routinely viewed as evidence of psychopathology. The evaluation and treatment used here, however, negate this view. The pulling was not accompanied by other problem behavior, responded readily to direct treatment, and did not recur in another form during or after treatment. In other words, the pulling appeared to be a simple habit disorder presenting in an otherwise normal child and an appropriate context of care for such problems is PCBP. Second, the clinical approach involved both forms of PCBP, supportive counseling (e.g., the pulling was placed in its appropriate developmental and prognostic context) and prescriptive treatment. Third, the prescriptive treatment was based on

the theoretical assumptions of PCBP. The parents' verbal interactions with their daughter regarding pulling were reduced to a highly simplified and quantitative minimum. The focus of their interactions was directed away from what their child thought, felt, and said about pulling and onto pulling itself (i.e., doing). For example, their repeated attempts to obtain an explanation for the pulling from their daughter or to reason with her about it were terminated. They imposed consequences (time out) for pulling that involved the type of experiential contrast (unpleasant, nonpreferred) that would reduce its likelihood in the future. Lastly, in order to increase the amount of contrast produced by time out, the parents employed various methods to increase the experientially pleasant aspects of their daughter's life (i.e., to increase time in).

VI. SUMMARY

There is a vast number and array of child behavior problems that, although not necessarily representative of true psychopathology, do pose psychological risks for the children who exhibit them and for their families. Almost all of these problems are initially seen in primary care settings and, absent a deterioration sufficiently serious to warrant specialty care, the majority are seen only in primary care. To remedy the problems early and obviate the risks they pose, we propose they be evaluated and treated within pediatric primary care itself via a special branch called primary care behavioral pediatrics. The principal types of therapies used in PCBP are supportive counseling and prescriptive behavioral treatment. Supportive counseling involves placing presenting problems in their appropriate developmental and prognostic context and prescriptive behavioral treatment involves the provision of procedure-based interventions for their remediation. PCBP is a multidisciplinary specialty but its practice is largely confined to psychologists and physicians. Limitations on time and in training, however, may reduce the physician's ability to deliver more complex procedures or to modify treatment in accord with unexpected responses. But because the physician is very likely the first professional to whom behavior problems are reported and because there often are medical considerations in the evaluation of behavior problems, the position of this chapter is that a partnership between physician and psychologist is optimal for practice. A representative sample of problems appropriate for PCBP includes risky infant behavior, oppositional behavior in younger and older children, bedtime problems, incontinence, and various habit disorders. It is important to stress that PCBP is not

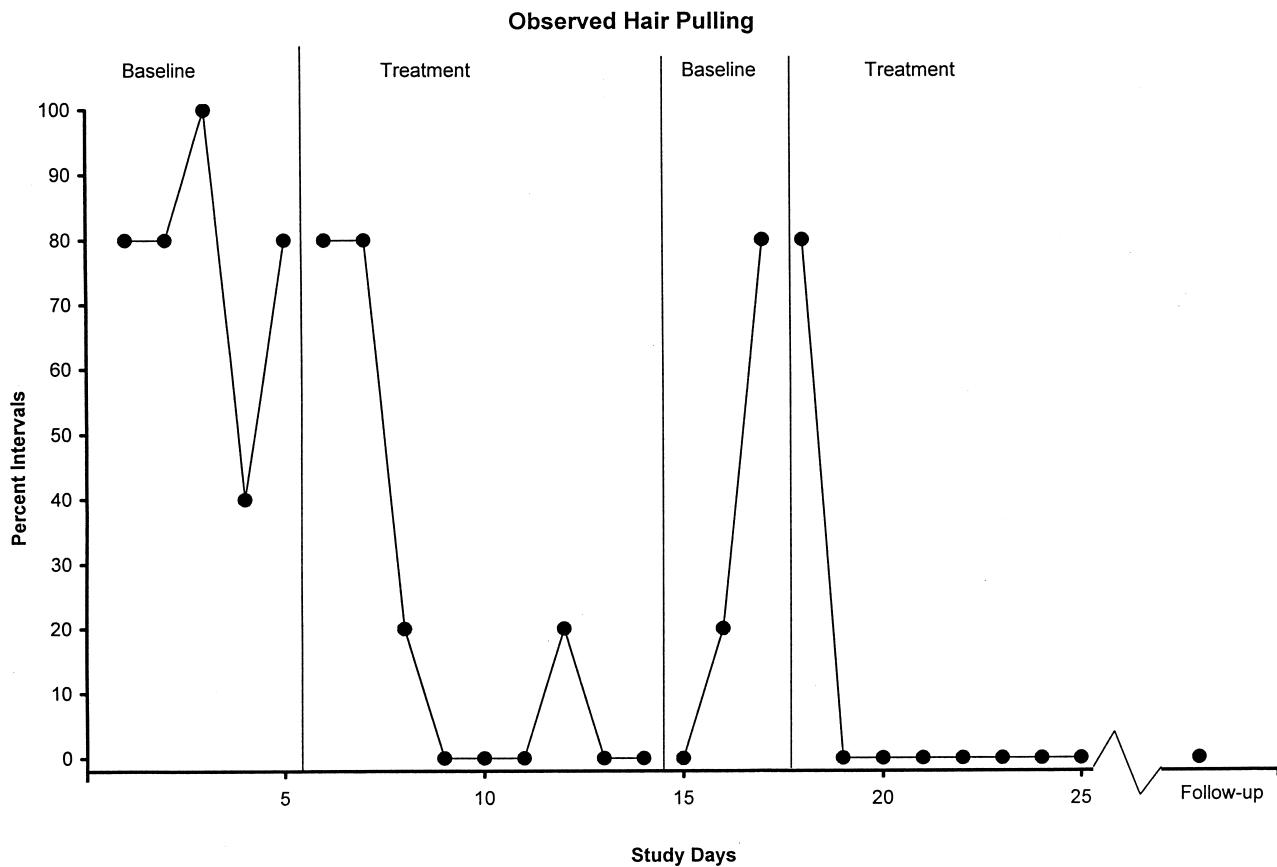

FIGURE 1 This figure shows the effects of treatment on hair pulling. The data points represent the percentage of intervals where hair pulling occurred. During baseline periods treatment was not administered. Reprinted with permission from *Pediatrics* 91, 944. Copyright 1993, the American Academy of Pediatrics.

a universal approach for behavior problems in childhood. It is rather best viewed as the optimal domain for early intervention. Serious diagnostic conditions such as major depression, suicidal behavior, or delinquency represent boundary conditions for PCBP and should be referred for specialty care as soon as they are identified. Additionally, referral is recommended when presenting problems prove resistant to supportive counseling and prescriptive treatment. Behavioral pediatrics is thus proposed as a supplement to and not a substitute for existing care systems.

See Also the Following Articles

Behavioral Consultation and Therapy ■ Child and Adolescent Psychotherapy: Psychoanalytic Principles ■ Family Therapy ■ Home-Based Reinforcement ■ Nocturnal Enuresis ■ Parent-Child Interaction Therapy ■ Time-Out

Further Reading

- Bijou, S. W. (1993). *Behavior analysis of child development*. Reno, NV: Context Press.
- Blum, N., Williams, G., Friman, P. C., & Christophersen, E. R. (1995). Disciplining young children: The role of reason. *Pediatrics*, 96, 336.
- Blum, N., & Friman, P. C. (2000). Behavioral pediatrics: The confluence of applied behavior analysis and pediatric medicine. In J. Carr & J. Austin (Eds.), *Handbook of applied behavior analysis*. Reno, NV: Context Press.
- Brazelton, T. B. (1973). *Neonatal behavior assessment scale*. Philadelphia: Lippincott.
- Carey, W. B., & McDevitt, S. C. (1995). *Coping with children's temperament: A guide for professionals*. New York: Basic Books.
- Christophersen, E. R. (1998). *Little people*. Shawnee Mission, KS: Overland Press.
- Christophersen, E. R., Finney, J. W., & Friman, P. C. (Eds.) (1986). Prevention in primary care. *Pediatric Clinics of North America*, 33.

- Forehand, R., & Long, R. (1996). *Parenting the strong willed child*. Chicago, IL: Contemporary Books.
- Friedman, S. B. (1975). Foreword. *Pediatric Clinics of North America*, 22, 515–516.
- Friman, P. C., & Jones, K. M. (1998). Elimination disorders in children. In S. Watson & F. Gresham (Eds.), *Handbook of child behavior therapy*. New York: Plenum.
- Friman, P. C., & Rostain, A. (1990). Trichotillomania in children: A caveat for primary care. *New England Journal of Medicine*, 322, 471.
- Levine, M. D., Carey, W. B., & Crocker, A. C. (1999). *Developmental-behavioral pediatrics*. Philadelphia: W. B. Saunders.
- Webster-Stratton, C., & Herbert, M. (1994). *Troubled families, troubled children*. New York: John Wiley.

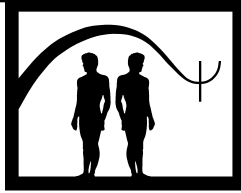

Progressive Relaxation

Rachel L. Grover and Douglas W. Nangle

University of Maine

- I. Description of Treatment
 - II. Theoretical Bases
 - III. Applications and Exclusions
 - IV. Empirical Studies
 - V. Case Illustration
 - VI. Summary
- Further Reading

to be aware of muscle tension and to release quickly that tension. One common system of progressive relaxation involves tensing and releasing various muscle groups until a deeply relaxed state can be accomplished through simply recalling the feeling of relaxed muscles. Progressive relaxation is used with a variety of populations to alleviate a range of complaints including anxiety, depression, and psychophysiological disorders.

GLOSSARY

autonomic nervous system The part of the nervous system that controls involuntary actions of the smooth muscles, heart, and glands. Consists of sympathetic and parasympathetic portions.

psychophysiological Pertaining to the branch of psychology that is concerned with the biological bases of psychological processes.

sympathetic nervous system The part of the autonomic nervous system that inhibits or opposes the effects of the parasympathetic nervous system, as in reducing digestive secretions, speeding up the heart, and contracting blood vessels.

systematic desensitization A behavior therapy technique that is used to reduce or eliminate anxiety. Deep muscle relaxation is paired with imagined scenes or actual anxiety-provoking situations that increase in intensity.

Progressive relaxation represents a group of therapeutic techniques that seek to reduce one of the physiological manifestations of anxiety by teaching a person

I. DESCRIPTION OF TREATMENT

A. The Basic Procedure

Progressive relaxation training should take place in a quiet, dimly lit room with little chance of disruption. The client is seated in a chair that completely supports the body, thus enabling tension and relaxation of all required muscle groups. The client is encouraged to wear loose-fitting clothing to prevent the distraction of uncomfortable attire.

Progressive relaxation training involves teaching the client to tense and relax a series of 16 muscle groups: (a) dominant hand and forearm; (b) dominant biceps; (c) nondominant hand and forearm; (d) nondominant biceps; (e) forehead; (f) upper cheeks and nose; (g) lower cheeks and jaws; (h) neck and throat; (i) chest, shoulders, and upper back; (j) abdominal or stomach region; (k) dominant thigh; (l) dominant calf; (m) dominant foot; (n) nondominant thigh; (o) nondominant calf; and (p) nondominant foot. To begin, the client is

encouraged to focus on the first muscle group and to tense the muscles in that group for a period of 5 to 7 sec. Then the client is instructed to relax the muscle group for 30 to 40 sec. During both tension and relaxation, the therapist helps focus the attention of the client on the muscular experience. Comments such as, "Notice what it is like to have tension/relaxation in these muscles" are useful. The tense-relax sequence then is repeated with the same muscle group, with an increase in relaxation time to 45 to 60 sec. The client is required to attain full muscle relaxation with each muscle group before progressing to the next group. The therapist asks the client to signal complete relaxation by raising a finger of the right hand before continuing to the next muscle group. If the client does not report total relaxation in the specified muscle group, the tense-relax procedure is repeated. To avoid muscle fatigue or pain, repetition should not exceed four or five times.

With the application of the tense-relax sequence to the chest, shoulders, and upper back, breathing cues are added to the instructions. The therapist begins including mild suggestions about breathing into the script (e.g., "Notice your slow and regular breathing"). In addition, the client now is instructed to take a deep breath and hold it during the tension phase and to release the breath during the relaxation phase of each subsequent muscle group.

Upon completion of the entire sequence, the therapist reviews the targeted muscle groups and encourages the client to continue to relax. Then, the client's overall level of relaxation is assessed. Once again, the therapist asks the client to signal when a state of complete relaxation throughout the body has been achieved. If the client does not signal complete relaxation, then the client is asked to signal tension in a muscle group as the therapist lists the possible groups. On the identification of tension, the tense-relax sequence is repeated. The assessment phase is continued until complete relaxation is obtained or until the therapist decides to terminate the training. Prior to concluding the training, the client is allowed to experience complete relaxation for a few moments. At this time, the therapist makes comments that aid the client in remaining focused on the feeling of relaxation. After a few minutes, the therapist may begin the termination process.

The therapist guides the client out of the relaxed state by asking the client to begin moving muscle groups. For example, the therapist may count backwards from 1 to 4, informing the client to move legs and feet at 4, arms and hands at 3, head and neck at 2, and to open the eyes at 1. The client is encouraged to continue feeling re-

laxed and calm. In addition, the client is prepared for the possibility that he or she may feel dizzy or disoriented on emergence from the state of deep relaxation.

Relaxation is a skill that cannot be perfected without practice. Therefore, the client should be encouraged to practice twice a day for 15 to 20 min. The therapist helps the client identify appropriate times and places to practice progressive relaxation. For best results, the client is asked to practice on a comfortable chair or bed when there is no time pressure and little chance of disruption.

B. Variations on the Basic Procedure

Once the client is able to completely relax the 16 muscle groups, the therapist condenses the progressive relaxation procedure to decrease the amount of time needed to reach a fully relaxed state. Frequently, the initial 16 muscle groups are decreased to 7 muscle groups including: (a) dominant arm; (b) nondominant arm; (c) facial muscles; (d) neck and throat; (e) chest, shoulders, upper back, and abdomen; (f) dominant thigh, calf, and foot; and (g) nondominant thigh, calf, and foot. The procedure can be further reduced to include 4 muscle groups in the tense-relax sequence: (a) arms, hands, and biceps; (b) face and neck; (c) chest, shoulders, back, and abdomen; and (d) thighs, calves, and feet. The client must master each variation both in session and during home practice before progressing to the next version.

Following competence in relaxation through the tense-relax sequence, the client is introduced to relaxation through recall, or muscle relaxation achieved through memory of the relaxed state, without the initial tension. The therapist encourages the client to think about a particular muscle group and then relax by remembering how to release those muscles. After focusing on the relaxed muscle for 35 to 45 sec, the therapist asks the client to signal if the muscle group in question is relaxed. Similar to the basic procedure, the client should achieve complete relaxation in a muscle group prior to proceeding to the next group. Also, the therapist may repeat a muscle group if needed. This new approach is incorporated into the home practice sessions.

When the client becomes proficient at relaxation through recall, the therapist transitions the client into relaxing the entire body by counting from 1 to 10. The therapist first introduces this technique when the client already is in a relaxed state. After relaxing each muscle group through recall, the therapist instructs the client to notice all the muscles in the body continuing to relax as the therapist counts to 10. Once the client has

practiced this approach at home several times, the therapist works with the client toward reaching a relaxed state solely by counting from 1 to 10. Again, the client must practice this skill.

C. Applied Relaxation

The goal of progressive relaxation training is for the client to learn an effective way to reduce muscle tension in daily life. Therefore, the client needs to learn to transfer these skills from the twice-daily practice sessions to routine situations throughout the day. The process of using relaxation skills in specific stressful situations is called “applied relaxation.” Applied relaxation training as described by psychologist Douglas Bernstein and colleagues, consists of four components. First, the client learns to monitor tension in the body and notice when the body begins to move away from a relaxed state. Second, the client becomes adept at implementing relaxation responses subsequent to the detection of tension. Next, frequent practice is recommended to improve the skill of the client at deploying relaxation strategies. Last, the client learns several different approaches for reclaiming a relaxed state to optimize the chance of success in a variety of anxiety-provoking situations.

II. THEORETICAL BASES

Several conceptual explanations have been theorized to account for the ability of progressive relaxation to reduce anxiety. Edmund Jacobson’s work in the first half of the 20th century represented the first significant attempt to investigate this relationship. In his early studies, Jacobson observed that the subjective state of anxiety was accompanied by a contraction of muscle fibers. In subsequent investigations, he observed that thoughts of physical activity elicited corresponding electrical activity in the expected muscle group. Similarly, absence of thought was associated with negligible electrical activity in the musculature. Using the earlier information, Jacobson theorized that prolonged stress resulted in chronic tension. This chronic tension caused excessive strain on the musculature and a sustained increase in activity in the central nervous system that contributed to a variety of pathological conditions. In Jacobson’s view, deep relaxation of the muscles would decrease activity in the central nervous system thus preventing and ameliorating psychological and/or physical distress. In 1938,

he developed the tense–release procedure he named progressive relaxation and used it to treat anxious people. By 1962, the therapy was an intensive experience involving 15 muscle groups and extending over 50 hour-long sessions of training.

Around 1950, the inclusion of an abbreviated form of progressive relaxation in a successful treatment for anxiety called systematic desensitization precipitated another wave of empirical scrutiny. Systematic desensitization is a treatment approach that entails imagined or actual contact with the feared stimuli in stages progressing from least stressful to most distressing. At each stage, an individual is encouraged to experience the stimuli until a reduction of anxiety occurs, thus lessening the learned fear. The subjective experience of anxiety is thought to have cognitive, behavioral, and physiological components. When a person experiences anxious arousal, increased activity in all of the components contributes to the amplification and length of the anxious state. Psychologist Joseph Wolpe theorized that muscle relaxation was physiologically incompatible with the experience of anxiety. Therefore, relaxation intervenes in this process by reducing physiological arousal. As such, the presentation of a feared stimulus coupled with a physiological state incompatible with fear could eventually eliminate the conditioned anxiety response.

Additional research has supported this theory. The physiologist Ernst Gellhorn developed the most thorough explanation of the mechanisms by which progressive relaxation affects the autonomic nervous system. Gellhorn theorized that relaxed muscles correspond to a decrease in activity in the autonomic nervous system caused by the lack of feedback information from the skeletal muscles. The physiological aspects of anxiety are activated by the part of the brain that stimulates the sympathetic nervous system, or the reticular system. Gellhorn noticed that a large proportion of the nerve input into the reticular system came from fibers in the skeletal muscles. As such, progressive relaxation reduces autonomic arousal (e.g., decreased heart rate and blood pressure) by reducing input to the reticular system and therefore, the sympathetic nervous system. In addition, nerve fibers also connect the reticular system to the cortex: the area of the brain associated with the feeling of nervousness and increased vigilance. Thus, progressive relaxation may also dampen alertness and cognitive activity. Indeed, the research of psychologist F. J. McGuigan revealed that all thought is associated with muscular activity. Hence, reduction of muscular activity can result in a lessening of cognitive activity.

III. APPLICATIONS AND EXCLUSIONS

A. Applications

Progressive relaxation was developed to reduce tension in clients who have chronic anxiety problems; thus early applications were predominately limited to this population. However, in recent years the range has greatly broadened to include a variety of people who suffer from an extended scope of problems including insomnia, hypertension, tension headache, explosive anger, chronic pain, and depression. In addition, progressive relaxation occasionally is used to aid the therapeutic process. For example, relaxation training may enable a client to discuss a particularly distressing topic. On the other hand, research suggests that progressive relaxation works best when the central difficulty is tension. Progressive relaxation is appropriate for both adults and children, and there is a manual that includes suggested amendments in procedures for children with special needs.

In their 2001 manual, Bernstein and colleagues recommend a pretraining inventory to assess the appropriateness of a client for progressive relaxation training. First, any biological bases for the presenting problem should be ruled out. Second, the therapist should assess the possible risks of relaxation for that client. For example, a client may have an injury that is aggravated by repeated tensing and releasing of a muscle group. Next, if possible, the client should discontinue the use of any muscle-relaxing drugs as they may interfere with the client learning how to control tension and relaxation. Finally, the therapist should consider whether progressive relaxation training is likely to alleviate the client's complaint.

B. Exclusions

There are a few reasons why some clients may not benefit from training in progressive relaxation. However, adjusting some basic procedures can accommodate the limitations of most clients. For example, if a person has an injury that prevents tensing a muscle group, the therapist may instruct only to relax that muscle group thus forgoing the tension phase. Similarly, clients with breathing difficulties (e.g., chronic congestion due to smoking or allergies) may need to sit upright for the training to prevent coughing. Other exclusionary factors are more serious. For example, individuals who lack muscle control will, obviously, not

benefit from this intervention. Second, a minority of individuals experience "relaxation-induced anxiety" that may prevent them from gaining any benefit from relaxation training. Relaxation-induced anxiety refers to a variety of symptoms including fear of losing control, increased tension, and increased indications of anxiety that appear to be triggered by relaxation. Third, relaxation approaches are ineffective when skill deficiencies rather than anxiety appear to be the problem. For example, highly test-anxious college students are helped more by instruction in test-taking skills than by relaxation methods. Finally, there are many disorders for which progressive relaxation has been found to be inappropriate (e.g., muscle pain disorder, excessive gastric acid output, tinnitus).

IV. EMPIRICAL STUDIES

Progressive relaxation has been applied to a large variety of physical and psychological complaints. This section reviews the research on those classes of disorders most frequently investigated in connection with relaxation methods. As the original progressive relaxation procedure was designed to counteract anxiety, the majority of the research falls within this topic area. In addition, a considerable amount of research has investigated progressive relaxation as a component in the treatment of depression. Finally, progressive relaxation also is used to help treat psychophysiological disorders such as headache, hypertension, insomnia, and chronic pain.

A. Anxiety Disorders

Progressive relaxation training is an element present in the treatment of almost all anxiety disorders including generalized anxiety disorder, panic disorder, specific phobias, and posttraumatic stress disorder. Progressive relaxation training is often used as an essential component in a more comprehensive treatment package targeting physical, behavioral, and cognitive aspects of anxiety. For example, although progressive relaxation reduces anxiety, the most successful treatment for generalized anxiety disorder is a multicomponent package that includes cognitive, behavioral, and physiological aspects. The empirical literature reveals that individuals with anxiety treated with a treatment package tend to report significantly less anxiety than people given a placebo, drug treatment, nondirective counseling, or no treatment. Similarly, in the treatment of panic disorder, progressive relaxation alleviates panic to a greater extent

than no treatment. However, the therapies with the most empirical support are multicomponent composed of exposure to panic triggers, cognitive therapy, deep breathing, and progressive relaxation.

In the treatment of specific phobias, repeated exposure to the feared stimuli is essential. Contact with the feared object or situation is introduced in stages through systematic desensitization. At each stage, exposure is encouraged until a reduction of anxiety occurs, thus lessening the learned fear. Progressive relaxation has been used for decades as part of systematic desensitization to facilitate the fear reduction process. Indeed, in a few studies, the addition of a relaxation component to exposure has increased the effectiveness thereby demonstrating its validity as a necessary component of treatment.

Research on the treatment of posttraumatic stress disorder reveals that progressive relaxation alone is not a viable treatment. However, the treatment packages that have empirical support all include a relaxation module. In each therapy program, progressive relaxation is used to create a mood state that resists anxiety in a systematic desensitization, flooding, or stress inoculation procedure.

B. Depression

Applying progressive relaxation procedures to depression emerged from the observation that anxiety symptoms often occur along with depression. Moreover, depression can be exacerbated by stress. A few research studies have demonstrated the superior effectiveness of progressive relaxation alone to no treatment in adolescents and adults with mild to moderate depression and in women with postpartum depression. More frequently, research supports the inclusion of a relaxation component in a comprehensive treatment package for depression. One such treatment program has garnered an extensive amount of research endorsement. The Coping with Depression Course was designed by psychologist Peter Lewinsohn and colleagues to aid in the treatment of depressed adults and adolescents. In clinical trials, it has proven to significantly reduce depression scores and the rate of diagnoses in comparison to a wait-list control condition. Moreover, the empirical literature suggests that results are maintained over time. In addition to progressive relaxation training, the Coping with Depression Course is composed of several treatment components including cognitive therapy, social skills training, pleasant events scheduling, self-monitoring, and training in personal goal achievement in a group setting.

C. Behavioral Medicine

In recent years, progressive relaxation increasingly is used to alleviate the effects of stress-related and psychophysiological disorders such as headache, hypertension, insomnia, and chronic pain. Progressive relaxation training is an effective treatment for both tension and migraine headaches. Recent investigations demonstrated that in the treatment of tension headache, relaxation training is more effective at reducing the strength and frequency of headaches than headache monitoring, false biofeedback, medication placebo, and attention placebo. In addition, gains in treating tension headache through progressive relaxation tend to be long-term improvements. Progressive relaxation in combination with thermal biofeedback appears to be a successful treatment for migraines, proving more beneficial than headache monitoring and medication placebo. Component treatments that include progressive relaxation (or applied relaxation) and cognitive therapy also reduce and weaken migraine headaches more than headache monitoring, and at times, placebo conditions.

Early research on the effects of progressive relaxation on hypertension yielded promising results, leading research reviews at that time to conclude that relaxation training was effective in lowering blood pressure. Unfortunately, many of the positive results of these investigations have not been replicated. In fact, few studies continue to support the benefits of progressive relaxation over blood pressure monitoring and placebo. Currently, more attention is being paid to comprehensive treatment packages that include relaxation as a component along with stress management skills and healthy lifestyle behavior training. However, further research should be done to determine whether progressive relaxation is a useful component in the treatment of hypertension.

Insomnia is probably the most common behavioral medicine complaint that progressive relaxation has been applied to treat. Progressive relaxation is considered to be an effective treatment for insomnia. However, combination treatment packages that also include stimulus control and sleep restriction techniques tend to be more effective than relaxation training alone.

Similarly, multicomponent treatments for chronic pain have proven to be more effective than relaxation training alone. The more effective treatment packages for chronic pain are cognitive behavioral in orientation and composed of goal setting, increased activity and/or exercise, pain education, and medication management. These comprehensive treatments generate more

favorable results than no-treatment control, standard physical rehabilitation, and attention placebo conditions. However, the overall effectiveness of progressive relaxation training on the treatment of chronic pain is unclear as the majority of research is based on lower back and joint pain and pain experienced as a result of rheumatoid arthritis.

V. CASE ILLUSTRATION

“Tom” was a 42-year-old male living alone subsequent to a recent divorce. Tom had no history of previous psychiatric treatment, although he did report a serious head trauma when he was a teenager. At the time of referral for depression, Tom was self-employed as a painter and also performed routine maintenance on several houses. Tom presented for treatment on the recommendation of his parents who were concerned about his lingering depression. In the initial interview, Tom stated that he was apprehensive about therapy and was willing to attend only because it relieved his parents’ fears. Throughout the session Tom sat rigidly upright and gripped tightly the arms of the chair.

As Tom began to trust the therapist in subsequent assessment sessions, he confided that he had been depressed since his divorce 1 year ago. In addition, he had recently experienced suicidal thoughts in the form of visions of himself jumping off the roof of a house that he was painting. He reported that that he did not want to die, but was terrified that he would “lose control” and jump. He stated that this fear caused him a great deal of anxiety resulting in difficulty sleeping and an inability to concentrate on his work. These initial sessions were extremely difficult for Tom as he maintained his high level of muscle tension and stated that it was anxiety provoking to confide his fears to another person.

As a result of the assessment, the therapist concluded that Tom would benefit from cognitive-behavioral therapy for his depression. However, his high level of anxiety surrounding the therapeutic process was a significant barrier to this process. Therefore, the therapist introduced progressive relaxation training as a coping skill to be used during therapy and at his work. The therapist predicted that after mastering progressive relaxation, Tom would be able to discuss his concerns with less distress and be able to examine more readily his thoughts and behaviors.

Progressive relaxation training followed Bernstein and colleagues’ 2001 manual for this purpose. The first four sessions focused on tensing and relaxing 16 major muscle groups. Tom was able to signal deep relaxation during

the second training session. The therapist asked Tom to practice the training on his own at least twice a day. Tom reported practicing three times the first week, but increased his practice sessions in the following weeks as he became more familiar with the procedure. In the next two sessions, the therapist concentrated on tensing and relaxing 7 major muscle groups. Tom continued to report deep relaxation during the training sessions. He also appeared visibly more relaxed. He stopped gripping the arms of his chair during session and presented a more relaxed posture. Tom reported that he was less anxious at work and his suicidal thoughts had decreased. In the next few sessions, the therapist continued the tense-and-release training with four muscle groups. Finally, Tom was able to progress to relaxation with recall training and relaxation with counting training. Tom was instructed to continue to practice at least once daily during the continuation of therapy.

Following the progressive relaxation training, Tom obtained slightly lower scores on measures of depression and greatly reduced scores on measures of anxiety. More important, his fears of committing suicide disappeared. Tom was able to discuss his thoughts surrounding his divorce with less distress. He reported continuing the therapeutic process both for his parents and for himself.

VI. SUMMARY

Progressive relaxation refers to a closely related group of procedures designed to reduce muscle tension, one of the physiological symptoms of anxiety. The described technique involves repeated tensing and releasing of a series of muscle groups. The tense-relax process increases awareness of muscle tension and how to alleviate that tension. After a client achieves deep relaxation with the original procedure, the amount of muscle groups is systematically reduced. Once the client attains a state of deep relaxation using the tense-release system, the client then is introduced to a less intensive way to relax. For example, counting from 1 to 10 as the client relaxes the body is often used to encourage relaxation. In this way, the client learns to reach a relaxed state with less investment of time and energy. Learning the basic progressive relaxation skills enables the client to then utilize the skills in stressful situations in daily life. Progressive relaxation may be used with both adults and children and is easily adapted for individuals with special needs. However, relaxation training is not appropriate for people who cannot control their skeletal musculature. Progressive relaxation frequently is used to treat anxiety

disorders, depression, and several psychophysiological complaints. Progressive relaxation is most effective when included in a multicomponent treatment package.

See Also the Following Articles

Applied Relaxation ■ Breathing Retraining ■ Panic Disorder and Agoraphobia ■ Relaxation Training ■ Stretch-Based Relaxation Training ■ Successive Approximations ■ Systematic Desensitization

Further Reading

Bernstein, D. A., Borkovec, T. D., & Hazlett-Stevens, H. (2001). *New directions in progressive relaxation training:*

A guidebook for helping professionals. Westport, CT: Praeger.

Carlson, C. R., & Hoyle, R. H. (1993). Efficacy of abbreviated progressive muscle relaxation training: A quantitative review of behavioral medicine research. *Journal of Consulting and Clinical Psychology, 61*(6), 1059–1067.

Cautela, J. R., & Groden, J. (1978). *Relaxation: A comprehensive manual for adults, children, and children with special needs.* Champaign, IL: Research Press Company.

Goldfried, M. R., & Davison, G. C. (1994). *Clinical behavior therapy* New York: John Wiley & Sons.

Lehrer, P. M., & Woolfolk, R. L. (Eds.). (1993). *Principles and practice of stress management* (2nd ed.). New York: Guilford.

Roth, W. T. (Ed.). (1997). *Treating anxiety disorders.* San Francisco: Jossey-Bass.

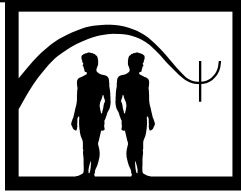

Projective Testing in Psychotherapeutics

J. Christopher Fowler

The Erik H. Erikson Institute for Education and Research

- I. Projective Techniques and Psychoanalysis
- II. Projective Techniques for Diagnostics and Treatment Planning
- III. Empirical Evidence and the Scientific Status of Projectives
- IV. Summary
Further Reading

GLOSSARY

diagnostic evaluation report The vehicle for communicating interpretations of test data that illuminates the underlying personality structure, object-relations paradigms, sources of psychological distress, and the framework for understanding defense constellations, as well as providing treatment recommendations and consultation to the referring therapist.

early memories test Procedures to elicit early childhood memories work from the basic assumption that early childhood memories are retrospective narrative creations that reveal aspects of psychological functioning rather than objective truths about the person's life. Narratives are analyzed using a variety of content and structural scoring systems to assess object-relations themes, character styles, depression, and behavioral disorders.

personality assessment Utilizing various instruments, diagnosticians are able to synthesize an understanding of individual's cognitive style, emotional attitudes, and aptitudes, as well as primary defenses and conflicts.

projective techniques A broad array of assessment procedures utilizing ambiguous stimuli and opaque instructions to conceal the nature of the task and the personality struc-

tures being assessed. Ambiguity presses the individual to organize responses in terms of personal motivations, perceptions, attitudes, ideas, emotions, problem-solving strategies and core dynamic conflicts.

Rorschach inkblot method Hermann Rorschach's perceptual/projective test consisting of 10 standardized inkblots of varying color and form that are administered to the participant one at a time with the request to describe, "What the inkblot might be." From the free associations and the inquiry of the determinants making up a percept, the examiner applies one of several standardized scoring systems to develop hypotheses relevant to personality traits, perceptual and problem-solving styles, prototypic modes of interpersonal relating, degree of thought, mood, and impulse disturbance. Systems for analysis vary from a-theoretical empirical approaches to psychoanalytically derived systems.

thematic apperception test Conceived by Henry A. Murray as a narrative projective device, the TAT consists of 20 scenic pictorials from which participants are instructed to create narratives about the scenes and human representations. Through the participant's imaginative elaborations, the psychological examiner makes inferences about themes most important in the participant's life. From these themes, psychological datum such as the participant's needs and "press," prototypic relationship paradigms, object relations, and understanding of social causality can be ascertained.

word association methods A series of assessment methods utilizing stimulus words or phrases to elicit immediate associations. Thematic analysis and comparison of participant's responses to normative data allows for discerning complexes and defenses.

I. PROJECTIVE TECHNIQUES AND PSYCHOANALYSIS

The demand for assessment techniques that probe beyond the patient's conscious defenses and resistances could only have developed from clinical and theoretical systems that endeavored to comprehend the obscure layers of personality functioning, and to explore the interplay of conflicts and fantasies in the creation of symptoms. Inherent in the psychoanalytic model is the assumption that superficial layers of personality structure are readily available to consciousness, but to comprehend unconscious motivations, fantasies and complexes require the specialized techniques of free association, dream interpretation, and the analysis of the transference. Projective techniques are the logical application of psychoanalytic theory to assess underlying structures.

Assessment methods specifically designed to tap into hidden complexes and conflicts has a rich history involving luminaries and revolutionaries from the psychoanalytic movement. Carl Jung developed the first projective test with the Word Association Task to uncover hidden complexes and conflicts as an aspect of psychoanalytic investigations. Since Jung's test, numerous sentence completion tasks have sprung from the essential theory that irregularities in response style and repetitive patterns of themes reveal underlying conflicts that the patient would not readily reveal through traditional interview methods. Alfred Adler crafted a technique for analyzing early childhood recollections as a projective test that reveals the individual "lifestyle" and major life themes including self-schemas. Although somewhat outside the mainstream of psychoanalytic discourse, Adler's test is widely used by practitioners of the individual psychology movement. Martin Mayman, an analyst from the Menninger Foundation, drew on modern ego psychology and object-relations theory to develop a highly versatile assessment technique by inquiring into specific early childhood memories. Another class of projective test relies on complex pictures depicting people involved in various interactions to which the participant is pressed to create stories that are then analyzed for structure and content. Tests such as the Thematic Apperception Test rely on the participant's apperception of relationships to project their beliefs and emotional reactions in their stories.

Herman Rorschach, one of the first presidents of the Swiss Psychoanalytic Society, is best known for developing the now-famous inkblot method bearing his name. Rorschach believed his method did not uncover

layers of unconscious processes. Rather, he thought of it as an experimental, atheoretical method for assessing personality styles based on the perceptual organization of patient's responses. In his 1921 monograph he made patently clear that the test could not be used to tap into the contents of the subconscious. Thus from its inception, the Rorschach Inkblot Method was considered a perceptual task based on objective scoring criteria of how participants organize the inkblots into images. In this way specific contents were less important than what portions and features of the blot were utilized in the development of the percept. It is now widely acknowledged that Rorschach underestimated the full application of his technique in its ability to reveal aspects of the individual's representational world of self and others. In the last four decades analysts and nonanalytic diagnosticians have broadened the scope of the method from essentially two angles. From an atheoretical stance of a perceptual task, diagnosticians and researchers have developed empirically validated structural variables by correlating them with behaviors and personality constructs. Working from psychoanalytic theory, David Rapaport, Roy Schafer, Steven Applebaum, Sidney Blatt, and Paul Lerner have not only articulated psychoanalytic test theory, they have brought their learning from projective testing to deepen and extend psychoanalysis as a science. Still other analysts have developed specialized psychoanalytic analog scales to assess intrapsychic phenomena such as primitive defenses, object representations, and interpersonal phenomena such as dependency.

Projective techniques encompass a number of methods for measuring personality constructs that makes an all-inclusive definition impossible. Nonetheless, they share some common features and purposes. First, their purpose is to gain insight into the individual personality as a system, rather than assessing one facet or a series of disconnected features. Most tests of this nature rely to some degree on ambiguous stimuli and opaque directions as catalysts for creating data. These tests pressure the examinee to draw on inner resources to respond to visual and verbal stimuli. This forces the examinee to utilize perception, apperception, associative processes, and memory to create responses to the examiner's questions: the more ambiguous the stimuli, the greater freedom to form idiosyncratic responses that reveal aspects of individual personality. A second feature of projective tests is the nature of data analysis—like the examinee's multitude of possible interpretations of the stimulus—the diagnostician interprets data from empirically derived scoring methods, to

more “experiential” analysis that emanates from a well-organized theory of personality.

II. PROJECTIVE TECHNIQUES FOR DIAGNOSTICS AND TREATMENT PLANNING

Testing is generally undertaken to answer questions about puzzling diagnostic possibilities, to determine the presence and form of a personality disorders, and to provide consultation to therapists prior to, or during the course of psychotherapy. The standard method for answering these questions is to select a series of tests that have the greatest potential for answering the referral questions. A second consideration when compiling a battery of tests includes choosing measures that are differentially sensitive to unique manifestations of personality. For example, it is widely held that the TAT and Rorschach tap different levels of “implicit” personality functioning, and that findings from various tests, including self-report measures, provide the opportunity to observe the patient functioning under different circumstances. This data is then integrated into the formulation of the patient’s character organization and the understanding of symptoms and defense configurations (Rapaport, Gill, and Schafer wrote the classic text on this topic).

A review of the diagnostic validity of projective tests in assessing symptoms, diagnoses, and prediction of outcomes would require volumes to complete. Rather than a specific review, the following is a brief sample of how projective testing is used in treatment planning and prediction in psychoanalytic treatments.

Early developments in theory-based psychological assessment can be traced to David Rapaport’s efforts to interpret projective test responses using psychoanalytic theory of motivation, drives, and defensive structure. The fruits of such a major undertaking were best described by Martin Mayman:

Rorschach inferences were transposed to a wholly new level of comprehension as Rapaport made a place for them in his psychoanalytic ego psychology and elevated psychological test findings from mundane, descriptive, pragmatically useful statements to a level of interpretation that achieved an incredible heuristic sweep.

Although Rapaport’s approach was a considerable advance, a broadening of its scope was necessary to capture the experience and influence of the testing sit-

uation and its relation to transference paradigms as they are revealed in the testing situation. Roy Schafer, psychoanalyst and expert diagnostician, wrote the classic treatise on how the testing situation stimulates the expression of underlying dynamic configurations. For Schafer, the constraints of the patient role in being tested is an anxiety-arousing situation that stimulates and exacerbates defensive and transference reactions that can be scrutinized and integrated into the understanding of the patient. This approach brought the prediction of potentially disruptive and useful transference configurations into the scope of diagnostic testing.

Schafer and others were successful in shifting the focus from testing solely to determine analyzability to an approach that emphasizes the assessment of problems that interfere with the establishment of a therapeutic alliance to discover potential therapeutic levers, as well as predicting potential therapeutic stalemates and transference enactments that may not be readily discernible in the course of a standard diagnostic evaluation. The ability to employ new models for predicting transference enactments has become critical, as more patients were referred to treatment with severe character pathology and vulnerability to psychosis and suicide. Such patients create special challenges for therapists and hospital staff because premature terminations, turbulent transference-countertransference struggles and negative therapeutic reactions are more the rule than the exception. Predicting transference enactments are best done through a careful assessment of object relations prior to beginning psychotherapy because the capacity for interpersonal relations depends largely on an individual’s internal array of object representations.

The strength of object relations theory when applied to psychological assessment is that it provides an understanding of the complex interactions among self and object representations, defenses, pathological formations, and ego strengths that make up the entire personality. The clinical utility of testing improved dramatically when diagnosticians shifted from more traditional focus on ego structures and impulse-defense configurations framed in abstract terms, to a middle language, grounded in a patient’s phenomenology that create meaningful clinical generalizations about a patient. Diagnosticians who craft test reports in this middle language create a textured picture of a patient’s character style, their modes of relating and vulnerabilities that alert the therapist to potential pitfalls that may emerge months later during an intensifying transference.

Test data from Rorschach, TAT, and Early Memories protocols are particularly well suited to these newer

modes of data analysis. Psychoanalytic Rorschach scales have been crafted to examine features of self and object representations, generally along a developmental continuum from pathological to healthier and more mature modes of object representation. Two such scales are Sidney Blatt's Concept of the Object scale and Jeffery Urist's Mutuality of Autonomy scale. The former assesses the developmental level of object representations using a variety of projective tests including the Rorschach and the TAT. Utilizing structural variables, Blatt and his colleagues have studied the developmental progression of object representations along more cognitive lines by integrating the theories of Piaget and Werner into the system.

The Mutuality of Autonomy scale was developed for the Rorschach to assess the degree of differentiation of object representations, focusing primarily on the developmental progression of separation individuation from engulfing, fused relations, to highly differentiated self-other representations. Studies have demonstrated that the scale can be reliably scored, has a high degree of construct validity with behavioral ratings, and has been utilized in treatment outcome studies.

Drew Westen's Social Causality and Object Relations scale has been applied to TAT and Early Memories data, as well as interview and psychotherapy process data. Westen's scale assesses both cognitive and affective features of patient's understanding of interpersonal relations and the underlying structures of object representations and the affective quality of those representations. The scale successfully differentiates diagnostic groups and predicts behavioral outcomes such as early termination from treatment. A growing body research attests to its construct and convergent validity.

Early childhood memories have also been utilized to understand crucial aspects of personality functioning. Because of their reconstructive nature, early memories allow patients to express critical life themes in a camouflaged and unconscious way, while revealing their inner object relations, character structure, and prototypic transference enactments. Inner object-relation constellations intrude into the structure and content of early memories, just as they occur repetitively in important interpersonal relationships. This is precisely what makes early memories so revealing of the private inner world, allowing therapists to make informed decisions about therapeutic stance, and timing of interventions in order to facilitate a viable therapeutic alliance. A vast array of studies assessed early memories in treatment planning, determining character organization, and assessing potential transference paradigms.

III. EMPIRICAL EVIDENCE AND THE SCIENTIFIC STATUS OF PROJECTIVES

The fate of projective testing is continuously in question because heated disagreements over the scientific status of projective techniques, most notably the Rorschach Inkblot Method, are consistently engaged in scholarly journals. This article cannot address the scope of this debate but provides some evidence of the utility and empirical validity of the projective techniques, using the Rorschach as the prototype. A brief review is undertaken to examine the accuracy of Rorschach in assessing select disorders, in predicting treatment outcome, and in assessing change during and after intensive psychodynamic treatment.

Research has demonstrated the validity of some, but certainly not all Rorschach indexes in accurate diagnosis. When appropriately formulated, the Rorschach has demonstrated high degrees of validity in measuring specific personality constructs such as interpersonal dependency, ego strength, defense mechanisms, and quality of object relations. In terms of differential diagnosis, specific patterns of Rorschach responses have been correlated with independent diagnosis of schizophrenia; major mood disorders; and antisocial, narcissistic, and borderline personality disorders. Perhaps one of the most important uses of the test is in predicting dangerous behavior during treatment. The Rorschach when appropriately scored and formulated can predict with approximately 75% accuracy which patients will make a lethal suicide attempt within 60 days of the administration of the testing. The Rorschach has also demonstrated that scoring indexes can predict similar levels of accurate prediction of patients who will make a near lethal suicide attempt within 60 days of administration of the test.

Traditional applications of projective testing include their use in clinical settings to predict who will most likely benefit from certain forms of psychological treatment. Anecdotal evidence is far more abundant than scientifically sound studies that support the empirical validation of projective testing in predicting treatment outcome. This is in part due to the fact that most researchers in the field conduct exploratory studies rather than replicating others work. As a result research is not cumulative, making it difficult to summarize the general effectiveness of specific measures in predicting specific outcomes. One stunning exception is the myriad studies of Bruno Klopfer's Rorschach Prognostic

Rating scale (RPRS). In a sophisticated statistical and conceptual analysis, Meyer and Handler analyzed the results of 20 separate studies assessing the validity of the RPRS in predicting treatment outcome. This meta-analysis (involving 752 participants) revealed that the RPRS was highly predictive of subsequent therapy outcome. To examine its predictive power the authors compared the RPRS to other predictor-criterion pairs from various fields including medicine and education. They found the RPRS was a better predictor of psychotherapy outcome than the SAT and GRE scores are at predicting subsequent grade point average. The RPRS as a predictor of psychotherapy outcome was also superior to electrocardiogram stress tests in predicting subsequent cardiac disease. For an enlightening view of how psychological testing compares to medical diagnostic testing, readers will profit from Meyer and colleagues' latest work appearing in the *American Psychologist*.

Steven Applebaum produced two clinically based studies that directly compared inferences based on projective test data to inferences based on traditional interview data. In a small sample of 13 cases, Applebaum found test-based inferences were more accurate than inferences based on interview data. Psychological test-based inferences were most accurate in assessing ego strength, quality of interpersonal relationships, core conflicts, patterns of defense, and transference paradigms. In a second study, 26 additional cases were added to the original 13 to compare interview-based predictions to test-based ones. When psychiatrists and psychological testers disagreed on the predictions, most often testers made correct predictions about the patient's ego strengths, core conflicts, transference paradigms, defense configurations, and the degree of psychological mindedness. The results suggest that projective test data, in the hands of well-trained diagnosticians can be used for making predictions about treatment planning and outcome that is superior to that of clinicians who have clinical data from interviews.

One facet of assessment that has received relatively little attention is the application of projective tests in assessing changes in intrapsychic functioning as an aspect of psychotherapy outcome research. Given that psychoanalytic treatment endeavors to effect structural change, it is remarkable that few researchers have used sensitive measures such as the Rorschach to monitor change. Nonetheless, there are examples of how the Rorschach has been utilized in this manner. Irving Weiner and John Exner, for example, assessed 88 patients prior to starting exploratory dynamic therapy, then retested them on three occasions including at ter-

mination. A second group of 88 patients undergoing brief nondynamic psychotherapy were also assessed throughout the course of treatment and at termination. The researchers chose 27 Rorschach variables indicative of patient's ability to manage stress, perceive reality in conventional modes, modulate affective experience, adaptively utilize ideation, be self-reflective, and represent interpersonal relationships.

Results indicated that 24 of the 27 variables were significantly improved for patients in the long-term dynamic therapy, demonstrating progressive improvements at each testing through termination. Short-term patients also made significant improvement but to a lesser extent than patients in psychodynamic treatments. In a similar study Exner and a colleague replicated the first study with 70 patients, 35 in long-term treatment and 35 in brief therapy. The researchers added a fourth testing after termination. They found similar results with one major exception—improvements for patients in long-term treatments were more likely to be sustained, whereas short-term patients did not sustain improvements at follow-up.

In one of the most in-depth and extensive studies of intrapsychic change (involving 90 psychiatric inpatients with serious disturbances. Sidney Blatt and Richard Ford examined the nature of intrapsychic and behavioral change across all patients, while simultaneously assessing differential change in two distinct groups. At 1 year into treatment, the researchers found that the patients as a whole had made significant improvement in externally validated real-world behaviors such as social behavior and symptom expression (assessed from hospital case records). In terms of structural change measured by the Rorschach, they found statistically significant decreases in the degree of thought disorder, with the clearest improvements in the most serious forms of thought disorder frequently found among patients with psychotic disorders. Patients also demonstrated a greater capacity to engage adaptive fantasy and demonstrated a significant improvement in the quality of object representations, both in terms of decrease in their expectations of malevolent interactions and their ability to represent objects as separate and more autonomous.

Blatt and Ford then assessed the possibility that psychodynamic treatment might affect patterns of intrapsychic functioning in different ways depending on the patient's character structure. Blatt and his research group at Yale University had earlier distilled two essential developmental trajectories corresponding to two global character styles, the anaclitic and introjective.

The anaclitic character's actions are organized around defending against vulnerabilities to disruptions in need-gratifying interpersonal relationships. Anaclitic patients are highly dependent people who often experience somatic symptoms and seek solace and care from others including physicians and therapists. By contrast, the introjective character is focused primarily on issues of self-definition, autonomous identity, and self-esteem. Introjective characters often eschew dependent longings for fear they will disrupt efforts to secure autonomy and clarity of identity.

When patients were divided along anaclitic and introjective lines, interesting results emerged. For patients primarily concerned with maintaining need-gratifying relationships, changes were noted in moving from experiencing relationships as malevolent, controlling and fused, to more benign and differentiated. This structural change corresponded to the anaclitic patients' improved social competence and motivation for treatment. For patients with introjective character organizations, the greatest change occurred in decreased thought disorder on the Rorschach, with a corresponding improvement in clinician's assessment of symptoms—most notably, introjective patients demonstrated significant decreases in psychotic symptoms with corresponding improvement in affect modulation. Blatt and Ford's findings support decades of clinical case reports demonstrating that structural change occurs in specific arenas of functioning most related to the patient's psychopathology. An equally, if not more important finding is the fact that psychiatric patients with severe disturbances appear to benefit from intensive psychodynamic treatment. Finally, they demonstrate the way in which projective techniques can be sensitive to subtle changes in patients' intrapsychic processes and can be quantified to study treatment outcome for large groups of patients.

IV. SUMMARY

This article reported on the evidence for specific uses of projective tests in developing an accurate portrait of a patient's personality—their frailties and strengths. The diagnostic facet of projective testing can be integrated into treatment recommendations for specific patients to

help the therapist develop a working model of the patient's functioning and to help predict potential transference developments. The scientific status of projective testing was considered in light of recent comparisons between the Rorschach in predicting treatment outcome and the ability of medical diagnostic tests in predicting the development of disorders such as cardiac disease. Finally, the use of projective testing to monitor intrapsychic change illuminates the current and potential uses of projective testing in measuring treatment outcome.

See Also the Following Articles

Behavioral Assessment ■ Manualized Behavior Therapy ■ Neuropsychological Assessment ■ Object Relations Psychotherapy ■ Single Case Methods and Evaluation

Further Reading

- Applebaum, S. A. (1977). *The anatomy of change: A Menninger Foundation report on testing the effects of psychotherapy*. New York: Plenum.
- Blatt, S. J., & Ford, R. (1994). *Therapeutic change: An object relations perspective*. New York: Plenum.
- Lerner, P. (1998). *Psychoanalytic perspectives on the Rorschach*. Hillsdale, NJ: The Analytic Press.
- Mayman, M. (1968). Early memories and character structure. *Journal of Projective Techniques and Personality Assessment*, 32, 303–316.
- Meyer, G. J., Finn, S. E., Eyde, L. D., Kay, G. G., Moreland, K., Dies, R. R., Eisman, E. J., Kubisyn, T. W., & Ried, G. M. (2001). Psychological testing and psychological assessment: A review of evidence and issues. *American Psychologist*, 56(2), 128–165.
- Meyer, G. J., & Handler, L. (1997). The ability of the Rorschach to predict subsequent outcome: A meta-analysis of the Rorschach Prognostic Rating Scale. *Journal of Personality Assessment*, 69, 1–38.
- Rorschach, H. (1921/1942). *Psychodiagnostics*. Bern: Hans Huber.
- Rapaport, D., Gill, M. M., & Schafer, R. (1968). *Diagnostic psychological testing*. New York: International Universities Press.
- Schafer, R. (1954). *Psychoanalytic interpretation in Rorschach testing: Theory and application*. New York: Grune and Stratton.
- Weiner, I. B. (1999). Contemporary perspective on Rorschach assessment. *European Journal of Psychological Assessment*, 15(1), 78–86.



Psychoanalysis and Psychoanalytic Psychotherapy: Technique

Stephen M. Sonnenberg

Uniformed Services University of the Health
Sciences, Baylor College of Medicine

Robert J. Ursano

Uniformed Services University of
the Health Sciences

- I. The Talking Cure
 - II. Analysis as a Drama
 - III. Core Technical Concepts
 - IV. Core Interventions
 - V. Psychoanalytic Perspectives on the Mind
 - VI. How Do Psychoanalysis and Psychoanalytic Psychotherapy Work?
 - VII. The Therapeutic Action of Psychoanalysis and Psychoanalytic Psychotherapy
- Further Reading

GLOSSARY

abstinence The refrain of the therapist/analyst from gratifying the patient's wishes.

adaptational perspective The perspective that addresses the patient's attempts to adjust and compromise with external reality.

clarification A technical intervention on the analyst's part asking the patient to consider the unconscious intentions of the patient's communications.

confrontation The technical intervention on the part of the analyst in which the analyst brings to the patient's awareness some aspects of feelings, thoughts, or context of which the patient has been unaware.

countertransference The experience of transference by analysts and therapists.

free association The technical instruction from the analyst for the patient to say anything that comes to mind, and to suspend the usual effort to think clearly and coherently and to pass judgement on the appropriateness of the idea.

freely hovering attention A mode of functioning and listening on the part of the analyst in which the analyst is sensitive to symbolic metaphorical communications, and listens in a creative, imaginative frame of mind, attempting to discern the underlying unconscious intentions of the patient's communication.

freely hovering role responsiveness The manner in which the analyst participates in the psychoanalysis, allowing himself or herself to experience the transference, as well as countertransference, forces at play in the relationship.

historical perspective The perspective of psychoanalytic thought that emphasizes the influence of past history on present behavior.

interpretation A technical intervention in which the analyst attempts to assist the patient to understand exactly how and why he thinks, feels, and behaves as he does.

neutrality The stance which the analyst/therapist takes in which he or she does not express personal preferences to the patient and does not ally himself or herself with important dimensions of the patient's conflict.

psychodynamic perspective The emphasis in psychoanalytic theory demonstrating conflict and compromise among various psychological structures to create new behaviors, symptoms, and psychological structures, such as wishes and fantasies.

structural perspective A psychoanalytic view that describes the components of the mind, emphasizing the specific functions and tasks of these components.

topographical perspective A psychoanalytic perspective that emphasizes there are two qualities of mental activity, conscious and unconscious.

transference The tendency to unwittingly construct and create, through an active but unconscious process, the pattern

of imagined and real past relationships with an important person.

I. THE TALKING CURE

Psychoanalysis and psychoanalytic psychotherapy are often referred to as the talking cures. That term emphasizes that psychoanalysts help patients by talking with them and that a conversation is central to what heals the patient. However, although the term *talking cure* captures something very special about psychoanalysis, it is misleading. It fails to stress that at the core of what heals is the relationship between the analyst and the patient, and that their conversation is the way the aspects of that relationship are formed and expressed.

A. Basic Assumptions

An examination of the basic assumptions underlying psychoanalysis and psychoanalytic therapy will further clarify what has just been emphasized. In the past various groups of analysts have come together in more or less official schools, groupings that emphasize somewhat different theoretical perspectives. Today, there is an emphasis on harmonizing those groups, and finding the common ground in the basic assumptions they share. In a recent article, Donna Kline and Stephen Sonnenberg suggested that four basic assumptions were useful in describing contemporary psychoanalysis. These are (1) that the analyst is experienced by the patient as having characteristics of important people from the patient's past, (2) that the patient's actions in and outside the analysis repeat patterns from the patient's past, (3) that some mental activity of all people takes place outside of consciousness, and (4) that people have a wish to understand themselves, to know, and that what is known can lead to changes in the way they think, feel, and act.

It is very important that the analyst is experienced as having characteristics of people from the past. The technical term for this is *transference*, and because it occurs in the relationship between the patient and the analyst, that relationship becomes a living experiment in which the influence of the patient's past on the patient's present life can be explored.

Past patterns are repeated in the present that provide another component of the transference, again making possible an exploration of the effect of the past on the present.

The idea that some portion of mental activity takes place outside consciousness is also of vital importance

in psychoanalysis. Certainly, it is that idea which was central when Freud invented psychoanalysis as a method of personal inquiry and healing: Freud reasoned that when an unconscious idea became conscious it could be examined, and if it was unreasonable, placed in a new perspective. For example, consider a person has a powerful unconscious wish to put a business competitor out of business and fails at his own business out of unconscious guilt over that unconscious wish. When the wish becomes conscious the individual in question can thoughtfully decide to abandon the idea/wish, or perhaps to follow through and develop a business plan that is acceptable and does not cause him second thoughts.

The desire to know is an assumption of psychoanalysis that has not always been sufficiently emphasized. If one pauses and gives serious thought to this matter, one must marvel at the human capacity to question and seek answers. Indeed, were it not for that capacity, one might realize there would be no field of psychoanalysis, no discipline that has at its purpose the illumination of the mysteries of what goes on in the human mind.

A corollary of this assumption is that the wish to know allows the patient and the analyst to come together in an alliance, sometimes called a working alliance, sometimes called a therapeutic alliance. It is certainly the case that a journey of deep self-inquiry will have many rough spots, many difficult times, and it is because the patient and the analyst are joined in a mutual commitment to knowing, to learning, that they can form a relationship in which they examine together often emotionally painful aspects of the patient's life. Put another way, it is the mutual wish to know that binds the patient and the analyst together in a relationship in which they both tolerate the frustration and sometimes painful challenge of the analytic journey.

II. ANALYSIS AS A DRAMA

Another useful metaphor in understanding the technique of psychoanalysis and psychoanalytic psychotherapy is that of a dramatic performance. In the treatment relationship the patient is asked to write a play about his life, and to act many of the roles in that play in his relationship with the analyst. For her part, the analyst is asked to give herself over to the playwright patient and psychologically assume various roles assigned by the patient in the course of their analytic relationship. This vivid process is described by

psychoanalysts when they use the technical terms transference and countertransference.

A. The Transference

This term has already been introduced. The reason to discuss this term further in this section is to emphasize that it is the analyst's responsibility to teach the patient that the creation of the transference—the pattern of past relationships with an important figure—derives from the patient. Most often, the patient “creates” the transference out of an active, though unconscious, aspect of repeating a past experience. At times, this has been thought of as part of the wish to correct the past, but this is not a necessary part of the concept of transference. Rather, the pattern of interpersonal relationships laid down by early experience in our biopsychosocial world may give us few options of choice unless we become aware of our patterns of behavior. When the analyst helps the patient understand consciously this old pattern that is awakened (and is creating a drama driven by past experiences rather than present ones), the analyst helps the patient understand his contribution to the present conflict and for the life he lives.

Analysts are trained to both experience and observe the drama the patient constructs in words in the analytic consulting room. The analyst imagines herself in the world the patient creates, places herself in her imagination in the roles the patient describes for those with whom he interacts, and recognizes how in subtle ways similar patterns are created by the patient in the interactions with the analyst or therapist. The products of those reflections by the analyst are the various ideas the analyst conveys to the patient.

To illustrate this point, imagine a patient who feels helpless in all situations with authority figures. The patient will regard the analyst/therapist as an authority figure. The analyst will feel that role assigned to her, and that feeling will help the analyst understand the helplessness the patient feels.

B. The Countertransference

Psychoanalysis is neither an intellectual exercise nor a spectator sport. In the analytic relationship both the analyst and the patient experience the patient's life in an active, vivid way. In that spirit, psychoanalysts have stated that in their professional relationships with their patients they are participant observers, not simply outside observers. Therefore, analysts and therapists also

experience transference—called countertransference—to the patient when the patient reminds the analyst of an important figure from the past. The analyst's awareness and attention to countertransference permits the analyst/therapist to have a fuller appreciation of the drama of the patient's life. The analyst does not act on the countertransference but rather uses her awareness of these feelings as further information to inform the understanding of the patient's world.

C. Abstinence and Neutrality: The Design of the Therapeutic Encounter

The analyst is restrained in interaction with the patient to words designed to help the patient learn about himself. In that spirit, the analyst strives to create an environment in which the patient feels safe to experience a part of the drama of his life and be able to observe it in this subtle form. This requires that the patient not be burdened with worry about the realities of the analyst's life, values, or ideas about living. The analyst maintains neutrality, does not express personal preferences to the patient, and provides limited information about his or her own life. A corollary of this is that the analyst maintains anonymity, thereby protecting the patient from knowledge of the analyst's personal style and values. The term abstinence refers to the fact that the analyst avoids gratifying the patient's wishes, whatever those might be—praise or punishment—direction or to be left alone. The analyst's task is to understand and to convey the patterns of interpersonal relating that emerge and reflect the past experience of the patient. This occurs in part because the analyst does not praise or punish or in general fulfill the unspoken wishes of the patient. When the patient's wishes remain unfulfilled, they are felt as obstacles by the patient and become available for examination. The concept of abstinence shares a common border with the concepts of neutrality and anonymity. As a group, these aspects of the analyst's behavior might usefully be seen as the way the analyst provides the context in which the patient can both experience and examine the interpersonal drama of his life and its past origins.

III. CORE TECHNICAL CONCEPTS

Four technical concepts of psychoanalysis and psychoanalytic psychotherapy are important to therapeutic process: free association, the metaphors in the

patient's words, freely hovering attention as a mode of analytic listening, and freely hovering role responsiveness as a mode of establishing the countertransference during analytic listening.

A. Free Association

Psychoanalysts have observed that when people think and say what comes to mind their thoughts reveal a layering. On the topmost layer is rational thought, the kind of thinking that takes place when one performs an intellectual task or has a conversation about a particular topic. However, buried in that conscious rational verbal exchange and thinking are the hints of a parallel layer of thought that occurs simultaneously, outside conscious awareness. In this form of thinking, different rules apply. For example, many different things may be represented by a single symbol, a process sometimes described as condensation, sometimes described as symbolization. We see this same logic in other areas—such as a rebus in which a clock with wings represents “time flies,” or when one recalls a vacation at the beach in childhood as a way to remember an entire year of one's life that may include many important but not yet recalled events.

Thus, when the psychoanalyst or psychodynamic psychotherapist listens to her patient, she first instructs the patient to say anything that comes to mind, to suspend the usual effort to think clearly and make sense. When the patient is able to do that, and it is not easy, the unconscious layer of thinking is more apparent, symbols are more apparent, and the analyst can hear somewhat more directly what goes on in the patient's mind outside usual awareness. In fact, this process of free association is always relative and only really becomes free as the patient resolves the conflicts that are the source of his or her pain.

B. The Focus on Metaphor

This core technical concept dovetails with free association. The psychoanalyst believes he or she can best help the patient if the analyst can equip the patient to examine his thoughts, recognize the clues to what is unconscious, examine the unconscious layer of mental activity, and determine how such thinking influences current behavior. Therefore, it is essential for the analyst to listen for the symbolic meaning in what the patient says.

For example, let us imagine that just as thoughts of dogs outside of conscious awareness may represent all four-legged animals, all similarly considered children

who want love and praise may represent all adults who feel starved for love and praise. Let us also suppose that the patient in treatment is one such adult. When asked to free associate the patient may return repeatedly, in many forms, to the subject of children who need love and praise. Suppose also that the patient is a pediatrician who gives lectures to parents about the need of children for parental love and praise. Eventually, through noting when and in what context these associations occur, the patient's hints and verbal symbols about children and their need for parental love may be understood as the patient talking about his own need for love and praise when speaking of the children.

The analysis of dreams is a part of psychoanalysis and psychoanalytic psychotherapy. Dreams have been called the royal road to the unconscious, and certainly they often occupy an important place in a clinical psychoanalytic treatment. Dreams are used in the same way as free associations—a source of material to free associate to, as the patient and analyst/therapist listen for the unconscious concerns of the present and the forgotten links to the past. The analyst listens to the patient describe a dream in a search for symbols and for metaphor to educate the patient and facilitate an understanding of the meaning of the thoughts and the way of thinking, and an appreciation of all the mental activity which is outside conscious awareness.

C. Freely Hovering Attention as a Mode of Analytic Listening

As the analyst/therapist listens to the patient's free associations, he or she listens for the patient's unconscious mental activity. In this listening, the analyst is sensitive to the symbolic communications of the patient. This is not a process that is easy, nor ever automatic, no matter how well an analyst/therapist knows the patient. The analyst listens in a creative, imaginative frame of mind, in which layering of meaning and symbols become vivid experiences for the analyst. The analyst has as background the many previous topics that have been discussed by the patient and the context of these and of the present and past life of the patient.

For example, as the patient describes a needy child, the freely hovering analyst may note that a mental image of such a child has come to mind, and that image may change in the analyst's mind's eye into an imaginary mental image of the patient as a young child. The analyst/therapist continues to listen, now no longer freely hovering, but rather reasoning that perhaps the image is related to a subtle communication from the

patient—how the patient phrased something or the empathy in the patient's associations. The analyst then wonders if he or she should ask the patient if he is talking about himself. If the patient responds in the affirmative, a piece of analytic information has been generated, and the patient has shared an experience of making the unconscious conscious.

D. Freely Hovering Role Responsiveness

Much that the analyst learns about the patient comes from being a participant observer in the analytic relationship. Imagine, then, that along with imagining the patient as a needy child, the analyst began to recognize the patient's subtle but demanding requests that the analyst praise him. That request by the patient and experience by the analyst could come in relatively hidden ways. For example, the pediatrician patient, despite having other alternatives, may ask his analyst to change the times of several hours because he must attend several national professional meetings, at which he has been asked to speak about the emotional needs of children. He may say to the analyst that he is available to meet at times he knows are not the usual working hours. For her part, the analyst may sense with great force the patient's request/demand for special treatment, as part of the recognition of what an outstanding pediatrician he is. The analyst practicing abstinence, neutrality, and anonymity, and using a freely hovering role responsiveness that has thus identified an unconscious meaning in this request, will be able to convey to the patient the particular meaning of the patient's associations and actions within the analytic relationship and wonder if the patient is alert to these feelings and wishes. With appropriate analytic inquiry on the part of the analyst, and a willingness to explore his desires on the patient's part, further insight will be gained by the patient of what he originally thought was only a "practical" request.

IV. CORE INTERVENTIONS

A critical part of an understanding of the technique of psychoanalysis and psychoanalytic psychotherapy includes how the therapist speaks to the patient. While the psychoanalyst listens to the wishes and feelings of the patient that are both conscious and out of awareness in order to have a deep understanding of the patient as another human being, the setting of that listening is specifically restrained. In addition, the ways

of speaking to the patient are designed to effect change in specific ways. In sum, the analyst tries to speak in a way that enhances the patient's awareness of his own unconscious processes, and more generally of how his mind works, so that the patient can learn to practice effective introspection on his own. There are three technical ways the analyst speaks to the patient that are designed to enhance the capacity for insight: confrontation, clarification, and interpretation.

A. Confrontation

At times in psychoanalysis, the analyst confronts the patient with information or observations. The term confrontation in this context does not mean a hostile exchange between analyst and patient, but bringing to the patient's awareness some aspect of feelings, thoughts, or context that the patient is not aware of. In keeping with the notion of the therapeutic alliance, the analyst attempts at all times to create a safe atmosphere in which the analysis will take place. This will be described in more detail later. Nevertheless, it is often the case that the analyst points out, in a kind way, that the expectations or ideas of the patient are quite different from what the patient realizes them to be.

For example, returning to our dedicated pediatrician, suppose he asked his analyst to see him on Saturdays, which she normally took off, and when she refused, said he was going to quit his analysis because she obviously did not care about him. In that instance, the analyst would appropriately point out to the patient that he was assuming that she could see him on Saturday and simply chose not to, and that on the basis of that unproven assumption was ready to stop a much needed treatment. This example, by the way, is common; there are many similar instances in which individuals desperately needing psychological help quit treatment without realizing that their actions are being guided by one of the problems for which they are seeking treatment. Thus, the analyst must be prepared to vigorously confront the patient, when necessary.

B. Clarification

There are other times when the analyst must ask the patient to clarify what he has said, or speak to the patient in a way that offers clarification from the analyst's viewpoint. Again, returning to our pediatrician, he might ask his analyst to give up her day off in a way so subtle that he unconsciously hopes she will not recognize that the request comes from him. Unconsciously,

he desires her to feel spontaneously that she should offer to see him on Saturday. Consciously, he may be aware of none of this; not even that he has made an actual request of this kind. Here is a situation in which the patient requires clarification, rather than confrontation. The clarification may involve the analyst asking the patient to consider, in a thoughtful way, what he has said and to wonder if there may have been a subtle request, or a veiled threat if the wished-for offer was not spontaneously forthcoming from the analyst. Alternatively, the clarification may involve the analyst making such an observation to the patient.

C. Interpretation

Often interpretation is seen by analysts as the crown jewel of the methods available to help patients think more effectively about themselves. Interpretation involves telling patients in a convincing way that there is an unconscious process at work in their thinking and, in a complete interpretation, explaining exactly why and how that unconscious process works. In the example we are using, it might involve the analyst telling her patient that he requested sessions on her day off because he wanted to know that she loved and admired him, and that this was a strong desire of his for certain specific reasons that she would elaborate related to specific childhood experiences and needs which she would describe in detail. It is the addition of the developmental explanation of the feelings, wishes, and hopes that makes an interpretation a linking the past with the present in a convincing manner.

Interpretations are designed to help the patient understand exactly how and why he thinks, feels, and behaves as he does, but it is incorrect to think that they are more important than confrontations and clarifications. These three methods of communication are used throughout an analysis, and it is the judicious use of all three modes of communication that is an important skill of the clinical psychoanalyst.

V. PSYCHOANALYTIC PERSPECTIVES ON THE MIND

Psychoanalysis works by enhancing the patient's ability to examine the workings of his mind, especially workings that were previously unconscious. Put another way, psychoanalysis is a method of making the unconscious conscious or what is out of awareness available for the patient to consider and include in decisions and choices. However, there are several per-

spectives that psychoanalysts use in observing their patients, organizing their ideas about their patients, and which they try to convey to their patients in the belief that these perspectives will help them practice effective introspection during psychoanalysis and afterward on their own. These perspectives include the topographic, the structural, the historical, the psychodynamic, and the adaptational. These are, in effect, the smaller units into which the working of the mind can be divided. By understanding these, the patient has additional tools for introspection.

A. The Topographic Perspective

The topographic perspective emphasizes that there are two qualities of mental activity—conscious and unconscious. Much mental activity, increasingly supported by neurosciences of brain function, takes place outside conscious awareness. Forces pushing thoughts out of awareness appear to be always at work.

B. The Structural Perspective

The structural perspective describes the components of the mind, each of which has specific functions and performs certain tasks. Of course, these components do not really exist but rather are a way to group conceptually certain types of thinking and cognitive processes. For example, Freud described three components, or “structures” in the mind—the ego, the id, and the superego. Roughly, the first is where we do most of our thinking, the second where we do our wishing, and the third where our conscience and goals reside. Knowledge about these systems helps the clinician think more clearly about the patient. In addition, when understood in the specifics of one's life, it can help the patient think more clearly about himself.

Returning to our pediatrician, it is obvious that at the time he is asking his analyst to give up her Saturdays, there are desires (that we consider part of the id) that are very powerful, and ways of thinking (ego functions) that may allow him to implement his desire without it coming into full awareness. The knowledge that he has a mind that performs these different functions simultaneously can be helpful to this analytic patient.

C. The Historical Perspective

The historical perspective focuses on the aspects of mental function that show the influence of past history on present behavior and our attempts to resolve our conflicts and choices. This perspective, also, can be

very helpful for the patient as one of the tools of introspection. It is essential that the analyst teach the patient to appreciate the ongoing nature of transference, and that transference takes place not only within the analysis, but in life outside the treatment setting. When the patient understands the ubiquitous nature of transference and the influence of the past and its important interpersonal relations, he has a perspective that will consistently enhance self-analysis.

D. The Psychodynamic Perspective

The psychodynamic perspective involves an appreciation of the conflicts we experience in our mental life and their path to compromise. From the psychoanalytic view, this means the way the different psychic agencies (structures) clash throughout mental life, and as a result, how much mental activity remains outside conscious awareness. For example, the dynamic perspective traces the evolution and alteration of a wish, a desire, or a hope from childhood and adulthood into being kept unconscious, molded by the ego into a compromise, and subjected to the judgment of the conscience. Returning for a moment to our pediatrician—the patient, thinking dynamically, recognizes his wish to be loved and his anger when love is not available. He recognizes his wish to threaten the person who does not bestow the love he wants, his compromise of lecturing on the need for love by others (young children), and that such lecturing brings him a loved feeling. In addition, he has come to realize that this process was previously outside awareness because such ignorance was more comfortable than knowing. With a new awareness of this complex set of feelings, thoughts, motives, and actions related to problems going back to childhood, the pediatrician may feel empowered to give up the wishes of childhood. The pediatrician recognizes that his previous frustration is replaced with a mature awareness that the disappointments of childhood no longer have the powerful impact they had when he was dependent on his parents for everything at the age of five.

E. The Adaptational Perspective

The adaptational perspective emphasizes how our feelings, thoughts, and behaviors are an adaptation, an adjustment and compromise with what was possible. This is important to the patient because it puts in context the patient's psychological strengths, his assets, and the reality of the world of the past and the present. Indeed, whatever compromises have been made throughout a person's development, part of the reason

for them is that they have certain adaptational advantages. To avoid throwing out the baby with the bath water, it is crucial for the patient to have an enduring appreciation of how he came to be, what he was before psychoanalysis, and how he can and should retain the best of himself throughout the process. This includes an appreciation of the strengths of his personality structure, and the useful ways he has learned to use his thoughts and his feelings.

VI. HOW DO PSYCHOANALYSIS AND PSYCHOANALYTIC PSYCHOTHERAPY WORK?

Much has been written about the therapeutic action of these treatments. The goals of treatments include resolution of symptoms but, even more important, an enhanced maturity and ability to introspect and analyze one's mental conflicts on one's own after treatment. An enhanced maturity is indicated by more intimate, responsible, committed relationships. A more effective capacity to engage in self-analysis provides the patient with a tool for the future. Life is not static; human development involves ever new challenges. An effectively psychoanalyzed individual has developed the autonomous capacity to engage in productive self-reflection. What has occurred during a psychoanalysis, as a result of the techniques described, that promotes such personal maturation and self-reflection? These broad goals are reached through the patients obtaining:

1. A working understanding of his history, his psychodynamics, and his adaptational skills.
2. A mind now much more aware of itself than before. His unconscious mental processes are much more accessible to consciousness and, therefore, much more manageable.
3. A set of new and rearranged psychic structures, including an autonomous self-analytic, self-observing function, and a conscience that is both reasonable and appropriate.

VII. THE THERAPEUTIC ACTION OF PSYCHOANALYSIS AND PSYCHOANALYTIC PSYCHOTHERAPY

We have already established that analysis works because it is a relationship in which there is a process of

examination, and that, during that process of examination, the patient changes in many ways. Analysts use the term working through to describe this. The process often takes several years. However, more recently, brief forms of psychodynamic psychotherapy have been introduced that are more focused, often to a single conflict-defense pattern, and rely much more on the patient's ability to carry on significant work after the treatment. For psychoanalysis, many analysts believe that at the start the patient needs to experience the examination as open ended. In this way, the patient is less able to use a special end point as a safe harbor, a place to which he can travel with the belief that once there he will be spared the difficult task of profound introspection. When the open ended treatment is not available, the therapist's and analyst's work must be even more alert to the patient's defensive choice of endings of the treatment or a protective definition of successful outcome.

The relationship with a psychoanalyst and a psychoanalytic therapist is unique in the modern world. Where else in adult life does someone listen to another person with such attention and concern? Such an environment provides the patient with what has been called a corrective emotional experience, an experience of being understood, accepted, held in a safe place, protected by someone with whom the patient can actually share his pain, his worries, his fears. This last activity is known as the analyst's containing function. Good parents of young children perform such a function. It is rarely available outside very close, loving relationships in adult life. Indeed, because most patients who seek analysis have trouble forming such close, loving relationships, the uniqueness to the patient of the analytic situation is evident.

Many analysts believe that the provision of such a safe and understanding environment provides the patient with such a new experience that the memories of the analyst's many functions and interactions can become the organizing psychological force behind the creation of a new psychic structure in the patient. As

such, it can be an important, new idea in the patient's mind about what is possible in a human relationship. This new structure in turn permits the patient to develop a new structure of his self, a part of his mind in which his sense of himself is different than it was before. This new self is capable of the many psychological changes and behaviors described in this article because of psychoanalytic treatment. This self structure exists in a new and stable equilibrium, capable of loving itself and others, and working hard to do a good job in a wide range of life activities. In this new structure there are also new and old memories of others, memories that are now also stable, enduring, and either pleasing or relatively tolerable to the patient.

See Also the Following Articles

Confrontation ■ Free Association ■ Interpretation ■ Psychoanalytic Psychotherapy and Psychoanalysis, Overview ■ Research in Psychotherapy ■ Therapeutic Factors ■ Transference ■ Unconscious, The ■ Working Alliance

Further Reading

- Kline, D. C., Sonnenberg, S. M. (In Press). Skepticism and science: An empirical construal of psychoanalytic experience. *Journal of Clinical Psychoanalysis*.
- Malan, D. H. (1963). *A study of brief psychotherapy*. London: Tavistock Press.
- Racker, H. (1968). *Transference and countertransference*. New York: International University Press.
- Sandler, J., Dare, C., & Holder, A. (1973). *The patient and the analyst: The basis of the psychoanalytic process*. New York: International University Press.
- Ursano, R. J., & Silberman, E. K. (1999). Psychoanalysis, psychoanalytic psychotherapy and supportive psychotherapy. In Hales, R. E., Yudofsky, S. C., & Talbott, J. A. (Eds.), *Textbook of Psychiatry* (pp. 1157–1184). Washington DC: American Psychiatric Press.
- Ursano, R. J., Sonnenberg, S. M., & Lazar, S. G. (Eds.). (1998). *Concise guide to psychodynamic psychotherapy*. Washington, DC: American Psychiatric Press.

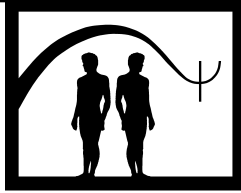

Psychoanalytic Psychotherapy and Psychoanalysis, Overview

Eric R. Marcus

Columbia University College of Physicians and Surgeons and Columbia University
Psychoanalytic Center for Training and Research

- I. Introduction
- II. Goals and Objectives of Psychoanalytic Treatment
- III. Indications and Contraindications
- IV. Method
- V. Technique
- VI. Induction Phase
- VII. Middle Phase
- VIII. Termination Phase
- IX. Case Illustration
- X. Training of Practitioners
- XI. Psychoanalytic Psychotherapy
- XII. Combinations with Other Treatments
- XIII. Research
- XIV. Summary
- Further Reading

GLOSSARY

analyze To make conscious and to describe the structure, relationships, meanings, significance, and origins of mental phenomena, especially emotional representations.

associations Experiences that come to mind, including memories and fantasies, that link emotionally to the topic under discussion. That topic may be a symptom or a pathological character trait.

cognitive A word for conscious thinking.

cognitive-behavioral therapy The use of conscious focus and will to overcome mental symptoms. The focus is on behavior and conscious thinking.

compromise formation A term used to refer to the result of conflicting forces. The compromise result may be a symptom or personality trait. A compromise formation may also

be nonpathological. The difference is whether or not the compromise is adaptive to both the outer world and inner wishes and fears.

conflict The experience of opposed emotional forces causing anxiety and generating symptoms and pathological personality traits.

implicit memory Memory of aspects of experience inherent in, but not obviously part of, the content of events. Usually nonverbal and unconscious.

induction phase of psychoanalysis The first phase of psychoanalysis in which patients are engaging with the treatment process and emotional aspects of their own history start to emerge. The transference relationship to the analyst begins. The focus is on interpretation of resistances to the treatment process and to the transference.

mental representations The content and organization of mental experience. The term refers especially to self and object representations. Psychoanalysis is particularly interested in affect representations.

mental structure The relatively stable and lasting organizations of mental contents and functions.

middle phase of psychoanalytic treatment The phase of treatment when the patient's unconscious dynamic psychology unfolds in consciousness, the transference intensifies and focuses in a transference neurosis, and when interpretation of unconscious conflict and the working through of better compromises is occurring.

neurocognitive rehabilitation A method of teaching education techniques for learning to patients with neurological difficulties in learning.

neurotic A level of intensity of mental illness in which reality testing and emotional control are present.

parameters Noninterpretive techniques in psychoanalysis.

personality Characteristic attitudes and behavioral reaction patterns based on temperament and experience.

personality defenses Personality traits that are used to protect the conscious mind from painful mental experiences.

procedural memory The memory of processes that organize events. A type of implicit memory. Usually unconscious.

procedural rules The rules of organization and use of mental experience.

psychoanalysis A talking treatment method for eliciting and understanding the psychology of unconscious emotional experiences and representations. The method reveals the unconscious structures that organize emotional experience. The word also refers to a theory of human emotional development.

psychoanalytic psychotherapy A talking treatment method of less intensity than psychoanalysis. Usually conducted with the patient sitting up and facing the analyst, the treatment occurs one or two times a week. The goals are less ambitious. The objectives are more limited and focused. The treatment involves many different interventions, not just interpretation of conflict.

psychoanalytic treatment An intensive talking treatment method to understand the emotional conflicts in mental symptoms and personality. The patient lies on a couch with the analyst behind and is seen four or five times per week. The focus of treatment is especially on the emotional relationship with the analyst.

psychopharmacological treatment The use of medications to affect mental illness.

symbolization The representation of mental experience, particularly affect experience, that involve one image or element to refer to and express emotional meaning.

temperament Inborn reaction propensities composed of stimulus sensitivity, latency time, intensity of response, and dominant affect elicited.

termination phase The last phase of psychoanalysis. The transference neurosis resolves. Shifts in personality function and symptom improvement are consolidated. The psychoanalytic process itself is internalized.

transference The transfer of feelings about childhood relationships onto the experience of the relationship with the analyst.

unconscious Mental experiences, particularly emotional experiences, of which a person is not aware.

working through The process of applying insights from psychoanalysis to many different areas and to the working out of new compromise formations.

servations and treatment for emotional illness. Psychoanalysis and psychoanalytic therapy are talking treatments in which a person's psychology is explored in order to help the person master emotional conflicts. These conflicts are manifested in mental symptoms, in troubled relationships with others, in work, in love inhibitions and disruptions, in unhappiness, and in poor self-esteem. Through a detailed description of what troubles a person, and all the associations this brings to mind, the elaborate complexity of how the person's mind functions is brought to consciousness.

Psychoanalysis is based on the concept of unconscious mental representations that are built up from childhood. These mental representations of self and others include intense and conflicted emotions. The conflicted emotions involve wishes, associated fears, and attitudes that organize compromises among them. These representations are influenced both by temperament and experience. The representations are linked by association mainly of affect. They are mediated by and encompass the various groups of mental functions. They can be made conscious in an affect-stimulating relationship and changed if they can then be consciously observed and thereby better synthesized in more adaptive ways. The psychoanalyst achieves this goal by becoming the focus of and then analyzing the patient's projections of mental representations and attitudes.

Mental representations and attitudes include conflicted emotions. Emotional conflicts involve simultaneous wishes and fears. An example is envious hatred of, and longing feelings of love for, the same person, or the same type of relationship. The compromise might be avoiding love and having unhappy, longing feelings. If a compromise of distant love is rigid and fixed, the patient's love life will be lonely, sad, and unrequited. Psychoanalysis, tries to understand the conflict and its defensive avoidance so thoroughly that the patient can understand and achieve a new and better compromise that involves an intimate relationship.

The idea that we are not aware of all our feelings, of all the conflicts in our feelings, of the ways we defend against them, and the ways we compromise those feelings in our minds and in our everyday lives, or the rules that organize those compromises, was first thoroughly researched and systematized by Sigmund Freud. He discovered the rules of organization of emotional life in the late 19th century when the physical sciences were beginning to discover the rules of organization of physical matter. Freud's initial training was in physical science and neurology and he brought that intellectual

I. INTRODUCTION

Psychoanalysis is a theory and a method for understanding the development and functions of human psychology, especially the emotions. Psychoanalysis is a theory of human emotional development based on ob-

approach to his study of human psychology and the unconscious.

II. GOALS AND OBJECTIVES OF PSYCHOANALYTIC TREATMENT

The goal of psychoanalysis is the relief of mental symptoms and life stalemates through understanding the contributing conflicted emotional forces involved. The objective is a shift in the compromises of those forces so that symptoms ease, psychological development renews, and life growth progresses. The specific objectives will depend on the particular categories of symptoms and behaviors in each case.

III. INDICATIONS AND CONTRAINDICATIONS

The indications for psychoanalysis are quite broad. Although classically limited to neurotic symptoms and personality disorders, the modern practitioner may attempt this method with a much broader spectrum of patients, either alone or in combination with other treatments.

The majority of patients in psychoanalysis have neurotic symptoms and neurotic personality disorders. Psychoanalysis is particularly indicated for personality disorders because the illness affects almost all areas of interpersonal functioning and requires a model relationship to use as an example. The doctor–patient relationship in the psychoanalytic setting becomes that model.

Central to the treatment is the analysis of symptoms and of personality defenses. Symptoms are repetitive mental experiences the patient finds unpleasant. Personality defenses are attitudes the person experiences as part of themselves, justified and valuable, which are used to protect the person, but at a price. Both symptoms and maladaptive personality traits are stable, psychological structures that encode conflicted feelings and responses from years of emotional feelings. These structures are associated with the memories they originated with and are partly in response to. They therefore encode the developmental history of the emotional life. Their structures involve the symbolization of emotional conflicts in symptoms and in attitudes.

Patients with neurotic symptoms and personality problems have their cognitive and emotional control functions intact. They are therefore able to understand and use a psychological treatment to gain conscious in-

sight into the emotional forces at work in their problems. They have the capacity to apply this information to many different related areas. With insight, they can construct new compromises for the warring emotional forces so that the symptoms and personality traits that are the pathological compromises can change.

However, sicker patients are more and more being treated by this method in conjunction with medications, other treatments, and nonpsychoanalytic technique mixed with psychoanalytic technique. These parameters of treatment are aimed at strengthening cognitive and emotional control functions damaged by severe psychiatric illness. The sickest patients alter their view of reality to fit their conflicted emotional states. These patients cannot function well in psychoanalysis, and may even get worse, unless medications and other parameters of treatment are used. Such combinations can be highly successful.

The major contraindications for psychoanalytic treatment are, therefore, patients who have severe cognitive–integrative function disorders, patients who have extreme emotional control disorders, and patients whose reality testing is gone or severely limited. Of particular concern are those with emotional discontrol problems because they respond to intense emotion with disruptive actions or worsening emotional states. This is a problem in psychoanalysis because the technique is specifically geared to increase available affect for neurotic level patients, especially in the relationship with the therapist.

Relative contraindications are those patients who are not psychologically minded, or cannot use metaphor and meaning to generalize and apply to specific symptoms and concrete behavioral actions. Sometimes these functions can be rehabilitated or taught anew, making a psychological treatment possible.

IV. METHOD

The method of psychoanalysis has two components, the setting and the technique. The setting is an intensive psychotherapeutic setting where the patient is seen four or five times per week. The frequency of sessions is to achieve a persistence in focusing on pathological symptoms and actions and an intensity in the relationship to the analyst. This intensity is usually required for the conscious experience and analysis of unconscious emotional conflicts. The treatment lasts for a number of years, so that the deepest intensity and the deepest possible resolution of emotional conflict can be achieved.

The patient lies down on a couch with the analyst seated behind so that ordinary social interaction can recede and the patient's inner world of long-standing self and object relationships and attitudes can emerge. The frightening aggressive and loving fantasies that are organized in symptoms and personality attitudes can then be analyzed, and their earliest manifestations recovered in memory.

The method needs privacy and confidentiality. Because people are talking about their most intimate fears, wishes, and memories, the treatment cannot work unless the privacy of the analytic setting, and utmost confidentiality about any records of the treatment, is maintained. Breaches of this privacy and confidentiality barrier, whether casual or systematic, destroy the possibility of the treatment.

V. TECHNIQUE

The main technique of psychoanalysis is free association, in which the patient says whatever comes to mind about the symptoms and attitudes. Because associations are organized especially by affect-linked relationships, entering a free association pattern will reveal affect-organized self and object relationships. These patterns have a long developmental history beginning in early childhood. The free association method leads back to these early memories.

The free association method slowly discovers not only the content of thoughts, memories, and fantasies, and not only their historical antecedents in memory, but also their organizing procedural rules. Those procedural rules are crucial aspects of personality attitudes and form the basis of the experience of one's self and other people. The organizational rules of these emotional patterns may be stored in a special memory capacity that cognitive science calls procedural memory, a type of implicit memory. Psychoanalysis enters the procedural memory bank through the free association method.

By saying what comes to mind in free association, new historical information and/or new, previously unconscious, emotional attitudes to the life historical information become conscious. Crucial to this emerging story are the unconscious fantasies organizing attitudes and life history. Dreams and conscious fantasies are clues to this more unconscious material. More emotional and less factual dreams and fantasies show the surface of emotional conflicts, their historical associations, their present triggers, and their personality defenses more clearly. This allows for a more complete

understanding of the life history, the emotional history, and their relationship. The influences on the development of the personality slowly become clear. Because of the intimacy of the setting, the intensity of the affect experiences, the pointing to resistances against associations and against the unfolding of affect experiences, the patient reexperiences the full force of affect associations, their memories, and their organizations.

The patient then has an emotional reaction to the listener. In this case, the listener is a psychoanalyst who can describe these reactions to the treatment and to the person of the analyst. These reactions are called transference reactions because they are transferred from formative relationship experiences in the past. When the analyst describes them in detail, the analyst is said to be analyzing the transference.

The transference is a crucial aspect of psychoanalytic technique because it gives the analyst a firsthand view of core emotional reactions in the patient. There is no other way to experience the specificity and the complexity of those emotional reactions because, being unconscious and composed of affect, the patient may not at first have descriptions in conscious language. The transference is the reason that the setting involves the supine position, frequent sessions, interpretation of resistance, and relative abstinence of the analyst. All of these techniques are to foster and catalyze an intense transference reaction that will reveal the deeper layers of personality.

The transference is different than the same old attitudes played out with other people in the patient's life for two reasons. The first reason is that the transference is usually clearer in its content and functions than interactions with people in the patient's present relationships because the associated conflicts become conscious. The second reason is that the conflicts are described in words. Language helps with new syntheses by reorganizing feelings into concepts. Logical sequence, cause and effect, and reality can now enter the new synthesis.

The technique of analyzing the transference allows for the slow emergence and better elaboration of the unconscious, and for understanding and integrating the new material that emerges. It is this emergence from the unconscious and from the past that allows more adaptive compromises in the present. This is what leads to more adaptive real-life relationships and to more emotional satisfaction. The unrealistic wishes, unrealistic fears, and resulting poorly adaptive compromises can now change. The more mature compromises form when patients are better able to see the unrealistic and impossible to satisfy nature of the previous conflicts

and unhappy compromises. New compromises also form because the fears lessen and therefore more of the previously unacceptable wishes can find their expression in new reaction patterns and new attitudes that are both more generous and more realistic. This does involve giving up some of the intensity and unrealistic focus of these wishes but because it also involves giving up uncomfortable, unrealistic fears, new compromises can form that can achieve greater emotional and real-life satisfaction.

Interpretation is another crucial technique. Interpretation is the description by the analyst of what is unconscious, what the conflicts are, what the compromises are, and how they are linked to symptoms and attitudes. Interpretation describes the emotional link between the past and the present. Particularly important is the interpretation of transference, of resistance to transference, and of free association.

VI. INDUCTION PHASE

The treatment can be divided for discussion into three overlapping phases. The first is the induction phase, during which patients are becoming comfortable with the treatment process, and are telling their life history and present illness or unhappy state. Engagement with the treatment process and emotional aspects of their own history start to deepen. The real attributes of the analyst fade from view and patient's fears and wishes about other people begin to be focused on the analyst. In order for this phase to progress and be completed successfully, the analyst must pay attention to, and descriptively analyze, resistances to the analytic process and to treatment. Resistances use personality defenses and therefore are a leading edge of the personality neurosis of the patient. Because this personality neurosis is a primary focus of the psychoanalytic treatment, the resistances elicited by the induction phase form the crucial beginning to the treatment.

VII. MIDDLE PHASE

The middle phase of treatment is when the emotional history starts to progressively unfold. The transference intensifies, consolidates, and focuses intensely on the psychoanalyst. This focusing of the transference on the analyst, and the intense involvement the patient has with that transference, is called the transference neurosis. The transference neurosis provides crucial

data about the subtleties of conflicts and compromises basic to the person. The transference neurosis allows the analyst as well as the patient to experience these attitudes, to thereby better understand their contents and their organizations, and to better reconstruct both their origins and present functions.

When the transference neurosis is established, the analyst and the patient are witness to the patient's full range of unique, emotional, personality reactions in a setting where they can be consciously experienced and their elements, conflicts, and troublesome compromise manifestations understood and analyzed.

A defense is an unconscious mechanism that protects the conscious mind from unconscious, conflicted emotional experience. Symptoms express defenses. Aspects of personality function are defensive. Conflicted emotional experience would be even more disruptive and painful than the defense in symptoms or personality. As defenses are analyzed and unraveled, as their functions become more known and more conscious, the underlying, conflicted emotional experiences they protect against emerge more clearly. Because this process is gradual, because each step of uncovering is preceded by a new and more satisfying organization of compromise, the patient can tolerate the uncovering of the deeper layers. A patient's tolerance is one of the factors requiring a long and intense treatment. The analysis of defense and of underlying conflicts allows for the better resolution of unhappy, symptom-generating, and maladaptive attitudes. The conscious mind, seeing the structure and functions more clearly in the course of analysis, and seeing their first origins in childhood, is better able to bring an adult perspective to bear, shifting mental problems in the direction of reality and emotional adaptation in the direction of new, more adaptive, and more satisfying compromises.

The application of insights about emotional conflict applied over and over again to different situations and manifestations, so that new compromises can be applied in all areas of mental life, is called the process of working through. The middle phase of psychoanalysis involves many intense periods of working through as each aspect of conflict is understood, and the insights gained are applied.

Analysis of the transference neurosis and personality defense, and the working through of conflict form together the major and defining aspects of the work of the middle phase. Both the analysis of the transference neurosis and the working through process require constant analysis of resistance defenses against the work. This analysis of resistance and defense is what opens

up the character defenses in order to work them through to better compromises.

VIII. TERMINATION PHASE

The termination phase is the last phase and is also an intense period of the treatment. New data emerge making the life history and emotional history more complete, more understandable, and more useful. New compromises are applied to a range of life situations. Significant shifts in personality functioning and associated symptoms are consolidated. Conclusions to emotional stories and the transference neurosis are arrived at.

Crucial to this phase is the understanding of the full impact of the transference neurosis. In this phase, the analyst once again, as in the beginning, emerges more into the reality experience of the patient. The analyst is now seen more clearly as a person very separate from the projected attitudes and fantasies of the patient. This results in further conviction about the neurosis for the patient and further consolidation of the new, healthier compromises of personality conflict. During this phase, there is an internalizing of the psychoanalytic process itself, so that patients can continue understanding their mental life on their own. Patients are able to do some free association for themselves and to understand the central themes of their personality, dramatized in their fantasies and dreams. They can therefore figure out their new unhappy feelings and the reality triggers causing them, and plan to meet those reality challenges in ways that will be as satisfying as possible.

IX. CASE ILLUSTRATION

A 40-year-old man is in the perilous phase of fighting with his wife in a second marriage after a painful divorce ended his first. He is intensely unhappy and while he blames his second wife, as he did the first, it is he who is unhappy and it is he who cannot help but notice that the fight is the same one that ended his first marriage. He does not want the second one to end.

In consultation with a psychoanalyst, it is apparent in the first session that the same fight has gotten him into trouble at work and has retarded his career. The fight has something to do with who is in control. In analysis, this issue immediately affects his attitude to the analyst and he struggles over every issue, from time to money to the exact wording of interpretations by the analyst. Associations lead to a relationship with his

mother in which there was a struggle over dominance. The relationship was filled with anger, recrimination, and humiliation. Years are spent untangling what seems to have been his mother, what seems to have been him, what seems to have been each one's reaction to the other, and how all this is played out now. He gradually comes to see that not every difference of opinion is a contemptuous judgment, not every variation is an attempt to humiliate, and not every suggestion is an attempt to control. He also comes to see that he is exactly like the mother he accuses. His personality gradually mellows, he becomes more flexible, and his career and marriage improve dramatically. Of added benefit is the great improvement in his relationship with his children, a benefit he had not expected because he never noticed it was also infected by his core issues. The transference to the analyst is quite stormy for the first few years and he berates and threatens the analyst with quitting treatment. Much careful confrontation, together with great tact and patience were required so that the analytic relationship could be useful to the patient.

X. TRAINING OF PRACTITIONERS

Becoming a psychoanalyst requires many years of training. The usual background for such a person is advanced training in one of the mental health fields and then psychoanalytic training. In the United States, for many years physician psychiatrists dominated the field. In the past 20 years, Ph.D. psychologists have increasingly sought psychoanalytic training. More recently, clinical social workers and others have sought this training. Psychoanalytic training involves 4 to 5 years of classroom work, supervision of patients treated by the student, and a personal psychoanalysis. This intense course of study is necessary to learn the theory, practice the technique, and get enough self-analysis so that personality attitudes of the analyst do not interfere with the work. Another crucial advantage of personal psychoanalysis for the analyst is the ability to use emotional reactions to the patient as information about the patient, rather than only about the analyst. In this way, when one's own personality is well enough known, the analysts themselves can become, and can tolerate becoming, the vehicle of treatment. After many years of training and practice, psychoanalysts may undertake a formal certification process by the American Psychoanalytic Association if they are a graduate of the one of the institutes that comprise that association. On successful

completion, the analyst may call himself or herself a certified psychoanalyst.

XI. PSYCHOANALYTIC PSYCHOTHERAPY

Psychoanalytic psychotherapy is a modified form of psychoanalysis. Its goals are similar in that it tries to achieve relief from mental suffering through a careful understanding of mental functions and contents. Although the goal is the same, the objectives, setting, and technique vary. The objectives are more focused and limited, the setting is once or twice a week with the patient sitting up, and the technique may be very much more active on the part of the therapist.

The indications are generally the same as for psychoanalysis but because the sitting position and active interventions of the therapist often prevent an intense emotional regression, this type of therapy may be better suited to sicker patients whose integrative mental functions cannot yet tolerate a full analysis. In addition, the method may be used when very specific, time-limited objectives are needed by the patient and no personality reconstruction is necessary for those objectives. Some examples of this situation are difficulty in mourning a lost one, panic attacks or social anxiety as isolated symptoms in an otherwise high-functioning person, difficulty adapting to a difficult spouse or boss, or help in understanding a troubled relationship with a child. This kind of therapy is often used in conjunction with medication. Examples are the treatment of depression, panic attacks, or social anxiety situations. The combination is a potent one. The duration of such treatments are weeks to months to a few years. In some situations, generally because of constraints of time or money on the patient's part, such therapy can stretch on for years with the goal of providing a modified psychoanalysis for the treatment of long-standing personality disorders.

The technique generally involves both interpretation of dynamic conflict and support of defenses and of self-esteem. The usual goal is to repair, not reconstruct. However, for those whom the technique is being used as a modified psychoanalysis, interpretation, reconstruction, uncovering, and the intensification of transference and its interpretation are important techniques just as they are in psychoanalysis.

The training of practitioners is difficult for the patient consumer to ascertain because there are few programs specifically teaching dynamic psychotherapy. Psychiatrists may learn dynamic psychotherapy in their residen-

cies. Those who are psychoanalytically trained at psychoanalytic institutes after residency training at least are well grounded in the theory and technique of psychoanalysis, which is then applied to psychodynamic psychotherapy. Psychologists and social workers may get specific training in dynamic psychotherapy during the course of their degree programs. Some get further training in the few psychotherapy training programs that exist or go on for full psychoanalytic training themselves.

XII. COMBINATIONS WITH OTHER TREATMENTS

Psychodynamic psychotherapy and psychoanalysis are sometimes used with other treatments. The combination with medication for the treatment of depression is a very powerful combination because the psychopharmacological treatment treats the physical manifestations and the talking treatment treats the psychological manifestations. This combination is powerful because depression usually involves both components. Each component may catalyze or trigger the other component. A single uncombined treatment may or may not affect the other arm of the illness. Treating them both at the same time achieves a more rapid and more complete relief for more people. Although there is as yet little research proof of this, it is the overwhelming majority opinion among clinicians at this time.

Another combination that is growing in use is couples treatment combined with psychoanalysis or psychodynamic psychotherapy. The marital therapist can observe behavior that might otherwise go unreported in the individual treatments. Similarly, patients can gain insight into aspects of their own conflict that are counterproductive in their relationships. This may help in the more rapid uncovering of psychological conflict and in the more complete working through of its resolutions.

Another combination that is sometimes used is the combination with cognitive-behavioral therapy, which is highly focused on target symptoms such as phobias, panic, social anxiety, and obsessive-compulsive disorder. The combination with psychodynamic psychotherapy and psychoanalysis is especially helpful in two situations. The first is when a rapid resolution of symptoms is mandatory for the comfort of the patient and the progress of the psychodynamic treatment. The other is when the psychodynamic treatment has been going on for a long time without resolution of symptoms because the patient needs hand-on help in the working through and application process.

Another combination growing in importance is concomitant neurocognitive rehabilitation in patients who have severe learning disabilities, especially when those learning disabilities make it hard for them to integrate and apply a psychologically based treatment. Neurocognitive rehabilitation also helps the patient with academic work and with employment problems. Information from the neurocognitive psychologist to the psychoanalyst or psychotherapist can help the therapist understand better what the cognitive problems with the patient are so that the talking treatment can be better targeted, better framed, and more understandable.

XIII. RESEARCH

Research about psychoanalysis has a long history. Outcome studies of efficacy include Wallerstiene's small but intimately detailed study of 42 patients in psychoanalysis, Weber and Bachack's much larger study of outcome at the Columbia University Center for Psychoanalytic Training and Research, the Menninger psychotherapy research project for many years under the directorship of Otto Kernberg, and the largest study to date done by Joan Earle and colleagues at the New York Psychoanalytic Institute. These many studies tend to demonstrate certain conclusions. The first is that the longer and more intense the treatment, the better the result tends to be. The next is that even if patients fail to develop a full psychoanalytic process, and are instead in treatments with major psychotherapy parameters, the outcome in approximately 80% is excellent. What is left to be proved is whether the psychoanalytic process itself, rigidly defined if that is possible, is crucial to the beneficial outcome. My own reading of the data is that psychoanalytic psychotherapy aspects are crucial and the strict psychoanalytic process may or may not be crucial. One would expect this to vary not only because of the difficulty in standardizing psychoanalytic process but also because patients' needs vary according to illness.

Psychodynamic psychotherapy research has been advanced in a major way by Barbara Milrod and Fred Busch, who succeeded in manualizing a psychodynamic method of treating panic disorder and in show-

ing the success of this method. Peter Fonagy and others who are psychoanalytic child researchers have succeeded in showing the excellent outcome of psychoanalytic treatments of children.

In conclusion, research over many years supports the general efficacy of psychoanalysis and psychoanalytic psychotherapy. The current challenges in research are to demonstrate the efficacy of the process, of various applications to different illnesses, of the efficacy of combination treatments, and of the relative efficacy against other treatments.

XIV. SUMMARY

A method is said to be psychoanalytic if it has certain crucial elements of treatment. The elements are the analysis of resistance and defense in the making conscious of unconscious conflicts and their compromises, the use of transference as a vehicle to understanding, some effort to reconstruct past patterns as they influence present functioning, and frequent sessions so that an intensity of treatment is achieved that can reveal these patterns. The goal is the progressive unfolding of personality psychology.

See Also the Following Articles

Cognitive Behavior Therapy ■ History of Psychotherapy ■ Psychoanalysis and Psychoanalytic Psychotherapy: Technique ■ Research in Psychotherapy ■ Therapeutic Factors

Further Reading

- Balint, M., Ornstein, P. H., & Balint, E. (1972). *Focal psychotherapy*. Philadelphia: J.B. Lippincott.
- Brenner, C. (1982). *The mind in conflict*. New York: International Universities Press.
- Freud, S. (1932). New introductory lectures on psychoanalysis, Standard edition, (Vol. 22). London: Hogarth Press.
- Rothstein, A. (1983). *The structural hypothesis and evolutionary prospective*. New York: International Universities Press.
- Shapiro, D. (1989). *Psychotherapy of neurotic character*. New York: Basic Books.

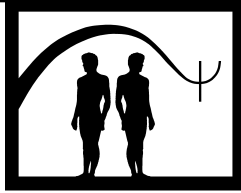

Psychodynamic Couples Therapy

Francine Cournos

Columbia University

- I. Theoretical Model
 - II. Presenting Complaint
 - III. Assessment
 - IV. Treatment Plan
 - V. Empirical Studies
 - VI. Conclusions
- Further Reading

explores how any given couple acts, thinks, and feels, but also the meaning each partner attaches to these experiences. Such exploration is undertaken with the aims of reducing conflict and enhancing intimacy. In this approach, the therapist balances views of what is universally true about intimate relationships with respect for the uniqueness of every partnership between two people.

GLOSSARY

countertransference The way the patient interacts with the therapist which induces feelings in the therapist towards the patient.

intrapsychic defenses Mental strategies developed to contain, and in some instances keep from consciousness, unacceptable wishes and impulses.

object relationships The internalized concepts of self and other that carry with it expectations, sources, type of gratification, and considerations of value.

temperament The biologically-oriented predisposition of a child towards particular ways of behaving, perceiving, and processing information and interactions.

transference The ubiquitous component of all human relations which in psychotherapy refers to how the patients experience the therapist.

Psychodynamic couples treatment involves interventions that incorporate concepts of mental functioning based on psychoanalytic theories. It is an approach that

I. THEORETICAL MODEL

Psychodynamic couples therapists believe that adult behaviors and perceptions in intimate relationships are patterned on the interactions, and the associated feelings and fantasies, of important childhood connections with others, usually most powerfully with parents and siblings. Even under the most favorable circumstances, human development inevitably contains conflict and ambivalence as children struggle with such opposing needs and feelings as closeness and separation, love and hatred, and guilt over forbidden sexual or aggressive wishes. The mental strategies that develop to contain unacceptable wishes and impulses are called intrapsychic defenses, and their many variations and complexities are discussed in psychoanalytic literature. Some defenses are more adaptive than others. Those that allow people to recognize their feelings and take constructive action, for example, work better than those that involve the denial of feelings or self-destructive behaviors. Each

person develops a unique repertoire of compromises between the expression of potentially dangerous (psychologically or otherwise) wishes or impulses and the efforts to contain them with intrapsychic defenses.

Because intrapsychic defenses develop in childhood, they contain irrational conclusions based on childhood reasoning. For example, young children imagine causal associations between unrelated events that occur at the same time. If a 4-year-old girl gets angry at her mother for bringing home a baby brother and then the baby gets seriously ill, the little girl might conclude that her angry feelings and wishes harmed the baby. Because seeing such a bad wish come true is frightening and guilt-provoking, the little girl may then develop intrapsychic defenses to contain her anger, which in turn may cause her to behave in a more inhibited manner. This resolution may persist as the little girl matures without her giving any conscious thought to its origins.

Intrapsychic defenses are well established by adulthood. They operate automatically and mostly unconsciously, but these defenses, and the impulses and wishes they protect against, can in part be indirectly observed through repetitive patterns of behavior and feelings in relationships. Exploration through psychodynamic couples therapy examines these patterns and the associated beliefs and fantasies that the patient uses to explain his or her interpersonal world. So, for example, the woman described earlier might return to the experience of her brother's illness if she seeks to understand in therapy why, when her husband's criticisms make her angry, she silently withdraws (her defense) rather than assert her opposing viewpoints (her aggressive wish).

Psychodynamic exploration also clarifies positive and negative internalized concepts of the self and of others, which are referred to as object relationships. For example, a boy who feels loved and cared for by his mother may have internal images of himself as handsome and appealing, and of his mother as protective and nurturing. By contrast, a little boy who feels his mother takes minimal interest in him and his well-being may have images of himself as unlovable and unworthy, and of his mother as remote and uncaring.

Although this example suggests that these images are created by a simple process, this is not at all the case. Children and parents bring to their interactions unique ways of behaving and experiencing the world, and there is also the matter of the fit between them. A father who is athletic and adventurous may perceive his highly active and mischievous son as great fun, whereas this same little boy could be perceived as a

problem child to a quiet and studious father whose primary mode of expressing himself is through conversation. Children create images of themselves that incorporate how they believe they are seen in eyes of people who are important to them. This is affected by the child's temperament as well. So, for example, an easygoing child may both elicit more positive responses and reach more optimistic conclusions than a child with an irritable temperament. Subjective truths are as important as objective facts, and they help explain how two siblings can emerge from the same family with very different perceptions of childhood.

Children depend on their adult caretakers for nurturance, but because they are relatively helpless, they also fear being harmed by them. Young children cope with this contradiction by keeping the good and bad images of their caretakers separate. An example is their fascination with fairy tales that depict the good and bad images of mothers as fairies and witches. These contradictory images are integrated as the child grows and develops greater autonomy and more mature cognitive and emotional capacities. Integration allows for a more realistic view of others so that a range of negative feelings can be tolerated while still maintaining a predominantly positive image of an important person. Children can best accomplish this integration when they feel safe and loved.

Adults enter relationships using these mental structures constructed in childhood. We bring to our search for intimate partners our deepest hopes and fears and our preconceived ideas about how relationships work. We then think and act in ways that encourage a repetition of these expectations or perhaps seem to be an antidote to them. The attraction of one person to another is in large measure based on finding a fit for childhood constructs. When this fit results in the repetition of patterns that lead to excessive conflict, disappointment, or detachment, it can produce the suffering that is often the presenting complaint of a couple seeking treatment.

One of the central ways the psychodynamic therapist learns about the internal constructs a patient uses to guide relationships is by focusing on transference and countertransference. In individual therapy, transference refers to how the patient experiences the therapist. It is partly a response to the real qualities of the therapist and partly the unprovoked projection of expectations onto the therapist that are based on the internal constructs discussed earlier. For example, a man may anticipate that his therapist is going to be incompetent and judgmental because he perceived his father

in that way. He may then doubt the therapist's opinions or perceive them as criticism. The degree of tact, respect, and reassurance the therapist manifests will to some extent enhance or discourage the patient's tendency to perceive the therapist in this manner.

The way the patient interacts with the therapist induces feelings in the latter known as countertransference, which are partly a response to the real qualities and interpersonal behaviors of the patient and partly a manifestation of the therapist's emotional reactions based on internal constructs from his own past. Psychodynamic therapists are trained to examine their countertransference feelings in such a way that they can use them constructively to help patients. For example, rather than respond to a patient's disdain by being offended or arguing to the contrary, the therapist seeks to understand what he can learn about how the patient approaches relationships. By examining the patient's transference feelings and the therapist's countertransference feelings, the therapist gains critical information about a patient's wishes, intrapsychic defenses, and object relationships. The therapist can then use this information to help the patient reconsider childhood assumptions and develop more adaptive adult strategies.

Most psychodynamically trained therapists learned their skills conducting individual therapy, which is by far the most commonly practiced form of psychodynamic treatment. However, with a shift in perspective, these same psychodynamic principles can be applied to couples interventions.

Transference is not a phenomenon unique to the process of therapy. Rather it is a ubiquitous component of human relationships. Each member of the couple is enacting models of the self and others that only partly correspond to the partner's reality. Thus, in effect, each member of the couple both projects expectations onto the partner (transference) and responds to the partner's projected expectations (countertransference). Negative transference and countertransference feelings can interact with one another in a vicious circle, each setting off the other in a spiral that can cause considerable pain and despair. A man who experienced his mother as inept and now reacts to his wife in the same way can easily elicit the wife's preexisting insecurities about her own abilities. The wife might respond by avoiding tasks in the marriage that could provoke her husband's criticism, which in turn confirms the husband's belief in his wife's ineptitude. Recognizing and exploring these cycles creates possibilities for profound change by allowing the couple to form more realistic and empathic views of one another, by separating the present relation-

ship from past experience, and by creating clearer boundaries between what each person thinks and feels.

Psychodynamic couples therapy moves along much more rapidly than individual psychodynamic treatment. This is primarily because individual therapy brings together two strangers—the patient and the therapist—who develop a relationship over time. When a husband tells his individual therapist about a fight with his wife, the therapist hears only half the story. He does not know how the wife actually behaved, or how she perceived her husband's actions. In fact the individual therapist can best understand the whole story of how the patient relates to others from the experience of how the patient relates to him. Here the therapist is the partner in the relationship, and he knows how he felt and behaved in the interaction. He is learning firsthand about the patient's approach to others by observing and responding to the patient's transference and the therapist's countertransference. This takes time and unfolds with the development of the patient-therapist relationship.

By contrast, in couples therapy the couple brings an already existing intense relationship into the therapeutic process. By directly observing, for example, the hundreds of verbal and nonverbal exchanges that occur in only a few minutes of a couple's typical argument, the therapist begins to see how the wishes, disappointments, inhibitions, and preconceived ideas each member of the couple brings to the relationship play out between them.

The presence of three people in the session also greatly increases the complexity of what the therapist must attend to, including the interactions of the members of the couple with each other and the interaction of each of them with the therapist. This requires the therapist's intense and constant concentration because even a momentary lapse can result in a loss of crucial information. There is also a greater need to control what happens in the room lest the couple simply repeat destructive interactions or pull the therapist into their conflicts without achieving any therapeutic goals. This requires the therapist to make rapid decisions about interventions using less information than that upon which individual therapy interventions are usually based. Some dynamic therapists feel ill at ease with these requirements, whereas others find couples therapy lively and engaging, a remarkable opportunity to have a profound effect on the well-being of others in a relatively brief period of time.

Although Sigmund Freud laid the groundwork for the psychodynamic approach, many subsequent psychoanalytic clinicians and theorists have contributed

substantial modifications to the original theories. Others have made an attempt to integrate these theories with new discoveries about the biology of the brain and the development of the mind. The skilled therapist uses a range of interventions within an overall framework based on psychodynamic principles and tailored to the particular couple's needs. So, for example, the therapist might employ behavioral interventions to improve a couple's skills in the areas of communication and negotiation, or he might refer a member of the couple who weeps throughout the session for an assessment of whether she would benefit from antidepressant medication. There is no single technique that provides an answer to every issue that arises. Skilled couples therapists know when to augment their primary approach with other strategies that are either more effective or more efficient but that do not undermine the framework of the overall treatment.

The psychodynamic therapist is interested both in what is universal and what is unique about people. She understands that just as no two people are the same, so it is that no two couples are the same. It follows that there are no simple formulas, instructions, or remedies for how couples should live their lives. Although the therapist uses her own emotional responses as a tool for understanding a couple's experiences, she has deep respect for the fact that her perspective is also unique to her own past and she avoids imposing her personal solutions on the couple. The psychodynamic therapist respects the couple's autonomy. With the exception of life-endangering situations, the therapist understands that only the couple can reach conclusions about the viability of their relationship, and that they are the ones who must live with the consequences of a decision to stay together or separate. The psychodynamic therapist also believes that all theories are only approximations of the truth, and that the couple's truth is more important than the therapist's theories. She is humbled by the knowledge that beneath every layer of truth is yet another layer. Each member of a couple selects what to reveal, and, however great a couple's willingness to be open, some truths will remain unconscious and therefore unavailable. An awareness of the enormous complexity of people and the irrational forces that influence them contributes to the depth and flexibility of the psychodynamic approach.

Because in most states anyone can hang up a shingle claiming to be a couples therapist, even with no training at all, complaints about the simple-mindedness and lack of success of couples treatment are commonplace, and such experience often leads to a jaundiced view of all couples treatment. Moreover, books and workshops

abound that offer to teach couples how to have a more fulfilling relationship. Although these offerings may present meaningful opportunities for self-improvement, they are to be distinguished from psychodynamic couples therapy, which avoids one-size-fits-all solutions and involves a highly individualized assessment and treatment plan.

II. PRESENTING COMPLAINT

Sometimes a couple will present following an event that crystallizes a long-standing pattern of difficulties. Among the most dramatic of these precipitants are the revelation of an affair or an uncharacteristic act of physical violence. Couples may present because one member has given the other an ultimatum—for example, to marry or break up, to have a baby or divorce. Prenuptial agreements are sometimes experienced as ultimatums as well. Meeting with divorce lawyers prior to marriage may be economically sound, but it is a painful way to begin a marriage. Disappointment in the partner based on the perception of being emotionally and sometimes physically abandoned at a critical time of need, such as during job loss, infertility treatment, or an episode of serious illness may be the presenting complaint. Chronic feelings of anger are prominent in almost all these situations, and a reduction of sexual interest is common.

III. ASSESSMENT

Assessment begins with an evaluation of the presenting complaint. In obtaining this information, the therapist needs to convey the following complex set of concepts: that no two members of a couple see a story in the same way; that the therapist is more interested in subjective truth than objective fact; that the therapist listens for the purpose of understanding and not assigning blame; that the difference between the two stories that emerge will be useful to the therapeutic process; and that each member of the couple has the final say about his or her feelings or intentions. The therapist is in effect making an important intervention by creating an environment in which it is relatively safe to look at areas of disagreement and in the process clarify how each member of the couple may be projecting feelings or motivations onto the partner that create inaccurate perceptions of who the partner is. In the process, members of the couple can learn to separate past perceptions (e.g., "My father never took an interest in what I had to say.") and present reality (e.g., "I pres-

ent my opinions in such an angry way that my partner finds it difficult to listen sympathetically.”).

Elucidation of the presenting complaint leads naturally to inquiring about other areas essential for the therapist's understanding. These include the story of the relationship; the factors that attracted them; the history of their difficulties; their sexual functioning; the birth or adoption of children; the presence of any serious physical or mental illness in either of the partners or a child; and prior experience with individual or couples therapy. The couple's relationship then needs to be put into the context of each partner's family dynamics and, unless the couple is uncomfortable with discussing it, an understanding of previous important couples relationships. Religious and cultural factors also need to be taken into account. For example, the marriage of a Japanese-born businessman to a musician of Irish extraction raised in the Midwest presents enormous complexity with regard to the differences in assumptions, patterns of communication, and expectations each brings to the relationship.

The assessment allows the therapist to begin to answer the following questions: Why is the couple presenting now? What has drawn them together or kept them apart? What is each member of the couple seeking from therapy? To what extent are their goals compatible? How does this relationship repeat patterns each partner learned in childhood? How does the couple function at their best and at their worst? To what extent is their anger and disappointment with one another balanced by a reserve of good feelings? What skills does each partner possess in communicating, negotiating, and empathizing with the other?

Maladaptive patterns of behavior are often passed from one generation to another. For example, a man who becomes verbally abusive or physically violent with his wife will often have experienced similar abuse as a child, and in turn risks raising a new generation of children who engage in such behavior. This man's maladaptive patterns are accompanied by painful internal constructs of a victimized, revenge-seeking self in relationship to undeserving and untrustworthy others. The roles of victim and perpetrator are intertwined.

One essential area of assessment that is often overlooked in couples treatment is the presence of major untreated psychiatric illness, most often depression, manic-depressive illness, anxiety disorders, and addictive disorders (e.g., alcohol, drugs, gambling). Each can place enormous stress on a relationship. For example, the irritability and pessimism of depression, the aggressive behavior seen in mania, the need for constant reassurance induced by anxiety disorders, and the loss of impulse control associated with addiction are each

associated with interpersonal difficulties that can have a severe negative impact on how the couple functions. Personality disorders may also be present, and the therapist needs to assess what aspects can be addressed in the couples treatment and what difficulties are best handled by referral for individual therapy.

Consider a young woman who marries a middle-aged divorced man with two preadolescent sons from a previous marriage. Things go relatively smoothly until she gets pregnant, gives birth to a healthy baby girl, but then develops a severe episode of postpartum depression. She becomes withdrawn and irritable and expresses increasing annoyance with her stepsons. They feel rejected and displaced by the new baby, and become progressively more angry and defiant. This in turn reminds the new mom of her unhappy childhood experiences following her own parents' divorce and the subsequent emotionally distant relationship she developed with her father's new wife. She is frightened at finding herself in the position of becoming the evil stepmother. Although there are many psychodynamic issues for the couples therapist to explore, it is essential to consider the contribution that this woman's untreated depression is making to the deteriorating family situation and her inability to repair it.

The therapist also needs to appreciate what she is not likely to hear about in couples sessions: secrets that one partner wishes to keep from the other (e.g., an extramarital affair); hidden agendas (e.g., a plan to hide financial assets in the event of a divorce); full disclosure of each partner's feelings toward the other; and the type of intimate self-revelation that is the focus of individual psychodynamic treatment. Meeting with each member of the couple alone has the advantage of providing some additional information, and the potential disadvantage of burdening the therapist with secrets that the couple may not be prepared to confront. Whether or not the therapist elects to meet with each partner separately, she remains humbly aware that there are deep unconscious forces at work, that these will remain in place throughout the therapy, and that there is much that the therapist and even the members of the couple cannot understand.

Obtaining information from a couple stirs up strong feelings that need to be addressed, and thus the assessment process is also the beginning of the treatment.

IV. TREATMENT PLAN

Many couples enter therapy reluctantly, believing this admission of failure to solve problems on their own is the first step to separation or divorce. Not uncommonly,

one partner has pressured the other to come to the initial session. A couple in angry conflict may fear that this form of passion is the only force that binds them. Often each partner puts the responsibility for problems on the other, and there is an almost universal desire to effect a change in one's partner rather than in oneself. Other common themes at the beginning of treatment include the wish to be understood without having to put feelings or requests into words, and the belief that one's own inner despair could be quelled by a more responsive partner.

The initial phase of couples treatment is the creation of a safe therapeutic environment in which discussion of painful issues does not cause further harm. This involves setting limits to destructive behaviors such as name-calling, shouting, interrupting, and other forms of angry interaction that serve no useful purpose. In their place, the therapist helps the couple use such strategies as identifying specific issues (e.g., "So you feel rejected when he comes home late every night."); adhering to the topic rather than engaging in global warfare (e.g., "Let's stay focused on the arguments you're having about the kids' bedtime rather than all the past failures to discipline them."); achieving useful goals (e.g., "Do you think that calling him a whining wimp will get you what you want?"); not invoking absent third parties (e.g., "Since your mother isn't here to concur that your wife is neglectful, let's focus on your own opinions."); and distinguishing past grievances from future hopes (e.g., "You're both bitter about the past, but perhaps there's enough good feeling between you to work on handling things differently from here on.").

The presence of physical violence is in a category of its own because it is unsafe to conduct couples treatment in this situation without setting very clear limits to what is acceptable behavior. The therapist's failure to do so can result in an escalation of violence. Consider the case of a lawyer who enters therapy after neighbors called the police in response to his wife's cries for help during a physical altercation. The husband accedes to his wife's demand to see a couples therapist because he is fearful that further police action could result in his being disbarred, but he believes his actions were amply justified by his wife's provocations. Both members of the couple act as if the husband has two different personalities: the good and caring one, and the out-of-control one. The therapist must indicate his belief that there is no provocation that justifies violence, that the threat of disbarment reflects a societal judgment that physically abusing a spouse is unacceptable under any circumstance, and that the husband has a single personality

whose good and caring side must take responsibility for his angry and destructive side. It is essential as well to work with the wife on removing herself and her children from the situation (e.g., keeping clothes in the car, having a place to go to) when she observes the warning signs of impending violence. Exploring the feelings and barriers that might prevent her from taking such protective measures must be part of this process.

All sophisticated couples therapists use strategies for creating a safe environment regardless of theoretical orientation. When the psychodynamic couples therapist employs them, she maintains awareness of the powerful but unidentified intrapsychic forces each member of the couple brings to the joint creation of their repetitive pattern of painful and seemingly self-defeating behaviors. She knows that in childhood when each member of the couple developed the strategies they now use, these approaches were a way of coping with distressing feelings and creating some sense of safety. She has respect for the role of these strategies in maintaining each partner's emotional well-being, and is careful not to make matters worse.

The therapist's approach is then guided by her understanding of how much is at stake in making any changes. This is true whether she makes behavioral suggestions (e.g., "Let's work on how you'll carve out a time of the day to talk to one another without interruptions."); or addresses the underlying psychological problems (e.g., "I guess when your father died and left you alone to deal with your alcoholic mother, it felt like you should just learn to manage on your own and not have to depend on anyone.").

The goals of couples therapy depend on the motivation, capacities, and focus of the couple. They include such diverse possibilities as reducing conflict; improving communication; enhancing empathy and support; promoting trust; creating more effective teamwork; enhancing the depth of relatedness in such areas as self-revelation and sexual intimacy; using humor and pleasurable activities more effectively; improving relationships with extended family; and initiating appropriate treatment for coexisting psychiatric disorders. Because fewer conventional structures are in place and because discrimination exists, gay and lesbian couples, and sometimes interracial couples, may need to make a more conscious effort to integrate themselves into one another's families and work lives.

Although it raises cost and reimbursement issues, longer couples sessions are often more effective than shorter ones because they allow for greater closure of the topic under discussion. This reduces the likelihood

that the couple will leave the office with feelings that they cannot successfully manage between sessions. The amount of time a couple needs to work on a particular goal can vary enormously from a few sessions to a lengthy treatment. Also, couples may be ready to focus on different issues at different times, and it is best to be open to the possibility of couples returning following an initial course of therapy. Decisions about how much collaboration to have with individual therapists, if present, and distinguishing between goals best met in couples therapy rather than individual therapy, are also important components of the treatment plan.

V. EMPIRICAL STUDIES

There is a substantial number of studies examining the outcome of a variety of models of marital therapy. However, most do not meet the current research standards for demonstrating the effectiveness of a treatment (e.g., random assignment, a control group comparison, use of questionnaires that have been shown to be reliable and valid, detailed protocols for administering and observing the intervention), and few of the studies test the outcomes of psychodynamic couples therapy. On the positive side, the direction of the findings taken as a whole suggests that marital therapy is effective and is more likely than individual therapy to solve marital problems.

VI. CONCLUSIONS

Psychodynamic couples therapy uses in-depth models of psychological functioning both within and

between people to enhance intimacy and reduce conflict and suffering. This treatment works best when it takes advantage of the entire array of interventions known to improve couples functioning. This includes the diagnosis and treatment of psychiatric disorders present in either member of the couple and the use of cognitive and behavioral strategies as necessary to improve communication and interpersonal skills. The skilled psychodynamic couples therapist does not offer simple formulas, but rather assists each couple in finding solutions that are responsive to their unique needs and hopes.

See Also the Following Articles

Behavioral Marital Therapy ■ Couples Therapy: Insight Oriented ■ Family Therapy ■ Psychodynamic Group Psychotherapy ■ Spouse-Aided Therapy ■ Supportive-Expressive Dynamic Psychotherapy

Further Reading

- Gabbard, G. O. (2000). *Psychodynamic psychiatry* (3rd ed.). Washington, DC: American Psychiatric Press.
- Glick, I. D., Clarken, J. F., & Kessler, D. R. (Eds.). (1987). *Marital and family therapy* (3rd ed.). New York: Grune & Stratton.
- Jacobson, N. S., & Gurman, A. S. (Eds.). (1986). *Handbook of marital therapy*. New York: Guilford Press.
- Schaddock, D. (2000). *Contexts and connections*. New York: Basic Books.
- Scharff, D. E., & Scharff, J. S. (1987). *Object relations family therapy*. Northvale, NJ: Jason Aronson.
- Siegel, J. (1992). *Repairing intimacy*. Northvale, NJ: Jason Aronson.

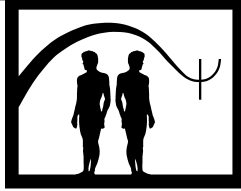

Psychodynamic Group Psychotherapy

Walter N. Stone

University of Cincinnati College of Medicine

- I. Description of Treatment
 - II. Theoretical Bases
 - III. Empirical Studies
 - IV. Summary
- Further Reading

GLOSSARY

countertransference Broadly defined, the emotional and behavioral response of the therapist stimulated by the therapeutic encounter.

group cohesion (cohesiveness) A property of the group in which the members are committed to the aims and work of the group, and from the satisfaction of being a member. Moreover, the properties of the group influence the members, creating a reciprocal experience in which individuals influence the group and the group influences the individual. The influences may be “positive” or “negative.” This is akin to “the therapeutic alliance” in dyadic therapy.

identification An unconscious process in which the participant (patient) takes on parts or aspects of another. By taking on aspects of another, the individual changes by altering perceptions, behaviors, or affects.

norms Unwritten “rules,” either conscious or unconscious, which evolve during the therapeutic process that regulate members’ “behaviors.” The behaviors may be either what is expected or what is sanctioned.

partial hospital A treatment setting that patients attend for portions of a day, evening, or night. Partial hospitals represent an alternative to full hospitalization.

personality disorder A constellation of inflexible and maladaptive personality traits that result in significant functional impairment or subjective distress.

posttraumatic stress disorder (PTSD) A set of symptoms that develop after a person sees, is involved in, or hears of an “extreme traumatic stressor.” The symptoms must last more than 1 month. People reexperience the event in dreams or daily events. They attempt to avoid any stimulus that will reawaken the event. They may respond with numbness or hyperarousal.

psychosis The term is not precise, but is taken to mean grossly impaired in reality testing. It may be considered synonymous with major impairment of social and personal functioning.

repetition compulsion A person’s tendency to repeat intrapsychic conflicts that have resulted from past traumatic experiences.

resistance Patients’ difficulties in effectively collaborating in their therapy (They are late, forget to pay bills, miss sessions, unable to verbally participate). The source of these phenomena are thought to be unconscious.

transference A set of expectations, beliefs, or emotional responses displaced from prior experiences (often parents) to individuals in the present (often a therapist).

I. DESCRIPTION OF TREATMENT

Psychodynamic group psychotherapy is a treatment modality in which a specified number of individuals, who have been appropriately interviewed and prepared for the treatment, gather together at a regular day and time for treatment of their psychological problems. The groups may be of predetermined or indeterminate duration. They may have a fixed membership or be open to additional individuals, as space permits. Members,

through examination of their in-group behaviors, learn about unconscious processes arising from prior experiences that distort present relationships with peers, authority, or with their relationship to the whole group (transferences). They become familiar with resistances and defenses against the emergence of unconscious processes, through manifestations in their relationships, slips (of the tongue), dreams, and fantasies as they emerge in the group process. Examination of the in-group process and dynamics are a primary, but not exclusive, focus of attention in members gaining insight into both conscious and unconscious aspects of themselves as they strive to understand and change their psychological problems.

A. Planning a Psychodynamic Psychotherapy Group

An essential element in the conduct of psychodynamic group psychotherapy is careful planning. Clinicians must determine the potential for finding sufficient individuals (6 to 10) who would benefit from and are willing to enter group treatment. They need to carefully plan for the space and time commitment involved in conducting this therapeutic modality, and they need to properly prepare members for participating in the group. A private practice setting differs from one in a clinic in which administrative and systems issues require particular attention.

The group format should be specified. One option is an ongoing, open-ended group, in which, as individuals leave, they are replaced. Another option is a time-limited group, which is usually defined as a predetermined number of sessions. Generally, time-limited groups are closed for new admissions once they begin.

In composing treatment groups, consideration of ethnicity, age, gender, education, diagnosis, or degree of patients' psychological (functional) impairment should be taken into account. Groups may be heterogeneous as to these elements, but too great a disparity across these various dimensions would likely interfere with effective group treatment. Although each individual is unique, a degree of commonality along one or more of these dimensions is important in order to provide for linkages and identification(s) among members.

Time-limited groups are often composed for a specific commonality (eating disorders, bereavement, reactions to a medical illness, victims of a disaster, including post-traumatic stress disorder) with the expectation that the commonality will enable the members to more readily identify with one another and facilitate sharing.

B. Therapeutic Factors

The therapeutic elements in group treatment arise from interactions among the members and with the leader. In addition, the image individuals develop of the group contributes to treatment outcome. The working theory posits that individuals will repeat their dysfunctional ways of experiencing and interacting (repetition compulsion) in the group setting, thereby providing a window into the person's conscious and unconscious emotional and cognitive processes. Individuals will experience the leader or other members as they have important individuals in their past (transference).

Insight into a person's unconscious emotional life as exemplified through their transferences has been the traditional cornerstone of the therapeutic action of dynamic group treatment. However, insight alone has never been sufficient explanation for a positive treatment effect. The value of the therapeutic relationship has always been appreciated as important, but only recently has it been differentiated from "nonspecific" or supportive categories. Cognitive elements, such as sharing of information or learning about an illness, have also been seen as useful.

Irvin Yalom, in 1975, working primarily in a framework of interpersonal relationships, listed 12 "therapeutic factors" that he believed were central to the mutative action of group psychotherapy. A cornerstone of this perspective was the potential for mutative impact from others' feedback as problematic transactions emerged in the course of the interaction. Yalom also emphasized group cohesion as a necessary, but insufficient, group element in effecting change. Group cohesion broadly defined as the commitment of the members to the aims and the work of the group, is a property of the entire group. Interpersonal influence (feedback) was most effective when a group was cohesive.

In 1997, Roy MacKenzie regrouped and modified Yalom's factors into four categories. The factors included in Yalom's formulation are indicated in bold:

1. *Supportive*: a sense of belonging to the group, which includes acceptance, **altruism**, **hope**, and **universality** (we are all human). **Group cohesion** is subsumed in this category.
2. *Self-revelation*: self-disclosure and **catharsis**. This included cognitive and affective dimensions.
3. *Learning*: **education**, guidance, **modeling**, and **vicarious learning** (observing how others interact and seeing similar aspects in one's self).
4. *Psychological work*: **interpersonal learning** and insight.

Psychological work is conceptualized as individuals' examine and learn about wishes, fears, hopes, and motivations that emerge in the manner they interact with others. Such work optimally takes place when the person feels supported, understood, and has revealed significant emotional aspects of her- or himself.

C. Recruiting and Preparing Members

Prior to recruiting members, clinicians need to attend to the composition and to an appropriate framework for the group. To form a group with the potential for achieving cohesion and a working atmosphere, the membership should not be too diverse along the dimensions of age, culture, socioeconomic background, or psychological awareness. Members should have a similar degree of psychological awareness as expressed in recognition of their inner emotional motivations or in their contributions to dysfunctional relationships. An individual might be excluded from a particular group, for example, on the basis of profession (a university professor with blue-collar workers), or age (a 65-year-old person with individuals in their twenties). Some exclusionary criteria based on traditional stereotypes are not valid if other aspects of the individual are basis for commonality (persons of color, if they have a similar occupation or common interests with others). However, using the theory of group process and dynamics described in the succeeding sections, modified psychodynamic groups can be formed with persons with persistent mentally illness or those with personality disorders who have significant deficits or absence of self-reflective capacities.

Fees for the sessions should be predetermined. Availability of appropriate space where members can sit in a circle with an unobstructed view of one another is necessary. In private practice settings adequate space may only be available in a waiting room, and under such circumstances, the clinician needs to assure privacy. Generally, groups are held in the evening after working hours. In the planning, clinicians must be aware of the extra time that is involved for administrative tasks (i.e., record keeping, patient contacts, or completing insurance forms). In clinics, arranging for a group requires collaboration with various levels of the administrative structure to assure collaboration with the clinician's needs in conducting a group in contrast to conducting dyadic treatment.

Any individual suitable for dynamically oriented psychotherapy is a prospective candidate for group

treatment. However, most persons seeking psychotherapy request individual treatment. Thus, clinicians find it necessary to recruit and conduct careful preparatory interviews to determine an individual's motivation and psychological capacities to participate in group therapy. Clinicians also provide information regarding the treatment format.

Members may be recruited from the therapist's own practice. This has an advantage of both parties knowing each other and having worked together. Often therapists have insufficient prospects to begin or maintain an adequate group census. Other practitioners, or the clinician's usual referral sources, should be informed of the planning for a group to obtain additional candidates. In clinic settings, collaboration with persons in charge of admissions (intake), conferences reviewing patients' treatment, or in managing transfer from one clinician to another (often in the context of a therapist departing the clinic) provide additional referrals. Educational presentations serve to inform others of this treatment modality, as do flyers announcing the formation of a group. This latter method, however, seldom produces many referrals, but functions to remind others of the presence of a group that is seeking members.

Criteria for selecting individuals who would benefit from group treatment are linked to the therapist's goals for the group. Three basic criteria are: (1) an individual's motivation to work on his or her problems, (2) an ability to trust and share inner feelings, and (3) a capacity to examine one's inner states of mind and bodily responses.

General exclusionary criteria include persons (1) who show great reluctance or do not wish to join, (2) have mental retardation, (3) in a relational crises (i.e., divorce, death, loss of job), (4) in acute emotional reaction (i.e., a major depression or a psychosis), or (5) certain persons with certain personality characteristics (i.e., antisocial tendencies, limited frustration tolerance, or inability to maintain confidentiality). An additional consideration is individuals' life circumstances that prevent them from regular attendance (i.e., businesspersons, entertainers, or professional athletes who travel). None of these criteria are absolutes. Persons in crises may become good candidates when they recover. Insufficient data exist to define who should be excluded, because the attributes of the therapist and the characteristics of the specific group membership may be such that a particular individual may benefit from a particular group.

Candidates should be individually interviewed to determine their suitability for group treatment. The tasks of preparatory interviews as outlined by J. Scott Rutan and Walter Stone, include:

1. Obtaining a history and gaining a preliminary understanding of the person's problem(s).
2. Forming a relationship with the patient.
3. Setting treatment goals.
4. Providing information about the group.
5. Exploring initial anxieties about joining the group.
6. Gaining acceptance of the group agreement.

Interviews are not solely focused on determining a clinical diagnosis. They are conducted to learn, also, about an individual's prior role functioning in groups. Participation in the family, school, work, church, and recreational activities are almost universal group experiences. Therapists should inquire if individuals assumed leader or follower roles? Do they keep to task or have conflict with authority? Are they active or passive? Do they speak up or are they listeners? Can they keep secrets? The history and examination of role behavior alerts clinicians and patients to aspects of future group behaviors. Such an interview focus helps patients more clearly specify treatment goals. Furthermore, clinicians' interest in trying to understand the nature of their patients' problems in the various settings increases the likelihood of individuals negotiating the initial anxiety of entering and successfully remaining in the group.

Patients' treatment goals should be as specific as possible. These are usually formulated in interpersonal terms such as, "I need to understand why I become so angry at x," or "I seem to always get into relationships in which I am taken advantage of"; or "I cannot maintain a loving relationship with a man (woman)."

Information should be provided about the group. Usually this includes where the group meets, the time and duration of the sessions, gender composition, and if it will be an open or closed group. For ongoing groups, goals may be stated, "The group will provide members an opportunity to examine relationships both inside and outside the meetings." An additional explanation might include that a person's relational problem will emerge in the interactions among members and with the leader, and in this respect the group will be a microcosm of one's extra-group world. Learning about oneself in the group can be used in one's daily life.

Prospective members are informed that the group will be composed of persons who have no known prior relationships with each other. This leads into exploration of patients' initial anxieties about entering a group and further discussion of their ways of managing those feelings. Preparation serves to help patients work with their feelings and also provides an additional indi-

cation of the therapist's interest in the patient, further strengthening their alliance.

The group agreement (contract) is a central element in the preparation process and serves as a structure for the treatment. The elements include agreement to

1. Be present each week on time and remain throughout the entire meeting.
2. Work actively on the problems that brought you to the group, remain in the group until those problems are resolved, and provide sufficient time to say goodbye.
3. Put feelings into words, not actions.
4. Use the relationships in the group therapeutically, not socially.
5. Be responsible for your fee.
6. Protect the names and identities of your fellow members (confidentiality).

Each element can never be entirely fulfilled. Yet the agreement provides a structure and an indication of what behaviors are useful in the pursuit of treatment. The agreement alludes to patient safety, both physical and emotional. Proscribed actions include physical behavior and verbal attacks that are also considered actions. The ambiguous instruction to use groups therapeutically, not socially, leads to a discussion of extra-group contacts among members. They are asked to discuss in the group all salient contacts between them that take place outside of the meeting, as a means of learning more about themselves.

Fee arrangements should be explicit. The author distributes statements in the group at the initial meeting of each month for payment by the end of the month. If problems arise about payments, they should be discussed openly in the group. (This proves to be a very difficult assignment because money is not readily discussed in the American culture.) Groups cannot function without confidentiality, and it must be emphasized to the members. Members are not prohibited from speaking with others about the meeting, but they are instructed to do so in a fashion that no one can be identified. Members are reminded that confidentiality cannot be guaranteed, and each person is responsible to protect the information that is shared.

Failures to abide by the agreement provide opportunities to examine the reason and meaning of the particular behavior. It is easy to ignore members' slight tardiness or their delinquency in paying fees. Therapists need to overcome their own resistance to addressing such "violations" and help members to do the same.

The group agreement is incomplete without also informing members of the therapist's obligations. Therapists need to tell members about how they will use information gathered outside of the sessions, and how they will participate in the meetings. The former includes information from diagnostic or regularly scheduled (individual, family) therapeutic sessions, phone calls, chance meetings, or contact with other therapists. Moreover, patients should be told what information will be provided to insurance companies or of its use by the therapist in her or his professional capacity (i.e. writings or lectures). Finally, the therapist explains that he or she will try to help members understand themselves in their interactions in the group and in their lives. The members set the agenda. The therapist will intervene when a comment might be helpful.

D. The Therapist's Role

The clinician has the major initial responsibility for creating a group atmosphere that can be therapeutically useful to the members. The clinician must maintain a balance between understanding individuals, subgroups, and the whole group and be able to utilize that understanding for members' benefit.

Leaders need to initially establish boundaries between the group and the outside world, among members, and between themselves and the members. The concept of boundaries includes the time, place, and duration of the meetings (when do the session begin and end; where and when do we meet). The agreement is the first step in this process, because it defines aspects of the relationships among the members, and members with the therapist and with the group. For example, an external boundary is represented by selecting or excluding participants or by the emphasis on confidentiality. An internal boundary is exemplified by the element in the agreement to put feelings into words and not into action.

Clinicians help members begin to relate to one another in the here and now of the group. Yvonne Agazarian, in 1997, emphasized this process by pointing out similarities among pairs or subgroups. Such linking reduces members' sense of alienation. The therapist may identify a common group theme, which generally includes an assumption that silent members are participating, although they are not speaking. Moreover, not everyone has to be in agreement, because some members may favor a certain notion and others may "fight it," but all are reacting to it.

Therapists also have a responsibility in monitoring and, if necessary, helping members' contain or express

their emotions, whichever is salient. Expression of intense emotions is inevitable. When feelings threaten to disrupt, rather than advance, therapy, the clinician must step in to prevent injury to an individual or to the group. Judgment is necessary in this task, and no rules are possible other than the general principle that safety is paramount.

The therapist also monitors and, when appropriate, comments on the unfolding group process, with the goal of alerting members to particular behaviors or interactions (confrontations) or of understanding unconscious elements in the transactions (insight). Many narratives seem only to describe events outside the meeting. However, they may be (displaced) communications or metaphors for unexpressed relationships or emotions within the group. Explaining these two levels (internal or external to the group) may lead to patients' insight into aspects of themselves.

Traditional theory elevates "insight" to a privileged place in helping patients. Insight may refer to understanding in the here and now of the meeting, to relationships in one's daily life or in the past. Interpretations provide insight into the transferences with linkages between "behavior" or feelings in the group, examples from the patient's current life, and from the patient's past. Interpretations illustrate the repetitious quality of patients' responses and their propensity to transport the past into the present. In the group, multiple opportunities for transferences are available with others representing parents, siblings, teachers, or other emotionally significant persons in the patient's life. The treatment setting opens transferences to examination and to understanding (insight). With insight the person can change.

Advances in theory have focused on the function of the relationships and interactions as significant in helping patients change their experience of others—this is often labeled a "corrective emotional experience," which means that people in the present respond differently than those in the past who have injured or traumatized a particular individual. A significant element in the therapist's task is to monitor the group atmosphere and try to form a setting in which such experiences can take place. The "relational experience" in itself is understood as mutative. Therapists, through their predictability, dependability, and reliability, contribute to the mutative impact of the treatment.

The focus of the therapist's activities is conceptualized by J. Scott Rutan and Walter Stone as encompassing two dimensions: role and focus:

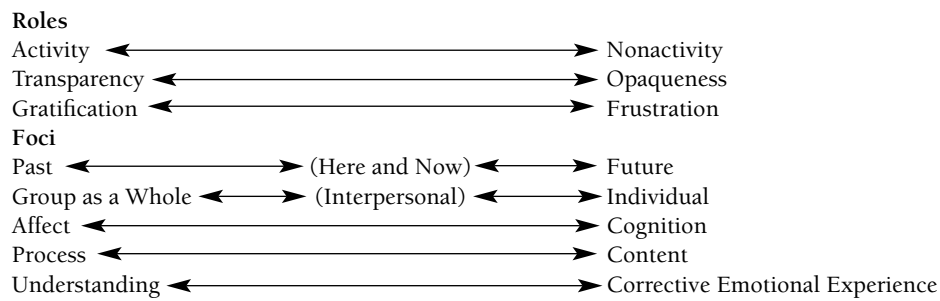

FIGURE 1 Roles and foci for the group therapist. Reproduced with permission from Rutan and Stone (2001). *Psychodynamic Group Psychotherapy*, 3rd ed. New York: Guilford Press.

1. Role

Role function addresses the leader's manner of engaging in the treatment. Each of the three dimensions is on a continuum. Clinicians may show considerable variation where they would be classified along theoretical or clinical places on a continuum. For instance, some clinicians might be active and gratifying during the initial meetings as a way of containing anxiety and creating a warm and accepting group atmosphere. Other clinicians might choose to remain inactive and opaque. They would view their position of nongratification of the "typical" leader role as creating anxiety that would help the members expose prior maladaptive relational patterns (transferences). It is unlikely that any therapist who rigidly adheres to one or another position on these continua would be therapeutically effective.

2. Focus

Leadership foci describe clinicians' stance regarding which aspects of the leadership will command their attention. No single dimension is the sole focus, nor is a single point along the continuum. For example, initially, individuals may not feel safe examining in-group feelings, and they resort to discussing events outside the meeting. The therapist may sense that such discussions promotes cohesion and identifications among members. At a later time, the therapists, hearing a similar discussion, may suggest that the discussion is a metaphor for transactions in the here and now of the group. Nevertheless, no matter which focus leaders choose, unanticipated responses are inevitable because many levels of individual and group experiences are simultaneously touched on. A comment to an individual about his or her behavior in the current transactions may reverberate to members' current life, their past, or imagined future.

E. The Group Process

Viewed from a perspective of a living organism, groups, somewhat akin to individuals, traverse developmental stages. These stages are not fixed or invariant but are subject to the capacities of the membership and the ability of the leader.

Like embarking on any enterprise, individuals enter a group needing to determine the nature of the task and of the emotional relations with peers and the therapist. The task in a psychodynamic group is to learn about and alter dysfunctional relationships and one's inner emotional responses. The therapist usually minimizes ordinary instructions in how to achieve these goals and leads by following—that is the clinician does not introduce topics or provide agendas but follows the members' lead and attempts to understand and convey understandings in a usable manner. This strategy of removing the "ordinary" expectable instructions creates a setting in which transferences, resistances, and unconscious processes are more available for examination.

The basic outline of group development was proposed by Warren Bennis and Herbert Shepard in 1956. An assumption of group developmental schema is that many of these processes are not conscious, yet they significantly affect an individual's emotions and behaviors. Knowledge of these processes serves to inform clinicians of influential elements that are outside of ordinary awareness.

1. The Formative Phase

On entering a group, members have two tasks—to determine how the group can be used to achieve their personal goals and to determine what is emotionally safe. With the leader providing only a bare outline of how to proceed, members naturally employ their usual

strategies to obtain answers on how to proceed. Under the pressure evoked by meeting and having to reveal shameful or guilty aspects of themselves to unknown others, patients utilize previously learned strategies to manage the stressful situation. In the main, such strategies are unconsciously determined, having been arrived at during childhood, but are no longer adaptive. This process is termed *regression*. In this anxiety-laden context, members may cautiously reveal aspects of themselves while simultaneously assessing their emotional safety. Moreover, they invariably have an eye on the leader to determine if their behavior meets with approval, a reaction that suggests “childlike” dependency.

Members, through their interactions, unconsciously develop “rules” (norms) that will protect themselves from being emotionally injured. Norms serve as powerful restraints on the members, but simultaneously they function to protect members from overstimulation and intense discomfort. As these unconscious norms become established they partially replace the therapist, because they serve as rules. Under these circumstances the leader no longer has the same salience for dependency.

Members can benefit from this stage by studying how they respond to new situations. They can learn about their emotional adaptations (defenses) at an interpersonal and internal (unconscious) level, both in relation to authority and to peers. They may feel better because they have shared some of their problems (catharsis), discovered that they are not alone (universality), and they have been respectfully listened to. These represent relational elements inherent to group treatment.

2. The Reactive Phase

Similar to the manner in which children interpret rules rigidly, initial group norms often are experienced (unconsciously) as tyrannical, constricting, and impersonal. In response, clients begin to free themselves and assert their individuality. They may begin to argue or fight, and members’ commitment to the group is tested. At times the group may feel on the verge of disintegration because of the tension. The process unfolds as if participants are saying, “I am an individual with my own feelings and responses, and I will not be controlled by the group.” Thus the members’ task is to find ways of remaining an individual in the group and simultaneously forgo a portion of their individuality. This is a difficult period because the process evokes powerful feelings, which may, for some, seem foreign and aversive. Members may threaten or actually drop out. During this phase, the therapist may lose confidence and may seriously question the value of the enterprise.

In most instances the group and the members survive, discovering that they can manage intense feelings they had not handled previously. They learn to recognize differences, and they learn about the use of their own and others “power.”

3. The Mature Phase

This phase is characterized by clients being able to engage in deeply emotional interchanges and self-expression, with others recognizing the significance of what is being transacted and not interfering with the discourse. Members learn to explore their relationships, including their manner of handling conflict and affection within the group, and apply the new knowledge to their lives outside in a more mature and productive fashion. Not only do participants explore their interactions with others, they examine the personal meanings, as it may be contributing to both their life in the present and in the past. This is not a search for “absolute truth,” but an attempt to examine patterns of behavior and feelings that have created ways of experiencing and interacting that continue from childhood into the present. The ongoing process allows members to experience their repetitious ways of handling relationships and to explore new ways of relating.

The therapist is no longer the only expert, as members learn that they can powerfully and effectively interact with others. This provides a sense of personal competence and efficacy, which is not present in dyadic therapy.

4. The Termination Phase

In ongoing groups clients enter and depart. Optimally, individuals do not leave abruptly. Rather, they provide sufficient time to say goodbye to others with whom they have formed meaningful relationships. Members usually have the opportunity to see others depart, and they familiarize themselves with a variety of responses to leaving. Their own departure, however, is much more personal. Often, under the stress, the departing person regresses to former behaviors. This provides an opportunity for “one more” chance to learn about oneself. No participant leaves entirely “cured.” Group membership provides real relationships as well as transference experiences.

Termination is not easy, as members experience envy, resentment, sadness, and pleasure. Memories of other meaningful losses (separations or deaths) are stimulated. Some may try to convince the departing patient that he or she is not ready to leave, so that they will not have to face the departure. Others push to condense the termination period and diminish their associated affects.

Therapists are not immune to similar emotions. As they do with all phases of treatment, clinicians need to monitor their own emotional states (countertransferences [see later]) to help the group and the departing member experience, to the best of their ability, their departure.

F. Treatment Factors That Affect the Process

1. Cotherapy

Some groups are led by two therapists, which provides clinicians opportunities to share the therapeutic responsibility and to observe and learn from one another in direct action. Cotherapy is often used in training settings. The format requires that the clinicians spend time addressing the process and exploring their areas of agreement and difference.

For patients, the format provides two authority figures, often experienced as parents, with one being experienced as father and the other as mother. It creates an environment similar to a family, with members' associations to the positives and negatives of their family. They can observe how differences and inevitable conflict are managed by the therapists, which may serve as a corrective emotional experience to what was experienced in the family of origin.

Drawbacks to the model are the deemed inefficiency (two persons working where one may do) and the extra time involved in the clinicians addressing their relationship as the process unfolds. Assets of the model include its use in training, an opportunity to work directly with another colleague, and to hear differing perspectives about the conduct of treatment.

2. Combined Therapy

Some patients simultaneously participate in both individual and group treatment. Individual treatment may be either with the group therapist or another clinician. The advantages of such formats are that patients can address emergent problems in private, where there is more individual time for exploration than is available in the group. When the same clinician is therapist in both formats, patterns in the group can be linked to behaviors in the individual treatment, even if the patient does not observe them. Moreover, problems emerging in the dyadic treatment may be brought to the group for further elucidation. This is usually a responsibility of the patient, and not of the therapist.

Almost without exception, patients reveal in the group that they are participating in combined therapy.

This information is examined like any other process element. Other members' common responses are of envy and wishes for special relationships. Opposite concerns suggest that the patient is more ill and requires extra treatment. Many clinicians endorse combined therapy as a very powerful treatment approach.

G. Certain Difficulties in the Treatment Process

1. Countertransference

In the modern therapeutic era, therapists' emotional responses in the treatment situation are examined as potential information about the therapeutic process. These responses may be in the form of the clinician's emotional states or behaviors that may be conscious or unconscious. Historically, countertransference was seen as an impediment to treatment due to the therapist's unconscious responses. Currently, therapists examine their emotional responses, fantasies, dreams, and interactions as sources of information about themselves and their patients. This expanded notion of countertransference separates clinicians' responses into those that can be useful in understanding either the individuals or the process from behaviors that may interfere with the treatment.

In group treatment therapists may respond to experiences from their past as stimulated by an individual, subgroups or the group-as-a-whole process. Mistakes and misunderstandings are inevitable. They may arise from a "reasonable" response to the emotions in the present or from the clinician's past. Interventions that are well intentioned may be heard, understood, or experienced by members in unintended or aversive fashion. Remaining alert to these possibilities enables the clinician to detect processes that may have been derailed.

2. Group Safety

For any treatment modality to function effectively, participants must have confidence in the safety of the situation. The agreement establishes a basic element—no physical contact. Patients who are unable to control themselves may not be able to continue in the group and may be asked to leave temporarily or permanently. In addition to physical actions, patients may threaten others verbally—an action that on a continuing basis is not compatible with group treatment.

3. Extra-Group Contacts

Members almost universally have contact with one another outside the treatment setting. This may naturally occur in the waiting room before the meeting or

when leaving together at the end of a session. Ordinarily, this is not problematic. Not infrequently, though, patients will attempt to manage feelings emerging in the group by meeting with others. Sexual liaisons take place rarely. All salient contacts need to be openly discussed in the therapy, where patients can learn about themselves (see group agreement). Persistence of any emotionally laden extra-group contacts sets up destructive subgroups (i.e., there are secrets) and may be incompatible with an effectively functioning group.

4. Excessive Premature Terminations or Dropouts

Patients leave the group prior to completing treatment for a variety of reasons. Within the first 12 weeks, in almost every new group one or two members are likely to stop treatment, sometimes without notification. Reasons for dropping out may include fears that hearing others emotions may be harmful, or life changes interfere with regular attendance (these changes are sometimes unconsciously “arranged” because of emotional responses).

To provide stability, replacements should be added to the group. If an excessive number of patients drop out, the viability of the group may be in doubt. Most groups do not function effectively with four or less members.

H. Other Populations

Groups described in this section are conducted with basic psychodynamic principles. Characteristically, patients have limitations in their ability to examine unconscious processes. This limitation does not obviate the unconscious processes that contribute to group dynamics. In these circumstances, treatment focuses more extensively on support, stabilization, and reintegration that in part arises from the supportive elements intrinsic to group dynamics. Examination of unconscious processes is limited, concordant with patients’ limited capacities. Such groups represent the application of psychodynamics in an expanded range of setting and populations.

Psychodynamically informed groups have been shown to be useful in inpatient or in partial (day) hospitals. In these settings, patients may meet daily in dynamically oriented groups as an intrinsic element in a broader range of therapeutic activities. The increased meeting frequency serves as support and enables individuals to expose deeper layers of their personality. The results of this treatment have been encouraging for difficult patients who do not respond to more usual outpatient therapy.

Groups for victims of a common trauma or for individuals experiencing grief have been found to be effective in relieving individuals of the resultant acute and sometimes chronic symptoms. Such groups are generally time limited, and the dynamic theory often focuses on the termination issue, which may more specifically reexpose the experience of loss or death.

Psychodynamically informed groups benefit persons with chronic mental illness. Patients with diagnosis of schizophrenia, bipolar disorder, other persistent major illness, or severe personality disorders represent the greatest number of individuals in this category. These individuals are generally not seen as amenable to “insight,” but they can benefit significantly from the slower developing, attenuated relationships. As described by Walter Stone in 1996, groups form in which some individuals attend regularly (core members) and others intermittently (peripheral members). Over time the group develops a workable degree of cohesion, and patients gradually develop trusting relationships. Members of these groups often do not thoroughly examine intragroup relationships and thus have limited potential for insight into their here-and-now transactions. Rather members achieve their benefits primarily through supportive, self-revelation and learning factors.

II. THEORETICAL BASES

Psychodynamic group psychotherapy arises from two theoretical bases: social psychology and psychoanalytic theory.

A. Social Psychology

Social psychology addresses the interaction between the social environment and the individual. Kurt Lewin, who developed field theory, conceives of a group not as a sum of its parts, instead groups form as a system that arises from interacting individuals. In turn, the system affects members’ behavior and feelings. Groups have goals, roles, norms, boundaries, and develop cohesion, and evolve over time.

Psychodynamic groups have goals of improved individual functioning. Roles define the functions necessary to accomplish the task. The schema suggested by Roy MacKenzie posits four group roles: task, social, divergent, and cautionary. The task role, primarily cognitive, helps define what has to be done to accomplish goals. The social role attends to members’ feelings. The divergent role challenges authority and questions normative

views. The cautionary role hides feelings and thoughts. These roles are omnipresent and represent group, not solely individual, functions. Potentially any person could fill each role.

Norms are the conscious and unconscious rules of behavior that influence and regulate the members and the nature of the interactions (i.e., conscious: we should all be on time; unconscious: we will not express anger here). External boundaries define the time, place, and proper information to bring to the group (i.e., one is to tell about oneself). Internal boundaries also define aspects of relationships among members (i.e., feelings are verbalized, not acted on or levels of communication: conscious/unconscious).

Over time, groups will “develop,” as initially described by Warren Bennis and Herbert Shepard. As members resolve conflicts concerning authority and intimacy, roles become distributed and flexible; norms change, and exchanges are freer in the service of achieving goals of individual development and maturation. This is a sociopsychological process seen as somewhat akin to individual psychological development.

B. Psychoanalytic Theory

Sigmund Freud was the founder of psychoanalytic theory of the human personality. Basic theoretical tenets include individuals' behavior is influenced by unconscious processes, (which may be glimpsed through dreams and “mistakes,” like slips of the tongue); individuals are in conflict with efforts to satisfy their instincts (aggressive or erotic), and their own or societal standards. Symptoms are a result of such conflicts. Individuals will transfer their childhood instinctual lives, often expressed as wishes and hopes, to persons in their current life (transference). They will be resistant to directly examining or acknowledging aspects of themselves (resistance) because of perceived danger associated with past childhood experiences or from their own internal prohibitions. They will repeatedly try to master these early conflicts (repetition compulsion) that will emerge in their present relationships. Psychoanalytic/dynamic theory attempts to help individuals understand the meaning of their behaviors or emotions, thereby freeing the person from unconscious forces.

Modifications of original Freudian theory have placed greater emphasis on wishes for relationships, rather than as gratifications of instincts. Moreover, more attention has been directed toward the role of culture in determining one's behavior.

Patients will exhibit repetitious patterns of behavior directed toward the therapist, peers, or to their image of the “group.” The group then becomes a microcosm of their behavior in the external world, with allies, enemies, saviors, or as objects (others or the whole group) of affection or hate (transferences). Members learn about their unconscious motivations or wishes for relationships through their interactions (transferences) that emerge through their repetitious behaviors and emotional responses. This new knowledge will then be available for members to make changes as they are made conscious and examined in the group interactions.

III. EMPIRICAL STUDIES

Treatment efficacy of group psychotherapy has been explored for more than four decades. This has been a most problematic area of research because of the multiple elements contributing to treatment outcome. Nevertheless, meta-analytic reviews of group therapy have shown that group treatment is more effective than no treatment and has equivalent efficacy with individual therapy. These findings, however, need to be appreciated as generalizations, because most of the studies have been with cognitive behavioral treatments. Those with psychodynamic orientation have been limited by a lack of specificity along general demographic dimensions, including age, gender, diagnostic description of the patient populations, and duration of treatment.

Moreover, efficacy studies of group psychotherapy have emphasized individual patient outcome and underemphasize group outcome, that is some groups (therapist–client composition) appear to be more efficacious than others. Insufficient emphasis has been placed on assessing the contribution to outcome of leader behaviors, member-to-member interactions, or the group as a whole setting. In 1999, The National Advisory Mental Health Council's Clinical Treatment and Services research workgroup, concerned with fundamental flaws in present research designs, proposed much broader guidelines in hopes of learning more about the subtle factors of relationship and personality in the therapeutic venture.

Nevertheless, certain consistent findings have emerged that inform group therapy outcome. Patients are generally reluctant to enter into group treatment. Individuals assigned to group treatment are less likely to appear for their initial group meeting than persons assigned to individual treatment. Persons of lower social class and of color are more likely to drop out.

Groups that have a greater number of dropouts are less likely to have good outcomes than those with more stable membership. Individuals who successfully complete their group treatment are likely to credit their benefit to peer interactions, rather than their interactions with the therapist.

Studies of homogeneous populations have been few. Recently, however, reports of patients with borderline personality treated in partial hospital settings have shown improvement as reported by Canadian researchers, Anthony Joyce, Mary McCallum, and William Piper in 1999 and by the Norwegian research team including Theresa Wilberg, Sigmund Karterud, Oyrind Urnes, and colleagues in 1998. Individuals in these studies were treated with a variety of group formats daily in a partial hospital for 16 to 18 weeks. The major emphasis was psychodynamically oriented group treatment. The Wilberg *et al.* study included a 30-month continued outpatient group treatment. Those participating in the continuing treatment had better outcomes than those who did not. The methodology did not include random assignment and therefore requires replication. These studies represent a focus on more homogeneous populations with methodologies that include direct verification of therapists' behavior, thereby controlling for some of the variability.

Despite the overall limitations, research into the efficacy and the process variables that may contribute to the outcome of psychodynamic group psychotherapy remains promising.

IV. SUMMARY

Psychodynamic group psychotherapy is a treatment modality in which a small group of individuals (6–10) meet at a regularly scheduled time and place to address and seek to improve their emotional functioning. The theoretical bases for the treatment derive from social psychology and from psychoanalytic theory. Groups require careful preparation that includes setting goals for the group, recruiting, and preparing prospective members.

Therapists are responsible for creating a structure that facilitates open-ended discussion in which individuals can freely express themselves and examine the un-

folding relationships among them, with the leader, and with the image of the group. In the therapeutic process members will, through repetition compulsion, recreate difficulties that brought them to therapy. Through the relationships and interpretations, participants will learn about their emotional responses and dysfunctional behaviors. The group provides a setting in which they may experiment with new behaviors before attempting them outside. Through the repeated opportunities to see, understand, and alter their behaviors and feelings, patients will mature and gain the capacity for greater intimacy and satisfying relationships and societal roles.

See Also the Following Articles

Anxiety Disorders: Brief Intensive Group Cognitive Behavior Therapy ■ Behavioral Group Therapy ■ Cognitive Behavior Group Therapy ■ Group Psychotherapy ■ Individual Psychotherapy ■ Posttraumatic Stress Disorder ■ Psychodynamic Couples Psychotherapy ■ Self-Help Groups

Further Reading

- Fuhriman A., & Burlingame, G. M. (Eds.). (1994). *Handbook of group psychotherapy: An empirical and clinical synthesis*. New York: John Wiley & Sons.
- Kaplan, H. I., & Sadock, B. J. (Eds.). (1993). *Comprehensive group psychotherapy* (3rd ed.). Baltimore: Williams and Wilkins.
- Klein, R. H., Bernard, H. S., & Singer D. L. (Eds.). (1992). *Handbook of contemporary group psychotherapy: Contributions from object relations self psychology and social systems theories*. Madison, CT: International Universities Press.
- MacKenzie, K. Roy. (1997). *Time-managed group psychotherapy: Effective clinical applications*. Washington DC: American Psychiatric Press.
- Piper, W. E., McCallum, M., & Azim, H. F. A. (1992). *Adoption to loss through short-term group psychotherapy*. New York: Guilford Press.
- Rutan, J. S., & Stone, W. N. (2001). *Psychodynamic group psychotherapy* (3rd ed.). New York: Guilford Press.
- Stone, W. N. (1996). *Group psychotherapy for people with chronic mental illness*. New York: Guilford Press.
- Yalom, I. D. (1995). *The theory and practice of group psychotherapy* (4th ed.). New York: Basic Books.

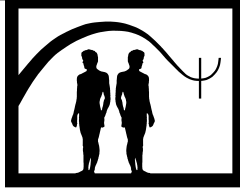

Psychogenic Voice Disorders: Treatment

E. Charles Healey

University of Nebraska, Lincoln

Marsha Sullivan

University of Nebraska Medical Center

- I. Description of Treatment
 - II. Theoretical Bases
 - III. Empirical Studies
 - IV. Summary
- Further Reading

GLOSSARY

- aphonia** Loss of voice.
- breathiness** Audible flow of air during phonation.
- dysphonia** Abnormal voice quality, heard as hoarseness, breathiness, or harshness.
- conversion aphonia** Voice loss in the absence of physical factors.
- conversion dysphonia** Voice disorder characterized by hoarseness, breathiness, or harshness that appears in the absence of physical factors.
- harshness** Phonation that has sudden onsets of phonation along with pitch and intensity abnormalities.
- hoarseness** Aperiodic vibration pattern of phonation, breathiness, pitch breaks, low pitch, and episodes of aphonia.
- hyperfunctional** Excessive function due to behavioral misuse or abuse.
- laryngeal massage** Therapeutic technique used to relax the musculature surrounding the larynx.
- muscle tension dysphonia** Voice disorder caused by excess muscle tension in the larynx.
- mutational falsetto** Voice disorder associated with a high-pitched phonation without structural abnormalities.
- phonation** Vibrations of the vocal folds creating voice.
- puberphonia** Voice of an adolescent.
- psychogenic** Referring to a voice that has psychological origins.

The human voice conveys a wide range of emotions, feelings, attitudes, and affections. It is a dynamic, complex mechanism that is central to verbal communication and is so individualized that for all practical purposes, no two voices are alike. A person's voice may be aesthetically displeasing or may convey a particular personality or emotional state. It is possible to hear a tremulous voice when a person faces fear or danger, an aphonic or dysphonic voice when someone endures extreme emotional stress, or an abnormal vocal pitch in which a man may sound like a woman or a woman like a child. Thus, the human voice has an extremely wide range of pitch, loudness, flexibility, and qualities, but the boundaries between normal and abnormal are not clearly defined. In 1990, Arnold Aronson defined a voice disorder as one that differs in terms of pitch, loudness, quality, or flexibility from the voices of other individuals of similar age, gender, and/or cultural group. However, there is no universal agreement of when either a normal or an abnormal voice exists.

There are a number of reasons why a person's voice might sound abnormal. Some voice problems can result from behavioral or hyperfunctional misuse of the vocal mechanism, abnormal medical and physical conditions, and psychological stress. Given the focus of this book, this article is limited to a discussion of the symptoms and treatments for three types of psychologically based voice disorders. These include (a) conversion reactions resulting in aphonia and dysphonia, (b) mutational falsetto or puberphonia, and (c) muscle tension

dysphonia. These voice problems are commonly referred to as “psychogenic” voice problems because the disorder emerges from abnormal psychological factors in the presence of a physically normal voice.

I. DESCRIPTION OF TREATMENT

Before the treatment for these three psychogenic voice disorders is described, it is necessary to discuss some general features of patients with these types of voice disorders. In light of the strong connection between emotions and vocal behaviors, it is not surprising that emotional conflicts and stress change the way the voice sounds and functions. In 2000, Daniel Boone and Stephen McFarlane noted that increased emotionality or stress will cause significant perceptual changes in the voice because people will: (a) produce shorter and more shallow breathing patterns, and (b) increase the tension of the vocal folds and neck musculature, creating an elevation of the larynx in the neck. The vocal symptoms resulting from these physiological changes can range from complete aphonia to varying degrees of dysphonia characterized by hoarseness, breathiness, and abnormally high-pitched phonation.

Because emotions and vocal performance are so closely related, effective therapy for psychogenic voice disorders requires attention to the entire profile of the person rather than the simple remediation of the vocal symptoms. Therefore, most voice therapy involves a multidisciplinary team approach. Key team members include a speech-language pathologist, an otolaryngologist, a neurologist, and/or a psychologist. The speech-language pathologist and otolaryngologist are the primary members of the team and work collaboratively to rule out the presence of organic laryngeal disease, systemic illnesses, and any form of vocal fold movement disorder. A neurologist is called on to evaluate the voice disorder from a neurological perspective while a psychologist may provide important follow-up support to voice therapy when it is apparent that the voice problem is an expression of significant psychological difficulties.

One of the hallmark features of all psychogenic voice disorders is that the voice sounds abnormal yet the person doesn't have any form of organic laryngeal pathology or disease. In other words, the voice appears normal on visual inspection but is perceptually different from other normal voices. In most cases, the cause of the disorder can be traced to some form of life stress or to personality disorder. Interestingly, normal movement of the vocal

folds usually occurs during a variety of vegetative laryngeal maneuvers such as quiet breathing, coughing, throat clearing, and laughing. Disordered vocal symptoms appear once the verbal communication is initiated.

The following is a description of voice therapy for conversion reactions, mutational falsetto, and muscle tension dysphonia.

A. Conversion Reactions: Aphonic and Dysphonic Voices

People who suddenly display hoarseness or lose the ability to phonate are thought to be suffering from a conversion reaction. These patients believe their voice problem is due to a physical or medically related disorder when, in fact, the problem is related to behavioral repositioning of their larynx due to unresolved interpersonal conflicts. They are unaware that they have translated an emotionally based communication problem into a physical voice problem. Typically, the voice symptoms are triggered by colds, flu, or a short period of laryngitis. Consequently, the person believes the vocal symptoms are a result of an upper respiratory infection rather than an unresolved emotional conflict that is related to communicating feelings toward others. The client's voice is characterized by aphonia, high-pitched squeaks, or varying degrees of hoarseness.

Treatment for this type of voice disorder involves the cooperation of the otolaryngologist and the speech-language pathologist. A patient needs to be reassured by both professionals that the larynx appears and functions normally. In 1995, Moya Andrews pointed out that it is important for the speech-language pathologist to build a positive relationship with the patient to help the patient discuss the main source of emotional conflict and stress. This should set the stage for having the patient accept the notion that the vocal condition is due to some type of emotional conflict. Once this issue is discussed, the speech-language pathologist explains to the patient how emotional stress and tension can interfere with the voluntary control of the voice. Next, the clinician should attempt to elicit a better-sounding voice pressing in, up, or down on the larynx while the patient sustains a vowel sound. Laryngeal massage, which involves using the fingers in a circular motion to reduce tension in the neck musculature around the larynx, is attempted also to help restore normal voicing. It is common to have the patient produce a significantly improved sounding voice during a cough, while clearing the throat, laughing, and shouting. If the voice improves dramatically during these involuntary forms of

phonation, the problem is clearly a conversion reaction. A clinician can facilitate a normal sounding voice through the use of these vegetative vocal gestures. For example, the clinician can have the patient cough but then say a sustained vowel sound immediately after the cough. By extending the vocal sound of the cough into a sustained vowel gives the patient an auditory image of a normal sounding voice and also shows the patient that a normal sounding voice is possible. Therapy continues with having the patient recite the days of the week, counting, or simple oral reading. Gradually, the person should be asked to maintain the voice during a conversation with the clinician. If this occurs, then the patient can be encouraged to talk about the underlying emotional stress or conflicts that precipitated the aphonic or dysphonic voice. Follow-up therapy sessions might be needed to ensure that a normal sounding voice is maintained. In those cases in which the patient is unable to maintain voicing, referral to a psychologist or psychiatrist is recommended.

B. Mutational Falsetto (Puberphonia)

The second major type of psychogenic voice disorder is mutational falsetto, which is sometimes called puberphonia. This voice disorder is most commonly found in young adolescents, but it can also occur in adults. The main vocal symptom of this disorder is an abnormally high-pitched voice for either the male or female even though the voice has undergone its normal postpuberty changes. In other words, the patient has a mature larynx but for some psychosocial reason rejects the normal, lower-pitched voice. Typically, the mutational falsetto voice patient exhibits an elevated larynx, tightly stretched vocal folds creating a thin vibratory mass, and a shallow breathing pattern.

In 1995, Andrews pointed out that treatment of this disorder begins with medical confirmation that laryngeal maturation has occurred and that a laryngeal web or other structural deviations in the larynx have been ruled out. If there are no concerns about the physical condition of the larynx, the clinician can elicit a lower-pitched voice in the following ways. First, the clinician can use laryngeal massage to decrease extrinsic and intrinsic laryngeal muscle tension, adjust head position, and attempt to pull the larynx down to a lower neck position. Gradually, the fingers move down to the thyroid cartilage and thyroid notch where the larynx is gently moved into a lowered position. Some patients will resist the lowering of the larynx, but a clinician

should be persistent and apply considerable force in pulling the larynx down to a more typical resting posture. Massage helps loosen tense musculature and stretches the laryngeal musculature, which contributes to a relaxed vocal mechanism. At the time the clinician is pulling the larynx down, the patient is instructed to cough, sustain a prolonged vowel sound, or repeatedly produce an abrupt onset of phonation. The patient also will produce a lower-pitched voice if a deeper breath is taken prior to phonation. In 1990, Aronson noted that the shift from a high- to a low-pitched voice will be sudden when the voice is produced forcefully and aggressively.

Once a lower-pitched voice is achieved, the clinician should have the patient habituate the lower pitch sound through repeated vowel productions using an abrupt or sudden onset of phonation. Eventually, the lower-pitched voice will become more consistent as the patient moves from vowel productions to words, and then phrases to spontaneous conversation. The speech-language pathologist will encourage the patient to use the lower-pitched voice because it is the most desirable and acceptable voice. Usually, only a few therapy sessions are sufficient to achieve a consistent, normal-sounding voice. At times, the patient rejects the lower-pitched voice because of the difficulty accepting the new vocal image. In those cases, it may be necessary to refer the patient for psychotherapy. Usually, patients return to therapy once they have accepted and become accustomed to the idea of the lower-pitch voice.

C. Muscle Tension Dysphonia

This type of voice disorder was first described by Murry Morrison, Hamish Nichol, and Linda Rammage in 1986. It is usually seen in young to middle-age adults who have difficulty coping with stress or use their voice in stressful situations. There is palpable muscle tension around the larynx, and during phonation, the suprahyoid musculature becomes tight. One of the main features of the disorder is that during indirect laryngoscopic exam, there is a visible space between the vocal folds in the posterior portion of the vocal folds during phonation. This posterior gap in the vocal folds contributes to the perception of a breathy voice and, to some degree, a harsh voice quality. Patients with muscle tension dysphonia usually complain that their voice is weak, lacks appropriate loudness, and tires easily.

Treatment for this type of psychogenic voice disorder typically involves laryngeal massage and a technique

called “yawn-sigh.” The yawn-sigh technique involves having a patient pretend to yawn, which creates an open vocal tract and helps the neck musculature to relax so that a lowered laryngeal position is obtained. When the patient exhales after the yawn, the patient is encouraged to create a gentle and brief phonation (i.e., a sigh) at the end of the yawn. Repeated practice of this technique may facilitate an improved voice quality. However, if this technique is ineffective in producing a better-sounding voice, a clinician will want to perform laryngeal massage and manual repositioning of the larynx, combined with simple vocalizations as done with conversion reactions and mutational falsetto patients. As stated earlier, the patient is asked to produce a sustained vowel sound while the laryngeal massage is taking place. A clearer voice quality and slightly lower pitch indicate that excessive muscle tension around the larynx is subsiding and/or the larynx is pulled down or the thyroid cartilage is gently squeezed. Once a better voice is achieved, the patient should practice using the voice in gradually more complex speech contexts. Patients can be taught how to massage their larynx and move it into a lowered position. In addition, the clinician explains the connection between emotional stress and its impact on increasing muscle tension levels in the neck as well as the direct effect muscle tension has on changing voice quality.

II. THEORETICAL BASES

In 2000, Boone and McFarlane stated that the most accurate theory that explains the mechanics of phonation is the myoelastic-aerodynamic theory of phonation developed in the late 1960s. The basic notions of this theory are that intrinsic vocal fold muscle contractions create elastic movements of the vocal folds, which interact with aerodynamic components. Specifically, airflow expelled from the lungs generates air pressure (aerodynamics) below the vocal folds as exhalation for speech begins. At the same time this aerodynamic process is initiated, there is simultaneous adduction of the vocal folds through contractions of the vocal fold adductor musculature. The vocal folds vibrate in response to the airflow passing between the vocal folds, separating the folds. The elasticity of the vocal fold mass brings the folds back toward the midline, and the vibratory process is repeated. The pitch of the voice and the flexibility of vocal fold movement are directly dependent on the mass, length, and internal tension of the vocal fold musculature.

In addition, the contribution of the epithelial covering and underlying lamina propria of the vocal folds (i.e., mucosa) cannot be ignored as an important component to vocal fold vibrations. Complex movements of the vocal fold cover create a mucosal wave that moves laterally across the superior surface of the each vocal fold at typical conversational pitch and loudness levels. Any type of voice disorder can be explained in terms of disruptions in any one or more components of the myoelastic-aerodynamic theory of voice production and alterations in mucosal wave activity. As stated earlier, changes in the internal position and tension levels of the larynx as well as changes in the airflow and air pressure characteristics of phonation can lead to abnormal voice qualities in psychogenic voice disorders.

III. EMPIRICAL STUDIES

Research confirming the effectiveness of the therapy approaches for psychogenic voice disorders are lacking. Perhaps the major reason for this is that most clinicians are able to achieve a normal or close-to-normal sounding voice within one or two therapy sessions. Moreover, clinicians may not have a sufficient number of these types of cases to warrant publication of the results of their clinical treatment. Our clinical results show that approximately 90% of the psychogenic patients we treat exit our clinics with normal-sounding voices. Relapse can occur but one or two treatment session(s) is usually sufficient to have the patient's voice return to normal.

The studies that are available indirectly address the effectiveness of the techniques used to treat psychogenic voice disorders. As discussed in the treatment section, laryngeal massage and repositioning of the larynx are used with all three psychogenic voice disorders described in this article. In 1993, Nelson Roy and Herbert Leeper showed that laryngeal massage was effective in improving the voices of 17 patients with voice problems that had no organic involvement.

In another study in 1998, Louis Luguna, Charles Healey, Debra Hope described the successful remediation of a patient with a voice disorder secondary to social phobia. At the outset of therapy, the patient was diagnosed with muscle tension dysphonia. The patient's voice was characterized by a combination of dysphonia, vocal tremors, and occasional spasmodic closure of the vocal folds. Treatment was successful in reducing the abnormal vocal symptoms and social phobia.

IV. SUMMARY

Psychogenic voice disorders represent a small portion of patients with voice disorders that a speech-language pathologist treats. However, the large majority of patients are capable of achieving a normal-sounding voice in a treatment session or two. This is possible because the voice disorder is not related to any organic involvement. Elevated levels of muscle tension in and around the larynx, a heightened posture of the larynx, and poor respiratory support for phonation can result in a voice problem ranging from complete aphonia to varying degrees of dysphonia. High-pitched, tense voices are always seen within the subgroup of the population with voice disorders. Treatment for psychogenic voice disorders involves convincing the patient that the problem is related to a functional misuse of the larynx. Through laryngeal massage and manual repositioning of the larynx while the patient produces simple vocalizations such as sustained vowels, coughing, or clearing the throat, a normal voice can quickly be established. Treatment for these types of voice disorders is effective when proper

diagnosis and management are provided by a speech-language pathologist.

Further Reading

- Andrews, M. L. (1995). *Manual of voice treatment: Pediatrics through geriatrics*. San Diego, CA: Singular Publishing Group.
- Aronson, A. E. (1990). *Clinical voice disorders* (2nd ed.), New York: Thieme-stratton.
- Boone, D. R., & McFarlane, S. C. (2000). *The voice and voice therapy* (6th ed.), Boston: Allyn and Bacon.
- Laguna, L. B., Healey, E. C., & Hope, D. A. (1998). Successful interdisciplinary intervention with an initially treatment-resistant social phobia. *Behavior Modification*, 22, 358–371.
- Morrison, M. D., Nichol, H., & Rammage, L. A. (1986). Diagnostic criteria in functional dysphonia. *Laryngoscope*, 94, 1–7.
- Rosen, D., & Sataloff, R. (1997). *Psychology of voice*. San Diego, CA: Singular/Thomson Learning.
- Roy, N., & Leeper, H. A. (1993). Effects of manual laryngeal musculoskeletal tension reduction technique as a treatment for functional voice disorders: Perceptual and acoustic measures. *Journal of Voice*, 7, 242–249.

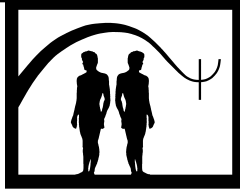

Psychopharmacology: Combined Treatment

Jerald Kay

Wright State University School of Medicine

- I. Description of Treatment
- II. Theoretical Bases
- III. Clinical Challenges in Using Psychotherapy and Pharmacotherapy
- IV. Applications and Exclusions
- V. Empirical Studies
- VI. Case Illustration
- VII. Summary
Further Reading

- c. *Selective serotonin reuptake inhibitors*—medications that promote greater synaptic availability of the neurotransmitter serotonin.
 3. *Hypnotics*—different classes of compounds (e.g., benzodiazepines) used to induce sleep.
 4. *Mood stabilizers*—multiple types of medications that reduce or prevent mood lability and associated symptoms in affective disorders (e.g., bipolar disorder).
 5. *Antipsychotics*—different classes of medications that target many types of malfunctioning neurotransmitter systems such as the dopamine system and relieve and prevent symptoms of psychoses.
- sequential treatment* The addition of psychotropic medication to psychotherapeutic treatment or psychotherapy to pharmacotherapy when a monotherapy is unsuccessful in alleviating symptoms of a patient's mental disorder.
- split treatment* The primary treatment of a patient by a psychotherapist in collaboration most often with a psychiatrist who is responsible for the management of medication.

GLOSSARY

combined treatment The simultaneous prescription of psychotherapy and pharmacotherapy in the treatment of a patient's mental illness.

integrative treatment The provision of pharmacotherapy and psychotherapy by the same clinician.

psychopharmacology The treatment of mental illness with classes of medications that include the following

1. *Anxiolytics*—compounds that possess antianxiety effects to relieve emotional tension.
2. *Antidepressants*—agents from a number of different classes used primarily to relieve depression although often useful in treating other symptoms.
 - a. *Monoamine oxidase inhibitors*—medications that inhibit the degradation of monoamine oxidase in the brain thereby elevating levels of available biogenic amines.
 - b. *Tricyclic antidepressants*—compounds that increase the availability of multiple neurotransmitters, (e.g., norepinephrine) in the brain.

I. DESCRIPTION OF TREATMENT

Throughout the last 10 years, managed behavioral health care has demanded an increasing accountability of mental health professionals to demonstrate both effectiveness and cost effectiveness in the treatments they provide. Because cost containment is the primary objective of managed care systems, the delivery of least expensive treatments has been paramount. This demand has resulted in a significant shift in the treatment models of patients or clients with mental illness toward therapies

that are less costly and time intensive. However, the use of combined treatment, that is the employment of both psychotherapy and medication in the treatment of mental disorders, has been a preoccupation of modern psychiatry for more than 40 years and is becoming standard for many mental disorders and psychological problems. In the case of the physician mental health professional, managed care has, in general, preferred a model wherein psychotherapy is provided by a nonphysician mental health provider, and the physician, usually a psychiatrist, becomes responsible for the initiation and ongoing management of pharmacotherapy. For nonphysician mental health professionals, they have become increasingly obligated to adhere to guidelines that mandate a specific treatment for a specific disorder that frequently requires the use of medication. This type of treatment has been referred to most often as split or collaborative treatment. Managed care has undoubtedly refocused professional attention on collaborative care.

Although there is sparse data to support either the effectiveness or cost effectiveness of split treatment in naturalistic settings, nevertheless it has become a common practice. There are however a small number of studies that have suggested the possibility of reduced costs when medication and psychotherapy are provided by the psychiatrist under the auspices of a managed care arrangement.

The use of medication with psychotherapy is limited by neither the type of disorder nor the theoretical model of psychotherapy employed. Indeed in the case of interpersonal psychotherapy (IPT) medication issues where appropriate are routinely presented as a significant component in the treatment process from the start. Part of the appeal of this type of psychotherapy is the direct attempt to provide treatment in a situation that closely resembles the traditional nonpsychiatric doctor-patient relationship thereby reducing the stigma often associated with the need for mental health services. Similarly, the integration of psychotherapy and medication, when indicated, often characterizes cognitive-behavioral as well as psychoanalytically oriented psychotherapies.

II. THEORETICAL BASES

The prominence of a biologically based psychiatry within the last 40 years was in no small part facilitated by the substantial development of new compounds to treat mental disorders. Initially there was resistance to the introduction in psychotherapy of psychotropic med-

ications. Some expressed concern that psychotropics irreparably altered the treatment relationship and dampened symptoms to such a degree that patients were no longer motivated to undergo psychotherapy. Others claimed that the introduction of medication encouraged a passive, dependent stance and perhaps the potential for magical thinking and symptom substitution. Still others claimed a lowering of the patient's self-esteem as a result of viewing himself or herself as being more ill and requiring some external agent to function. Some therapists feared that using medication raised unnecessary fears in patients that they were somehow less interesting to treat.

On the other hand, there may be benefits of employing medication within the psychotherapeutic relationship. These include:

- Patient self-esteem may be enhanced through symptom reduction.
- Greater safety and therefore increased expression of emotions by patients.
- Greater patient accessibility to psychotherapy through enhanced cognition, verbalization, and abreaction.
- Improvement in autonomous ego functions such as thought, attention, concentration, and memory permitting greater ego strength for verbal treatment.
- Reduction of stigma in help seeking through a positive placebo effect.
- Evocation of feelings and fantasies about receiving medication and the accompanying side effects that provide useful insights about the patient's personality and psychological state.
- Creation of an avenue to explore countertransference feelings around medication side effects or dose changes.
- Provision of a transitional connection between patient and therapist at times of unanticipated interruptions in treatment.
- Demonstration of patient conflicts about success when medication provides improvement.

Conversely, patient compliance or adherence to prescribed medication is a daunting problem for all physicians regardless of specialty. Some studies have found that nearly one-half of all patients prescribed a medication do not follow the prescription. Very often adding psychotherapy to a medication-based treatment program brings significant improvement in this problem because it establishes a format to explore noncompliance issues. In this respect, it is important to remember that effective treatment with pharmacological agents

requires a solid therapeutic alliance as is the case when psychotherapy alone is provided. Helpful psychiatric treatment is based on correct diagnosis, however making a correct psychiatric diagnosis without a productive doctor–patient relationship does not assure that patients will take their medications.

Regardless of theoretical persuasion, therapists know that the prescription of medication has significance for each patient in psychotherapy. If the psychological meaning of taking medication can be understood, it can provide a useful resource for the psychotherapist. This is true for either a treatment plan in which a psychiatrist is both prescribing medication and providing psychotherapy or in those instances when a physician is directing the pharmacotherapy and a nonphysician mental health professional is responsible for the psychotherapeutic component.

Medications may have positive and negative meanings for patients. For some, the prescription of medication is a positive reflection that the professional or professionals are interested in and acknowledge the patient's emotional pain and discomfort. Other patients may feel that the introduction of medication into a psychotherapy can be a reflection of the therapist's disinterest or discomfort with the patient's plight. For most patients, medication is viewed as a trustworthy and effective intervention, yet for the suspicious patient medication may be experienced as toxic, hurtful, and an attempt on the part of the physician to control the patient. Similarly, although most patients view medications as relatively safe interventions, others attribute psychological significance to even the most benign side effects. Because for many psychotropics, improvement in symptoms does not occur for 2 to 3 weeks or longer, some patients view the gradual onset of action as a sign that the psychiatrist is inept and or uncaring and that the nonphysician collaborator is not to be trusted because of the questionable referral. For those who have difficulty following the medication regimen, the psychotherapist is obligated to explore the possible reasons. Is it a matter of the patient's denial, incompetency, lack of motivation, the presence of an recognized comorbid disorder, or might this nonadherence be a true reflection of a poor therapeutic alliance? Regardless of diagnosis, for some with a mental disorder, poor adherence may be a representation of an unstable, inconsistent, or chaotic lifestyle.

Despite the substantial scientific evidence demonstrating (alone and in combination) the efficacy of psychopharmacology and psychotherapy for many disorders, cognitive neuroscience does not offer a unified theory explicating the precise mechanisms about the in-

teractions between the two types of treatment. Medications, by and large, are conceptualized in terms of their ability to enhance the capacity of the biological system to respond, experience, and integrate information. Psychotherapies address these issues as well, but fundamentally they are concerned with meaning. Different psychotherapies, of course, utilize different approaches at discovering and modifying the meaningfulness of certain events, feelings, conflicts, wishes, and fears. There is a growing knowledge, for example, about the neurobiology of psychotherapy that has described on the molecular and structural levels how learning and memory may bring about change in psychotherapy. Integrated neuroscience promises that someday what we call the mind will be explained from a biological point of view, at this point in time however, the clinician must juggle two conceptual approaches to understanding human behavior in illness and in health.

III. CLINICAL CHALLENGES IN USING PSYCHOTHERAPY AND PHARMACOTHERAPY

When a psychiatrist is providing both psychotherapy and pharmacotherapy there are some specific challenges to the delivery of effective combined treatment. These include:

- *The adoption of an overview to the patient that encompasses and integrates both biological and psychosocial domains.* This may require the clinician to adopt a more directive and educational manner of relating when discussing medication concerns, and perhaps, in the case of a psychoanalytically oriented psychotherapist, becoming more active than usual in this portion of the visit.
- *The establishment of a system for addressing medication issues with the patient.* The clinician may decide to raise medication issues at the start or very end of the session. In the former case, medication concerns are sure to be covered, and important and helpful material about the therapist–patient relationship may be introduced and explored throughout the entire visit. However, some therapists object to the physician setting the initial agenda for the meeting and favor permitting the patient to begin each session with whatever is most pressing. Others feel that by electing to discuss medication at the very end of a meeting, there is the possibility of premature closure of a significant discussion. Regardless of which approach is selected, it is vital to establish consis-

tency. Deviation from the traditional approach is often helpful in identifying potential countertransference events. For example, when a medication discussion is introduced by the clinician atypically in the middle of a session, it is often an indicator of some discomfort.

- *The development of a systematic format for addressing side effects, requests for changes in medication dose and type, and requests for discontinuation of pharmacotherapy.* In the first case, complaints about side effects may be an important manifestation of patient resistance to psychotherapy. If in the middle of a well-established insight-oriented psychotherapy, the psychiatrist considers raising the possibility of medication, this may be an indication of increasing frustration with the patient's lack of progress.

- *Acquiring a particular sensitivity to termination issues.* It is not uncommon for patients in some types of therapies to experience a recurrence of symptoms at the end stage of treatment. The clinician should not assume that such events require additional or reintroduction of medication. Invariably, this phenomenon is a reflection of the patient's conflicts about the end of the therapeutic relationship and requires appropriate exploration.

Professionals working in collaborative or split treatments face quite different challenges. These treatment relationships may consist of a nonphysician mental health professional and a psychiatrist, a primary care physician and a psychotherapist, and a psychoanalyst or psychiatrist and psychopharmacologist to name but a few formats. The practice of collaborative treatment is by no means rare and two-thirds of practicing psychiatrists have reported prescribing medication for patients in psychotherapy with other professionals. However, the greatest challenge in providing quality collaborative care is assuring adequate communication. This includes communication between the patient and each of the professionals but especially between the psychotherapist and physician.

The amount of time that is required to establish an effective relationship between two providers in a split treatment is by no means insubstantial. However failure to delineate many aspects of the collaborative relationship at the outset is undoubtedly the primary reason for poor patient outcome. First, cooperative treatment implies equal respect for the responsibilities and contributions of each provider. There is no place for ideological or professional tensions in the provision of effective split treatment. Second, the patient must be educated about the unique aspects of entering this type of treatment relationship. These include consent for the professionals to communicate frequently about the patient's progress,

difficulties, and medication side effects. Confidentiality is defined differently in this type of treatment relationship, and patients must be aware that information from either professional will be discussed routinely and particularly at times of change or crisis in the treatment.

Informed consent in collaborative treatment should outline clearly the benefits and risks of each type of treatment component as well as explore the patient's expectations of the combined treatment. Organizational guidelines in the field of psychiatry suggest that there should be documentation of each party's responsibilities and that this information has been conveyed to the patient. This includes the need for periodic assessment of the treatment process. It is helpful to prepare a document that explains responsibility in times of emergencies, need for hospitalization, vacation coverage, and a method and frequency of collaboration that is not limited to times of crisis. In this regard, many professionals have begun to rely on electronic mail or fax to keep their collaborators up-to-date. Others prefer face-to-face meetings or telephone conversations.

Consistent communication between the treating professionals serves other purposes beyond legal concerns. Because transference is universal regardless of treatment modality, the introduction of a second professional may often provide some unique challenges. Depending on a patient's psychological problems, a three-person system may activate significant unresolved conflicts and unexpressed expectations about the treatment team. On the other hand, the propensity for splitting is high in some types of patients especially those with particular personality disorders. Idealization of the physician because he or she prescribes medication whereas the psychotherapist does not is common. Similarly, some patients experience a quick medication visit as being reflective of the disinterest of the physician, and the therapist is then held in much higher regard. Negative comments about either professional may serve as important indicators of the patient's problems and characterological style and require that their psychological importance be understood and explored with them within the treatment. Under no circumstances, except in cases of ethical misconduct or malpractice, should either professional collude with the patient to criticize another collaborator. Persistent negativity about one provider should be discussed within the collaborative relationship to decide how best to address this issue.

As noted previously, the suggestion to seek a pharmacological consultation invariably raises relevant patient concerns about the meaning of the current treatment relationship as well as the prognosis. How consideration

for medication consultation is introduced has great influence on the patient's ability to follow through with the recommendation. The nonphysician professional should be clear for the reasons for referral. Is it a request for a second opinion about the patient's problems and suitability for psychotherapeutic treatment alone, a request for assistance in controlling disruptive symptoms, or even concern about the potential for an unmerited lawsuit.

IV. APPLICATIONS AND EXCLUSIONS

As will be reviewed shortly, the empirical evidence for employing combined treatment is growing. This is true across the spectrum of mental disorders from the most disabling to those disorders that are often associated with higher levels of functioning and coping. There appear to be no patient populations for which combined treatment is contraindicated although the usual culturally based reservations about psychotherapy or the taking of medication are always relevant. Beyond cultural considerations, the nonphysician professional must be aware that for some patients, medication is not an acceptable form of treatment and that a significant number of patients depending on their disorder will not respond to medication regardless of the type and duration of treatment.

There may be some clinical indications when combined treatment by a psychiatrist may be advantageous although there is no scientific evidence to support these assumptions. These might include those patients with highly complex medical conditions; cluster B personality disorders that have a history of significant self-harm and have experienced the need for frequent hospitalizations; and for those individuals with severe anorexia nervosa who require intensive medical care. Some, but not all, noncompliant patients with severe Axis I disorders such as schizophrenia and bipolar disorder may be candidates for this type of care as well.

V. EMPIRICAL STUDIES

A. Mood Disorders

With respect to combined treatment, unipolar nonpsychotic depression or major depression has been the most extensively studied disorder. Recent randomized controlled studies have provided the best evidence of the efficacy of psychotherapy and pharmacotherapy

in the treatment of mood disorders. In a study of approximately 200 elderly patients with recurrent nonpsychotic major depression, interpersonal psychotherapy (IPT) in combination with a tricyclic antidepressant was found to be more effective than either medication or psychotherapy alone. More specifically, those receiving the combined treatment has a recurrence of 20% compared to 43% in those patients with medication alone, and 64% of those treated exclusively with psychotherapy. Those patients receiving only placebo in a typical medication clinic program had a recurrence rate of 90%.

The largest meta-analysis of approximately 600 subjects with nonpsychotic unipolar depression has established that combined psychotherapy and pharmacotherapy was more effective than psychotherapy alone. This study examined patients treated with either cognitive-behavior therapy (CBT) or IPT and compared them to those who were treated with IPT and medication. Combined treatment produced better outcome and also shorter time to recovery. However in patients with less severe depression, psychotherapy alone was equivalent to combined treatment.

A very recent study, the largest randomized controlled trial to date, demonstrated that medication and psychotherapy is clearly superior to either monotherapy. This study of nearly 700 patients found that psychotherapy and a newer antidepressant (nefazadone) provided greater relief than either treatment intervention by itself. This study used a manualized cognitive behavioral treatment called cognitive behavioral analysis system of psychotherapy (CBASP). Study participants receiving integrative treatment had an 85% response rate compared to 55% of those taking medication alone and 52% of participants being treated with psychotherapy alone.

European researchers were able to demonstrate the cost effectiveness of adding psychodynamic psychotherapy in outpatients with depression being treated pharmacologically. The addition of the psychotherapy resulted in fewer hospital days at the end of treatment as well as at 1-year follow-up. In addition to lower direct costs from hospitalization, combined treatment was also associated with less indirect costs for sick days.

As many as 40% of adolescents with chronic depression fail to respond to an initial trial with either a selective serotonin reuptake inhibitor (SSRI) or psychotherapy. Some of these so called treatment-resistant teenagers may have comorbid disorders such as attention-deficit-hyperactivity disorder (ADHD), bipolar disorder, and/or substance abuse. However, in adolescents

with only chronic depression, as many as 70% of these patients will respond when both medication and psychotherapy are provided.

In what order should medication or psychotherapy be added to either ongoing monotherapy is an important treatment issue. Sequential therapy refers to this clinical decision as to when to augment psychotherapy with medication or when to add psychotherapy to a pharmacotherapy. In the treatment of recurrent major depression it was found that in women who did not fully recover with IPT, the addition of an antidepressant was more effective than treating participants from the outset with combined treatment. Although this study was not a randomized controlled one, it did examine participants from a single patient population treated at one center. This treatment sequence may have particular appeal to women who are against taking medication during pregnancy or lactation.

The data from combined treatment in patients with dysthymia is inconclusive, but this is not the case in the treatment of bipolar disorder. Patients with bipolar and schizoaffective disorders are treated more effectively when they receive family therapy with medication as opposed to psychotherapy alone. Those in combined treatment had fewer relapses and hospitalizations, and researchers were able to demonstrate that family members viewed their affected relatives in a much more positive light.

B. Schizophrenia

There is a wealth of studies going back more than 20 years that has demonstrated the efficacy and effectiveness of treating schizophrenia with psychotherapy and medication. Contrary to some views, families and patients affected by this disorder value psychotherapy greatly. Early studies have demonstrated that patients living in families characterized as having high expressed emotion are more vulnerable to relapses. Such families are characterized by intense affect, frequent criticism, and intrusiveness which have been associated with noncompliance. One randomized controlled study of first-episode patients found only a 10% hospital readmission rate with participants who received both family therapy and medication. This figure compared to a 75% readmission rate in those patients who received no treatment. In addition to family therapy, individual psychotherapy has shown substantial promise. A recent 3-year randomized controlled trial of patients with schizophrenia who received medication and a type of individual treatment called personal therapy that addressed stress management, education about ill-

ness, and interpersonal relationship issues was found to be superior to medication and supportive measures. It also promoted enhanced social adjustment throughout the entire study period.

Patients in a British study whose illness did not respond to medication were helped with the addition of 9 months of CBT. Improvement persisted after the completion of formal therapy that was not the case for those patients receiving medication and a nonspecific befriending relationship. This study also noted that rational discussion of hallucinations and delusions when included as a formal component of the psychotherapy accounted for 50% less symptomatology. Another randomized controlled study of patients treated with 20 individual sessions of CBT showed significant improvement compared to groups who either received only medication or supportive psychotherapy plus medication.

Two other studies have demonstrated that CBT is helpful in the treatment of patients with schizophrenia. Treatment refractory patients started on an atypical antipsychotic medication and provided with CBT and social skills training showed greater improvement than a comparison group treated with supportive psychotherapy and medication. Another randomized controlled trial where CBT and medication were compared to medication plus routine care demonstrated nearly four times the improvement in the former group.

C. Anxiety Disorders

Compared to schizophrenia and affective disorders, there are considerably fewer studies of integrative and combined treatment in panic, generalized anxiety, and obsessive-compulsive disorders. In the case of panic disorder, a recent randomized controlled trial of approximately 300 patients receiving CBT and the tricyclic antidepressant imipramine demonstrated greater improvement at the end of the maintenance phase of treatment than those patients with panic disorder who were treated with either monotherapy. One report examined combined treatment of panic disorder with clomipramine and 15 sessions of brief psychodynamic psychotherapy. Patients who received both components showed greater improvement 9 months after the discontinuation of medication compared to those who were treated only with clomipramine. The efficacy of psychodynamic psychotherapy as a monotherapy in the treatment of panic disorder is currently under study, and preliminary reports are very promising.

In the 1980s there were numerous publications that supported the superiority of tricyclic antidepressants and behavioral therapy in combination for the treat-

ment of panic disorder and agoraphobia with single interventions. However, there is considerable controversy regarding the advantage of using combined treatment compared to medication or psychotherapy alone in large part due to the high rate of relapse after medication is discontinued. The integrative treatment of social and specific phobias may be more helpful than is the case with panic disorder. It appears that the same may also be true for combined treatment of generalized anxiety disorder with CBT and medication. However the literature is very limited in this area. The clinician must remember that the vast majority of early studies in combined treatment of anxiety disorders employed older tricyclic antidepressants that often cause considerably more side effects than newer-generation medications. Therefore, studies using selective serotonin reuptake inhibitors may clarify the usefulness of these agents with psychotherapy.

Some practice guidelines support the use of medication and behavioral therapy in treating obsessive-compulsive disorder. Clinical consensus is that exposure and response prevention psychotherapy coupled with selective serotonin reuptake inhibitors is the treatment of choice. The superiority of behavioral therapy over medication alone is well established, but there are few substantive studies of combined treatments.

D. Substance Abuse

There are a number of reports that have noted the superiority of combined treatment with the opiate dependent. A randomized controlled trial assigned 84 opiate-dependent patients to either 4 months of counseling and supplemental drug counselling or counseling with supportive-expressive psychotherapy. At 6 months after treatment, those participants receiving the psychodynamic psychotherapy could be maintained on lower doses of methadone and also were less likely to test positive for cocaine. Another randomized controlled study of the same population found that those provided with psychiatric and vocational counseling services as well as family therapy were less likely to be hospitalized, experience job instability, and to be on welfare than patients who were assigned to medication or medication and counseling groups.

With regards to the treatment of alcoholism, two medications have been used traditionally and are FDA approved: disulfiram and naltrexone. The effectiveness of psychotherapy has been studied in a multisite effort called Project MATCH (Matching Alcoholism Treatment to Client Heterogeneity). This study of more than 1,700 patients, compared three forms of manualized treatment

(CBT, motivational enhancement therapy, and 12-step facilitation) and found that all three treatments were effective in treating alcohol dependence with the last proving the most effective at 3-year follow-up.

E. Eating Disorders

At present there is only one randomized control trial addressing the treatment of women with bulimia nervosa. This study of 120 participants examined groups that were treated with CBT, supportive dynamic psychotherapy, and medication. Results indicated that CBT plus antidepressants was more effective than the psychotherapy by itself. Also patients given either CBT or supportive psychotherapy with medication experienced less depression and binge eating. The medication component of the study permitted the prescription of new-generation antidepressants if an older medication was unhelpful. This sequential treatment provided only modest improvement compared to the effectiveness of the CBT or supportive treatment.

F. Personality Disorders

There exists one randomized controlled trial of combined treatment for personality disorders, and therefore many clinicians follow consensus treatment guidelines. In this recent study of patients with borderline personality disorder treated with psychoanalytic psychotherapy and medication compared to patients receiving only standard care without psychotherapy, the former group showed decreased suicidal attempts, self-mutilating behavior, number and duration of hospital admissions, and the use of other psychiatric services. This group also demonstrated symptomatic improvement in anxiety, depression, and general symptom distress. There were also gains in interpersonal functioning and social adjustment.

The use of medications in the psychotherapeutic treatment of borderline personality disorder has been associated with a decreased treatment drop-out rate and fewer severely disruptive regressions. Some have cited a positive effect of medication in decreasing intense feelings of aloneness, a common characteristic of many patients with borderline personality disorder. Many clinicians use split treatment arrangements that augment the psychotherapy with medication for reducing target symptoms of aggression, impulsivity, affective lability, and behavioral dyscontrol.

From the review of the literature it is clear that many questions must be answered about the combined use of psychotherapy and pharmacotherapy. Which disorders

are best treated with an integrative approach? What are the indications for sequential treatment, that is, when should treatment begin with psychotherapy and then be followed by the introduction of medication? For which patients and when in the treatment should psychotherapy be added to a pharmacological approach? Which psychotherapies are more advantageous for which disorders in a combined treatment? For which disorders is split treatment cost effective? Many mental health professionals work under significant fiscal pressure to be accountable to payors for the services they provide. Some of these constraints are not based on scientific support and require substantial investigation.

VI. CASE ILLUSTRATION

Ms. Jensen is a 27-year-old unmarried accountant who was referred by a recently relocated family physician to a social worker for assistance in managing the patient's depression and anxiety. According to her physician, the patient has not responded within the last 6 months to any of the various medications he has prescribed. She has a long-standing history of depressive episodes beginning as grade schooler and a well-established pattern of self-defeating behavior since her high school days. The patient has been difficult for the physician as she frequently calls for appointments because of a multiplicity of symptoms and complaints. He is unable to ascertain any significant illness in his patient, and all diagnostic tests have proven normal. Because the psychotherapist has not worked previously with the referring doctor, she recommends that they meet to discuss the patient before an evaluation for treatment is started. The doctor puts off the therapist saying he is pressed for time in his new practice and would prefer to send a summary of the patient's history. The social worker, not willing to disappoint a new referral source, agrees reluctantly to see Ms. Jensen.

The patient tells the therapist that her doctor seemed disinterested in her and stated that she was instructed to visit with a mental health professional for counseling. She describes her physician as very controlling and insisting that she take medication. The history indicated that the patient grew up in a household where both her mother and father were very demanding and rigid, always insisting that there was only one way to view life. This had major consequences for the patient particularly in her adolescence.

Ms. Jensen acknowledged that she had stopped taking the medications prescribed for her because of side effects despite the fact that her doctor had reassured her that they would pass after the first week of treatment. She felt

he had been dishonest because some side effects, like her sexual dysfunction, did not improve. The patient was effusive in her praise for the psychotherapist who clearly was interested in her plight and gave her sufficient time to talk. This was not the case with her family doctor whom she experienced as somewhat rigid.

At the completion of the assessment, the social worker summarized her thoughts about the possible ways in which to proceed. She mentioned that the patient should discuss her side effects with her physician and that perhaps there might be another medication that would be less problematic for her. She instructed Ms. Jensen to return to her primary care doctor and share with him that psychotherapy would be helpful as well and that therapist was available to meet with this patient on a regular basis.

After trying to contact the referring physician without success, 4 days later the psychotherapist received a discouraging phone call from Ms. Jensen's doctor who felt he was undercut in his treatment decisions because the patient refused to take any of the medications he wished to prescribe and had nothing but glowing words about her interaction with the therapist. According to the physician, Ms. Jensen explained that she was instructed to tell him that psychotherapy was indicated and not medication treatment.

A. Discussion

This vignette illustrates the complications that can arise in a collaborative treatment when the expectations of both collaborators are never fully presented. First, even prior to the referral, the meaning of medication to this patient was never appreciated. She experienced her physician much like her parents who insisted they were correct at all times and that everything she did should conform to their wishes. In addition, there was a failure to explore side effects that resulted from the medication. This referral was made after the physician became frustrated with the patient and began to experience her as a difficult or problem patient. However, the psychotherapist should not have agreed to evaluate this patient because the necessary guidelines for the referral were never clear. Because the respective roles of the professionals were not delineated, the patient began even within the diagnostic sessions to polarize her treatment relationships with her physician and therapist. She also misconstrued what was recommended by the mental health professional, but this remained unclear because the physician had not returned the consultant's call in a timely manner. In short, this collaborative effort was doomed from the first.

It would have been helpful if the professionals had agreed to meet in person as this was their initial referral experience. At the very least, an in-depth phone conversation should have detailed the physician's concerns and expectations about the referral, and the social worker could also explain her requirements to evaluate and treat the referred patient. If treatment were indicated, the physician would be aware of the central need for communication and in what form and how frequently it should occur. There was no opportunity to discuss any of the groundwork either clinical or legal for this type of treatment relationship, and it was apparent from the outset that the physician did not respect or value the potential assistance from the mental health professional.

VII. SUMMARY

Integrated and combined treatment is the provision of both psychotherapy and pharmacotherapy to a patient. In the case of the former, therapy is most often administered by a psychiatrist. Combined, split, or collaborative treatment is administered jointly by a psychiatrist, other physician, or nurse practitioner with another mental health professional psychotherapist. Although collaborative or split treatment lacks scientific support for its effectiveness or cost effectiveness, it nevertheless is widely used. Mental health care financing has undoubtedly played a major role in the acceptance of split treatment. The psychiatrist who treats the patient with medication and psychotherapy must be hypervigilant to the meaning of medication for each patient and how it is reflected in the treatment relationship. Those clinicians working in collaborative treatment relationships must above all develop concise and consistent plans for professional communication about their patient's experiences if the treatment is to succeed.

Last, despite early efficacy initiatives, the clinician is in the best position to discover the benefits and challenges of treating clients or patients with multiple approaches. For the near future, the naturalistic setting is likely to provide the exciting findings and suggest new areas of inquiry. Mental health professionals will undoubtedly become more sophisticated in their ability to provide integrative and combined treatment.

See Also the Following Articles

Adjunctive/Conjoint Therapies ■ Eating Disorders ■ Integrative Approaches to Psychotherapy ■ Mood Disorders ■ Neurobiology ■ Schizophrenia and Other Psychotic Disorders ■ Sleep Disorders ■ Substance Dependence: Psychotherapy

Further Reading

- Barlow, D. H., Gorman, J. M., Shear, M. K., & Woods, S. W. (2000). Cognitive-behavioral therapy, imipramine, or their combination for panic disorder: As randomized controlled trial. *Journal of the American Medical Association*, 283, 2529–2536.
- Eells, T. D. (1999). Psychotherapy versus medication for unipolar depression. *Journal of Psychotherapy Practice and Research*, 8, 170–173.
- Gabbard, G. O. (2000). Combined psychotherapy and pharmacotherapy. In B. J. Sadock, V. A. Sadock (Eds.), *Comprehensive textbook of psychiatry* (7th ed., pp. 2225–2234). Philadelphia: Lippincott, Williams and Wilkins.
- Goldman, W., McCulloch, J., Cuffel, B., Zarin, D. A., Suarez, A., & Burns, B. J. (1998). Outpatient utilization patterns of integrated and split psychotherapy and pharmacotherapy for depression. *Psychiatric Services*, 49, 477–482.
- Hogarty, G. E., Greenwald, D., Ulrich, R. F., Kornblith, S. J., Dibarry, A. L., Cooley, S., Carta, M., & Flesher, S. (1997). Three-year trials of personal therapy among schizophrenic patients living with or independent of family. I: Description of study and effects of relapse rates. *American Journal of Psychiatry*, 154, 1504–1513.
- Kay, J. (2001). *Integrated treatment of psychiatric disorders*. Washington, D.C.: American Psychiatric Press.
- Klerman, G. L., Weissman, M. M., Markowitz, J. C., Glick, I., Wilner, P. J., Mason, B., & Shear, M. K. (1994). Medication and psychotherapy. In A. E. Bergin, S. L. Garfield (eds.), *Handbook of psychotherapy and behavior change* (Vol 4, pp. 734–782). New York: John Wiley and Sons.
- Riba, M. B., Balon, R. (1994). *Psychopharmacology and psychotherapy: A collaborative approach*. Washington, DC: American Psychiatric Press.
- Thase, M. E., Greenhouse, J. B., Frank, E., Reynolds, C. F., Pilkonis, P. A., Hurley, K., Grochocinski, V., & Kupfer, D. J. (1997). Treatment of major depression with psychotherapy or psychotherapy-pharmacotherapy combinations. *Archives in General Psychiatry*, 54, 1009–1015.



Race and Human Diversity

Sandra Jenkins

Pacific University

- I. The Rise of Multiculturalism
 - II. Multicultural Approaches to Psychotherapy
 - III. Multicultural Assessment
 - IV. Research Issues
 - V. Training Issues
- Further Reading

GLOSSARY

culturation The process by which a person learns, integrates and assumes the characteristics of a culture different from the person's original culture.

culture The sum total of human social organization, socialization, and learning.

ethnic group A group of people who share cultural norms and values and who identify with each other as a reference group different from other groups.

multiculturalism A branch of psychology that is based on the theoretical orientation that cultures are determining factors in the practice of psychology.

race A sociopolitical concept that describes a group of people who predominantly interbreed with one another and, therefore, share certain salient physical characteristics.

I. THE RISE OF MULTICULTURALISM

The field of psychology has evolved over time to include the dimension of race/cultural diversity as an area of professional competency. The American Psychological

Association, the American Psychiatric Association, and the National Council of Schools of Professional Psychology have included guidelines for cultural competencies in their written policies for practice and training. It was not always so. A recent survey of the PsycLit files showed a total of 19,418 references under the key term "cross-cultural." For the period between 1872 and 1950 there were 14 references cited, and most of these were rooted in anthropological origins. Then starting in the 1950s and 1960s the number of citations jumped to 863, and the numbers have continued to climb since then. This "burst" of interest coincides with the social reform movements during these periods, that is, the Civil Rights movement in the 1950s and 1960s and the women's and gay rights movements of the 1970s onwards. Clearly psychology as a field has responded to the forces of social change in the larger society.

There is no scientific evidence to support the existence of racial subgroups in the *homo sapiens sapiens* species. Physical anthropologists and geneticists have argued the point for over a century. Both definitions and typographies of racial groups have been difficult to establish. The reasons have to do with the distribution of genes in the human gene pool. No genes of significance are found in any human subgroup that are not found in all others. It seems certain that, after much scientific analysis, there are no human races, and yet the concept has had enormous social, economic, and political impact.

Since the beginning days of psychotherapy, problems have persisted when the client is an ethnic minority and

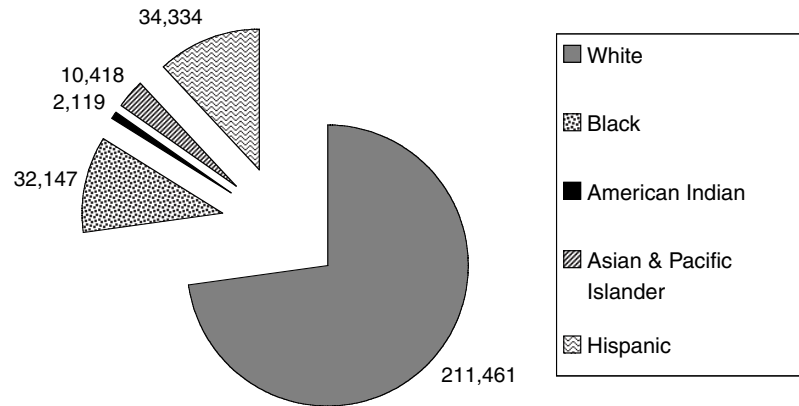

FIGURE 1 2000 population in thousands (U.S. Census Bureau).

the therapist is White. Eurocentric practitioners were prone to constructing improper judgments in diagnosis and treatment. For many years many minority clients were either misdiagnosed or treated with medications and hospitalizations in greater numbers than White clients with similar diagnoses. Many minority clients were denied psychotherapy because it was believed that they were either not verbally skilled or not intellectually capable of achieving insight into their psychological problems. Other studies have shown that minority clients do not present themselves for treatment as often, or drop out of treatment earlier than White clients. In many situations minority clients have been subjected to racial bigotry. Such bigotry is rarely intentional. Most therapists have been unaware of harboring racist attitudes and beliefs. Overall, the experiences of many ethnic minorities has been that psychotherapy has served as a means for furthering and promoting the “status quo” of the dominant White society. The prevailing dilemma is, despite the good intentions in the professional community, psychotherapy with ethnic minorities has frequently failed.

Efforts to solve the problem of ethnocentric psychology practices have been organized under the general category of the “multiculturalism” movement in psychiatry and psychology. Other terms have been used previously. “Cross-cultural,” “culture centered,” “inter-cultural,” “transcultural,” and “culturally sensitive” have also been used as terms to define the struggle to expand the awareness and skills of practitioners working with clients from different cultural backgrounds.

The multicultural approach grows out of the debates in anthropology, which saw the concept of “races” give way to the concept of “cultures.” From a “race” perspective it is clear that not all human groups are equal to each other and that some groups are subject to domina-

tion, extermination, and exploitation by other groups. When people are grouped in terms of “cultures,” the possibility emerges for equality and relativism. That is, each group can be seen as equally valuable and equally deserving of respect and dignity as any other group. Proponents of multiculturalism have been acutely aware that the population “complexion” of the United States is rapidly changing. The changing demographics, with increasing numbers of non-White groups leads away from previous “assimilationists” thinking toward “cultural pluralism.” (Figure 1 shows recent ethnic group figures for the 2000 census. Figures 2 and 3 are projections based on the 1990 census.)

The emphasis remains on ethnic minority clients, but the concept has also been extended to include many circumstances that place a person in a “minority position” in society. Clients who may be disadvantaged by their social position include persons from low socioeconomic backgrounds, women, gays and lesbians, disabled and elderly persons, certain religious groups, and immigrant/refugee clients. In other words, the multiculturalism movement potentially encompasses any clients who are not White, middle class, heterosexual, and mainstream in their social rank and values.

Multiculturalism addresses the failures of psychology to adequately treat diverse peoples, by positing that the cause of failure is the failure to fully realize existence of determining cultural factors. When client populations are viewed from a perspective of cultural/social determinism, a necessary set of questions arises. How does culture affect identity formation and pertinent social roles? What are the cultural factors that influence mental disorders? Are there culturally different norms for healthy or developmentally appropriate behavior? How does culture affect interpersonal behavior? Especially, how does culture influence the client–therapist relationship? How does

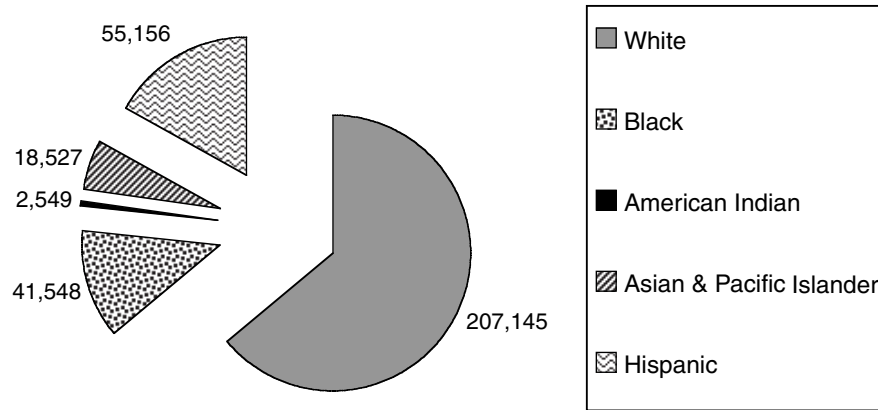

FIGURE 2 2020 projected population in thousands (U.S. Census Bureau).

culture affect help-seeking behavior? What are the implications for treatment and assessment?

Extending “culture” to include “diversity” means extending the concepts to include any significant social or environmental determinants that distinguish between dominant versus subordinate people. This means extending the same questions to incorporate variables, such as gender, age, socioeconomic status, and sexual orientation, and so on. How does a history of experiencing social oppression, discrimination, racism, sexism, and homophobia affect mental health and the development of healthy functioning? Again, what are the implications for assessment and treatment?

As the limits of ethnocentric practices became better understood, the multicultural thrust began to include development of cultural competence requirements for practitioners. In attempting to summarize various authors, a basic doctrine emerges throughout the literature. The multicultural position maintains that for therapists to be competent and successful:

1. Therapists must be knowledgeable about the history, beliefs, values, and norms of the client’s reference group. They must also be knowledgeable about each group’s status in relation to the dominant society.

2. The therapist must be mindful of the effects of social oppression and be willing to actively combat oppressive social forces.

3. To avoid pitfalls of bigotry and “cultural mismatches” the therapist must also be aware of their own cultural norms, beliefs, and values. They must be mindful of how their implicit cultural beliefs enter into and affect the therapy process.

4. The therapist must be aware of the ways in which their own worldview and the worldview of the client may be similar or different and accommodate the therapy to the client’s worldview as much as possible.

5. The therapist must have the skills to respond appropriately to the client’s verbal, non-verbal, affective, and cognitive cultural norms. This includes knowing and responding to culturally acceptable

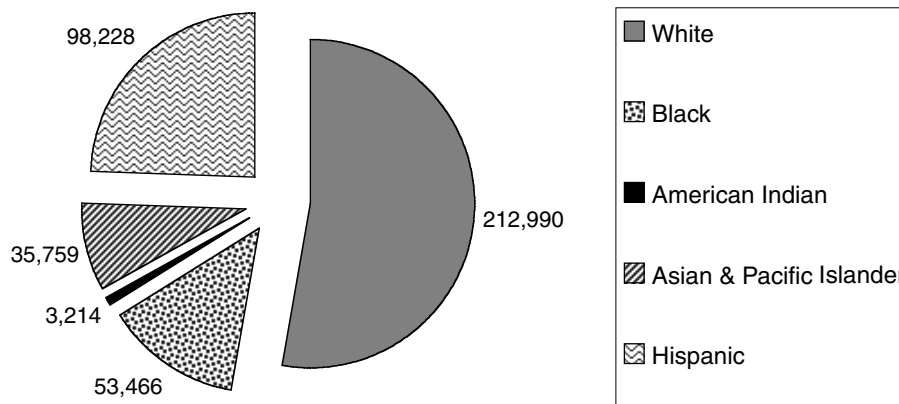

FIGURE 3 2050 projected population in thousands (U.S. Census Bureau).

norms for interacting with authority figures, non-family members, and strangers.

6. The therapist must possess knowledge of the cultural norms that govern asking for help and establishing a relationship.

7. The therapist must know the culturally prescribed expressions of different symptoms and must know how to accurately interpret and respond to the meaning of different affective and cognitive concepts.

8. The therapist must know the different cultural criteria for mental illness, as well as the criteria for healthy individual and social functioning.

9. Therapists must be knowledgeable of how cultural variables affect results of psychometric tests and measures. They must know which test instruments are suitable for use with which ethnic groups. They must be able to accurately interpret test results of various ethnic minorities.

10. Therapists must maintain an attitude of respect and valuing of each group, no matter how much that group differs from their own group. When therapists are able to maintain this attitude of "intercultural" valuing, both the therapist and the client can grow as human beings, developing from ethnocentric beings to a higher maturity of intercultural identities.

Based on a foundation of cultural relativism and pluralism, multiculturalists have attempted to establish new directions for psychology therapy practice, assessment, research, and training. To make psychotherapy culture sensitive, psychologists are encouraged to study the cultural norms of different groups, study specific personality traits relevant to each group, and explore developmental issues for each group. Culture-centered psychotherapies are also being developed. Assessment issues include test content, examiner bias, and culturally-competent test administration. A main focus of assessment is the degree of acculturation of the ethnic minority person being assessed. Identity development issues also play a strong part. The identity models that have been developed are generally consistent with one another. These models posit that ethnic minority identity develops along a series of cognitive stages. The stages begin with naive precontact with members of the dominant society and then some conflictual encounter leads to a rejection of the dominant society and an immersion into the ethnic group of reference. This stage eventually gives way to an autonomous/independence stage that eventually matures into a humanitarian/universal self. Research issues include problems with assessment, that is, reliability and validity studies of newly developed tests. Other important questions being studied are questions of operational-

izing cultural competencies and evaluation of culture-sensitive therapies. Training issues concern development of training models and evaluation of effectiveness of training programs. There are two problems that persist in making these efforts difficult. One is the fact that there is more within-group than between-group variance, and another is that the process of acculturation is a fluid and changing, not static phenomenon.

II. MULTICULTURAL APPROACHES TO PSYCHOTHERAPY

A. Ethnographies

Ethnography has flourished in anthropology as a research method. Anthropological data are collected in the field when the anthropologist spends long periods living within the cultural community being studied. By using native informants to describe, translate, and clarify cultural beliefs, rituals, practices, values and norms, the anthropologist strives to understand unique and universal cultural realities. Two kinds of ethnographic data are used. Emic data are gathered directly from informants and are particular to the culture being studied. Etic data are the translation of emic data to universal cultural principles.

Various authors have presented ethnographic-based studies as one approach to culturally-sensitive psychotherapy. By adapting ethnographic descriptions of different ethnic groups, psychologists have utilized what might be called applied ethnography. The groups most represented in the literature are groups with the greatest increases in numbers in the U.S. population. Many applied ethnographic studies encompass African Americans, Asian Americans, Hispanic Americans and Native Americans. Other groups include immigrants from Eastern Europe and the Middle East.

When applied ethnographies are used for formulating treatment approaches three caveats are repeatedly emphasized:

1. Within-group variables are often larger than between-group variables.
2. The therapist must determine the extent to which cultural norms apply to the individual client.
3. Individual clients depict different social adaptations, identity formation stages, and acculturation issues.

1. Applied Ethnographies

a. African Americans. When working with African American clients the therapist must be knowledgeable

about the impact of history. African Americans have had to struggle through slavery, in all of its brutal aspects, and racist attitudes toward Blacks continue in the larger society. Although there has been improvement, there are still crucial links between racism and poverty that affect large numbers of Blacks. Poverty rates are higher for Blacks than for Whites. Among lower-class Blacks, 70% of households are headed by single females. Black teens face an unemployment rate of 50%, and many are subjected to violence, including homicides. Black teen suicide rates are increasing.

African Americans often live in poor neighborhoods where substandard housing, crime, and violence are prevalent. Schools located in impoverished neighborhoods can be poor environments for learning. This combination of social problems leads to high levels of stress and higher incidence of both physical and mental illnesses associated with stress. Many lower-class Blacks, especially teenagers, feel that there is not much hope for a better future.

Since slavery, European physical characteristics have been preferred among many African Americans. Caucasian features such as light skin color, straight hair, thin lips, and light eye-color have been symbolic of higher status and greater attractiveness than African Americans with more African physical features. These preferences can cause social, economic, and interpersonal conflicts among African Americans. Although there were significant changes in these attitudes during the 1960s and the Black power movement, residual physical characteristics issues can cause additional stress and self-esteem problems.

Basic values present in Black culture include sharing responsibilities, respect for parents, pride in heritage, spirituality, and strong family ties. Many single women raise children with the help of extended family, boyfriends, and family friends. There is no empirical evidence that Black children raised in fatherless homes suffer from lower self-esteem than children raised in two-parent homes. Black churches have been a central source of community support since the days of slavery. In many Black families, whether headed by one parent or two, children often take on adult-level responsibilities at an earlier age than White children. African American men and women have traditionally shared domestic duties, with women working outside the home and men participating in child care and household tasks.

(1) *Within-Group Differences.* There are approximately 32,147 million African Americans in the United States. The majorities of Blacks are actually bicultural and have been able to adapt to living in a generally hostile domi-

nant society. One third of Black Americans are middle class or higher. Most of these African Americans live in two-parent families and are pursuing lifestyles similar to European Americans. Yet, certain stressors are associated with the Black middle class. Job stress can come in the form of feeling that one has to compromise one's Black values to fit into work settings that are dominated by White values. Some middle-class Blacks must cope with racist attitudes at work, such as less chance for promotion or lower salaries than their White counterparts. There is some evidence that marital stress and alcohol abuse are often factors related to job stress. Middle-class Blacks do embrace White middle-class values to a larger extent than poor Blacks, but they are often victims of the stressors inherent in a bicultural lifestyle. Many middle-class Blacks live in predominantly White suburban neighborhoods and send their children to mostly White public and private schools. Yet, many of these African Americans seek out activities within the Black community to instill pride in heritage in their children.

(2) *Treatment Approaches.* Due to a history of racism many Blacks, especially Black families, are reluctant to seek outpatient mental health services. Despite such reluctance some studies show that people in Black communities do have knowledge of what is involved and expected in mental health centers and do believe that therapy can be helpful. Reluctance to seek services is usually based on the fear that White therapists will not understand the realities of African American racial oppression. Others have difficulties with transportation or child care arrangements. Many Blacks, especially those who have assumed adult responsibilities at an early age, are taught that they should take care of their own problems and are reluctant to ask for help.

Establishing trust is the most crucial aspect of forming a therapeutic alliance. There is no research support for matching Black clients with Black therapists as a therapeutic necessity. Trust is best established when the therapist behaves in a way that conveys honesty and sincerity and when differences in education and social status are not flaunted. It is important to provide straightforward answers to questions. The therapist should be easy to talk to but should avoid the pitfalls of "color blindness" and "paternalism" or feel that it is necessary to "buy into" a victim's stance. It is sometimes necessary to confront and challenge the client's thinking and beliefs if they are self-defeating or maladaptive.

In most therapy situations the Black client's attitudes and behavior in therapy are more likely to be determined by social class, personal experiences, and education status than by racial concerns. When a Black client

behaves in a manner that is hostile, apprehensive or nonengaging it should not be assumed that the problem behaviors are racially motivated. To discover the basis of the problem it is necessary to distinguish between racial hostilities and fears versus the manner in which the therapy is being conducted.

Most authors agree that the White therapist must be open to initiating a conversation about racial differences within the beginning sessions. A frank, non-defensive discussion about the client's feelings and concerns, if there are any, suggests to the client that candid talk about racial matters is an acceptable part of the therapeutic process. Others suggest that it would be more prudent for the therapist to wait for the client to bring up the subject. In any case, the therapist must be prepared to discuss racial difficulties as openly as possible with Black clients.

It is also important for the therapist to pay attention to the possibility of practical problems. Black clients may need help with survival skills: finding employment, seeking further education, coping with crime and poor housing in their neighborhoods, and so on. The therapist may have to accommodate the therapy process to transportation and child care problems. It is best to be flexible and willing to negotiate scheduling, and fee arrangements that allow the client to attend sessions and pay for sessions in a way that works best with their job and family situations.

The client's family life should be explored and evaluated as part of the therapy process. It should be noted, however, that the Black family should not be evaluated in terms of healthy or desirable White family values. Healthy Black families have adapted to very different circumstances, and the healthy functioning of the Black family should be evaluated in terms of those norms. Family therapy work, including parenting training, can be constructive. It is also advisable to include the client's spiritual community.

Therapy should include exploration of the client's personal experiences with racism and the ways in which they have attempted to cope with it. Including extended family members and community and church resources can also augment therapy. There is evidence that African American clients, overall, respond best to a problem-focused, brief, cognitive-behavioral treatment approach. There is also evidence that African American clients respond favorably to a directive and educative approach to problem solving.

b. American Indians. The cultures of the American Indians were transformed dramatically with the arrival

of Europeans. From 1492 until 1790 a series of disease epidemics greatly reduced their numbers. During the period from 1829 until 1890, a series of wars, White settlers claiming American Indian lands, and relocation of American Indians onto reservations were sources of further population devastation. It has been estimated that by the turn of the 20th century that the American Indian population had been reduced by over 90%.

The policy of the U.S. government has been to think of American Indians as a group to be "managed." Thus, the plight of American Indian cultural life has been governed by a series of treaties and laws, with the federal government. Until 1887 laws were designed to force American Indians onto reservations, prevent the practicing of their cultural traditions, and force a policy of assimilation into European culture. Thousands of American Indian children were routinely taken from their families and placed into boarding schools or adopted by White families. The subsequent loss of American Indian children from tribal communities is estimated at 25% to 55%. Traditional cultural practices, including religious ceremonies, were discouraged or forbidden. The policy of seizing American Indian lands continued into the 1920s, and the practice of placing American Indian children into boarding schools and other institutions continued until the 1970s.

American Indians were not granted U.S. citizenship until 1924, however, at this point racist policies gradually began to change. The 1934 Indian Reorganization Act terminated much of the federal controls over American Indian life, but many American Indians were relocated to urban centers where they were beset with expanding unemployment, welfare, and alcoholism. In 1955 the Indian Health Service was formed and established the Mental Health Services in 1969. In 1978 the Indian Child Welfare Act became the means to halt the seizing of children from American Indian families. The American Indian Religious Freedom Act of 1978 protected religious practices. With these recent legal freedoms has come a resurgence of interest in reclaiming cultural roots, with increasing numbers of American Indian peoples attending powwows and other cultural heritage events and ceremonies.

Depending on the political perspective, different terminology can be used when addressing this group of Americans. The term "Indian" began when European explorers thought they were in the Asian country of India and named the Caribbean tribes "Indians." Correcting this problem the term Native American became preferred. Native American, however, also has the problem of not distinguishing between native peoples

and those Europeans whose ancestors settled in America before the 1700s. Generally, the term American Indian is used, despite its negative political connotations. In Alaska, the term Alaska Native is preferred. Really correct, is to address an American Indian person by his or her tribal or clan name, because personal identity usually acquires from the tribal affiliation, then extends to include the entire group of American Indian nations and finally extends to the larger U.S. citizenship.

In traditional American Indian society bonds within the tribal group and harmony with nature and others in the group are primary values. Giving and sharing with others is a major source of status in the group. One strives to maintain balance between the natural, human, and spiritual worlds. American Indian values predispose American Indians to have difficulty in situations that reward individualism, control over others, competition, verbal aggressiveness, and talking openly about personal problems with strangers. Prolonged eye contact can be interpreted as aggressive, but prolonged silence is tolerated. Shaking hands should be slight contact, not a firm grasp.

American Indians have the highest high school dropout rate of any ethnic group. Basic problems for many American Indian clients are problems with the loss of the family, isolation from the tribal group, poor education, depression, alcoholism, and underemployment.

(1) *Within-Group Differences.* Today there are approximately 2,119 million American Indians living within the United States. Estimates of the number of federally recognized "entities" range from 505 to 517; the number of state-recognized tribes is cited as between 304 to 365. There are approximately 200 to 250 tribal languages still being spoken. Yet, the definition of who is an American Indian is somewhat problematic. The U.S. Census Bureau figures are based on self-report, and the numbers of people reporting American Indian ancestry is increasing at a rapid rate. The Bureau of Indian Affairs and different tribal organizations have different systems based on percentages of blood ancestors; therefore, it is difficult to get a firm fix on the actual group numbers.

Vast differences exist within American Indian groups, including regional differences. It is important to remember that American Indian tribes populated the entire American continent. Tribal customs and languages varied considerably between in the eastern, southern, western plains, and northwestern regions of the country. Cultural worldviews vary from ethnocentrically isolated families who live mainly on reservations, to bicultural families who reside predominantly

in urban areas, to acculturated families who may never have set foot on a reservation and have few connections to other American Indians in their daily lives.

Problems can occur with bicultural lifestyles. Many American Indians seeking work and education leave the reservations to live in urban areas. They may feel isolated from their families and cultures. Additional problems exist between generations as younger American Indians acculturate to European lifestyles and values. Younger generations may feel that they have little in common with older, more traditionally oriented parents and grandparents, thus causing further deterioration in family bonds.

(2) *Treatment Approaches.* It is a well-known fact that American Indians underutilize mental health services. This is true for three reasons. Many American Indians do not know about the existing services, there are few existing services and many distrust the reception and responses they will receive when they seek services. Several studies show that, on the whole, American Indians came to one therapy appointment and did not return for a second. Many American Indians fear that they will encounter a power difference that will amount to more forced assimilationism of European values. Many American Indians prefer to seek the services of traditional American Indian healers because, aside from the fact that they are probably effective, they are seen as the "keepers" of their cultural heritage.

When treating an American Indian client it is important for the therapist to understand the crucial necessity to spend sufficient time getting to know the client. It is important to establish a bond based on the degree of acculturation of the client. The therapist should take the lead to establish the structure and then proceed toward gathering personal history information. Questions about family relationships, education, employment, and where the client usually resides help to gauge the extent of acculturation. On the other hand, it is important to avoid prying too deeply at first, and avoid lengthy personal questions as well as lengthy questionnaires and agency forms. The therapist can encourage trust building by being willing to disclose information about themselves, as long as it is not too personal in nature. In American Indian culture words are considered important and lulls in conversation are not only acceptable, but also preferable to banter. The therapist should not expect the client to engage in emotional demonstrativeness, introspection, or self-examination. The therapist should take a directive but slow approach, allowing the client to pace the interview.

It is best to build a positive social support relationship. This can include family and friends who are available for participating in the therapy process. It is also advisable to inquire about use of traditional healers and to include those resources where appropriate.

The therapist should be willing to arrange flexible appointment times and be available for crisis interventions. American Indian clients might present a concrete problem at first to gauge the degree of social support and interpersonal bonding. When working with American Indians the therapist should be willing to bond with clients and their families. Connecting to clients outside the therapy structure is more important with this group than with any other.

Therapy approaches that appear to get the best results consist of social learning, behavioral, and family systems orientations. Teaching social skills, assertiveness skills, alcohol and drug education, suicide prevention, and parenting skills are effective and desirable treatment methods for American Indian clients. A homogeneous (only American Indians, separated by gender) group therapy can be especially helpful. The group should include pleasant and traditional activities. In a group approach elder American Indians can provide wisdom and guidance.

c. Asian Americans. Asian Americans are the fastest growing minority group and have the largest within-group variance. The Chinese began arriving in the 1840s to work on the railroads and gold mines. The Japanese began coming to the United States in the 1890s to work in the agrarian economies. Both groups soon encountered racist attitudes and were the victims of violent assaults, especially when work was scarce for White workers. The Federal Chinese Exclusion Act of 1882 banned immigration of Chinese. The Act was not repealed until WWII. In 1941, shortly after Pearl Harbor was bombed, Executive Order 9066 made Japanese Americans political prisoners. Japanese citizens were ordered into internment camps with no evidence of espionage or subversive activities. The Immigration Act of 1965 lifted restrictions on Asian immigration, and in 1988 The Civil Liberties Act offered reparations and apologies to Japanese Americans.

South East Asians have been arriving in large numbers since the mid-1970s. Many of the earlier 1970s immigrants were middle-class, educated Vietnamese, many of whom had worked for the U.S. government. Later South East Asian immigrants were poorer, and many were refugees escaping oppression after the fall of Saigon and the rise of the Cambodian Pol Pot

regime. Many of these refugees have been victimized by pirates and subjected to brutal rapes, murders, and robberies. Many refugees have spent months and sometimes years, in refugee camps before arriving in the United States.

Ancient values based on Confucian and Buddhist thought are predominate moral and social codes in the cultures from Asia. Strong emphasis is placed on filial piety (respect, obedience, and loyalty for parents and other authority figures), emotional reserve, harmony with others, hard work, self-sacrifice, and endurance. Fathers are the respected heads of the family and mothers provide domestic nurturance. Fathers are to be obeyed by the children, including adult children, and mothers have a more supportive role. Interpersonal harmony is maintained by speaking indirectly around the point, rather than direct confrontation. Because expression of intense feelings is considered inappropriate, it has been theorized that Asian Americans tend to present with somatic symptoms, rather than emotional concerns.

Proper individual behavior and personal shortcomings are regulated by shame and guilt. Conformity to the group is valued and is also a way of avoiding being shamed or "losing face." Personal problems are kept in the family, because to reveal them to the community places people at risk for feeling shamed. There is strong parental pressure exerted on children to be successful. A poor work or achievement performance can result in intense feelings of shame and guilt.

(1) Within-Group Differences. There are approximately 10,418 million Asian Americans. The subgroups are numerous with large variations in history, culture, and languages. The largest subgroups are Chinese, Filipinos, Japanese, Koreans, Vietnamese, and Cambodians. There are also substantial numbers of Hmong and Laotian citizens. Percentage wise more Asian Americans have college degrees than any other minority group. The median income is the highest of any group, including Whites. Yet, one half of Asian Americans are poor and undereducated. Urban ghettos, such as "Chinatowns" are often filled with poverty.

Some Japanese adults whose parents or grandparents were interned are often coping with the shame that the family experienced. Family members often refuse to talk about their internment experiences because of the shame and because talking about intense feelings is not culturally appropriate. Such suppression of feelings can lead to symptoms of anxiety and depression.

Many immigrants and refugees face problems with language barriers and with learning to fit in socially.

Pressure to acculturate is always in conflict with loyalty to family and cultural values. Recent immigrant children can face difficulties at school. They are sometimes subjected to racist attacks and ostracization. Children typically acculturate faster than adults, thus, Asian American children are often bicultural and speak native languages at home and speak English in school. This leads to intergenerational stress problems, which are difficult to deal with, especially when the children speak English and the parents do not. As children become acculturated they are often in conflict with values of strict obedience to authoritative parents. Problems with anxiety, loneliness, depression, and a sense of “not belonging” are common mental health concerns.

Many recent immigrants and refugees practice traditional healing methods of Chinese medicine, herbalists, and cope with evil spirits with coin rubbing. It has happened that Vietnamese parents were accused of child abuse when their son appeared at school with bruises on his torso. The school officials did not realize that well-meaning parents had rubbed his body with coins to heal his troubled spirit.

(2) *Treatment Approaches.* There is some evidence that Asian Americans underutilize mental health services. The problem appears to be fear of stigma and conflicting cultural values. When working with an Asian American client the degree of acculturation is a crucial consideration. If the families are recent immigrants or refugees, care should be taken to not offend and to behave in ways that are considered respectful and proper. Respect for authority is important in Asian culture, so the therapist should take an active, directive, teaching role. The therapists must show themselves to be credible and trustworthy. Many South East Asian clients expect concrete problem solving and advice giving. The therapist should be aware, however, that though they may offer advice it may not be followed. The therapist should not expect clients to talk about personal problems and personal feelings in an open fashion, especially in the beginning stages of therapy. Asian American clients often experience feelings of shame for having personal difficulties that require professional help and for bringing problems to a non-family member.

Language difficulties must be considered as well. Much literature has focused on the need for interpreters, but the results are mixed. Use of interpreters is generally discouraged unless they have been extensively trained in the proper role of an interpreter in a therapy context. It is not wise to use children or relatives as interpreters. A bilingual therapist is best, if one is available.

Major immigrant therapy issues include feeling socially isolated, struggling with gender and intergenerational adjustments in a new culture, and learning to adapt to new ways. Recent immigrants are often lonely and have lost loved ones or have lost social status by having to flee oppression. Japanese Americans may need encouragement to talk about the family internment history. South East Asian immigrants may need to talk about the traumas of refugee camps and victimizations by pirates.

Family therapy is advisable to deal with intergenerational problems if acculturated adolescents and traditional parents are not getting along. It is wise to show deference to the father, at least in the first session. It is never wise to insist that Asian adolescents, or adults, defy their parents openly. Acculturation takes time, and families can be helped to adjust if they are given hope for the future and a realistic sense of the amount of time it takes to adjust. Where possible, normalize problems to reduce feelings of shame.

d. Hispanic Americans. Hispanic Americans are growing rapidly in numbers. Due to high birth rates and a flow of immigrants, these Americans are the second largest minority group. The term Hispanic applies to all persons of Spanish-speaking descent. Other terms are in current usage including Latinos. Mexican American and Chicanos, are also common terms. Hispanic applies to a diverse group of peoples originally from Mexico, Puerto Rico, Cuba, and a number of Latin American countries, including Guatemala, El Salvador, the Dominican Republic, Honduras, and Nicaragua. The largest subgroups are Mexicans, many of whom have resided in parts of the southwest before the area became part of the United States in 1848, Puerto Ricans, who have been U.S. citizens since 1917, and Cubans many of whom have fled the Castro regime since the 1950s.

The history of Hispanics is filled with colonization and religious conversions. Many Mexican Americans have been victimized by racist policies, especially in the southwest. Many Hispanics are poor, with a median income below the national average. Migrant worker children drop out of high school at a rate of 50%, the second highest dropout rate.

Hispanics place great importance on the extended family and most live in two-parent families. Males are expected to value machismo, which has come to have many negative connotations, but has many positive ones as well, such being chivalrous, courageous, respectful, and protective. Men are heads of the household and are

expected to be responsible providers. Women are taught to value *marianismo*, which means high moral virtue. Indeed, women are expected to set the moral standards for men. Boys are expected to be independent, but girls are often restricted by the close supervision of their families. Children assume adult responsibilities at an early age, for working and helping to raise younger children. The influence of the Catholic church is strong. It has been theorized that part of the church influence is that many Hispanics believe in the inevitability of fate and may display resignation during hard times or when faced with personal problems.

(1) *Within-Group Differences.* There are approximately 34,334 million Hispanic Americans in the United States today. Hispanic Americans live in diverse places. Most Mexican Americans live in the southwest, Puerto Rican Americans reside mainly in urban areas of the east and Cubans tend to reside in the south, especially Florida. Cuban Americans have the highest incomes, and Puerto Rican Americans the lowest. Rates of acculturation vary greatly. Some Hispanics are monolingual for English, some are monolingual for Spanish, and many are bilingual. Recent immigrants may have little knowledge of English. Intergenerational problems, including conflicts about gender roles, are family problems associated with acculturation. These problems appear less often if the family is middle class or not Catholic. Less acculturated Hispanic families also experience adjustment and educational problems with children in schools, especially where English is the dominant language.

After centuries of intermarriage with American Indians, Blacks, Europeans, and Asians, Hispanics show a wide variety of skin colors. Each skin shade has its own term and relative status. Since the Spanish colonizations, lighter-skinned children are preferred in some groups. Such preferences, however, are not a given.

(2) *Treatment Approaches.* Hispanics historically underutilize mental health services. The reasons appear to have to do with language barriers, seeking help inside the extended family and concerns about conflicting values. Many Hispanics first seek folk healers—the *curandera*. Many may use folk healers and professional healers simultaneously. Common mental health concerns include acculturation adjustments, alcoholism, drug use, and intergeneration family conflicts. Poverty is also a concern that should be considered.

The therapist should assess the degree of acculturation as a first step in the therapy process. The therapist should learn how to properly pronounce Spanish

names and address people using their last names, at least in the first sessions. A therapist should also offer non-intimate self-disclosure to establish trust and to forming a working alliance. If the client offers a gift it is rude to not accept it.

Many Hispanic clients expect the therapist to offer suggestions that are practical and problem-solving oriented. Hispanics may think that therapy will be brief or perhaps only one session, so it is good to offer suggestions by the end of the first session. Problems with racism and identity formation should be explored and discussed. It is also advisable to address practical problems with jobs, food, clothing, and housing. The therapist should make flexible arrangements for session times, and be flexible if the client is late, misses appointments, or needs transportation.

Because of the importance of family ties, a family systems approach can be effective with Hispanic clients. Because of the emphasis on family cohesion and hierarchies, Structural family therapy is preferable to other approaches. It is important that the therapist show the family proper respect. Address the father first in the initial sessions.

Language problems must be dealt with. The literature is mixed concerning the use of interpreters. Some Hispanic clients resent the intrusion of a third party, whereas others feel that providing an interpreter is sign of caring about and respect for the cultural differences. A bilingual, bicultural therapist is preferable, if one is available.

Behavioral approaches tend to work best. Behavioral orientations have the cultural fit advantage of being goal oriented, action, rather than feeling oriented and here-now oriented, as well as brief. Social skills training and systematic desensitization are effective treatments for clients suffering from the stress and anxieties associated with making social adjustments. These are also methods associated with empowering clients and helping them to make changes in their adjustments to the new environment. Assertiveness training can be helpful for some clients, but with women clients the therapist should take care to not encourage role difficulties that make the client alienated from their families and cultures.

III. MULTICULTURAL ASSESSMENT

When assessing intelligence, achievement, and personality the psychologist is proceeding incompetently if certain culturally determined moderator variables are not taken into account. The major moderator variables that must be considered are acculturation, identity

development, values, and attitudes toward the larger society. Misdiagnosis and misguided treatment failures are common problems when working cross-culturally. For example, two of the most widely used personality tests—the MMPI–2 and Rorschach—were standardized using a majority of European participants. Subsequently, the tests are used as etic measures, when in fact they are emic measures. That is, they are culturally specific in their underlying constructs and test designs but are being applied throughout the world in mental health settings as if they are measuring universals.

Cross-cultural application of culture-specific tests is prone to errors in predictive validity and reliability. It has also been demonstrated that ethnic minorities as a group show more pathology and have lower performance scores on all known psychometric and intelligence tests. Generally, when persons are unacculturated and have been poorly educated, especially combined with low social economic status (SES), then test scores show more pathology or lower intelligence.

The problem of test bias has yet to be solved. Instrument bias occurs when the test is designed in a way that the task is unfamiliar to the test participants. For example, some cultures do not have familiarity with pictorial tests, such as the Rorschach. It is then difficult to know whether the Rorschach scores are a result of the internal processes of the participants or their lack of knowledge about the test stimuli. Construct bias is a problem when the test does not have equivalent constructs in the other culture. It may be impossible to create a “culture-free” test, but it is also very difficult to construct a “culture-fair” test. For example, the MMPI–2, does not measure constructs like “face” or “harmony,” both of which are immensely important social variables in Asian cultures. Moreover, it is not clear if concepts such as “depression,” “guilt,” “aggression,” and “filial piety” are equivalent across cultures.

Language barriers are also a source of bias. Translations of the MMPI–2 may not provide cross-cultural accuracy, especially if the test is translated directly, (i.e., with one interpreter of the second version). The only method that appears to have language accuracy is back translation, where two interpreters are used. One interpreter translates from the first language into the second language, and then a back interpreter translates back into the first language. When the third translation matches the first, then accuracy of the second language version can be assumed.

Examiner bias is also a concern. If the examiner harbors a preference for Eurocentric, assimilationist thinking, then test administration and interpretation may be biased. Eurocentric norms can be applied to clients, and

the given assumption is that any deviance for European norms is pathological. For instance, the examiner commits the error of functional bias if aggression is given a pathologic score for peoples for whom aggressive behavior is the norm in certain situations. Another example is to assume that the client is being negative, noncooperative or inept if they do not self-disclose in the assessment interview. Such behavior may be determined by the client’s culture, values conflicts, the situation or the examiner’s behavior, or all of these.

Multicultural research with the existing tests has been conducted for many years. Results are mixed. Research has also mainly focused on comparisons of African American tests scores and has not progressed very far with other ethnic minority groups. Research on the MMPI–2, for instance, has shown mixed results. Some authors report group differences comparing *T* scores of African Americans and White participants. Other authors, matching and controlling for social class and education background, found no significant differences between the two groups.

Accuracy in assessment outcomes can only be accomplished by first, assuming that cultural moderator variables are present, unless it is possible to rule them out. Second, the examiner has been carefully trained in recognizing the impact of culture on the testing and interview situation. Third, the tests themselves must be either altered to become culture sensitive or the norms of each group must be known or calculated. Fourth, and probably most important, the degree of acculturation of the client must be determined and the assessment process should be guided by this variable. Finally, test selection, administration, and interpretation should proceed only after all of these considerations have been met.

Few culture-specific intelligence and personality tests have been constructed, but existing tests are being researched for cultural accuracy, and new tests are under construction. Some researchers are working on developing truly etic, (i.e., universal measures, but these are not well developed yet). A number of culture-specific tests do exist to measure acculturation. Of the tests surveyed all were found to have adequate reliability and validity. Despite advantages of using these measures, they are currently used mainly for research purposes and have not become widely used for clinical work.

A number of scales exist to measure the attitudes, values, identity formation and degree of acculturation for different groups. Others measure acculturation and identity formation across groups. The number of existing scales is too numerous to offer a complete review here. Some scales that are gaining in recognition are

measures specific to African Americans, and those have concentrated on developmental issues of identity and racial attitudes, rather than acculturation, because most African Americans are bicultural. The Racial Identity Attitude Scale (RIAS-B), the Black Identification Scale (BIS), and the Developmental Inventory of Black Consciousness (DIB-C) and the Black Personality Questionnaire (BPQ) are examples of measures currently available. Some measures of White identity have also been developed. The White Racial Identity Attitude Scale (WRIAS) and the White Racial Consciousness Development Scale (WRCDS) are currently in use.

Some measures are designed to measure degree of affiliation and the degree of acculturation with a specific group. Some examples include, the American Indian Self-Identification Scale, the Acculturation Rating Scale for Mexican Americans (ARSMA-II), the Measure of Acculturation for Mexican Americans, the Bicultural Involvement Questionnaire (for Cuban Americans), the Suinn-Lew Asian Self-Identity and Acculturation Scale (SL-ASIA), the Ko Mental Health Questionnaire (KMHQ), and the Chinese Personality Inventory (CPAI).

Other scales are designed for multiethnic use. These include, the Multigroup Ethnic Identity Measure (MEIM), the Bicultural Inventory (BI), the Acculturative Balance Scale (ASC), and the Scale of Effects of Ethnicity and Discrimination (SEED).

Some measures are being developed to assess the competencies of the mental health services and counselors. The Agency Cultural Competency Checklist, the Multicultural Environmental Inventory (MEI), and the Institutional Racism Scale (IRS) are available for agencies and degree programs. The Cross-Cultural Counseling Inventory-Revised (CCCI-R), the Multicultural Counseling Knowledge and Awareness Scale (MCKAS), and the Multicultural Awareness-Knowledge-and-Skills Survey (MAKSS) are measures of the cultural competency of the therapists.

It is still an important question, however, as to how to measure acculturation. Acculturation is not static, levels of acculturation change over time. Another problem is that there are such great variations within groups that the validity of any group measure can be questioned. There are also wide differences between different regions of the country, and between urban and rural residents. Persons may also be totally unacculturated (speaking little if any English and spending little, if any time in the larger society, bicultural (speaking both English and their native language or dialect and spending equal amounts of time in both cultures) or totally

acculturated (speak only English and have little, if any contact with their native culture). How do these different levels, with many points in between, become accurately measured? Moreover, it is possible for an individual to have multiple identities, depending on the situation and the reference group. At present, until these problems are resolved, it is considered preferable to use available measures despite these difficulties.

IV. RESEARCH ISSUES

Research in multicultural assessment and practice has been moving along steadily, but much remains to be done. There are still at least five important problems to be addressed.

1. More information is needed on the epidemiology and prevalence of disorders in ethnic minority populations.
2. Further outcome data is needed to answer the questions as to whether or not alternative culture-sensitive therapies are actually more effective with minority clients.
3. Further research on usage patterns is needed to explain the mixed information existing in the literature.
4. More empirical studies are needed to evaluate ethnic-specific assessment instruments.
5. More work is needed on ethnic minority identity development and formation.

Not much is known on incidence and prevalence of various disorders. This is partly true because most studies have been carried out either in hospitals, where only limited diagnostic data is obtained, or in community mental health settings, with few minorities presenting for therapy. As has been pointed out, a lack of help seeking should not be equated with a lack of mental health problems. The research on usage is inconsistent. Many studies show that ethnic minorities tend to underutilize mental health services but other, more recent studies, show that some minority groups are utilizing services at a comparable rate to White clients.

Controlling for the different variables that affect mental disorders is not an easy task. In fact, it is very cumbersome. For instance, much has been written about the linkage between SES and mental illness. It is, therefore, important to have some consistency between studies as to how SES is determined. Should the criteria be the income of the head of the household, or occupation of the head of household or total extended family financial re-

sources? Studies are being conducted using different criteria. How do these inconsistencies between studies affect the research results and conclusions? It is also difficult to get broad research participation in some minority communities, due to a historically based lack of trust between minority peoples and the larger society.

Most of the ethnic-specific instruments have been developed using college students. Analogue methods for test construction and clinical training have been shown to have drawbacks. Again, under these circumstances there can be confounds between power-level discrepancies, SES, gender, the acculturation of the participants and the constructs being measured. Test instruments need further norming within client settings and among the general populations of ethnic minorities. Questions of equivalence must be addressed. Are the tests measuring the same constructs? The cross-cultural equivalence problems with existing instruments are well known, but construction of truly ethnic measures will be a daunting task. Large sample sizes are needed, and these are hard to acquire. It will also be necessary to compare across more than two cultures, as well as controlling for the usual variables of age, education, SES, and so on. A particularly difficult problem concerns different meanings attributed to words in different cultures. More rigorous control for use of language, especially in personality tests, is required.

If alternative methods are more effective, the question then is which particular methods and with which ethnic groups? If alternative methods are not more effective then why not? Treatment satisfaction results are mixed. Most studies reviewed here report that minority clients prefer a directive approach. However, some studies dispute this, showing a preference for non-directive approaches. More research is needed on insight-oriented therapies, especially those that are conducted with culture-sensitive modifications. Given the present state of the research it cannot be assumed that insight therapies are not effective with ethnic minority clients. Nor, for that matter, can it be assumed that only directive/behavioral therapies are preferred. More is needed on effectiveness of ethnic and gender matching. Again, studies are mixed in the results obtained. Some studies show that minority women and men differ in their preferences on this dimension.

Bicultural identity development research work is barely beginning. As the demographics of the U.S. population change, more people are self-reporting biethnic or mixed ethnic identities. Minority and White identity development models need further clarification and research on the connection between identity formation

and the therapy process. Definitions of ethnic identity must be widened to include persons who claim multi-ethnic or multicultural backgrounds.

Possible explanations for research results discrepancies include the following:

1. The variables being tested are not specific enough. In particular, the linkages between SES, gender, and treatment satisfaction have not been consistently controlled.

2. The acculturation levels of clients is another crucial variable that has not been adequately controlled for.

3. Many studies have been based on an entire ethnic subgroup, (i.e., Asian American or African American, or Hispanics, or even non-White vs. White clients, etc.). Studies such as these are not conducted with sufficient regard for the enormous within group differences.

4. Cultures are not separate or static. Whenever different ethnic groups encounter each other a series of mutual cultural exchanges and influences begin that forever alter the participants. This cultural exchange variable, while always present, is difficult to isolate.

V. TRAINING ISSUES

Many psychologists feel reluctant and ambivalent about treating poor and minority clients. The essential questions for training programs are "What happens when a therapist encounters a client who is different?" "Is the therapist able and willing to engage in conversations that are meaningful to the client?" This would include participating in appropriate discussions about group inequalities and the painful experiences of people who have been subjected to oppressive social conditions. Given our nation's history, the very subject of racial and social class relations is loaded with conflictual, painful, and anxiety-provoking content. These subjects have been treated as taboo topics, with little substantive conversation in the media or in school settings. Most psychologists are from White and/or middle-class backgrounds. They have had little, if any, experience living or working among poor or ethnic minority peoples. Their own degree of unfamiliarity can be felt as a barrier to forming meaningful therapy relationships. Furthermore, the topic of multicultural practice is loaded with complex concepts, complex skills and a long list of behaviors that a psychologist is expected to master. The prospect of becoming multiculturally competent can feel overwhelming.

Given the difficulties inherent in the subject matter, combined with the rapidly changing demographics in

the country, it follows that graduate degree programs must step up their training efforts in multicultural practice. Up-to-date information on the curricula of degree program offerings in multicultural training is sketchy. What is apparent is that some programs offer specific courses, practica, and workshops, and so on, while other programs offer little, if anything, specifically designed to train graduates in this area. Some programs focus on specific cultural groups, that is, training in working with African Americans or working with American Indian clients, and so on. Others take a broad-based approach. In some programs multicultural training is a degree requirement, in others training is an elective.

The literature reviewed here is consistent on the viewpoint that effective training models should strive to integrate four major goals:

1. Increasing awareness of the student's own and other people's cultural norms.
2. Increasing specific cultural and clinical knowledge about different cultural groups.
3. Developing skills about how to interact effectively with peoples who are culturally different.
4. Consciousness raising about how cultural differences affect the therapy process and learning to become comfortable with those differences.

Training should also be comprehensive enough to cover cognitive, behavioral, and affective learning.

Course work in a didactic format with lectures, discussions and term papers, and so on, is mainly viewed as a beginning platform to which other components are added. Specific knowledge about cultural groups, their histories, cultural norms, and so on, can be conveyed in this format. There are so many different groups, however, that programs should offer several subcourses that offer in-depth knowledge about different groups and the clinical issues associated with each. It is unlikely that a single comprehensive course can be designed to do justice to this entire topic.

Other goals intended to increase awareness and skills can only be achieved through combining multiple learning techniques. Increasing self-knowledge, including learning about one's own cultural norms and assumptions, is a crucial component. How to train students in this aspect is still being developed. The Pedersen Triad model is an example. In this model students role play working with a culturally different client while an "anticounselor" voices the negative thoughts of the client and the "procounselor" voices the positive thoughts of the client. This training technique is intended to bring to light the differences between the

client and the counselor and to enhance the counselor's awareness of the impact of differences on the therapy process. Another model for increasing awareness is the Hines & Pedersen Cultural Grid, which offers comparisons of same versus different expectations, values, and behaviors. Another method is the use of "synthetic" cultures. Using IBM staff personnel from around the world, Hofstede identified four cultural dimensions: small versus large power distances, weak versus strong uncertainty avoidance, masculinity versus femininity, and collectivism versus individualism. From these dimensions synthetic cultures named Alpha (high power distance), Beta (strong uncertainty avoidance), Gamma (high individualism), and Delta (high masculinity) were developed. The Leong and Kim Intercultural Sensitizer method presents students with a case story in which some culturally based misunderstanding occurs. After reading these short stories students choose from four possible explanations for the misunderstandings. Each possible choice is accompanied by a rationale for why each choice is correct or incorrect.

Using vignettes based on the Cultural Grid, synthetic cultures or Intercultural Sensitizer counselors can examine their assumptions, attitudes, and predispositions and how their cognitions affect the client case. Other methods for developing skills and awareness include role plays and real-life client-counselor sessions using videotapes and case studies. Students watch videotapes of cross-cultural interactions and then analyze the underlying cultural assumptions and their impact on the interactions.

To consolidate the learning process, it is important that training go beyond the classroom. A cultural immersion experience is suggested to complement academic and skills-building components. A number of immersion experiences are possible. In some cases the immersion experience is a placement in a community mental health center that serves ethnic minority clients. In other settings, especially where there are no suitable community placements, the immersion experience can be volunteer service work. Another approach is to use field trips to relevant ethnic communities, social programs, and agencies. Some schools have adopted a "buddies" system technique, in which students are paired with a foreign student and engage in social activities. After contact with peoples in the immersion experience it is advisable to provide debriefing sessions in which trainees can analyze their experiences.

It is important that graduate programs realize that multicultural training can be stressful. Training programs should be carefully planned to provide a format in which certain inevitable affective responses and reactions can be discussed and resolved. Students often

feel anxious when asked to engage in open, honest discussions with or about people who are different. Many are anxious when in contact with people who are different. Students are often anxious about revealing any “hidden” or unintentional racism, sexism or homophobia, and so on. Students may experience feelings of guilt or shame. The training format should help students cope with these emotions. Students should learn to become comfortable with differences and the unavoidable interpersonal and intergroup conflicts that will arise. Trainees need a format that allows for the emergence of intergroup conflicts and that also allows for the resolution of conflicts. Trainees need to be trained in the appropriate, that is, therapeutic methods for establishing rapport with clients who may be identified with being social victims. Training needs to be conducted over a sufficient period of time, utilizing a stage model with increasing degrees of difficulty of course material, personal awareness, and interpersonal skills development as the training progresses.

As of yet, there is little information on the frequency of use of these models in training programs. There are few studies on the evaluation of training models. Little is known about the effectiveness of different models. For instance, there is little information on pre- and posttests to demonstrate effectiveness of graduate student training. More work is needed to examine the effectiveness of existing training models and to develop additional models. Degree-granting programs in psychology will eventually be pressured by the rapidly changing population demographics to provide sufficient training in working with ethnic minority and bicultural clients. For the first time the U.S. Census Bureau included a multiracial category in the 2000 census. 6,826,228 million (or 2.4 percent) respondents checked two or more races. The future arrives sooner than we think.

See Also the Following Articles

Addictions in Special Populations: Treatment ■ Cultural Issues ■ Economic and Policy Issues ■ Education: Curriculum for Psychotherapy ■ Modeling ■ Multicultural Therapy ■ Objective Assessment ■ Transcultural Psychotherapy

Further Reading

- Arkin, N. (1999). Culturally sensitive student supervision: Difficulties and challenges. *The Clinical Supervisor*, 18(2), 1–16.
- Cartmill, M. (1999). The status of the race concept in physical anthropology. *American Anthropologist*, 100, 651–660.
- Cuellar, I., & Paniagua, F. A. (Eds.). (2000). *Handbook of multicultural mental health*. San Diego, CA: Academic.
- Dana, Richard H. (2000). *Handbook of cross-cultural and multicultural personality assessment*. Mahwah, NJ: Lawrence Erlbaum Associates.
- Gopaul-McNicol, S., & Brice-Baker, J. (1998). *Cross-cultural practice*. New York: John Wiley and Sons.
- Jones, J. M. (1998). Ethnic minority psychology in the 20th century: Reflections and meditations on what has been and what is next. *Cultural Diversity and Mental Health*, 4, 203–211.
- Klonoff, E. A., Landrine, H., & Ullman, J. B. (1999). Racial discrimination and psychiatric symptoms among blacks. *Cultural Diversity and Ethnic Minority Psychology*, 5, 329–339.
- McKittrick, D. S., & Jenkins, S. Y. (2000). Considerations for ethnically diverse clients. In M. Hersen & M. Biaggio (Eds.), *Effective brief therapies: A clinician's guide* (pp. 411–431). San Diego, CA: Academic.
- Morrison, L. L., & Downey, D. H. (2000). Racial differences in self-disclosure of suicidal ideation and reasons for living: Implications for training. *Cultural Diversity and Ethnic Minority Psychology*, 6, 374–386.
- Pedersen, P. (Ed.). (1999). *Multiculturalism as a fourth force*. New York: Brunner/Mazel.
- Pope-Davis, D. B., Lui, W. M., Nevitt, J., & Toporek, R. L. (2000). The development and initial validation of the multicultural environmental inventory: A preliminary investigation. *Cultural Diversity and Ethnic Minority Psychology*, 6, 57–64.
- Ramirez, Manuel. (1999). *Multicultural psychotherapy: An approach to individual and cultural differences* (2nd ed.). Needham Heights, MA: Allyn and Bacon.
- Strickland, B. R. (2000). Misassumptions, misadventures, and the misuse of psychology. *American Psychologist*, 55, 331–338.
- Sue, D., & Sue, D. (1999). *Counseling the culturally different: Theory and practice* (3rd ed.). New York: John Wiley and Sons.
- Sue, S. (1999). Science, ethnicity, and bias: Where have we gone wrong? *American Psychologist*, 54, 1070–1077.

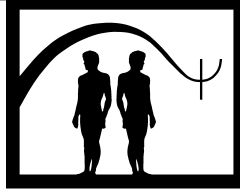

Rational Emotive Behavior Therapy

Albert Ellis

Albert Ellis Institute

- I. The ABCs of Rational Emotive Behavior Therapy
 - II. Rational Emotive Behavior Therapy Techniques
 - III. Multimodal Aspects of Rational Emotive Behavior Therapy
 - IV. Review of the Literature
 - V. Summary
- Further Reading

GLOSSARY

desensitization The gradual overcoming of a symptom or behavior by the presence of a counter behavior or idea in the presence of the provoking stimulus, usually in a graduated degree of intensity.

exposure Behavioral technique that involves confrontation with the symptom provoking stimulus.

multimodal Refers to different modes of therapy that involve social, cognitive, emotional, behavioral, and biological dimensions of the individual's life. Also refers to different ways of doing therapy based on these different issues, such as family therapy, medications, psychotherapy, etc.

mustabatory An Ellis term referring to the set of ideas formed by the individual's sense of social necessity or the requirements of other important people. Frequently, these ideas have a rigid and preemptory quality.

Rational emotive behavior therapy (REBT) was originated in January 1955 as a pioneering cognitive–experiential–behavioral system of psychotherapy. It is heavily

cognitive and philosophical, and specifically uncovers clients' irrational or dysfunctional beliefs and actively and directly disputes them. But it also sees people's self-defeating cognitions, emotions, and behaviors as intrinsically and holistically connected, not disparate. It holds that they disturb themselves with disordered thoughts, feelings, and actions, all of which importantly interact with each other and with the difficulties they encounter in their environment. Therefore, with emotionally and behaviorally disturbed people, REBT employs a number of thinking, feel, and action techniques that are designed to help them change their self-defeating and socially sabotaging conduct to self-helping and socially effective ways.

REBT theorizes that virtually all humans consciously and unconsciously train themselves to be to some degree emotionally disturbed. Therefore, with the help of an effective therapist and/or with self-help materials, they can teach themselves to lead more satisfying lives—if they choose to do so and work hard at modifying their thinking, feeling, and behaving.

Albert Ellis, the originator of REBT, was trained in Rogerian person-centered therapy in graduate school in clinical psychology (1942–1947), found it too passive and abandoned it for psychoanalytic training and practice (1947–1953). But psychoanalysis, too, he found ineffective because it was too much insight-oriented and too little action-oriented. His clients often saw how they originally became disturbed—supposedly because of their family history. But when he stayed

with typical psychoanalytic methods, he failed to specifically show them how to think and act differently and to thus make themselves more functional.

So Ellis went back to philosophy, which had been his hobby since the age of 16, and re-read the ancient philosophers (especially Epicurus, Epictetus, Marcus Aurelius, and Gautama Buddha) and some of the moderns (especially John Dewey, Bertrand Russell, and Paul Tillich) and found that they were largely constructivists rather than excavationists. They held that people do not merely get upset by adverse life conditions, but instead often choose to disturb themselves about these adversities. A number of philosophers also said that people could choose to unupset themselves about minor and major difficulties; if they made themselves anxious and depressed, they could reduce their dysfunctional feelings and behaviors by acquiring a core philosophy that was realistic, logical, and practical.

Following these philosophers, Ellis started to teach his clients that they had a choice of experiencing healthy negative emotions about the misfortunes they encountered—such as feelings of sorrow, disappointment, and frustration; or they could choose to experience unhealthy negative reactions—such as panic, depression, rage, and self-pity. By using rational philosophy with troubled clients, he saw that when they faced adversities with self-helping attitudes they made themselves feel better and functioned more productively. But when they faced similar adversities with irrational (self-defeating) philosophies they made themselves miserable and acted ineffectively. When he convinced them that they almost always had the choice of helping or hindering themselves, even when their desires and goals were seriously blocked, they often were able to make that choice.

I. THE ABCs OF RATIONAL EMOTIVE BEHAVIOR THERAPY

During the 1950s, Ellis put this constructivist theory into the now well-known ABCs of REBT. This theory states that almost all people try to remain alive and achieve basic Goals (G) of being reasonably content by themselves, with other people, productively working, and enjoying recreational pursuits. When their Goals are thwarted and they encounter Adversities (A) they are then able to construct Consequences (C)—mainly feelings and actions—that either help or hinder them satisfy these Goals. They largely (although not completely) do this by choosing to follow rational, useful Beliefs (B) or to follow irrational, dysfunctional Beliefs. Therefore, although the Adversities (A) they experience are impor-

tant contributors to their emotional and behavioral Consequences (C), they do not directly or solely cause these Consequences. When at C, people feel and act dysfunctionally or self-defeatingly, their irrational Beliefs (B) and their experienced Adversities (A) bring on their disturbed reactions. So A does not by itself lead to C. A interacts with B to produce C; or $A \times B = C$. However, people tend to be aware that C follows A, but not that B is also included in the process. They therefore think that adverse As automatically lead to disturbed Cs—that their internal reactions are controlled by external events.

Ellis noted in his first paper on REBT at the Annual Convention of the American Psychological Association in Chicago in August 1956, that when people feel and act disturbedly (C), they have 12 common irrational or dysfunctional Beliefs (B) about the undesirable things that happen to them (A). When they change these to rational or functional Beliefs (in therapy or on their own) they become significantly less disturbed. Both these hypotheses have been supported by many empirically based studies, first by followers of REBT and then by other cognitive behavior therapists who largely follow and have tested the ABC theory of REBT. Hundreds of published studies have given much support to this theory.

After using REBT for a few years in the 1950s, Ellis came up with clinical evidence for Karen Horney's hypothesis about the "tyranny of the shoulds." He realized that the many irrational Beliefs with which people often disturb themselves can practically always be put under three major headings, all of which include absolutistic shoulds, oughts, and musts. With these three core dysfunctional ideas, people take their strong preferences for success, approval, power, freedom, and pleasure, and elevate them to dogmatic, absolutistic demands or commands.

The imperatives that frequently accompany dysfunctional feelings and behaviors seem to be (1) "I absolutely must perform well at important tasks and be approved by significant others—or else I am an inadequate person!" (2) "Other people absolutely must treat me kindly, considerately, and fairly—or else they are bad individuals!" (3) "Conditions under which I live absolutely must provide me with what I really want—or else my life is horrible, I can't stand it, and the world's a rotten place!"

These three common irrationalities lead to innumerable derivative irrational Beliefs and frequently are accompanied by disturbed emotional and behavioral Consequences. In fact, REBT hypothesizes that people would find it difficult to make themselves disturbed without taking one or more of their major preferences and transforming them into absolutistic demands. Individuals with severe personality disorders and psychosis

also disturb themselves by turning their healthy preferences into unhealthy musturbating, but they often have other biochemical and neurological characteristics that help make them disturbed.

REBT also theorizes that the tendency to elevate healthy preferences to insistent demands, and thereby to think, feel, and act unrealistically and illogically, is innate in humans. People naturally and easily take some of their strong goals and desires and often view them as necessities. This self-defeating propensity is then exacerbated by familial and cultural upbringing, and is solidified by constant practice by those who victimize themselves with it. Therefore, especially with seriously disturbed people, psychotherapy and self-help procedures can, but often only with difficulty, change their dysfunctioning.

Many therapy techniques—such as meditation, relaxation, a close and trusting relationship with a therapist, and distraction with various absorbing activities—can be used to interrupt clients' musturbatory tendencies and help them feel better. But in order for them to get and stay better, REBT holds, they usually have to consciously realize that they are destructively escalating their healthy desires into self-sabotaging demands and then proceed to D—to actively and forcefully Dispute the irrational Beliefs that are involved in their disturbances. By vigorously and persistently Disputing these Beliefs—cognitively, emotively, and behaviorally—they can change their self-destructive shoulds and musts into flexible, realistic, and logical preferences. They thereby can make themselves significantly less disturbed.

II. RATIONAL EMOTIVE BEHAVIOR THERAPY TECHNIQUES

To help people specifically achieve and maintain a thoroughgoing antimusturbatory basic outlook, REBT teaches them to use a number of cognitive, emotive, and behavioral methods. It helps them gain many insights into their disturbances, but emphasizes three present-oriented ones:

Insight No. 1: People are innate constructivists and by nature, teaching, and, especially, self-training they contribute to their own psychological dysfunctioning. They create as well as acquire their emotional disabilities—as the ABC theory of REBT notes.

Insight No. 2: People usually, with the “help” and conivance of their family members, first make themselves disturbed when they are young and relatively foolish. But then they actively, although often unconsciously, work hard after their childhood and adolescence is over

to habituate themselves to dysfunctional thinking, feeling, and acting. That is mainly why they stay disturbed today. They continue to construct dysfunctional Beliefs.

Insight No. 3: Because of their natural and acquired propensities to strongly choose major goals and values and to insist, as well as to prefer, that they must achieve them, and because they hold these self-defeating beliefs and feelings for many years, people firmly retain and often resist changing them. Therefore, there usually is no way for them to change but work and practice—yes, work; yes, practice—for a period of time. Heavy work and practice for short periods of time will help; so brief rational emotive behavior therapy can be useful. But for long-range gain, and for clients to get better rather than to feel better, they require considerable effort to make cognitive, emotive, and behavioral changes.

REBT clients are usually shown how to use these three insights in the first few sessions of psychotherapy. Thus if they are quite depressed (at point C) about, say, being rejected (at point A) for a very desirable job, they are shown that this rejection by itself did not lead to their depression (C). Instead they mainly upset themselves with their musturbatory Beliefs (B) about the Adversity (A). The therapist explores the hypothesis that they probably took their desire to get accepted and elevated it into a demand—for example, “I must not be rejected! This rejection makes me an inadequate person who will continually lose out on fine jobs!”

Second, clients are shown—using REBT Insight No. 2—that their remembering past Adversities (A), such as past rejections and failures, does not really make them depressed today (C). Again, it is largely their Beliefs (B) about these Adversities that now make them prone to depression.

Third, clients are shown that if they work hard and persistently at changing their dysfunctional Beliefs (B), their dire needs for success and approval, and return to mere preferences, they can now minimize their depressed feelings—and, better yet, keep warding them off and rarely falling back to them in the future. REBT enables them to make themselves less disturbed and less disturbable.

III. MULTIMODAL ASPECTS OF RATIONAL EMOTIVE BEHAVIOR THERAPY

To help clients change their basic self-defeating philosophies, feelings, and behaviors, REBT practitioners actively and directly teach and encourage them to use a good many cognitive, experiential, and behavioral

techniques, which interact with and reinforce each other. It is one of the pioneering integrative therapies. Cognitive methods are particularly emphasized, and often include (1) Active disputing of clients' irrational beliefs by both the therapists and the client; (2) rational coping self-statements or effective philosophies of living; (3) modeling after people who coped well with Adversities similar to, or even worse than, those of the clients; (4) cost-benefit analyses to reveal how some pleasurable substances and behaviors (e.g., smoking and compulsive gambling) are self-sabotaging and that some onerous tasks (e.g., getting up early to go to work) are unpleasant in the short term but beneficial in the long run; (5) REBT cognitive homework forms to practice the uncovering and disputing of dysfunctional Beliefs; (6) psychoeducational materials, such as books and audio-visual cassettes, to promote self-helping behaviors; (7) positive visualizations to practice self-efficacious feelings and actions; (8) reframing of Adversities so that clients can realize that they are not catastrophic and see that they sometimes have advantages; (9) practice in resisting overgeneralized, black and white, either/or thinking; (10) practical and efficient problem-solving techniques.

REBT uses many emotive-experiential methods and materials to help clients vigorously, forcefully, and affectively Dispute their irrational demands and replace them with healthy preferences. Some of its main emotive-expressive techniques include the following: (1) Forceful and persistent disputing of clients' irrational Beliefs, done *in vivo* or on a tape recorder; (2) experiencing a close, trusting, and collaborative relationship with a therapist and/or therapy group; (3) steady work at achieving unconditional other-acceptance (UOA), the full acceptance of other people with their failings and misbehaviors; (4) using visualizations or live experiences to get in touch with intense unhealthy negative feelings—and to train oneself to feel, instead, healthy negative feelings; (5) role-playing difficult emotional situations and practicing how to handle them; (6) using REBT's shame-attacking exercises by doing "embarrassing" acts in public and working on not denigrating oneself when encountering disapproval; (7) engaging in experiential and encounter exercises that produce feelings of discomfort and learning how to deal with these feelings.

REBT uses many activity-oriented behavioral methods with clients, such as (1) Exposure or *in vivo* desensitization of dysfunctional phobias and compulsions; (2) taking deliberate risks of failing at important projects and refusing to upset oneself about failing; (3)

staying in uncomfortable situations and with disturbed feelings until one has mastered them; (4) reinforcing oneself to encourage self-helping behaviors and penalizing oneself to discourage self-defeating behaviors; (5) stimulus control to discourage harmful addictions and compulsions; (6) relapse prevention to stop oneself from sliding back to harmful feelings and behaviors; (7) skill training to overcome inadequacies in assertion, communication, public speaking, sports, and other desired actions that one is inhibited about.

These are some of the cognitive, emotive, and behavioral techniques that are frequently employed in rational emotive behavior therapy. Many other possible methods are individually tailored and used with individual clients.

The main therapeutic procedure of REBT is to discover how clients think, feel, and act to block their own main desires and goals, and to figure out and experiment with ways of helping them get more of what they desire and less of what they abhor. As they make themselves less disturbed and dysfunctional, they are helped to actualize themselves more—that is, to provide themselves, idiosyncratically, with greater satisfactions. At the same time, clients are helped to stubbornly refuse to define their preferences as dire necessities and thereby tend to reinstitute their disturbances.

IV. REVIEW OF THE LITERATURE

When Ellis originated it in 1955, rational emotive therapy was unique. It was followed by somewhat similar forms of cognitive behavior therapy (CBT) in the 1960s and 1970s, particularly cognitive therapy of Aaron Beck, rational behavior therapy of Maxie Maultsby, Jr., cognitive behavior modification of Donald Meilchenbaum, and Multimodal Therapy of Arnold Lazarus. REBT was soon supported by about 300 published studies that showed its effectiveness with many different types of clients.

Many of these have been surveyed in comprehensive reviews by R. DiGiuseppe, N. J. Miller, and L. D. Trexler, by T. E. McGovern and M. S. Silverman, by D. Hajzler and M. E. Bernard, by L. C. Lyons and P. J. Woods, and by M. S. Silverman, M. McCarthy, and T. E. McGovern.

As a result of its many successful outcome studies, REBT has become one of the most practiced psychotherapies. It is widely used with children, adolescents, couples, families, people with sex problems, and in other forms of counseling and psychotherapy. In ad-

dition, it is often used in business and industry, in education, in sports, in assertion training, in stress management, in parenting, and in many other fields.

Finally, REBT has revolutionized the self-help industry and has been widely adapted in scores of best-selling books, workbooks, and audio-visual cassettes, such as Wayne Dyer's *Your Erroneous Zones*, Albert Ellis' *A Guide to Rational Living*, and David Burns' *Feeling Good*.

The Albert Ellis Institute in New York, and in its many American and foreign branches, trains therapists and counselors in REBT and certifies them in its practice. To date, it and its affiliates have certified well over 5000 therapists.

V. SUMMARY

Rational emotive behavior therapy (REBT) was originated in 1955 as the first of the major cognitive behavior therapies. It has been shown to have effective outcomes in hundreds of published studies and has become one of the most popular psychotherapies. It looks like it, as well as cognitive behavior therapy, will continue to thrive in the 21st century.

See Also the Following Articles

Beck Therapy Approach ■ Behavior Therapy: Historical Perspective and Overview ■ Cognitive Appraisal Therapy ■ Cognitive Behavior Therapy ■ History of Psychotherapy ■ Humanistic Psychotherapy ■ Multimodal Behavior Therapy

Further Reading

- Bernard M., & Wolfe J. L. (2000). *The REBT resource book for practitioners*. New York: Albert Ellis Institute.
- DiGiuseppe, R. A., Miller, N. J., & Trexler, L. D. (1979). A review of rational-emotive psychotherapy outcome studies. In A. Ellis & J. M. Whiteley (Eds.), *Theoretical and empirical foundations of rational-emotive therapy* (pp. 218–235). Monterey, CA: Brooks/Cole.
- Ellis, A. (1994). *Reason and emotion in psychotherapy: Revised and Updated*. New York: Kensington Publishers.
- Ellis, A. (1999). *How to make yourself happy and remarkably less disturbable*. Atascadero, CA: Impact Publishers.
- Ellis, A. (2000). *How to control your anxiety before it controls you*. New York: Citadel Press.
- Ellis, A., & Dryden, W. (1997) *The practice of rational emotive behavior therapy*. New York: Springer.
- Ellis, A., Gordon J., Neenan, M., & Palmer, S. (1998). *Stress counseling*. New York: Springer.
- Hajzler, D., & Bernard, M. E. (1991). A review of rational-emotive outcome studies. *School Psychology Quarterly*, 6(1), 27–49.
- Lyons, L. C., & Woods, P. J. (1991). The efficacy of rational-emotive therapy: A quantitative review of the outcome research. *Clinical Psychology Review*, 11, 357–369.
- McGovern, T. E., & Silverman, M. S. (1984). A review of outcome studies of rational-emotive therapy from 1977–1982. *Journal of Rational-Emotive Therapy*, 2(1), 7–18.
- Silverman, M. S., McCarthy, M., & McGovern, T. E. (1992). A review of outcome studies of rational-emotive therapy from 1982–1989. *Journal of Rational-Emotive and Cognitive Behavior Therapy*, 10, 111–186.
- Walen, S., DiGiuseppe, R., & Dryden, W. (1992). *A practitioner's guide to rational-emotive therapy*. New York: Oxford.

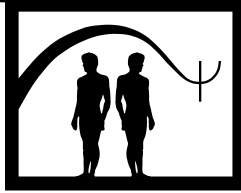

Reality Therapy

Robert E. Wubbolding

Center for Reality Therapy

- I. Description of Treatment: Environment and Procedures
- II. Theoretical Bases: Choice Theory
- III. Empirical Studies
- IV. Summary
Further Reading

GLOSSARY

- choice theory** The underlying principles of reality therapy that emphasize behavior as chosen for the purpose of satisfying inner genetic instructions or needs.
- environment** The therapeutic atmosphere or climate that serves as the basis for specific interventions.
- WDEP** The delivery system of reality therapy, signifying wants, direction and doing, self-evaluation, and planning.

Founded by William Glasser reality therapy has its roots in the work of Alfred Adler, who emphasized that human beings are social in nature and that behavior is goal centered. Glasser extended his early ideas to include genetic instructions or human needs as sources of human behavior. Accordingly, human beings originate their own behavior. It is not thrust on them by their families, their environment, or their early childhood conflicts. Rather, behavior is seen as chosen. In the early stages of its evolution, the formula for reality therapy was described as involving eight steps. Used widely in therapy, counseling, corrections, as well as in education,

reality therapy attempted to avoid coercion and punishment and teach inner responsibility. Its current formulation as a delivery system, developed by Robert E. Wubbolding in his books *Using Reality Therapy* and *Reality Therapy for the 21st Century*, is summarized with the letters WDEP. Its use now extends to self-help, as well as management, supervision, and coaching employees.

Describing the root of human strife as flawed relationships, Glasser has provided a theoretical and conceptual blueprint for addressing human conflict. Wherever human relationships are improved, productivity increases in the workplace, families remain intact, students achieve, and organizations achieve their goals and function more humanely.

I. DESCRIPTION OF TREATMENT: ENVIRONMENT AND PROCEDURES

Figure 1 presents an outline of the delivery system for reality therapy. Establishing a safe atmosphere or environment provides the basis for the more specific interventions known as procedures. As in any therapy the therapist listens to clients' stories presented in their own words and seeks to become part of their inner discourse. In the language of choice theory the therapist becomes part of the clients' quality world (i.e., someone who is capable of providing needed help). The procedures are the specific tools for helping clients clarify and prioritize their wants, evaluate their actions and self-talk, and finally, make plans for effective change. The "Cycle of

CYCLE OF MANAGING, SUPERVISING, COUNSELING AND COACHING

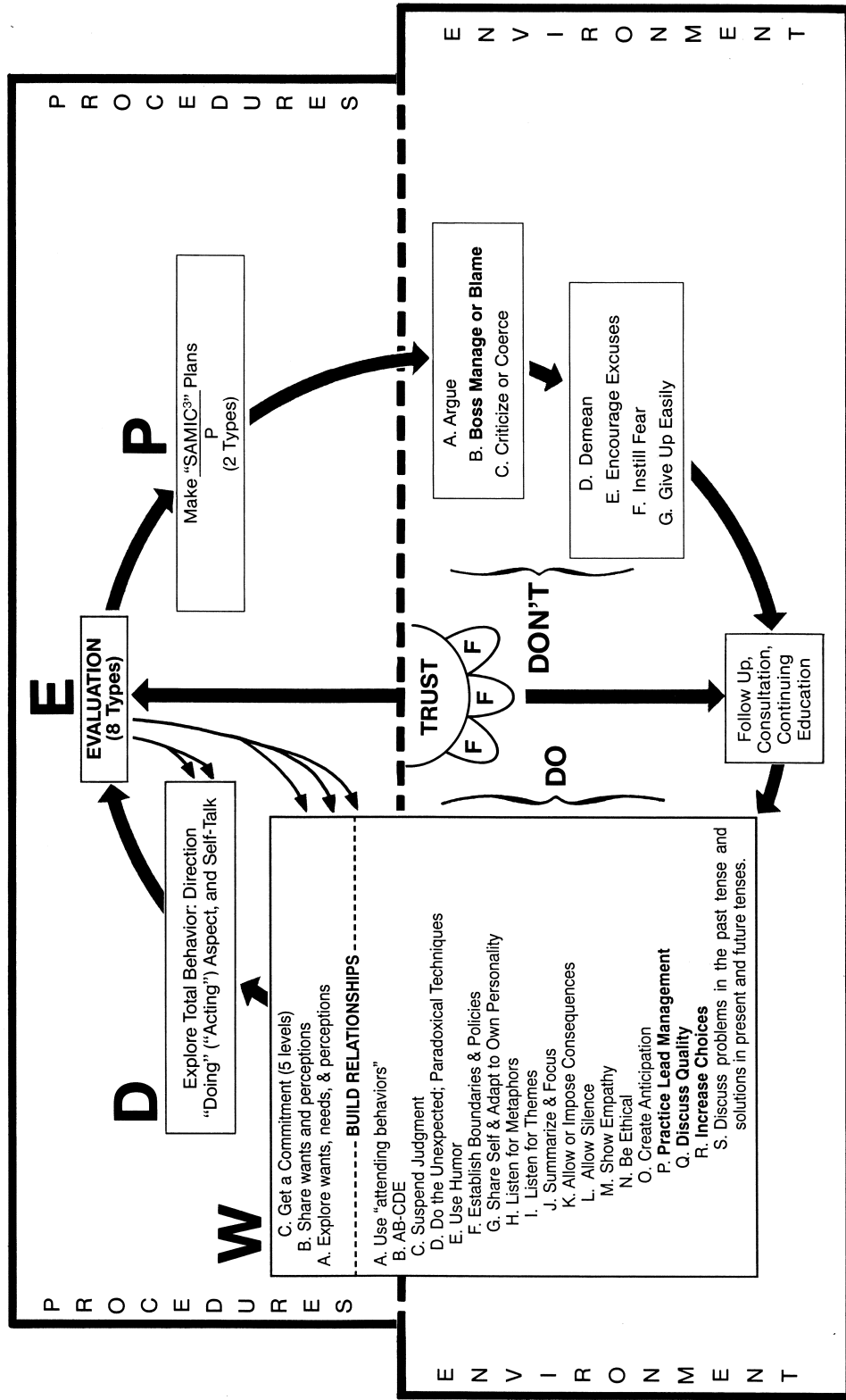

FIGURE 1 Outline of the delivery system for reality therapy. Adapted from the works of William Glasser. Copyright 1986 Robert E. Wubbolding. Reproduced with permission.

Summary Description of the Cycle of Managing, Supervising, Counseling and Coaching

Introduction:

The Cycle consists of two general concepts: Environment conducive to change and Procedures more explicitly designed to facilitate change. This chart is intended to be a brief summary. The ideas are designed to be used with employees, students, clients as well as in other human relationships.

Relationship between Environment & Procedures:

1. As indicated in the chart, the Environment is the foundation upon which the effective use of Procedures is based.
2. Though it is usually necessary to establish a safe, friendly Environment before change can occur, the "Cycle" can be entered at any point. Thus, the use of the cycle does not occur in lock step fashion.
3. Building a relationship implies establishing and maintaining a professional relationship. Methods for accomplishing this comprise some efforts on the part of the helper that are Environmental and others that are Procedural.

Environment:

DO: Build Relationship: a close relationship is built on TRUST through friendliness, firmness, and fairness.

- A. Using Attending Behaviors: Eye contact, posture, effective listening skills.
- B. AB = "Always Be..." Consistent, Courteous & Calm, Determined that there is hope for improvement, Enthusiastic (Think Positively).
- C. Suspend Judgment: View behaviors from a low level of perception, i.e., acceptance is crucial.
- D. Do the Unexpected: Use paradoxical techniques as appropriate; Reframing and Prescribing.
- E. Use Humor: Help them fulfill need for fun within reasonable boundaries.
- F. Establish boundaries: the relationship is professional.
- G. Share Self: Self-disclosure within limits is helpful; adapt to own personal style.
- H. Listen for Metaphors: Use their figures of speech and provide other ones.
 - I. Listen to Themes: Listen for behaviors that have helped, value judgements, etc.
 - J. Summarize & Focus: Tie together what they say and focus on them rather than on "Real World."
 - K. Allow or Impose Consequences: Within reason, they should be responsible for their own behavior.
 - L. Allow Silence: This allows them to think, as well as to take responsibility.
 - M. Show Empathy: Perceive as does the person being helped.
 - N. Be Ethical: Study Codes of Ethics and their applications, e.g., how to handle suicide threats or violent tendencies.
 - O. Create anticipation and communicate hope. People should be taught that something good will happen if they are willing to work.
 - P. Practice lead management, e.g., democracy in determining rules.
 - Q. Discuss quality.
 - R. Increase choices.
 - S. Discuss problems in the past tense, solutions in present and future tenses.

DON'T:

Argue, Boss Manage, or Blame, Criticize or Coerce, Demean, Encourage Excuses, Instill Fear, or Give up easily.

Rather, stress what they can control, accept them as they are, and keep the confidence that they can develop more effective behaviors. Also, continue to use "WDEP" system without giving up.

Follow Up, Consult, and Continue Education:

Determine a way for them to report back, talk to another professional person when necessary, and maintain ongoing program of professional growth.

Procedures:

Build Relationships:

- A. Explore Wants, Needs & Perceptions: Discuss picture album or quality world, i.e., set goals, fulfilled & unfulfilled pictures, needs, viewpoints and "locus of control."
- B. Share Wants & Perceptions: Tell what you want from them and how you view their situations, behaviors, wants, etc. This procedure is secondary to A above.
- C. Get a Commitment: Help them solidify their desire to find more effective behaviors.

Explore Total Behavior:

Help them examine the Direction of their lives, as well as specifics of how they spend their time. Discuss ineffective & effective self talk.

Evaluation - The Cornerstone of Procedures:

Help them evaluate their behavioral direction, specific behaviors as well as wants, perceptions and commitments. Evaluate own behavior through follow-up, consultation and continued education.

Make Plans: Help them change direction of their lives.

Effective plans are Simple, Attainable, Measurable, Immediate, Consistent, Controlled by the planner, and Committed to. The helper is Persistent. Plans can be linear or paradoxical.

Note: The "Cycle" describes specific guidelines and skills. Effective implementation requires the artful integration of the guidelines and skills contained under Environment and Procedures in a spontaneous and natural manner geared to the personality of the helper. This requires training, practice and supervision. Also, the word "client" is used for anyone receiving help: student, employee, family member, etc.

FIGURE 1 (Continued).

Managing, Supervising, Counseling, and Coaching” is applicable to many relationships and is used in many settings where human relationships are paramount: teaching, therapy and counseling, consultation, management, and supervision. Moreover, reality therapy employs several strategies common to all counseling theories.

Also, although the environment is the foundation upon which the procedures are built, there is no absolute line of demarcation between them. Thus “Build Relationships” is both environmental and procedural. Nor is the “Cycle” a simplistic lock-step method to be entered unwaveringly at the same place with every patient. People using reality therapy in their human interactions, enter the “Cycle” at various points. Although a therapist generally establishes a friendly, warm relationship before employing procedures that lead to change, helping clients evaluate their own behavior and making plans often occurs early in the therapy process.

Finally, because reality therapy is used in corrections, in classrooms, and in many relationships besides therapy, specific helpful and hurtful and behaviors as well as attitudes are described under environment such as “don’t criticize” and “don’t encourage excuses.”

A. Environment

The word “environment” implies an effort on the part of the therapist to establish an atmosphere in which the patient can feel safe, secure, and motivated. As shown in Figure 1, hindrances to establishing a trusting, helpful, safe environment include arguing, bossing, blaming, criticizing, demeaning, colluding with excuses, instilling fear, and giving up easily. In consulting with parents, educators, managers, and others, therapists often teach the ineffectiveness of such choices.

Opposite the ineffective environmental behaviors is a wide range of helpful, effective, and facilitative suggestions leading to a trusting atmosphere. These include attending behaviors, use of paradoxical techniques and metaphors, listening for themes related to procedures, skill in demonstrating accurate empathy, and helping clients find choices even amid their feelings of depression, perceptions of oppression, and lack of opportunities to fulfill their own needs.

B. Procedures: The WDEP System

The environment serves as a foundation for the effective use of procedures that lead to change. They are not a series of recipes used mechanically. Rather they are a network or a system defined by the acronym WDEP. Therefore, depending on the presenting and un-

derlying problem, the therapist extracts from the system appropriate components for application.

W: Explore Wants, Needs, and Perceptions

Essential to the process of change, as well as facilitating the relationship, is a clear determination and definition of clients’ wants or desires. They are asked to describe current pictures or to insert firmly in their “quality worlds,” exactly what they want. Using the analogy of wants as pictures, it is evident that clients often have blurred wants. They are unclear about what they want, so when they are asked, “What do you want from your job, from your spouse, from your parents, from your children?” the answer is, “I don’t know” or “I’m not sure.” An adolescent often wants “my parents off my back” or “to be left alone” but is unable to provide a detailed and unambiguous description of this desire. Consequently, the reality therapist helps clients clarify and define wants, which is the process for the beginning of effective action on the part of clients.

Another part of the W is the exploration of clients’ perception or viewpoint. The therapist asks the parent of a child, “How do you see your son or daughter?” In the case of a severely upset child, the parent might answer, “I see a lazy, rebellious, surly, uncooperative, and ungrateful child.” Of course, such questioning is combined with an exploration of wants, for example, “What do you want from him or her?”

To the workaholic parent of a child, the therapist could say, “I see your 18 hour days not as a ‘rendezvous with destiny’ but as a collision course for you and your children.” To the parent of the teenager, the counselor might say, “I see your son or daughter as a person who needs a compliment for even a minor success or change.” In the practice of reality therapy, therapists take an active but nonauthoritarian role, and see themselves as a partners in the process of change.

D: Doing (Total Behavior)

Behavior is composed of four aspects: doing, thinking, feeling, and physiology. A popular misconception is that reality therapy neither deals with nor allows for a discussion of feelings and emotions. This erroneous perception is perhaps derived from the accurate statement that in reality therapy the action aspect of the behavioral system is emphasized (although not to the exclusion of the other components). Still, there are two important aspects to this procedure: exploration of overall behavioral direction and specific actions or choices.

The therapist encourages clients to be specific in the discussion of behaviors, such as exploring a specific segment of time: a day, a morning, an hour, an incident, or an event. Although it is important to examine the

overall direction of total behavior, direction will change only with small measurable changes made one at a time. Thus, therapists help clients become a television camera describing specific rather than typical events.

E: Self-Evaluation

If the entire process of environment and procedures is a cycle, the procedures appear as an arch with its keystone self-evaluation. This component is a prerequisite for change in human behavior. No one chooses a more effective life direction or changes a specific behavior without making at least a minimal self-evaluation that the current course of action is not advantageous. Effective change rests on judgments related to total behavior, wants, perceptions, and other aspects of the client's life.

The term "Evaluation" has a meaning in reality therapy that is different from its meaning in other theories. In reality therapy, the procedure described here is not an assessment evaluation or "clinical diagnosis." Rather, it is a series of value judgments, decisions, and changes in thought made by the client. In the restructuring of thought, clients come to the conclusion that their life direction is not where they want to go, that a certain exact and specific current behavior is not useful or not helpful, that what they want is not attainable or helpful, that a perception is not effective, and that a future plan of action represents a more need-fulfilling behavior.

In the "Cycle" evaluation comprises an axis that closely connects procedures and environment. Reality therapists help clients evaluate their own choice systems (wants, behavior, perceptions) as well as devote considerable effort toward the evaluation of their own specific professional behaviors and generalized competencies.

P: Planning

If evaluation is the keystone of the procedures, planning is the superstructure or the goal. A plan of action is crucial to change. It can sometimes be complicated and sometimes simple. There must always be a plan. People who go through life without some sort of long-term plan, are like ships floundering without rudders. This procedure is the easiest to bring about if the therapist has prepared the way by the effective use of the more subtle procedures and environmental components already described. Nevertheless, if the plan is to be effective, it should be characterized by as many as possible of the following qualities summarized by the acronym SAMIC³.

- S = Simple: The plan is clear and not complicated.
- A = Attainable: Realistically doable rather than grandiose and impossible.
- M = Measurable. An effective plan is precise and exact.

I = Immediate. Implementation immediately after or even during the therapy session is desirable.

C = Controlled by the planner. A plan should not be contingent on the behavior of another person.

C = Committed to. The reality therapist elicits a firm commitment.

C = Consistent. The plan should be repeated.

The WDEP system should be seen as a unit, a system in which one component affects the others, and so, the subsystems W, D, E, and P are not isolated steps that must be followed one after another. Rather, it is more appropriate to extract from the system whatever component is most relevant at the moment. Through listening, practice, and supervision, a user of reality therapy can develop a sense of where to start and how to proceed through the "Cycle."

II. THEORETICAL BASES: CHOICE THEORY

The practice of reality therapy is based on choice theory. Previously lacking a theoretical framework for reality therapy, Glasser employed the relatively obscure principles of control system theory to explain its effectiveness, and extended the theory to provide a basis for clinical practice by presenting a detailed explanation of human needs, total behavior (actions, thinking, feelings), perceptions, and inner wants or "quality world," the phrase used to describe our specific wants and intense desires. Control system theory is based on the principle that living organisms originate their behavior from the inside. They seek to close a gap between what they have and what they perceive they need at a given moment. This discrepancy, called a "perceptual error," sets the behavioral system in motion so as to impact the external world. Human organisms act on their external worlds to satisfy needs and wants. They gain input from and generate output toward the external world. Because of the emphasis on inner control and especially because of the emphasis on behavior as a choice, the theory was renamed choice theory in 1996.

III. EMPIRICAL STUDIES

The question is often asked, "Does reality therapy work? Is it effective?" Robert Wubbolding has provided an extensive summary of research conducted on its efficacy. Investigators have found an increase in the self-esteem of clients and a greater realization of the meaning

of “addict,” a significant reduction in the rate of recidivism with juvenile offenders, and a complete resocialization of a large number of prison residents, all of whom received reality therapy treatment.

Much research has been conducted in schools measuring the effects of counselor and teacher training in reality therapy. Teaching students to self-evaluate their behavior and their work has resulted in a drop in teacher referrals for discipline and other problems.

A sampling of research in a variety of settings illustrates the wide use of this system. Participants in training workshops leading to certification represent psychology, social work, counseling, classroom teachers, administration, corrections, geriatrics, and other disciplines. Although there is ample research to demonstrate the viability of reality therapy as a therapeutic method, more is needed. Wubbolding recommends that close attention be given to the quality of training provided for therapists, teachers, and others who use the system so that the genuine use of reality therapy is measured. Also, more studies measuring outcome (i.e., change in behavior) are needed.

IV. SUMMARY

Reality therapy, formulated as WDEP, is a practical and jargon-free system based on choice theory. Its philo-

sophical principles include the belief that people choose their behavior. It is not imposed from early childhood or by external stimuli. Therapists help clients define their wants, evaluate their behaviors as well as their wants, and make plans for future change.

See Also the Following Articles

Adlerian Psychotherapy ■ Control-Mastery Theory ■ Family Therapy

Further Reading

- Glasser, W. (1965). *Reality therapy*. New York: HarperCollins.
- Glasser, W. (1968). *Schools without failure*. New York: HarperCollins.
- Glasser, W. (1998). *Choice theory*. New York: HarperCollins.
- Glasser, W. (1999). *Reality therapy in action*. New York: HarperCollins.
- Wubbolding, R. (1988). *Using reality therapy*. New York: HarperCollins.
- Wubbolding, R. (1996). *Employee motivation*. Knoxville, TN: SPC Press.
- Wubbolding, R. (2000). *Reality therapy for the 21st century*. Philadelphia, PA: Brunner/Routledge.
- Wubbolding, R., & Brickell, J. (1999). *Counselling with reality therapy*. London: Winslow Press.

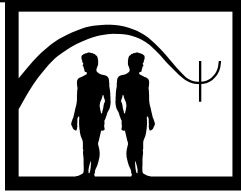

Reinforcer Sampling

Adrienne E. Fricker, Amy M. Combs-Lane,
Joanne L. Davis, and Ron Acierno

Medical University of South Carolina

- I. Description of Treatment
- II. Theoretical Bases
- III. Empirical Studies
- IV. Summary
- Further Reading

GLOSSARY

behaviorism School of thought that stresses the importance of studying behavior objectively and dealing only with directly or potentially observable stimuli and responses.

reinforcer sampling rule Before using an event or stimulus as a reinforcer, sampling of the reinforcer is required in the situation in which it is to be used.

token economy Reinforcement system in which individuals earn symbolic reinforcers that can be exchanged for a tangible reward for performing adaptive behaviors, or lose symbolic reinforcers for performing maladaptive behaviors.

Reinforcer sampling is the procedure of noncontingently presenting a portion of a reinforcer prior to a response to (1) determine that a stimulus or event is, in fact, reinforcing, and (2) increase the motivation of the organism to engage in behavior to obtain the reinforcer. This article will present a review of the theoretical and empirical bases of reinforcer sampling, provide ways in which reinforcer sampling has been used in clinical populations, and provide other practical examples of its utility.

I. DESCRIPTION OF TREATMENT

Reinforcer sampling is a procedure to identify or increase the reinforcing value of a stimulus or event. In order to identify whether a potential reinforcer is desirable to the subject, the reinforcer is presented noncontingently (i.e., the subject receives or “samples” the reinforcer without doing anything for it). After the subject has sampled the reinforcer, the probability that the subject will work to gain access to the reinforcer in the future may change. A response or set of responses are then specified upon which the reinforcer is made contingent. It is hoped that since the subject has had a chance to experience the reinforcer, he or she will be more motivated to obtain it, and thus will be more likely to engage in the desired behavior.

Reinforcer sampling could be used in a situation in which a parent wishes to obtain a specific behavior from a child. For example, a mother may want her child to pick up his toys when he is finished playing with them. To alter his behavior using reinforcer sampling, this mother could noncontingently introduce a potential reinforcer, such as a new computer game, several random times in the home. Then, after it appeared that her son liked playing the game and looked forward to playing it, the mother could tell him that he would be able to play the computer game only after he picked up all of his toys, therefore making playing the computer game contingent upon picking up his toys. Importantly, prior experience, or sampling the computer

game, would be necessary for this stimulus to have any relevance to the boy.

II. THEORETICAL BASES

Reinforcer sampling was described by Teodoro Ayllon and Nathan Azrin in their 1968 book on the token economy system of motivational and rehabilitational therapy. A token economy system requires individuals to earn tokens for adaptive behavior that can be exchanged for numerous reinforcers, such as meals, activities, and so on. The theory behind the token system is that individuals will engage in adaptive behaviors in order to gain access to available reinforcers. However, this will only be effective if the implementers of the token economy system accurately identify those stimuli or events (i.e., reinforcers) that may serve the function of increasing the probability of the occurrence of targeted responses (i.e., truly reinforcing stimuli). Ayllon and Azrin reported that many individuals in a token economy system would not engage in what was assumed to be a reinforcing activity. That is, the activity was not truly reinforcing to these individuals. Reinforcer sampling is a way of determining the reinforcing properties of a stimulus or event. Although the sampling of an event does not guarantee that it will be reinforcing, it will increase familiarity with the event. Thus, if the individual does not seek the reinforcer, one is assured that this is not simply due to unfamiliarity with it.

In their book, Ayllon and Azrin presented the Reinforcer Sampling Rule, which states that before using an event or stimulus as a reinforcer, sampling of the reinforcer is required in the situation in which it is to be used. This is important for several reasons. First, if an individual has not previously or recently come into contact with the potentially reinforcing event, then it may not be reinforcing to that individual. Second, a previously identified reinforcer may lessen or lose its reinforcing qualities in a new situation. In other words, while a stimulus may be familiar and somewhat reinforcing, it may not be worth the effort when subjects are required to engage in certain behaviors to obtain it.

The principle of stimulus generalization suggests that the probability of a response increases as a function of the degree of similarity of the stimuli to those previously present at the moment of reinforcement. Thus, to increase the odds that an individual will work for a reinforcer, the situation should closely approximate the original situation that existed when the individual initially obtained the reinforcer. Reinforcer sampling procedure allows the individual to be briefly presented with

the reinforcer before the response, thereby reproducing all of the stimuli associated with the onset of the reinforcer. After the individual has sampled the reinforcer in the new situation, and thus has become familiar with the reinforcer in the new context, the remainder of the reinforcer could then be delivered after the individual has produced the desired response.

The sampling rule is often used in businesses. An example is the woman who hands out free food and drink samples at the grocery store hoping that shoppers will find the sample good (i.e., reinforcing) and buy the product (i.e., engage in the desired behavior).

III. EMPIRICAL STUDIES

In the 1960s, Ayllon and Azrin conducted a series of studies evaluating the use of reinforcer sampling with psychiatric inpatients. Each study evaluated the number of psychiatric inpatients that engaged in different activities, (e.g., a fair, a walk, watching a movie, a social evening, a music session, and religious services), without first being allowed to “sample” the event. The patients had to use one of their earned tokens to attend the event. In the second phase, patients were allowed to “sample” the event by being present at the fair grounds or watching the first few minutes of the religious service, and then were allowed to decide whether they wanted to use their token to attend the event for a longer duration. Ayllon and Azrin found that the patients were more likely to attend the event if they had been allowed to sample the event first. However, with a return to the regular procedure in which the patients were not allowed to sample the event before deciding whether they wanted to attend it, they were less likely to choose to use a token to participate. Ayllon and Azrin reported that this suggests that reinforcer sampling is an effective means of increasing utilization of a reinforcer, and that it can be used with a variety of different reinforcers. They also suggested that reinforcer sampling should be used for as long as the specific behavior is desired, as their results showed that patients decreased their utilization of the reinforcer event when the reinforcer sampling procedure was discontinued.

Reinforcer sampling does not appear to work solely by familiarizing individuals with reinforcers. That is, the experiments demonstrated an increased utilization of the reinforcer once sampling was available, even in patients who had previous experience with the event.

Since Ayllon and Azrin studied reinforcement sampling procedures in psychiatric inpatients, other studies have replicated their findings with other samples of

psychiatric inpatients, as well as in different populations. Often, reinforcer sampling has been studied in the context of token economy systems used with severely mentally ill individuals or individuals with mental retardation. In these populations, reinforcer sampling is used to encourage individuals to work for reinforcers and activities that are available. For example, in token economy systems, individuals earn tokens by engaging in specific desirable behaviors and then are allowed to use the tokens to “purchase” meals, access to objects such as musical instruments, and activities such as social events or outdoor passes. In research conducted in the later 1960s through the 1970s, with an occasional study in the 1990s, researchers examined the effectiveness of reinforcer sampling in increasing mentally ill or developmentally delayed individuals’ utilization of positive reinforcers (e.g., arts and crafts) provided in a long-term care setting. Similar to Ayllon and Azrin, researchers have predominantly found that allowing individuals to sample the reinforcer prior to using the reinforcer as a contingent event or stimulus has increased the chances that individuals will choose to engage in the reinforcing activity.

Researchers have also experimented with alternate forms of reinforcer sampling. For example, some have employed response exposure as a form of sampling. Response exposure involves allowing an individual to observe a desired response being chosen or enacted by another person followed by receipt of reinforcement.

IV. SUMMARY

Reinforcer sampling is a procedure that can enhance the relevance of a reinforcer. Reinforcer sampling in-

volves presenting a potential reinforcer noncontingently to an individual prior to requiring a specific behavior so that the individual’s motivation to obtain the reinforcer is increased. This procedure is useful when individuals are unfamiliar with the reinforcer, or are unfamiliar with the context in which the reinforcer will be used to obtain a desired behavior. Reinforcer sampling also helps to identify those events, objects, or activities that will be reinforcing to a specific individual or group of people. Reinforcer sampling has been used primarily with psychiatric inpatients and developmentally delayed populations. However, behavioral principles suggest that it could be useful with a variety of types of populations.

See Also the Following Articles

Behavioral Consultation and Therapy ■ Negative Reinforcement ■ Positive Reinforcement ■ Token Economy

Further Reading

- Ayllon, T., & Azrin, N. (1968). *The token economy: A motivational system for therapy and rehabilitation* (pp. 88–103). New York: Appleton-Century-Crofts.
- Ayllon, T., & Azrin, N. H. (1968). Reinforcer sampling: A technique for increasing the behavior of mental patients. *Journal of Applied Behavior Analysis*, 1, 13–20.
- Kazdin, A. E. (1977). *The token economy: A review and evaluation* (pp. 157–158). New York: Plenum Press.
- Spiegler, M. D., & Guevremont, D. C. (1993). *Contemporary behavior therapy* (2nd ed., pp. 105–137). Pacific Grove, CA: Brooks/Cole.

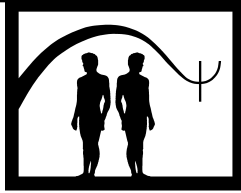

Relapse Prevention

Kirk A. Brunswig, Tamara M. Penix, and William O'Donohue

University of Nevada, Reno

- I. Overview
- II. Theoretical Bases
- III. Treatment Components
- IV. Future Directions
- V. Summary
- Further Reading

GLOSSARY

abstinence violation effect (AVE) Occurs when a client lapses and irrationally concludes that the lapse is so severe that they may as well relapse (e.g., since I broke the rule and I had one shot of whiskey, I may as well finish the bottle); a form of perfectionist or “all or none” thinking.

high-risk situation A situation identified by client and therapist as one in which the client has a greater likelihood to experience a lapse or relapse. Part of a behavior chain that probabilistically could lead to a lapse or relapse.

idiographic A self-referenced, as opposed to norm-referenced, context (e.g., comparisons with the client's previous level of function would be idiographic, whereas comparisons with the client's peers would be nomothetic).

lapse An occurrence of an undesired behavior in the context of behavior cessation or reduction program (e.g., smoking a cigarette by the client in a smoking cessation program or visiting a bar by an alcoholic). A lapse is always less serious than a relapse.

problem of immediate gratification (PIG) The orientation to positive, usually smaller, short-term consequences with adverse, usually larger, long-term consequences, rather than to adverse or unwanted short-term consequences for a more beneficial long-term consequence.

relapse A violation of the contract or terms of the behavior cessation or reduction program. Sometimes defined as a return to pretreatment levels of the problem behavior.

seemingly irrelevant/unimportant decisions (SIDS/SUDS) Decisions early in a behavior chain that place the client in a high-risk situation (e.g., the pedophile deciding to get milk from the market near the day care center rather than the market near the commercial district).

I. OVERVIEW

When one thinks of psychotherapy, a picture comes into view of a more or less theoretically inspired set of techniques that are employed as a primary clinical intervention to treat a constellation of psychological symptoms. Unlike most of the psychotherapies that are described in this volume, relapse prevention (RP) did not evolve as a front-line treatment for a particular mental disorder. It was instead a calculated response to the longer-term treatment failures of other therapies. It was not conceived as an alternative to those interventions, but as a supplemental tool that would make a variety of treatments, particularly for addictive behaviors, more effective.

Another unique feature of RP is that it was not originally concerned with all of the phases of treatment; for example, it did not address the precontemplation, contemplation, preparation, and action stages of treatment. The original target of RP was the maintenance phase of treatment, when patients are no longer receiving

a regular dose of the primary treatment and the positive effects brought about by regular treatment contact can begin to wane. RP was conceived as an answer to the problem of maintaining initial gains. Arguably the most difficult challenge for any patient is maintaining treatment gains over time without the structure and accountability of therapy, or the support of a therapist or group. RP provides some tools for maintaining treatment gains over time.

This article provides the history of RP and its evolution in the treatment of addictions and other impulse control problems. We describe some of the various forms of RP and its basic components. Relevant research is presented and we discuss the future potential of RP with the additions of motivational interviewing, stepped-care approaches to health, and harm reduction concepts.

II. THEORETICAL BASES

Relapse Prevention is a broad phrase that is used to describe a varied set of cognitive-behavioral techniques that are employed to maintain desirable addictive and impulsive behavioral changes. Alan Marlatt and Judith Gordon developed the approach over the course of several years and many discussions. Marlatt and his colleagues were working in the treatment of substance abuse and became increasingly concerned with follow-up data. Results indicated that although significant treatment gains could be produced in addictive behaviors such as drug, alcohol, and tobacco use, those gains also diminished significantly over time if no further intervention was implemented. In 1995 D. Richard Laws wrote of findings suggesting that within 1 year of ending treatment over 80% of patients would relapse (resume the undesired behavior) and two-third of these resumptions would occur in the first 3 months. Marlatt and his colleagues concluded that it was not the cessation treatments themselves that needed to be altered. These approaches initially appeared to facilitate abstinence for many patients. Instead, Marlatt reasoned that a supplemental treatment was needed that would focus on the maintenance of the gains that were acquired during the original treatment period.

The primary assumption of RP is that there it is problematic to expect that the effects of a treatment that is designed to moderate or eliminate an undesirable behavior will endure beyond the termination of that treatment. Further, there are reasons to presume a problem will reemerge, such as a return to the old environment that elicited and maintained the problem behavior; forgetting the skills, techniques, and information taught

during therapy; and decreased motivation. Treatments typically involve an intense but limited period of time during which patients are brought into contact with new influences (some mental health workers, some patients like themselves), information, and contextual components that aid in creating changes in their behaviors. There is an accountability factor that is built into these techniques as well as a regular dose of treatment given reliably over a period of time. These accountability and dose elements are commonly removed after the client has reached his or her treatment goals (treatment is terminated) and the client must learn to implement the skills and knowledge he or she learned in a new context with little or no assistance. Generalizing the skills to varied situations poses a significant challenge and many treatment failures are the result.

Marlatt and his colleagues believed that treatment failures could be analyzed in order to discover internal and external variables that increased risk for relapse. They further reasoned that knowing items such as situational factors, mood states, and cognitions would identify individualized targets of change for clients, targets focused not on the acquisition of quitting behavior, but the maintenance of that behavior. Based loosely on Albert Bandura's 1977 social learning theory, the RP model proposes that at the cessation of a habit control treatment, a client feels self-efficacious with regard to the unwanted behavior and that this perception of self-efficacy stems from learned and practiced skills. Over time the client contacts internal and external risk factors such as seemingly irrelevant decisions (SIDS, sometimes seemingly unimportant decisions, or SUDS) and/or high-risk situations (HRS) that threaten the client's self-control, and consequently his or her perception of self-efficacy. According to the model, if the client has adaptive coping skills to adequately address the internal and external challenges to his or her control, the client will not relapse. However, if his or her skills are not sufficient to meet the challenge, a lapse or relapse may occur (this will be described in greater detail below). In response to a resumption of the change behavior at some level, the client has a reaction that either increases attempts to implement adaptive coping skills, or fails to cope effectively and engages in the undesirable behavior because it provides immediate gratification. Embedded in this model is Marlatt's supposition that the targets of intervention are cognitions and behaviors that are collectively referred to as coping skills. Marlatt and his colleagues' treatment therefore employs cognitive-behavioral techniques to improve the retention and accessibility of adaptive coping responses.

In the short period of time since its introduction, RP has evolved in numerous directions. It has been applied

to new problem areas such as risky sexual behaviors, overeating, and sexual offending. It has additionally come into use as a full program of treatment and lifestyle change, instead of simply a supplemental intervention strategy. That is, RP is often a primary treatment program in addition to addressing the maintenance issue. Lastly, RP is emerging as a bona fide theory of compulsive habit patterns and the processes of relapse. It should be noted that RP is most widely used with behaviors deemed volitional in origin (e.g., behaviors of consumption); however, some practitioners have applied RP in problem behaviors where the volitional element is less clear (e.g., schizophrenia, depression).

Tony Ward and Stephen Hudson in 1996 argued that this conceptualization often fails to accurately capture the addictive processes for which it was used. For example, the theoretical link between high-risk situation and lapse, as well the link from lapse to relapse has not been sufficiently demonstrated. As Ward and Hudson suggest, RP has rightfully undergone increasing scrutiny in recent years. Additional researchers and scholars have critiqued and extended the RP theory that commenced with the ideas of Bandura, Marlatt, and Gordon. See the edited work by Laws, Hudson, and Ward (2000) *Remaking Relapse Prevention with Sex Offenders* for the latest developments in RP theory in general, and treatment applications for sexual offenders.

III. TREATMENT COMPONENTS

In 1995 Laws outlined the tenets of RP. He provides 12 principles that serve as the foundation of this approach. Briefly summarized, the components of RP are identification of a maladaptive behavior, a process of change defined by commitment and motivation, behavioral change and maintenance of behavior change, identification of lapses (a single instance of the maladaptive behavior) and relapses (a complete violation of the self-imposed abstinence rules), lifestyle balance between obligatory and self-selected behaviors, recognition of the ideographic aspects of the maladaptive behavior, and recognizing and planning behavioral responses for high-risk situations. In practice, RP addresses the issues of identifying high-risk situations, seemingly irrelevant decisions, and the problem of immediate gratification. Therapists using RP to treat sex offenders also include skills training components, such as social skills and coping skills.

In general, relapse prevention's foci are first, identification of high-risk situations, and second, employing appropriate self-control responses. High-risk situations

are determined by an analysis of past offenses and by reports of situations in which the client feels or felt "tempted." These situations may be a bar or tavern for smokers and drinkers, playgrounds and shopping malls for sexual offenders, and casinos for gamblers. Appropriate responses are those behaviors that lead to avoidance of high-risk situations, or if in a high-risk situation, behaviors that foster nonoffending actions. For example, if an offender realizes he is having a fantasy about offending, he can employ a thought-stopping behavior, such as saying out loud "Stop!" or distracting himself such that the deviant fantasy is interrupted. Laws suggests that responding with an appropriate coping response to high-risk situations will lead to increased self-efficacy and a decreased probability of relapse. He also indicates that if appropriate coping responses are not utilized or not in the behavioral repertoire, there will be a decrease in self-efficacy, an increased likelihood of positive outcome expectancies (perception of positive experiences resulting from engaging in maladaptive behavior), a lapse, and an increased probability of future lapses.

A. High-Risk Situations

This component often involves the ideographic assessment of high-risk situations. The client and clinician work together to identify the situations in which the client has previously engaged in problematic behavior and those situations in which the client is likely to engage in problematic behavior. The client will be asked to generate a list of situations that are lowrisk, and to determine what aspects of those situations differentiate them from high-risk situations. The focus will be to train the client to recognize themes and commonalities in his or her high-risk situations so that the client can generalize the ability to assess level of risk in a novel situation. The therapist works with the client to ensure that the client is realistic in his or her assessment of the level of risk in a variety of hypothetical situations. For example, the therapist often creates a series of hypothetical situations, based on the client's self-report of risk factors, to assess the client's ability to determine the causes and severity of risk.

B. SIDs/SUDs

Seemingly irrelevant decisions (SIDs) (also seemingly unimportant decisions or SUDs) are those behaviors that might not lead directly to a high-risk situation, but are early in the path of decisions that place the client in a high-risk situation. For example, if the client reports that he is more likely to engage in the problematic

behavior after drinking during lunch, a SID would be agreeing to attend a two-martini luncheon with a co-worker. In addressing SIDs, the therapist works with the client to determine which decisions lead to high-risk situations. Coping skills are often taught in conjunction with therapeutic work on SIDs. Once the client can identify high-risk situations and SIDs, the client needs to learn effective coping strategies. For example, the therapist may direct the client to brainstorm strategies to resolve a high-risk situation without employing the problematic behavior. For example, the client may choose to walk away or the client may wish to change the situation so that the risk is lowered (e.g., for a smoker, moving a conversation to a room in which there are more nonsmokers, away from the break room or smoking area). The therapist must work with the client to ensure that client solutions and skills are adequate and appropriate. The therapist may also role-play situations with the client to allow the client a chance to practice skills in a hypothetical high-risk situation.

C. Problem of Immediate Gratification

The problem of immediate gratification (PIG) is the orientation of the client to smaller positive short-term consequences with larger adverse long-term consequences, rather than adverse or unwanted short-term consequences for a more beneficial long-term consequence. With smokers, the immediate relief from withdrawal symptoms provided by a cigarette is the proximal consequences, while emphysema, lung cancer, and death are more distal consequences. To address the PIG, the therapist typically employs psychoeducational approaches to teach the client how to create a decision matrix. This is usually a written exercise, in which the matrix contains the positive and negative outcome expectancies for engaging or not engaging in the problematic behavior, in both the immediate and short-term frame of reference. The therapist then confronts any unrealistic outcome expectancies until the client is able to generate more realistic outcomes. Following this, the therapist directs the client to analyze past situations in which the patient engaged in the problematic behavior, and to compare the immediate gratifications against the long-term consequences.

D. Abstinence Violation Effect

The abstinence violation effect (AVE) highlights the distinction between a lapse and relapse. Put simply, the AVE occurs when a client perceives no intermediary step

between a lapse and a relapse. For example, overeaters may have an AVE when they express to themselves, "one slice of cheesecake is a lapse, so I may as well go all-out, and have the rest of the cheesecake." That is, since they have violated the rule of abstinence, they "may as well" get the most out of the lapse. Treatment in this component involves describing the AVE, and working with the client to learn alternative coping skills for when a lapse occurs, such that a relapse is prevented. The AVE occurs when a client is in a high-risk situation and views the potential lapse as so severe, that he or she may as well relapse. The client and therapist will practice identifying and coping with lapses. The treatment is not lapse prevention; lapses are to be expected, planned for, and taken as opportunities for the client to demonstrate learning. It is relapse prevention. Most often, relapse tends to be construed as a return to pretreatment levels of occurrence of the targeted behavior. Although there is some debate about the best definitions of lapse and relapse from theoretical and conceptual levels, these definitions should suffice.

E. Outcome Expectancies

An example of skills training is seen when addressing outcome expectancies. The client is asked to construct a decision matrix: on one dimension, the choice of offending versus not offending, on the second dimension, the positive and negative outcomes, and on the third dimension, the short- and long-term consequences. Often, the client will not generate accurate outcomes, and is instructed in more likely outcomes for their offending and nonoffending behaviors. Another component in some manifestations of RP is enhancing victim empathy. Clients are asked to do a variety of tasks, such as watching a videotape of victims telling of the effects of their victimization, imagining how the client and a loved one would feel if victimized, and writing a letter from the victim's point of view.

F. Cognitive Distortions

Therapists trained in CBT often find it necessary to address the client's cognitive distortions when dealing with clients who engage in problems of self-control. In 1989, as part of Laws's book on RP for sex offenders, Katurah Jenkins-Hall described the steps for changing cognitive distortions in sexual offenders as identification of the thoughts that lead to maladaptive behavior, analyzing the validity and utility of the thoughts, and an intervention designed to change the cognitive distortions into more adaptive cognitions. Jenkins-Hall

details how cognitive therapy can be adapted to sexual offenders. Step one is providing alternative interpretations in that the “client is taught that his initial interpretation of a given situation may not be the most accurate. He is asked to generate a list of alternative explanations.” Step two, utilitarian counters, asks the client to evaluate whether his thinking assisted or hindered the achievement of the desired outcome (e.g., did having a biased interpretation of the victim’s behavior make it easier for you to justify your actions to yourself?). In step three, objective counters, the therapist helps the client analyze the logic behind certain types of thinking. Step four, disputing and challenging, is based in Ellis’s rational emotive therapy. In this stage the client is asked to identify irrational types of thinking and beliefs, and these irrational statements and beliefs are challenged in therapy.

G. Social Skills

Another common problem in some self-control problems relates to deficits in social skills. Clients may be misperceiving both verbal and nonverbal behaviors by those in high-risk situations. An ideographic assessment can be used to learn which, if any, key social skill deficits are present. The clinician should address relative deficits in perception, interpretation, response generation, enactment, and evaluation. In conducting social skills training with these clients, clients and therapists typically discuss the abstract principles of the particular class of social skills. The therapist then models the specific set of social skills. The client and therapist then role-play a situation that emphasizes the specific social skills relevant for the client. For example, for a client working sexually inappropriate behavior in the workplace, the client and therapist may role-play joke-telling situations, socializing, or other critical situations common at the workplace. The therapist would then provide feedback for the client regarding the skills present and absent during the role-play.

H. Aftercare

As with any therapeutic intervention, therapists are obligated to design a plan for aftercare. With RP, one of the essential elements of the psychoeducational process is instructing the client about the role of misbehavior in the context of one’s life. Although the goal of RP is the prevention of the occurrence of problematic behavior, the lifestyle must be addressed. The repairing of a damaged boat hull is an appropriate analogy. Patching the hole is well and good (reducing problematic behav-

ior), but the pilot of the boat should also learn not to run the ship aground, through rapids, or into icebergs (lifestyle balance).

Often, the development of positive addictions is presented. Positive addictions are healthy behaviors and hobbies, such as reading and bowling, in which the client can engage without experiencing adverse consequences. Lastly, each element of the RP approach, e.g., high-risk situation, the PIG, the AVE, and cognitive distortions are reviewed in the larger context of RP. For example, in work with sexual harassers, the harasser is directed to review the role of cognitive distortions as a component involved in sexual harassment, and then relate to how cognitive distortions are involved in the RP model.

I. Planning for Lapses

To dissuade the client from buying into the AVE, a realistic aftercare plan should include a plan for addressing lapses, because they are likely to occur. To plan for lapses clients should know how they would handle situations in which they feel at risk for engaging in the problematic behavior. What is the client’s support group? How will the therapist work with the client to devise strategies for seeking help, should the need arise after therapy? The therapist and client should also review plan to prevent a lapse from becoming a relapse. One way to do this is to practice these skills beforehand, for example, the client and therapist can role-play situations in which the client will need to ask a friend or loved one for help, call a therapist for an appointment, and tell a new friend about their history of problematic behavior and what the new friend can do to help the client when the client is in need.

There is gradual waning of the active role of therapy and the therapist in the client’s life. However, practitioners employing RP typically inform their clients that the clients will struggle with this problem for life, and they will likely never be “cured.” To enhance the gains made in therapy, and during RP aftercare for other primary interventions, RP sessions are often faded to biweekly, then later to monthly, then bimonthly, and sometimes continue annually for years.

J. Data on RP

In 1995 Gordon Nagayama Hall demonstrated the effectiveness of a community-based outpatient RP program for male sexual offenders, while Karl Hanson has spearheaded an effort to collect and organize data from an international pool of researchers on the effectiveness of RP programs with sex offenders. Most of

these studies were limited by a lack of random assignment to conditions due to ethical and pragmatic difficulties. The effectiveness of RP with other problematic behaviors has been demonstrated as well, specifically with alcohol, tobacco, and overeating. Efforts to gather increasingly informative treatment outcome data are extensive and ongoing. In general, there is some evidence that RP can be an effective intervention to prevent the reoccurrence of many problematic behaviors. However, there exists a disconcerting lack of data on the theoretical foundations of RP, such as covert pathways to relapse and the role of motivation in treatment success. For example, there has not been a clear demonstration of the necessary and sufficient internal and external conditions that will predict instances of lapses and relapses. What the field does have is a bevy of clinical experience across a broad domain of client problems, all suggestive that RP is plausible as well as popular with both clients and therapists.

IV. FUTURE DIRECTIONS

A. Denial and Minimization— Motivational Interviewing

A common problem in working with clients who would likely benefit from RP is the evaluation and treatment of denial and minimization. In their 1993 work with sexual offenders, William O'Donohue and Elizabeth Letourneau developed an intervention that was designed to help the client to admit to the offense and be motivated to seek and participate in therapy. An adaptation of their techniques to the treatment of general self-control problems would include presenting the probable outcomes of receiving versus not receiving treatment (e.g., gainful employment versus lower wage or no employment) and likelihood and consequences of future instances of misbehavior (e.g., if treated, lower likelihood of re-offense, if untreated, higher likelihood of re-offense and more severe consequences).

In addition, therapists have successfully used intervention of motivational interviewing (MI). MI has been shown effective in a variety of other RP treatment evaluations (see the 1991 edited work by Miller and Rollnick, *Motivational Interviewing*.) MI involves presenting the client's data in a matter-of-fact manner in which problems are not discussed, but rather, a simple review of the facts is performed. This is thought to allow the client to make an informed choice about engaging treatment.

B. Stepped Care

Stepped care involves the gradual introduction of interventions of increasing cost and severity. The initial interventions are the least intensive, most costeffective, and have the lowest response cost to the client and have the greatest possibility of success. If this level of intervention fails, then more intense, high-cost interventions are introduced. As the level of intensity increases, fewer clients should require that level of intervention. As the active components of RP are better understood, the treatment dose and content may be tailored to the individualistic problem such that resources are used efficiently. In addition, as RP techniques are better documented and available to clients, the involvement of RP therapists may become limited or obsolete in some cases.

C. Harm Reduction

Laws describes the change in focus between RP and harm reduction (HR) as a difference based on expecting an absolute cessation of the problem behavior (RP) as opposed to a manageable and acceptable reduction (HR). In his work with sex offenders, Laws describes as recognizing that offenders may have the occasional fantasy or desire to act out sexually. By owning up to this reality, Laws indicates that client and therapist goals can be more realistic. Furthermore, lapses, when they occur in the HR model, can be seen as learning experiences rather than failures.

V. SUMMARY

Relapse prevention was not produced as a stand-alone treatment derived from theoretically based and empirically supported foundations. Instead, RP was created as a supplement to existing treatments to address as the treatment failures seen in other therapies for problematic behaviors often conceptualized as problems of self-control. Furthermore, RP was not an "intervention" per se, but rather a structured aftercare regimen to assist in the maintenance of treatment gains.

Over the course of time, RP was taken from the research laboratories at the University of Washington and field tested with problem drinkers, smokers, overeaters, and sex offenders, to name only a few. In its many manifestations, RP addresses high-risk situations, the avoidance of those situations, the management of those situations, and skills for recovery after encountering those situations. The data on RP, while

sparse, suggest that RP is generally effective for a variety of self-control problems. The future of RP includes motivational interviewing, stepped care, and harm reduction, as well as further clarification of the theoretical underpinnings, mechanisms, and outcomes of relapse prevention.

See Also the Following Articles

Cost Effectiveness ■ Efficacy ■ Objective Assessment ■ Outcome Measures ■ Substance Dependence: Psychotherapy ■ Termination

Further Reading

Laws, D. R. (Ed.). (1989). *Relapse prevention with sex offenders*. New York: Guilford Press.

Laws, D. R. (1995). A theory of relapse prevention. In W. O'Donohue, & L. Krasner (Eds.), *Theories of behavior therapy: Exploring behavior change*. Washington, DC: American Psychological Association.

Laws, D. R., Hudson, S. M., & Ward, T. (Eds.) (2000). *Re-making relapse prevention with sex offenders: A sourcebook*. Thousand Oaks, CA: Sage.

Marlatt, G. A. (1998). *Harm reduction: Pragmatic strategies for managing high-risk behaviors*. New York: Guilford.

Marlatt, G.A., & Gordon, J.R. (Eds.). (1985). *Relapse prevention*. New York: Guilford Press.

Sandberg, G. G., & Marlatt, G. A. (1991). Relapse prevention. In D. A. Gravlo & R. I. Shader (Eds.), *Clinical manual of dependence*. Washington, DC: American Psychiatric Press.

Ward, T., & Hudson, S. (1996). Relapse prevention: A critical analysis. *Sexual Abuse: A Journal of Research and Treatment*, 8, 177–199.

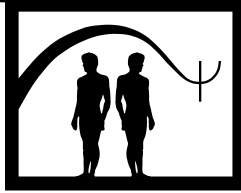

Relational Psychoanalysis

Spyros D. Orfanos

Stephen A. Mitchell Center for Relational Psychoanalysis

- I. Description
 - II. Historical Development
 - III. Theoretical Concepts
 - IV. Clinical Processes
 - V. Conclusion
- Further Reading

GLOSSARY

intersubjectivity A developmental achievement in which both individuals within a dyad recognize each other's subjectivity.

multiple selves The concept that people experience themselves not as unitary and unchanging but as consisting of multiple selves that may be compatible or incompatible with one another.

mutuality The idea that both patient and analyst participate in the analytic process, that they mutually regulate or influence each other, consciously and unconsciously.

projective identification A process by which the patient's disavowed feelings are projected onto the analyst who has become a container for the dissociated features of the patient's experience.

transference-countertransference matrix Transference and countertransference are interdependent, mutually determined experiences that are shaped by both patient and analyst.

I. DESCRIPTION

Relational psychoanalysis is an intensive form of psychotherapy that places human relations at the cen-

ter of motivation, psychopathology, and treatment. It is an alternative to classical Freudian psychoanalysis (including its modifications in psychoanalytic ego psychology). It considers relations to others, not drives, as the basic building blocks of mental life. From the relational perspective, individual experiences and the internal structures of the mind are viewed as deriving from and are transformations of relationships with significant others.

The term "relational psychoanalysis" is a relatively new coinage. It refers to a theoretical and clinical sensibility that integrates a variety of psychoanalytic theories that have evolved following the promulgation of Freud's seminal ideas. Thus, it is a contemporary eclectic approach that has been in a process of growth and development in the United States for the last 20 years. This new perspective includes recent developments within, and cuts across, U.S. interpersonal psychoanalysis, the British school of object relations, self psychology, and currents within contemporary Freudian theory. It is concerned with the intrapsychic as well as the interpersonal, but the intrapsychic is seen as constituted by the internalization of interpersonal experiences. Although these internalized interpersonal experiences may be biologically mediated, relational psychoanalysis is primarily concerned with the psychological determinants of experience.

There is considerable variation in the practice of relational psychoanalysis, but all relational analysts share a sensibility in which the therapeutic relationship plays a superordinate role in the treatment. Thus,

the analyst's subjectivity and personal involvement, including partially blinding entanglements, are given serious consideration. Gender, class, race, culture, and language are additional factors of great significance to relational analysts.

II. HISTORICAL DEVELOPMENT

The sea change that has been taking place in contemporary U.S. psychoanalysis in the last two decades is in sharp contrast to the popular view that modern-day psychoanalysis is a footnote to Freud. Psychoanalytic practice has evolved considerably since Freud's original creative contributions. Freud's body-based instinct (drive) model emphasizes intrapsychic conflict among id, ego, and superego as the child passes through the psychosexual stages of development. Interpretation, the main form of clinical intervention in Freudian analysis, is for the purpose of making unconscious content, such as sexual and aggressive impulses, conscious. In the Freudian model, relatedness is a derivative of the primary drives of sex and aggression.

The current paradigm shift away from the classical drive model to the relational model had its origins in the work of two psychoanalytic pioneers: the Europeans Sandor Ferenczi and Otto Rank. Both were students of Freud and in 1924 collaborated in exploring the primacy of experience in the here and now of the transference. After their collaboration, Ferenczi theorized about the mutuality of relationships in human development and clinical process. Rank went on to elaborate a theory of the birth of the self and the centrality of early relationships in the therapeutic interaction.

Working in the United States before World War II, Harry Stack Sullivan revised Freudian psychoanalytic ideas in his development of an interpersonal psychiatry. In an informal collaboration with Erich Fromm, Karen Horney, Freida Fromm-Reichman, and Clara Thompson, Sullivan came to disagree with the prevailing view of psychopathology as residing in the individual. He believed that human beings are inseparable from their interpersonal field and that focusing on the individual without considering past and present relationships is misdirected. Sullivan emphasized that human relatedness is a prerequisite of psychological well-being and a safeguard against anxiety. In treatment, he urged concentration on the here and now of the therapist-patient interaction. Subsequently, Thompson assembled the emerging concepts that constituted an interpersonal psychoanalysis and helped institutionalize them through the Washington School of Psychiatry and the William

Alanson White Institute in New York City. Over time, two different clinical approaches emerged in the interpersonal tradition: Sullivan's emphasis on empathy and tact and Fromm's emphasis on frankness and confrontation. In stressing the role of actual and specific interpersonal relationships in personality development and psychopathology, interpersonal psychoanalysis came to be caricatured as social psychology by the mainstream and medical psychoanalytic power circles of the day. In recent years, however, interpersonal psychoanalysis has gained increased acceptance with the elegant writings of Edgar Levenson, who stressed that what was talked about between analyst and patient was also concurrently being enacted between the two.

Contemporary British object relations theories began to have a significant presence in the United States in the 1970s. The theoretical and clinical innovations of the British school stressed the importance of the pre-Oedipal stage and especially the early mother-infant relationship. Emphasis was placed on the conflictual nature of internalized relationships to others. Moreover, nonverbal phenomena, regressed states, and the actual relationship between analyst and patient were also highlighted. Melanie Klein's theorizing about greed, envy, aggression, and projective identification also played an influential role. As represented by Michael Balint, W. R. D. Fairbairn, D. W. Winnicott, and Harry Guntrip, the British school of object relations was a thorn for U.S. Freudian psychoanalysis in that the centrality of the Oedipus complex was downplayed.

A third psychoanalytic paradigm that contributed to relational approach is self psychology. In the late 1970s, Heinz Kohut reformulated Freud's ideas, first in terms of the concept of narcissism and then in terms of theory and practice. He emphasized the chronic traumatizing milieu of the patient's early human environment, not the intense sexual and aggressive pressures that Freud had defined as basic to human motivation. He viewed aggression and rage in treatment not as an expression of a fundamental force but as result of deep vulnerability. The self psychology school of psychoanalysis developed into a powerful presence and influenced the thinking and practice of many.

In their more contemporary cast, these three schools of psychoanalysis seemed to be moving along similar paths, toward a focus on self-other relations, an interest in feelings and experience rather than drives, and toward a less authoritarian stance on the part of the analyst. Furthermore, the clinical focus is often on the patient-analyst relationship and the way in which small, but subtle interactions and enactments dominate the clinical situation.

Other theoretical influences in the development of a relational approach were the works of Hans Loewald and John Bowlby. Hans Loewald, a prominent ego psychologist in the 1970s, redefined id, ego, and superego in terms of interpersonal experience giving drives a relational character. He argued against the Freudian idea that the human mind can be an independent unit of inquiry without taking into account the analyst's participation. John Bowlby's work on attachment theory in the 1960s and the subsequent rich research on attachment has also played an important role in recent relation theorizing. Bowlby and his followers have placed intimate attachments to others at the "hub" around which a person's life revolves throughout the life span.

In 1983, Jay R. Greenberg and Stephen A. Mitchell published their landmark treatise, *Object Relations and Psychoanalytic Theory*, in which they distinguished two distinct approaches to psychoanalytic theory: the drive-structure model and the relational-structure model. Despite its title, their book was not only about object relations theories. It compared various models including interpersonal theory and self psychology. In addition to making detailed comparisons, the authors argued that theoretical positions in psychoanalysis are inevitably embedded in social, political, and moral contexts. They used the term relational to bridge the traditions of interpersonal relations, as developed within interpersonal psychoanalysis, and object relations, as developed within contemporary British theorizing.

During the early 1980s, Merton Gill, a prominent leader in U.S. ego psychology, published a series of articles recognizing the contributions of the interpersonal theorists and their views. He contrasted the drive model with the more humanistic model in which relationships are given primary importance. He identified the depth of clinical process and the exploration of transference-countertransference issues as the defining characteristics of clinical psychoanalysis. Later in the decade, the English translation of *The Clinical Diary of Sandor Ferenczi* was published after having been suppressed for more than half a century. Consisting of Ferenczi's clinical experiments with mutual analysis, it demonstrated an objection to the hierarchical arrangement of the traditional analytic relationship between an analyst who dispenses interpretations and a patient who receives them.

Conceptually, two other broad developments occurred in the last two decades of the 20th century that facilitated the development of relational psychoanalysis. The first development was feminism. It launched a major critique on Freudian notions by deemphasizing the phallogocentricity of its theories and practice. Sexuality was

unlinked from both physical constitution and reproductive function, and homosexuality no longer pathologized. Using a feminist approach, Jessica Benjamin published *The Bonds of Love* in 1988. This work masterfully argued the importance for psychoanalytic theory to include both an intrapsychic and an intersubjective perspective. The second development was constructivism, in its moderate postmodern form. Basically, psychoanalytic theorists have used a constructivist approach to critique essentialism, positivism, and any pretext to objectivity. Constructivism is used to understand transference not as simply a distortion emanating from the patient as in Freudian psychology. Transference, according to Irwin Hoffman, is viewed as involving the analyst's subjectivity in a process of co-creation with the patient. In his 1998 book *Ritual and Spontaneity in the Psychoanalytic Process*, Hoffman brilliantly critiques theorists such as Sullivan, Kohut, and Winnicott charging that they are similar to Freud in that they suggest that analysts can keep their own subjective experience from "contaminating" their patients' transferences.

Organizationally, relational psychoanalysis was greatly bolstered by four developments. The Division of Psychoanalysis of the American Psychological Association operating outside the control of the traditional American Psychoanalytic Association acted as a forum for the relationally minded psychoanalyst and allowed for numerous creative and scholarly panel presentations at its annual conferences. This in turn gave relational psychoanalysis a national network and identity. The second organizational development took place in 1988 at the New York University Postdoctoral Program in Psychoanalysis and Psychotherapy where a "relational track" was established to go along with its Freudian, interpersonal, and independent tracks thus adding a prestigious university training legitimacy to relational psychoanalysis. Third, the establishment of the highly successful *Psychoanalytic Dialogues: A Journal of Relational Perspectives* in 1990 led to further consolidation of the identity of relational analysts. Finally, the formation of the International Association of Relational Psychoanalysis and Psychotherapy is well under way and will be inaugurated with a clinical conference in New York City in January 2002 titled *Relational Analysts at Work: Sense and Sensibility*.

III. THEORETICAL CONCEPTS

As articulated by Jay Greenberg and Stephen Mitchell, there are at least two different and incompatible views of human nature in psychoanalysis. Drive

theory is derived from a philosophical tradition that sees a person as an essentially individual animal and human goals and desires as essentially personal and individual. In contrast, relational theory holds the philosophical position that a person is a social animal and that human satisfactions are realizable only within a social community. Consequently, the relational position is not interested in the single mind as a unit of study. It is interested in the relationship as a unit of study.

Although unconscious processes, the Oedipal complex, dreams, slips of the tongue, and free associations are of importance to relational theorists, they do not hold privileged positions. Wary of privileging any conceptual notion, relational theory nevertheless places the conscious and especially the unconscious relationship between patient and analyst at the heart of the therapeutic effort.

The relational matrix involves conflict, constructivism, and an overarching two-person perspective. Unconscious conflict is central to the drive model. In this model, the analyst strives to help the patient come to understand that sexuality and aggression are not as dangerous as they appear to be in the patient's fantasy-dominated child's mind. In the relational model, the traditional notion of conflict is maintained, but it is understood as containing conflicts over loyalties to parents, an idea attributable to W. R. D. Fairbairn's object relations theory. Thus, conflict is not located "in the person" but rather conflict may best be explained as both intrapersonal and interpersonal.

Constructivism in psychoanalysis holds that the observer plays a role in shaping, constructing, and organizing what is being observed. Psychoanalysis is a particular method for organizing what there is into unique patterns, but the patterns can be understood and organized in any number of ways. Thus, ambiguity and uncertainty are features of all human relatedness. This does not necessarily lead towards nihilism. On the contrary, it can propel theorists toward further elaboration and synthesis. For Irwin Hoffman, the paradigm shift in contemporary psychoanalysis is not necessarily from the drive model to the relational model, but from the positivist model to the constructivist model. Thus, the great divide is between dichotomous and dialectical thinking. What is meant by dialectic is a process in which each of two opposing concepts creates, informs, preserves, and negates the other, each standing in a dynamic relationship with the other. Among the pairs of phenomena Hoffman considers dialectically are doubt and certainty, possibilities and constraints, hierarchy and egalitarian relations; risk taking and responsibility; neurotic and existential anxiety; psychoanalysis as an instrument of healing and as cultural symptom; the an-

alyst's intentions versus the patient's will; action and reflection; and analytic rituals and the analyst's spontaneity. Last, constructivism in psychoanalysis holds that analytic therapists do not have privileged access to their own motives, nor are they able to know exactly what is best for their patients. Hence, the patient's perception of the analyst's subjectivity is critical.

Stephen Mitchell has argued that the distinction between a monadic theory of mind (a one-person psychology) and an interactional relational theory of mind (a two-person psychology) is pivotal to understanding psychoanalytic concepts. In general, those theories greatly influenced by classical analysis have been referred to as one-person psychologies. They emphasize the individual experience of the patient and view the analyst as a blank screen onto which the patient projects wishes and fantasies. The two-person psychologies are influenced by the notion of the analyst as co-participant in the therapy. Emmanuel Ghent has described the history of psychoanalysis as constituted by dialectical shifts between one-person and two-person psychologies. Neil Altman has added to the dialogue by suggesting that we consider not a one-or two-person psychology but a three-person psychology. A good example of a three-person psychology would be thinking through the therapeutic relationship as it operates in a particular clinic or in conjunction with a specific insurance company.

Another important concept in relational psychoanalysis is that of intersubjectivity. Jessica Benjamin's work on intersubjectivity emphasizes mutual recognition as an intrinsic aspect of the development of the self. She argues that we need to maintain a tension in our theory between relating to others as objects and relating to others as separate subjects. The infant research of Daniel Stern on the development of a sense of self yields evidence for intersubjective relatedness, a relatedness that includes the recognition of subjective mental states in the other as well in oneself. By contrast, for Robert Stolorow and his colleagues, the term intersubjective is applied whenever two subjectivities constitute the field, even if one does not recognize the other as a separate subjectivity.

Recently, relational thinkers have been hypothesizing about how the mind is structured in an effort to redefine notions of the self. The self has usually been thought of as a continuous, unitary phenomenon. Philip Bromberg has described a state of multiple selves. This concept holds that people experience themselves not as unitary and unchanging but as consisting of multiple selves that may be compatible or incompatible with one another. For example, an adult self may be taking in a logical

explanation about an interaction, while at the same time a child self simply feels vulnerable and angry. Multiple self-states are created not by unmet developmental needs, but by unintegrated, sometimes traumatic, early interactions with significant others. The therapeutic goal is to bring the different self-states into awareness and into a useful dialogue and not necessarily integration. For Jody Messler Davies multiple selves suggest a central role for the process of dissociation and consequently a very different vision of the unconscious. Unlike drive theory that utilizes the metaphor of an onion or an archaeological site for the unconscious, Davies prefers the metaphor of a kaleidoscope with which each glance through the pinhole of a moment in time provides a unique view and an infinite constellation of interconnectedness.

A fundamental principle in the relational model of psychoanalysis is that of mutuality. Mutuality is a process in which patient and analyst mutually regulate or mutually influence each other both consciously and unconsciously. What is regulated is subtle, but it can often involve feelings, thoughts, and actions. Heinrich Racker pointed out that analysis is not an interaction between a sick person and a healthy one, but rather an interaction between two personalities, each with healthy and pathological dynamics. Thus, the classical authority of the analyst has given way to a more democratic, respectful exploration of a joint reality. Mutuality means that the analyst and the patient are partners in the treatment, albeit unequal ones. This mutuality requires a certain type of emotional honesty from both participants. In the relational model, the analyst cannot function as a blank screen or a detached observer encouraging intense feelings in the patient and responding in a neutral manner. When mutuality in the clinical process is taken into account, dialectical tensions can arise. One such dialectical tension occurs between the patient's sense of the analyst as a person like himself or herself and the patient's sense of the analyst as a person with superior and magical power. Although the analyst engages in relative subordination of personal interests, the resolution of such tensions can be powerful emotional experiences for both participants.

IV. CLINICAL PROCESSES

The clinical attitude conveyed by a relational analyst depends very much on the particular analyst's personality, training, and the specific impact of a particular patient. She does not act as a judge of reality and nor does she presume that there is only one way to see something

accurately. The patient's own sense of reality is greatly respected and encouraged. Compliant surrender to the analyst's presumed superior vision is not encouraged. The patient's observations and perceptions about the analyst are encouraged. Notwithstanding these attitudes, it is likely that there will develop repetitive reenactments of some of the most warping features of the patient's earlier experiences. These reenactments will likely involve the analyst and consequently also involve a range of feelings from attraction to conflict in relation to the analyst.

To a large extent, traditional analysis requires that the analyst interpret the true meaning of the patient's reactions to her. In contrast, when a patient feels discontent with her analyst, the relational approach requires both parties to examine how and why they are in conflict and to negotiate the conflict as best they can. This is a shift involving a move away from interpreting observer to active participant. The in-depth exploration will require that both parties track the way the patient's observations lead to conclusions about the analyst and how they might be reenactments in the here and now of earlier relationship difficulties.

Clinical psychoanalysts have tended to centralize the experiences of early childhood. The relational orientation acknowledges this importance as well, but it does not consider the uncovering of the past to be the major task of treatment. In the classical approach, the patient's problems are the result of repression; cure entails the release of impulses, fantasies, and memories from repression. The analyst interprets both the content of the repressed and also the ways the patient is defending against the content. The analyst helps the patient gain insight thereby releasing from repression unconscious conflicts and thus being cured. A number of relational approaches, particularly the British object relations school and the self psychology school, assume that from the moment of birth, the child's whole being has developed in the context of experiences with others. Normal development is thwarted due to inadequate parenting. What is curative in the analytic relationship is the analyst offering some form of basic parental responsiveness that was missed early on. The interpersonal approach regards the analyst's response to the patient as organized not along parent-child lines but rather along adult-to-adult lines requiring honest responses and engagement. Hence, relational analysts differ with respect to their use of efforts to reanimate stalled developmental processes or their use of frankness and authentic confrontations. For many espousing a more integrated relational approach, however, the belief is that the patient can be both child and adult. Both

the realities and the fantasies of early childhood experiences are important to understand in detail, but the realities and fantasies of adulthood are also important to understand in detail.

In the most general sense, all psychoanalytic treatment paradigms value the analysis of transference. The relational paradigm, however, considers more than just the transference; it values the transference–countertransference matrix. Transference represents the emergence of feelings toward early childhood figures, displaced onto the person of the analysts. Historically, countertransference is the displacement of feelings from the analyst's past into the analytic situation. This was considered a seriously negative developmental in the analysis. The analyst was enjoined to rid herself of it through self-analysis or to return to her own psychoanalyst for help. Relational analysts have a different approach. They believe that countertransference is a normal state of affairs and that it can advance the analytic work. The transference–countertransference matrix is mutually determined and shaped by the conscious and unconscious beliefs, hopes, fears, and wishes of both patient and analyst.

The clinical approach of the relational model holds that the analytic situation is more than an arena for playing out the past; it is also where the patient is firmly engaged in the present. Thus, the patient is not simply displacing feelings from earlier relationships onto the analyst; he or she is likely to have observed a great deal about the analyst and to have constructed a plausible view of her. This view is, in part, based on the patient's own past and his typical way of organization experience. For example, an analyst can be experienced by a patient as critical of certain actions on the patient's part, and indeed that may be an opinion of the analyst. However, an in-depth exploration of a patient's observations about the analyst can show that the criticism is different from the patient's mother and does not require allegiance from the patient for a personal connection to be maintained.

With the qualification that indeed psychoanalysts can suffer from the very same problems they are trying to assist patients with, relational ideas stress that countertransference can be (a) an ordinary, common responses to the sort of interpersonal positions and pressures a patient can set up; (b) an analyst–patient reenactment of a patient's past relationships; (c) a complex result of the patient's projective identification; and (d) something the patient is doing to strike responsive chords in the analyst.

Given that all analysts have a less than complete understanding of their own defenses, and that the patient

may have picked up features of the countertransference that the analyst is not aware of, some analysts like Lewis Aron and Irwin Hoffman have argued for the usefulness of extended explorations of the patient's experience of and hypotheses about the analyst's experience. Such explorations give permission to patients who grew up feeling that their perceptions of their parents were forbidden and dangerous, and discounting their own observations albeit subtle and sometimes unformulated. Aron prefers to speak of the analyst's subjectivity instead of the analyst's countertransference. He believes that the term countertransference implies that the analyst's experience is reactive rather than subjective. The patient's perception of the analyst's subjectivity does not replace the historical analytic focus on the patient's experience, but it is seen as one component of the analysis.

To a large extent, relational analysts view self-disclosure as a form of intervention. It may involve the analyst revealing to the patient information, such as her thoughts or feelings about an interaction, something about the analyst's personal life, or the analyst's values and biases. Although the information may be useful, it is not disclosed as oracular. Other information besides the analyst's countertransference is necessary to confirm an idea about the patient's experience or to provide an interpretation. Nonetheless, many relational analysts believe that judiciously chosen self-disclosures can be helpful.

Finally, the two-person framework is interactive and makes more demands on the analyst to be attentive to the field—from disclosures that may momentarily focus attention on the analyst's mind, through analysis of interaction, to interpretation of the patient's intrapsychic activity. Clinical techniques are not to be objectified into a hard set of rules and regulations. Rather, psychoanalytic techniques are an interlocking set of clinical concepts that the analyst uses as a framework for analyzing the unique interactive matrix. The dialectical tension between the rules of restraint in the analytic relationship and the analyst's personal participation is a major controversy in contemporary psychoanalysis. The relational framework considers the joint critical reflection of such dialectical events crucial to the clinical process.

V. CONCLUSION

Relational psychoanalysis is a selective integration of various theoretical approaches. Its origins can be traced to contributions by various psychoanalysts and schools of psychoanalysis primarily interpersonal psychoanalysis, British object relations, and self psychology. In the

last two decades it has evolved dramatically in the United States and is now the major challenge to the traditional Freudian school of psychoanalysis. Its current state of theoretical development and clinical innovations may make it a revolutionary challenge.

A major premise of relational analysis is that one's history of early relationships and present realities are critical. While classical Freudian theory holds that relatedness is a derivative of instinctual drives, relational theory considers relatedness to be at the center of human development and psychotherapy. In the clinical situation, relational analysts continuously track both the patient's subjectivity and their own. The relational matrix is understood to involve mutuality, conflict, and co-creation. Overall, the aim of relational psychoanalysis is to enrich the patient's experience, to expand the patient's degrees of personal freedom, and to examine the enormous complexities of the mind.

The success of the relational turn in psychoanalysis is consistent with a whole range of movements in other intellectual disciplines such as postmodernism. However, perhaps the major reason for its success is that it has proven to be a more useful approach to the problems in living that are presented in the consulting room of today. This utility in the day-to-day clinical work is based not on empirical research, which relational thinkers believe is only one of many narratives that can be useful, but on rigorous thinking, honest self-reflection and continuous cross-checking with clinical experience.

See Also the Following Articles

Acceptance and Commitment Therapy ■ Countertransference
 ■ History of Psychotherapy ■ Object-Relations
 Psychotherapy ■ Self Psychology ■ Sullivan's Interpersonal
 Psychotherapy ■ Transference

Further Reading

- Altman, N. (1995). *The analyst in the inner city*. Hillsdale, NJ: The Analytic Press.
- Aron, L. (1996). *A meeting of minds: Mutuality in psychoanalysis*. Hillsdale, NJ: The Analytic Press.
- Benjamin, J. (1988). *The bonds of love: Psychoanalysis, feminism, and the problem of domination*. New York: Pantheon Books.
- Bromberg, P. M. (1998). *Standing in the spaces: Essays on clinical process, trauma, and dissociation*. Hillsdale, NJ: The Analytic Press.
- Davies, J. M., & Frawley, M. G. (1994). *Treating adult survivors of childhood sexual abuse: A psychoanalytic perspective*. New York: Basic Books.
- Greenberg, J. R., & Mitchell, S. A. (1983). *Object relations in psychoanalytic theory*. Cambridge, MA: Harvard University Press.
- Hoffman, I. Z. (1998). *Ritual and spontaneity in the psychoanalytic process: A dialectical-constructivist view*. Hillsdale, NJ: The Analytic Press.
- Mitchell, S. A. (2000). *Relationality: From attachment to intersubjectivity*. Hillsdale, NJ: The Analytic Press.
- Mitchell, S. A., & Aron, L. (Eds.). (1999). *Relational psychoanalysis: The emergence of a tradition*. Hillsdale, NJ: The Analytic Press.

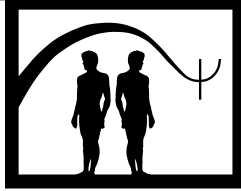

Relaxation Training

Daniel W. McNeil and Suzanne M. Lawrence

West Virginia University

- I. Description of Treatment
 - II. Theoretical Bases
 - III. Empirical Studies
 - IV. Summary
- Further Reading

I. DESCRIPTION OF TREATMENT

“Relaxation training” is a general term that refers to methods that are used to teach and learn specific techniques to help people moderate or control reactivity or arousal that is problematic to them. Often this term is associated solely with muscle relaxation, but given the commonalities among all relaxation-induction methods, we use it as an omnibus term. This label, then, includes various arousal control methods, such as muscle relaxation training, autogenics, biofeedback, meditation, imagery, and paced breathing. Hypnosis, often used to induce relaxation, has many similarities with these other methods, but is not reviewed in this article. The hyperarousal targeted by these techniques often is considered to be physiological (e.g., muscle tension), but can be cognitive (e.g., intrusive thoughts) or behavioral (e.g., fidgeting) as well. The widespread use and effectiveness of relaxation training have led some to call it “behavioral aspirin.” The “training” component of relaxation training implies that it is a skill learned by someone, often a client or patient in a clinical setting, who ultimately can utilize it to induce relaxation on his or her own, in a variety of situations and settings. This procedure for producing relaxation then distinguishes it from other methods that are evoked by other persons (e.g., massage therapy) or substances (e.g., anxiety-reducing medications).

GLOSSARY

- autogenics** Use of autosuggestions to evoke relaxation responses.
- autosuggestion** Process by which clients make self-statements, usually silently, that they then accept and believe.
- biofeedback** Integration of physiological assessment instrumentation (e.g., to record the temperature of the skin surface on one’s finger) with audio or video stimuli (e.g., an outline of a human hand on a video monitor, with different colors indicating varying skin temperatures) to help a client learn to control physiological functions (e.g., skin temperature, muscle tension).
- imagery** Set of mental stimuli, existing cognitively, that can encompass all the senses (i.e., sights, sounds, tastes, smells, and tactile cues) that can be used to evoke a particular emotional or cognitive state (e.g., attention).
- meditation** Act of focused, quiet contemplation used to achieve a relaxed state.
- patter** Slow, rhythmic speech used by a therapist to maintain and enhance relaxation; repetition of statements often is involved.
- relaxation** Reducing or preventing levels of reactivity or arousal, in physiological, behavioral, or cognitive realms, which are so high as to constitute a problem.

A. The Role of Relaxation Training in Behavior Therapy

Relaxation training often is used in behavior therapy as a means to reduce anxiety, tension, and stress. Research has shown it to be effective in a variety of disorders and conditions, primarily those related to anxiety, fear, and stress (e.g., specific phobias), but including those in the realm of behavioral medicine and dentistry, such as acute and chronic pain (e.g., tension headaches), hypertension, and coping with nausea related to chemotherapy. Training patients to relax typically involves providing a rationale, demonstrating exercises, and practicing relaxation in treatment sessions in clinics and hospitals. In addition, patients almost always are asked to practice (“homework”) between therapy sessions. Often, forms or log books are used for patients to record details about their practice. Relaxation training can be relatively brief or long and more comprehensive. The former type has been referred to as “abbreviated” and the latter method as “deep,” and has been associated with muscle relaxation.

Relaxation is a crucial ingredient in many empirically supported contemporary psychosocial treatments for various disorders, including such therapies as the Mastery of Your Anxiety and Panic program, which is a treatment for panic disorder. Relaxation training, in its various forms, is used most often as an adjunctive intervention, comprising one part of a comprehensive treatment program. Relaxation training also can be used to help facilitate communication during a therapy session with a client who may be too tense or anxious to communicate effectively with the therapist. Relaxation training (especially progressive muscle relaxation) often is used in conjunction with systematic desensitization, a procedure designed to lower fear or anxiety toward a specific stimulus (or stimuli) by pairing the feared stimulus or thoughts of the feared stimulus with relaxation.

B. Types of Relaxation Training

1. Progressive Relaxation Training

Progressive relaxation training (PRT) focuses on muscle relaxation; it is a widely used relaxation technique in behavior therapy, and has been the subject of considerable empirical research. Under the direction of the therapist, the client alternately tenses and then relaxes isolated muscle groups, until the entire body is completely relaxed. The rationale is that tensing the muscles before attempting to relax allows the client to become more aware of muscle tension, so as to be able to identify

it when it occurs. The contrast between the tense and relaxed states also may help the client achieve a deeper state of relaxation than would be possible when beginning from a resting state. By focusing on the feelings of tension and relaxation, the client can even learn to induce deep relaxation at a later time by using a recall procedure, allowing him or her to achieve a similar state of relaxation without actually creating muscle tension.

The exercises of progressive relaxation training follow a general sequence of individual muscle groups; each muscle group is relaxed as completely as possible before moving on to the next one. The most common contemporary methods include 16 muscle groups. As training progresses, the muscle tension exercises can be combined into 8 and then 4 groups. The specific order of muscle groups used varies according to the practitioner and his or her adherence to a particular sequence recommended in the literature, as well as to individual needs of the client. One possible sequence involves the following order:

1. Right (or dominant) hand and forearm
1. Right (or dominant) biceps
2. Left (or opposite) hand and forearm
3. Left (or opposite) biceps
4. Shoulders and upper back
5. Neck
6. Lower cheeks and jaws
7. Upper cheeks and nose
8. Forehead
9. Chest (breathing)
10. Abdominal region
11. Right (or dominant) thigh
12. Right (or dominant) calf
13. Right (or dominant) foot
14. Left (or opposite) thigh
15. Left (or opposite) calf
16. Left (or opposite) foot

The entire procedure is carefully controlled by the therapist; each exercise is precisely timed. Muscle tension is maintained for 5 to 7 seconds, during which the clinician may make such statements as “feel the tightness of the muscle; notice what the tension in the muscles feels like.” The therapist will then instruct the client to relax, and make statements to direct the client’s attention to the feelings of relaxation. This relaxation “patter” is used to capture the client’s attention, to soothe and to encourage focusing of attention, and to promote quiescence. The relaxation part of the cycle continues for 30 to 40 seconds, after which the tension-release cycle is

repeated. During early sessions of progressive relaxation training, the tension-release cycle typically is performed twice on each muscle group to ensure complete relaxation. In later sessions, after the client is familiar with the feelings of tension and relaxation, the procedure is often abbreviated, as already noted, to fewer steps by tensing combined muscle groups (i.e., both legs simultaneously instead of each leg individually).

Once clients are comfortable with the briefer procedure, a recall procedure may be taught that can be used in a wider variety of settings. This “cue-controlled relaxation” does not involve any actual tensing of the muscles, but rather the client recalls the feelings of relaxation using a cue word such as “relax.” The cue word is paired with relaxation in treatment sessions and becomes associated with the feeling of deep relaxation through conditioning. Another use of PRT is in differential relaxation training, in which clients are taught to recognize the muscles that are necessary in which activities (e.g., while standing) so that one can ensure that muscles not involved in that activity have minimum tension.

Edmund Jacobsen pioneered PRT in the 1930s. In his research, he found that persons who deeply relaxed their skeletal muscles did not show a normal startle response. Expanding on these findings, he developed a technique in which alternately tensing and releasing individual muscle groups, and learning to attend to and discriminate between the feelings of tension and relaxation, could moderate tension and produce relaxation. In the 1940s and 1950s, progressive relaxation training came to the attention of Joseph Wolpe, who in his research with cats, had discovered that a conditioned fear response could be diminished and even eliminated if an incompatible response (such as relaxation) was induced at the time of fear. Wolpe shortened Jacobson’s methods, to make it feasible to use them in clinical settings. He used PRT in conjunction with systematic desensitization, as a way of producing relaxation during the reconditioning of fears in clinical patients. In 1973, Douglas Bernstein and Thomas Borkovec also streamlined Jacobson’s approach, and produced a step-by-step treatment PRT manual for therapists. Since that time, there has been a great deal of research on PRT, and numerous variants and extensions of it have been forwarded.

2. Behavioral Relaxation Training

In 1988 Roger Poppen published a book on behavioral relaxation training (BRT), a variant of PRT based on modeling and operant conditioning. Like progressive muscle relaxation training, it emphasizes overt motoric behavior, which is important because it facilitates

direct observation of the behavior by both the client and the therapist. Behavioral relaxation training is unique from progressive muscle relaxation training in its emphasis on observable behavior, including posture. Clients are instructed to observe their overt postures, as well as to be aware of feelings of relaxation. BRT also is somewhat different from progressive relaxation in that it is composed of four discrete steps for each of 10 postures or activities, including the hands, breathing, and other components very similar to that of PRT.

1. *Labeling*: A one-word label (e.g., feet) is assigned to each behavior (or posture) to facilitate communication between client and therapist.

2. *Description and modeling*: The therapist explains and demonstrates the relaxed posture, and contrasts it with frequently occurring unrelaxed postures.

3. *Imitation*: The client displays each posture.

4. *Feedback*: The therapist praises accurate posture portrayal, or provides corrective cueing if the client’s posture is incorrect. Gentle manual guidance may be used by the therapist if the client is unsuccessful in achieving correct relaxed postures after several attempts. Positive feedback is then given for the correct postures.

The client maintains each correct posture for 30 to 60 seconds while being aware of the relaxation feelings. There are specific postures or behaviors for the hands, feet, body, shoulders, head, mouth, throat, quiet breathing, and eyes.

As a method of behaviorally assessing relaxation, Poppen devised the Behavioral Relaxation Scale (BRS). There are 10 descriptions of postures and activities in the BRS that are considered to be characteristic of one who is completely relaxed. Relaxation is assessed during an observation session at the conclusion of the session, or before relaxation as a baseline measure. Although the BRS was designed for use with BRT, it can also be used to assess relaxation induced by other methods.

Poppen proposed a taxonomy for analyzing complex behavior that can be easily applied to relaxation. His conceptualization of behavior is that it occurs in four domains: motoric, verbal, visceral, and observational. Poppen claimed that most relaxation techniques emphasize only one or another of these modalities while ignoring the others. BRT is intended to address all four of these areas.

3. Applied Relaxation

Another variant, and an extension of PRT, is applied relaxation, which was described by Lars-Goran Öst in

1987. It is conceptualized as a coping technique that focuses on physiological reactions when a person encounters a phobic object or situation. The intent is for the relaxation skill to be applied rapidly when confronted with such an event, to foster coping. Applied relaxation is intended to counteract, and later to prevent, phobic-level physiological reactions. Training includes the recognition of anxiety signals early in the chain of reactions to phobic events. PRT is then taught, followed by a shortened version in which only the relaxation (or muscle release) component is included. Cue-controlled relaxation is then reviewed, followed by differential relaxation. A somewhat unique component of applied relaxation is its focus on rapid relaxation in the natural environment. Then, application training ensues, first in generally stressful but nonphobic situations, and later in actual exposure to phobic objects or situations.

4. Stretch Relaxation

Much like PRT, stretch relaxation also is based on achieving a quiescent state through decreased muscle tension. The major distinction is that stretch relaxation does not require the individual to tense and release muscle groups. Rather, the reduction in tension is achieved through the systematic stretching of individual muscle groups. This technique was developed by Charles Carlson and colleagues, in part because some patient populations find the tensing and releasing of muscles painful or distressing, or that it is inappropriate for them. For example, some pain patients find that tensing their muscles increases pain and does not readily allow subsequent relaxation. Patients with certain cardiovascular problems, such as patients in whom creating muscle tension could cause arrhythmias or elevated blood pressure, also may be inappropriate candidates for progressive muscle relaxation. Stretch relaxation training is often an effective alternative treatment for these patients.

The process involves a series of 14 muscle-stretching exercises. Prior to the actual stretching exercises, the individual is instructed to assume a quiet resting position and breathe slowly and deeply. After 3 to 4 minutes of physical resting and relaxed breathing, the client or patient begins the stretching exercises, starting with the lower right leg and progressing through the 14 muscle groups. Similar to PRT that involves muscle tensing, stretching is utilized for the separate muscle groups in the extremities, back, buttocks, stomach, chest, forehead, eyes, jaws, neck, and shoulders. Examples of stretching exercises are those for the upper leg, in which

one knee is raised and placed over the other leg to sag, and those for the shoulders and upper arms, in which the fingers of the hands are interlocked and the arms are raised over the head.

Each stretch is held for 15 seconds, and is followed by 60 seconds of relaxation. Clients are instructed to focus their attention on the sensations of stretching and relaxation and to breathe using a slow, regular rhythm.

5. Autogenic Training

Autogenic training (AT) is a passive autosuggestion technique with the goal of self-produced relaxation with a minimal amount of training. AT is used extensively in Europe, Russia, and Japan, but is less popular in North America. Some of the conceptualizations and wording are not common in American culture. In contrast to progressive muscle and stretch relaxation, AT is passive rather than active. It consists of six mental exercises that are based on short autosuggestions, or "formulas." Sensory feelings and states are emphasized, including heaviness and warmth in the extremities, regulation of respiration and cardiac activity, abdominal warmth, and coolness of the forehead. The therapist uses a calm, relaxed voice and makes statements about these feelings and physical states, which the client then repeats internally. The exercises are learned in a specific sequence, and the client achieves each state before initiating the next exercise. The six exercises or "formulas" are:

1. *Heaviness formula:* This exercise is intended to affect the muscles and reduce muscular tension. The therapist might utter a statement such as: "My left leg is very heavy."

2. *Warmth formula:* Blood circulation and dilation of blood vessels is the focus of this formula. The clinician focusing on this area with clients might suggest: "My right arm is very warm."

3. *Heart regulation:* Encouraging awareness of heart activity is the primary consideration, after which regulation of heart activity is the goal, consistent with statements such as "My heart is beating calmly and strongly."

4. *Breathing regulation:* Regular respiration is the key issue for this formula. Voluntary changes in breathing pattern are considered undesirable because that can involve tensing muscles and movement. Passive phrases are used, such as "It breathes me."

5. *Regulation of the visceral organs:* Clients focus their attention on the solar plexus as the central nerve center for the internal organs. A typical statement may be "Warmth radiates over my abdomen."

6. *Regulation of the temperature of the head:* Using statements such as “My forehead is cool,” clients imagine the feeling of a cool cloth on their forehead, with the result of localized movement of blood away from the surface of the skin (i.e., vasoconstriction) on the forehead, creating sensations of coolness.

Autogenic training developed along a similar timeline to progressive relaxation training. In 1932, a German physiologist named Johannes Schultz began developing AT as a passive form of controlling arousal. Early psychophysiological studies led him and his colleagues to assert that the state brought about by AT was unique, and different from conscious awareness, sleep, or hypnosis. Electroencephalograph (EEG) recordings during AT led to the conception of the autogenic state as similar to a “pre-sleep state.” Schultz believed that the shift from consciousness to the autogenic state was a specific process that involved changes in both psychological and physiological functioning, and allowed the person to “step behind” or “dive under” the usual conscious waking state. Schultz and his colleague Wolfgang Luthe believed that the mental and physical relaxation brought about by their procedure could eventually lead to relief from many physiological and psychological problems.

6. Biofeedback

The term biofeedback refers to a variety of procedures that provide ongoing information about physiological activity to persons attempting to learn to modify their physiological levels and responses. In particular, electromyographic (EMG) biofeedback is often employed as a relaxation technique to help people to control their levels of muscle tension. Thermal biofeedback also is common, in which the temperature of the skin surface is monitored, usually on a finger or foot, as increased blood flow to the skin surface is associated with relaxation. The general aim of biofeedback is to teach clients to use the feedback to gain conscious control of biological responses (e.g., skin temperature, heart rate) that have been operating maladaptively and that were previously thought to be uncontrollable. Biofeedback is shown to be effective across a variety of conditions, most notably anxiety disorders, tension headache, insomnia, and hypertension. In many cases biofeedback does more than teach individuals how to regulate their biological functions; it can also help improve their sense of personal control and ability to cope with stressful situations by showing that it is in fact possible to control the physiological events that accompany everyday life.

There are three major stages in biofeedback training. In the first stage, the client becomes aware of the maladaptive response (e.g., muscle tension) and learns that certain thoughts and biological events can influence the given response. The patient can relax some with a conscious effort. In the second stage, the client gains better control over the maladaptive response and can consciously relax with greater ease. The third stage marks the point at which the client can readily transfer the control to daily life, and can relax with little or no conscious effort.

Biofeedback training requires the use of instrumentation of varying degrees of sophistication. The essential requirement is that clients be provided with either visual or auditory information regarding their bodily state, usually in “real time,” as the person’s physiology is responding. The form of the feedback varies, can be shown visually on a video monitor, and/or can be transmitted by auditory tones or clicks, with higher or lower frequencies indicating the physiological response is increasing or decreasing.

Interest in biofeedback as a therapeutic technique burgeoned in the 1960s as a result of the work of various investigators. Among them, Joe Kamiya developed a technique of controlling alpha (EEG) rhythm by use of a tone to indicate that the brain was producing alpha waves. Second, Neal Miller demonstrated that autonomic responses could be conditioned through operant procedures in animals. Also, Thomas Budzynski and his colleagues built an alpha EEG feedback device with the intent of teaching subjects to produce more pleasant, tranquil alpha brain wave activity. Thereafter, attention shifted away from alpha feedback and toward skin surface feedback, generally measured through electrodes placed on the forehead to record facial muscle activity. This progression in research was based on investigations that found that the frontalis muscle of the forehead was a reliable indicator of anxiety, tension, and arousal. Over the years since this early research, EMG biofeedback has been demonstrated to be effective in helping clients to learn to reduce tension in the muscles of the head and scalp, thereby producing long-lasting reductions in tension headaches, among other uses.

7. Meditation

One of the currently most popular methods of relaxation is meditation. Examples are transcendental meditation and mindfulness meditation. In many forms, meditation enjoys widespread use across many lands and cultures. Quite old forms of meditation are involved in yoga practice; Japanese Zen, Chinese Tao, Hindu, and

Buddhist meditation are other forms. Some forms of meditation are associated with religious and spiritual beliefs about lifestyle. Others have no connection with religion or spirituality, but focus specifically on feelings of peacefulness and concentration. Across types of meditation, there are some qualities that are common to most or all of them.

First, meditation requires a comfortable position, usually sitting or lying down. Second, like other relaxation techniques, it usually must take place in a quiet, peaceful setting where interruption is unlikely. Thirdly, individuals regulate their breathing to a slow steady pace. Fourth, mental or cognitive activity during meditation often is focused on a particular word or phrase (e.g., a “mantra”). Some types of meditation, however, require the individual to empty the mind, think of nothing, and meditate on that mental silence.

One meditation technique that deserves special attention is one developed by Herbert Benson in 1975 termed “the relaxation response.” Benson based his technique on laboratory observations of practitioners of transcendental meditation. He found that during meditation, the oxygen consumption and blood lactate levels of his subjects dropped to levels similar to those seen in sleep or hibernation. He concluded that meditation led to a hypometabolic state, which he termed the “relaxation response.” Benson went on to specify a method to meditate in which one can achieve the desired response through four crucial elements:

1. *Quiet environment:* A quiet place is essential for meditation practice, so as to eliminate distracting noises. Also, in this and most other forms of relaxation, the client closes his or her eyes, to reduce distracting visual stimuli.

2. *Target object to dwell on:* The target can be a repeated word, phrase, sound, symbol, or image, or can involve focusing on a particular feeling.

3. *Passive attitude:* The individual should allow thoughts and feelings to drift in and out of awareness without concentrating on them. Ongoing self-evaluation of progress with meditation practice should be avoided. Maintaining a passive attitude was identified by Benson as the most crucial factor in eliciting the relaxation response.

4. *Comfortable position:* As with most forms of relaxation, it is usually necessary for the person to be in a sitting position that can be comfortably maintained for at least 20 minutes.

Although Benson’s technique has not been subjected to the same amount of empirical research as other tech-

niques such as PRT or biofeedback, it has enjoyed widespread popularity in the United States and elsewhere.

8. Guided Imagery

In the use of guided imagery, the therapist and client develop imagery scenes that produce feelings of calmness, tranquility, or pleasure for the client. It is critical that the therapist consult with the client as to the appropriateness of scenes, as a scene thought to be calming (e.g., sitting at a waterfall) may not be relaxing to a particular individual (e.g., one who is phobic of water). The scenes are embellished with as much sensory detail as possible, both to make the imagery seem more real and to completely involve or “absorb” the client in the experience. Common settings for guided imagery include the beach, a tranquil forest, or a mountaintop. Note the sensory detail in these scene instructions:

Close your eyes, sit back, take a few deep breaths, and relax. While your eyes remain closed, sitting in the chair and feeling relaxed, think about yourself on a tropical island. Make this image as real as possible, as if you really are there. As you look up, there are a few wispy clouds scattered across the brilliant blue sky. The turquoise ocean tumbles toward the shore in gentle, foam-capped waves. Gulls fly overhead; you hear their distant squawks. You feel the bright, warm rays of sun over your entire body and the light breeze blowing over your skin. You taste the salt from the air, as the wind blows in from the water. Walking along the beach, you encounter pleasing flowery scents from the nearby groves of tropical trees.

Actual scenes can be much longer. After the scene has been developed, clients are instructed to practice using the scene. In practicing, clients often focus on the scene for approximately 30 seconds, trying to picture, feel, and otherwise sense as much detail as possible. Over time, they should be able to readily and reliably evoke the image, leading to relaxation. It is possible also for clients to use the imagery to inoculate themselves from stressful or fear-provoking situations, or to mediate those reactions once they have begun. Guided imagery is often used as a distraction from pain during medical and dental procedures, or to combat anxiety during a feared situation.

Guided imagery relies somewhat on the clients’ abilities to vividly imagine scenes, so in clinical practice, it may be important for the therapist to assess the clients’ abilities in this area. Imagery ability can be assessed informally by asking clients to recall a particular event they enjoyed. Allowing clients to relax, the therapist then asks for as many details as they can provide, after

which clients rate the vividness of the image, for example, on a 1 to 10 scale. Another way to assess imagery ability is to use a rating scale in which the clients are instructed to imagine a variety of scenes and to rate the vividness of each. For clients whose skills are not well developed, imagery training can be employed to help them effectively utilize guided imagery.

9. Paced Breathing

Deep, regular breathing is a component of most relaxation training strategies. Many clients who experience problem levels of stress often have breathing-related complaints, and most of the symptoms associated with stress are those associated with hyperventilation. Variations in breathing patterns have an effect on cardiovascular functioning. Diaphragmatic breathing is a technique that teaches clients to breathe deeply using the diaphragm, expanding the abdomen rather than the chest. One of the most common ways of teaching diaphragmatic breathing is to have clients place their hand on the abdomen while breathing slowly. The client is instructed to breathe so that the hand on the abdomen raises up, minimizing any movement in the upper chest. Breathing in this manner allows the individual to inhale more air than normal shallow breathing. Deep breathing has been shown to release stress and tension, build energy and endurance, help with pain management, and to enhance mental concentration and physical performance. It can be taught as part of another relaxation technique or alone. Deep breathing usually is easily taught in one therapeutic session, and has the advantage that it can easily and unobtrusively be used by clients during the day whenever a stressful situation emerges.

C. Clinical Assessment and Treatment Issues

As with any treatment, assessment is a key issue in relaxation training. Identifying who can and cannot benefit from a given treatment is a critical consideration, although psychological science has not yet evolved to the point that it is known which treatments match to which clients. Those relaxation methods that focus on muscle tension or stretching may be particularly appropriate for clients who have high levels of tension and tension-related ailments, such as tension headache. Persons with highly reactive cognitive processes (e.g., worry, intrusive thoughts) may be well suited for those techniques that emphasize control over one's thinking. Relaxation skills can be taught in individual or group settings. There are numerous commercially available re-

laxation programs, including various media (e.g., audiotapes), for clients and therapists.

There are some considerations to be addressed in employing relaxation training. The first of these considerations is medical in nature. Before deciding on relaxation training, the clinician should ensure that medical problems have been properly evaluated, and that treatment has been provided or is ongoing. Many times, relaxation methods are a helpful adjunctive treatment for clients who have diseases (e.g., cardiovascular disease), and can be used in conjunction with medications. Another consideration is the possibility of contraindications to the use of relaxation training. Some clients (such as chronic pain patients, and those with temporomandibular joint [jaw] dysfunction) are advised not to tense certain muscle groups, so techniques that involve the tensing or stretching of muscles may not be the treatment of choice, although if only a few muscle groups are involved, the tension component can be skipped for them. Another issue to consider in using relaxation training is the source of the tension. If a person's tension is excessive or out of proportion to a situation, then relaxation training may be particularly appropriate. If, however, there is a life situation (e.g., marital disharmony) that is amenable to change that is leading to the problem tension, then addressing that problem directly (e.g., marital therapy) may be the treatment of choice. Another point to consider is that tension may be a conditioned response to some specific environmental stimuli. In this case, relaxation training alone may not be sufficient. Instead, systematic desensitization or *in vivo* exposure may be more appropriate. Finally, the preference of the client should be a prime consideration in choice of a relaxation strategy. As there presently are no hard and fast guidelines about which methods to use with which persons, client preferences may well be one of the most important factors currently in predicting treatment success.

Not everyone will benefit from relaxation training. Although it is rare, relaxation training sometimes can actually induce anxiety or even panic in some clients. There have been several explanations offered for such a reaction. One is that relaxation causes new and unusual sensations in the body, such as feelings of disorientation, or "floating." These unfamiliar feelings may provoke anxiety in some clients. Other patients may have a fear of losing control. It has been hypothesized that some people with chronic, pervasive anxiety may have learned to control their anxiety by never letting go or permitting themselves to relax. The feeling of loss of control associated with relaxation can cause excess anxiety in such individuals.

II. THEORETICAL BASES

By emphasizing “training,” the conceptual underpinnings of relaxation training obviously include learning. It is assumed that individuals learn a new skill, enhance existing abilities, or learn to utilize existing adaptive responses. Some individuals may need relaxation training because of extreme life circumstances (e.g., undergoing chemotherapy). Others may have a unique psychophysiology, behavioral functioning, or cognitive processing that predisposes them to psychological problems that are amenable to relaxation training. The problem response may either be chronic (e.g., hyperactivity in the muscles due to job-related stress), acute (e.g., intense response to a phobia, such as public speaking phobia), or both. Regardless of the reason for the problematic physiological, cognitive, or behavioral response, training is utilized to develop, enhance, or prompt relaxation-related skills.

There are elements of classical conditioning, operant conditioning, and observational learning in relaxation training. The relaxed state is classically conditioned to various stimuli (e.g., sitting in a dimly lit room, closing one’s eyes while sitting in a relaxed posture). Operant conditioning principles are employed, for example, when therapists use positive reinforcement for praising clients for proper use of relaxation procedures. When therapists model or demonstrate appropriate relaxation postures, for example, observational learning occurs. Moreover, in some forms of relaxation training (e.g., PRT), the individual is specifically taught to discriminate between tense and relaxed states. This training allows clients to discern more accurately tense and relaxed states, particularly in terms of muscle tension, which should allow them to prevent tension before it reaches problematic levels. In other types of relaxation training, the focus is on learning the relaxation response itself, and clients are encouraged to turn their attention away from impediments to relaxation (e.g., intrusive thoughts).

III. EMPIRICAL STUDIES

There is a wide body of literature that supports relaxation training as an effective therapy for a wide range of disorders. One problem with much of the existing data, however, is that most studies combine relaxation training with other forms of therapy; it rarely is used in isolation. Charles Carlson, who originated stretch relaxation, and a colleague, conducted a review in 1993 of 29 experiments with relaxation training. Their statistical analyses suggested that relaxation training is effective for a range

of disorders, particularly including tension headache. Individual training was found to be superior to group sessions, and training audiotapes for home practice were determined to increase treatment effectiveness. Longer treatment duration in each session, and greater numbers of sessions, also were associated with more positive treatment outcome. In addition to this “meta-analysis” of the findings of a number of studies, recent individual experiments also provide strong support for the effectiveness of various forms of relaxation training.

One example is an investigation by F. Dudley McGlynn and colleagues in 1999; they examined the effects of PRT on levels of fear and arousal during *in vivo* exposure to phobic stimuli. There were 10 snake phobic individuals who were given six sessions of progressive relaxation training, while another 10 were not. All participants were then exposed six times to a 4-minute viewing of a caged snake on a conveyor; they were able to control how close the snake came to them. The distance between the subject and the snake was measured, a self-report measure of fear was obtained, and heart rate and sweat gland activity were recorded. Data analyses showed that the individuals trained in progressive relaxation had significantly lower fear ratings, and a smaller degree of heart rate change, throughout the course of snake exposure. These findings support the use of PRT prior to *in vivo* desensitization procedures.

As another example, a study of applied relaxation by Lars-Goran Öst and a colleague in 2000 compared it to cognitive therapy in the treatment of generalized anxiety disorder. There were 36 patients who met criteria for this anxiety disorder who were randomly selected to receive either one or the other of the treatments. At posttreatment assessment, both treatment groups showed clinically significant and lasting improvements in a variety of areas, including worry, cognitive and somatic anxiety, and depression.

IV. SUMMARY

Varying types of psychosocially based relaxation inductions have been used across known history. In the latter part of the 20th century, and into the 21st century, empirically tested forms of relaxation training have become widely available. There are many commonalities among the various forms of relaxation training, but each has its own unique characteristics. Some of the differences among these methods are based on societal perceptions, and the different labels that are used to describe them. Some of the similarities of these methods include the client being in an environment relatively

free of distractions (e.g., a quiet, dimly lit room) so as to reduce distractions, reposing in a relaxed posture (usually sitting), focusing on a specific stimulus (such as the therapist's voice in PRT, or a "mantra" in meditation), and having guidance by a practitioner using a soothing voice and calm manner. Clinicians now have a wide array of relaxation methods to choose from, allowing more individualized treatment for clients with complaints including anxiety, hypertension, insomnia, pain (including tension headaches), and many others. As in any science, research will progress to reveal more information about relaxation and its beneficial effects and limitations, and techniques will continue to improve.

See Also the Following Articles

Anxiety Management Training ■ Applied Relaxation ■ Applied Tension ■ Biofeedback ■ Emotive Imagery ■ Progressive Relaxation ■ Stretch-Based Relaxation Training

Further Reading

- Benson, H. B. (1975). *The relaxation response*. New York: William Morrow.
- Bernstein, D. A., Borkovec, T. D., & Hazlett-Stevens, H. (2000). *New directions in progressive relaxation training: A guidebook for helping professionals*. Westport, CT: Praeger.
- Carlson, C. R., & Hoyle, R. H. (1993). Efficacy of abbreviated progressive muscle relaxation training: A quantitative review of behavioral medicine research. *Journal of Consulting and Clinical Psychology, 61*, 1059–1067.
- Cautela, J. R., & Groden, J. (1978). *Relaxation: A comprehensive manual for adults, children, and children with special needs*. Champaign, IL: Research Press.
- Davis, M., Eshelman, E. R., & McKay, M. (1988). *The relaxation & stress reduction workbook* (3rd ed.). Oakland, CA: New Harbinger.
- Jacobson, E. (1970). *Modern treatment of tense patients*. Springfield, IL: Charles C Thomas.
- Lichstein, K. L. (1988). *Clinical relaxation strategies*. New York: Wiley.
- Öst, L.-G. (1987). Applied relaxation: Description of a coping technique and review of controlled studies. *Behaviour Research and Therapy, 25*, 397–409.
- Poppen, R. (1988). *Behavioral relaxation training and assessment*. New York: Permagon.
- Wolfgang, L. (1990). *Autogenic training: A clinical guide*. New York: Guilford.

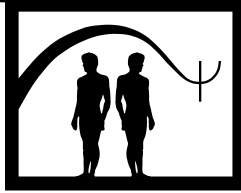

Research in Psychotherapy

Karla Moras

University of Pennsylvania

- I. Introduction
 - II. Historical Overview
 - III. Key Questions
 - IV. Concluding Comments
- Further Reading

GLOSSARY

effect size A statistic that often is used in therapy research to indicate the magnitude of the difference in outcomes (or “effects”) found in a research study between alternative treatments or between a treatment and an un- or minimally treated control group.

external validity A concept that refers to the inferences that can be accurately drawn from a research study’s findings, specifically the confidence with which findings can be assumed to “generalize” or extend to situations, people, measures, times, and so on other than those particular to the study. A study’s research design and methodology are major determinants of the external validity of its findings.

internal validity A concept that refers to the inferences that can be accurately drawn from a study’s findings, specifically the confidence with which a causal relationship can be assumed to exist between a study’s independent variables (e.g., forms of therapy) and dependent variables (e.g., outcomes or effects in a therapy study). The fit between a study’s hypotheses, research design, and methodology is a major determinant of its internal validity.

managed care corporation A for-profit business that sells health care insurance contracts to employers and to individuals. Managed care corporations differ from traditional indemnity

insurance companies in that the former directly oversee and control access to treatment by those who hold its contracts.

outcome research Studies that are designed primarily to test hypotheses and answer questions about the effects of psychotherapy and other treatments. “Outcome” is used as a synonym for “effects.” For example, outcome studies can be designed to answer comparative treatment questions like, “Is cognitive-behavioral therapy associated with more improvement in depression than interpersonal psychotherapy?”

patient In the therapy research literature one of two words, “patient” or “client,” usually is used to refer to a person who is the direct recipient of psychotherapeutic services. “Patient” typically is used in more medically dominated settings such as departments of psychiatry, “client” in more psychologically dominated settings such as university counseling clinics. Herein, the term patient is used.

psychoneurotic A global psychodiagnostic term that was in common use until about 1980. It connotes a wide range of problems that now (2002) are called anxiety disorders, unipolar depressions, and personality disorders in the American Psychiatric Association’s diagnostic nomenclature (*Diagnostic and Statistical Manual of Mental Disorders*). “Psychoneurotic” typically did not refer to what are considered more severe disorders such as schizophrenia and bipolar disorder.

psychopathology research A field that is focused on (a) distinguishing normal and abnormal human psychological, emotional, and behavioral functioning; (b) identifying causes for abnormalities; and (c) developing methods to assess and taxonomies for varieties of abnormal functioning.

psychotherapy Psychotherapy is used in this article as a synonym for “psychological therapies.” It refers to all forms of treatment in which the primary therapeutic agent is a person

(e.g., in contrast to an instrument or machine) who relies exclusively on verbal/conceptual, psychoeducational, or behavioral methods, rather than on pharmacological or other somatic methods (such as electroconvulsive treatment or rapid transcranial magnetic stimulation), to ameliorate a broad array of behavioral and psychological problems, many of which fall under the contemporary medical terms, “mental illnesses” and “psychiatric disorders.”

statistical significance A mathematically derived index of the probability that a research finding is valid versus due to chance.

I. INTRODUCTION

Psychotherapy research in the United States is a relatively young field, about 60 to 80 years old depending on the perspective taken. It encompasses a diverse array of activities, a uniting goal of which is to create a scientific foundation for the practice of psychotherapy. Alan Kazdin, a contemporary expert on psychotherapy research, described its aims this way: “To understand alternative forms of treatment, the mechanisms and processes through which these treatments operate, and the impact of treatment and moderating influences on maladaptive and adaptive functioning.”

A broad mix of research strategies and methods are used to achieve the preceding aims. They span a continuum from relatively “uncontrolled” methods (e.g., systematic, naturalistic observation) to experimental procedures that are used to control (reduce the potential impact of) some variables so that the operation of others can be observed more clearly and precisely. Psychology and, in particular, clinical psychology often are said to be the parent disciplines of psychotherapy research in the United States. Other disciplines, notably psychiatry, also have made important contributions to it from the outset. The relatively short history of psychotherapy research includes marked shifts of focus (“turning points” herein), as well as scientific advancements (“milestones” herein). The field also has some long-standing, unanswered fundamental questions.

One goal of this article is to convey the dynamic nature of psychotherapy research—its responsiveness to social issues, government needs for information on which to base policy, developments in related fields—as well as to its own discoveries and other advances. A second goal is to provide an overview of some of the field’s defining, substantive features as they have evolved to the present. The features described are primarily key research questions. A few, related research methods also are described. Detail on the conduct of

psychotherapy research is not provided, nor are findings on different questions reviewed in depth. Relevant research methods (e.g., study design, measurement, statistical data analysis strategies) are extensive and are well described in many excellent sources, a few of which are listed in Further Reading. Similarly, sophisticated and comprehensive reviews of findings from the thousands of psychotherapy research studies that have accumulated over the years can be found in the five editions to date of *The Handbook of Psychotherapy and Behavior Change*.

A single article on an entire field of research requires many inclusion and exclusion decisions. This article is focused solely on the development of psychotherapy research in the United States. It also is limited to research on individual psychotherapy (not group or family therapy) for adults (not children or adolescents). The content pertains most directly to therapy research for problems other than addictions (e.g., to alcohol and drugs of abuse such as heroin) because substance abuse treatment research in the United States followed a partially separate developmental path. Within the preceding delimitations, a guiding principle was to highlight scientific milestones and turning points. Turning points herein are findings or events that changed the direction of at least a notable constituency of therapy researchers. Milestones are findings or other research-related developments that improved the possible scientific quality of research or its immediate value for informing clinical practice (the two are not distinct: “findings” from studies with poor scientific quality rarely if ever are properly regarded as having immediate implications for practice). Of course, the identification of milestones and turning points lies in the eyes of the beholder. To reduce the extent to which the topics discussed mainly reflect idiosyncratic biases of the author, several dedicated experts in psychotherapy research graciously reviewed the article (see Acknowledgments).

The preceding precaution could not eliminate another type of limitation. Doing psychotherapy research teaches well the general lesson that some “facts” are highly dependent on the perceiver. The author has been involved in therapy research for over 25 years in a variety of settings. Nevertheless, a participant–observer’s perspective always is limited to just part of “the elephant” that is one’s field. In addition, the perspectives herein on the primary forces that prompted turning points are likely to both overlap with and differ somewhat from descriptions by others who had different vantage points and who were influenced by different contingencies.

II. HISTORICAL OVERVIEW

Psychotherapy research is a branch of research on treatments for psychological, emotional, and behavioral problems, that is, for problems often referred to by the medically oriented term, “mental illnesses.” The development of psychotherapy research has a strong historical link to clinical psychology. The link was solidified in 1949 at the Conference on Graduate Education in Clinical Psychology that was held in Boulder, Colorado. The “Boulder model,” also known as the scientist–practitioner model of graduate-level training in clinical psychology, was established then. The essence of the Boulder model is that the doctoral degree (Ph.D.) in clinical psychology should be based on training both in research methods and in the clinical application of (i.e., direct use with people) psychotherapeutic interventions. To this day, Ph.D. clinical psychologists are expected to be able to conduct and evaluate research relevant to their field, as well as to provide psychotherapeutic services.

The psychotherapy studies done by clinical psychologists and other therapy researchers examine a broad range of questions. Some are designed mainly to answer more basic questions (e.g., “How do psychotherapies work?”), whereas others are designed to answer questions that have immediate implications for the practice of psychotherapy such as, “Which of the available forms of treatment has the best probable outcomes for depression in adults?” Both types of studies are said to have “applied” aims. Treatment-relevant research that primarily has applied aims is referred to as “clinical research.” Psychotherapy research correctly is regarded as a branch of clinical, mental health research.

A. How Psychotherapy Research Relates to Other Mental Health Research

Psychotherapy research is distinguished from other types of clinical mental health research such as psychopharmacology (medication) research, which is strongly linked to the field of psychiatry and to the pharmaceutical industry. However, from the mid-1980s to the present an increasing number of outcome studies include psychotherapeutic interventions, pharmacological interventions, and their combination, thereby blurring the boundaries between psychotherapy and psychopharmacology research. Psychotherapy research also is distinguished from mental health services research. Traditional services research is intended to obtain data on the natural functioning of community-based, clinical

care delivery systems. Typical data include how such systems are organized, their accessibility, fiscal features, and outcomes at a global level (e.g., recidivism). Services research usually utilizes large databases (e.g., several thousand service recipients and clinic “contacts” or visits) and provides information useful at a programmatic level. It is not designed to test and develop specific treatments. Psychotherapy research also can be differentiated from psychopathology research, although the two fields historically and presently overlap.

B. Psychotherapy Research versus Behavior Therapy Research

For many years (from about the 1950s through the 1970s), therapy researchers themselves drew a clear distinction between behavior therapy research and psychotherapy research. The distinction reflected what aptly has been described as an internecine struggle between those who endorsed forms of therapy that were grounded in theories and findings of subdisciplines of psychology known as learning and behavior (“behavioral” therapies), and those who favored therapies derived from Freudian psychodynamic theory or from humanistic principles (e.g., Rogerian client-centered therapy). The distinction was instantiated in the founding by psychologists of two scientific organizations at approximately the same time: the Association for the Advancement of Behavior Therapy (1966) and the Society for Psychotherapy Research (circa 1968). Both flourish to this day.

By the late 1970s, tangible signs of a rapprochement between the two camps emerged. One such sign was the “psychotherapy integration movement” that was spearheaded by psychologists such as Paul Wachtel and Marvin Goldfried. The period of rapprochement was spurred in part by outcome findings that indicated that behavior therapy-based and psychotherapy-based treatments both were associated with measurable benefits, often of comparable magnitude. Neither camp could claim unqualified victory. Indeed, contrary to the hopes and expectations of many, some studies in which a behavioral therapy was compared directly to a non-behavioral therapy (e.g., psychodynamic psychotherapy) failed to detect statistically significant outcome differences. A prototypic study like this was published in a 1975 book by Sloane, Staples, Cristol, and colleagues, *Psychotherapy vs. Behavior Therapy*.

At least partially due to mutually humbling outcome research findings, animosity between the camps substantially diminished, and some cross-fertilization even occurred. The two arms of therapy research also retained

some distinctiveness, as reflected in one of the field's most influential recent milestones, a listing of empirically supported forms of therapy ("ESTs") for specific types of problems. The list was first published in 1995, based on the work of the American Psychological Association's Task Force on Promotion and Dissemination of Psychological Procedures. The Task Force was chaired by Dianne Chambless from 1993 to 1997. (Initially, the term "empirically validated therapies" was used for the list. It was changed to ESTs in part because the word "validated" could mistakenly connote that the process of validation for a therapy had been completed and no additional research on it was needed.) The list includes some therapies that are essentially behavioral (e.g., exposure and response prevention for obsessive-compulsive disorder), as well as some that are not such as interpersonal psychotherapy for depression (a type of psychotherapy that was developed by psychiatrist Gerald Klerman and colleagues, published in 1984).

The long-standing distinction in the literature between behavior therapy and psychotherapy, and between the corpus of research focused on each, marks a historically important epoch in the development of research on psychologically based interventions. Herein the term "psychotherapy research" includes research on all forms of psychologically based treatments.

C. "Coalescence" Phase of the Field of Psychotherapy Research

So, when did all this start? Several reviews of therapy research indicate that the earliest outcome studies of psychotherapies were published in the late 1920s, slightly over 80 years ago. A 1916 study was mentioned in a review by Allen Bergin, an unusually knowledgeable reviewer. The number of outcome studies published per year was very low at first—about two every 5 years between 1920–1930. The rate increased to about 10 every 5 years after that and during World War II. Starting in the early 1950s, the publication rate of psychotherapy outcome studies began to increase exponentially.

By 1958, the field of psychotherapy research definitely had emerged in the United States. In that year, the Division of Clinical Psychology of the American Psychological Association held the first national conference on psychotherapy research. The National Institute of Mental Health (NIMH) provided financial support for the conference. Broadly stated, its purpose was to evaluate the status of therapy research and to thereby provide information that also could stimulate further research. An important additional aim was to

strengthen research collaboration and interdisciplinary relations between psychologists and psychiatrists. Psychiatrists were among the invited participants and also were asked to join the conference planning committee.

Several forces are likely to have contributed to the accelerating growth of psychotherapy research that was evident by the 1950s. The end of World War II played a role. For example, resources of many types became more available, and the kinds of acute problems that psychiatrists observed in soldiers led to greatly expanded interest in psychotherapy after the war. A closely related development was the U.S. Veterans Administration's promotion of the use of psychologists both to administer psychotherapy and to conduct research. Another factor was the methodologically groundbreaking and exemplary psychotherapy research program that was developed by Carl Rogers, his colleagues, and students at the University of Chicago beginning in 1949. The availability of funding from the NIMH, after it was established in 1949, was certainly growth promoting. The previously noted adoption in 1949 of the scientist-practitioner model for education in clinical psychology also contributed. Moreover, doubtless, what was reacted to by many as a gauntlet thrown down by Hans Eysenck in 1952 energized and focused psychotherapy outcome research initiatives.

In perhaps the most widely cited therapy research publication of the era, Eysenck presented data that he interpreted as evidence that existing outcome studies did not show that psychotherapy was associated with better improvement rates than occurred, over time, in untreated individuals who had comparable problems. The latter was termed "spontaneous remission." Eysenck used two previously published naturalistic data sets to estimate improvement rates that would occur in psychoneurotic problems over 2 years without the benefit of "systematic psychotherapy." One set of figures was from discharge records of neurotic patients from New York state hospitals; the other was from an insurance company's disability claims for psychoneuroses for a 5-year period. According to Eysenck's calculations, improvement rates found in psychotherapy outcome studies and improvement rates for the same types of problems in those who did not receive psychotherapy both were about 66%.

The validity of Eysenck's methods and conclusions were challenged by many therapy researchers over the years. The kinds of questions asked included "Was his assumption accurate that those in the naturalistic studies had not received any psychotherapy?"; "Were the improvement criteria used in the naturalistic studies

comparable to those used in therapy outcome studies?"; "Was spontaneous remission an established finding," as Eysenck's argument suggested it was? It was not until 1977 that data were presented (by Mary Smith and Gene Glass) that finally put to rest Eysenck's conclusion that no evidence existed that psychotherapy was effective. More about this in Section III.

Before leaving the topic, a key fact is worth noting. The heated debate stimulated by Eysenck's 1952 paper (and by a later, similar paper of his published in 1960) was to some extent both fueled by and a manifestation of, the aforementioned behavior therapy versus psychotherapy struggle. Eysenck, himself, became a leader in the behavior therapy movement.

Despite the field's burgeoning growth since the 1950s, as recently as 20 years ago (1980) psychotherapy research was quaintly described as a "cottage industry" by some observers. The term seems to have originated mainly from comparison of psychotherapy research to psychopharmacology research, a field whose primary and huge funding source is the pharmaceutical industry. Among other things, cottage industry status connoted that outcome studies of psychotherapy typically had relatively small sample sizes—20 or fewer individuals included in each treatment condition. In addition, many studies were un- or underfunded and conducted by individual investigators who did not closely coordinate their efforts with those of others working on the same or related questions. Thus, findings did not typically build on each other, thereby creating a cumulative and obviously progressing body of knowledge. Although the quality of studies could be excellent, their findings typically were not highly influential in terms of affecting either the practice of psychotherapy or public policy on mental health treatment. (Cottage industry or not, the field was an active one. According to Michael Lambert who reviewed the psychotherapy research literature in 1980, 4,000 studies of various types had been published by then.)

D. "Coming of Age" Phase: Therapy Research Enters the Mainstream of Clinical Mental Health Research

The milestones and turning points described in the next subsections, with one exception (the NIMH treatment development grant mechanism), were in some way controversial within the field of therapy research. Indeed, controversy probably is a marker for publicly observable events that have the potential to precipitate widespread change. The points of contention are not

discussed here but readily can be found in the psychotherapy research literature.

1. Large-Sample, Multisite Studies, Randomized Clinical Trial Design

A clear turning point for the field of therapy research began to take shape in about the late 1970s. Larger-scale outcome studies of psychotherapies—250 or more individuals treated—began to be undertaken with the assistance of substantial funding from the NIMH. The shift was at least partially due to a leadership role taken by NIMH staff like Morris Parloff and Irene Elkin, both of whom were experienced psychotherapy researchers. Psychiatrist Gerald Klerman also facilitated the changes from his position at the helm of the Alcohol, Drug Abuse and Mental Health Administration, the federal government agency that oversaw the NIMH at the time.

One study, in particular, marked the defining shift for psychotherapy research from its so-called cottage industry status to a recognized, influential branch of clinical research. The study is known as the NIMH Treatment of Depression Collaborative Research Program (TDCRP). Irene Elkin of the NIMH played a key role in the study's oversight and conduct throughout its course. Work began on conceptualizing and designing the TDCRP in 1977. Its initial outcome findings were published in 1989, a mere 13 years ago. The TDCRP was the first time that a collaborative, multisite outcome study of psychotherapies (i.e., the same research design and procedures were implemented simultaneously at three, geographically distant research settings) was conducted using the randomized, controlled clinical trial research strategy. Until then, collaborative clinical trials were commonly used for pharmaceutical company-funded research on psychoactive medications but not for psychotherapy research.

2. Selection of Patient Samples by Psychiatric Diagnoses

The TDCRP also illustrates the impact of a development external to the field of psychotherapy research that became a momentous turning point for it shortly after 1980. In 1980, the American Psychiatric Association published the third edition of its diagnostic nomenclature of psychiatric disorders, the Diagnostic and Statistical Manual of Mental Disorders (*DSM-III*). The *DSM-III* was a major revision of the Association's existing nomenclature. The overhaul was undertaken in part to remediate features of prior versions of the *DSM* that made it an inadequate diagnostic system to

support clinical research—both psychopathology studies and outcome studies of psychopharmacological and other treatments. For example, the descriptions of diagnoses were not specific or detailed enough to enable diagnoses to be assigned reliably to the same patient by different, even expert, psychiatrists. Poor interrater reliability of diagnoses was a fatal handicap from a research perspective, and it created many problems from a practice perspective too.

The *DSM-III* had a major impact on psychotherapy research despite the fact that many mental health professionals from all disciplines and many psychotherapy researchers did not endorse it. Some even condemned it. They did not believe that the *DSM-III* was either a valid system for classifying psychopathology or a treatment-relevant nosology for selecting and planning most types of psychotherapeutic interventions. Despite rejection of the nomenclature by many therapy researchers, the *DSM-III* and its subsequent editions changed the direction of psychotherapy research. After the mid-1980s, psychotherapy outcome studies started to be focused on disorders as they were defined in the *DSM*, such as panic disorder and major depression. The TDCRP was a harbinger of this trend.

Developments at the NIMH in 1985 contributed to the impact on psychotherapy research of the *DSM-III* and its later editions. In 1985, the NIMH Division of Clinical Research was reorganized such that many of its subdivisions or “branches” were identified by disorders that appeared in the *DSM-III*. For example, the existing Psychosocial Treatments Research Branch was abolished and replaced by the Affective and Anxiety Disorders Research Branch. (“Psychosocial” was a term that was adopted at the NIMH by branch chief Morris Parloff in part to span the aforementioned rift in the field between behavior therapy and psychotherapy.) Prior to the NIMH reorganization, psychotherapy researchers often sought guidance from staff of the Psychosocial Treatments Research Branch on their grant applications. After the reorganization, many therapy researchers did not know which, if any, branch was the appropriate one to contact about their treatment study ideas and potential proposals. Moreover, it became evident rather quickly to researchers that the NIMH grant review committees were, in essence, requiring grant applications for psychotherapy outcome studies to be focused on a specific disorder. Study patients were to be selected primarily by diagnostic criteria, and disorders as defined in the *DSM* seemed most likely to be viewed as acceptable by review committees.

For the last 20 years and into the present, the largest and most influential psychotherapy outcome studies

have been designed to test psychotherapies for specific *DSM* disorders—despite the continuing reservations of many therapy researchers, practicing mental health professionals, and psychopathology researchers about the validity of much of the nomenclature. One major result is that a cumulative body of treatment research findings has been achieved. At the same time, substantial and scientifically well-founded skepticism about aspects of the nomenclature continues among mental health researchers and practitioners from all disciplines, including psychiatry.

3. “Time-Limited” Courses of Therapy

The TDCRP illustrates yet another characteristic feature of therapy outcome research during its coming-of-age phase through the present. The length of therapies studied typically has been relatively short—12 to 24 sessions over 3 to 4 months. Particularly to psychotherapy research pioneers who espoused the psychodynamic orientation, examining therapies of less than 1 or more years duration was of uncertain relevance, at best, to the phenomenon of psychotherapy. Several forces converged by the late 1970s that resulted in the focus of psychotherapy outcome research, particularly federally funded studies, on time-limited treatments. Society’s and insurance companies’ concerns about the costs of long-term psychotherapy played a role, as did scientific considerations that made the conduct of interpretable studies of long-term psychotherapy problematic. Indeed, few outcome studies of long-term psychotherapy exist at this time. A study done of psychodynamically oriented therapy at the Menninger Foundation in Topeka, Kansas, from about 1954 to 1974 is a famous exception.

Findings from studies of time-limited treatments, particularly for depression, are renewing interest in conducting studies of longer-term therapy—up to 1 year. Disappointing percentages of individuals who reach a “recovery” criterion and evidence that a notable proportion of patients relapse after time-limited treatments support the interest. Indeed, 18-month follow-up findings from the TDCRP contributed to the currently nascent tendency to conduct outcome studies of longer-term courses of psychotherapy. A well-established trend is outcome studies of “maintenance” therapeutic interventions (e.g., monthly “booster” therapy sessions following time-limited, acute phase treatments) to determine if posttreatment relapse rates can be reduced. A contrasting direction, consistent with economic considerations and cost-cutting interests of managed care organizations, is the examination of very short treatments—three sessions for some types of anxiety problems. In addition, the

potential of technological advances, such as handheld computers (“Palm Pilots”), to enhance psychotherapy is being explored, e.g., between-session use of Palm Pilots by patients with panic disorder to prompt behavior change and to reduce the amount of contact with a therapist that is required to get desired outcomes.

4. Treatment Development Grants

Efforts of NIMH staff, such as psychologist Barry Wolfe, led to another pivotal milestone in the history of psychotherapy research. In 1993, the NIMH made available a type of funding opportunity called a “treatment development grant.” NIMH’s action followed a similar initiative by the National Institute on Drug Abuse that was cultivated by Lisa Onken, then of its Clinical and Experimental Therapeutics Branch. The appearance of the treatment development grant was embraced by psychotherapy researchers as a crucial attempt to help offset a very long-standing handicap from which the field suffered, particularly in comparison to psychopharmacology research. Pharmaceutical companies are and have been a major source of non-federal funding for psychopharmacology outcome research, as well as for the development and initial testing of new medications for psychiatric problems. The field of psychotherapy research never had a counterpart to this mammoth corporate funding source for treatment development. The development of new forms of therapy, or modified versions of existing ones, was completely dependent on the unfunded initiative of individuals before treatment development grants became available. The preceding major impediment to the development of psychotherapies was long recognized by therapy researchers.

E. Unfolding Directions

Three more turning points for psychotherapy research surfaced in the 1990s, the ultimate impact of which on the field and on the practice of psychotherapy in the United States is yet to be known. Two of the three were spawned directly by the NIMH. It, in turn, was responding to a host of forces, prominently including economic concerns (continually increasing costs of all forms of health care) and public health policy issues (e.g., what direct recommendations for typical clinical care settings could be made from existing treatment research?). One turning point was a call for cost data to be included in mental health treatment studies. A second began as the “efficacy versus effectiveness debate” and culminated in the intentionally revolutionary endorsement by the NIMH of “the public health model” as a new paradigm for mental health treatment research. The

third, not completely distinct from the other two in terms of causal forces, was the introduction to therapy research of a “patient-focused” research paradigm.

1. Cost-Effectiveness, Cost-Benefit, and Related Methodology

By the mid-1970s if not before, insurance companies and various U.S. social institutions voiced concerns about the cost of mental health treatment. By the early 1990s, rising health care costs were a major focus of the U.S. Congress. In addition, managed care treatment delivery systems, an intended antidote for rising costs, were actively seeking cost-effectiveness data on mental health treatments. Concurrently, the NIMH began making concerted efforts to get investigators to obtain cost data in treatment outcome studies. (The concept of costs is very broad and includes resources of many types that are used in the delivery of treatments such as office space, supplies, and transportation.) Various types of cost information were needed by federal and local health care policymakers and by managed care entrepreneurs—the comparative costs of alternative treatments, such as medication and psychotherapy for the same problem; the relative benefit obtained for resources consumed by different treatments (cost benefit); and savings in medical expenses, work days lost, and so on, that might be associated with mental health treatments (cost offset).

Highly sophisticated and complex methods for assessing costs associated with treatments existed though they rarely were used in psychotherapy outcome research at the time. The NIMH recommended that health care economists be added to outcome study grant applications to ensure that adequate cost data would be obtained. Now, in 2002, experts in cost analysis are on NIMH treatment grant review committees. The impact is not yet widely evident of cost data from outcome studies on practice patterns and on directions in psychotherapy research.

2. From Efficacy versus Effectiveness to the Public Health Research Paradigm

From a public health perspective, a core issue of what often is called “the efficacy versus effectiveness debate” is the generalizability to community-based, clinical practice settings of treatments examined in, and outcome findings from, randomized controlled studies. Sometimes the issue is characterized as the “transportability” of treatments from research into typical practice settings. From a scientific perspective, the debate’s core issues are: (a) alternative experimental designs and methods that can be used for clinical treatment studies,

and (b) the kinds of inferences (conclusions) for practice in non-research, community settings that most confidently can be drawn from them.

The seeds of the efficacy versus effectiveness debate were sown years before its rise to the forefront as a bonafide scientific debate in the mid-1990s. Its emergence then was a side effect of several forces, including: (a) dramatic shifts in health care delivery that occurred in the United States beginning about the mid-1980s, (b) the U.S. Congress's (failed) attempt in 1993 to reform national health care, and (c) escalating dissatisfaction of practitioners with the output of therapy research (e.g., manuals for therapists that describe how to implement specific types of psychotherapy).

In the mid-1980s, health care delivery patterns increasingly moved away from indemnity insurance coverage toward managed care. The managed care model gained momentum from the mid-1980s on as a way to contain and cut health care costs. Both managed care and the health care reform movement spotlighted the need for valid information about existing treatments to guide decisions of government policymakers and managed care entrepreneurs. Both groups were motivated to make decisions rapidly that would affect the treatments that millions of citizens could receive using insurance benefits. Gaps became widely evident between the types of information wanted by these and other stakeholders in mental health treatment (e.g., its "consumers" and clinical providers) and what was available from existing therapy and other mental health-related research. Recognition of the limitations fostered lively debates about how treatment research, particularly federally funded research that is mandated to meet broad public health needs, should be designed.

From a scientific standpoint, two concepts that are key to the efficacy versus effectiveness debate are internal and external validity. The concepts first were proffered in the early 1960s by Donald Campbell and Julian Stanley as part of a conceptual framework that linked different experimental designs and methods to the types of questions that could most validly (logically correctly) be answered with them. Internal validity relates to designs and methods that increase a study's logical strength for drawing causal conclusions about the relationship between its independent (e.g., form of psychotherapy) and dependent (e.g., outcome indices) variables. When a therapy outcome study has a design and methods that maximize internal validity (e.g., random assignment of patients to the treatment conditions that are being compared; inclusion of a "control" condition of some type to provide an estimate of the improvement that could occur, without treatment, over

the same period of time that a study treatment is provided), confidence is maximized that its findings can be interpreted as evidence that the therapy or therapies examined caused the outcomes obtained. Studies that have high internal validity are referred to as "efficacy" studies in the parlance of the debate. The aforementioned TDCRP is a prototypic efficacy study.

External validity relates to study designs and methods that enhance the generalizability of study findings. Generalizability means the confidence with which a study's results can be assumed to extend to situations, people, measures, times, and so on, other than those particular to the study. For example, say a finding is that cognitive therapy plus progressive muscle relaxation for generalized anxiety disorder is associated with more reduction in anxiety than nondirective therapy plus relaxation. The external validity features of the study's design and methods determine the types of "real-world" clinical settings, therapists, patients, and treatments to which we can confidently generalize the expectation (i.e., infer) that the same cognitive therapy plus relaxation will be associated with more reduction in anxiety in generalized anxiety disorder than an alternative therapy will be. Studies with designs and methods that achieve high external validity are referred to as "effectiveness" studies in the efficacy versus effectiveness debate.

In a series of actions that became clearly evident to psychotherapy researchers by about 1998, the NIMH indicated it wanted to receive grant applications for studies that were designed to have external validity strengths in the sense of having direct implications for practice in typical care settings. In actuality, a much more dramatic and far-reaching change was in progress, a change that has the potential to affect therapy research at least as profoundly as the 1985 NIMH reorganization did.

Another major reorganization of the NIMH funding by programs occurred in 1997 under the leadership of a new director. Once again, as in 1985, psychotherapy researchers interested in federal funding needed to determine what new branch of the NIMH they should contact with their ideas, and so on. In addition, a Clinical Treatment and Services Research Workgroup was established and charged by the new NIMH Director Steven Hyman to advise on "strategies for increasing the relevance, speeding the development, and facilitating the utilization of research-based treatment and service interventions for mental illnesses into both routine clinical practice and policies guiding our local and national mental health service systems." In 1999, the Workgroup's report, *Bridging Science and Service*, became available. Moreover, in 1999, Dr. Hyman co-authored a

publication with key NIMH treatment research administrators that said that NIMH was now dedicated to advancing “a public health model approach to clinical research.” The model is intended to eventually fill the information gaps that various stakeholders need and want. It also is expected to meet the treatment dissemination and other goals, described earlier, that the Workgroup was charged to consider.

Obviously, yet another major turning point for therapy research is underway, spurred by the NIMH's recent transformation and new aims. As yet, the field's new directions, questions, and findings largely remain its unforeseen future.

3. Patient-Focused (versus Treatment-Focused) Research

In 1996, Kenneth Howard and colleagues presented a research strategy that was new to the field of therapy research. It was called “patient profiling.” The strategy was an outgrowth of Howard's direct knowledge of contemporary trends in the provision of psychotherapy in managed care delivery systems and lifelong career doing therapy research in naturalistic settings. Patient profiling also was an outgrowth of the application of developments in data analysis techniques. Other therapy researchers concurrently pursued similar directions, using what now are sometimes classified as “patient-focused” research strategies. In general, patient-focused research answers questions like, “Is this patient's therapy working?” It is contrasted with conventional or “treatment-focused” therapy research that addresses questions like, “Does this type of therapy work?”

A main difference between patient-focused and treatment-focused studies (like the TDCRP) is that the aim of the newer strategy is to provide information that can be used to evaluate the progress of a specific patient's treatment by comparing his or her ongoing treatment response in real time to an expected response of clinically comparable individuals. The expected (or predicted) response is estimated from archival data on many treated patients, that is data of the type collected by managed care corporations.

The potential value and impact of patient-focused research on the main questions in therapy research is yet to be known. A hope is that it will, at minimum, provide one type of bridge across an ironic and chronic gap between therapy research and clinical practice. For example, the utility of patient-focused research currently is being examined for giving community-based therapists up-to-date information on how a patient is progressing compared to a predicted course so that therapists can consider modifying the treatment that they are providing.

F. Comment

The foregoing has been a thumbnail sketch of trends in and forces that have shaped psychotherapy research in its first 60 or so years. One aim was to illustrate that psychotherapy research is characterized so far by noteworthy shifts in focus and style. Many of the shifts described reflect the responsiveness of the field to external forces rather than to its own findings or findings in closely related fields such as psychology and other behavioral sciences. Therapy research has responded to research priorities established by the NIMH to meet public health and policy needs; developments in psychiatry; and insurance providers' demands for data on the efficacy, safety, and costs of psychotherapies to form and defend their mental health care reimbursement policies. Indeed, the applied (practice-relevant) potential of psychotherapy research can make it a quickly changing, exciting field both to work in and to observe. Unfortunately, many of the sources of excitement and the sense of urgency associated with studying practice-relevant questions also can challenge the maintenance of scientific integrity.

III. KEY QUESTIONS

Fundamental features of a scientific field are its focal aims, focal questions, theories, and primary research methods. In research, aims are instantiated in the form of specific questions and hypotheses. Several key questions that have been examined by psychotherapy researchers are reviewed in this section. The emergence of milestones and turning points along the way is noted.

A. What Can Be Learned about Personality Psychology from Psychotherapy?

During the late 1940s and 1950s when psychotherapy research was beginning to coalesce as a scientific field, an aim endorsed by many investigators was to use psychotherapy as a method to advance personality theory, a major subdiscipline of psychology. At least into the early 1960s, some psychologists were exploring the question of whether psychotherapy provided a “valid method for the science of psychology.” In other words, psychotherapy as a vehicle for advancing basic academic, rather than applied, research questions was of considerable interest.

Psychotherapy had several features that suggested its promise as a sort of laboratory for systematically

investigating human personality and behavior. Psychotherapy provided a relatively standard, simple-to-construct situation in which a person and his or her psychological processes could be observed closely. Moreover, to achieve therapeutic goals, the psychotherapy situation specifically was designed to enable people to reveal themselves in the most complete and honest way possible. This feature also afforded a unique opportunity to achieve scientific goals. It was hoped, for example, that both observations of people and information they revealed about themselves and their life histories might answer basic questions about personality, its developmental antecedents, and also provide data from which a valid taxonomy of personality traits (cross-situationally consistent patterns of perceiving and behaving) might be derived and tested. In turn, from the preceding types of knowledge, principles of personality change could be developed.

The foregoing early trend in psychotherapy research reflected, in part, Freud's legacy. Freud viewed psychoanalysis as both a treatment and a method to examine hypotheses about personality and its development. A similar perspective was prominently displayed at the first conference on psychotherapy research in 1958 that was mentioned in Section I. The authors of a summary of the conference, Morris Parloff and Eli Rubinstein, noted that many of the researchers present were relatively uninterested in outcome studies compared to research that was intended to advance understanding of personality.

B. What Is “the Problem” to Be Treated?

The early interest of psychotherapy researchers in personality psychology points to the intrinsic link between psychotherapy research and models of psychopathology. The development and identification of efficacious, efficient psychotherapeutic interventions are fundamentally contingent on conceptualizations of the problem(s) to be treated. Widely endorsed models of psychopathology have been elusive, although models have not been in short supply. None have generated widespread acceptance despite their lynchpin role for the development, refinement, and evaluation of psychotherapies. The lack of consensus has been an enduring handicap for psychotherapy research, as well as for other types of clinical mental health research.

Why has the development of consensually agreed-on models of psychopathology been unattainable to date? One reason is that many problems that seem to be legitimately regarded as mental health concerns are neither objectively observable nor measurable deviations from

clearly definable and delimited “normal” functioning and states of mind. Even though behaviors of the type that often are the focus of mental health treatment can be observed, their deviation from “normalcy” frequently is a judgment call. (The preceding two statements do not apply to psychotic and manic symptoms of conditions like schizophrenia and bipolar disorder that are associated with obvious impairments in adaptive functioning. The two conditions exemplify a few that are consensually viewed as more “severe” by mental health professionals across disciplines.) In brief, the nature of the problems that can be the focus of psychotherapy (and of psychopharmacology by current practice patterns) often is much different than the physical anomalies and abnormal processes that typically are the focus of medical treatment.

Medicine characteristically has the relative luxury of being directed to physically observable and, thus, readily agreed-on deviations from equally observable, normal functioning of the human organism. Obvious examples are broken limbs, flesh wounds, and cancers. Many serious medical problems are not observable by the unaided eye, but technological aids such as microscopes, x-rays, and imaging equipment allow their presence to be observed and consensually assessed. Mental health complaints often are not similarly available to visual inspection or verification and, thus, to consensual agreement on the nature of (or even presence of) the problem to be treated. Moreover, attitudinal, emotional, and behavioral functioning that is regarded as in the normal range seems to be much more heterogeneous than physical functioning in the normal range. Thus, using indices of normality as a benchmark from which to create models of psychopathology is unlikely to be as helpful as it has been in medicine. The medical model is only partially applicable, at best, to dimensions of “mental” functioning.

Unfortunately, attempts so far to develop models of psychopathology that could provide strong foundations for psychotherapy research and for other mental health treatment research often have elicited, or have been notably influenced by, guild interests of the various mental health professions. Such factors compound the difficulty of an extremely difficult, yet crucial conceptual challenge for psychotherapy research and for mental health treatment, in general.

C. Does Psychotherapy Work?

Alternatively stated, the question is, “Is psychotherapy effective?” Its answer requires results from studies that are designed to determine if a type of psychotherapy

is associated with greater or different change than no treatment, using a standard criterion to judge whether or not a difference exists.

1. A Compelling, Affirmative Answer

It was not until 1977 that data were presented that provided a widely influential and convincingly positive answer to the simplistic yet fundamental question, “Does psychotherapy work?” The answer came from the application of meta-analysis, a statistical technique, to data from nearly 400 (in 1977) and then 475 (in 1980) therapy outcome studies, many of which included a no- or minimal treatment control condition. The two meta-analyses (the first authored by Mary Smith and Gene Glass; the second by Smith, Glass, and Thomas Miller) were a major milestone for the field of psychotherapy research. The larger one showed that when findings were pooled from outcome studies in which treated individuals were compared in the same study with either (a) untreated or minimally treated individuals, or (b) groups who received placebo treatments or “undifferentiated counseling,” the average person who received a form of psychotherapy was better off on the outcomes examined than 80% of those who needed therapy but were not treated. The advantage for psychotherapy was larger when the meta-analysis included only studies in which therapy groups were compared to no- or minimal treatment groups. Subsequent meta-analyses to date, often focused on the effects of psychotherapy for specific problems (like depression), have supported the conclusion that it is an effective treatment modality.

As noted previously, numerous and often painstaking prior attempts were made to effectively challenge Hans Eysenck’s 1952 conclusion that no evidence existed from outcome studies that psychotherapy was associated with a higher rate of improvement than could be expected to occur, over time, without therapy. For some years, a major impediment to disproving Eysenck’s conclusion was a lack of psychotherapy outcome studies that included a no- or minimal treatment condition whose outcomes were compared with those of the therapy of interest. The presence of such a condition provides an experimental way to estimate or “control for” change that might occur without treatment—with just the passage of time and normal life events. Randomized controlled psychotherapy outcome studies became increasingly prevalent over the years following 1952. Thus, a lack of controlled studies was not the only impediment to the appearance, before 1977, of a compelling counterargument to Eysenck’s proposition.

Before Smith and Glass applied meta-analysis to controlled outcome studies of psychotherapy, others had

summarized the results of such studies using a “box score” or tallying method. That is, the results of available studies were coded on whether or not the therapy of interest was associated with statistically significantly more improvement than was the no- or minimal therapy control condition. Conclusions based on the box score method were not as convincing as those of a meta-analysis. This was partially because the possibility of finding differences between therapy conditions in outcome studies is heavily influenced by a study’s sample size. Larger studies have a greater probability of obtaining statistically significant differences between therapy and control conditions.

2. How Should the Question Be Formulated?

Even while many therapy researchers were trying to disprove Eysenck’s conclusion that psychotherapy did not work, they already had concluded that the global question, “Does psychotherapy work?,” was not a productive one to guide research. For example, in a 1966 paper that, itself, qualifies as a milestone for the field, Donald Kiesler argued for the need to study “which therapist behaviors are more effective with which type of patients.” In a similar vein, in 1967 Gordon Paul framed the question for outcome research as: “*what* treatment, by *whom* is most effective for *this* individual with *that* specific problem, and under *which* set of circumstances” (original emphasis)? Others, such as Nevitt Sanford noted as early as 1953 that the global question, “Does psychotherapy work?,” was inadequate from a scientific standpoint to guide the field and suggested alternatives—“which people, in what circumstances, responding to what psychotherapeutic stimuli” However, it was Paul’s phrasing of the question that essentially became a mantra for psychotherapy research.

One of the most recent and major milestones in the history of psychotherapy research illustrates the field’s answers so far to a partial version of the applied question that Paul formulated for it 30 years earlier. The milestone was the aforementioned 1995 (updated in 1998) American Psychological Association list of empirically supported psychotherapies for various types of problems, such as depression and panic attacks.

D. What Is “the Treatment”?

For years, many researchers’ energy and attention was directed toward answering the question, “Does psychotherapy work?,” before methods were developed that enabled them to know of what, exactly, “the therapy” consisted that was done in outcome studies. Particularly for research on non-behavioral therapies, the field

essentially was in the position of saying “it works (or it doesn’t), but we don’t really know for sure what ‘it’ is.” More interesting, many therapy researchers were not fully aware that they were in the foregoing position. Investigators often assumed that study therapists were conducting the type of therapy that they said they were (e.g., “psychodynamic”), and that all therapists who said that they used a particular form of therapy implemented it more similarly than not. Donald Kiesler brought “myths” like the foregoing ones to the field’s attention in 1966 in his previously mentioned, classic critique of conceptual and methodological weaknesses of therapy research at the time. The increasing use of audiotaping technology in therapy research no doubt contributed to the uncovering of mythical “therapist uniformity assumptions” like those which Kiesler identified.

It was not until the mid-1980s that detailed descriptions of non-behavioral psychotherapies were put into written, manual form for therapists to learn from and follow in outcome studies. (Manuals began to be used in behavior therapy research about 20 years earlier, the mid-1960s.) The development of therapy manuals for all types of therapy was a crucial milestone for psychotherapy research. In effect, manuals were operational definitions of the main independent variable(s) of psychotherapy outcome studies. They also enhanced the scientific quality of research on psychotherapies in other ways.

Manuals made it more possible for all the therapies examined in a study to be implemented as they were intended to be. Manuals contributed to consistent, correct implementation in two primary ways. First, they facilitated systematic training of therapists in the conduct of a study’s therapies. Second, they provided criteria that could be used to monitor each therapist’s implementation of a therapy for accuracy (i.e., Is the therapist “adhering” to the manual?) throughout the entire course of each study therapy that he or she did. In addition, and very important from a scientific perspective, therapy manuals greatly facilitated attempts to replicate outcome findings in different settings, with therapists from different disciplines and experience levels, for example. Finally, from both the practice and public health perspectives, manuals aid widespread and efficient dissemination of therapies that are found to be efficacious in outcome studies.

In 1984, Lester Luborsky and Robert DeRubeis observed that “a small revolution in psychotherapy research style” had occurred with the use of manuals. What is particularly interesting is not that the revolution of manualization occurred, but that this fundamental methodological advance did not occur earlier. How

could a clinically-relevant, scientific field conduct valid tests of its treatments without first clearly articulating and defining them? As already noted, manuals were used in behavior therapy research almost 20 years before they were widely used in research on other forms of therapy. The lag largely reflected different fundamental assumptions of those who endorsed psychodynamic and some humanistic therapies, compared to therapies based on principles of learning and behavior. For example, a common view among psychodynamically oriented researchers and practitioners was (and is) that the treatment could not be “manualized” because it essentially requires artful and ongoing responsiveness of the therapist to shifts in the patient. When the aforementioned emphasis on time-limited forms of therapy occurred, it began to seem more possible to advocates of non-behavioral therapies to extract the theoretically essential change-promoting principles and techniques from their therapies, and codify them into manuals for the conduct of time-limited versions of the therapies.

As alluded to earlier in this article, ironically, one of the most important scientific advances for psychotherapy research—*therapy manuals*—became one of its most ferociously criticized accomplishments by practitioners in the 1990s. The reaction is only one example of a well-chronicled, perpetual gulf between research and practice. Historically, a central problem was that practitioners ignored therapy research and described its findings as irrelevant to or otherwise unhelpful for their work. More recently, practitioners do not feel as free to ignore findings. External pressures exist (e.g., from managed care payers) to make their care conform with findings by being able to provide manualized treatments found to be efficacious in treatment studies. The gulf is, of course, especially fascinating given that therapy research was fostered largely by the scientist–practitioner (Boulder) model of training in clinical psychology.

E. What Does It Mean to Say a “Psychotherapy Works”?

Two of many basic, yet conceptually and methodologically difficult questions that therapy researchers encountered early on were: “What effects (outcomes) should be measured to evaluate the usefulness of a psychotherapy?” and “How can the effects of interest be measured reliably (with precision) and validly (correctly)?” As investigators formulated answers to the first question, and both used and contributed to developments in psychometric methods to answer the second one, their findings revealed considerable additional

complexity. Some of the complexity will become evident in topics that are discussed next. Many, if not most, of the relevant issues continue to be debated: “How frequently should effects of interest be measured in a therapy outcome study?”; “What is the impact on the validity of outcome data of repeated measurement?”

1. The “Perspective” Problem

By the early 1970s, findings unequivocally indicated that the answer to the outcome question often depended on whom was asked. The patient’s assessment typically differed from the therapist’s perspective on the same effect (e.g., degree of improvement in self-esteem). For example, it was not unusual to find very low coefficients of correlation—0.10—between patients’ and therapists’ ratings of patients’ status on the same outcome variable. (A correlation of 0.80 or larger typically is regarded as high. Squaring a correlation coefficient indicates how much overlap, or “shared variance” scores on two measures have— $0.80 \times 0.80 = 64\%$.) Moreover, both perspectives could differ from the judgment of a clinically experienced, independent assessor. (Independent assessors’ ratings came to be included in outcome studies for several reasons such as to obtain a judgment from someone who was not invested in either the benefit experienced by individual patients or the study results). In the rare instances when family members or others who knew a patient well were asked to evaluate outcomes, this “significant other” perspective did not necessarily agree with any of the other three.

In 1977, Hans Strupp and Suzanne Hadley presented a conceptual “tripartite model” of mental health and therapy outcomes. The model helped to resolve the problem of ambiguous outcome findings posed by low agreement between perspectives. It identified three parties who have a vested interest in a person’s mental health (“stakeholders” in current parlance): the individual, mental health professionals, and society. The model included the idea that no one perspective was inherently more valid than another, although each perspective differentially valued aspects of an individual’s functioning and experience. For example, the individual can be expected to be most interested in subjective experiences of well-being and contentment. Society is likely to be most interested in the adaptive qualities of a person’s behavior. Another research-relevant idea of the tripartite model was that multiple perspectives should be obtained on the primary outcomes measured in an outcome study. The standard continues to this day.

The perspective problem was only one of many discoveries along the way that indicated the complexity of the focal phenomenon of interest in psychotherapy re-

search. It also illustrates the challenges that the phenomenon poses for obtaining simple answers from even the most sophisticated applications of scientific methods to the study of psychotherapy.

2. Statistical Significance versus Clinical Significance of Effects

In a series of papers from the mid-1980s to 1991, Neil Jacobson and colleagues provided a solution to a basic limitation of what were then state-of-art psychotherapy research methods. Their contribution was a major conceptual and methodological milestone for psychotherapy outcome research. At the time, statistical significance typically was the sole criterion used to determine if study results indicated that a therapy worked or worked better than an alternative treatment. For example, if the difference between a therapy group’s and a minimal treatment control group’s post-treatment scores on an outcome measure was statistically significant favoring the therapy group, the therapy was concluded to be efficacious (assuming, of course, that the study design and methods had adequate internal validity to test the question).

An important problem was that the criterion of statistical significance could be met even if treated individuals remained notably impaired on the outcomes of interest. For example, a therapy group’s average posttreatment scores could indicate that, although statistically significant improvement had occurred in symptoms of depression, most people’s outcome scores were still not in the normal (non-depressed) range on the outcome measure. Thus, statistical significance did not give a full picture of the potential usefulness or effectiveness of a therapy. Jacobson and colleagues’ milestone contribution was a set of logical and statistical procedures that provide information on how close to normal or to individuals with non-impaired scores on outcome measures those who receive a therapy are.

3. A Note on Data Analytic Techniques

The development of clinical significance methodology for evaluating outcomes illustrates the central role that data analytic techniques and statistics play in the kinds of conclusions that are possible from therapy research. As noted previously, the topic is excluded from this article. However, many developments in data analysis have been stimulated by or appropriated for psychotherapy research and are properly regarded as milestones for the field because they have had a profound impact on the kinds of questions that can be asked and answered. For example, effect sizes—as described by Jacob Cohen in 1970 and as used in the

aforementioned technique of meta-analysis—came to be preferred over statistical significance indices for comparing the outcomes of treatment and control conditions. An effect size is a statistic that can indicate the magnitude of differences between two alternative treatments or a treatment and a control condition. Random effects regression and hierarchical linear modeling are other examples of techniques that were not available to therapy research during its coalescence phase that subsequently extended how outcome and other questions can be examined and answered.

4. Stability and Longevity of Effects

Obtaining data from outcome studies on the question, “How long do the desired benefits of a psychotherapy last?,” was recognized as important early in the development of psychotherapy research. For example, Victor Raimy’s 1952 chapter in the *Annual Review of Psychology* noted both the importance and absence of posttreatment follow-up data on the outcomes of psychotherapies. By about the mid-1960s, the collection of follow-up data was regarded as a crucial component of therapy outcome studies.

The need to know how long a therapy’s effects last to fully evaluate its utility is another fundamental question that has proven to be an intransigent one. Over time, as more and more alternative treatments for the same problem have become available (e.g., various forms of psychotherapy and various medications for depression), data on the stability of effects of treatments have become particularly important because they bear directly on the relative desirability of the alternatives. Yet, it seems accurate to say that as of 2001 it is impossible to derive conclusive, no caveats, answers to stability of effects questions using currently available research methods.

A major problem is the phenomenon of attrition (loss) of study subjects during follow-up periods. Post-treatment follow-up periods typically range from 3 months to 2 years. Some portion of treated individuals inevitably become unable to be located or unwilling to continue to provide data. The longer the follow-up period, the larger the attrition problem typically becomes. The lack of complete follow-up data from all individuals treated in a study raises the possibility that the data obtained are biased in some way, that is, do not reflect the follow-up outcomes of the entire original sample (also called the “intent-to-treat” sample). For example, perhaps those who experienced more positive outcomes are more likely to agree to provide follow-up data. One obvious solution is to offer study participants large financial incentives to provide follow-up data. However, such a procedure raises the ethical concern of

coercion of participants and typically is frowned upon by human subjects research review committees.

All the limitations associated with collecting unequivocally interpretable stability of effects data notwithstanding, interesting evidence exists for a variety of problems. For example, a recently completed multisite comparative outcome study of cognitive-behavioral therapy, medication, and their combination for panic disorder by David Barlow and colleagues suggested that the treatments that included medication (medication alone or combined medication and therapy) were associated with less stable benefits after treatments were discontinued than were treatments that did not include medication (i.e., therapy alone or therapy plus pill placebo).

F. How Does Psychotherapy Work: Mechanisms of Action

The question of how psychotherapy works often is stated in the contemporary therapy research literature as a “mechanisms of action” question: “What are the primary mechanisms and processes by which psychotherapeutic treatments potentiate desired changes (outcomes)?” Using no jargon, William Stiles and David Shapiro stated the essential question this way in 1994: “How do the conversations between therapists and clients (psychotherapy process) reduce psychological suffering and promote productive, satisfying ways of living (psychotherapy outcome)?” Many therapy researchers have devoted substantial parts of their careers to this and related questions.

Mechanisms of action questions have been examined since at least the 1940s when Carl Rogers and associates began doing methodologically groundbreaking research on them. Such questions have been studied from widely divergent vantage points—a range that has been characterized as “elephant to amoeba.” For example, at a macro level, studies are done to identify therapeutic processes that might operate in all forms of psychotherapy (i.e., “nonspecific” or “common” factors) and that, thus, characterize psychotherapy as a treatment modality. At a more intermediate level, mechanisms of action are tested that are posited by the theory of a specific type of psychotherapy (“specific” factors) such as Beckian cognitive therapy for depression. At a micro level, “therapeutic change events” are examined—patterned sequential shifts in a patient’s focus of attention and affect states in a therapy session—that might constitute universal psychological change processes that can be prompted by specifiable therapist interventions.

The importance of mechanisms of action research cannot be overemphasized. Without knowing the

causally dominant processes by which a form of psychotherapy can prompt desired changes, therapists cannot structure their interventions to achieve a therapy's potential effects as quickly and as completely as is possible. Therapists can identify very specific goals for a patient's progress and improvement. Yet, without knowing a therapy's active mechanisms, they cannot rationally guide their interventions in the most effective and efficient ways to help a patient attain identified goals. Without mechanisms of action knowledge, therapists' moment-to-moment choices between alternative interventions must be based mainly on their knowledge of the theory that underlies a form of therapy, more general theories of how therapeutic change can be facilitated, or on their reflexive sense of what to do (or not do) next. Even the most well developed theories are not detailed enough to guide all the momentary decisions that therapists must make. Moreover, theories remain just that until posited mechanisms of action are tested and supported by empirical findings.

1. Process and Process-Outcome Research

The importance of conducting research on mechanisms of action questions has been matched so far by the difficulty of answering them. Pursuing such questions required therapy researchers to develop new methods, a task on which great strides have been made. The relevant methods collectively are referred to as process research methods. The development and refinement of process methods was a key advance for the field of therapy research during the last 50 years. Several colleagues and students of Carl Rogers at the University of Wisconsin in the 1960s such as Donald Kiesler, Marjorie Klein, and Philippa Mathieu-Coughlan made major early contributions to the needed methodological infrastructure.

The traditional type of process methods are observational. The researcher(s) or trained raters are the observers. Observational process methods involve systematic examination of actual therapy session material (i.e., the "process" of therapy), such as videotapes and/or transcripts of therapy sessions. Process methods extend to the collection of other types of data on therapy sessions such as patient and therapist self-report questionnaires completed immediately after sessions. The term "systematic examination" is a deceptively simple one that masks much complexity when used to describe process research methods. For example, it refers to detailed procedures for selecting (sampling) therapy session material to examine in order to answer a particular research question. It also refers to the development of psychometrically sound instruments that are needed to observe and quan-

tify therapy process variables of theoretical or pragmatic interest (e.g., the therapeutic alliance). Process outcome research is a subset of process research that specifically involves combining therapy process data and outcome data from the same patients with the aim of identifying the aspects of therapies that can be either helpful or harmful.

Donald Kiesler authored a classic, still relevant text on observational process research, *The Process of Psychotherapy: Empirical Foundations and Systems of Analysis*. The book was the first attempt to compile and systematically review process methods, methodological issues, and "systems" (instruments and related instructions for their use) that had been developed. Seventeen major therapy process research systems of the time are reviewed in detail. Only process methods used to study non-behavioral types of psychotherapy are included, an omission consistent with the aforementioned bifurcation of the field at the time into "behavior therapy" and "psychotherapy" research. In 1986, Leslie Greenberg and William Pinsof edited a similar volume that included many of the then, major process research systems. A succinct contemporary summary of process research methods and issues can be found in Clara Hill and Michael Lambert's chapter in the most recent edition (5th edition) of the *Handbook of Psychotherapy and Behavior Change*.

2. Process-Outcome Research: Problems with the Paradigm

David Orlinsky and colleagues described process-outcome research in their 1994 review of existing studies this way: "Process-outcome studies aim to identify the parts of what therapy is that, singly or in combination, bring about what therapy does." An enormous amount of effort has been devoted to investigations of this type. Even after using specific definitions to delimit process-outcome studies, Orlinsky recently estimated that about 850 were published between 1950–2001. However, the yield from them, in terms of identifying mechanisms of action, was judged to be disappointing by many therapy researchers as of the late 1980s. Newer studies have not modified the overall disappointment of researchers' and practitioners' wish to know precisely (a) what the active agents of change are, and (b) how they can be reliably initiated and supported by a psychotherapist's actions. Yet, useful knowledge has been obtained from process outcome research.

Cardinal advances to date include the identification of overly simplistic conceptualizations that drove much process outcome research, that is, hypotheses about

how therapeutic interventions might causally potentiate desired outcomes. For example, advances include: (a) elucidation of limiting assumptions that underlie the correlational design, a traditional one in process outcome research; (b) enhanced recognition that a network of contributing variables must be taken into account in this type of research; and (c) proposals for alternative, more complex strategies that incorporate (a) and (b).

a. Limiting Assumptions: The Drug Metaphor. Several limiting assumptions were highlighted for the field in a 1989 paper by Stiles and Shapiro with the attention-getting title: "Abuse of the Drug Metaphor in Psychotherapy Process-Outcome Research." The authors' general thesis was that "slow progress" in identifying the mechanisms of action of therapies was due to the ubiquity of a research paradigm in which therapeutic techniques were tacitly assumed to act like medications. So, for example, study designs reflected the assumption that therapeutic "ingredients" were dispensed by a therapist to a passive patient. Many studies also reflected the assumption that the relationship between a therapy's potentially helpful interventions and desired outcomes was linear and ascending—more is better.

The linear dose–response assumption guided many, if not most, of the mechanisms of action studies through the 1980s. That is, theoretically posited or other possible agents of change, measured with process methods in therapy session material, were correlated with outcome scores obtained at the end of a therapy. Such correlational designs are based on the assumption that a linear function accurately describes the relationship between two variables. For example, severity of depression scores (outcome variable) might be correlated with the frequency of therapist interventions in sessions that were intended to help the patient identify and change ways of thinking and behaving that (theoretically) were creating and maintaining symptoms of depression.

Most therapy researchers were at least dimly aware of the limitations of correlational designs for examining mechanisms of action hypotheses and of the other conceptual simplicities that Stiles and Shapiro elucidated. Yet, the research strategy continued to be used (overused) for a variety of reasons. As Stiles and Shapiro noted, the correlational design is not inherently flawed for use in process outcome research. Rather, it is highly unlikely to reveal all of the ways in which therapeutic interventions might robustly potentiate desired changes.

The drug metaphor analysis of process outcome research fostered widespread awareness of the need to formulate and test alternative hypotheses about relationships between outcomes and theoretically posited and

other possible mechanisms of action of psychotherapies. It helped to solidify, disseminate, and encourage the implementation of "new ways to conceptualize and measure how the therapist influences the patient's therapeutic progress," in George Silberschatz's words.

b. Network of Contributing Variables: Moderators and Mediators. Pioneers in psychotherapy research were very much on target when they endorsed Gordon Paul's aforementioned formulation of the overarching question for psychotherapy research, that is, "what treatment, by whom, is most effective for this individual ... and under which set of circumstances (original emphasis)?" Increasingly, therapy researchers have tried to identify "moderator" and "mediator" variables that might modify and determine the potential therapeutic outcomes of a psychotherapy. A paper by Reuben Baron and David Kenny that helped clarify therapy researchers' thinking on the issues appeared in 1986. In brief, moderators and mediators are "third variables" that can affect the relationship between independent variables (like a type of psychotherapy) and dependent variables (e.g., reduction in symptoms of depression). So, for example, a therapist technique that is specific to a form of therapy, as interpretation is to psychodynamic psychotherapy, is a therapy process variable that is hypothesized to be a primary mediator of the potential benefits of psychodynamic psychotherapy. Specifically, as defined by Baron and Kenny, a mediator is "the generative mechanism through which the focal independent variable is able to influence the dependent variable of interest." A moderator is "a qualitative (e.g., sex, race, class) or quantitative (e.g., level of reward) variable that affects the direction and/or strength of the relations between an independent or predictor variable and a dependent or criterion variable."

The impact of possible moderating and mediating variables on hypothetically important mechanisms of actions of therapies (which also are posited mediators of outcome) is increasingly being attended to in process outcome research.

G. How Does Psychotherapy Work?: Specific versus Non-Specific (Common) Mechanisms of Action

The specific versus non-specific question is an enduringly central one for psychotherapy process outcome research. The basic question is: "What is the contribution to therapy outcomes of the specific therapeutic techniques that characterize different forms of therapy, compared with other possibly therapeutic, but

common (non-specific) features that characterize psychotherapy as a treatment modality?" The potential causal contribution of common factors to therapy outcomes was convincingly argued 40 years ago by Jerome Frank.

In a classic book, *Persuasion and Healing: A Comparative Study of Psychotherapy*, Frank tried to account for the fact that existing psychotherapy outcome studies typically failed to show that markedly different types of psychotherapy had different outcomes. He specifically noted three types of null or "no-difference" findings. One was that "about two thirds of neurotic patients and 40 percent of schizophrenic patients are improved immediately after treatment, regardless of the type of psychotherapy they have received." Second, comparable improvement rates were found even when patients had "not received any treatment that was deliberately therapeutic." Third, follow-up studies, although very few at the time, did not demonstrate differences in long-term outcomes of diverse treatments.

The lack of evidence for any clearly superior form of therapy was, itself, perplexing. It was completely inconsistent with the expectations of many therapy researchers and nonresearcher, practicing mental health professionals alike. Different forms of therapy, such as Rogerian client-centered therapy and Freudian-derived psychodynamic therapy, were based on very different theories of the psychological processes that needed to be potentiated to achieve desired benefits. In addition, each theoretical orientation endorsed very different specific therapist techniques—techniques that were believed to potentiate the theoretically posited and theoretically required, psychological processes. In other words, a fundamental assumption was that the specific techniques of a type of therapy made a causal contribution to the outcomes that were sought. In addition, proponents of each orientation assumed that its underlying theory was more valid than the theories of alternative forms of therapy. Failure to find any one therapy that was superior to others was a stunning challenge to the preceding widely held assumptions.

Given that the results of therapy outcome research did not support the specific factors hypothesis (at least, not when using research methods and statistical analyses that were accepted at the time), Frank posited an alternate hypothesis. He suggested that similar improvement rates were due to psychologically influential elements that were common to all types of psychotherapy. Moreover, he posited that the common factors were those that operate in all human healing relationships and rituals, including religious healing. For example, he identified the arousal, or rearousal, of

hope (e.g., the expectation of help) as one common factor. Frank did not, however, completely dismiss the role of specific factors. He hypothesized that improvement rates in outcome studies reflected changes due to common factors in many patients plus change due to specific factors in some patients who did, indeed, respond to the particular form of therapy that they received. So, Frank's common factors hypothesis included the idea that specific techniques of different forms of therapy could be helpful to certain individuals although they were not needed by all those who could benefit from psychotherapy.

By 1971, Frank had further developed his common factors hypothesis and identified six "therapeutic factors" that are present in all forms of psychotherapy. For example, one was giving the patient a rationale or "therapeutic myth" that included both an explanation for the cause of the distress and a way to remedy it. Frank posited that his or her therapeutic action of such rationales, whatever their specific content or validity, includes strengthening a patient's confidence in the therapist. This, in turn, can reduce a patient's distress by reducing anxiety, as well as make the patient more open to the therapist's "influence" (e.g., suggestions for needed changes in attitudes and behaviors, and possible ways to achieve such changes).

Currently, 40 years after Frank's common factors treatise, research designed to identify the contributions to therapy outcomes of specific therapeutic techniques compared to common factors still is of central importance to the development of maximally effective and efficient psychotherapies. In general, it continues to be true that much less evidence than expected exists for the contribution to outcomes of specific techniques endorsed by different forms of therapy. Many researchers have attempted to explain why the null findings persist, given that process research has repeatedly demonstrated that purportedly different forms of therapy (e.g., cognitive therapy for depression and interpersonal therapy for depression) are associated with observably different and theoretically consistent, specific therapist interventions. For example, Alan Kazdin summarized and evaluated the situation this way for the 1994 *Handbook of Psychotherapy and Behavior Change*:

Comparative studies often show that two different forms of psychotherapy are similar in the outcomes they produce. ... This finding raises important questions about whether common mechanisms underlie treatment. Yet methods of evaluation are critical to the conclusion. It is possible that the manner in which treatment is studied may lead to a no-differences finding. The vast majority of therapy studies, by virtue of

their design, may not be able to detect differences among alternative treatments even if differences exist.

It is of interest that a similar situation exists for medications commonly used to treat depression. Classes of medications that have demonstrably different effects at the level of brain neurochemistry, such as selective serotonin reuptake inhibitors and tricyclics, have not yet been found to be associated with notably different outcomes. (Side effect differences are documented, however.) The similar failure to find outcome differences in medication treatments that differ at another level of observation lends some credence to contentions that current, standard methods for evaluating therapy outcomes might not allow different effects of psychotherapies to be observed. It also could be that the current difficulty demonstrating outcome differences between therapies that are demonstrably different at the level of implementation (therapeutic techniques) is a repetition of the fact that it could not be convincingly demonstrated that psychotherapy was better than no psychotherapy until the effect size statistic was applied to the task.

H. Do Some Forms of Psychotherapy Work Better Than Others?

Questions about the comparative efficacy of different forms of therapy have been a central focus of therapy research. As already noted, to the continual amazement of advocates of various specific forms of therapy, an enduring finding when different forms of therapy are compared is that their effects are not demonstrably different.

Over the years, the creative language skills of many experts in psychotherapy research have been stimulated by the frequent failure to demonstrate differential efficacy of different forms of therapy. For example, in a widely-cited 1975 paper, Lester Luborsky and colleagues adopted the Dodo Bird's salubrious verdict from *Alice in Wonderland* that "all have won and all must have prizes" to describe the weight of the evidence. Almost 10 years later, in 1984, Morris Parloff similarly summarized the findings as "all psychotherapy works, and all psychotherapy works equally well." However, the title of Parloff's paper highlighted a less sanguine implication of the no difference results: "Psychotherapy Research and Its Incredible Credibility Crisis." Shortly thereafter in 1986, William Stiles and colleagues analyzed possible reasons for the "equivalence paradox," that is, the fact that comparative outcome studies repeatedly found no differences in outcomes, yet the therapeutic techniques used in the different treatment conditions

had been demonstrated (via process research methods) to be different.

As of now, 2002, very detailed and comprehensive reviews of the comparative outcome study literature on different types of problems (e.g., anxiety disorders like obsessive-compulsive disorder and generalized anxiety disorder) and different patient groups (e.g., children, adolescents, and adults) suggest that it is not completely true that all therapies work and work equally well for every type of problem. For example, evidence exists that different specific forms of behavior therapy (such as exposure plus response prevention vs. progressive muscle relaxation) are differentially effective for obsessive-compulsive disorder. However, the general situation remains that less evidence for differential effects of specific forms of therapy exists than predicted by prevailing theories of psychotherapy and their posited mechanisms of action.

I. How Well Do Psychotherapies Work Compared to and Combined with Medications?

Increasingly, since about the early 1980s, psychotherapy researchers have collaborated with experts in psychopharmacology research to design and conduct comparative outcome studies of medications and psychotherapies. Comparative studies that include a combined medication plus psychotherapy condition also have become more frequent. A keen interest currently exists in comparative medication, psychotherapy, and combined medication and therapy outcome studies. The interest reflects the fact that medications have become more and more widely used in mental health treatment. Increased use can be traced to many forces including, of course, the aforementioned national emphasis on cost containment and cutting in mental health care.

In the early 1960s, Hans Strupp noted that chemical means were likely to be a challenge for psychotherapy. Indeed so. Within the past 3 years (since 1999), psychoactive medications (e.g., for depression) started to be advertised in television commercials in the United States. Viewers now are even encouraged to inform their doctors when new forms of existing drugs are available (e.g., an extended time release, once weekly, Prozac pill). As yet, no forms of psychotherapy are advertised in this way.

Conducting comparative psychotherapy and medication outcome studies heightened therapy researchers' awareness of some of the assumptions on which their standard research methods were based. For example, in therapy outcome studies the posttreatment outcome assessment traditionally is done after therapy sessions have been discontinued. The procedure is consistent

with both internal and external validity aims because of a general assumption about how psychotherapeutic interventions work. Historically, diverse forms of therapies all were expected to continue only for a time, to foster desired changes during that time, and then end when the patient had learned or otherwise “internalized” the ameliorative psychological processes that the therapy was intended to potentiate. When therapy researchers started to collaborate with psychopharmacology researchers, they observed alternative procedures for measuring outcome. For example, in medication studies, the convention was to obtain outcome assessments while patients still were taking the study medication. Differences in research methods made therapy researchers more aware of alternative methods and indicated the need for careful selection of methods that would yield “fair” and clinically-relevant findings from comparative studies of psychotherapies and medications.

Focal questions examined in comparative medication and therapy studies include rate of reduction in symptom severity, percentage of treated patients who reach a recovery criterion, stability and longevity of recovery, length of continuing treatment needed to retain response, and cost-effectiveness. Additional questions are associated with testing combined medication plus therapy treatments such as, “In what sequence should each intervention be administered to obtain the best outcomes?” An example of such a sequence is: Provide medication alone first for 2 months, then add in psychotherapy for 3 months, then discontinue medication while therapy continues for 3 months.

Fascinating, yet now completely unknown mechanisms-of-action questions about how medications and psychotherapies can interact are likely to be key to our ability to ultimately devise the most effective and efficient combined treatments. For example, do a particular medication and a psychotherapy interact in an additive way to affect certain problems so that the benefits of combined treatment are equal to the sum of the separate effects of each component? Alternatively, is the interaction “permissive” meaning that the presence of one component is needed to enable the other component to have its potential benefits? Alternatively, is the nature of the interaction inhibitory so that the presence of one component reduces the potential effects of the other component?

It is difficult to provide concise, general summaries of the findings from comparative studies of psychotherapies and medications, and their combination. Results exist for a variety of problems that differ markedly in symptoms and functional impairment (e.g., various anxiety disorders, types of mood disorders, schizophrenia). The find-

ings are not the same across disorders. It is of interest, though, that for at least some disorders (major depressive episode, panic disorder) the common expectation that combined treatment would be more effective than single modality treatment (either medication or psychotherapy alone) generally has not been supported yet. For example, as mentioned previously, some evidence exists that combined treatment of panic disorder is associated with poorer stability of response after treatment is discontinued than cognitive-behavior therapy alone is. For major depression, the evidence now indicates that combined treatment is not generally more effective than monomodality treatment of either type except, perhaps, for individuals with more severe or chronic (e.g., ≥ 2 years) symptoms of unipolar depression.

J. Can Psychotherapy Be Harmful?

The importance of conducting research to determine the frequency and nature of negative effects of psychotherapeutic interventions has been recognized by various therapy researchers over the years, such as Allen Bergin in the early 1960s, and Daniel Mays and Cyril Franks in the early 1980s. In the mid-1970s, Strupp and colleagues received a contract, initiated and funded by the NIMH to examine the topic. Their conclusions were published in a 1977 book, *Psychotherapy for Better or Worse: The Problem of Negative Effects*. In 1983, Edna Foa and Paul Emmelkamp edited a book focused on unsatisfactory outcomes, not negative effects per se, *Failures in Behavior Therapy*. The book illustrates the effort to improve the effectiveness of existing therapies by studying cases in which their effects are disappointing. The value of studying poor outcomes was noted in 1954 by Carl Rogers in a book that reported on the first 5 years of the therapy research program at the University of Chicago Counseling Center, *Psychotherapy and Personality Change*: “The field of psychotherapy cannot come of age until it understands its failures as well as it understands its successes.”

Research on deterioration, negative effects, and failures associated with psychotherapeutic interventions has not been prolific, but many questions have been examined. For example, the possible contribution of therapist personality features to poor outcomes has been studied as has the interaction of treatment approach (e.g., supportive vs. more “confrontational”) with patient characteristics.

A review of research on the important topic of negative effects is included in Michael Lambert and Allen Bergin’s chapter in the 1994 *Handbook of Psychotherapy and Behavior Change*. The review does not include

relevant findings and methods that now are emerging from patient-focused research strategies. Such information can be found in Lambert and Ogles' chapter, "The Efficacy and Effectiveness of Psychotherapy" in the fifth edition of the *Handbook of Psychotherapy and Behavior Change*.

IV. CONCLUDING COMMENTS

Much ground has been covered in this article. Even so, some milestones in psychotherapy research have not been discussed, such as research on the therapeutic alliance (a subject that is covered in a separate article in this volume). Important topics have been skipped (e.g., research on training in psychotherapy) or referred to only in passing (e.g., the gulf between therapy research findings and clinicians' satisfaction with their utility for practice). Moreover, the Key Questions section doubtless has left the impression that some crucial and basic discoveries are yet to be made. For example, much more remains to be learned than is known about the major causal agents of change in existing therapies, and the relevant moderating variables.

Bountiful evidence has been provided that conducting informative, reasonably conclusive research on psychotherapy is difficult. Sol Garfield, one of the field's major contributors and astute critics, is among those who observed that a core problem is that clinical research is very unlike controlled laboratory experiments. The central variables in therapy research (e.g., patients, therapists, extratherapy events, outcomes) have proven to be particularly intransigent both to evaluation and to the kind of experimental controls needed to obtain unambiguous findings. Given the challenges, many of which were revealed as researchers tried to answer the field's fundamental questions, Michael Lambert and Allen Bergin's appraisal of progress as of 1992, seems apt: "Psychotherapy research has been exemplary in facing nearly insurmountable methodological problems and finding ways of making the subjective more objective."

Given the difficulties of the endeavor, one might ask, "Why do psychotherapy research?" The field's first 60 to 80 years has revealed that the work can be painstaking and can yield results that, although very informative and important, are surprising and disappointing—sometimes especially to those who worked to find them. But what are the implications for clinical practice and for the patients who are served by it if therapy research is not pursued? Lee Sechrest, in an

electronic mail message to the Society for the Study of Clinical Psychology in 2000, observed: "reliance on authority (teachers, supervisors, trainers) or on one's experience does not allow you to know whether you are right or wrong." In the same message, Sechrest credited C. P. Snow for saying: "Science cannot guarantee that you will be right forever, but it can guarantee that you won't be wrong forever." For those who are dedicated to the responsible and ethical provision of mental health treatments, Paul Meehl's observation in 1955 (*Ann. Rev. Psych.* 6) exemplifies a compelling justification for psychotherapy research:

The history of the healing arts furnishes ample grounds for skepticism as to our nonsystematic "clinical" observations. Most of my older relatives had all their teeth extracted because it was 'known' in the 1920s that the clearing up of occult focal infections improved arthritis and other disorders ... Like all therapists, I personally experience an utter inability not to believe I effect results in individual cases; but as a psychologist I know it is foolish to take this conviction at face value.

Acknowledgments

Morris Parloff, Donald Kiesler, and Marvin Goldfried all key contributors to and observers of the development of psychotherapy research in its first 60 to 80 years, generously provided comments and perspectives on the content of this article. Lisa Onken and Barry Lebowitz, two experts on the field who view therapy research from leadership positions at the U.S. National Institutes of Health, also graciously provided comments. Winnie Eng, a student of therapy research, made helpful suggestions. Responsibility for errors, omissions, and interpretations of events remains the author's. Quote page 541: Copyright and used by permission of John Wiley & Sons, Inc.

See Also the Following Articles

Cost Effectiveness ■ Effectiveness of Psychotherapy ■ Efficacy ■ History of Psychotherapy ■ Outcome Measures

Further Reading

Beutler, L. E., & Crago, M. (Eds.). (1991). *Psychotherapy research: An international review of programmatic studies*. Washington, DC: American Psychological Association.

Chambless, D. L., & Ollendick, R. H. (2001). Empirically supported psychological interventions: Controversies and evidence. *Annual Review of Psychology*, 52, 685–716.

- Freedheim, D. K. (1992). Psychotherapy research (Section III, Chapters 9–12). In D. K. Freedheim (Ed.), *History of psychotherapy: A century of change* (pp. 305–449). Washington DC: American Psychological Association.
- Handbook of psychotherapy and behavior change*. (1971–). (Editions 1–4, 5th ed., in press). New York: John Wiley and Sons.
- Kazdin, A. E. (1994). Methodology, design, and evaluation in psychotherapy research. In A. E. Bergin & S. L. Garfield (Eds.), *Handbook of psychotherapy and behavior change* (4th ed., pp. 19–71). New York: John Wiley and Sons.
- Kazdin, A. E. (Ed.). (1998). *Methodological issues & strategies in clinical research* (2nd ed.). Washington, DC: American Psychological Association.
- Kraemer, H. C., & Telch, C. F. (1992). Selection and utilization of outcome measures in psychiatric clinical trials: Report on the 1988 MacArthur Foundation Network I Methodology Institute. *Neuropsychopharmacology*, 7, 85–94.
- Orlinsky, D. E., & Russell, R. L. (1994). Tradition and change in psychotherapy research: Notes on the fourth generation. In R. L. Russell (Ed.), *Reassessing psychotherapy research* (pp. 185–214). New York: Guilford Press.
- Persons, J. B. (1991). Psychotherapy outcome studies do not accurately represent current models of psychotherapy. *American Psychologist*, 46, 99–106.
- Schooler, N. (Vol. Ed.). (1998). Research methods. In A. Bellack & M. Hersen (Series Eds.), *Comprehensive clinical psychology* (Vol. 3). London: Elsevier Science.
- Wilson, T. (1996). Manual-based treatments: The clinical application of research findings. *Behaviour Research and Therapy*, 34, 295–314.

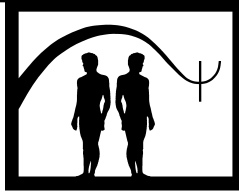

Resistance

Kay McDermott Long and William H. Sledge

Yale University School of Medicine

- I. Definition
 - II. Freud on Resistance
 - III. Contemporary Psychoanalytic Views
 - IV. Behavioral Therapy Perspectives
 - V. Clinical Examples
 - VI. Summary
- Further Reading

GLOSSARY

character A person's enduring patterns of thinking, feeling, and acting, as well as habitual ways of resolving inner conflict.

compromise formation The mind's attempt to resolve conflict between various aspects of a person's inner world and external reality by reorganizing the various aspects of the inner world so that competing interests are all given expression. For example, a fantasy may represent a compromise formation in that it expresses a wish, as well as defenses against the wish and ways a person imagines being punished for the wish.

defense A general term used to describe the mind's, usually unconscious, attempts to protect itself from felt dangers, such as loss of love or of the loved one, loss of physical integrity, or a harsh conscience and all the attendant uncomfortable feelings.

drive (instinctual drive) A strong endogenous motivational force, especially of a sexual or aggressive nature, that motivates behavior toward a particular end.

interpretation The analyst puts into words his or her understanding of what the patient has been expressing, perhaps even without knowing it, to add new knowledge about a patient's mental life.

object relations The particular, individual patterns of relating to others that are characteristic of a person.

repression The exclusion of painful ideas, impulses, and feelings from conscious awareness.

transference The largely unconscious process of shifting feelings, thoughts, and wishes originally experienced with significant figures in childhood onto current figures in one's life.

unconscious Mental content that one is not aware of at any given time, though one may get glimpses of it through dreams, slips of the tongue, and disconnected thoughts.

Resistance is a term used to describe the various ways patients in psychotherapy oppose the process of change. This article briefly traces the development of this concept in Freud's thinking and then presents contemporary psychoanalytic views of resistance. In addition, psychoanalytic views will be contrasted with a behavioral perspective. Finally, clinical examples illustrate how a psychoanalytically oriented psychotherapist might understand and treat resistance in a treatment situation.

I. DEFINITION

Perhaps the clearest and most direct definition of resistance was Freud's deceptively simple statement in 1900, in his landmark work, *The Interpretation of*

Dreams: “Whatever disturbs the progress of the work is a resistance.” His discovery of the phenomenon, his attempts to understand it, and his work with it led him to some of his most important technical and theoretical discoveries in psychoanalysis. The concept of resistance still stands today as a cornerstone of psychoanalytic theory and practice; however, precise definition of the term remains elusive. In fact, any comprehensive definition of resistance includes almost all the key analytic concepts: drive, defense, compromise formation, character, and transference.

II. FREUD ON RESISTANCE

Early in his psychotherapeutic career Freud worked with Joseph Breuer treating women with hysterical symptoms. In their jointly published book, *Studies on Hysteria*, Freud describes his work with Fraulein “Elisabeth von R.,” his first reported full-length analysis of hysteria and his first case report of resistance. By this time Freud had seen the limitations of using hypnosis and the power of suggestion to help his patients give up their hysterical symptoms, and he had already turned to encouraging his patients to talk freely as a method of cure. As Freud worked with Elisabeth, she would fall silent and refuse to speak. When Freud asked her what was on her mind she replied, “Nothing.” Freud surmised that her not talking was a way of resisting treatment. Undiscouraged, Freud was able to make virtue out of a defect. He realized that resistance was not an obstacle to be overcome, but a way in and of itself to reach the repressed and overcome neurosis.

Freud learned through clinical experience how tenacious and persistent resistance could be even in patients truly interested in symptom relief and in the process of therapy. Anything could be used as a resistance to treatment: falling silent, forgetting, intellectual discussions about theory and treatment, coming late, seeing the therapist as the enemy. Equally suitable for resistance was coming on time, finding everything the therapist says helpful and brilliant, talking without hesitation.

At first blush, resisting treatment seems irrational. Why would someone who is suffering and coming for help in relieving that suffering resist efforts to get better? The attempt to answer this question led Freud to the discovery of key aspects of his theory and therapy. Freud posited that people fall ill due to the repression of painful memories or wishes, that is by pushing painful experiences out of conscious awareness. They get better by remembering those painful experiences.

However, to readmit those warded-off mental contents into consciousness is inherently marked by conflict. It entails undoing or giving up the mental structures that have been created to achieve some form of adaptation, however costly and unsuccessful. The patient, understandably, resists recognition of painful experiences, and, in essence, mounts the same efforts that brought about the repression of the pain in the first place.

When Freud attempted to overcome this resistance through suggestion and authority, he was met with increased resistance. This led him to recognize the importance of interpreting the resistance rather than directly interpreting the warded-off aspects of the patient’s experience. Resistance to treatment begins to seem more understandable in light of the patient’s fear (perhaps even unconscious) that the “cure” may be worse than the “disease.” Competing wishes are doing battle within the patient: the wish to leave well enough alone and the desire to ally with the therapist to be able to “remember” in the hopes of eventual relief of suffering. Ultimately the patient must ally with the therapist well enough to develop a partnership in exploration, and first and foremost exploration of his resistances.

In one of Freud’s technical papers “Dynamics of Transference,” he elaborates: “Resistance accompanies the treatment at every step; every single association, every act of the patient’s must reckon with this resistance, represents a compromise between the forces aiming at cure and those opposing it.” In fact, Freud defined psychoanalysis in terms of resistance. In a later work he wrote,

It may thus be said that the theory of psychoanalysis is an attempt to account for two striking facts of observation which emerge whenever an attempt is made to trace the symptoms of a neurotic back to their sources in his past life: the facts of transference and resistance. Any line of investigation which recognizes these two facts and takes them up as the starting point of its work has a right to call itself psychoanalysis, even though it arrives at results other than my own.

Freud’s first attempt to inventory resistances was in his previously cited book, *Studies on Hysteria*. Here he recognized that some resistances are manifest and some are hidden which led him to recognize the unconscious aspects of resistance and ultimately to see that his current model of the mind (topographic theory of conscious and preconscious) was not sufficient to account for the clinical phenomena he observed. Consequently he developed the structural theory of id, ego, and super-ego. Reflecting the further development of his ideas

Freud was still expanding his inventory of resistances 25 years later in “Inhibitions, Symptoms and Anxiety” in which he outlined three types of resistances: ego resistances—repression, transference resistance, and secondary gain from illness; superego resistances—unconscious guilt and need for punishment; id resistances—such as the repetition compulsion.

As Freud developed his theories of psychoanalytic technique he continued to emphasize the central role of interpreting resistance, along with the transference (i.e., relating to the therapist as if he or she were an important figure from the patient’s past). In fact, he viewed transference itself as, in part, a resistance in that the patient was enacting a prior relationship rather than remembering and verbalizing it. Freud came to see that transference and resistance both impede and facilitate cure. The desire to remember is opposed by the desire to forget. According to Freud, analytic technique must first and foremost address itself to overcoming resistance.

III. CONTEMPORARY PSYCHOANALYTIC VIEWS

Psychoanalytic thinking, including the theory of resistance, has developed along several paths since Freud laid down his original ideas. Psychoanalytic thinkers since Freud have been trying to sort out his somewhat diverse legacy concerning resistance. At times Freud seemed to consider resistance as something to be overcome and at other times as psychical acts that could be understood. That same duality persists today in those who endorse techniques designed to overcome or bypass resistance and make the unconscious conscious, and those who would seek to recognize and clarify resistance at work and to try to analyze the perceived threat to the patient’s functioning posed by trying to overcome the resistance. Adherents to the work of Melanie Klein in Great Britain (Kleinians) have been responsible for the development of the former view, while ego psychologists in North America (contemporary Freudians) have been developing the latter view. In addition, another school of thought has developed inspired originally by the works of Hans Kohut (self psychology, interpersonal or relational psychology) that has taken psychoanalytic theory and technique in quite a different direction. Although the ego psychological perspective has been the dominant view in North America, the influence of the Kleinians and the self psychologists is increasingly felt and is working its way into the mainstream of analytic thinking.

A. Ego Psychology

The central role of resistance in theory and technique has been best preserved in analysts schooled in an ego psychological approach (contemporary Freudians). Resistance, along with its successful interpretation by the analyst, is held as the essential unit of clinical psychoanalysis. A patient resists not just remembering but also resists understanding the nature of the felt dangers that caused the original repression. The patient is seen as struggling with internal conflicts not with the therapist. Resistance is a ubiquitous, recurring, ever-present aspect of the psychotherapeutic work. Successful therapy does not bring about removal of resistances but an understanding of them so that a new set of resistances can emerge and be explored. Successful psychoanalysis is the successful negotiation of one resistance after another. Problems occur when the patient becomes stuck in one particular resistance and cannot move on to other ones.

Contemporary Freudian efforts to develop Freud’s ideas on resistance have focused on the defensive aspects of resistance. In this vein contemporary analytic thinkers view resistance as whatever gets in the way of a patient being able to recognize what comes to mind, as well as how and why it comes to mind. Paul Gray and his followers have led the field in contemporary efforts to develop Freud’s ideas on resistance. Gray is particularly interested in the defensive aspects of resistance. He argues that traditionally analysts work to get past the resistance to get at what the patient is experiencing but not why the experience is so painful that the patient resists knowing it. Gray and his adherents argue for an approach that takes into account the importance of understanding why something is resisted as well as what it is that is being resisted. In Gray’s view, it is not just that an experience is painful that it is avoided but that it threatens the patient with feeling overwhelmed and losing the capacity to function adequately.

B. The Kleinian School

In this school the emphasis has been on penetrating interpretations aimed at reaching the deepest levels of a person’s unconscious experience. Trying to locate and articulate unconscious fantasies takes precedence over interpreting resistance. Resistances are seen in terms of object relationships rather than as impersonal mechanisms of the mind. That is to say they occur in the context of the relationship between the analyst and patient or between figures in the person’s internal world.

C. Self Psychology, Interpersonal or Relational Psychology

In this framework resistances are not viewed as ways the patient is avoiding communicating or knowing something about the self, but as yet another way the patient has of communicating something important about the self to the analyst. What another analyst might see as resistance, a relational analyst would view as a communication from the patient to the analyst about something the patient wants the analyst to know and to hold in the analyst's mind because the patient cannot yet tolerate knowing it consciously. It is then the analyst's job to "contain" the communication and eventually to put this "unspeakable, unknowable" mental content into words.

In sum, a contemporary analyst might hear Freud's patient, Elisabeth's response of "Nothing" when asked what was on her mind as an attempt to keep painful experience out of mind and hence avoid feeling overwhelmed (ego psychology); as an unconscious repetition of an internal object relationship (Kleinian); or as an attempt to communicate something about herself to the analyst (self psychology/interpersonal psychology).

IV. BEHAVIORAL THERAPY PERSPECTIVES

Behavior therapy, of course, is a multifaceted approach about which generalizations should be made cautiously. So it would be misleading to state that there is a particular perspective or approach to the idea of resistance emanating from behavior therapists. Nevertheless, certain similarities and differences can be noted. For one, although behavior therapists and psychodynamic psychotherapists both believe that human behavior is more or less lawful and ultimately understandable, the laws that are in question are fundamentally different between the two approaches. Behavior therapy is based on the idea of the preeminence of the environment in controlling and shaping actions whereas the psychodynamic psychotherapist is concerned with the internal environment of the individual actor and the role of unconscious mental processes in governing behavior. Naturally then, when faced with the inevitable difficulty of the patient in complying with the prescribed treatment, adherents to the two approaches will see different (from one another) forces at work. Behavior therapists will look to the environment as the source of the problems while the psychoanalytically oriented therapist will see the key environment driving the patient as being located within the patient.

The definitions of resistance of the two perspectives are also different. For behavior therapists resistance is antitherapeutic behavior. For the psychodynamic psychotherapist resistance is the force working against making conscious unconscious processes in the context of the patient's effort to make changes in action, thinking, and feeling. In both perspectives, the patient acts in a way to keep the therapy from having a full effect. Behavior therapists tend to see resistance as something that has to be changed or eliminated. Psychoanalytic therapists see resistance as an essential element of the change process. For the behavior therapist, resistance is usually conceptualized as the therapist's failure to perceive accurately and fully the lawful rules by which the environment is influencing the behavior of the patient. The behaviorists think of resistance as just another part of the patients' world that has to be taken care of in the delivery of the therapy. For the behaviorist, it is not a central or core concept.

V. CLINICAL EXAMPLES

Though psychotherapists today may not be familiar with the history of Freud's thinking about resistance they are intimately familiar with the same clinical phenomena that led Freud to his theoretical and technical innovations. Day by day, hour by hour, psychotherapists confront powerful resistance on the part of even the most motivated patients.

Ms. A., usually very responsible in her time management, found herself over the course of a number of weeks arriving later and later for her psychotherapy appointment. At times she was as much as 15 or 20 min late and would berate herself for wasting valuable time. "How will I ever get better if I can't even get here on time to talk about my problems?" she asked. Her therapist suggested that perhaps she had mixed feelings about her therapy, wanting to be here to get better, but perhaps she was also aware of something that felt uncomfortable about being here. Several weeks later Ms. A. arrived only a few minutes late and saw the previous patient leaving her therapist's office. She felt a wave of jealous, competitive feelings come over her that she immediately wanted to disavow. Instead she decided, reluctantly, to talk to her therapist about her feelings of jealousy and dislike for the woman who saw him in the hour before her. As they talked about this the therapist suggested that these jealous feelings that clearly disturbed her might be playing a part in her recent pattern of coming late to her sessions. Immediately she saw that she had unwittingly avoided these feelings by coming

so late she would never run into any “rivals” leaving her therapist’s office. This understanding of her resistance led her to talk more about the role of jealous and competitive feelings in her life and also led her to resume coming to her therapy hour on time.

Mr. B. came to treatment feeling desperately unhappy about almost every aspect of his life. He had few friends, was not able to sustain romantic relationships, and felt stymied in trying to choose among various career paths open to him. Mr. B.’s therapist noticed that no matter what kind of comment she made to Mr. B., Mr. B. rejected it. For example, Mr. B. was talking about being in a social situation the previous evening and described becoming extremely anxious as he began to talk to a particular woman he found attractive. His therapist, thinking she was empathically reflecting what he had already said, responded that Mr. B. seems to become anxious around women he finds attractive. Mr. B. immediately responded, “Well, not exactly. I mean maybe but not always.” After repeated efforts to try to talk with Mr. B. about his feelings and dilemmas the therapist realized that the work would go nowhere until the resistance was explored. The therapist pointed out to Mr. B. that every time she attempted to say something, even if it was something the patient has just described, the patient would reject it. The therapist interpreted that the patient seemed to be having trouble taking in anything from the therapist. Over time with the therapist’s help the patient was able to observe this response over and over again in their conversations, and he began to be curious about it. He came to understand more about his attempts to shut out the therapist in this way and about the ways this related to his experiences with his intrusive mother as well as with others in his present life.

In these examples we can see that resistance is not just an obstacle to be overcome but the expression of essential aspects of the patient’s characteristic ways of relating to themselves and others, the exploration of which can lead to significant therapeutic gains, as well as open doors to further areas of conflict and to transference manifestations.

VI. SUMMARY

All psychotherapists are faced with the many ways patients seek and resist help in the same endeavor. How that resistance is defined, understood, and worked with varies widely between schools of therapy, as well as within a particular school of thought. There is no single voice in psychoanalysis or in behavioral therapy, yet meaningful distinctions between the two schools of thought exist.

Practitioners of behavior therapy and psychoanalysis treat the clinical phenomenon of patients’ opposition to the effects of the treatment in very different ways. Adherents of both perspectives recognize the clinical phenomenon and its salience for the effectiveness of the treatment. In the case of the psychoanalytic perspective, resistance is seen as an essential, indeed necessary element of the treatment process. It is inevitable, and there are technical, specific strategies and clinical rules and theoretical formulations designed to address this phenomenon. Of course, this conceptualization depends on the existence of an unconscious mental process that can both enhance as well as oppose conscious motivations and intentions at the same time.

Behavior therapy practitioners, on the other hand, tend to conceptualize the patient’s inability to follow the treatment program as a lack or defect on the part of the therapist in not accurately understanding and formulating the contingencies in the patient’s life. Behavior therapy provides no such motivational construct of patient-originated resistance to the treatment. Rather, behavior therapists locate the problem as existing in a faulty understanding of and/or application of treatment on the part of the therapist. Indeed, behavior therapists make room for the prospect that it would be impossible for all therapists at all times to understand all patients. The responsibility, however, for the treatment progress or lack thereof rests clearly on the shoulders of the therapist.

The different ways of conceptualizing the phenomenon of patient-originated opposition goes to the core of the differences between behavior therapy and psychoanalysis. Psychoanalysis postulates underlying and unwitting motivational complexes that can be in conflict with one another, and behavior therapy locates these conflicts entirely in the contingency environment of the patient.

See Also the Following Articles

Countertransference ■ Engagement ■ Interpretation ■ Object-Relations Psychotherapy ■ Termination ■ Transference ■ Unconscious, The ■ Working Alliance

Further Reading

- Boesky, Dale. (1990). The psychoanalytic process and its components. *Psychoanalytic Quarterly*, 59, 550–584.
- Busch, Fred. (1992). Recurring thoughts on unconscious ego resistances. *Journal of the American Psychoanalytic Association*, 40, 1089–1115.
- Gray, Paul. (1987). On the technique of analysis of the superego—an introduction. *Psychoanalytic Quarterly*, 56, 130–154.

- Kris, Anton. (1985). Resistance in convergent and in divergent conflicts. *Psychoanalytic Quarterly*, 54, 537–568.
- Renik, Owen. (1995). The role of an analyst's expectations in clinical technique: Reflections on the concept of resistance. *Journal of the American Psychoanalytic Association*, 43, 83–94.
- Schafer, Roy. (1973). The idea of resistance. *Journal of the American Psychoanalytic Association*, 54, 259–285.
- Spezzano, Charles. (1995). “Classical” versus “contemporary” theory—the differences that matter clinically. *Contemporary Psychoanalysis*, 31, 20.
- Wachtel, Paul. (Ed.). (1982). *Resistance psychodynamic and behavioral approaches*. New York: Plenum.
- White, Robert. (1996). Psychoanalytic process and interactive phenomena. *Journal of the American Psychoanalytic Association*, 44, 699–722.

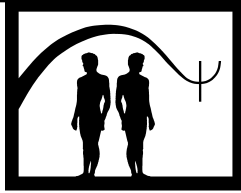

Response-Contingent Water Misting

J. Grayson Osborne

Utah State University

- I. Equipment
- II. Operational Definition
- III. Functional Outcome
- IV. Subjects
- V. Side Effects
- VI. Observations and Opinions
- VII. Chronological Annotated Literature Review
Further Reading

GLOSSARY

AB design A case study design in which the behavior of interest is first measured in the absence of treatment (during Condition A). Treatment is then applied (during Condition B). Changes of the behavior in Condition B cannot be attributed to the change from Condition A to Condition B.

ABAB withdrawal design A single subject research design in which A = baseline (no treatment) conditions; B = treatment conditions in which, after the occurrence of baseline (no treatment) treatment is presented for a number of sessions and then is withdrawn, and then is re-presented. The intent is to establish the effect of treatment.

aggression Behavior directed toward another individual that either produces or intends to produce physical or emotional damage.

alternating treatment design A research design in which several treatments are presented in succession in random order within sessions.

aromatic ammonia The use of ammonia as a punisher by holding it under an individual's nose contingent upon the emission of undesirable behavior (often pica).

BAB design Where B = treatment and A = no treatment; same as ABAB withdrawal design except that the study starts with the treatment condition immediately.

demand condition A diagnostic condition in which an individual is asked to perform a response the result of which is aggression by the individual against the asker with the intent that the aggression will make it less likely that the demanded response will be performed.

differential reinforcement of incompatible behavior (DRI) Reinforcement of a response (R_1) that is functionally incompatible with another response (R_2) with the intent of reducing in frequency that other response (R_2). The intent is that R_1 will occur frequently enough because it is being reinforced so there is limited opportunity for R_2 to occur.

differential reinforcement of other behavior (DRO) Reinforcement of the absence of a response (R_1) for a period of time with the intent of reducing it in frequency. At the end of the period of time whatever response (R_0) is occurring, as long as it is not the response that is supposed to be absent (R_1), is reinforced. As with DRI, the intent is that R_0 occurs frequently enough because it is being reinforced so there is limited opportunity for R_1 to occur.

facial screening A punishment technique in which the individual's face is briefly covered with a towel whenever an undesirable behavior occurs.

fading procedures Any of a number of procedures in which the known controlling stimuli of a discriminated response are gradually diminished in their apparentness such that their stimulus control passes to other stimuli that are more apparent in the current environment.

forced arm exercise Raising and lowering the arms of an individual in rapid succession as a punishment technique.

generalization of punishment The occurrence of the effects of punishment (i.e., the reduced frequency of the punished response) in an environment in which the response was not formally punished.

hand biting A self-injurious response in which the hand is inserted in the mouth and bitten, often with resulting tearing of the skin.

head banging/hitting Any response of an individual that brings the head into forceful contact with an object or body part.

lemon juice (therapy) Typically a squirt of lemon juice in the mouth contingent upon the emission of an undesirable behavior; often used with individuals who ingest nonedible substances in an attempt to punish such ingestion.

mental retardation Any endogenous or exogenous condition the result of which is an individual who has significant challenges in functioning independently in everyday life.

mouthing Putting an open mouth on objects or more typically on other body parts (e.g., skin) usually to the point where the other body part is damaged.

multiple baseline across settings The sequential treatment of a response in each of several settings; while being treated in one setting measurements of the frequency of the treated behavior occur in the other settings. If no change in frequency occurs in the other settings until and only if the behavior is treated in that setting, causal inferences about the treatment are typically thought to be strengthened.

pica The ingestion of inedible substances.

positive reinforcement Response-contingent presentation of a stimulus that has the effect of increasing the frequency (strength) of the response that it follows; both parts of this definition are necessary to the inference of positive reinforcement.

prepunishment baseline The frequency of occurrence of a response before punishment of the response.

programmed generalization The processes that produce the occurrence of a behavior therapeutic outcome in an environment in which it was not treated.

punisher A punishing stimulus, the presentation of which causes a decrease in the frequency of the response on which it is contingent.

punishment Either the presentation of a stimulus or the withdrawal of a stimulus, which has the effect of reducing the frequency of the response on which such presentation or withdrawal is contingent.

punishment procedure Either the response-contingent presentation or withdrawal of a stimulus, which has the effect of reducing the frequency of the response on which such presentation or withdrawal is contingent.

response Anything an organism (person) does or says that can be reliably observed and reported.

response-contingent faradic shock Electrical current delivered to an individual contingent upon the emission of a response, typically a self-injurious or aggressive response.

response-contingent water mist Water misting a person contingent upon that person's emission of a response, typically a self-injurious or self-stimulatory response.

restitutional overcorrection The overcorrection procedure in which the individual undergoing the procedure returns the environment to its former (presumably unspoiled) state, such as righting furniture that may have been thrown over during a tantrum. May also include a component in which the individual is required to improve on the unspoiled environment, such as polishing the furniture.

self-choke Any response of an individual that has the effect of cutting off the supply of oxygen to the brain.

self-injury Tissue damage caused by an individual's own behavior, such as head banging or head slapping.

self-injurious (behavior) responses Any response an organism emits that is either immediately tissue damaging or is tissue damaging in the long term.

self-stimulatory behavior (responses) Behavior that occurs in the absence of apparent, empirical reinforcement; typically assumed to be inherently reinforcing.

side effects Unprogrammed outcomes of behavioral procedures that may be positive or negative.

skin tearing Picking/pulling at loose pieces of skin.

stereotypic behaviors Peculiar responses that are emitted repetitively across long periods of time (e.g., mouthing), may be synonymous with self-stimulatory responses.

time-out (from positive reinforcement) Either the removal of a person from a reinforcing environment for a few minutes or the removal of the reinforcing environment from the person for the same few minutes contingent upon the emission of some undesirable response; a punishment technique.

water mist The spray from a water bottle.

water misting The act of spraying water mist at a person; typically a reaction to the occurrence of a self-injurious behavior by that person.

Response-contingent water misting has been used as a mild punisher to suppress self-injurious behavior (SIB) and/or self-stimulatory behavior in people with mental retardation. It is the subject of a little over a dozen clinical and research papers in the literature. Response-contingent water misting came to prominence as a function of the search by behavior analysts for mild punishers to use when reinforcement-based behavior reduction techniques had failed and stronger punishment techniques were inappropriate, as discussed by Bailey and colleagues in 1983. This article describes the use of the technique, its effectiveness, and drawbacks to its use. It also provides a chronological, annotated bibliography of the known literature.

I. EQUIPMENT

In its most prevalent use, water, at room temperature, is placed in a plastic spray bottle. Spray bottles used for

the purpose of water misting are those commercially obtained for household use. They are manufactured in a variety of sizes that hold up to 1 liter of water. Spray is emitted from the nozzle of the spray bottle when a hand pump/trigger that is part of the nozzle and the cap to the bottle is squeezed. Each squeeze of the pump dispenses about 0.5 cc. The nozzle is usually adjustable to produce gradations from a thin stream of water (like that from a squirt gun) to a fine mist. The mist usually describes a diffuse arc of water greater than 90 degrees and travels no more than about 46 cm. Thus, those operating the water mist must hold the spray bottle within 30 cm of the subject of the water misting.

II. OPERATIONAL DEFINITION

Room temperature water mist is sprayed in the recipient's face from a distance of 30 cm contingent upon the emission of a defined response. As is the case with all punishment procedures, unless the procedure is being used for research purposes, water misting does not occur absent concurrent positive reinforcement for behavior incompatible with the water-misted response.

III. FUNCTIONAL OUTCOME

The desired outcome is complete cessation of the water-misted response. Such an outcome is rare. Rather, the technique most often produces good, but partial, suppression of the response. Thirty to 90% suppression of the contingent response roughly encompasses the range of suppression in the literature. Suppression of the contingent response appears to be enhanced by the concurrent positive reinforcement of behavior incompatible with the contingent response. Response-contingent water mist does not appear to produce permanent suppression of the contingent response, as there is often recovery when the procedure is withdrawn, as discussed by Bailey et al., in 1983, Dorsey et al. in 1980, and Osborne et al. in 1992. Recovery is often incomplete; that is, the rate of the punished response does not return to the prepunished baseline. One implication of the recovery finding is that the procedure must be used chronically to maintain suppression of the responses on which it is contingent. However, fading procedures, in which the spray bottle is kept near to hand but where its presence cannot be discriminated by the subject, are effective in producing generalization of suppression beyond the occasions and environments of therapy, according to research by Jenson et al. in 1985 and Rojahn

et al. in 1987. In these procedures, the bottle has been made smaller so that it can be easily concealed.

IV. SUBJECTS

Subjects in the clinical and research literature have been primarily individuals with severe to profound mental retardation, often with additional challenges such as impaired vision and hearing and limited mobility. Most subjects described in the literature had been exposed to many other procedures to reduce the self-injurious or self-stimulatory responses that are frequently the focus of their behavioral programs, in the absence of good effect. These procedures are often the differential reinforcement of other behavior (DRO) or the differential reinforcement of incompatible behavior (DRI) in which the attempt is made to strengthen behavior that—when it occurs—precludes the occurrence of the self-injurious or self-stimulatory behavior. The literature is silent on how effectively these other procedures were applied. As these other procedures usually are mentioned as the reason to proceed with water misting, their ineffectiveness is assumed.

V. SIDE EFFECTS

No negative side effects have been reported. However, as with any punishment procedure there is always a chance of aggression against the therapist, according to Rojahn et al. in 1987. It may be notable that many of the subjects of this procedure appeared to be less than capable of aggression against a therapist because they were nonambulatory and confined to wheelchairs as discussed by Dorsey et al. in 1980, or they had visual impairments according to Dorsey et al. in 1980, Fehr & Beckwith in 1989 and Osborne et al. in 1992. Positive side effects appear to include enhanced effectiveness of concurrent positive reinforcement, as described by Fehr and Beckwith in 1989, and increased social interaction, as discussed by Singh et al. in 1986, which are common to other punishment procedures as well, according to Risley in 1968.

VI. OBSERVATIONS AND OPINIONS

Water misting was initially used for several reasons, as discussed by Dorsey et al. in 1980. First, it was easier to administer than other punishment procedures such as faradic shock or restitutional overcorrection. Second, the equipment (a spray bottle) was inexpensive

and highly portable. Thus, it could be used in many different environments. Third, unlike other punishment procedures (e.g., response-contingent faradic shock), water misting appeared not to present any health risks to those on whom it was used. Fourth, because of its relative simplicity, it was easy to train staff in its use. Fifth, staff had fewer objections to using water mist than they did other punishment procedures. Sixth, given all of the foregoing, water misting—as punishment—could be considered relatively innocuous.

Notwithstanding these reasons, no evidence suggests that the technique has been used in the past decade. Since this time period is concurrent with the absence of virtually all other applied punishment research, it is concluded that the national crusade against the utilization of formally described punishment procedures is responsible. (I say formally here, because most therapists involved with institutionalized people understand that informal punishment procedures continue to be used by the staff of such institutions.)

Water misting is not a completely effective punishment procedure. If it were, it would produce complete cessation of responding, no negative side effects, no avoidance of the therapist, and generalization outside treatment sessions. Therefore, it is possible that the reason that it is no longer used is that it was not effective enough. However, absent complete suppression, there are no negative side effects of the procedure, there is no evidence of avoidance of the therapist, and there is some evidence of generalization outside treatment sessions. Therefore, response-contingent water misting is an effective—if not completely effective—punishment procedure. Utilization of the procedure has suffered the fate common to the formal application of all other punishment procedures.

In the beginning, water misting was used as an alternative to more effective punishment procedures, such as response-contingent faradic shock, according to Dorsey et al. in 1980. It was used also because it was thought that society would tolerate its use better than had been shown to be the case for faradic shock. Clearly, this was an incorrect supposition. No behavior analyst ever feels good about administering any form of punishment during therapy sessions, particularly to a subject who is not capable of escape. Water misting was no exception. Colleagues worried about changes in subjects' dignity and self-worth. Yet, such concerns were overridden by the felt need to help reduce what was, and is, perceived to be serious self-injury and its long-term effects. Response-contingent water misting seemed a good compromise.

A possibly serious restriction on the effectiveness of response-contingent water misting is the absence of application of this procedure to normal populations. The procedure would seem, on its face, to constitute a possible backup to ineffective verbal reprimands by parents of their young children. It could constitute a viable alternative to the more uncontrolled use of corporal punishment. Absent any such information, however, it should be understood that generalization of the effectiveness of contingent water misting beyond the rather restricted populations on which it has been successfully used is unwise.

VII. CHRONOLOGICAL ANNOTATED LITERATURE REVIEW

1. Peterson, R. F., & Peterson, L. W. (1977). Hydropsychotherapy: Water as a punishing stimulus in the treatment of a problem parent-child relationship. In B. C. Etzel, J. M. LeBlanc, & D. M. Baer (Eds.), *New developments in behavioral research, theory, method, and application*. Hillsdale, NJ: Lawrence Erlbaum.

Study Design. Single subject, ABAB withdrawal design imbedded in contact/no-contact context; punishment only in contact context; during no contact, parent ignored child's head banging; followed by time-out phase.

Subject. 3.5-year-old male; with mental retardation.

Response. Head banging/hitting.

Treatment. 4-oz water splash delivered by parent from a water glass from a distance of 18 to 30 cm concurrently with a shouted, "No!"

Results. Good suppression by water splash over baseline in contact and no-contact periods; suppression not as good during no-contact context; but no-contact period provided evidence of generalization of punishment. Recovery during withdrawal phase, but phase stopped before recovery could further increase. Time-out was about as effective as water splash. Suppression maintained during follow-up, however, time-out was continued during this period.

Critique. Not really water misting. Study included because it appears to be a precursor to the water-misting procedure. Note difficulty of governing amount of water to be splashed and how much less water appears to be as effective when using water misting.

2. Murphrey, R. J., Ruprecht, M. J., Baggio, P., & Nunes, D. L. (1979). The use of mild punishment in combination with reinforcement of alternative behaviors to reduce the self-injurious behavior of a profoundly retarded individual. *AAESPH Review*, 4, 187–195.

Study Design. Single subject, BAB design.

Subject. Profoundly retarded male.

Response. Self-choke.

Treatment. Water squirt in the area of the mouth for self-choke; positive reinforcement of other behaviors; treatment application in six different settings; utilization of seven different therapists.

Results. Good suppression of self-choking (near 90%); quick recovery during treatment cessation (A); considerable recovery by follow-up after 20 months.

Critique. Treatment begun in the absence of a recorded baseline. Good attempt at programmed generalization.

3. Dorsey, M. F., Iwata, B. A., Ong, P., & McSween, T. E. (1980). Treatment of self-injurious behavior using a water mist: Initial response suppression and generalization. *Journal of Applied Behavior Analysis, 13*, 343–353.

Experiment 1:

Study Design. ABAB within-subject, reversal designs.

Subjects. Seven nonambulatory persons with profound mental retardation, with additional auditory and visual impairments, 5 to 37 years old.

Responses. Mouthing; hand biting; skin tearing; head banging.

Treatments. Water mist contingent upon SIB.

Results. Substantial reductions in SIB frequencies during treatment conditions—but not to zero—followed by recovery (instantly in four of the seven cases) to prior levels during treatment absence (baselines).

Critique. No concurrent positive procedures. No generalization outside sessions.

Experiment 2:

Study Design. Single subject; case study with successive treatments, across two environments; i.e., AB1B2B3 where A = baseline; B1 = response contingent “No”; B2 = “No” + water mist + DRO 1 minute; B3 = “No” + DRO.

Subjects. 21-year-old female, nonambulatory, with profound mental retardation; 26-year-old female, nonambulatory, from Experiment 1.

Response. Hand biting.

Results. Little or no suppression during B1; good suppression in one environment each for each subject during B2, but not in the second environment; addition of DRO helped with suppression for one subject but not the other in the second environment; upon withdrawal of water mist (B3) there was continued suppression in both subjects in the previously successful environment and good suppression in the remaining environments for both subjects.

Critique. No measurements beyond treatment sessions. Authors anecdotally note no generalization in

terms of long-term maintenance of suppression across the entire day.

4. Gross, A. M., Berler, E. S., & Drabman, R. S. (1982). Reduction of aggressive behavior in a retarded boy using a water squirt. *Journal of Behavior Therapy & Experimental Psychiatry, 13*, 95–98.

Study Design. Single subject; ABAB design with follow-up.

Subject. 4-year-old male with mental retardation.

Response. Biting; gouging (i.e., aggression).

Treatment. Baseline continued a hand slap and “No!” contingent on aggression that was already in place; treatment consisted of water misting—with mister set to the concentrated stream setting.

Results. Good suppression by water squirt over the hand slap procedure; some recovery during withdrawal of water squirt, but not back to original baseline; subsequent good suppression during second treatment application; zero frequencies at 6-month follow-up.

Critique. All day use of technique may have helped its success. Note that the study is only one of two (see work by Peterson and Peterson in 1977) that use water not in mist form.

5. Bailey, S. L., Pokrzywinski, J., & Bryant, L. E. (1983). Using water mist to reduce self-injurious and stereotypic behavior. *Applied Research in Mental Retardation, 4*, 229–241.

Study Design. Single subject; ABAB design with no treatment probes.

Subject. Ambulatory 7-year-old male with severe mental retardation with autism.

Response. Mouthing; hand biting.

Treatment. Water misting contingent upon finger/hand mouthing; all other contingency-based programs continued; including time-out for aggression during water misting.

Results. Excellent, but not complete, suppression during treatment periods; suppression also during no-treatment probes but not nearly as much as during treatment periods; recovery—but not complete recovery—during withdrawal phase; good suppression thereafter in no-treatment probe conditions.

Critique. Lengthy study, but no follow-up.

6. Friman, P. C., Cook, J. W., & Finney, J. W. (1984). Effects of punishment procedures on the self-stimulatory behavior of an autistic child. *Analysis and Intervention in Developmental Disabilities, 4*, 39–46.

Study Design. Single subject; ABACADAB where A = baseline; B = water mist; C = lemon juice; D = vinegar with follow-up.

Subject. 11-yr-old male with severe mental retardation and autism.

Response. Hand touching (hand clapping; hand jabbing; finger jabbing).

Treatment. Water mist to the face or lemon juice squirted in the mouth; or vinegar squirted in the mouth.

Results. Partial suppression during water mist followed by complete recovery during withdrawal; less suppression with lemon juice; about same suppression as water mist with vinegar; more suppression in second water mist phase; follow-up was continued use of water mist by staff and teacher with very good suppression.

Critique. Sessions were only 5 minutes. Baseline conditions and background in all treatment sessions consisted of structured play that involved therapists telling subject what to do explicitly—a demand condition that may have contributed to baseline frequencies.

7. Reilich, L. L., Spooner, F., & Rose, T. L. (1984). The effects of contingent water mist on the stereotypic responding of a severely handicapped adolescent. *Journal of Behavior Therapy & Experimental Psychiatry, 15*, 165–170.

Study Design. Single subject; multiple baseline across settings and teachers with follow-up.

Subject. 15-year-old female, deaf and blind.

Response. Stereotypic behavior (e.g., picking up coats, paper, etc., and covering her head with these items).

Treatment. Head coverings removed and water mist applied to subject's face immediately, while during baseline she was allowed to keep covered for 2 minutes before covering was removed.

Results. Good, but not complete, suppression on application of water misting in each environment only when water mist applied; good suppression in the presence of each teacher. Zero frequency at 17 months follow-up.

Critique. Not a very exciting response. There did not seem to be anything life threatening about it, nor did it have the qualities of stereotypic behavior (that is, on its face, did not seem highly self-stimulatory). Rather, response appeared to be attention getting. However, DRO had been tried and had failed.

8. Jenson, W. R., Rovner, L., Cameron, S., Peterson, B. P., & Keisler, J. (1985). Reduction of self-injurious behavior in an autistic girl using a multifaceted treatment program. *Journal of Behavior Therapy and Experimental Psychiatry, 16*, 77–80.

Study Design. Single subject; case study with generalization and follow-up.

Subject. 6-year-old-female, autistic, with moderate to severe mental retardation.

Response. Hand biting.

Treatment. Contingent water mist plus loud “No!” Size of spray bottle reduced across phases (fading). Parents also used program at home.

Results. Virtually complete suppression. Long-term follow-up showed almost complete suppression also.

Critique. Case study design. However, fading size of bottle and having parents do procedure at home, may have contributed substantially to long-term effectiveness.

9. Singh, N. N., Watson, J. E., & Winton, A. S., (1986). Treating self-injury: Water mist spray versus facial screening or forced arm exercise. *Journal of Applied Behavior Analysis, 19*, 403–410.

Experiment 1:

Study Design. Single subject; alternating treatments design with follow-up.

Subject. 17-year-old female, with profound mental retardation.

Response. Face slap.

Treatment. Alternation of contingent water mist with facial screening counterbalanced across the two daily sessions.

Results. Substantial reductions in frequencies of face slapping by both water misting and facial screening with slightly more reduction by the facial screening.

Critique. No generalization or measurement to other times of day.

Experiment 2:

Study Design. Same as Experiment 1.

Subject. 17-year-old female with profound retardation.

Response. Finger licking.

Treatment. Same as Experiment 1.

Results. Only about 25% reduction by water mist; much greater reduction by facial screening; socially positive interactions increased.

Critique. No generalization or measurement to other times of day.

Experiment 3:

Study Design. Same as Experiment 1.

Subject. 17-year-old female, with profound retardation.

Response. Ear rubbing.

Treatment. Water misting alternated with forced arm exercise.

Results. Water mist reduced ear rubbing by 80%; but forced arm exercise reduced it by 90%; socially positive interactions increased.

Critique. No generalization or measurements to other times of day. Forced arm exercise may have been more effective because subject was precluded from ear rubbing during the exercise.

10. Rojahn, J., McGonigle, J. J., Curcio, C., & Dixon, M. J. (1987). Suppression of pica by water mist and aromatic ammonia: A comparative analysis. *Behavior Modification, 11*, 65–74.

Study Design. Simultaneous (alternating) treatment design with fading.

Subject. 16-year-old female, autistic, with severe mental retardation, with mild cerebral palsy.

Response. Pica (tacks, staples, crayons, strings, woven material, paper, cigarette butts).

Treatment. Three daily sessions (7.5 minutes). Water mist, aromatic ammonia, and no treatment alternated across these sessions; location of bottle faded; generalized to other therapists.

Results. Virtually complete suppression of pica by water mist. Early ammonia administration produced increase in pica followed by decrease. Possible increase in collateral mild aggressive behavior. No increase in collateral SIBs.

Critique. No long-term follow-up. Absence of concurrent positive reinforcement program.

11. Fehr, A., & Beckwith, B. E. (1989). Water misting; Treating self-injurious behavior in a multiply handicapped, visually impaired child. *Journal of Visual Impairment and Blindness, 83*, 245–248.

Study Design. Single subject; case study; combined multiple baseline across settings and ABA design.

Subject. 10-year-old male; visually impaired; auditory agnosia; profound mental retardation.

Response. Head hit.

Treatments. Fine water mist spray to face contingent upon head hit, preceded with “No!” Food contingent on peg placement and toy play.

Results. Substantial reductions of head hitting in breakfast and lunch environments but not in class or residence hall until positive reinforcement for appropriate behavior was added in the latter two.

Critique. No follow-up. No measurement of response outside of treatment sessions and environments.

12. Paisey, T. J. H., & Whitney, R. B. (1989). A long-term case study of analysis, response suppression, and treatment maintenance involving life-threatening pica. *Behavior Residential Treatment, 4*, 191–211.

Study Design. Single subject.

Subject. 16-year-old male with profound mental retardation.

Response. Wandering; pica.

Treatment. Phase 1: Assessment. Pica observed in 4 settings—observers present; subject alone; baits on the floor but neck screen on (blocked vision of floor); neck screen on but baits on furniture, unlimited edibles,

contingent mesh hood (did not permit ingestion); contingent water mist accompanied by loud “No!”, contingent lemon juice. *Phase 2. Lemon juice punishment for pica and boundary training using water mist; Phase 3: Residential treatment package.* Lemon juice punishment for pica; water mist contingent upon crossing a taped line (wandering); DRI; DRO.

Results. Assessment. Pica greatest during alone context; pica lowest during lemon juice, mesh hood, and ad lib edibles, high during water mist contingency. Still mean frequencies of pica were reduced by half during water misting. *Program Development.* Excellent suppression of pica by lemon juice; good suppression of boundary crossing by water mist and warning. *Residential treatment package.* Lemon juice suppressed pica about 50%; with addition of water mist for boundary crossing there was additional suppression; upon withdrawal of lemon juice and water mist after 30 months there were some increases in pica but suppression was still about 50%.

Critique. Water mist shown not to be too effective with pica, but more effective with boundary crossing (wandering); Excellent study length, although disappointing to see that after so much time there was still an increase in pica after withdrawal of water misting and further increase in pica after withdrawal of lemon juice.

13. Peine, H. A., Liu, L., Blakelock, H., Jenson, W. R., & Osborne, J. G. (1991). The use of contingent water misting in the treatment of self-choking. *Journal of Behavior Therapy and Experimental Psychiatry, 22*, 225–231.

Study Design. Single subject, case study; AB design with treatment generalization and follow-up.

Subject. 25-year-old deaf, blind, male with profound mental retardation.

Response. Self-choke.

Treatments. Fine water mist spray to face contingent upon self-choke, paired with “No!” 20-second absence of self-choke produced face wipe, juice sip, and hug or pat on back.

Results. Approximately 2 responses/min in baseline to .03 to .12 responses/min during treatments—17- to 70-fold reduction. Zero responses during 8-month follow-up.

Critique. AB case study design; no disaggregation of water misting and the positive reinforcement procedure. Except for follow-up—an important exception—no measurement of response outside of treatment sessions and environment.

14. Osborne, J. G., Baggs, A. W., Darvish, R., Blakelock, H., Peine, H., & Jenson, W. R. (1992). Cyclical self-injurious behavior, contingent water mist treatment, and the possibility of rapid-cycling bipolar disorder.

der. *Journal of Behavior Therapy and Experimental Psychiatry*, 23, 325–334.

Study Design. Single subject, case study; multiple probe design in which pre- and posttreatment baselines were taken before and after each treatment session.

Subject. 45-year-old female; visually impaired, with profound mental retardation.

Response. Head slap.

Treatments. Water mist spray to face contingent upon head slap, paired with “No hitting!” DRO 1 to 6 minutes for social and tangible reinforcers. Session end contingent upon a successful DRO interval.

Results. Subject cycled between high- and low-frequency periods of SIB lasting 4 to 14 weeks. Mean reduction from pre-session baseline during treatment was 71% for high-frequency periods; mean reduction from pre-session baseline during treatment baseline was 85%. No difference between pre-session baseline and treatment during low-frequency periods; reduction to zero in post-treatment baselines after treatment during low-frequency periods.

Critique. Use of pre- and posttreatment baselines shows recovery of SIB frequencies from posttreatment to next pretreatment baselines. DRO procedure not uncoupled from water mist procedure. No effect of water mist procedure on length of this subject’s high- and low-frequency SIB periods.

See Also the Following Articles

Differential Reinforcement of Other Behavior ■ Fading ■ Negative Punishment ■ Overcorrection ■ Positive Punishment ■ Response Cost ■ Time-Out

Further Reading

Bailey, S. L., Pokrzywinski, J., & Bryant, L. E. (1983). Using water mist to reduce self-injurious and stereotypic behavior. *Applied Research in Mental Retardation*, 4, 229–241.

Dorsey, M. F., Iwata, B. A., Ong, P., & McSween, T. E. (1980). Treatment of self-injurious behavior using a water mist: Initial response suppression and generalization. *Journal of Applied Behavior Analysis*, 13, 343–353.

Fehr, A., & Beckwith, B. E. (1989). Water misting: Treating self-injurious behavior in a multiply handicapped, visually

impaired child. *Journal of Visual Impairment & Blindness*, 83, 245–248.

Friman, P. C., Cook, J. W., & Finney, J. W. (1984). Effects of punishment procedures on the self-stimulatory behavior of an autistic child. *Analysis and Intervention in Developmental Disabilities*, 4, 39–46.

Gross, A. M., Berler, E. S., & Drabman, R. S. (1982). Reduction of aggressive behavior in a retarded boy using a water squirt. *Journal of Behavior Therapy and Experimental Psychiatry*, 13, 95–98.

Jenson, W. R., Rovner, L., Cameron, S., Petersen, B. P., & Kesler, J. (1985). Reduction of self-injurious behavior in an autistic girl using a multifaceted treatment program. *Journal of Behavior Therapy and Experimental Psychiatry*, 16, 77–80.

Osborne, J. G., Baggs, A. W., Darvish, R., Blakelock, H., Peine, H., & Jenson, W. R. (1993). Cyclical self-injurious behavior, contingent water mist treatment, and the possibility of rapid-cycling bipolar disorder. *Journal of Behavior Therapy and Experimental Psychiatry*, 23, 325–334.

Paisey, T. J. H., & Whitney, R. B. (1989). A long-term case study of analysis, response suppression, and treatment maintenance involving life-threatening pica. *Behavioral Residential Treatment*, 4, 191–211.

Peine, H. A., Liu, L., Blakelock, H., Jenson, W. R., & Osborne, J. G. (1991). The use of contingent water misting in the treatment of self-choking. *Journal of Behavior Therapy and Experimental Psychiatry*, 22, 225–231.

Peterson, R. F., & Peterson, L. W. (1977). Hydropsychotherapy: Water as a punishing stimulus in the treatment of a problem parent-child relationship. In B. C. Etzel, J. M. LeBlanc, & D. M. Baer (Eds.), *New developments in behavioral research, theory, method, and application* (pp. 247–256). Hillsdale, NJ: Erlbaum.

Reilich, L. L., Spooner, F., & Rose, T. L. (1984). The effects of contingent water mist on the stereotypic responding of a severely handicapped adolescent. *Journal of Behavior Therapy and Experimental Psychiatry*, 15, 165–170.

Risley, T. R. (1968). The effects and side effects of punishing the autistic behaviors of a deviant child. *Journal of Applied Behavior Analysis*, 1, 21–34.

Rojahn, J., McGonigle, J. J., Curcio, C., & Dixon, M. J. (1987). Suppression of pica by water mist and aromatic ammonia. *Behavior Modification*, 11, 65–74.

Singh, N. N., Watson, J. E., & Winton, A. S. W. (1986). Treating self-injury: Water mist spray versus facial screening or forced arm exercise. *Journal of Applied Behavior Analysis*, 19, 403–410.

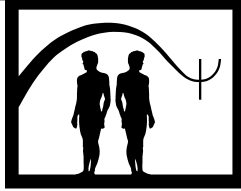

Response Cost

Saul Axelrod

Temple University

- I. Definition
 - II. Conceptual System
 - III. Forms
 - IV. Applications
 - V. Advantages
 - VI. Disadvantages
 - VII. Considerations in Using Response Cost
 - VIII. Summary
- Further Reading

GLOSSARY

point-based response cost procedure Point removal in a point economy contingent on a targeted undesirable behavior.

response cost A punishment procedure in which a person loses a reinforcer or a portion of reinforcers following an undesirable behavior. A naturally occurring example of response cost is a traffic fine following an arrest for speeding.

I. DEFINITION

Response cost is the removal of a person's or group's reinforcer(s) as a consequence of an undesirable behavior. Although the entire reinforcer can be removed, more commonly, only a portion is removed. Response cost derives from the notion that the probability of the occurrence of a behavior is related to its physical or monetary cost. That is, the greater the cost of performing a behavior, the less likely it is that the behavior will be performed. Some authors specify that

the lost reinforcers must be conditioned, but they may also be primary, as in the loss of a portion of a person's edible reinforcers.

II. CONCEPTUAL SYSTEM

A response-cost procedure that results in a decrease in the future rate of a certain behavior is classified as Type II punishment. It differs from Type I punishment in that a reinforcer is removed rather than an unpleasant event (e.g., a loud verbal reprimand) being applied. Response cost differs from extinction, which involves termination of the delivery of ongoing reinforcers. It differs from time-out, which specifies a period of time in a less reinforcing environment following an inappropriate behavior. Response cost does not involve a temporal component, although a person can lose allotted minutes from a desired activity. Response cost is similar to time-out in that both procedures have an aversive component.

Hierarchies of restrictiveness of decelerative procedures usually place response cost as more restrictive than extinction and equal in restrictiveness to time-out procedures. The present author recommends that this classification be revised because response cost is quicker acting and associated with fewer undesirable side effects than extinction. Also it does not require physical intervention (e.g., removing people from ongoing activities), as do many time-out applications.

III. FORMS

The most common form of response cost is evident when a government fines its citizens for traffic violations, paying taxes late, or failure to obey health and safety regulations. A precondition for its application is that an individual have something to lose. Therefore, in order for a response-cost procedure to be applicable, a person must either have reinforcers to lose or must be provided with them.

Often, response-cost procedures are carried out in the context of token-reinforcement programs. Tokens in the form of points, stars, chips, check marks, smiley faces, and so on are removed contingent on display of inappropriate behaviors. The tokens are conditioned reinforcers that can be exchanged periodically for backup reinforcers. The amount of tokens an individual is penalized is crucial since it must be large enough to impact behavior, but not so large that a person quickly loses all of her or his reinforcers.

In one common form of response cost, people lose reinforcers from an existing pool. The pool of reinforcers can already exist in the person's possession or can be provided to the person by the program implementer. For example, a client could be fined \$25 each time she missed an appointment at a weight-control clinic. Or a teacher could give a student 15 tokens each day and remove one each time he violated a classroom rule.

In a second form of response cost, a person could start the day with no reinforcers, but earn reinforcers for appropriate behavior and lose them for inappropriate behavior. The popular television quiz show, "Jeopardy," is conducted according to this format. People residing in group homes often experience programs of this type. Thus, the individuals may receive points for carrying out household chores and for prosocial behaviors and lose points for violations such as fighting and failing to do assigned work.

Variations of each of these approaches can also be applied. First, response cost can be carried out on a group-contingent basis. Thus, students can be given 10 extra minutes of free play, but lose 1 minute each time a classmate breaks a classroom rule as follows:

10, 8, 8, 7, 6, 5, 4, 3, 2, 1, 0

In this case there were a total of three violations; thus, each member of the class had 7 extra minutes of free time.

In a second variation, free reinforcers can be retained on an all-or-none basis. This modification, frequently mislabeled as differential reinforcement of low rate of

response (DRL), could involve allowing a child to stay up an extra 15 minutes if she takes her brother's toys less than three times during the day. If she violates the rule three or more times, she loses the privilege of staying up 15 minutes late.

Finally, as was the case in the two previous examples, program implementers can program penalties from a bonus pool. That is, people can be offered a bonus for refraining from inappropriate behavior. Rule violations then result in the loss of the bonus, rather than what was already due the individual (e.g., the regular recess time). This variation can reduce ethical objections to the use of response cost.

IV. APPLICATIONS

The variety of settings, populations, and behaviors to which response cost has been successfully applied is immense. Settings include traditional homes, schools, clinics, group residences, work sites, correctional facilities, playgrounds, and athletic fields. Populations include children and adults, with and without handicaps. A partial list of behaviors comprises classroom disruptions, aggressiveness, sleep difficulties, excessive drinking, overeating, inattentiveness, speech disfluencies, psychotic speech, food scavenging, toileting accidents, failure to use seatbelts, occupational injuries, failure to keep appointments, failure to hand in assignments punctually, and hair and eyelash plucking. In a naturalistic environment, it has been shown to radically reduce directory assistance calls and could probably be employed to combat resource shortages involving fuel usage and water consumption.

V. ADVANTAGES

Response cost is one of the most effective interventions available. It commonly produces immediate, large, and enduring changes in behavior. It can be applied immediately, easily, and precisely following an undesirable behavior. The application typically does not interfere with the ongoing activity. Unlike time-out, response cost does not remove a violator from the setting in which the problem behavior occurred. Thus, a student who committed an infraction would not lose academic time. Unlike time-out and overcorrection, response cost does not involve physical interaction that could lead to injury. Compared to extinction, response cost works more quickly and produces greater decreases in behavior.

Unlike other punishment procedures, response cost is seldomly associated with adverse side effects. At times it results in desirable side effects. Thus, a reduction in disruptive behavior through response cost has sometimes resulted in appropriate social interactions. Also response cost rarely incurs public objections. It tends to fall within society's norms on how people should treat each other and is compatible with the principle that those who break a rule should pay proportionally.

VI. DISADVANTAGES

Although uncommon, adverse side effects of response cost have been noted. These include emotional responses and aggression following reinforcer removal and avoidance of the environment in which response cost occurs. Also response cost calls attention to the inappropriate behavior, possibly reinforcing its occurrence. All of these problems can be reduced or eliminated by combining response cost with positive reinforcement for appropriate behavior. Thus, a person will not avoid an environment that is mostly reinforcing, but employs occasional response cost. Also attention to appropriate behavior will lessen the likelihood that response cost will reinforce inappropriate behavior.

A significant problem that can occur is that a person could lose all of her or his reinforcers, thereby nullifying the response-cost procedure. In such cases a back-up system such as time-out might be necessary. Another problem is that, due to its effectiveness and ease of implementation, response cost can be overused. It might, for example, be effectively applied to minor infractions that do not justify a punishment procedure. Finally, given the numerical nature of many response-cost procedures, some mastery of quantification is often necessary. This may limit its usefulness with very young or severely cognitively limited individuals.

VII. CONSIDERATIONS IN USING RESPONSE COST

Given that response cost is a punishment procedure, it should only be used when more constructive approaches, such as positive reinforcement, are unreasonable or ineffective. Also the usual operations concerning any behavioral intervention should be employed. This includes defining the behavior(s) of concern, measuring its occurrence during baseline and intervention, specifying

the rules of the operation, and revising the procedure when necessary.

In point-based response-cost procedures, point removal should be immediate, obvious, and follow all infractions. The point removal should be done in such a manner as to provide feedback to the offending individual, but should not involve comments that could reinforce inappropriate behavior (through attention) or trigger additional problems.

Significant issues with point-based response cost are setting the upper limit and determining how many points to remove on each occurrence. As indicated earlier, the procedure can be negated when all points are lost. Baseline measures can help set the upper limits for response cost. Thus, the upper limit for a person who displays 40 misbehaviors might be 20, whereas the upper limit for someone who displays 5 misbehaviors might be 3. Research has indicated that the removal of two points per infraction is more effective than removing one. Yet, removing two points might cause the upper limit to be exceeded more quickly than removing one point. In general, the effectiveness of response cost is so great that the upper limit is seldom reached.

Without exception response-cost procedures should be combined with positive reinforcement for appropriate behavior. This can take the form of bonuses or can simply consist of praise for appropriate behavior. The combination of response cost and positive reinforcement is more effective than either procedure used alone. The combination of procedures also allows for the possibility of gradually removing the response-cost procedure and maintaining improved performance with positive reinforcement procedures alone.

VIII. SUMMARY

Response cost is a punishment procedure in which a person loses a reinforcer or a portion of reinforcers following an undesirable behavior. It is powerful, easily implemented, and socially acceptable. It has been successfully used across a wide variety of behaviors, populations, and settings. For reasons of effectiveness and humaneness, it is best combined with positive reinforcement for appropriate behavior.

See Also the Following Articles

Differential Reinforcement of Other Behavior ■ Extinction ■ Good Behavior Game ■ Overcorrection ■ Positive Reinforcement ■ Punishment ■ Token Economy

Further Reading

- Alberto, P. A., & Troutman, P. A. (1999). *Applied behavior analysis for teachers*. Columbus, OH: Merrill.
- Heron, T. (1987). Response cost. In J. O., Cooper, T., Heron, & W. L., Heward, (Eds.), *Applied behavior analysis*. Columbus, OH: Merrill
- Kazdin, A. E. (1972). Response cost: The removal of conditioned reinforcers for therapeutic change. *Behavior Therapy*, 3, 533–546.
- McSweeney, A. J., (1978). Effects of response cost on the behavior of a million persons: Charging for directory assistance in Cincinnati. *Journal of Applied Behavior Analysis*, 11, 47–51.
- Pazulinec, R., Meyerrose, M., & Sajwaj, T. (1983). Punishment via response cost. In S. Axelrod & J. Apsche (Eds.), *The effects of punishment on human behavior* (pp. 71–86). New York: Academic Press.
- Reynolds, L. K., & Kelly, M. L. (1997). The efficacy of a response-cost based treatment package for managing aggressive behavior in preschoolers. *Behavior Modification*, 21, 216–230.
- Thibadeau, S. F. (1998). *How to use response cost*. Austin, TX:Pro-Ed.
- Weiner, H. (1962). Some effects of response cost upon human operant behavior. *Journal of the Experimental Analysis of Behavior*, 5, 201–208.

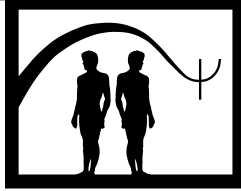

Restricted Environmental Stimulation Therapy

Jeanne M. Bulgín and Arreed F. Barabasz

Washington State University

W. Rand Walker

University of Idaho

- I. Description
 - II. Biological and Psychophysiological Effects
 - III. Application Efficacy
 - IV. Summary
- Further Reading

GLOSSARY

chamber REST A type of REST that involves secluded bed rest in a small light-free and sound-attenuated room.

dry flotation REST A type of REST that involves a sound and light attenuated enclosed chamber designed so that the research participant is separated from the fluid, a solution of $MgSO_4$, by a velour-covered thin plastic polymer membrane.

restricted environmental therapy/treatment (REST) An experimental psychotherapeutic practice that, through the use of a solitary environment and a drastically reduced level of external sensory stimulation (i.e., light, sound, touch, and gravity) can produce beneficial effects on medical, psychological, and behavioral health outcomes, particularly when used in conjunction with other therapies.

wet flotation REST A type of REST that involves the use of a specially designed sound and light attenuated enclosed tank filled with a skin temperature aqueous solution of Epsom salts and water.

I. DESCRIPTION

Two decades ago, Peter Suedfeld coined the term restricted environmental therapy or technique (REST) as a less pejorative description of sensory deprivation. REST

was born out of experimental methods designed to study the affects of environmental stimulus reduction on human beings. The earliest and most relevant preliminary research was published in the 1950s by Donald Hebb of McGill University who, with his students and collaborators, described the effects of “severe stimulus monotony” on his research participants to test his theory of centrally directed behavior. Hebb’s experimental setup consisted of a completely light-free and sound-attenuated chamber in which the participant was isolated on a bed for a period of 2 to 3 days. Further sensory reduction was attempted by using variations of the basic setup such as having the participant wear translucent goggles and cardboard sleeves that fit over the hands and arms to limit visual and tactile stimuli and/or enclosing research participants in “iron lungs.”

Shortly after publications involving chamber REST methods, John C. Lilly, a neuropsychologist at the National Institute of Mental Health, published findings from his sensory reduction research that focused on the effects of many natural or non-experimental experiences of isolation. These included details of autobiographical accounts from individuals who were isolated geographically or situationally. As a result of these findings, Lilly and his associate, Dr. Jay Shurley, pursued the origins of conscious activity within the brain and whether the brain required external stimuli to keep its conscious states active. To fully address this question, Lilly designed the flotation tank, which restricted environmental stimulation as much as was practical and feasible.

The experimental setup of flotation REST required that the research participant be submerged up to the neck in an enclosed tank of water. A diving helmet acted to block out outside visual stimulation and a breathing apparatus was used so that the participant could respire if the nose and mouth should drop below the level of the water. Although the helmet decreased visual stimuli, the breathing apparatus was anything but noise free. Over the years, Lilly continued his experiments with flotation, simplifying and improving the general design of the tank. Lilly found that one could float in a more relaxing supine position, rather than suspended feet downward in fresh water, if more buoyant salt water was used. This method allowed for the subsequent elimination of the breathing apparatus. Other refinements, such as water heaters, air pumps, and water filters for the reuse of the Epsom salts, were added and by the early 1970s, Lilly had developed the flotation tank in much the design that is used today.

Early studies addressing chamber and flotation REST tested participant endurance, often up to several days, and included setups that were ultimately stressful (being enclosed in iron lungs, cardboard sleeves and/or goggles, or having to rely on a noisy breathing apparatus for respiration as well as being almost completely submerged). It was no wonder that many of the findings from the initial reports were dramatic and negative. Such findings included aversive emotional reactions, disruptions of conscious states, negative hallucinations, interference with thinking and concentration, and sexual and aggressive fantasies. Later research suggested that these negative findings could be understood on the basis of a negative experimental set (aberration and endurance), of an excessive duration of isolation, and of demand characteristics. The most frequent and replicable results of REST are an openness to new information, increased suggestibility, increased awareness of internal cues, decreased arousal, and attentional shifts. These results not only contradict earlier studies, they actually hint at some potential benefits of REST. Research evidence indicates that REST consistently has beneficial effects on medical, psychological, and behavioral health outcomes, particularly when used in conjunction with other therapies.

Current use of REST involves three differing optimal methods and one method that can be used in clinical settings without substantial accommodations. The first, chamber REST, involves secluded bed rest for a variable amount of time, generally 24 hours or less, in a small, completely dark, and sound-attenuated room. Most of the data to date has been generated through

the use of this technique. The second method, wet flotation REST, involves the use of a light-free, sound-attenuated flotation tank, resembling a large covered bathtub filled with a skin temperature solution of saturated Epsom salts and water. The research participant floats supinely in the tank for a time period that is generally 90 min or less. The third method is termed dry flotation REST. This method includes a rectangular chamber that is designed so that the research participant is separated from the fluid, a solution of $MgSO_4$, by a thin, plastic polymer membrane. Again, the float time is generally 90 min or less. In clinical settings it is possible to restrict the environment by using darkened goggles, earplugs, sound maskers, and a room with reasonable sound attenuation.

II. BIOLOGICAL AND PSYCHOPHYSIOLOGICAL EFFECTS

The research examining the biological and psychophysiological effects of chamber and flotation REST has been based on more than 1,000 incidents in which 90% of the individuals interviewed reported marked feelings of relaxation and a greater focus on internal processes because external stimuli is limited. A summary of specific findings regarding the relaxation response and cognitive processes are discussed in this section. Such findings include both subjective and objective measurements of various effects.

The relaxation response can be understood by studying several different biochemical and psychophysiological parameters. First, subjective measures of REST have been collected to study relaxation effects using various instruments including the Spielberger State Anxiety Scale, Zuckerman Multiple Affect Adjective Checklist, subjective units of disturbance scale (SUDS), and the profile of mood states (POMs). These instruments conclude that REST participants perceive significantly lower levels of subjective measures of stress and feelings of calmness, alertness, and deep relaxation.

Endogenous opiate activity has been studied, as it is frequently associated with increased pleasure responses and is related to a reduction of stress and pain, and increased relaxation. Results of these studies suggest that REST increased central nervous system availability of opioids across sessions. In addition, a state of relaxation can be defined as exhibiting low levels of the biochemical substrates involved in the stress response. The stress response is a fairly complicated reaction that involves hormone changes from the adrenal glands in

particular. Basically, the hormones triggered by stress in this response include norepinephrine, epinephrine (commonly known as adrenaline), adrenocorticotropin (ACTH), cortisol, renin, and aldosterone. Each of these hormones play a role at various organ systems that results in the increase of heart rate, blood pressure, respiration, and muscle tension. Therefore, stress response parameters studied in REST research include blood pressure, muscle tension, and heart rate, as well as the adrenal axis hormones mentioned earlier.

Research studies that have examined heart rate, muscle tension, blood pressure, and various plasma and urinary adrenal hormones conclude that REST consistently produces significant decreases both within and across sessions of these measurements. Other hormones have been measured in conjunction with those mediating the stress response to provide an experimental control. These hormones have included testosterone and lutenizing hormone (LH) and have been found to remain consistent in a 1990 study by Charles R. Turner and Thomas H. Fine. Significant reductions in blood pressure was a finding that was established through case studies of hypertensive individuals, and later in controlled research studies that began in the early 1980s. Researchers that studied REST's effects on hypertensives included Fine and Turner, Jean L. Kristeller, Gary E. Schwartz, and Henry Black, and Suedfeld, Cuni Roy, and Bruce P. Landon, to name a few. This research concludes that a significant decrease in both systolic and diastolic blood pressure can occur in hypertensives. Furthermore cortisol and blood pressure have been shown to maintain these effects 9 months after cessation of repeated REST sessions in a follow-up study by Kristeller, Schwartz, and Black in 1982. Thus, the effects of REST are more than an immediate response that is reversible.

Cognitive effects of REST include a shift in cognitive processing strategies away from analytic, sequential, and verbal thinking toward non-analytic, holistic, and imaginal thought processes. A review of common reports by Helen Crawford in 1993 describes a decrease in external stimuli with redirection to internal stimuli or more narrowly focused external stimuli with possible shifts in attentional processing (changes in focused and sustained attention). The increases in internally generated stimuli, such as fantasies and thoughts, tend to be more vivid and involving. Since 1969, researchers have studied the effects of REST and increased suggestibility. Arreed F. Barabasz and Marianne Barabasz found that floatation REST enhances hypnotizability in participants who scored low on the Stanford Hypnotic

Susceptibility Scale: Form C in 1989. Findings by A. Barabasz have also revealed that chamber and dry flotation REST dramatically influence hypnotizability whereas wet flotation REST elicits spontaneous hypnosis in participants that are highly hypnotizable.

A 1990 A. Barabasz study involving measurements of electrocortical (EEG) activity showed significantly increased theta (4–8 Hz) after flotation REST. Fine, Donna Mills, and Turner compared frontal monopolar EEG and frontal EMG readings of wet flotation versus dry flotation REST in 1993. The results showed that wet flotation REST had higher amplitude alpha frequency components. They concluded that wet flotation REST is qualitatively different in terms of central nervous system activity and may resemble the “twilight learning state.” This state is induced through hypnosis and Stage 1 sleep. Differences between dry and wet flotation REST include humidity, temperature, and amount of tactile stimulation available to the participant. It is unknown which of these factors may contribute to differences in EEG readings.

III. APPLICATION EFFICACY

In 1982, Suedfeld and Kristeller suggested that, based on the implications of research and theory, REST should be “particularly appropriate” in two types of clinical situations: habit change and states of lower arousal and relaxation. Habit change, is based on the known cognitive effects of REST. The lack of distraction, increased hunger for stimuli, and increased openness to new information associated with the stimulus reduction experience, leads to a uniquely focused state of awareness. Lower arousal or relaxation effects of REST facilitate treatments addressing problems associated with chronic or acute stimulus overload such as dysfunction of information processing and stress-related disorders. Research findings have shown that chamber REST applications are particularly effective for the modification of habit disorders, whereas flotation REST sessions have been applied and have been found to be effective in the treatment of stress-related disorders, chronic pain, anxiety disorders, and sports performance enhancement. Notwithstanding the promising outcomes of REST as a treatment, as well as an augmentation strategy, the status of REST is predominantly an experimental procedure with many open questions regarding its utility and appropriateness in the clinical setting. Subsequently, REST research has been applied to a variety of problems, disorders, and opportunities for performance enhancement.

Smoking cessation studies combining REST with other traditional treatments have shown considerable promise as an augmentation strategy with multiple research sites demonstrating success rates of over 50% with follow-up periods ranging from 12 months to 5 years. In a few clinical studies, 1 to 2 years in duration, REST has been combined with weekly support groups. In those instances 75 to 80% with support group and tailored message have maintained abstinence for the length of the study.

Controlled studies have also demonstrated efficacy in decreasing the alcohol consumption of heavy drinkers. In 1987, Henry B. Adams, David G. Cooper, and John C. Scott studied the effects of REST on heavy social drinkers treated with 2.5 hours of REST with an antialcohol educational message during the treatment. The results of the study showed 55% reduction in alcohol consumption in the first 2 weeks after the treatment whereas control participants showed no significant reduction. A replication of this study showed similar results and alcohol reduction was maintained at 3- and 6-month follow-ups. A 1990 study by M. Barabasz, A. Barabasz, and Rebecca Dyer found that, for heavy drinkers, after exposure to one 12-hour or 24-hour chamber REST session, the average daily consumption of alcohol continued to drop over 6 months of follow-up. The 24-hour group's average consumption before REST was 42.7 ounces per day, immediately post-REST, it was 23.3 ounces per day, 16.0 ounces per day at 3 months, and 12.7 ounces at 6 months. Chamber REST was studied by David Baylah in 1997 as a relapse prevention technique with substance abusers enrolled in outpatient substance abuse treatment programs. At the end of 4 years of follow-up, 43% remained continuously sober and drug free, whereas none of the control group did after an 8-month follow-up.

Eating disorders have also been responsive to REST in a number of controlled studies. In a study that examined REST as a treatment for bulimia, the elimination of purging behaviors was a significant finding with a 50% success rate. In three studies using REST as a treatment for obesity, a slow continuous weight loss over a 6-month follow-up period after treatment was noted. In 1990, Dyer, A. Barabasz, and M. Barabasz utilized a true experimental design using a 24-hour REST treatment with a message (participants were asked to focus on the importance of diet and exercise and the role their particular problem foods had in their weight problems) and a REST treatment with problem foods (problem foods were brought into the chamber with the participants). Participant's total caloric consumption, problem food consumption, and body fat percentage were significantly lowered, and interviews revealed that REST appears to

facilitate the resolution of conflicting attitudes and behaviors about food. Those individuals who had 25 to 30 or less pounds to lose benefited most from the study, whereas participants who had more weight to lose reported initial losses of 5 to 10 pounds and then reported that they were unable to maintain diet and exercise regimens. Non-REST participants did not show significant weight loss in the study.

Recreational, competitive, and intercollegiate sports including basketball, archery, tennis, gymnastics, rowing, darts, skiing, and rifle marksmanship have been the focus of flotation REST treatments to enhance performance. A performance enhancement study has also been done on commercial pilots, and REST treatments showed significant improvement on instrument flights tasks as opposed to control in a Lori G. Melchiori and A. Barabasz study. REST greatly enhances mental imagery, relaxation, and visualization of skills and has been shown to produce remarkable results in anecdotal and controlled performance studies. Studies in 1991 by Jeffery D. Wagaman, A. Barabasz, and M. Barabasz have been done on improving basketball performance. In these studies, improvements on shooting foul shots in a non-game session has been shown with REST, as well as improvements on objective performance skills and coaches' blind ratings as compared to a control group. Six sessions of flotation REST plus performance enhancement imagery of approximately 50 min over a 5-week period produced improved skill in passing, dribbling, shooting, and defense game and non-game measures when compared with an imagery-only control group.

An intercollegiate tennis study by Patrick McAleney in 1991 controlled for relaxation and guided imagery confounds noted in previous research on the enhancement of human performance using REST. Twenty participants took part in 50-min flotation REST treatments with visual imagery group or an imagery-only group. Participants were pre- and posttested on athletic performance and precompetitive anxiety measure. The analyses of performance scores revealed a significant performance enhancement effect for first service winners for the flotation REST plus visual imagery group in contrast to the group that received visual imagery only. No other performance analyses (key shot, points won or lost) were significant. The results of the analyses of anxiety scores were not significant. Another study by A. Barabasz, M. Barabasz, and James Bauman in 1993 looked at the enhancement of rifle marksmanship scores to determine the effects of dry flotation REST versus hypnotic relaxation, which is a confounding variable because flotation REST elicits spontaneous hypnosis in participants that are highly hypnotizable. Twelve participants who took

part in a rifle marksmanship training course, and who were exposed to dry-flotation REST, showed significantly higher rifle marksmanship scores than 12 participants who were exposed to relaxation only. This suggests that REST's positive effects on marksmanship go beyond the induction of relaxation by hypnosis.

As mentioned previously, REST increases relaxation effects and pleasurable effects via endogenous opiate activity. Flotation REST has been studied as a treatment for chronic low back pain and chronic pain in rheumatoid arthritis, fibromyalgia, and premenstrual syndrome. Wet flotation REST was consistently associated with improved range of motion and grip strength and decreased pain both within and across sessions in all participants involved a Turner, Anna DeLeon, Cathy Gibson, and Fine 1993 rheumatoid arthritis study. Responses with dry flotation REST were less consistent and less vigorous. The moisture and heat associated with wet flotation REST are likely factors in the differences between the two types of REST treatments because rheumatoid arthritis is relieved by moist heat. A different study found that the pain associated with rheumatoid arthritis significantly decreased in participants treated by REST and autogenic training (a form of self-hypnosis). Studies on low back pain, fibromyalgia, and premenstrual syndrome also yielded significant relief of pain from REST treatments.

Stress and anxiety-related disorders are the focus of many flotation REST studies because of the role that REST plays in decreasing adrenal axis hormones associated with the stress response. Many foundational studies have been done that have illuminated REST's effects on lowering specific stress-related hormones. Other studies on anxiety-related disorders such as social anxiety, obsessive-compulsive disorder (OCD), trichotillomania (chronic hair pulling), psychophysiological insomnia, and induced stress have added to the growing body of research demonstrating that REST is effective at reducing physiological arousal related to stress and anxiety.

REST has also been used as an augmentation strategy for exposure treatments. In one case study involving a treatment refractory OCD patient, REST was used, along with an imaginal exposure treatment (using a loop tape), to treat severe contamination obsessions and compulsions. It was determined that the primary reason for the patient's unresponsiveness to traditional exposure treatments was his inability to focus on the stimulus. Subsequently, he would not meet the basic requirements of a sufficient time of exposure, as well as a lack of focused arousal. After an initial period of "REST

only," the patient was exposed to the loop tape containing the fear-evoking material. This unconventional use of REST resulted in a substantial reduction of OCD symptoms.

IV. SUMMARY

REST has come a long way since its conception in the 1950s. Although it was initially used to test hypotheses about human endurance in monotonous, sensory-deprived environments and to test theories regarding brain processes, several side effects emerged from that early research that included an openness to new information, increased hypnotizability, increased focus on internal processes, and lower arousal. These cognitive and relaxation effects of REST were studied as they were seen as potential treatments for a wide variety of psychophysiological problems, addictive behaviors, and performance enhancement. In the past decade, REST has emerged as an effective therapeutic treatment with a low occurrence of negative side effects. The relaxation and pleasurable effects of REST have been used as a mechanism to decrease anxiety and pain in treatments of stress-and pain-related disorders. The cognitive effects of REST have been effective in modifying addictive behaviors and treating phobias and compulsive behaviors. Although there are many theoretical questions that remain to be answered as well as many possible applications that have yet to be studied, continued research builds its credibility and increases its visibility and practicality as a sound therapeutic treatment.

See Also the Following Articles

Applied Relaxation ■ Arousal Training ■ Neurobiology

Further Reading

- Barabasz, A. F., & Barabasz, M. (1993). *Clinical and experimental restricted environmental stimulation: New developments and perspectives*. New York: Springer-Verlag.
- Suedfeld, P., Ballard, E. J., & Murphy, M. (1983). Water immersion and flotation: From stress experiment to stress treatment. *Journal of Environmental Psychology*, 3, 147–155.
- Suedfeld, P., & Kristeller, J. L. (1982). Stimulus reduction as a technique in health psychology. *Health Psychology*, 1, 337–357.
- Suedfeld, P., Turner, J. W., & Fine T. H. (1990). *Restricted environmental stimulation Theoretical and empirical developments in flotation REST*. New York: Springer-Verlag.

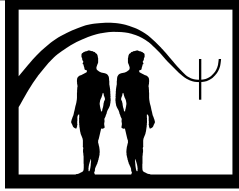

Retention Control Training

Kurt A. Freeman and Elizabeth T. Dexter

Pacific University

- I. Components of the Intervention
 - II. Bladder Capacity and Its Role in Nocturnal Enuresis
 - III. Effectiveness of Retention Control Training
 - IV. Summary
- Further Reading

GLOSSARY

enuresis Involuntary discharge of urine after an age at which urine control should have been established.

micturition The passage of urine; urination.

Retention control training (RCT) is an intervention developed for the treatment of nocturnal enuresis. This article discusses the basic components of RCT, incorporating a brief description of the clinical phenomena for which it is used. Next, the theoretical and empirical basis for the development and use of this intervention is described. Finally, a review of the effectiveness of this intervention with nocturnal enuresis is provided.

I. COMPONENTS OF THE INTERVENTION

Enuresis is a condition that involves the involuntary passage of urine by a child after the age at which urinary control would be expected. According to the American

Psychiatric Association's *Diagnostic and Statistical Manual, Fourth Edition, Text Revision (DSM-IV, TR)*, an individual must be at least 5 years of age, chronologically or developmentally, in order to be diagnosed as enuretic and experiencing repeated voiding of urine into bed or clothes, either intentionally or involuntary, at least two times per week for 3 consecutive months. If the enuretic behavior has not been present for the specified period of time, then clinically significant distress or impairment in social, academic, or other important areas of functioning must be present. Enuresis cannot be the result of a medical condition or the physiological effect of a substance, such as a diuretic. Furthermore, enuresis can be classified as either nocturnal (during sleeping hours), diurnal (during waking hours), or both. In addition to the subtypes of enuresis, it can also follow two different courses. Primary enuresis is characterized when the individual has never had a period of time with urinary continence, whereas enuresis is characterized as secondary when it begins after the individual has once established urinary continence.

Enuresis has a relatively high prevalence rate among young children and decreases as age increases. The literature reports there to be a 14 to 20% prevalence rate for 5-year-olds, 5% for 10-year-olds, 1 to 2% for 15-year-olds, and approximately 1% for 18-year-olds. In addition to differences across ages, the prevalence rate of enuresis also differs across gender. Males are twice as likely to be enuretic than females: 7% and 3%, respectively, at age 5; 3% and 2%, respectively, at age 10; and 1% and less than 1%, respectively, at age 18. Enuretic

individuals may also experience a period of spontaneous remission without treatment. The likelihood of spontaneous remission is reported to be approximately 14% between the ages of 5 and 9, 16% between the ages of 10 and 14, and 16% between the ages of 15 and 19. Finally, a strong indicator of enuresis has been found to be family history. According to the *DSM-IV, TR*, 75% of children with enuresis have a first-degree biological relative who also experienced the disorder.

RCT is an intervention technique used for the treatment of nocturnal enuresis. As an intervention, RCT is relatively simplistic and typically involves the implementation of procedures during waking hours as a means of indirectly altering urine retention during sleeping hours. In general, RCT involves instructing the enuretic child to delay micturition from the time that he or she first senses the urge to urinate. In this manner, the child is learning to increase the amount of urine that can be held in the bladder prior to urination, thus establishing appropriate inhibitory responses. In addition to delaying urination, children are typically instructed to increase fluid consumption above normal levels. By doing so, they experience more frequent urges to urinate, providing more frequent opportunities for mastering retention control.

There are several variations in the basic procedures of RCT described in the current literature. First, procedures may differ regarding the method used to delay urination. One model instructs the child to delay micturition by programming successively longer periods of time. For example, the child is encouraged by parents to increase the delay between feeling the urge to urinate and doing so by 10 minutes across successive weeks. During the first week of intervention, the child is requested to delay urination for 10 minutes. The delay is then increased to 20 minutes and 30 minutes during the second and third weeks of treatment, respectively. In contrast, another variation of RCT entails the requested delay to be systematically increased over time by first instructing the child to go to the bathroom and urinate. The child is then provided with 500 ml of fluid and coached to delay urination as long as possible. Parents note the time at which the child requests to use the toilet, ask the child to delay urination for as long as possible, and then note when the child uses the restroom. From this information, postponement time can be calculated. This latency period serves as the baseline used during subsequent training trials so that the parents and therapists can monitor that the child is delaying urination 1 to 2 minutes longer with each consecutive attempt. Finally, RCT can involve a proce-

dure that involves instructing the child simply to delay urination for as long as possible.

Second, the use of rewards for successful retention of fluids may also differ. Parents may be instructed not to provide any tangible reinforcement contingent upon successful delay of urination, to administer praise only, or to utilize procedures that involve the delivery of tangible rewards contingent upon increased fluid consumption and/or successful delay. Further, methods of reinforcement may also include instructing the child to change his or her own bed linens after voiding during sleep prior to returning to bed.

A third variation in RCT involves the child delaying urinations during the night. With this method the parents are instructed to give a large drink (i.e., 1 pint) to the child before bed and wake him or her every hour. At each awakening, the child is asked if he or she could delay urination for another hour. If so, the child returns to bed. If not, he or she is encouraged to delay urination for a few more minutes, is praised for doing so, and then is allowed to void. The child is then given another large drink and returned to bed; the amount of fluid loading may vary. Current research has only evaluated using this specific routine during the first night of treatment.

As mentioned earlier, methods of RCT may vary. To date, research has not systematically compared the various methods of administering RCT to determine which is most effective. Therefore, deciding which variation of the intervention to use depends on the structure of the child's environment (i.e., the willingness of the parents and the child) and the comfort level of the therapist with the different methods of the procedure.

II. BLADDER CAPACITY AND ITS ROLE IN NOCTURNAL ENURESIS

Various theories have been put forth to explain enuresis. Currently, enuresis is considered to be a functional disorder that is multiply determined, often with more than one causal mechanism operating with any given child. Physical causes accounting for the disorder include, but are not limited to, urinary tract dysfunctions and infections, nervous system dysfunctions, and bladder capacity deficits. Further, psychological and behavioral causes that have been shown to account for enuresis include toilet training practices and emotional disturbances.

Some research suggests that a proportion of children who experience nocturnal enuresis display small functional bladder capacities (i.e., the volume of urine at

which contractions designed to evacuate the bladder occur). Thus, although the structure of the bladder is normal, its capacity to hold typical amounts of urine is underdeveloped. This smaller-than-expected functional bladder capacity may result in excessive urination diurnally in response to small amounts of urine in the bladder, resulting in fewer opportunities to learn micturition inhibitory responses. In fact, researchers have determined that a significant portion of enuretic children urinate more frequently than nonenuretic peers. At night, this may translate into an enuretic episode given the likelihood of decreased sensitivity to urination urges while asleep. RCT is based on the assumption that increasing functional bladder capacity will result in a decrease in enuretic episodes. In order to increase the bladder capacity, enuretic children are prompted to engage in certain behaviors during the day to train their bladders to hold increasing amounts of urine before voiding.

III. EFFECTIVENESS OF RETENTION CONTROL TRAINING

A significant amount of research has been conducted over the years in regards to the effectiveness of RCT and other behavioral treatments for nocturnal enuresis. Not surprisingly, RCT has been empirically demonstrated to increase functional bladder capacity. For example, in 1960 S. R. Muellner demonstrated that enuretic children produced greater urinary output following the use of RCT. Further, in 1975, Daniel Doleys and Karen Wells demonstrated that RCT resulted in normalized functional bladder capacity for a 42-month-old child. Regarding its effectiveness in treating nocturnal enuresis, RCT alone has been found to be effective in decreasing enuretic episodes in 50 to 75% of individuals. Further, it has been shown to be 30 to 50% effective in producing complete cessation of bedwetting episodes.

RCT reduces enuresis by normalizing bladder capacity and is thus more beneficial to those with a low functional bladder capacity. A child's bladder reaches full development around the age of 4 to 5. In a 1996 study, Tammie Ronen and Yair Abraham found that the rate of increase in bladder capacity is directly related to the age of the individual utilizing RCT. Specifically, they reported that the closer one is to the typical age of bladder maturity, the faster one can increase bladder capacity. Further, the rate of increase is slower for children much younger and much older than age 4 to 5.

This is consistent with the results found in a 1990 study by Sandra Bonser, Jim Jupp, and Daphne Hewson. They implemented RCT with a 13-year-old female. Prior to implementing the treatment, the adolescent female was required to track her daily number of urinations and number of wet and dry nights for 5 weeks. This information continued to be monitored during the treatment and then for 1 week during each of the 2 months following termination of the intervention. In this study, RCT involved the adolescent holding her urine for successively longer periods of time. During the first week of treatment, she was instructed to hold her urine for 15 minutes after she first felt the urge to urinate. After 15 minutes, she was allowed to void. During the second week she was instructed to hold her urine for 20 minutes and then follow the same procedure as the previous week. In weeks 3 through 8, the adolescent was required to load her bladder with extra fluid as a means of increasing bladder capacity while continuing to hold her urine for 20 minutes. To accomplish this, she drank three large glasses of fluid in addition to her normal daily fluid intake throughout the day at breakfast, lunch, and after school. Finally, a reward system was in place based on the number of dry consecutive nights experienced. It took 8 weeks for her to decrease from seven wet nights per week to two wet nights per week and at 6-month follow-up she was experiencing only one wet night per week.

In 1970 H. D. Kimmel and Ellen Kimmel were among the first to systematically investigate the use of RCT in modern times. Three female children ages 4 and 10 participated. Baseline data revealed almost nightly bedwetting for all participants. RCT involved encouraging fluid intake (via reward contingent upon consumption) at any hour of the day and rewarding successively longer periods of retention of urine in the bladder, up to 30 minutes. Results showed that complete cessation of nocturnal enuretic episodes occurred for two of the participants within approximately 7 days of the initiation of RCT, and within 14 days for the third. Further, follow-up data indicated that none of the subjects had more than one enuretic episode during the year following treatment.

In 1972 A. Paschalis, H. D. Kimmel, and Ellen Kimmel conducted a more extensive investigation of RCT with 35 children who exhibited nocturnal enuresis. Treatment was essentially the same as that described by Kimmel and Kimmel in 1970 and was conducted for 20 days. Results showed that 40% of the participants met the criteria for success (i.e., seven consecutive nights without an accident) during the treatment period, and

an additional participant achieved success through a continuation of the treatment beyond 20 days. Of those who were successful, no relapse was noted over a 90-day period.

As mentioned previously, reinforcement methods are at times used as a component of, or in addition to, RCT. In 1987, M. Carmen Luciano used an A-B-C single-subject design to test the effects of RCT plus reinforcement on nocturnal enuresis in two male participants, ages 11 and 12. After first obtaining baseline data, Luciano introduced RCT for 5 weeks in order to evaluate the effects of increasing bladder capacity on enuretic behaviors. RCT entailed the children drinking as much fluid as possible throughout the day and then holding their urine as long as possible for progressively longer periods of time until they reached 45 minutes. In addition, the children were told to practice stream interruption exercises (i.e., physically stopping and starting the voiding of their urine) three to five times each time they voided. The boys received points throughout the day for following directions as part of a reward system. The occurrence of bedwetting was recorded daily. Results showed that the use of RCT both increased bladder capacity and reduced the number of wet nights. However, because complete cessation of the enuretic episodes was not achieved, Luciano introduced differential contingency dry wet bed (DCDWB). DCDWB entailed an inspection of the child's bed each morning with a parent. If the bed was dry, a token reward system was implemented and the parent praised the child. If the bed was wet, the child was instructed to replace the dirty linens with clean ones and to wash his soiled nightclothes. From the point at which DCDWB was initiated, the nocturnal enuresis stopped within 5 to 6 weeks for both boys. At weeks 17 and 18, fading procedures were implemented by gradually decreasing the daily monitoring, exercises, and reward system. These findings are consistent with other studies demonstrating that providing tangible rewards plus fading as a treatment for nocturnal enuresis has a higher success rate (85%) and lower relapse rate (37%) than both dry bed training and the urine alarm.

In 1982, J. Bollard and T. Nettlebeck implemented a component analysis of dry bed training, a comprehensive treatment for enuresis consisting of the urine alarm, RCT, waking schedule, and positive practice/cleanliness training. This study included 177 enuretic individuals between the ages of 5 and 17. Each individual was randomly assigned to one of the eight groups. Group 1 was considered the standard condition, which entailed the use of the urine alarm during sleep. Group 2 involved

the use of a waking the schedule in addition to the urine alarm. The waking schedule consisted of waking the individual every hour to void during the first night and one time 3 hours after falling asleep during the second night. Then after each dry night, waking would occur one-half hour earlier than the previous night, until the waking time was equal to 1 hour after sleep onset. Group 3 entailed the use of the urine alarm in addition to RCT. Here, RCT included the third variation of RCT at night that was discussed earlier (i.e., fluid loading before bed, hourly waking, prompting urine retention). The fourth group included the use of positive practice, cleanliness training, and the urine alarm. Positive practice entailed the child lying in bed with the lights off and counting to 50. When the child reached the set number, he or she was to go to the toilet and try to void. This process was repeated 50 times before falling asleep. Immediately following an enuretic accident, the child was reprimanded and sent to the toilet. The child then implemented cleanliness training, which involved changing one's nightclothes, removing and replacing the soiled bed linens, and drying and repositioning the detector pad of the urine alarm. Prior to returning to bed the child again had to carry out the positive practice exercises 20 times. There were also four additional groups that were composed of combinations of the first four groups. Group 5 included waking and RCT. Group 6 entailed waking, positive practice, and cleanliness training. Group 7 included RCT, positive practice, and cleanliness training. Finally, Group 8 was composed of the full dry bed training package. Bollard and Nettlebeck found that groups 6 and 8 had significantly fewer wet nights than each of the other groups. Further, they found no significant differences between the other groups. However, they did report that each of the four groups that included the waking schedule responded faster to the treatment than those without the waking schedule. In the RCT group specifically, 11 of the 12 participants met the criterion for becoming dry with an average of 24 wet nights during the 20-week treatment period.

As noted, studies have evaluated the combined effectiveness of RCT and other intervention methods as a means to stop enuresis. In 1986, Gary Geffken, Suzanne Bennett Johnson, and Dixon Walker compared the effects of the urine alarm alone against the urine alarm plus RCT with 50 5- to 13-year-old enuretic children. Baseline measures of wetting frequency were collected over a 2-week period of time; in addition, classification of either a small or large maximum functional bladder capacity was determined prior to randomly assigning participants to each of the

groups. All participants were instructed to use the urine alarm. Half were also instructed to implement RCT based on Paschalis, Kimmel, and Kimmel's 1972 model of RCT. In this study, children in the RCT plus urine alarm group were instructed to hold their urine for progressively longer periods of time until they reached 45 minutes beyond the initial urge. Over the course of treatment, 10 participants dropped out. Of the 40 remaining participants, 92.5% ($n = 37$) achieved 14 consecutive dry nights, although 41% ($n = 16$) of the children relapsed. The fewest bedwetting accidents occurred in children with a large functional bladder capacity who were in the urine alarm only group and with the children who had a small functional bladder capacity and were in the urine alarm plus RCT group, suggesting a relationship between functional bladder capacity and method of treatment. This decrease in bedwetting may have also been a result of the increase in nighttime arising to use the toilet. This suggests that RCT was able to increase the sensitization to a full bladder but not actually increase functional bladder capacity as has been suggested throughout the literature.

Research on the effectiveness of RCT and other behavioral methods, such as dry bed training and the urine alarm, continue to provide information regarding the effective treatment of nocturnal enuresis. Further, treatment of nocturnal enuresis tends to produce a high dropout rate due to the demands placed on the parents to implement and follow through with the treatment. As discussed, different variations and combinations of RCT and other methods will result in different outcomes. It is important to choose a method that best suits the therapist and the family being treated.

IV. SUMMARY

RCT is an intervention model used to decrease the presence of nocturnal enuresis. Enuresis is the voluntary or involuntary voiding of urine in clothes or in bed after the age of 5. RCT encourages the holding of urine

for extended periods of time after the first urge to urinate is detected. This functions as means of increasing the functional bladder capacity of an individual. Variations of RCT may also include fluid loading and reward systems as methods of reinforcement for increased fluid consumption, delayed urination, or both. On average, RCT is effective with 50 to 75% of individuals in reducing nocturnal enuresis, and with 30 to 50% of individuals in completely eliminating bedwetting. Based on the varying methods of implementation and the results of previous studies, specific intervention programs for treating enuresis should be tailored to the specific family and individual being treated.

See Also the Following Articles

Bell-and-Pad Conditioning ■ Child and Adolescent Psychotherapy ■ Modeling ■ Nocturnal Enuresis: Treatment ■ Primary-Care Behavioral Pediatrics

Further Reading

- American Psychiatric Association. (2000). *Diagnostic and Statistical Manual, 4th Edition, Text Revision*. Washington, DC: author.
- Friman, P. C., & Jones, K. M. (1998). Elimination disorders in children. In T. S. Watson & F. M. Gresham (Eds.), *Handbook of child behavior therapy* (pp. 239–260). New York: Plenum.
- Friman, P. C., & Warzak, W. J. (1990). Nocturnal enuresis: A prevalent, persistent, yet curable parasomnia. *Pediatrician, 17*, 28–45.
- Geffken, G., Bennett Johnson, S., & Walker, D. (1986). Behavioral interventions for childhood nocturnal enuresis: The differential effect of bladder capacity on treatment progress and outcome. *Health Psychology, 1986*, 261–272.
- Lyman, R. D., Schierberl, J. P., & Roberts, M. C. (1988). Enuresis and encopresis: Psychological therapies. In J. L. Matson (Ed.), *Handbook of treatment approaches in childhood psychopathology* (pp. 397–428). New York: Plenum.
- Ronen, T., & Abraham, Y. (1996). Retention control training in the treatment of younger versus older children. *Nursing Research, 45*, 78–82.

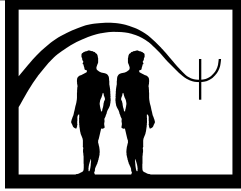

Role-Playing

Joanne L. Davis, Adrienne E. Fricker, Amy M. Combs-Lane, and Ron Acierno

Medical University of South Carolina

- I. Description
 - II. Theoretical Basis
 - III. Empirical Studies
 - IV. Summary
- Further Reading

GLOSSARY

confederate An individual who pretends to be a participant in a research study, but is actually part of the research study.

modeling A procedure in which a particular behavior or behaviors is/are demonstrated for an individual to allow that individual to emulate the behaviors.

operant conditioning A theory of behavioral modification that states that behaviors are controlled by contingencies that occur following the behavior.

role reversal The client acts “as if” they are another individual involved in a problematic situation.

Role-play is a procedure in which scenarios are designed to elicit particular behaviors from an individual. The individual is asked to respond “as if” the situation were actually occurring. The individual may respond to another person or to a situation presented by video- or audiotape. This article presents a review of the uses of role-play in therapy, guidelines for use, advantages and disadvantages of this techniques, and information regarding empirical studies of the technique.

I. DESCRIPTION

Role-playing, also known as behavioral rehearsal, has a number of uses in behavior therapy, in terms of both behavioral assessment and treatment. Whether used as part of an assessment or intervention, role-playing requires the client to act “as if” they are in a real-life situation involving a problematic behavior. Role-play may enable clinicians to directly observe deficits (e.g., unassertiveness) or excesses (e.g., aggression) in an individual’s behavioral repertoire. Role-play may also be used in treatment for a number of behavior-based problems including phobias, anxiety, social skills training, and interpersonal difficulties.

Role-play sessions can be audio- or videotaped in order for the behaviors to be rated by either the therapist, the client, or an objective judge. Frequently, behavior checklists are used to rate target behaviors the client is attempting to learn. Behaviors can be rated in terms of their effectiveness, frequency of occurrence, duration, or presence or absence. Clients can also provide ratings of self-perceived competence or level of arousal while performing the behaviors. Based on the ratings, a therapist provides feedback to the client. Feedback includes specific information regarding the individual’s performance and suggestions for improvement and additional practice.

A. Assessment

Often, it is not possible for a therapist to observe directly a problem behavior in the natural setting in

which it occurs. In these cases, it may be possible to recreate the situation in the therapists' office. Role-play frequently involves the therapist and client reenacting a problematic interpersonal situation. Outside models may also be used to better simulate the actual situation. For example, if the client is a male college student reporting difficulties asking women for dates, the therapist may want to recruit a young female assistant to assist in the role-play.

Role-play may also be beneficial if the client has a difficult time verbally expressing the nature of the problem. Enacting a similar situation with the client may provide the therapist with specific knowledge of the client's behavioral excesses and deficits that he or she is not able to verbalize. For instance, if the college student described above is not able to explain the nature of his difficulties interacting with women, conducting a role-play may clarify the specific nature of the problem.

B. Intervention

Role-play is often conducted within the therapy session to assist clients in learning and practicing new skills, decrease and extinguish undesirable behaviors, and increase and reinforce desirable behaviors. Through role-play exercises, the therapist is able to observe the client's behaviors directly and provide feedback regarding strengths and limitations, and to reinforce the target behavior. For example, a therapist engaging in social skills training may describe the procedure to the client, provide a rationale for its use, establish several scenarios that approximate the problematic situations, model the appropriate behavior with a confederate, then ask the client to respond to a confederate (live, audio, or video) "as if" the situation is occurring. Feedback is then provided to the client on her or his performance. Role-play is also frequently used to assist parents in teaching new skills or modifying behavior of a child. Role-play may be first conducted in session with parents. The parents are then instructed to engage in role-play practices at home with their child. For example, role-play may be appropriate for teaching an aggressive child socially appropriate means of interacting with other children.

Role-play is also useful for helping a client attend to internal processes of which they are unaware. For instance, while enacting a scene in which the client is practicing assertive behavior, the therapist may call attention to thoughts, feelings, and stimuli to which the client typically does not attend. Once the client has identified the internal processes, role-play can be used

to learn new ways of responding to the situation. For example, clients with social anxiety may not be aware of automatic, distorted cognitions (e.g., "Everyone in the audience thinks I'm stupid") that may be increasing their levels of anxiety.

Role-play is frequently used to introduce the concept of generalization of therapeutic techniques to other contexts. For example, if a client has been working on increasing his assertive behavior with his wife around money issues, the therapist may ask him to role-play confrontation with a friend or a problem at work. Further, a therapist may ask the client to take on various roles to gain other's perspectives on a problematic situation. This type of role-play is termed role reversal and is useful in challenging and modifying automatic thoughts concerning how a client is perceived by others.

Other forms of behavioral rehearsal that may be used as an adjunct to role-play are instruction, physical guidance, modeling, and imagery rehearsal. The decision to incorporate other techniques will depend on the desired skill or the behavior to be changed, the nature of the situation, and the current level of client functioning. For example, if the goal is acquisition of a new skill or if the client's behavioral repertoire is lacking, modeling appropriate behaviors may be required prior to initiating role-playing. Effective intervention with complex new skills may require breaking the skill down into smaller components and role-playing each component, gradually piecing together the total skill. An individual with a severe snake phobia may need to practice imaginal exposure or watch others interact with snakes before he or she is able to role-play exposure to a toy snake.

C. Guidelines for Use

The effectiveness of role-play techniques may be increased with the following strategies:

1. Make the scenarios as realistic and as close to the actual problematic situation as possible.
2. Start role-play with simple situations and graduate to more complex situations and behaviors.
3. Use a variety of different scenarios to help generalize skills to different contexts.
4. Specific role-plays should target the most salient problem behaviors for each client.
5. Monitor a client's progress over time. It may be helpful to provide a graphic depiction of the client's progress. For example, if the frequency of occurrence of target behaviors is the rating focus, the

therapist can plot changes in this frequency within and across sessions.

5. If role-plays are to be conducted across time as part of an ongoing assessment, care should be taken to standardize instructions and scenarios to ensure that it is the client's behavior that is being assessed, not changes in the scene, environment, or other individual(s) in the scene.

D. Advantages and Disadvantages

As with any procedure, there are numerous advantages and disadvantages to the use of role-play in assessment and as a therapeutic intervention.

1. Advantages

Role-play allows for the direct observation of clients' verbal and nonverbal behaviors. It can be used to corroborate self-reports of problem behaviors. Role-play assessments of target behaviors are easily conducted in the research laboratory or the therapist's office and are inexpensive. It provides a rich record of client responses that are difficult to assess using paper and pencil measures or interviews. Role-play scenarios are typically brief, so many can be conducted within one session.

Role-play can have many advantages in therapy. Clients frequently experience difficulties completing homework assignments at home. Role-playing within session may help decrease fears about the assignment and increase compliance. Role-play allows clients to achieve small successes, which in turn increase motivation for change. Further, role-play can be used as a steppingstone for performing more complex skills or conducting *in vivo* practice of target behaviors.

2. Disadvantages

There are also several disadvantages to consider. Scenarios need to be standardized in order to provide an accurate assessment of behavior change. Inconsistencies in the behavior of a confederate or the format of stimuli used may impact the behavior of the client and may inaccurately suggest improvement and make comparisons difficult. Perhaps the most salient limitation is the questionable criterion validity of role-play. The participants' or clients' behavior in session or in a research setting may not be an accurate representation of their behavior in a natural situation. Also, the therapist is not able to sample all possible scenarios, thus there is a potentially erroneous assumption of cross-situational consistency. Finally, the accuracy of the simulations themselves may not be completely acceptable in all scenarios.

II. THEORETICAL BASIS

In this discussion, role-play is presented as a behavioral technique and its utilization is based on the behavioral principle of focusing assessment and treatment on observable behaviors. It is not meant to provide an understanding of the etiology of a behavior; rather, problematic behaviors are identified and modified through practice in simulated situations regardless of etiology.

The theory of operant conditioning holds that the probability of the occurrence of specific behaviors is determined by the contingent consequences of those behaviors. The frequency of a behavior can be increased through positive (i.e., adding a desired stimulus) or negative (i.e., removing an aversive stimulus) reinforcement and decreased through positive or negative punishment. In cases in which the target behavior does not occur or is not yet a part of the client's behavioral repertoire, modeling (i.e., observational learning) may be used to introduce the behavior. Depending on the complexity of the target behavior, shaping (i.e., reinforcing approximations of the target behavior) may be incorporated in the role-play.

Once the skill is learned and the behavior performed, the therapist uses positive reinforcement to increase the occurrence of the behavior and to encourage the client to engage in the behavior outside of the therapy session. It is hoped that the modified behavior will positively impact the contingencies, further reinforcing the client's desire to engage in the behavior.

III. EMPIRICAL STUDIES

Research evaluating the validity of the use of role-play in either an assessment or as part of a therapeutic intervention is somewhat limited and dated. One of the primary difficulties involved in conducting such research is the lack of standardization of role-play stimuli used across studies. For the most part, research demonstrates that ratings of subjects' behavior responding to simulated situations correlates highly with evaluations of those who knew respondents well. Role-play (alone or as part of a treatment protocol) has been found to be effective for emotional and behavioral disorders including depression, social skills training, anxiety, phobias, aggression, and interpersonal problem solving. Role-play also has some support for prevention efforts. In 2000, Arthur Perlini and Christine Ward investigated the effectiveness of HIV prevention interventions and found that role-play was associated with increased

knowledge about AIDS and HIV in comparison to video, lecture, or no intervention.

technique for a variety of difficulties including anxiety and interpersonal interactions.

IV. SUMMARY

Role-play techniques have been widely used in behavioral assessment, as part of therapeutic interventions, and as a means of evaluating therapeutic interventions. Empirical support for role-play is fair; however, there are a number of factors that limit one's ability to evaluate techniques across studies. There are numerous advantages (e.g., brief and inexpensive) and disadvantages (e.g., questionable criterion validity) to consider when deciding whether or not to use role-play. However, it appears to be an appropriate

See Also the Following Articles

Behavioral Assessment ■ Behavioral Therapy Instructions ■ Behavior Rehearsal ■ Corrective Emotional Experience ■ Heterosocial Skills Training ■ Self-Statement Modification ■ Modeling ■ Working Alliance

Further Reading

Bellack, A. S., Hersen, M., & Kazdin, A. E. (1985). *International handbook of behavior modification and therapy*. New York: Plenum Press.

Cormier, W. H., & Cormier, L. S. (1991). *Interviewing strategies for helpers* (3rd ed.). Pacific Grove, CA: Brooks/Cole Publishing Company.



Schizophrenia and Other Psychotic Disorders

Richard L. Munich

The Menninger Clinic

- I. Introduction
 - II. History
 - III. Contemporary Approaches
 - IV. Linking Psychotherapy with Phase of Illness
 - V. Cognitive Strategies
 - VI. Related Modalities
- Further Reading

GLOSSARY

psychosis A mental state characterized by loss of reality testing as in delusions and hallucinations, often accompanied with severe interferences with the capacity to meet the ordinary demands of life, maintaining social and personal boundaries, manage profound levels of anxiety, focus attention, and experience pleasure.

schizophrenia A disorder of cognition and behavior that lasts for at least 6 months and includes two or more of the following: delusions, hallucinations, disorganized speech (positive symptoms), grossly disorganized or catatonic behavior (disorganized symptoms), emotional flattening, poverty of thought, and speech and severe impairments in motivation (negative symptoms).

I. INTRODUCTION

Contemporary treatment of patients with schizophrenia is an amalgam of its biopsychosocial determinants, heterogeneous presentation, and phasic course. It includes psychopharmacological, psychoeducational, and rehabilitative interventions, and a continuum of care

with a variety of ambulatory-based alternatives. Comprehensive treatment tailors these interventions to the phase of illness and is reinforced with a variety of flexible and supportive psychotherapies that emphasize medication compliance, problem-solving tasks, community reintegration and tenure, and in its most stable phase, conflict resolution and personal growth. This article describes the evolution and implementation of these psychotherapies as well as their interface with the various above-mentioned interventions.

II. HISTORY

Although Sigmund Freud was skeptical about the use of psychoanalytical therapy for patients with schizophrenia, many practitioners from early in the 20th century applied his methods for these patients. Because of their withdrawal from the external world and essential narcissism (e.g., autism), Freud felt that patients with psychotic disorders were unable to form a meaningful, stable, and workable transference, the basis of psychoanalytic treatment. This inability made it difficult to work through unconscious conflicts and their accompanying defenses as they appeared in relation to the therapist. Other psychoanalytic pioneers and followers of Freud, such as Paul Federn, Karl Abraham, and Carl Jung, felt otherwise and began a long tradition of utilizing insight-based techniques that developed side by side with psychodynamically oriented psychotherapy generally. To the earliest list was added the

work of Victor Tausk, A. A. Brill, Wilhelm Reich, Gregory Zilboorg, Sandor Ferenczi, and Ernst Simmel. Simmel and Georg Groddeck introduced the psychodynamic approach into the mental hospital. It is noteworthy that all these early practitioners recommended modifications of the traditional analytic technique to be more directive, less focused on the transference, and employing more techniques than interpretation alone.

Use of these modified approaches reached its peak in the United States in the post-World War II decades of the 1940s and 1950s. Represented in the work of Harry Stack Sullivan, Frieda Fromm-Reichman, and Harold Searles, practitioners of the interpersonal school of psychiatry worked with patients as if schizophrenia were fundamentally a disorder of interpersonal relatedness. Along with British object relations theorists and practitioners such as Melanie Klein, Wilfred Bion, and Herbert Rosenfeld, these therapists believed that the illness was caused and could ultimately be cured, or at least significantly ameliorated, by interpersonal, psychotherapeutic, and interpretive techniques. Although much of the focus of treatment remained with an elucidation of the meaning of various symptoms and their relationship to the patient's past and current stressors, modifications in classical technique continued with patients being seen face to face, often less than daily, and with much more interaction between patient and therapist.

In the decades of the 1960s and 1970s clinicians like Lewis Hill, Milton Wexler, and Victor Rosen continued the psychodynamically oriented approach to patients with the idea that psychosis was just like neurosis only more so. Others, like Ruth and Ted Lidz, Steven Fleck, and Lyman Wynne, supported somewhat by the previous work of Searles, believed that schizophrenic pathology made it difficult to attain adequate separation from important figures in the patient's life. As opposed to the primacy of intrapsychic conflict, this more developmental or family point of view focused on the etiological role of dysfunctional events and faulty communication patterns within families. At the same time, this approach led to a more reality-based, adaptive thrust with straightforward language and problem-solving techniques. Unfortunately for those espousing this approach, the dysfunctional impact on families of living with a family member with schizophrenia was not adequately considered.

After reaching a peak in the two decades between 1950 and 1970, the clinical use of, reimbursement for, and educational input toward the psychodynamically informed psychotherapy for patients with schizophrenic, schizoaffective and psychotic depression steadily declined in the United States. The causes for

this decline are well known and reflect a myriad of documented social, scientific, and economic realities. The development of the earliest antipsychotic medications dramatically reduced some of the most dramatic symptoms of psychosis. Research efforts were unable to confirm the effectiveness of psychotherapy, whereas others demonstrated a lack of its effectiveness. Questions about patient selection invalidated many of the remarkable and compelling anecdotal case reports of successful treatment. In addition, there was a dramatic proliferation of nonpsychological forms of treatment, and trends in the overall practice of psychotherapy itself shifted in ideology from psychodynamic to interpersonal to cognitive-behavioral modalities of therapy.

III. CONTEMPORARY APPROACHES

This nearly 30-year decline in the practice of dynamically informed psychotherapy for patients with psychotic disorders appears to be slowing down and even leveling off. There are several factors that account for this shift, not the least of which, paradoxically, is the revolution in and explosive growth of neuroscience over the last two decades. This growth directly affected psychotherapeutic work in two ways. First, there has been a clear-cut, experimentally verified recognition of the dynamic interplay between heredity and environment, between hard wiring and experience and between protein synthesis at the receptor site and input from the perceptual apparatus. Thus, a modern conception of severe mental disturbance suggests that the structure of a psychosis derives from the patient's genetic predisposition, prenatal environment, constitution and brain; whereas its content (the expression and experience of illness) issues from the patient's developmental environment, meaning system and mind. Because the interaction of psychosocial stressors and brain vulnerability leads to dysfunctional adaptation, optimal treatment addresses both sides of the interaction.

The second and more practical effect of the remarkable advances in *neuroscience* is the ability to design pharmacological agents to enhance effectiveness with the positive and disorganizing aspects of the illness and diminish some of those agents' most irritating side effects. Far from being perfect, the new so-called atypical antipsychotics also show promise for mitigating negative symptoms without the troubling extrapyramidal side effects of earlier neuroleptics. Much like the application of a brace to the paralyzed limb of a stroke victim, the antipsychotics appear to protect the

receptor site on an affected neuron against continued overstimulation. Neither intervention cures the fundamental pathological condition, but in both cases their removal activates the symptoms: in the first case, hemiplegia; and in the second, decompensation and the exacerbation of psychotic symptoms.

The ability to manage positive, negative, and disorganized symptoms, the most debilitating aspects of schizophrenic illness, have made the patient more available for psychotherapy and brought the following crucial treatment issues into bolder relief: personality and character, treatment compliance and therapeutic alliance, and long-standing cognitive, social, and vocational deficits. With respect to personality and character, it was within the past decade that many believed that a diagnosis within Axis I of schizophrenia or schizoaffective illness precluded the personality or character diagnoses of Axis II. This was because regression to psychotic levels was presumed to have a fundamental and disorganizing effect on identity, personality, and coherence of the self-concept. Most people who work closely with these patients, however, believe the personality remains essentially intact and, depending on its configuration, can have both facilitating and inhibiting influences on the treatment, the treatment alliance, and the course of illness. The emergence of personhood in the previously withdrawn and disorganized patient makes the patient available to discuss the substantial problems of living that result from debilitating illness and form the centerpiece of an effective psychotherapeutic process. Other issues that may come to the foreground as a result of effective medication include depression, negative symptoms, and a profound demoralization and despair about the afflicted individual's deviance from the mainstream of friendship and social life.

The reduction of disorganizing symptoms also makes it possible to look more closely at the treatment alliance and some of its resistances, and secondarily, of course, the whole question of treatment compliance. Treatment alliance is critical for the success of any of the therapies proposed in this section and takes us immediately into the realm of object relations and interpersonal theories. Unlike Freud's conceptualization of the narcissistic neurosis, it is now more commonly believed the problem with the transference in these patients is not that there is not enough for a treatment alliance; rather, the issue appears over and over to be a very intense and highly unstable alliance and difficult to manage transference reaction. As mentioned there is by this time an enormous anecdotal literature on this subject, most of which precedes the modern pharmacological era. Clinicians

continue to report on this kind of work with patients. In these highly evocative accounts, the vicissitudes of attachment and separation and transference and countertransference suggest much that can be reexplored and investigated with today's patient in an entirely new context and without the same level of anxiety about losing or doing damage to a patient. Psychodynamically oriented psychotherapy, however, with its emphasis on the regressive transference neurosis, may well be overstimulating for many of these patients especially in the early and more volatile phases of the illness. Thus, keeping in mind issues of separation and attachment while helping the patient reintegrate and cope—without focusing on them—becomes the task of the therapy.

Very often the psychotherapist of the patient with schizophrenia must perform auxiliary ego functions such as reality testing, assistance with impulse control, anticipation of consequences (judgment), and sharpening self-object differentiation. Therefore, the most widely practiced form of psychotherapy for patients with schizophrenia is supportive. The techniques include the establishment and maintenance of the therapeutic alliance, a steady focus on medication compliance and side effects, and paying attention to and helping reduce stress. These techniques are supported with clarification, education, and reassurance and are the heir to the psychodynamic tradition in which the relationship between therapist and patient is crucial and adaptive defenses are encouraged and reinforced. Finding the appropriate synthesis of the modifications from traditional psychotherapeutic technique, developing and maintaining a stable and durable therapeutic alliance, while keeping in touch with the dynamic unconscious, comprise the art of the therapeutic work with these patients. Furthermore, supportive psychotherapy is the basis of the majority of contemporary psychotherapies for the illness in virtually all its forms and phases. Figure 1 outlines the historical trends in the psychodynamically oriented psychotherapy of patients with schizophrenia.

Compliance with effective medication regimens is one of the most important issues in the ongoing treatment of patients with schizophrenia. The idea of learning in more detail about a patient's reluctance to continue a medication that is fostering the reintegration of his or her personality may be quite helpful. Is noncompliance the same or does it go beyond the same kind of denial of illness that one sees in any chronic illness, diabetes for example, in which issues of pride and autonomy play such a strong role in problems with compliance? Or is this denial significantly connected to the patient's low awareness of symptoms?

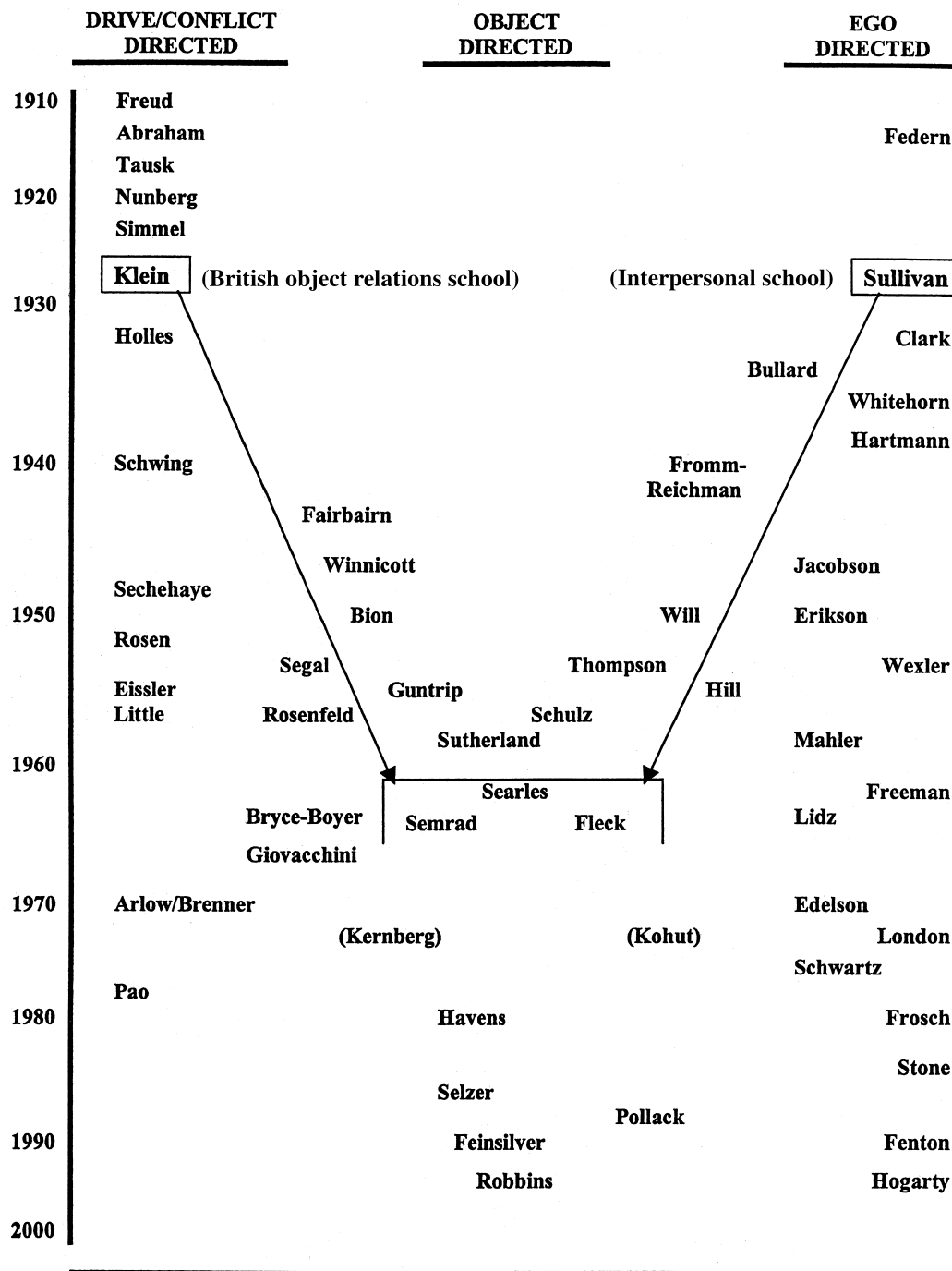

FIGURE 1 Major theoretical/clinical trends in psychotherapy of schizophrenia. Reproduced with permission from Spiegel (ed.). (1999). *Efficacy and Cost-Effectiveness of Psychotherapy*. Washington, DC: American Psychiatric Press.

Or is the reluctance to continue medication more like the patient with a bipolar disorder who stops their lithium or valproic acid because they miss the intense high associated with a manic state? Or is it a flight

from inner deadness, a manipulative effort to obtain more from the treatment team, or a retreat from the despair associated with the many demands of external reality in the absence of requisite adaptive skills? Or

finally, is it yet another manifestation of basic faults in internalized object relations alluded to when speaking of issues of attachment and separation earlier?

When a patient is not threatened so immediately and unpredictably by disorganizing symptoms, the psychotherapist is in a much better position to understand the dysfunctional interaction of these relevant and dynamic issues. It is noteworthy, however, that these issues may be sidestepped in many contemporary educative and rehabilitative approaches that take the position that non-compliance has more to do with a poor understanding of the illness, its symptoms, and the role of medications.

One of the most painful but important issues to emerge as a result of more effective psychotropic medication is the clear-cut cognitive, social, and vocational deficits that inhibit the functional adaptation of many of the patients with serious and persistent mental illness. In an increasingly technological age it may be preferable, in fact, to be considered mentally ill than it is to be labeled a "drop-out." There are many patients who have emerged from several years of psychosis and withdrawal only to discover they are way behind their peers in the capacity to solve the problems of everyday life, to feel socially attuned, to enter the workforce, or otherwise construct a meaningful life. These represent another kind of deficit, a deficit that results from being more or less "out of it" and which adds a new dimension to the illness itself. Various forms of psychotherapy are especially helpful with the problems in living that are functional and emotional sequelae of severe mental illness.

IV. LINKING PSYCHOTHERAPY WITH PHASE OF ILLNESS

Growing from the work of John Strauss and his colleagues at Yale utilizing longitudinal patterns and an interactive-developmental model, Wayne Fenton and his colleagues at the Chestnut Lodge Hospital formulated a set of phases through which symptoms develop, progress and retreat. The phases include

1. A prodromal period signaled by a constellation of symptoms including sleep difficulty, perceptual abnormalities, and social isolation.
2. An acute or active phase with the characteristic signs of decompensation.
3. A subacute or convalescent phase characterized by a reduction in florid symptoms, some reorganization of function, especially reality testing, and postpsychotic depression.

4. Moratoriums or adaptive plateaus during which, somewhat like the latency period of psychosexual development, there is a consolidation of gains, a gradual restitution of personal identity and a strengthening of confidence and adaptive skills.

5. Change points, called "mountain climbing" by Strauss during which there may be upward shifts in functioning (moving from halfway house to community; beginning a job, etc) either self-motivated or initiated by others but that carry potential for improvement or relapse.

6. Stable plateaus which can be more or less enduring and range from remission to fixed deficits or persistent symptoms.

Instead of a monolithic therapeutic approach to patients with psychotic disorders, the contemporary clinician flexibly modifies his or her interventions and contact according to the phase of illness. In this approach, that sensitive clinicians have long understood, therapeutic contact may range from quite time limited, reality based, problem solving, and ego supportive along one end of the continuum to more exploratory, nondirective, interpretive, and insight oriented along the other end. More specifically, during the acute phase, at onset of the psychosis, exacerbation or relapse of illness, the focus is on acute symptom stabilization, and the therapist is encouraged to be supportive and directive. Because patients in the acute phase are often out of touch with reality and highly sensitive to social stimulation, group therapy is contraindicated at this time.

In the subacute and convalescent phase, the supportive and directive approach is continued with the additional task of assessing stressors and vulnerabilities, mobilizing social supports and constructing the treatment team. The subacute and convalescent phase corresponds in timing and intervention to the basic phase of so-called personal therapy outlined by Hogarty and his colleagues at Pittsburgh. If group modalities are used during this phase, they should also be supportive and interactive as opposed to uncovering and insight oriented. Group therapy can be helpful in this phase if the patient does not have prominent paranoid or negative symptoms, and it can be helpful with discharge planning and return to the community.

In the first moratorium or adaptive plateau, the therapist can begin focusing on the treatment alliance and helping the patient with problem solving. In this phase interventions are tempered with considerable reassurance, supporting defenses and strengths. This approach is consistent with the idea that this is a phase

in which the patient is consolidating gains and restoring self-esteem. It is at this point that Hogarty's personal therapy would also introduce a step-by-step plan for the resumption of expected roles as well as the provision of social and avoidance techniques from social skills training. Group therapy during this phase is dependent on the patient's baseline level of functioning: for patients who can converse normally and function well between episodes, an interactive, non-insight-oriented approach is recommended; for those with chronic conditions and relatively good premorbid functioning, behaviorally oriented approaches should be used (see later).

When the patient moves to the next phase, begins to contemplate or becomes involved in changing status or venue, the therapy, now based on a reasonably solid treatment alliance, might begin to identify individual-specific prodromal and relapse factors because this is a very vulnerable time. This is also a phase when denial of illness may become prominent, so the therapist must pay attention to the patient's level of acceptance of illness. This phase roughly corresponds to Hogarty's intermediate phase. At this point his team provides internal coping strategies that include the identification of individual, cognitive and somatic indicators of distress, and the appropriate application of basic relaxation and cognitive reframing techniques.

After stable plateaus have been achieved and community reintegration and tenure sustained, the regular and by this point more traditional admixture of supportive and expressive psychotherapy can be employed. Here, interpretations continue to be quite modest, signs of regression are monitored very closely, and it is the patient who sets the pace of discovery. The later phases of recovery from the illness are usually those in which rehabilitative modalities are employed, inevitably highlighting the patient's premorbid difficulties, stressful familial patterns, and vulnerability to the social and technological demands of modern culture. This phase corresponds to Hogarty's advanced phase of personal therapy and includes encouragement for social and vocational initiatives in the community, progressive awareness of one's affect, together with its expression and perceived effect on the behavior of others. This latter phase also includes principles of criticism management and conflict resolution. Although it is a relatively recent addition to technique, personal therapy has modest research support.

Higher functioning patients may utilize an interactive group psychotherapy on an outpatient basis to learn more about their illness, to understand and uti-

lize their medications more effectively, apply reality testing as positive symptoms threaten to emerge, and learn communication and problem-solving skills. Ambulatory patients with more severe disorders are best served with approaches derived from cognitive and problem-solving techniques, as well as skill training derived from more recent psychiatric rehabilitation methods. Many recommend co-therapists in groups for patients with schizophrenia, somewhat more personal disclosure as compared to that in groups for patients with character disorders, and a steady focus on the techniques of clarification, support, and the here and now of interpersonal interactions. There is virtually universal agreement that interpretive activity aimed at uncovering unconscious conflict is contraindicated in group work with this population.

In the resurgence of psychotherapy for patients with serious disorders, the psychodynamics are far more part of the understanding than they are of the technique. The psychotherapy is much more a part of the treatment than the principal element in or the guide of the treatment. The psychotherapy is more flexible, adjusting to the phase of illness and primarily supportive, focal and educative rather than explorative, general and insight oriented. It is more about coping, adapting, problem solving, and coming to terms with deficits rather than collaborating in a regressive enterprise to uncover and resolve conflict. Emerging from the ego psychological point of view, this version of supportive psychotherapy is more reality based and adaptive and closer to a developmental and educative rather than an interpersonal and interpretive focus. It might even be called rehabilitative psychotherapy. This point of view is closest to that held by Lidz and others, and it contrasts with a more interpersonal and interpretive point of view outlined by Harry Stack Sullivan and held by Otto Will, Elvin Semrad, and Michael Robbins (see Table 1).

V. COGNITIVE STRATEGIES

The last two decades have seen a rapid increase in an interest in schizophrenia from a neurocognitive perspective, beginning with a focus on attentional dysfunction and moving to the more recent focus on working memory and its various components. This interest has naturally led to innovative treatment approaches. Cognitive-behavioral therapies (CBT) for patients with schizophrenia and other psychoses represents a radical departure from traditional, and even from the flexible

TABLE 1
Listening to the Patient with a Psychotic Disorder: Interpersonal and Developmental Psychodynamic Views

<i>Issue</i>	<i>Interpersonal</i>	<i>Developmental</i>
Advocacy	Sullivan, Will, Semrad, Selzer, Robbins	Lidz, Fleck, Wynne, MacFarland, Leff
Etiology	Interpersonal Primary versus secondary incapacity to cathect an object	Interfamilial Actual Dysfunctional events Faulty communication patterns
Symptom	Failure to connect with objects	Failure to separate from objects
Best theory	Closer to object relations	Closer to self-psychology
Treatment goal	Address deficits interfering with therapeutic alliance (self-other differentiation, faulty reality testing, observing ego).	Address pathogenic family transactions interfering with continuing development (marital schism, marital skew, double binds)
Individual psychotherapy	Conflict resolution Transference-countertransference Relate associations, restitutional phenomena to alliance	Problem solving Real, tangible life problems Discourage free association and exploration of restitutional phenomena
Milieu organized to:	Support psychotherapy; more confrontation	Support adaptive skills; less confrontation
Similarities	Both approaches look for and reinforce health functioning, tolerate regression, and minimize the use of somatic modalities.	

Reproduced with permission from Spiegel (ed.). (1999). *Efficacy and Cost-Effectiveness of Psychotherapy*. Washington, DC: American Psychiatric Press.

and personal psychotherapies of the last decade. CBT shifts the focus of intervention from the internal, dynamic, and supportive expressive to the external, symptom centered, and highly structured. Rather than a model of the mind based on psychoanalytic thought and various theories about the etiology of severe psychopathology, CBT addresses distortions in the cognitive sets or schemata that individuals develop to organize and understand their experience. These distortions may effect social-cognitive, perceptual, and inferential processes and lead to such diverse phenomena as hallucinations or delusional beliefs. Thus, rather than confronting or interpreting a delusion, the form and content of that false percept or belief, CBT's approach establishes a therapeutic alliance that increases the awareness and inconsistency of the belief. The goal is the replacement of the dysfunctional and maladaptive belief with one that is more evidence and reality based.

CBT for patients with schizophrenia and psychotic symptoms are based on the cognitive therapy developed in the 1960s and 1970s by Albert Ellis and Aaron Beck for patients with depression and anxiety. The emphasis placed on a nonthreatening and supportive therapeutic alliance, the effort to find aspects of the patient that are normal to help solve problems and a focus on adaptation and current problems harkens back to the

developmental perspective on individual psychotherapy and have much in common with other contemporary psychotherapeutic treatments. The collaborative and accepting mode of the treatment focuses on the symptoms and problems that the patient wishes to address. A rational and common-sense approach is taken to the patient's attitudes, underlying assumptions, symptoms, and problems of daily living.

The major CBT approaches to these disorders include belief modification, focusing/retribution, normalizing, cognitive therapy following acute psychosis, cognitive therapy for early psychosis, coping strategy enhancement and combinations of these. In belief modification, the patient is urged to view a delusion as only one possible alternative explanation of events. Without telling the patient that the belief is wrong, evidence for the belief may be challenged while inconsistencies are pointed out. Nonconfrontational verbal challenge and empirical testing help modify the degree of conviction patients may hold toward their beliefs.

Focusing/retribution is the intervention most suited for patients with auditory hallucinations. Over a series of sessions the patient is asked to focus on specific aspects of the hallucinatory experience, from the characteristics of the voices, their content, and the patient's

beliefs and thoughts about the voices. Following sessions, patients are given “homework” assignments to record these matters that are then used to discuss the timing and context of the hallucinations. The ultimate goal of this technique is to change the attribution of the voice from external to the patient to the patients themselves. Similarly, in the normalizing technique, the therapist attempts to help the patient describe the situation and stressors immediately preceding the onset of symptoms, as well as elucidate the cognitive distortions at the time of the onset. Normalizing also utilizes relaxation and anxiety management techniques, as well as the diary and notebook assignments as in the homework sessions described earlier. Much like the interpersonal school of psychoanalysis, every effort is made to emphasize the continuity of psychotic and normal experience and to reduce stigma and distress.

CBT interventions in acute psychosis and early psychosis combines many of the elements listed earlier but also include small group work in which patients are exposed to the irrationalities and inconsistencies of other group members, thus reducing some of the pressure on the individual patient. Efforts are also made to help patients integrate the experience, much like in the normalization technique, and families are encouraged to cooperate in helping reduce stress. These techniques also include illness education and focus on issues of motivation and stigma. Many of these techniques mirror the early phase of illness work in flexible and personal psychotherapies described earlier.

Coping strategy enhancement involves the reinforcement of those techniques already employed by patients to compensate for their illness. This method helps patients identify those environmental stressors that trigger dysfunctional cognitive, behavioral, and physiological reactions leading to psychotic symptoms. The process includes the careful and systematic identification and following of symptoms and their contexts, enhancement and development of ongoing strategies in response to the symptoms, and practicing new strategies in the sessions, and with homework assignments between sessions. Patients are taught to prioritize symptoms, whether or not to increase or decrease their activity, sensory input or social involvement in response to each symptom.

Because cognitive therapies have clear protocols, it is easier to design studies of effectiveness than with more dynamically oriented treatments. Since 1990 there have been well over a dozen variably controlled studies of the types of CBT mentioned earlier. The results are best for those patients with clear-cut symptoms and who acknowledge those symptoms as ones to be addressed.

Within that group the most effective results are with those patients with delusional symptoms. Investigators in the field are calling for better controlled studies with better and more random patient selection with respect to severity and concurrent treatments.

VI. RELATED MODALITIES

The final developments that have modified the practice of psychotherapy for patients with psychotic disorders is the increased sophistication in other modalities of treatment beyond psychotherapy and psychopharmacology. These techniques include psychoeducation, psychiatric rehabilitation, case management and assertive community treatment. These techniques serve to reduce stressors, facilitate adaptation, improve thinking, and mobilize resources in ways that reinforce self-esteem and enlarge the conflict-free zone, freeing the psychotherapist to more collaboratively share a focus with the patient in a more expansive and interrelated manner. These modalities address areas that were rarely meant to be dealt with in traditional psychotherapies.

Psychoeducational approaches do not dwell on the past and do not employ confrontative nor particularly interpretive techniques; rather, they make an effort to increase the family's knowledge of the illness and facilitate a rapprochement between parent and afflicted child, thus decreasing the pressure on both. Gone are the efforts to separate patients and their families. By reducing the stressors associated with dysfunctional interactions, experimental evidence has indicated a reduction in relapse rates. Then, like the early advertisements about medication, the patient becomes more amenable to and more continually available for the previously described, phase-appropriate psychotherapeutic interventions.

It is clear that medication, dynamic, personal, psychoeducational, and cognitive-behavioral therapies do not solve all the problems confronting the patient with a psychotic disorder. This is the case because most problems in living, especially for someone recovering from psychosis, have many interrelated components. With respect to the matter of social adjustment, for example, it is worth noting just how much might be involved from the different neuropsychological spheres encompassing sending, receiving, and processing. Starting at the foundation, social adjustment requires molecular skills such as eye contact and what to say in an introductory conversation—sending information. Acquiring these skills requires a sufficient level of motivation. Another critical element at the foundation for social

adjustment is the ability to perceive social cues, such as knowing when one might be welcome versus when one might be interrupting—receiving information. Acquiring social perception requires the capacity for self-object differentiation as well as the ability to recognize affects in the other. The final element in the foundation is problem solving. As mentioned, problem solving depends on intact cognitive processes, especially as has been more recently demonstrated, memory and visual-spatial mechanisms—processing information. Thus, effective treatment for social adjustment—a crucial factor in community reintegration and tenure—could involve cognitive remediation, social skills training, and psychotherapy—three separate treatment modalities, before coalescing into the molar skills necessary for social competence. And even then, these instrumental skills must be integrated with attachment needs. Insofar as some patients have the instrumental skills premorbidly, then a dynamically oriented psychotherapy that is helpful around issues of affiliation and attachment may be all that is needed. It is unusual, however, that this kind of intervention is sufficient for the modal patient with a psychotic disorder. Personal therapy as practiced by Hogarty and his colleagues appears to combine the elements most important for social adjustment. Their recently published study of 151 patients demonstrated a steady improvement in social adjustment for those patients living within a family. Their treatment had no effect on symptoms or anxiety and actually increased relapse rate in those patients living outside a family. Thus, like the recommendations of Fenton, they recommend that the later phases of their treatment await symptom and residential stability. Figure 2 outlines the many factors involved in social adjustment.

There is an important note to be made about the new modalities in the context of psychotherapy. Incompatible as they may seem on the surface, there are aspects of the contemporary treatment of schizophrenia and other psychotic disorders that are heir to the psychodynamic tradition in the continuing treatment of the seriously and persistently mentally ill. In determining a patient's specific rehabilitation goals, ideal environment and readiness for these interventions, the patient's interest and motivation, meaning system, symbolic, and value-laden world are critical. These emerge from the biopsychosocial model of illness and a thorough understanding of the patient and provide the energy for and shape of the treatment plan.

Expecting too much from or being too quickly discouraged with the lack of progress of a recovering patient can replicate exacerbating features such as high levels of tension or demoralization. Therefore, issues of

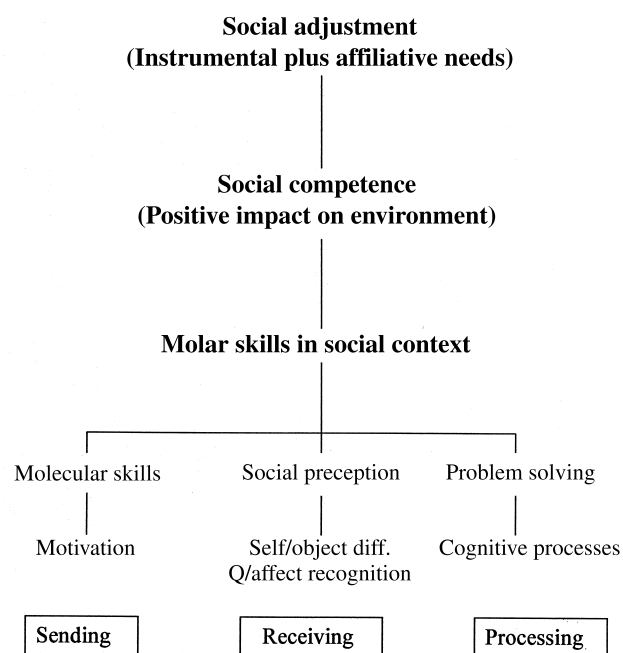

FIGURE 2 Elements of social adjustment.

psychological safety and trust are paramount, leading to difficulty coming to a shared reality and experiencing helpful intentions from a caregiver. A familiarity with the principles of psychodynamic psychiatry, with its emphasis on unconscious mental life, its principle of multiple determinants of actions, thoughts, and feelings, areas of sensitivity and vulnerability, and the presence of the past in the present—especially as represented in self- and object relations and transference phenomena, can only enhance the sensitivity and effectiveness of the treatment professional. Finally, the effectiveness of other treatments makes it possible for more appropriate technical neutrality than has often been the case in the psychotherapy for patients with a psychotic disorder. This is not meant in the sense, of course, of being a neutral object; rather, it means freeing the psychotherapist to shape the psychotherapy to fit the patient, whether it be from the point of view of therapeutic activity as previously mentioned, or whether it concerns itself with the patient's drives, ego operations, object relational, interpersonal, or self-system paradigms.

See Also the Following Articles

Attention Training Procedures ■ Cognitive Behavior Therapy
 ■ Object Relations Psychotherapy ■ Psychopharmacology:
 Combined Treatment ■ Sullivan's Interpersonal
 Psychotherapy ■ Vocational Rehabilitation

Further Reading

- Dickerson, F. B. (1999). Cognitive behavioral psychotherapy for schizophrenia: A review of recent empirical studies. *Schizophrenia Research* 2000, 43, (2–3): 71–90.
- Fenton, W. S. (2001). Individual psychotherapies in schizophrenia. In Gabbard, G. O. (ed.), *Treatment of psychiatric disorders* (2nd ed., pp. 47–66). Washington, DC: American Psychiatric Press.
- Fromm-Reichman, F. (1950). *Principles of intensive psychotherapy*. Chicago: University of Chicago Press.
- Gunderson, J. G., Frank, A. E., Katz, H. M., Vannicelli, M. L., Frosch, J. P., & Knapp, P. H. (1984). Effects of psychotherapy in schizophrenia. II: Comparative outcome of two forms of treatment. *Schizophrenia Bulletin*, 10, 564–598.
- Hogarty, G. E., Kornblith, S. J., Greenwald, D., DiBarry, A. L., Cooley, S., Ulrich, R. E., Carter, M., & Flesher, S. (1997). Three-year trials of personal therapy among schizophrenic patients living with or independent of family. I. Description of study and effects on relapse rates. *American Journal of Psychiatry*, 154(11), 1504–13.
- Kates, J., & Rockland, I. H. (1994). Supportive psychotherapy of the schizophrenic patients. *American Journal of Psychotherapy*, 48, 4543–4561.
- Munich, R. L. (1999). Contemporary practice of inpatient psychotherapy. In Spiegel, D. (Ed.), *Efficacy and cost-effectiveness of psychotherapy* (pp. 87–109). Washington, DC: American Psychiatric Press.
- Perris, C., & McGorry, P. D. (Eds.). (1998). *Cognitive psychotherapy of psychotic and personality disorders: Handbook of theory and practice*. New York: John Wiley & Sons.
- Stone, M. (1999). The history of the psychoanalytic treatment of schizophrenia. *Journal of the American Academy of Psychoanalysis*, 27(4), 583–601.
- Sullivan, H. S. (1962). *Schizophrenia as a human process*. New York: Norton.

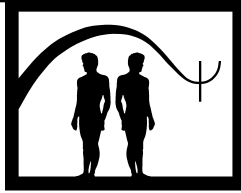

Self-Control Desensitization

E. Thomas Dowd

Kent State University

- I. Description of Treatment
- II. Theoretical Bases
- III. Empirical Studies
- IV. Summary
- Further Reading

GLOSSARY

- anticipatory anxiety** Anticipating one's future anxiety when thinking about an anxiety-producing situation.
- counterconditioning** The replacement of one conditioned response to a stimulus by another.
- hierarchy** An arrangement of anxiety-producing scenes, from low anxiety arousal to high anxiety arousal.
- in vivo desensitization** Desensitization based on exposure to real-life anxiety-producing situations, generally by the practice of coping strategies.
- proprioceptive responses** Internal physiological responses, such as muscle tension, that occur in response to anxiety-producing situations.
- reciprocal inhibition** The inhibition of a learned anxiety response by pairing a new adaptive response with the original anxiety-producing situation.
- self-control desensitization** Desensitization based on a coping skills mediational format involving sensitivity to proprioceptive cues and cognitive relabeling.
- systematic desensitization** Reducing the connection between an anxiety-producing stimulus and anxiety by pairing an anxiety-incompatible response with the original stimulus.

I. DESCRIPTION OF TREATMENT

Self-control desensitization is a variant of systematic desensitization that gives more control of the procedure to clients than does the latter, which is therapist run. It is also based on a somewhat different theoretical model. In self-control desensitization, clients are given a rationale that is essentially coping skills oriented in nature. They are told that they have learned, on the basis of past experience, to react to certain situations by becoming anxious, tense, or nervous. They are then told they will learn new coping strategies to replace these negative reactions with more adaptable ones. They are taught the relaxation skills and other coping methods, such as breathing control and attention to internal sensations, and are then instructed to use them in a hierarchy of anxiety-producing situations to relax away tensions and provide covert rehearsal for situations they may face. The anxiety-producing scenes in the hierarchy are constructed jointly by the therapist and the client, and the client is asked to imagine them for 10 to 15 sec if there is no anxiety response. If there is such a response, the client is asked to terminate the scene and concentrate only on relaxation, relaxing away any tension. It is important that the use of these coping strategies be practiced repeatedly for the new coping skills to become well learned. This is especially important for scenes that arouse considerable anxiety.

The construction of the hierarchy originally followed the guidelines described by Wolpe in which it

was considered necessary to construct separate hierarchies for each specific anxiety-producing situation. However, in accordance with a more mediational paradigm, clients were taught to cope with their internal proprioceptive responses rather than coping directly with the situations that caused the anxiety. Thus, early on the use of exact hierarchies was not considered to be as important in self-control desensitization. In fact, the therapist was urged to include items that reflected a series of different anxiety-producing situations.

In systematic desensitization, it was considered important that scenes in the hierarchy be terminated if anxiety was aroused. In self-control desensitization clients are encouraged to remain in the scene if anxiety increases and to cope with this anxiety by relaxation or other coping strategies. Clients are encouraged to practice these new skills in real-life (*in vivo*) situations. The *in vivo* practice of these coping strategies in actual anxiety-producing situations should lead to enhancement of these skills.

II. THEORETICAL BASES

Systematic desensitization, as originally developed by Joseph Wolpe, was theoretically based on reducing anxiety by causing a response antagonistic to this anxiety to occur in the presence of the anxiety-producing stimulus. Thus, if the presence of a snake (the anxiety-producing stimulus), which normally produces anxiety, was paired with relaxation (a response antagonistic to anxiety), then a reduction in anxiety should occur. Wolpe thought that in this fashion the bond between the fear-producing stimulus (the snake) and the anxiety response would be weakened or reciprocally inhibited. Wolpe thought that it was important that a hierarchy of fear-producing stimuli (ranging from looking at the snake to approaching the snake to touching the snake) be constructed so the individual was not overwhelmed by anxiety early in the process. The procedure was based on the counterconditioning model in which the original bond between stimulus and anxiety response was automatically reduced or eliminated by the introduction of an antagonistic response.

Self-control desensitization was originally developed by Marvin Goldfried in 1971 and was based on a somewhat different theoretical rationale. Rather than considering relaxation as “reciprocally inhibiting” the anxiety response, Goldfried proposed a mediational model that was a forerunner of cognitive-behavior therapy. This mediational model consists of two aspects: the active construction of the muscular relaxation response and a

cognitive relabeling of the entire sequence between the fear-producing stimulus and the fear response. Theoretically, the client learns a method of actively coping with the anxiety rather than an automatic weakening of a psychological bond taking place. The client also learns to identify proprioceptive cues that are associated with muscular tension and to relax them away, essentially coping with these proprioceptive anxiety responses rather than the actual situations that elicit the anxiety. With considerable repetition, the client also learns to react to anticipatory anxiety with anticipatory relaxation, and eventually this process can become automatic in nature. However, both self-control desensitization and systematic desensitization are based on an important assumption of the counterconditioning model that the relaxation response must be stronger than the anxiety response for counterconditioning to occur.

Both systematic desensitization and self-control desensitization originally postulated that the construction and use of a hierarchy of anxiety-producing stimuli was important because a too-rapid introduction of an anxiety-producing stimulus might overwhelm the new relaxation response. If that occurred, it was thought that anxiety would reduce the relaxation rather than the reverse. However, research by Goldfried and Goldfried indicated that the use of a hierarchy of target-relevant behavior was not necessary for effective self-control desensitization. More recent research conducted on systematic desensitization itself has shown that a hierarchy may not be as necessary as originally thought. Implosive therapy (or “flooding”), in fact, is based on the opposite rationale—that it is more effective to begin at the top of the hierarchy rather than the bottom so that rapid extinction might take place. Thus, the construction of a hierarchy has been deemed less important as the theoretical explanatory model shifted from a counterconditioning to a coping skills model. Likewise, in line with the mediational model, it was not considered as important to terminate the anxiety-producing scene if anxiety increased; rather the client should implement the model by coping with the anxiety itself and relaxing it away. Only if the client is unable to tolerate the anxiety should the scene be terminated. The coping skills model assumes that skills are enhanced by practice and success under somewhat adverse conditions.

III. EMPIRICAL STUDIES

The majority of the empirical research on self-control desensitization was conducted in the 1970s and early 1980s, with some doctoral dissertations

conducted in the late 1980s. Summary literature and case studies combining self-control desensitization with similar techniques, such as applied relaxation and Suinn's Anxiety Management Training, have appeared well into the 1990s. Especially noteworthy are the series of studies conducted by Jerry Deffenbacher and his colleagues on comparisons of self-control desensitization with Anxiety Management Training and self-control relaxation. Other studies have compared it to systematic desensitization, rational restructuring, and neurolinguistic programming. Its use has been investigated primarily with anxiety disorders but also with related problems such as phobias, vaginismus, and the management of psychotic patients and individuals with mental retardation.

The research has shown that, although self-control desensitization is effective when compared to control groups receiving no treatment, it is no more effective than a variety of alternative treatments. Furthermore, the use of a graduated targeted hierarchy does not appear to be necessary. What appears to be the mechanism of its effectiveness is the gradual installation of coping skills by practice, perhaps with the attendant nonspecific effects of hope, confidence, and optimism.

IV. SUMMARY

Self-control desensitization is a modification of systematic desensitization, as originally developed by Joseph Wolpe. It relies on an active, mediational, coping skills model of change rather than a passive counter-conditioning model. It utilizes coping skills such as relaxation as alternative responses to an anxiety response in the presence of anxiety-producing stimuli. A hierarchy of anxiety-producing situations is often used although research and clinical observation have shown

that it is not as necessary as was once thought. Rather than terminate the scene as soon as anxiety is felt, clients are encouraged to remain in the situation and relax away the anxiety. *In vivo* practice in actual anxiety-producing situations is encouraged. It is similar in many ways to other self-control anxiety reduction techniques such as applied relaxation and Anxiety Management Training. Research has shown that self-control desensitization is effective for a variety of anxiety disorders but is not more effective than other cognitive or behavioral techniques.

See Also the Following Articles

Coverant Control ■ Eye Movement Desensitization and Reprocessing ■ Self-Control Therapy ■ Self-Statement Modification ■ Systematic Desensitization ■ Vicarious Conditioning ■ Vicarious Extinction

Further Reading

- Barrios, B. A., & Shigetomi, C. C. (1979). Coping skills training for the management of anxiety: A critical review. *Behavior Therapy, 10*(49), 1-522.
- Borkovec, T. D., & Whisman, M. A. (1996). Psychosocial treatment for generalized anxiety disorder. In M. R. Mavissakalian & R. F. Prien (Eds.), *Long-term treatments of anxiety disorders* (pp. 171-199). Washington DC: American Psychiatric Press.
- Costello, E., & Borkovec, T. D. (1992). Generalized anxiety disorder. In A. Freeman & F. M. Dattilio (Eds.), *Comprehensive casebook of cognitive therapy* (pp. 53-60). New York: Plenum.
- Goldfried, M. R. (1971). Systematic desensitization as training in self-control. *Journal of Consulting and Clinical Psychology, 37*, 228-234.
- Goldfried, M. R., & Goldfried, A. P. (1977). Importance of hierarchy content in the self-control of anxiety. *Journal of Consulting and Clinical Psychology, 45*, 124-134.

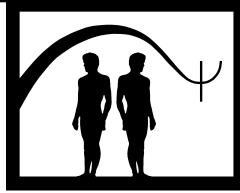

Self-Control Therapy

Lynn P. Rehm, Elisia V. Yanasak

University of Houston

- I. Description of Treatment
 - II. Theoretical Bases
 - III. Empirical Studies
 - IV. Summary
- Further Reading

GLOSSARY

self-management therapy A highly structured manualized, cognitive-behavioral therapy program for depression. Based on Frederick Kanfer's model of self-control, the treatment involves self-monitoring, self-evaluation, and self-control.

self-reward A strategy to increase probability of accomplishing difficult subgoal behaviors by setting up contingent rewards for their completion using a list of pleasurable activities for that purpose.

Self-control therapies involve teaching people skills and techniques for controlling their own behavior when striving to achieve long-term goals. It is usually assumed that people employ self-control implicitly in their efforts to change behavior, such as when starting a diet or exercise program. The self-control therapies attempt to teach these strategies in an explicit way. Many theories and therapies can be considered self-control theories. This article focuses on self-management therapy for depression developed by Lynn Rehm and his colleagues.

I. DESCRIPTION OF TREATMENT

Self-management therapy is a highly structured, manualized, cognitive-behavioral group therapy program for the treatment of depression. The program is currently presented in 14 weekly, one-and-a-half-hour sessions. Each session includes a didactic portion, a discussion period, in-session paper-and-pencil exercises, and weekly homework assignments that are reviewed at the beginning of the next session. It is an illustration of self-control therapies in that it is "transparent" to the participants. They are told that the depressive target of the intervention is identified, they are instructed in applying the intervention on their own, and they are told the theoretical rationale for the intervention. Participants are consciously applying psychological principles to change their own behavior.

Self-management therapy can be thought of in three ways. First, it is targeting specific components of depression and teaching the participants self-change techniques for modifying each target behavior. Second, it can be thought of as teaching principles of self-change in the context of depression. Third, it can be seen as teaching behaviors that are the opposite of depression, that is, positive self-esteem and self-control behaviors. People with positive self-esteem are people who accurately view their world, have a realistic sense of their abilities, set reasonable standards and goals, and are able to control their behavior with feedback to themselves.

The first session of the self-management therapy program serves to introduce the participants to one

another and to the program. The nature of depression is described and related to the symptoms presented by the participants. A brief overall description and rationale for the program is presented by the therapist. Homework for this first session involves keeping track of daily mood by rating average mood for each day on a scale of 0 to 10, where 0 is the worst most depressed day ever and 10 is the happiest day ever. The purpose of the assignment is to focus on daily variations in mood and to get participants used to the mood scale.

In the second session homework is reviewed with emphasis on participants' observations on their mood variability during the week and any correlates of their mood that they might have observed (e.g., felt better on days when they got out of the house). The didactic presentation in this session conveys a central idea in the program. The program is premised on the idea that mood is influenced by behavior and cognition, that is, activities that people engage in daily and the "self-statements" they make to themselves about what they do. Although the relationship may go both ways, the program is premised on the idea that depressed participants can change their daily mood and, thus, their depression by changing activities and self-statements. In various ways the rest of the program involves strategies for increasing positive activities and positive self-statements. The homework assignment is to continue monitoring mood and, in addition, to list positive activities and self-statements. This self-monitoring assignment is continued throughout the program with a variation in focus with each new topic.

In session three, the relationship between mood and events is demonstrated to participants by graphing their week's homework. For each day of the week the mood rating is graphed with a connected line. Then the total number of activities and self-statements for each day is graphed on the same form. Parallel lines illustrate the relationship between mood and activity. The homework assignment is to continue the self-monitoring logs daily.

The topic covered in the next session is the idea that any event has both positive and negative immediate and delayed consequences. When they are depressed, people tend to focus on immediate consequences. Activities can be positive either because they are immediately pleasurable or because they produce some delayed, or long-term positive outcome. Eating ice cream is immediately pleasurable whereas mowing the lawn may be a positive activity because the end product of a nice-looking lawn is pleasing. The homework assignment is to list each day at least one positive activity that is positive because it has a delayed positive effect. Each time such an activity is listed, a positive self-statement is to be listed noting the positive long-term effect.

Having covered the effects of activities, the next few sessions focus on their causes. Depressed persons are seen as making external, unstable, and specific attributions for positive events. "That was nice, but it wasn't my doing. It was just luck and may never happen again." Exercises in the session teach the participants to realistically take credit for positive activities. The exercise includes having participants take positive events from their self-monitoring logs and examine their causes. The homework assignment is to include in each day's self-monitoring log, one positive self-statement recognizing credit for taking responsibility for a positive activity.

In a parallel session, the idea is presented that depressed people tend to blame themselves for negative events. For a negative event, depressed persons tend to make internal, stable, and global attributions. In effect they are saying "It was my fault. I always fail in this way and I fail in everything else of this type." Again an exercise takes participants through a series of examples teaching them not to take excessive blame for negative effects, but instead, to see that some of the reasons for negative events are external, unstable, and specific. The homework assignment is to write a self-statement daily that diminishes blame from oneself for negative events.

Goal setting is the focus of the next sessions. Depressed persons tend to be disconnected from long-term goals, and they often set goals poorly. Drawing from the behavioral literature on goal setting, good goals should be positively stated, concretely defined, in the person's control, and attainable. Participants are asked to choose any goal of intermediate range that they can work on in the next few weeks. With a goal-setting form they are guided through an exercise to define their goal and to establish a list of component subgoals necessary to reach the main goal. The homework assignment is to include the accomplishment of subgoals on the daily self-monitoring log list of positive activities. The intent of the homework is for participants to acknowledge to themselves progress toward the distal goal.

Following the goal-setting topic, the idea of self-reward as a means of motivating oneself to pursue the goal is introduced. Essentially one can increase the probability of accomplishing difficult subgoal behaviors by setting up contingent rewards for their completion. Participants construct a list of pleasurable activities that they could use to reward themselves when they accomplish difficult subgoal behaviors. For example, when completing shopping for the materials necessary for a goal of completing some home repairs, the participant might self-reward with a stop at a favorite donut shop.

The homework here is to list the subgoal activities accomplished on the self-monitoring log and also to record contingent reward activities.

The final topics of the program deal with the way in which depressed people talk to themselves. Depressed persons typically talk to themselves in ways that are punishing and diminishing of motivation. For example, "Why should I try to do this? I'll never succeed. I always make a fool out of myself by failing at things like this." The idea presented is that talking to oneself in realistically more positive ways can increase rather than decrease motivation. Self-talk can be a self-administered reward or punishment. In one exercise, participants are asked to make a list of comfortable statements that acknowledge a positive accomplishment. As one person might say to a friend "You did a great job with that task," the person might list for him- or herself "I did a great job with that task." The corresponding homework assignment is consciously to practice contingent self-rewarding statements daily and to record them in the self-monitoring log as positive self-statements.

A final session allows for continued practice of the lessons taught in the program and review of the ideas involved. The therapist is given some latitude in deciding when to go on to a new topic during the weeks of the program. The extra sessions may be spent earlier to go over a topic that the therapist feels needs further effort.

II. THEORETICAL BASES

The self-management therapy program is based on an integrative model of depression that takes elements identified by other models and subsumes them in a larger coherent framework. In doing so, the model adds a focus on depression as a problem in disconnection from long-term goals. Frederick Kanfer's model of self-control provided the basis for Rehm's self-control model of depression. According to Kanfer, when an individual initiates an attempt to achieve a new long-term goal (e.g., quitting smoking, losing weight, getting "in shape"), that person regulates his or her own behavior via a three-phase feedback loop, including self-monitoring, self-evaluation, and self-reinforcement. Self-monitoring involves observing one's own behavior, including antecedents and consequences. Self-evaluation involves comparing one's behavior to an internal criterion or standard. On the basis of this comparison one feels good or bad about progressing toward the goal. Rehm added another consideration in thinking about self-evaluation. To self-evaluate and feel good or bad about a behavior, an internal attribution is nec-

essary. The person does not experience self-control if the control is actually external (e.g., spent the day in a nonsmoking environment).

The third phase of Kanfer's model is self-reinforcement. Kanfer argues that people influence their own behavior in the same way they may influence another person, by rewards and punishments. Metaphorically, if people are successful in their self-control attempts they "pat themselves on the back," and if they do poorly they "kick themselves." The reactions function as rewards and punishments to maintain the self-controlled behavior in the face of external stimuli and reinforcers operating against the behavior change (e.g., smoking urges, the effort of exercising). Self-reinforcement can be overt (rewarding oneself with a movie) or covert (feeling good about an accomplishment).

Rehm's model of depression uses Kanfer's self-control model as a framework. Rehm views depression as a failure of self-control to supplement external controls. When people are depressed they are hypothesized to show six deficits in self-control behavior. First, depressed people tend to self-monitor negative events to the relative exclusion of positive events. They are vigilant for things to go wrong. A similar idea is described by Aaron Beck as selective abstraction and a negative view of the world. Second, depressed people tend to self-monitor the immediate as opposed to the delayed consequences of behavior. Although they may ruminate about long-term goals they tend to be self-indulgent and respond to immediate consequences (watch TV rather than complete the housework).

Third, in terms of self-evaluation, depressed persons tend to set stringent self-evaluative standards for themselves. They view their own behavior as never good enough and tend to make all-or-none judgments that their behavior was either perfect or a complete failure. Perfectionism has been cited by various authors as a component of depression. Fourth, depressed people make negative attributions for their behaviors. Martin Seligman has elaborated this point in an extended attributional analysis of the behavior of depressed people.

The fifth and sixth deficits in the depression model are lack of contingent positive self-reinforcement and excessive self-punishment. Peter Lewinsohn's behavioral model of depression posits a loss or lack of response contingent positive reinforcement as the source of depression. This model assumes that self-administered rewards and punishments supplement external sources. A person with good self-control skills can successfully manage to get through a time of lack of external reinforcement with self-reinforcement and other self-control skills.

As can be seen, the elements of the model are dependent on earlier elements. The person who focuses on negative events and immediate consequences does not take credit for positive events, sees efforts as not meeting standards, fails to self-reinforce, and excessively self-punishes will be disconnected from long-term goals and suffer depression when the environment does not reinforce behavior benignly. The model forms the basis for the therapy program. Each deficit is focused on in sequence with a didactic presentation of the idea, an exercise to help participants understand the idea, and a homework assignment to try out more effective self-control behavior.

III. EMPIRICAL STUDIES

Self-control therapy was first examined in a series of six studies conducted by Rehm and his colleagues. The first two studies conducted were traditional outcome studies, in which self-management therapy was compared to a control group. In 1977, C. Fuchs and Rehm randomly assigned depressed female community volunteers to 6 weeks of self-control therapy, nonspecific group therapy, or a wait-list control condition. Self-control therapy was found to be the most effective treatment for alleviating symptoms of depression. In a second study in 1979 Rehm, Fuchs, D. Roth, S. Kornblith, and J. Romano assigned depressed women from the community to 6 weeks of self-control therapy or a behavioral assertion skills training program. Self-control therapy was found to be more effective than the assertion skills training program with regard to improving self-control and reducing symptoms of depression, whereas the assertion skills training program more effectively improved assertiveness. One year follow-up data on participants in these two studies, reported by Romano and Rehm in 1979, indicated that treatment gains were maintained over time. However, differences between the self-management and other active treatment conditions were no longer significant. Individuals in the self-management condition did report fewer additional depressive episodes and less severe recurrences of depression.

Next, to examine the various components of self-management therapy, two dismantling studies were conducted. The first study, conducted in 1981 by Rehm, Kornblith, M. O'Hara, D. Lamparski, Romano, and J. Volkin, examined five conditions, including: (1) self-monitoring plus self-reinforcement; (2) self-monitoring plus self-evaluation; (3) self-monitoring alone; (4) the complete therapy package; and (5) a wait-list control condition. All four treatment groups outperformed the

wait-list control condition with regard to self-reported and clinician measures of depression, with no consistent differences found between the active treatment groups. In a similar study, Kornblith, Rehm, O'Hara, and Lamparski compared four groups, including: (1) self-monitoring and self-evaluation alone; (2) self-management training without homework assignments; (3) the complete self-management therapy program; and (4) interpersonally oriented group psychotherapy, serving as the control condition. All four groups were successful in alleviating symptoms of depression, with no significant differences found among the groups.

Next, specific behavioral and cognitive targets of self-management therapy were examined. The self-control manual was revised, and programs were developed that focused primarily on cognitive targets (i.e., focusing on self-statements), behavioral targets (i.e., focusing on increasing activities), or both (i.e., the "combined" version). In 1985, Rehm, Lamparski, Romano, and O'Hara compared the three versions of treatment with a wait-list control group. All three treatment groups improved more than control subjects with regard to symptoms of depression, with no differences found between the treatment groups. In 1987, Rehm, N. Kaslow, and A. Rabin again compared the three versions of self-management against each other, using a larger number of participants. Again no differences were found between the three groups, with each group showing significant improvement in self-reported and clinician measures of depression over time. They also improved equally in behavior and cognition.

Self-management therapy has been evaluated by a number of other researchers in various contexts. B. M. Fleming and D. W. Thornton, in 1980, assigned depressed volunteers to self-management therapy, cognitive therapy, or a nondirective therapy control condition. At posttest and follow-up all three groups showed significant improvement, with the self-management group showing the greatest improvement on a number of measures. In 1980, D. P. Tressler and R. D. Tucker conducted a disassembly study in which depressed female volunteers were treated with either the self-monitoring and self-evaluation components alone, or the self-monitoring and self-reinforcement components alone. The self-monitoring and self-reinforcement combination was found to be superior at posttest and at a 12-week follow-up. In 1982, D. Roth, R. Bielski, M. Jones, W. Parker, and G. Osborn compared self-management therapy alone, to the combination of self-management therapy and a tricyclic antidepressant; although there was a faster response in the combined condition, no significant differences were found between the two

groups at posttest and a 3-month follow-up in self-reported symptoms of depression. S. Rude in a 1986 paper assigned depressed women to both cognitive self-control treatment (a modified version of Rehm's therapy) plus assertion skills training (administered in random order), or to a wait-list control group. Participants who received the combination of self-control and assertiveness training experienced significantly larger reductions in depressive symptoms than the control group. However at the midtreatment point, when each participant had only received one form of therapy, no significant differences were found between the three groups. R. Thomas, R. Petry, and J. Goldman in a 1987 paper assigned depressed female volunteer participants to 6 weeks of self-control therapy or cognitive therapy. Both forms of therapy were effective in alleviating depression, with results remaining at a 6-week follow-up. In 1995, J. H. C. van den Hout, A. Arntz, and F. H. J. Kunkels compared 12 weeks of self-control therapy plus standard treatment, to standard treatment alone, for depressed patients in a psychiatric day-treatment center. The addition of self-control therapy was significantly more effective than standard treatment alone with regard to improving self-control, self-esteem, and depression. Although gains were maintained at a 13-week follow-up, significant differences were no longer found between the two groups.

Self-management therapy has also been applied to diverse populations. In 1982, P. Rogers, R. Kerns, Rehm, E. D. Hendler, and L. Harkness found self-management therapy to be more effective than nonspecific individual psychotherapy in reducing depression in renal dialysis patients. S. Bailey in a 1996 study examined the effect of self-management therapy compared to a wait-list control condition as a treatment for abused women. Treated participants experienced significantly greater improvement than control subjects in symptoms of depression, self-control, and dysfunctional attitudes.

Self-management therapy has also been modified for use with depressed children and adolescents. In 1986, W. Reynolds and K. I. Coats assigned moderately depressed high school students to self-management therapy, relaxation training, or a wait-list control condition. Both therapy groups, compared to the control group, experienced significant reductions in depression and anxiety, as well as improvements in academic self-image. K. Stark, Reynolds, and Kaslow (1987) assigned children, ages 9 to 12, to either behavioral problem solving, self-control therapy (a child version), or a wait-list control condition. At posttest and 8-week follow-up, both treatment groups showed significant improvements in self-reported and clinician-rated de-

pression, whereas the wait-list control group showed little change. In 1996, Rehm and R. Sharp reported the results from a study in which self-management therapy was provided to fourth- and fifth-grade students; although little improvement was seen in depression across participants, those children who were classified as "depressed" at pretest significantly improved with regard to symptoms of depression, social skills, and attributional style.

Self-management therapy has also been applied to older adults (age 60 or older). P. Rokke, J. Tomhave, and Z. Jovic in a 1999 paper assigned depressed older adults to one of two forms of self-management therapy (one with a cognitive focus and one with a behavioral focus), or to a wait-list control condition. Both self-management groups, compared with the control group, experienced significant reductions in depressive symptoms (with gains maintained at a 3-month and 1-year follow-up), as well as improvements in depression-related cognitions, learned resourcefulness, self-control, and self-reinforcement. No differences were found between the two versions of self-management therapy. In a similar study published in 2000 Rokke, Tomhave, and Jovic randomly assigned depressed older adults to 10 weeks of self-management therapy, an educational support group, or to a wait-list control condition. No differences were found between the two treatment groups, each of which was more effective than the control group in alleviating depression and improving self-reinforcement, learned resourcefulness, and self-control knowledge. In addition, reductions in depression levels were maintained at the 1-year follow-up.

IV. SUMMARY

In sum, Rehm's self-management therapy program is a structured, manualized, cognitive-behavioral group therapy program, designed for the treatment of depression. The therapy is designed to address deficits in the three phases of the self-control feedback loop, including self-monitoring, self-evaluation, and self-reinforcement. A number of empirical evaluations have validated the efficacy of self-management therapy as an effective treatment for depression.

See Also the Following Articles

Grief Therapy ■ Self-Control Desensitization ■ Self-Help Groups ■ Self-Help Treatment for Insomnia ■ Self Psychology ■ Trauma Management Therapy

Further Reading

- Rehm, L. P. (1977). A self-control model of depression. *Behavior Therapy*, 8, 787–804.
- Rehm, L. P. (1995). Psychotherapies for depression. In K. S. Dobson & K. D. Craig (Eds.), *Anxiety and depression in adults and children* (pp. 183–208). Thousand Oaks, CA: Sage.
- Rehm, L. P., Mehta, P., & Dodrill, C. (2001). Depression. In M. Hersen & V. B. Van Hasselt (Eds.), *Advanced abnormal psychology* (2nd ed., pp. 307–324). New York: Kluwer Academic/Plenum.
- Rehm, L. P., & Sharp, R. N. (1996). Strategies in the treatment of childhood depression. In M. Reinecke, F. M. Dattilio, & A. Freeman (Eds.), *Comprehensive casebook on cognitive-behavior therapy with adolescents* (pp. 103–123). New York: Guilford Press.
- Rokke, P. D., & Rehm, L. P. (2001). Self-management therapies. In K. S. Dobson (Ed.), *Handbook of cognitive behavior therapies* (2nd ed., pp. 173–210). New York: Guilford Press.

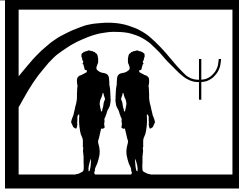

Self-Help Groups

Gary M. Burlingame and D. Rob Davies

Brigham Young University

- I. Overview and History
 - II. How Self-Help Groups Work
 - III. Effectiveness
 - IV. The Future
 - V. Summary
- Further Reading

GLOSSARY

helper-therapy principle Introduced by Riessman in 1965 to convey the notion that in the act of helping others, the member is empowered, both to help others and simultaneously to help him- or herself.

professional-centrism The tendency of professionals to view self-help groups with higher levels of professional involvement as being more helpful than non-professional self-help groups. This leads them to be more likely to refer to and support groups with higher levels of professional involvement.

self-help clearinghouses Organizations dedicated to cataloging and referring interested parties to the self-help groups in a particular district or region.

self-help groups Voluntary associations of persons who share common concerns or problems and who try to support and help each other at little or no cost.

self-help organizations Refers to a more complex and broader level of organization (regional, national, or international associations) that foster the development and management of local self-help groups.

I. OVERVIEW AND HISTORY

Despite rather humble beginnings, self-help groups have become a pervasive phenomenon in the United

States. Although their history can be traced as far back as the guilds in the Middle Ages and likely before, the origination of modern self-help organizations is most typically associated with the start of Alcoholics Anonymous (AA) in June of 1935. AA is the largest and oldest self-help organization in the United States. It started as the brainchild of two recovering alcoholics, Robert Holbrook Smith and stockbroker William Wilson. AA is the prototype for modern self-help groups in the United States and Canada and, in fact, has become one of the most commonly utilized groups among those seeking treatment for alcohol problems. There are now estimated to be more than 55,000 AA groups in the United States, and Canada.

Other well known self-help groups include Recovery, Inc., the National Alliance for the Mentally Ill (NAMI), Narcotics Anonymous, and Schizophrenics Anonymous as well as lesser known groups for epileptics, families of suicide victims, a variety of neurological diseases, eating disorders, a multitude of serious emotional crises (retirement, widowhood, loss of a child, various illnesses, handicaps, unemployment, divorce), almost all chronic diseases, minorities, marginalized peoples, and parenting to name but a few of the groups available. This list is by no means exhaustive because estimates suggest that there are over 400 distinct types of self-help groups in the United States alone.

Self-help clearinghouses have sprung up due in part to the wide variety and the sheer number of self-help groups in any one geographical area. These clearinghouses are dedicated to cataloging and referring interested parties to

the self-help groups in a particular district or region. For example, Gerald Goodman reports that in 1993 the California Self-Help Center clearinghouse alone, with 4,600 groups in its database, referred about 120 people a day to self-help groups.

Self-help groups have grown at an astounding rate. At present, it is estimated that the number of people being treated in self-help groups exceeds those in professionally-led individual and group therapy combined. It is surmised that roughly 25 million Americans have attended one of 500,000 self-help groups at some point in their lives. Telephone surveys of random individuals indicate that almost 7% of people admit to being actively engaged in a self-help group at any one time.

Despite the ubiquitous nature of self-help groups, there is less clarity on what is meant by the term. Mental health professionals have struggled for years to define these groups. Part of the difficulty lies in the fact that the concept itself is somewhat fluid. For instance, each one of the estimated 500,000 self-help groups add their own unique contributions to the definition. Despite this challenge most researchers have settled on four basic definitional tenants:

1. Members have common concerns or problems that they are dealing with.
2. Members of the group have control over the structure and format of the group.
3. Help that is received is given primarily through other members in the group.
4. There is little or no cost for the members of the group.

Although this definition has utility as an anchor point, it is important to keep in mind that individual self-help groups will vary on each one of these dimensions. For example AA groups and other "Anonymous" groups are built on a structured 12-step approach in which local chapters are facilitated by a larger national organization. Thus, although local members have some control over the structure and format of the group, much of what happens in group is a result of the structure set by the national program.

Other self-help groups are entirely controlled by local members without any affiliation with local or national organizations. In fact, given the earlier definition, a group of three or four single mothers who get together a couple of times a month for lunch to talk about their struggles could be classified as a self-help group. Of course, these self-help groups will never be classified by clearinghouses, receive publicity, and are

closed to other outsiders; nonetheless they fall under the rubric of self-help groups.

Given the aforementioned definitional variability, is there a typical self-help group? The answer depends on whether one includes AA and the approximately 150 other 12-step groups as the model group. A persuasive argument for such is offered by Kathryn Davison and colleagues who found that out of 12,596 self-help groups identified in four major cities for 20 different diseases or disorders, 10,966 (87%) were AA groups. Given the pervasive nature of AA groups, a brief overview is warranted.

AA meetings are divided into four types.

1. Open Meetings: Any interested person may attend.
2. Closed meetings: Only people who are alcoholic or who have a desire to stop drinking may attend.
3. Discussion meetings: Typically the chairperson suggests a topic for the group.
4. Speaker meetings: The speaker presents his or her life before entering the group and gains made since then.

AA and other "Anonymous" groups follow a 12-step program. The first 3 of the 12 steps deal with the admission of defeat or powerlessness over addiction. Steps 4 through 9 consider healing the ruin of the past, and the last 3 steps deal with maintaining peace and serenity. There is an unmistakable emphasis on religious or spiritual influences in 12-step groups, which has led to their marginalization in some contexts. Nevertheless, 12-step programs have flourished and are considered by many professionals today to be an integral part of treatment for addictions.

The majority of all self-help groups (about two-thirds) formally introduce existing group members to new members and have new members introduce themselves. Some (about one third) ask new members to share personal experiences related to the group's stated purpose. With few exceptions new members are welcomed and accommodated. In recent comprehensive surveys, as many as 40% of self-help groups were oriented toward the treatment of physical illness. Attendance at these group meetings varied considerably, with some being very large (50 people in attendance) and others involving only 2 to 5 individuals (average attendance is in the range of 13 to 21 people). Most self-help groups recruit new members by word of mouth, but a significant number also use newspaper or magazine advertisements or solicit professionals for referrals.

Some authors have tried to differentiate self-help and mutual support groups (also referred to simply as

support groups). The usual distinction is the level of professional involvement in leading, sponsoring, or otherwise controlling the nature of the group. Support groups are more frequently aligned with mental health professionals and are often led by a trained therapist. On the other hand, self-help groups are usually viewed as being relatively autonomous from professional involvement, and peer leadership is endorsed.

Critics of professional involvement voice their concern about the loss of the self-help group's ideology and effectiveness when a professional assumes the leadership role. This is based on an important therapeutic principle that self-help group members experience autonomy, control of the group, and a sense that they are the experts on their difficulty. Opponents to professional involvement postulate that when an authority steps in, the unique benefits of self-help groups are lost, and the members of the group may begin to engage in docile "patient behavior." This concern has led some writers in the field to characterize groups by the presence or absence of professional involvement with the former being classified as a treatment group (psychotherapy or psychoeducation).

The distinction between groups with and without professional involvement may have more ideological and historical value because modern self-help groups often incorporate professionals. More specifically, recent research indicates that most "self-help" groups have some professional involvement. In 1993, Morton Lieberman reported that over 60% of observed groups were professionally facilitated while simultaneously being characterized as self-help. Eight years earlier (1985), Jennifer Lotery randomly sampled 850 self-help groups in California and found that 14% "frequently" had professionals in the role of solo leader with another 35% using professionals as co-leaders. Thus nearly one half the groups experienced a professional as part- or full-time co-leader. More recently, Scott Wituk's work in 2000 found that in a sample of 253 randomly selected self-help groups only 27% were peer led with no professional involvement. Other recent random samples have also shown similar results, that is, a growing trend to include professionals in self-help groups.

Lotery's survey suggests that most self-help groups welcome professionals, especially as a referral source, speaker, teacher, student, or co-leader. Respondents also stated an interest in having professionals serve as solo leaders or coordinators/organizers. In general, most self-help organizations echo this sentiment. For instance, a recent study reports that groups with a combination of both peer and professional leadership had

greater longevity and continued group membership than either professional or peer-led groups. Thus, peer-leadership versus professional leadership seems to fall on a continuum rather than the dichotomous variable that early researchers conceptualized.

Despite potential for collaboration and consultation, it is important to note that self-help groups and professionals often view the consulting role rather differently. Self-help group members can view professionals as wanting to control the group using their clinical experience and training. Thus, it is important for professionals to approach self-help groups with an attitude of mutual respect and partnership rather than as a source for expert solutions that may conflict with self-help group ideology. Several recent studies of mental health professionals' perceptions of self-help groups suggest that the majority view groups with higher levels of professional involvement as being more helpful, effective, good, strong, healthy, understandable, active, interesting, predictable, and safer than groups with less professional association. This phenomenon has been labeled by Mark Salzer as "professional centrism" and has been well documented. Professionals are more likely to refer to and support those groups with higher levels of professional involvement. Paradoxically, scant research exists to either support or refute professionals' faith in self-help groups with more professional involvement.

II. HOW SELF-HELP GROUPS WORK

Members of self-help groups are empowered by not only being responsible for helping themselves, but also by being accountable for helping others. This is known in the self-help literature as the "helper-therapy principle." In helping his or her peers the member is enabled, both to assist others and at the same time to help him- or herself. The opportunity to help others with a similar problem is often a catalyst for personal change. Some research supports the help-therapy principle. Specifically the number of helping statements made by a member has been directly and significantly correlated with increasingly positive outcomes by Linda Roberts and her colleagues. Being in a position to help others with similar problems may be a unique experience for members of self-help groups, an opportunity not present in individual psychotherapy. In most self-help groups, even members who are experiencing serious challenges are given an opportunity to help others in the group.

A second source of therapeutic potential for self-help groups is the opportunity to observe strong role models

of individuals who have overcome similar problems. According to Festinger's social comparison theory, people have a drive to evaluate their opinions and abilities by comparing themselves to others that they deem as similar. Self-help groups provide a unique opportunity to compare oneself with homologous others who have overcome analogous problems. Strong role models can exemplify success, reinforce group norms, provide empathy, and promote identification and motivation. In self-help groups, many successful members continue to attend to share their success and offer support to new or struggling members. This continued long-term involvement is possible because the groups are usually free from financial obligations. Moreover, research suggests that the longer a person participates in a self-help group the more likely they are to benefit from it.

III. EFFECTIVENESS

The scientific study of self-help groups has been slow and difficult at best. The traditional research paradigm for studying the effectiveness of psychotherapy groups involves randomly assigning participants to experimental and control conditions and then observing differences between the two groups. Application of this protocol to self-help groups is problematic because they are not under the researcher's control and participants cannot be randomly assigned to a no-treatment or wait-list control condition. More specifically, refusing or delaying fellowship to interested members is in direct opposition to the open philosophy of the self-help movement.

Critics have also argued that there is an inherent selection bias in studies that assess the outcome of self-help groups. Indeed, research has shown that individuals who do not expect to benefit from self-help groups drop out. This phenomenon led Leon Levy to argue those who remain in self-help groups will undoubtedly find the group to be effective thereby skewing the effectiveness results in the "positive" direction.

A final obstacle in the scientific study of self-help group effectiveness lies in the purported effects. In traditional group psychotherapy therapists focus on the removal of symptoms by treating the underlying causes for pathology (maladaptive relationships, distorted cognition, etc.). On the other hand, self-help groups focus on mutual support. In short, the expected outcomes for the self-help and traditional psychotherapy groups are different. More specifically, one measure of effectiveness for self-help groups may be the amount of support these groups give to each other and not the re-

duction of psychopathology. Members often highlight the salubrious effect of the group on their feelings of isolation and social seclusion rather than reduction in pathology reporting high levels of satisfaction. Although robust empirical data on the effectiveness of self-help groups is scarce, the current literature does support their effectiveness. Participation in self-help groups has been linked to improved subjective well-being, attenuated use of professional services, strengthened coping skills, shorter hospital stays, less denial of problems, less identification with the patient role, and reduced psychiatric symptomatology. Self-help groups also help individuals form a new identity, give them a sense of belonging and association, and assist in personal transformations through support, advocacy, and empowerment. Self-help groups are recommended by a majority of treatment programs for substance disorders. In fact, studies that evaluated AA as one element in a treatment program suggest that alcoholics who attend AA in addition to other treatment modalities do better than those who attend only AA or use professional treatment alone. In general 12-step groups have produced beneficial outcomes.

It is important to note that not all research has supported the effectiveness of self-help groups. In 1999, Sally Barlow and colleagues focused on self-help groups in the medical field. Seventeen studies that compared controls with active self-help treatment groups when examined as an aggregate found no evidence that members of medical self-help groups improve more than a non-treated control group. However, this does not mean that members of the self-help groups were not satisfied with their groups or that they did not receive benefits other than those objectively measured by the researchers.

IV. THE FUTURE

Self-help groups are not an endangered species. Gerald Goodman and Marion Jacobs predicted that self-help groups will become the nation's "treatment of choice" in the next 10 to 20 years. Given self-help groups' exponential growth in recent years, it is hard to imagine a mental health field without them. In fact, with the increasing scarcity and lack of availability of mental health services to the general public, self-help groups are virtually assured a position of prominence in the future. It is also likely that professional involvement in self-help groups will not only continue but intensify over time. Self-help groups are being recognized as a

legitimate resource for clients and, as such, increasing numbers of professionals will vie to become involved with these groups.

Online groups are beginning to gain acceptance as a viable treatment alternative to the formal self-help group venue. They are likely to become increasingly common as more and more people gain access to this mode of communication. Advantages of online self-help groups include their availability (24-hours-a-day), breadth (worldwide), specificity (support for those with relatively rare conditions), and lower level of interpersonal risk (anonymity and indirect participation). Online self-help groups appear to be expanding despite the fact that almost no research exists to delineate whether participation is helpful or satisfying—a topic in need of future research.

V. SUMMARY

Self-help groups have grown exponentially since the inception of AA and are now a primary treatment method for many individuals. Although defining self-help groups has been problematic given the variety of groups available, they are typically composed of members with common concerns who have control over the structure and format of the group and who give mutual aid and support to each other for little or no cost. Of the over 400 documented types of self-help groups, most have some professional involvement, especially as a referral source, speaker, teacher, or consultant. Core therapeutic principles include giving members oppor-

tunities to help others, motivating them to emulate successful others in the group, and offering friendship and support. The study of how effective self-help groups are has been fraught with a number of problems that center around self-selection. Despite these problems, most research indicates that they are effective. In addition, most members of these groups report being highly satisfied with their group experience and rate the group as beneficial. It is likely that in the coming years self-help groups will become even more common.

See Also the Following Articles

Anxiety Disorders: Brief Intensive Group Behavior Therapy ■ Behavioral Group Therapy ■ Cognitive Behavior Group Therapy ■ Group Psychotherapy ■ Matching Patients to Alcoholism Treatment ■ Minimal Therapist Contact Treatments ■ Psychodynamic Group Psychotherapy

Further Reading

- Barlow, S. H., Burlingame, G. M., Nebeker, R. S., & Anderson, E. (2000). Meta-analysis of medical self-help groups. *International Journal of Group Psychotherapy*, 50(1), 53–69.
- Goodman, G., & Jacobs, M. K. (1994). The self-help, mutual-support group. In A. Fuhriman, & G. M. Burlingame (Eds.), *Handbook of group psychotherapy: An empirical and clinical synthesis* (pp. 489–526). New York: John Wiley & Sons.
- Kurtz, L. F. (1997). *Self-help and support groups: A handbook for practitioners*. Thousand Oaks: CA Sage.
- Wituk, S., Shepherd, M. D., Slavich, S., Warren, M. L., & Meissen, G. (2000). A topography of self-help groups: An empirical analysis. *Social Work* 45(2), 157–165.

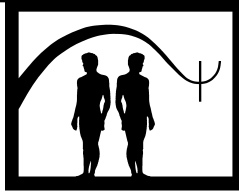

Self-Help Treatment for Insomnia

Annie Vallières, Marie-Christine Ouellet, and Charles M. Morin

Université Laval

- I. Introduction and Definition
 - II. Description of Treatments
 - III. Treatment Formats and Process
 - IV. Empirical Studies: Evidence for Efficacy
 - V. Advantages and Limitations of Self-Help Approaches
 - VI. Summary
- Further Reading

GLOSSARY

- chronic insomnia** Insomnia persisting more than 1 month.
- insomnia** A condition involving difficulties falling asleep, staying asleep, early morning awakening, or nonrestorative sleep.
- meta-analysis** A quantitative method using a common metric (z score) to summarize the data from different studies.
- primary insomnia** Insomnia that is not associated with another medical, psychiatric, or sleep disorder.
- self-help treatment** Intervention based on printed information or audio/video material designed to improve a medical or psychological condition.
- sleep efficiency** A measure of sleep continuity obtained by dividing the total amount of time slept by the time spent in bed, multiplied by 100.
- sleep hygiene** Education about the impact of lifestyle and environmental factors on sleep.
- sleep-onset latency** Time required to fall asleep at bedtime.
- sleep restriction therapy** Behavioral procedure consisting of limiting time in bed to the actual time spent sleeping.
- stimulus control therapy** Behavioral procedures aimed at establishing a consistent sleep-wake rhythm and reassociating the bed and bedroom with sleep rather than with insomnia.

I. INTRODUCTION AND DEFINITION

Insomnia is a prevalent condition affecting about 10% of the adult population on a chronic basis. It involves either difficulties falling asleep, staying asleep, early morning awakenings, or nonrestorative sleep. Insomnia can occur as a unique disorder, as in primary insomnia, or may be secondary to another medical (e.g., cancer) or psychological condition (e.g., depression or anxiety). Chronic sleep disturbances are often associated with negative daytime consequences such as fatigue and mood disturbance, thus significantly affecting one's quality of life. Despite its high prevalence and potential impact on social or occupational functioning, only a small portion of individuals with chronic primary insomnia actually receives any treatment. For those who do seek relief for their insomnia, the first interventions are usually self-initiated and generally involve medications bought over-the-counter, natural products, or the use of alcohol. When insomnia is brought to the attention of physicians, pharmacotherapy is the most widely used and often the only recommended treatment option, despite the controversy existing over the long-term use of hypnotic medications. In the past 20 years, there has been an increasing interest in psychological and behavioral factors contributing to insomnia. This has led to the development of diverse psychological therapies for insomnia, many of which have been shown to produce significant and

durable effects. However, these interventions remain underutilized because they are not well known to health care practitioners and are less easily accessible, both physically and financially, than pharmacotherapy. A self-help treatment for insomnia is a valuable alternative to overcome some of these barriers by making treatment more accessible, at a low cost, to a larger number of individuals with insomnia. Self-help treatment refers to any intervention, either for a psychological or physical condition, that is implemented with the assistance of printed material (e.g., books, pamphlets), audio- or videotapes, or any other medium (e.g., Internet). It can be implemented with or without guidance from a health care professional. The objective of this article is to provide an overview of self-help treatments that have received empirical validation in the management of primary insomnia.

II. DESCRIPTION OF TREATMENTS

Self-help treatments for insomnia incorporate much of the same information and material provided in a face-to-face therapy. Interventions that have received adequate empirical support and that are usually included in self-help treatment programs include stimulus control, sleep restriction, cognitive therapy, sleep-hygiene education, and relaxation procedures. The main goals of these interventions are to induce sleep rapidly at bedtime, to sustain it with minimal interruptions throughout the night, to enhance sleep quality and duration, and to improve daytime functioning. To achieve these outcomes, treatments focus on psychological and behavioral factors presumed to perpetuate sleep difficulties. They seek to curtail maladaptive sleep habits, to regulate the sleep schedule, to correct faulty beliefs and attitudes about sleep, to reduce autonomic arousal, and to educate patients about good sleep hygiene. Another common goal of these therapies is to teach self-management skills for coping with residual sleep disturbances once treatment is completed. Some interventions, such as stimulus control instructions, or sleep restriction, are more amenable to a self-help format because they are primarily educational or instructional in nature. Others, like relaxation or cognitive therapy, are likely to require more direct guidance, possibly with the help of a therapist, if they are to be fully effective. Provided next is a brief description of several of the psychological interventions that can be applied in a self-help format.

A. Stimulus Control

Stimulus control therapy consists of a set of behavioral rules designed to bring the patient to reassociate the bed and bedroom with sleep rather than with arousal or the frustration caused by the inability to sleep. This is achieved by curtailing sleep-incompatible activities. A second objective is to establish a consistent sleep-wake rhythm by setting a regular arising time and by avoiding naps. Standard stimulus control instructions are:

- Go to bed only when sleepy.
- Use the bed and bedroom for sleep and sexual activity only; do not read, watch TV, or worry in bed.
- When unable to sleep within 15 to 20 min, leave the bed and go into another room; return to bed only when sleepy again (this step is repeated as often as necessary throughout the night).
- Arise at the same time every morning regardless of the amount of sleep obtained the night before
- Do not take naps during the day.

B. Sleep Restriction

Individuals with insomnia sometimes spend excessive amounts of time in bed in a misguided effort to obtain more sleep. In turn, this practice may cause more fragmented sleep and perpetuate insomnia. The standard sleep restriction procedure consists of curtailing time in bed to the actual sleep time. Once the usual sleep time and time spent in bed have been estimated with the help of a sleep diary kept for at least one week, an initial time window is defined in which the patient can sleep or attempt to sleep (i.e., total time allowed in bed). This window is set to correspond to the average total sleep time and is readjusted periodically (usually weekly), either decreased or increased, based on estimations of sleep efficiency that can be easily calculated from the sleep diary (ratio of total sleep time over time spent in bed x 100). As sleep efficiency improves, the sleep window is progressively extended until an optimal sleep duration is achieved. Although the task of setting and adjusting the sleep window is usually left to the therapist in face-to-face treatments, this procedure, if well explained in written material, can be easily implemented by the individual. Sleep restriction guidelines are fairly operational and easy to follow for adjusting the sleep window: for example, if a person has been able to maintain a sleep efficiency of at least 85% for 1 week, the time allowed in bed is increased by a small amount, usually 15 to 20 min. Conversely, if

sleep efficiency is lower than 80%, the time allowed in bed is decreased by the same amount. Sleep restriction induces a mild state of sleep deprivation, which promotes a more rapid sleep onset, more efficient and consolidated sleep, as well as less inter-night variability. This procedure should however be used with caution with individuals who engage in hazardous activities (e.g., construction workers, truck drivers). In all circumstances, the time allowed in bed should never be less than 5 hrs to prevent excessive daytime sleepiness.

C. Relaxation Therapies

Patients with insomnia are often tense and anxious, both at night and during the day. Relaxation-based interventions are the most commonly used nondrug therapy for insomnia. A variety of techniques target different types of arousal. For example, progressive muscle relaxation, autogenic training, and biofeedback are used to reduce somatic arousal such as muscle tension. Cognitive or emotional arousal in the form of worries, intrusive thoughts, or a racing mind are addressed using attention-focusing methods such as imagery training (i.e., focusing on pleasant or neutral mental images) or meditation. Relaxation therapies may be less easily self-implemented than stimulus control or sleep restriction because they require the learning of specific relaxation techniques through appropriate training. Professional guidance or an audiotape is often necessary, particularly in the initial phase of treatment (e.g., the first 3 weeks), to optimize an adequate use of the techniques. Regardless of the training method selected, therapeutic gains usually require at least 2 to 3 weeks of relaxation training.

D. Cognitive Therapy

Poor sleepers tend to entertain faulty beliefs and attitudes about sleep, which feed into the vicious circle of insomnia, emotional distress, and more sleep disturbance. As such, insomnia often becomes a self-fulfilling prophecy. For instance, the belief that 8 hrs of sleep is an absolute necessity, or the perception that one is unable to function after a poor night's sleep is often enough to produce anxiety and exacerbate sleep disturbances. The objective of cognitive therapy is to alter these types of sleep-related cognitions by challenging them and replacing them with more adaptive substitutes. Several clinical procedures, modeled after those used in treating anxiety and depression, can be used for changing patients' misconceptions about sleep. Such

techniques include attention shifting, reappraisal, reattribution training, and decatastrophizing. Cognitive therapy is also used to teach patients strategies to cope more adaptively with residual difficulties that recur occasionally even after treatment.

E. Sleep Hygiene

Sleep hygiene education fosters healthy habits through simple recommendations about diet, substance use, exercise, and environmental factors that promote or interfere with sleep. Standard sleep hygiene measures include the following:

- Avoid stimulants several hours before bedtime. Caffeine and nicotine, both central nervous system stimulants, can impede sleep onset and reduce sleep efficiency and quality.
- Do not drink alcohol too close to bedtime. Alcohol consumption prior to bedtime can lead to more fragmented sleep and early morning awakenings.
- Avoid heavy meals too close to bedtime, as they can interfere with sleep. A light snack may be sleep inducing.
- Regular exercise in the late afternoon or early evening can deepen sleep. Conversely, exercising too close to bedtime could have a stimulating effect and delay sleep onset.
- Keep the bedroom environment quiet, dark, and comfortable.

III. TREATMENT FORMATS AND PROCESS

Several formats have been used to implement self-help therapies for insomnia, including printed material (books or pamphlets), audiotapes, and videotapes. Some Internet sites are also under construction, a format that should make treatment more interactive. Most treatments available tend to combine different formats, for example by offering a self-help book in conjunction with an audio- or videotape.

The basic structure of a self-help intervention for insomnia is similar to a therapist-led treatment. The first step is to provide basic information about sleep and insomnia. A brief self-assessment method is introduced to ensure proper diagnosis. The daily use of a sleep diary throughout treatment is an essential feature of any self-help intervention for insomnia. Indications and contraindications of self-help treatment are also underlined. Patients should be informed to seek professional help

when they are not sure whether they suffer from insomnia or from another condition (e.g., sleep apnea, depression). Once these preliminary steps have been completed, a conceptual model of insomnia is described, and the rationale behind the treatment is explained. This is particularly important because some treatment procedures, such as sleep restriction or stimulus control for instance, can appear paradoxical to individuals seeking relief for their insomnia, especially when they are sleep deprived. Consequently, it is important to inform the patient that mild sleep deprivation might occur in the initial phases of treatment, and to explain how this procedure will help them if they adhere to the treatment protocol. This understanding may influence the patient's willingness to invest time and efforts in carrying out the therapeutic recommendations.

Although therapist-led treatments often comprise 6 to 10 therapy sessions spread over a period of 10 to 12 weeks, there is no standard time frame when it comes to implementing a self-help treatment. Nonetheless, 4 to 6 weeks of strict adherence to treatment is usually necessary for sleep improvements to become noticeable. As treatment is often multifaceted, it is preferable to introduce each therapeutic component in a sequential fashion. Once basic information about sleep and insomnia and the rationale for treatment has been provided, sleep restriction and stimulus control procedures may be introduced. When these components are well integrated (about the 3rd week), treatment can move on to cognitive restructuring of dysfunctional beliefs and attitudes about sleep. Sleep hygiene education can be incorporated at any point in the treatment. If a relaxation-based component is added to the treatment, it should be introduced early on to allow sufficient time for training.

IV. EMPIRICAL STUDIES: EVIDENCE FOR EFFICACY

The efficacy of psychological treatments (mostly behavioral in nature) for chronic and primary insomnia has been well documented in the last 20 years. Two meta-analyses have shown that psychological treatments are effective in treating sleep-onset insomnia (problems falling asleep) as well as sleep-maintenance insomnia (problems staying asleep). Overall, it is estimated that about 70% to 80% of individuals with insomnia achieve some clinical benefits with behavioral interventions. Typically, treatment is likely to reduce the main target symptoms of sleep-onset latency and

wake after sleep onset below or near the 30-min criterion initially used to define insomnia severity. Sleep duration is increased by a modest 30 to 45 min, but patient's satisfaction with sleep quality is significantly enhanced. Moreover, treatment gains are well sustained or even enhanced up to 24 months after completion of treatment.

There have been only five studies conducted on the topic of self-help treatment for insomnia. Table 1 presents a summary of these studies. The first investigation of self-help treatment for insomnia was conducted in 1979. It was designed to compare the efficacy of two self-administered treatment manuals for sleep-onset insomnia with a waiting-list control condition. One manual included relaxation and standard stimulus control instructions, whereas the other involved a different form of relaxation plus a countercontrol procedure in which participants were instructed to stay in bed when unable to sleep. Sleep-onset latency, number of awakenings, and worries about sleep were assessed with sleep diaries completed daily by the participants. Twenty-nine participants aged between 17 and 80 years old were enrolled in the study. The results showed a significant reduction of sleep-onset latency in both treatment conditions, although the standard stimulus control condition was superior (59% versus 32%). Participants receiving the manual with the standard relaxation and stimulus control procedures also reported higher ratings of sleep quality. Greater improvements were observed in younger individuals as compared to the elder participants. The authors suggest that the higher prevalence of medical conditions in the elderly might interfere with sleep and thereby moderate treatment efficacy.

The next study was performed 10 years later by David Morawetz in Australia. Three questions motivated his study: (a) Is self-help treatment more effective than no treatment? (b) Is self-help treatment as effective as a therapist-led treatment? and (c) What factors moderate the treatment response to self-help interventions? One-hundred-and-forty participants aged from 23 to 63 years took part in the study, including 63 who were taking sleep medication. Daily sleep diaries were again used to evaluate the comparative efficacy of three conditions: a self-help treatment, a therapist-led treatment, and a waiting-list control. The treatment material included basic information on sleep physiology and sleep disorders, a description of the standard stimulus control instructions, and relaxation training instructions. Whether they were in the self-administered or in the therapist-led treatment group, participants

TABLE 1
Summary of Empirical Studies on Self-Help Treatment for Insomnia

<i>Authors</i>	<i>Sample</i>	<i>Design</i>	<i>Self-help format</i>	<i>Treatment content</i>
Alperson & Biglan (1979)	N = 29 17–80 years old	Relaxation + stimulus control Relaxation + counter control Waiting-list	Printed manual	Relaxation + Stimulus control relaxation + in-bed activities
Morawetz (1989)	N = 141 23–60 years old	Self-help treatment Therapist-led treatment Waiting-list control	Audiotape/manual	Sleep information + relaxation + stimulus control
Oosterhuis & Klip (1993)	N = 325 15–86 years old	Single group, quasi-experimental design	Television and radio segments, booklet and audiotape	Sleep information + relaxation + stimulus control + sleep hygiene
Riedel et al. (1995)	N = 100 > 60 years old	Video treatment with or without therapist guidance; good sleepers controls	Videotape/pamphlet	Sleep information + sleep restriction
Mimeault & Morin (1999)	N = 54 18–54 years old	Self-help treatment Self-help treatment + phone consultation Waiting-list control	Treatment manual	Stimulus control, sleep restriction, sleep hygiene education, cognitive interventions

received the same therapeutic components. The results showed significant reductions of sleep-onset latency for the two treatment groups, both at posttreatment and at a 3-month follow-up assessment. No significant improvement was observed in the waiting-list condition. The authors noted only limited improvements among participants who received treatment but were concurrently using a sleep medication. These improvements were nonetheless greater for the group receiving therapist-led treatment than for the group receiving the self-administered intervention. These results suggest that self-help treatment is effective but also highlight the importance of therapist assistance in cases where complicating issues, such as medication use, are present.

In 1993, a Dutch public television channel scheduled a series of television and radio programs that were broadcast in the Netherlands to offer educational material about insomnia and its treatment. There were eight television (15 min each) and nine radio segments. In addition, participants received by mail a relaxation tape and a booklet summarizing the critical information covered during the television and radio programs. The written material incorporated basic information about sleep and sleep hygiene education, relaxation training, and stimulus control techniques. Psychologists Aart Oosterhuis and Ed Klip evaluated the impact of this program. Participants were recruited via a survey and completed a daily sleep diary and different sleep and

mood questionnaires. This program reached an estimated 23,000 individuals. Of 400 participants who volunteered for the evaluation of this program, a total of 105 returned their assessment material. The results showed a significant decrease in sleep-onset latency and in the number of awakenings as well as a significant increase in total sleep time. In addition, 40% of the participants discontinued their medication during treatment. Although the results must be interpreted carefully because of the absence of control, this type of innovative program has the advantage of reaching a large number of individuals who may suffer from insomnia without ever consulting for it.

In a 1995 study, Brant Riedel, Kenneth Lichstein, and William Dwyer evaluated if therapist guidance, added to a self-help video program, influenced the efficacy of a self-help treatment for insomnia in older adults. Participants kept daily sleep diaries and completed a questionnaire evaluating knowledge about sleep. The video lasted about 15 min and contained information about sleep in the elderly, the benefits of restricting time in bed, and the possible hazards associated with the use of sleep medications. Subjects in the video-only condition and the video-plus-therapist guidance condition viewed the video twice with 2 weeks between viewing sessions. Participants in the therapist-guided condition received two additional group training sessions with a therapist. During these sessions, the therapist emphasized the

importance of restricting time in bed. Participants were evaluated before and after each session, and 2 months after the end of the intervention. The results indicate that both self-help interventions were effective to improve several sleep variables, but also that the addition of therapist guidance enhanced treatment outcome.

Véronique Mimeault and Charles Morin conducted the most recent study of self-help treatment in 1999. This investigation examined the efficacy of cognitive-behavioral therapy with and without professional guidance. Fifty-four adults were enrolled in this study after being carefully screened with structured diagnostic interviews. Participants were excluded if there was evidence of another sleep disorder, severe depressive or anxiety symptoms, as well as if they were using an antidepressant medication or if they were concurrently involved in psychotherapy. Participants were randomly assigned to a condition involving a self-help treatment manual only (bibliotherapy), a self-help treatment manual plus weekly telephone consultation (15–20 min), or a waiting-list control group. Treatment outcome was evaluated with daily sleep diaries and different questionnaires. Treatment was implemented over a 6-week period. Participants in both treatment groups were mailed one booklet per week, with each booklet introducing a new treatment component, its rationale, and methods to foster its implementation. Treatment components included basic information about sleep and sleep hygiene, stimulus control, sleep restriction, cognitive therapy, methods for discontinuing sleep medications, and relapse prevention. The results showed that sleep efficiency and total sleep time improved significantly at the end of treatment for both self-help conditions, and that therapeutic gains were well maintained at the 3-month follow-up evaluation. The addition of a weekly telephone consultation enhanced outcome at posttreatment but not at follow-up.

Taken together, the results of these five studies support the efficacy of insomnia treatment implemented in a self-help format. This approach may therefore be considered as a useful and cost-effective alternative to therapist-led treatments. It is important to note, however, that several factors may moderate the efficacy of self-help treatment, including the individuals' age, the use of sleep medications, the presence of medical or psychological factors (e.g., generalized anxiety disorder, depression) and, naturally, the individuals' willingness to comply with behavioral procedures. Older adults are more likely to suffer from sleep disturbances complicated by medical factors and may require a more thorough evaluation before undertaking a self-help treatment

for insomnia. Likewise, individuals who are chronic users of hypnotic medications are more likely to present comorbid anxiety or depressive disorders and may require therapist guidance, both for the initial evaluation and for treatment.

V. ADVANTAGES AND LIMITATIONS OF SELF-HELP APPROACHES

The main advantage of a self-help treatment format for insomnia is that it allows for a greater dissemination of treatment knowledge. The best example of this is with the Dutch television program, which was estimated to reach several thousands of individuals, many of which, might never have sought out treatment for their sleep difficulties. In this regard, it is possible that widespread dissemination of self-help interventions can actually prevent the development of more severe and chronic insomnia. Another advantage of self-help approaches is their low cost, rendering treatment more accessible to individuals who may never have consulted a professional for insomnia because of financial limitations.

Self-help interventions also have several drawbacks. First of all, there is always a danger of self-misdiagnosis. Insomnia can be easily confused with other sleep (e.g., apnea, periodic limb movement) or psychological disorders (e.g., generalized anxiety disorder, depression). In the presence of such disorders, insomnia should not be the initial target of treatment. Second, there is also a risk of inappropriate application of treatment techniques, particularly if the rationale is unknown or misunderstood. The third limitation concerns treatment failure, which can occur either because of misdiagnosis or inappropriate technique application, or because the problem is so severe that the individual is unable to sustain treatment long enough to make any improvement. Regardless of the cause of failure, it may lead to a worsening of the problem and may discourage patients to seek help from a health care professional. Another danger of self-help treatment is that there is no provision for monitoring patient's compliance and for ensuring adequate follow-up.

VI. SUMMARY

Insomnia is often undertreated and behavioral interventions remain underutilized, partly because they are more time-consuming and are not always known or accessible. Self-help behavioral therapies are a cost-

effective alternative to drug therapy for the management of primary insomnia. This type of intervention offers several advantages such as lower costs and greater availability. Treatment information that can be conveyed in a self-help format includes basic facts about sleep and insomnia, standard stimulus control and sleep restriction instructions, relaxation methods, sleep hygiene education, and cognitive restructuring techniques. It cannot be overemphasized that compliance is a critical element for insomnia treatment to be effective, and this is particularly true for self-help approaches. Although guidance from a therapist is not always essential for a self-help method to be effective in improving sleep, it can be particularly useful to enhance motivation and willingness to adhere to the treatment protocol. Professional guidance is more likely to be needed when there is a complicating medical (e.g., chronic pain) or psychiatric condition (e.g., generalized anxiety disorder, depression) or when an individual is using a medication for sleep, because such factors can influence the course and effectiveness of the treatment. It may also be indicated to consult a professional prior to initiating a self-help treatment for insomnia to ensure a proper evaluation and diagnosis. Additional research is needed to determine what is the most adequate administration format (e.g., printed material, audio- or videotapes, Internet), who are the best candidates for this treatment modality, and what are the predictors of the response to self-help treatment for insomnia. More important, it remains to be evaluated whether widespread dissemination of information about healthy sleep habits (through simple self-help programs) could be useful in preventing the development of severe and persist-

ent insomnia in the general population, thus significantly reducing health care costs.

See Also the Following Articles

Behavioral Treatment of Insomnia ■ Bibliotherapy ■ Relaxation Training ■ Self-Control Therapy ■ Self-Help Groups

Further Reading

- Alpers, J., & Biglan, A. (1979). Self-administered treatment of sleep onset insomnia and the importance of age. *Behavior Therapy, 10*, 347–356.
- Bootzin, R. R., Epstein, D., & Wood, J. M. (1991). Stimulus control instructions. In P. Hauri (Ed.), *Case studies in insomnia* (pp. 19–28). New York: Plenum.
- Clum, G. A., & Gould, R. A. (1993). A meta-analysis of self-help treatment approaches. *Clinical Psychology Review, 13*, 169–186.
- Mimeault, V., & Morin, C. M. (1999). Self-help treatment for insomnia: Bibliotherapy with and without professional guidance. *Journal of Consulting and Clinical Psychology, 67*, 511–519.
- Morawetz, D. (1989). Behavioral self-help treatment for insomnia: A controlled evaluation. *Behavior Therapy, 20*, 365–379.
- Morin, C. M. (1993). *Insomnia: Psychological assessment and management*. New York: Guilford Press.
- Morin, C. M. (1996). *Relief from insomnia*. New York: Doubleday.
- Oosterhuis, A., & Klip, E. (1993). Behavior therapy without therapists: Treating the complaint of insomnia. *International Journal of Health Sciences, 4*, 27–32.
- Riedel, B. W., Lichstein, K. L., & Dwyer, W. O. (1995). Sleep compression and sleep education for older insomniacs: Self-help versus therapist guidance. *Psychology and Aging, 10*, 54–63.

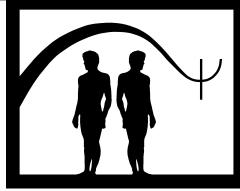

Self Psychology

Arnold Wilson and Nadezhda M.T. Robinson

Columbia University Center for Psychoanalytic Training and Research and St. Mary Hospital

- I. Self Psychology Defined
 - II. Heinz Kohut
 - III. Transformation
 - IV. Summary
- Further Reading

GLOSSARY

empathy A cognitive tool, how a clinician comes to know the internal states of another. Called “vicarious introspection” in the case of the analyst at work, with the aim of understanding another’s experience. Kohut describes empathic ambience as the positive attunement of analyst to analysand and empathic failures as the misattunement of analyst to analysand.

introspection A person’s ability to use self-reflection to know his or her own internal states, including emotions, thoughts, fantasies, and values.

narcissism Used primarily in two ways—first, a way of conceiving of human development, characterized by the growth and stability of the self independent of its transactions with externally experienced others; second, a line of development (vs. a fixed stage or pathological state) characterized by the strivings to form and maintain a vital self. Kohut distinguished between healthy narcissism, a strong and vital self with ambition and ideals striving toward the realization of individual talents and skills, and pathological narcissism wherein self strivings are unsuccessful in maintaining a cohesive and stable self-representation.

self-object The manner by which another is experienced as if that person were an extension of the self and performs functions necessary for the smooth continuity of the func-

tioning of oneself. A self-object relationship aids the experience of the self as cohesive, harmonious, firm in limits of time and space, connected to the past and present. Self-object relationships according to Kohut support mirroring, idealization, twinship, and alterego functions in the development and maintenance of a cohesive self.

transference When the patient responds to the analyst as if the analyst were some significant figure of the patient’s past. Transference provides the self psychologist the means to accurately diagnose the patient’s developmental level.

I. SELF PSYCHOLOGY DEFINED

Self psychology refers to the method, observations, and theory that grew from the novel clinical descriptions put forward by a pioneering psychoanalyst from Chicago, Heinz Kohut, primarily in the late 1960s and 1970s. However, the seeds for the development of self psychology were put in place by Kohut in a seminal 1959 paper titled “Introspection, Empathy, and Psychoanalysis.” In this early paper, Kohut set the groundwork for what was to come by defining the faculties of introspection and empathy as crucial tools and determinants of the clinician in the analytic encounter. Much as an internist uses a stethoscope, an analyst uses introspection and empathy. Introspection was defined as a person’s ability to use self-reflection to know his or her own internal states, including emotions, thoughts, fantasies, and values. By contrast, empathy was defined as “vicarious introspection,” by which Kohut meant a person’s

ability to be cognizant of and accurately apprehend another's mental states, that necessarily involved accessing one's own internal cognitive skills, memories, and emotional states. In defining the arena of psychoanalysis as within the jurisdiction of that which is comprehended by empathy and introspection, Kohut moved psychoanalysis away from a preoccupation with forces, vectors, and structures, and toward subjective states and more explicitly phenomenological processes. It was the "self" rather than a more abstract metapsychological concern that dominated Kohut's thinking, and which was made accessible by introspection and empathy.

How self psychology and classical analysis fit together is a fascinating study of politics in psychoanalysis. In some ways, over the years, self psychology has taken its own path and departed from the mainstream of classical analysis in the United States. However, in other ways, certain key aspects of self psychology have more recently been integrated into the mainstream of classical analysis and has fueled and enriched the entire corpus of contemporary psychoanalytic theory. Thus, although there are many clinicians who think of themselves as "self psychologists," some of the principles of self psychology can now as well be found in the mainstream and are the source of many different and helpful ways of formulating clinical interaction.

II. HEINZ KOHUT

Heinz Kohut was an analyst who emigrated to Chicago from Vienna as a young man. As so many immigrant pioneers in the psychoanalytic movement did, he brought with him the enormous charm and intellectual prowess characteristic of old world scholarship. In a relatively short amount of time, and at a young age, he established himself as one of the leaders of the psychoanalytic world. Trained in analysis at the Chicago Institute, he rapidly rose up in the ranks and was soon to become the leading luminary in the Chicago milieu, the acknowledged leader and pacesetter within that institute. At first a conservative analyst, quite loyal to the tradition of Hartman and ego psychology, he was to break ranks and found the self psychology movement that he came to see was markedly at odds with classical psychoanalysis.

It was largely the description of narcissistic patients that led Kohut to develop his original and, at the time, controversial views. While practicing as a classical analyst, Kohut found that what he called a patients' "self-cohesion" was disrupted when the patient perceived

the analyst to have committed an empathic failure. Kohut came to believe that many failures in analysis were not due to a narcissistic patients' predisposing pathology, but rather to the clinicians' failure to tune in to the analysand's underlying states. Believing that many failures in analysis were due to this factor, Kohut sought to expand the range of patients treatable by psychoanalysis. Although always a controversial topic, prior to Kohut many considered the narcissistic patient untreatable for a variety of reasons attributable to the patient, but rarely the clinician. Most telling, however, was the sense that such patients could not be reached by clinical interpretations, because they would contemptuously reject insight while at the same time displaying characteristics of extreme fragility and hypersensitivity. It was Kohut's inspiration to design a treatment that did not emphasize interpretation and insight, and in so doing, soon was to develop a whole new way of looking at people and the treatment situation. In moving away from interpretation as the primary mutative factor in psychoanalysis, Kohut spoke of "transmuting internalization" as a key concept, when the patient is enabled to take in those experiences that are empathically offered, and then convert them into psychic structure, thereby remediating early developmental failures that had been laying dormant for many years. The concept of transmuting internalization explains how patients change through the provision of empathic ministrations rather than through the acquisition of insight and understanding.

In 1968, Kohut published his first views on narcissistic disorders, which was to lead to his eventual postulate that narcissism was a line of development, rather than a stage, type of energy, or a personality disorder. At first, Kohut sought to meld his views with those of mainstream psychoanalysis. However, as his ideas developed, he perceived the need to carve out an independent niche for self psychology, which took the theoretical form of claiming that a self/narcissistic line of development follows an independent course from what he termed the "object-libidinal" line of development more typically described by classical analysis. Still, in 1971, when his first major book was published, titled *The Analysis of the Self*, it was framed in the patois of classical analysis. In this book, Kohut laid out the fundamentals of his views concerning the treatment of narcissistic patients, including transference and countertransference considerations. Most important, the analyst had to maintain an empathic immersion in the psychological field of the patient and tolerate the emptiness of their own emotional reaction to such individuals. What Kohut termed "empathy" was

crucial, for departures from such empathic immersion lead to profound disruptions in the patient's personality, what Kohut called "fragmentation" of the self. The self became the focus of the analyst treating the narcissistic patient, which was phenomenologically closer to clinical experience than the reigning tripartite model of the classical analysts. The patient grew in the crucible of the analyst's empathic immersion, rather than through the analytic imparting of insight by way of interpretation. The actual experience of the clinical interaction became more important than the knowledge that could be deduced from the interaction.

The fragmented self was seen to result from early failures in what Kohut termed "self-object experiences," which were seen as failures in caregivers' empathic relationship to their children and which tended to get covered over by what Kohut termed the "compensatory structures" of development, that is, defense-like structures that covered over and protected the individuals' self-esteem from these early deficits. Although covered over by subsequent life span experiences, such early failures lurked in the personality of the child and could only be altered through an isomorphic reevocation of the early self-object experience, which Kohut termed a "self-object transference." In particular, he identified two kinds of self-object transference, an idealizing and a grandiose one. Loosely speaking, the idealizing transference can be equated with paternal object relations and the grandiose transference with maternal object relations. The idealized self-object transference referred to the normative need of a child to see the other in perfectionistic terms. The grandiose self-object transference referred to the normative need of a child to experience themselves as omnipotent as mirrored by a caregiver. Eagle has critically written about a developmental psychology based solely on these two types of reconstructed transference configurations. Over the years, Kohut's vision of the child embedded in a world of self-objects has held up to research scrutiny far better than his description of these two types of transferences, which were reconstructed from the analytic situation of adults rather than actually observed in the behaviors of children and their caregivers.

Note again the emphasis on the concept of "self" in Kohut's thinking. The self is quite different than the ego of Freud. Kohut thought of the self and defined it as the center of initiative and action. The self develops through experiences of being independent, mirrored properly, and empathically understood until "self-cohesion" has formed. Self-cohesion is the term Kohut chose to describe the self of an emotionally strong, vig-

orous, expansive, and resilient person. The developing self is understood as potentially traumatized through subtle ways, such as a caregiver's rigidity, lack of empathy, or inability to affectively attune to a growing child. The child is seen as formed into a world of self-objects and is natively happy and prone to fit into such relationship patterns. The mind of the child is more akin to a tabula rosa than that described in classical analysis—children are born good and made bad, rather than inevitably suffering from the frustrations and limitations of intrapsychic conflicts as implied by an epigenetic psychobiological blueprint. This self psychology take on early development is in stark contrast to the classical view of trauma, which is understood more explicitly as an external assault on a psychic apparatus incapable of withstanding overstimulation, understimulation, and affective regulation.

The reception to his 1971 book was mixed. As Kohut inquired deeper and his clinical experience deepened, he felt the need to expand the scope of his investigations. As a consequence, Kohut began to describe what he called "the psychology of the self in the wider sense" that referred to a vision of self psychology as an approach to most patients, not just narcissistic ones (and which he contrasted with the "psychology of the self in the narrow sense"). Encouraged by many of his early followers in Chicago and elsewhere, such as Paul and Anna Ornstein, John Gedo (who was soon to break from this group), Arnold Goldberg, Michael Basch, Marian Tolpin, Joseph Lichtenberg, and Ernest Wolf, self psychology became a movement in its own right. In 1976, Kohut published a book titled *The Restoration of the Self* that became a virtual manifesto of this new movement. No longer seeking a rapprochement with classical analysis, a new vocabulary and new way of looking at virtually all clinical phenomena was born. It was also only a short amount of time before self psychology was to expand far beyond the frontiers of four to five times a week clinical psychoanalysis and become a treatment modality and method of investigation that addressed and incorporated psychotherapy, brief treatments, informed a tremendous amount of research, as well as a remarkable fecundity of applied psychoanalysis (art, history, politics, and literature). Reaching far beyond the borders of Chicago, self psychology became an international movement with chapters worldwide. It also was picked up by many nonmedical practitioners, who sensed a sympathetic and compatible view of people and treatment that they found lacking elsewhere.

As mentioned, in a subtle shift, self psychology overtly became a method of investigation into narcissism as a

line of development rather than as a type of personality disorder. The narcissistic line of development was defined as the relationship of the self to the self, and the object-libidinal line as the relationship of the self to the other. Individuals were seen as growing up among and requiring self-object relationships of all sorts. The self was not seen as boundary by the skin. Self-objects were defined as environmental objects that fulfilled functions required by the self, and in fact were experienced as if they were a part of the self. Although outside the self, they were experienced as if they were inside. Thus, soothing and/or self-regulating self-objects were sought if an individual did not have internalized capacity for self-soothing or self-regulating; then, these functions were treated as if they were internal although they belonged to someone external. This framed a kind of attachment to others, and so individuals were seen as embedded in a social and interactive matrix far more than classical analysis had emphasized. The classical emphasis on infantile sexuality and aggression was markedly deemphasized, in favor of self cohesion and empathic immersion. Self-objects were also defined as incorporating not necessarily people but also ideas, ideals, and other factors such as goals and values.

In his 1976 book, Kohut also addressed many aspects of the treatment situation that were the pillars of the classical approach; for example, he reexamined the Oedipus Complex and claimed that its turbulence was a “breakdown product” resulting from developmental failures in empathic self-object relations rather than a universal period of conflict stemming from entry into the world of triadic object relations. In a series of sharp exchanges, Kohut and Otto Kernberg, a New York-based analyst with a more classical persuasion, engaged in a scintillating and intriguing series of exchanges concerning the treatment of patients with severe disturbances, particularly those termed borderline. At the time, it was unfortunate that many clinicians perceived a rubicon of sorts between classical analysis and self psychology and were drawn into taking sides. This probably delayed or prevented an integrative assessment of the significance of self psychology, as many felt they either had to reject or accept it in its entirety.

Kohut, after the 1976 book, was yet to publish a great many influential papers. One such paper that has captured the attention of a great many scholars of psychoanalytic history was titled “The Two Analyses of Mr. Z” which he said was his analysis and reanalysis of a particular patient; the first employing the techniques of classical analysis, and a second employing the techniques of self psychology. Needless to say, he reported that the second analysis was far more helpful and

reached areas that the first analysis could not. Kohut reported that it was this analysis that truly opened his eyes to the depths and powers of self psychology. Although this cannot be confirmed, several independent sources hypothesize that Mr. Z. was Kohut himself. The two analyses referred to were actually the two analyses Kohut himself underwent.

III. TRANSFORMATION

Heinz Kohut died in 1981. His last book *How Does Analysis Cure* was published posthumously in 1984. With his death, self psychology underwent a profound transformation, as it became unclear whether it consisted of one theory or many. Clinicians such as Robert Stolorow and colleagues, Arnold Goldberg, Michael Basch, Howard Bacal, and others too numerous to name carried on the tradition. Many went their own way without the unifying force of Kohut’s vision. As the group of adherents to self psychology grew, several individuals worked hard to clarify the specific principles of therapy native to self psychology. Although there was disagreement, the unifying thread seems to be that the main goal of treatment is to strengthen the sense of self and to facilitate growth. Treatment works to facilitate the latent potential for self-vitalizing experiences, largely through the positive and affirming experiences that take place in the transaction between the therapist and the patient. It did not necessarily require four or five visits per week nor a couch. As the principles of therapy expanded, so to did the theory of self psychology informing treatment. For example, Stolorow went on to elaborate on a worldview he termed “intersubjective.” Goldberg sought something of a rapprochement with classical analysis, emphasizing that interpretation is and always has been the primary instrument of self psychology. Goldberg wrote persuasively of how empathy and introspection alone cannot define the field of psychoanalysis. Basch went on to describe psychoanalysis as “applied developmental psychology” and using a self psychology framework, brought in the method and findings of general psychology (perception, developmental psychology, brain-behavior correlations, etc.) to elaborate upon such issues as empathy, Freud’s corpus of writings, and principles of psychotherapy.

Many of these authors took issue to some extent with some of the basic and fundamental tenets of Kohut’s work. For example, Stolorow criticized Kohut’s model of the bipolar self for having the potential for reification of self-experience, for mechanistic thinking, and for limiting the number of potential self-object transferences that

can be found in the clinical situation. Basch also criticized the notion of the bipolar self and replaced it with his own version of a functional self-system, with a brain psychology integrating the affective and cognitive information processing activities governing the individual's adaptation to the environment. Bacal argues that self psychology is in reality an object-relations theory, and that the self-object transference is itself a particular type of object relationship; Kohut was explicit that he was not defining an object-relational psychology, which he pejoratively referred to as a "social psychology" that was outside of the arena of psychoanalysis.

As previously touched on, self psychology was informed by and spawned a significant amount of empirical research, particularly in developmental psychology. In many ways, the pioneering research of Daniel Stern in the early 1980s that pointed toward an interactive baby swept up in developmental currents was closer to Kohut's reconstruction of childhood than the child of classical analysis. Relationships rather than intrapsychic conflicts assumed a research priority. Other developmentalists, such as Louis Sander, Edward Tronick, and Beatrice Beebe, found the inspiration and a model in Kohut's description of childhood that fostered a great deal of creativity in their empirical research. Joseph Lichtenberg, himself not an infant researcher, was particularly active in conceptually seeking to integrate experimental and observational infant research with self psychology. Eventually, he was to go on to describe five motivational systems as the engine of action in self psychology, roughly equated with the drives in classical analysis. In several important publications, he described principles of treatments for the self psychological perspective that utilized his notion of these five motivational systems. Certainly one major advantage of these five motivational systems was their grounding in the developmental literature of the time, which in some people's view provided for a scientific grounding that could not be found in Freud's psychology of personality.

Self psychology was to develop its own diagnostic system (a kind of nomenclature) quite different from any other. A good example is depression. Many self psychologists spoke of "empty depression," a sort of experience of depletion or lack of vitality that characterize a sense of futility in connecting with others. Others were concerned with severely disturbed patients. They addressed how patients can develop the all-important capacity to sustain a stable self-object transference and defined this as the border between narcissistic and borderline states. Each has characteristic treatment implications in the self psychology diagnostic nomenclature. In borderline states, the transference was not

stable, and "secondary compensatory structures" interfered too readily, so as to make such an individual not amenable to analysis (although, to be sure, psychotherapy could be embarked on with such individuals). Narcissistic states could thus best be diagnosed from an assessment of the transference, rather than from stable intrapsychic personality factors standing apart from the treatment situation. A very important step became the articulation of translation rules from the diagnostic nomenclature of self psychology to others in the psychodynamic arena thinking and practicing with a different theoretical frame of reference. In many ways, this is a work still in progress.

The study of dreams became a focus of self psychology as it expanded its network of influence. Some self psychologists expanded upon Kohut's notion of a "self-state dream." Whereas classical analysis looked for infantile wish fulfillments lurking within the patient's associations to the manifest content of a dream, self psychology looked for "self-states" in dreams that provided an indication of the patient's sense of connection, mood, and integration. Ernest Wolf, a colleague of Kohut's in Chicago, was one of the first to investigate the self psychology construal of dreams and the departure therein from the prevailing classical analytic theory dating back to Freud's revolutionary portrayal of the role and functions of dreams.

IV. SUMMARY

As is true for many branches of contemporary psychoanalysis, self psychology at present is in a state of flux. In the classical world, it is certainly clear that after an initial period of rejection, many of Kohut's ideas have found their way into the mainstream. For example, Kohut's observations concerning the fragility of the narcissistic person and the need not to interpret transference early on until the patient is able to make constructive use of it now seems to be the dominant view in classical theory. Many classical analysts, such as Evelyn Schwaber, have described how they proceed by always assuming that the patient's perceptions are primary, and that empathically the analyst must always understand the world as seen through the eyes of the patient. Such sensitivity to the subjective states of the patient is an example of the type of technical advancements attributable to Kohut's writings and influence. It is unclear, looking toward the future, whether self psychology will continue as a monolithic tradition, become a loose confederation of post-Kohutian psychologies, or proceed apace toward an integration with the very same points of view it rejected

40 years earlier to make its own way in the evolving psychoanalytic tradition.

See Also the Following Articles

Relational Psychoanalysis ■ Self-Control Desensitization ■ Self-Control Therapy ■ Self-Help Groups ■ Self-Statement Modification

Further Reading

Basch, M. (1977). Developmental psychology and explanatory theory in psychoanalysis. *The Annual of Psychoanalysis*, 5, 229–263.

Basch, M. (1983). Empathic understanding: A review of the concept and some theoretical considerations. *Journal of the American Psychoanalytic Association*, 31, 101–127.

Goldberg, A. (1989). *A fresh look at psychoanalysis: The view from self psychology*. Hillsdale, NJ: The Analytic Press.

Kohut H. (1971). *The analysis of the self*. New York: International Universities Press.

Kohut H. (1977). *The restoration of the self*. New York: International Universities Press.

Kohut H. (1984). *How does analysis cure?* Chicago: University of Chicago Press.

Lichtenberg, J. (1989). *Psychoanalysis and motivation*. Hillsdale, N.J.: The Analytic Press.

Wolf, E. (1989). *Treating the self*. New York: Guilford.

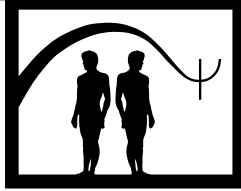

Self-Punishment

Rosiana L. Azman

University of Hawaii, Manoa

- I. Description
- II. Theoretical Basis: A Behavioral Perspective
- III. Empirical Studies
- IV. Summary
- Further Reading

GLOSSARY

extinction The weakening of a behavior by withdrawing reinforcement.

learning theory Pertaining to learning through classical conditioning, operant conditioning, or modeling.

reinforcement The presentation of a positive stimulus or the removal of a negative stimulus to increase a desired behavior.

Self-punishment is a behavior in which a person is responsible for removing a positive stimulus or presenting an aversive stimulus to himself to decrease an undesired behavior. This article explains the concept of self-punishment, its behavioral underpinnings, and the limits to its effectiveness.

I. DESCRIPTION

To most people, punishment tends to be equated with a harsh consequence that is expected to teach a lesson, whether it is a part of childrearing, education,

or civil law. A child may be grounded for missing curfew, a student kept in for recess because she failed to complete her homework assignment, or a criminal sentenced to jail for committing a felony. This definition, although adequate for everyday usage, is insufficient to describe the psychological connotations.

Behavioral psychologists, and others familiar with learning theory, appreciate punishment to be the presentation of a negative stimulus or the removal of a positive stimulus so that a particular undesired behavior will be decreased. The lay definition may include the aversive situation that comes with either the presentation of a negative stimulus or the removal of a positive one, but it is often irrelevant as to whether or not the behavior being punished will likely be deterred.

For persons to engage in self-punishment means that they are responsible for implementing the appropriate consequences without external support. For example, if a student tends to daydream while studying, a self-punishment tactic she could use to keep herself from going off-task would be to cancel her usual evening phone call with her best friend whenever she catches herself daydreaming (removal of a positive stimulus). The girl's decision not to call her friend must be self-generated for it to be self-punishment. Should her father revoke her phone privileges whenever she daydreams, it would be an external form of punishment. Similarly, every time a man deviates from his diet by eating fast food he could punish himself by having to drink an extra serving of wheat grass juice (presentation

of an aversive stimulus) instead of having a fruit smoothie (removal of a positive stimulus). If his wife decides that he cannot eat dessert after dinner, it would be external punishment.

II. THEORETICAL BASIS: A BEHAVIORAL PERSPECTIVE

In behavioral psychology, three possible events other than punishment can follow a behavior: negative reinforcement, positive reinforcement, or extinction. Punishment should not be confused with negative reinforcement, which is the removal of an aversive stimulus to increase a desired behavior. Although homework is not designed to be an aversive stimulus, most students would insist otherwise because they have other tasks on which they would much rather spend their time. Therefore, a teacher could negatively reinforce students to participate in class discussions by canceling the homework assignment whenever the entire class actively participates. Another example of negative reinforcement would be the use of an umbrella during a rainstorm: the action of opening the umbrella removes the negative stimulus of becoming wet. Therefore, this reinforces the use of an umbrella when it rains.

Positive reinforcement also serves to increase a desired behavior, but it is achieved by presenting a positive stimulus after a desired response. The term reward is often equated with a positive reinforcement, although it is important to keep in mind that a reward in lay vernacular does not necessarily imply a positive reinforcement. For example, a person may receive a monetary reward for finding a lost pet. The money is meant as a gesture of gratitude, not as a means to induce a person to continue to find more lost pets. In the true psychological sense of the concept, a child who is rewarded with praise and congratulations from his parents for earning good grades at school is likely to continue to earn good grades so that he may continue to receive the positive parental reinforcement.

Extinction is often confused with punishment because it also involves the removal of a particular stimulus to weaken or decrease a behavior. However, extinction is the decrease of a behavior that had been previously learned. A rat could be trained not to press a lever if he no longer receives food pellets with every depression. The rat must have been originally trained to receive the pellets as positive reinforcers for this action to be interpreted as becoming extinguished. Had the action not been trained, it would more likely be interpreted as punishment when the pellets were not supplied.

Extinction is much more complicated in real-life situations than it is in the laboratory. The withdrawal of reinforcers tends to result in the immediate eruption of the undesired behavior. In addition, even if the original behavior has abated, other unexpected patterns of behavior may surface that prove equally problematic. For example, persons who are attempting to quit smoking may use nicotine gum to decrease the number of cigarettes smoked. Eventually, the use of the nicotine gum must also be eliminated, but it is quite possible that they will have uncontrollable nicotine cravings and smoke cigarettes because they no longer have the consolation of the gum.

Extinction is also difficult to implement in nonlaboratory settings because the stimuli that reinforce the undesired behavior are not always known, nor are they easily controlled. It is common for students to misbehave in class because of peer reaction. If a young boy sneaks a frog into the classroom, supportive students will applaud and others will most likely scream, but both reactions serve to reinforce the student for his deed by bringing attention to him. It would be possible although most likely difficult for a teacher to instruct students not to be supportive of such a disruptive act, but it would be even more difficult to tell others not to be afraid. Unless both forms of reinforcement are removed, the behavior cannot be extinguished.

The main problem with any form of punishment is that it does not teach a desired behavior. By definition, it only decreases an unwanted behavior; it does not increase the behavior that is wanted. If you are trying to teach your child to eat all his vegetables at dinner, scolding him when he hides his brussels sprouts in his napkin will not necessarily make him eat his brussels sprouts on a future occasion. Instead, he will find other means to avoid eating his vegetables. Similarly, punishing yourself whenever you eat junk food will not necessarily cause you to eat more healthily.

Punishment can be quite helpful when you are trying to decrease a particular behavior instantly. If you punish your child immediately after he has run into the street, it is likely that you have deterred that dangerous behavior from occurring again. It does not mean, however, that your child will angelically walk alongside you from that point forward. It simply means he will not run into the street again.

With all forms of reinforcement, and punishment, it is important for the ensuing action to be immediate, strong, and consistent. It is difficult to learn a new behavior or terminate an old behavior if the consequences are not easily discerned. It was quite common several decades ago for fathers to be the disciplinarian

of the household. When children misbehaved early in the day, they would often have to wait several hours until their father came home before they were punished for their bad behavior making it difficult for them to associate their punishment with their earlier misbehavior. Instead, they would probably associate their punishment with their father coming home, and learn to fear the return of their father, instead of learning not to misbehave.

Delayed or inconsistent self-punishment would yield similar results. Suppose you are trying to teach yourself not to skip classes. You could tell yourself that every time you fail to attend a class, you would punish yourself by having to spend an extra hour in the library studying. This form of punishment is not likely to be successful because the punishment would not be immediate. For example, because it is such a beautiful day you decide to go to the beach instead of attending class. As you reach that decision, you tell yourself that you will go to the library that night for 3 hrs instead of two because of your truancy. Not only would your punishment be far removed from the misbehavior, but you have also unintentionally positively self-reinforced yourself for missing class by enjoying yourself at the beach. The positive stimulus immediately followed the decision to be truant; therefore, you are more likely to have trained yourself to skip class more often, the exact opposite of your original intentions.

III. EMPIRICAL STUDIES

There is limited evidence that self-punishment, used alone, is an effective method to change one's behavior. In fact, some research even suggests that more harm than good tends to come from self-punishment. In her doctoral dissertation, Sister Mary of St. Victoria Andreoli, R.G.S. found a strong positive correlation between self-punishment and later propensities to be aggressive toward others.

Many therapists have tried to use self-punishment to stop clients from smoking or from overeating. Clients are often instructed to pay a fine (removal of positive stimulus) whenever they engage in the unwanted behavior. Although this form of self-punishment avoids the ethical concerns associated with the presentation of a negative stimulus, M. J. Mahoney, N.G.M. Moura, and T. C. Wade found in 1973 that forcing someone to give up something of value was not an entirely effective means to deter a behavior.

In a study by M. J. Mahoney in 1971, a client was instructed to snap a large rubber band that was worn

around his wrist to decrease the target behavior. This form of self-punishment did prove effective but not because of the presentation of mild pain (aversive stimulus). The punishment interrupted the misbehavior, which then alerted the client to regulate his actions.

W. H. Morse and R. T. Kelleher found that punishment should supplement programs that utilize reinforcement. The punishment can decrease the acute problematic behavior while the reinforcement supports the desired behavior. For example, if parents are trying to convince their teenage son to wear his seatbelt when he drives his car, they should revoke his driving privileges (removal of positive stimulus) whenever he is caught without his seatbelt. They should also extend his curfew (positive reinforcement) whenever he does remember to buckle up without inducement. This theory can be extended to apply to self-punishment. Using self-reinforcement in lieu of or in conjunction with self-punishment punishment would prove more effective. In his study, "Coping with temptations to smoke," Saul Shiffman found that people who used strategies other than self-punishing thoughts resisted the urge to smoke more than their self-punishing counterparts.

IV. SUMMARY

Punishment in any form is not a completely ineffective method to change one's behavior. However, given that it can only decrease a particular action, also engaging in a form of reinforcement would prove more logical and efficient. Although not many studies have been done directly on the concept of self-punishment, it is not unreasonable to extend findings from studies on punishment and apply them to self-punishment. People interested in self-modification will have better results using forms of self-reinforcement than they would if they engage solely in self-punishment.

See Also the Following Articles

Aversion Relief ■ Conditioned Reinforcement ■ Extinction
 ■ Negative Punishment ■ Negative Reinforcement ■
 Positive Punishment ■ Positive Reinforcement ■
 Self Control Therapy ■ Self Psychology

Further Reading

Bufford, R. K. (1981). *The human reflex: Behavioral psychology in biblical perspective*. San Francisco: Harper and Row.

- Seligman, M. E. P. (1994). *What you can change and what you can't: The complete guide to self-improvement*. New York: Knopf.
- Shapiro, E. S., & Cole, C. L. (1994). *Behavior change in the classroom: Self-management interventions*. New York: Guilford Press.
- Shumaker, S. A., Schron, E. B., & Ockene, J. K. (Eds.). (1998). *The handbook of health behavior change*. New York: Springer.
- Watson, D. L., & Tharp, R. G. (2001). *Self-directed behavior: Self-modification for personal adjustment* (8th ed.). Belmont, CA: Wadsworth.

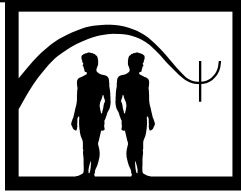

Self-Statement Modification

E. Thomas Dowd

Kent State University

- I. Description of Treatment
 - II. Theoretical Bases
 - III. Empirical Studies
 - IV. Summary
- Further Reading

self-statement The self-verbalizations or self-talk in which people engage, either overtly (aloud) or silently (covertly).

GLOSSARY

cognitive contents The content of people's self-talk; what they think and the sentences they use. They are close to or just below the level of conscious awareness.

cognitive processes The cognitive distortions people use in interpreting sensory data, for example, overgeneralizing, personalization, and dichotomous thinking.

cognitive structures The network of tacit rules and assumptions people use in interpreting the world that are laid down at an early age. They consist of tacit cognitive contents organized around a theme. They are also called core cognitive schemas and consist of unrecognized assumptions about the self and the world, for example, "I'm unlovable."

covert behaviors (or coverants) Behavior (such as internal verbalization) that is observable only to the behaving and observing individual.

internal dialogue A series of automatic self-statements about a situation or behavior.

operant conditioning Consequential learning based on reinforcement, which increases subsequent behavior, or punishment, which decreases it.

self-instructional training (SIT) A training package that trains people how to assess what they are saying to themselves and then to modify what they say to themselves to overcome behavioral difficulties.

I. DESCRIPTION OF TREATMENT

Self-statement modification is rarely attempted alone; rather it is generally presented as one component of a treatment package that includes other therapeutic ingredients such as modeling, role-playing, behavioral rehearsal, verbal reinforcement, problem-solving, or social skills training. There are two parts of self-statement modification, the assessment of maladaptive self-statements and the learning and production of new, more adaptive self-statements.

There are several methods for assessing self-statements, which were described (in another context) by Dowd in 1995. Interview-based methods include "think-aloud methods" (in which clients are instructed for a period of time to verbalize whatever comes to mind), "thought-listing" (in which clients list for a period of time whatever thoughts they might have had about a specific situation), "prompted recall" (in which clients view a video or audiotape of them in a problematic situation and indicate what their thoughts were at certain times), and "imagery assessment" (in which clients are asked about images they had during problematic situations). Questionnaire methods include such instruments as the Assertive Self-Statement Test (ASST), the Social Interaction Self-Statement Test (SISST), the Automatic Thoughts

Questionnaire (ATQ), the Dysfunctional Styles Questionnaire (ASQ), and the Irrational Beliefs Test (IBT). Some of these assess attitudes at least as much as self-statements but there is no clear demarcation between the two.

Once the maladaptive self-statements have been identified, clients are then taught to emit adaptive or coping self-statements in place of the maladaptive ones. Following the developmental theory of Luria and Vygotsky, Meichenbaum and Goodman in 1971 developed the prototype of the modification of self-statements:

First, E (*experimenter, therapist*) performed a task talking aloud while S (*subject, client*) observed (E acted as a model); then S performed the same task while E instructed S aloud; then S was asked to perform the task again while instructing himself aloud; then S performed the task while whispering to himself (lip movements); and finally S performed the task covertly (without lip movements). (p. 117, italics added)

Thus, the therapist gradually takes clients from overt verbalization of the new self-statements to covert verbalization, recapitulating the development of private speech or self-statements in children.

Examples of maladaptive self-statements might be, "I'll never be able to do this task!", "I just don't have what it takes!", "I'm not as smart as other people." Examples of coping or adaptive self-statements might be, "I can develop a plan to handle this," "I can do it if I slow down and take it one step at a time," "Just relax and let the fear subside," or "It worked! I did it — not perfectly but pretty good!"

As with other therapeutic procedures, repetition is very important in self-statement modification. People do not easily or quickly change long-entrenched and automatic ways of responding, including self-statements. Often they are not even aware of their self-talk until after it has occurred and sometimes not even then, even with therapist prompting. Practice outside of therapy as well as during the sessions is important for sustained progress.

II. THEORETICAL BASES

Self-statements are a universal aspect of human cognitive function and their modification is an important part of cognitive behavior therapy procedures. Indeed they are found in all of the important Cognitive-behavior therapy (CBT) interventions, although often by different names. Self-statements are the statements that people say to themselves in a variety of situations and they can be either positive or negative. Sometimes they are within the area of conscious recollection although often they

are not; that is, we sometimes recognize that we are making these statements while much of the time we do not.

Self-statements are similar in many ways to the automatic thoughts of Aaron T. Beck's cognitive therapy, to the irrational thoughts of Albert Ellis's rational-emotive-behavior therapy, to Marvin Goldfried's cognitive (or rational) restructuring, and to Daniel Araoz's negative self-hypnosis. What they all have in common is an assessment and modification of the covert self-talk that lies at and just below the level of conscious awareness. They are what Meichenbaum and Gilmore refer to as "cognitive contents," or the actual content of our cognitive processes. Perhaps because self-statement modification is functionally similar to or part of other CBT procedures, some writers have not clearly distinguished it from other CBT procedures, such as self-instructional training, cognitive restructuring, rational disputing, and imagery work. It has therefore appeared on occasion that the differences among them are insignificant. Nevertheless, there are distinctions. The automatic thoughts in Beck's cognitive therapy are more idiosyncratic in nature than the more standard irrational thoughts of Ellis. Cognitive restructuring is a more generic term for a set of techniques. Hypnosis and imagery work represent a class of more nonverbal techniques.

Perhaps the best theoretical development of self-statement modification can be found in the self-instructional training (SIT) of Donald Meichenbaum. Meichenbaum based his work on both behavioral and developmental theories, out of which he derived his own cognitive theory of change. His early work in cognitive behavior modification was based primarily on self-statement modification with impulsive children in order to reduce their level of impulsivity. Behaviorally, he considered self-statements to be examples of covert behaviors, subject to the same laws of learning and modification as other behaviors. Generally, the theoretical basis for these laws was operant conditioning. In this, he followed Lloyd Homme's notion of coverants (or covert operants/behaviors) as obeying the same laws as overt behaviors. Covert behavior was reinforced or punished according to the same principles as overt behavior. Developmentally, he referred to the work of the Soviet psychologists Alexander Luria and Lev Vygotsky, who viewed the internalization of self-statements as fundamental to the human development of self-control and regulation of behavior. Luria and Vygotsky argued that self-statements in young children are first overt in nature and mimic the overt talk of significant adults. Later, the child's self-statements become covertly subvocalized and then entirely automatic and nonconscious in nature. It is these automatic thoughts or self-statements

that result in adult behavioral regulation. Children who do not internalize these self-statements have difficulty with self-regulation (most obviously in impulsivity) but internalization of maladaptive self-statements can result in later psychological problems.

Meichenbaum's cognitive theory of change has three phases. The first phase is self-observation, in which clients first become aware of their own behavior. They begin to monitor, with increasing accuracy, their own thoughts, feelings, physiological reactions, and interpersonal behavior. They gradually become aware that their self-statements (internal dialogue) are negative, repetitive, and unproductive and come to reconceptualize or redefine their problems, in part according to the theoretical orientation of the therapist. Thus, the client of a psychoanalyst may come to see his problems as stemming from his early relations with his father while the client of a behavior therapist may come to see her problems as arising from inadequate reinforcement for exploratory behavior as a child. In the process, both gain understanding (and therefore control and hope) of their feelings, behaviors, and thoughts. They begin the process of thinking differently about their problems.

The second phase is incompatible thoughts and observations. Here, as a result of the observations in Phase One, clients begin a translation process from the maladaptive internal dialogue to a more adaptive internal dialogue. They begin to reconceptualize their problems differently. The new internal dialogue affects their attention, their appraisals, their physiological responses, and even instigates new behavior. The increased attention in Phase One helps change the internal dialogue in Phase Two, which in turn guides new behavior.

The third phase is the development of new cognitions about change. In this phase, clients begin a new internal dialogue about the changes they have been undergoing and the new behaviors they have been producing. These changes provide evidence for a change in self-statements that make up the internal dialogue. If their interactions with other people change, they will then reflect on this in their changed internal dialogue. The modified internal dialogue is similar to what in other systems might be referred to as "insight." In other words, behavior change precedes insight, rather than following it, a point made in 1962 by Nicholas Hobbs.

The implication of this theory of change is that therapeutic interventions might profitably focus first on instigating behavior change and then fostering cognitive change as clients reflect on their behavioral change and its implications. But cognitive therapists in general have often focused first on changing cognitive contents (self-statements) or cognitive processes (cognitive dis-

tortions). Indeed, Jeffery Young, in his schema-focused therapy, focuses on cognitive structures, or the network of rules and assumptions that determine how we interpret the world.

III. EMPIRICAL STUDIES

There has been considerable research conducted on self-statement modification, even within relatively recent years. Two meta-analyses of the effects of self-statement modification were published by Dush, Hirt, and Schroeder, in 1983 and 1989, one on adults and the other on children. In the adult meta-analysis, the results for self-statement modification were impressive. Self-statement modification produced a greater effect size than alternative therapies when compared both to no-treatment controls and to placebo controls. However, the effect sizes were smaller when compared to placebo controls than to no-treatment controls. The efficacy of self-statement modification was found to be greater when combined with other cognitive-behavioral procedures. Similar results were obtained in the children's meta-analysis. Self-statement modification produced greater effect sizes than either no-treatment controls or placebo controls, although there was no significant difference between the two types of comparisons, indicating that placebo treatment with children may not be more effective than no treatment. Comparing the two meta-analyses, the effect of self-statement modification appeared to be less for children than for adults, especially when compared to no treatment.

A related meta-analysis examining the treatment of impulsivity in children by Baer and Nietzel found comparable results. The interventions were associated with improvements ranging from one-third to three-fourths of a standard deviation when compared to untreated controls. Self-statement modification in these studies was combined with other cognitive-behavioral interventions.

Other studies have found self-statement modification to be effective in preparing patients for various stressful medical procedures such as coping with office routines and illness management, particularly for children. It has also been found to be effective as part of a treatment program for anger management and in treating such problems as heterosexual effectiveness, assertive training, and dating-skills training. Because it has sometimes been evaluated in combination with other CBT techniques, it is not always clear what unique contribution it makes. However, it has been shown to be at least as, if not more, efficacious than alternative treatments.

IV. SUMMARY

Self-statements, positive and negative, appear to be a ubiquitous aspect of human cognitive and developmental functioning and are heavily implicated in self control. Self-statement modification is found in many of the cognitive-behavioral theories, including those of Aaron Beck, Albert Ellis, Marvin Goldfried, and Donald Meichenbaum, and is designed to replace negative self-statements with positive ones. However, it often goes by different names in different theories. Perhaps the fullest and most complete expression of the technique is found in Meichenbaum's self-instructional training. Self-statement modification consists of assessing the self-talk that clients use about a problematic situation and then training them to emit different, more adaptive, self-statements instead. Research has shown that it is a very effective and versatile technique, although it is often used in combination with other techniques.

See Also the Following Articles

Behavior Rehearsal ■ Coverant Control ■ Modeling ■
Objective Assessment ■ Role-Playing ■ Self-Control
Desensitization ■ Self Psychology ■ Vicarious Extinction

Further Reading

- Baer, R. A., & Nietzel, M. T. (1991). Cognitive and behavioral treatment of impulsivity in children: A meta-analytic review of the outcome literature. *Journal of Child Clinical Psychology, 20*, 400–412.
- Dowd, E. T. (1995). Cognitive career assessment: Concepts and applications. *Journal of Career Assessment, 3*, 1–20.
- Dush, D. M., Hirt, M. L., & Schroeder, H. (1983). Self-statement modification with adults: A meta-analysis. *Psychological Bulletin, 94*, 408–422.
- Dush, D. M., Hirt, M. L., & Schroeder, H. E. (1989). Self-statement modification in the treatment of child behavior disorders: A meta-analysis. *Psychological Bulletin, 106*, 97–106.
- Goldfried, M. R., & Davison, G. C. (1994). *Clinical behavior therapy* (2nd ed.). New York: Holt, Rinehart & Winston.
- Kendall, P. C., & Hollon, S. D. (1979). *Cognitive-behavioral interventions: Theory, research, and procedures*. New York: Academic Press.
- Kendall, P. C. & Hollon, S. D. (Eds.). (1981). *Assessment strategies for cognitive-behavioral interventions*. New York: Academic Press.
- Meichenbaum, D. (1977). *Cognitive behavior modification*. New York: Plenum.
- Meichenbaum, D., & Goodman, J. (1971). Training impulsive children to talk to themselves: A means of developing self-control. *Journal of Abnormal Psychology, 77*, 115–126.

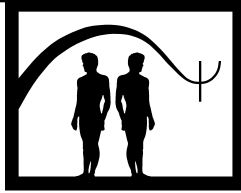

Setting Events

Mark R. Dixon

Southern Illinois University

- I. Description of Treatment
 - II. Theoretical Basis
 - III. Empirical Studies
 - IV. Summary
- Further Reading

GLOSSARY

consequence Any object or event that immediately follows the emission of a response.

discriminative stimulus A stimulus in the presence of which a response is reliably reinforced.

establishing operation A current environmental event, operation, or condition of the organism that alters the relative strength of the discriminative stimulus to control responding.

functional analysis An assessment technique whereby the experimenter directly manipulates potential controlling variables to directly assess their effects on the targeted behavior of interest.

punishment A contingent relationship between a behavior and a behavioral consequence, in which that consequence causes the behavior to decrease in frequency.

reinforcement A contingent relationship between a behavior and a behavioral consequence, in which that consequence causes the behavior to increase in frequency.

I. DESCRIPTION OF TREATMENT

A setting event is a distinct stimulus event or a specific level of a dynamic state of an organism that pre-

cedes and interacts with a particular stimulus and response function. Setting events may momentarily alter the relative control of a discriminative stimulus, resulting in a potentially different response than usually occasioned by that same discriminative stimulus. If a treatment was designed whereby a participant has been trained to emit a vocal response in the presence of a teacher's vocal prompt and subsequently reinforced with praise, the setting event of another person, say the participant's friend, may result in an altered probability of that same vocal response being emitted. In this case the setting event of the friend may result in a higher or lower probability of response emission by the participant. The relative change in response probability is a function of the participant's past history of reinforcement or punishment for similar responses in the context of that setting event. Assuming that the participant has been reliably reinforced for emitting a vocal response following a vocal prompt of the teacher, if now exposed to a similar situation where the friend is present he fails to emit the correct response. The occasioning ability of the teacher's prompt and the reinforcing function of the teacher's praise has been momentarily weakened in the presence of the participant's friend. Figure 1 provides a visual illustration of this example.

In order to establish new behaviors most effectively, one should be aware of the potential influence of setting events on a given treatment approach. Several variables will enhance the likelihood that the resulting treatment will be successful. First, attempts should be made to incorporate into treatment those setting

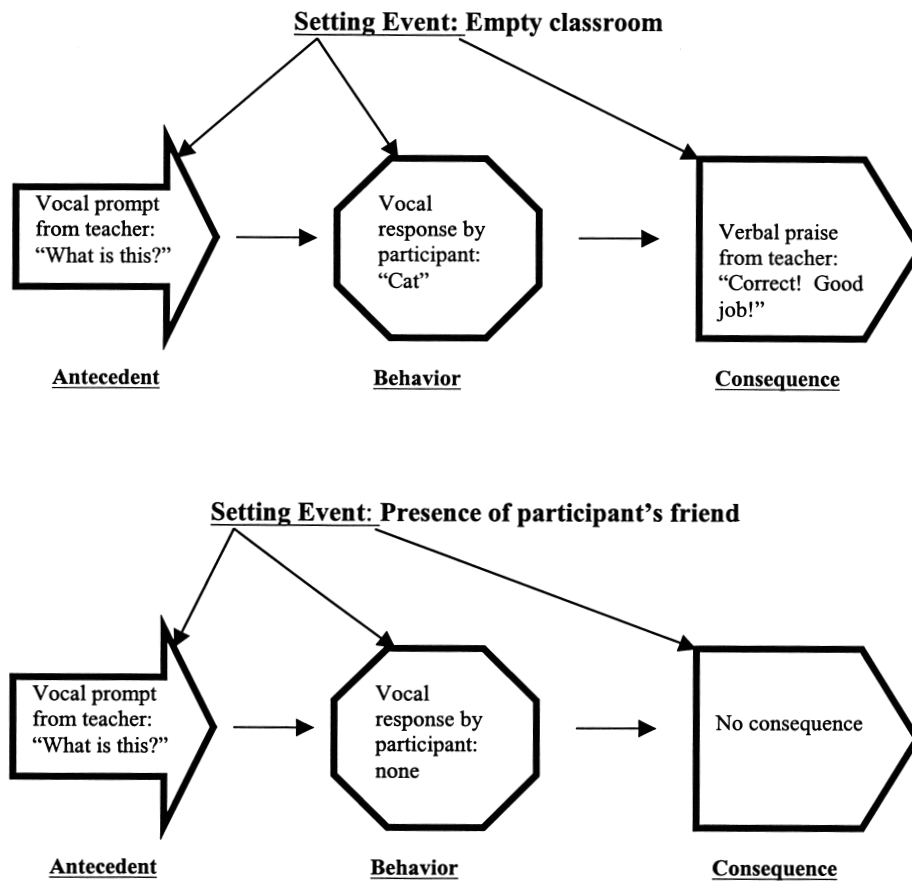

FIGURE 1 Conceptual illustration of the potential influence of a given setting event.

events that have been associated with increased emission of the desired response and eliminate those setting events that have been associated with decreased response emission. Proper identification of the relevant characteristics of the participant's environment that may be functioning as such setting events might be accomplished via an interview with relevant persons, direct observation, or a functional analysis. Second, it should not be assumed that a particular setting event will be directly observable or in temporal proximity to the stimulus-response function question. Setting events such as food deprivation, a fight with a spouse, and stomach pains may either be unobservable or currently absent from the immediate setting. In such cases, proper identification is still possible, yet may require additional exploration. Third, when the elimination of setting events that reduce the probability of treatment success are not possible, one should attempt to minimize their effect. This might be done by withholding the discriminative stimulus, which

will now not occasion the appropriate response, providing additional discriminative stimuli for the appropriate response, or altering the magnitude, density, or salience of the reinforcement to be delivered contingent for the appropriate response. In the earlier example this might consist of the teacher not prompting the participant for a vocal response until his friend leaves the training environment, the teacher providing additional prompts such as "Show your friend how much you know" before presenting the original discriminative stimulus prompt, or the teacher providing a piece of candy coupled with praise as the consequence for a correct vocal response.

II. THEORETICAL BASIS

The concept of setting event was theoretically discussed as early as 1959 by J. R. Kantor, under the name "setting factors." He conceptualized the setting factor as

a general circumstance surrounding the interaction between the stimulus and the response. According to Kantor, the setting may have an effect on the stimulus object, the reacting individual, or the interaction between the two. The role of the setting factor was to facilitate or hinder the occurrence of the particular stimulus–response function. Although the original name has changed in contemporary discourse from “factors” to “event,” the theoretical role it plays on subsequent behavior has not.

The notion of setting event is often added to theoretical conceptualizations of the traditional three-term contingency of (1) discriminative stimulus, (2) response, and (3) consequence, to aid in accounting for the periodic variability in otherwise assumed predictable responding. Setting events differ from other conceptualizations of an additional influence on the three-term contingency in terms of their scope. Setting events can be present in the current environmental context such as the case with food deprivation prior to meal time, yet they can also be somewhat removed in time such as the case with engagement in strenuous exercise the day before coming to therapy, or getting a traffic ticket on the way to work. The former example of food deprivation might be theoretically equivalent to the notion of an establishing operation, although the latter examples would not. Yet all three might exert some change in control over responding. In general the conceptualization of a setting event is broad and not limited by space–time proximity to a current emission of a participant’s behavior.

Additionally setting events may take the form of complete stimulus–response interactions that also affect other stimulus–response interactions that follow it. In other words, the setting event may be both an environmental event and the participant’s response to that event. For example, assume a college student whose studying behavior in her room is typically followed the next day by exceptional test performance, is now interrupted from studying in her room throughout the night by her brother’s playing of the drums downstairs. The no studying–being in her room interaction serves as a setting event for bad test performance the next day. Here it is the case that the previous night’s stimulus–response interaction has a latter effect on observed behavior the next day.

Setting events influencing control over behavior can be identified in ways theoretically similar to those of discriminative stimuli and/or reinforcing consequences. One form of potential identification is through an interview or a rating scale. Caregivers or those known to the participant might be surveyed for potential awareness of the presence of a given setting event. These might in-

clude questions regarding the participant’s daily sleep or eating patterns, medication changes, experience of recent traumatic life events, and the presence or absence of particular persons in a given setting. The interview or rating scale is a cost- and time-effective method for potential setting event identification. This method is also prone to potential problems. First, the skill of the interviewer must be such that appropriate questions are answered. Second, accuracy of responses is subject to the interviewee’s ability to remember specific events. Third, the responses will provide correlated and anecdotal information at best. Current control by a specific setting event may or may not be identical to what has been post hoc reported.

Another form of identification is through observation. The clinician or the participant directly observes the behavior of interest and records current features of the present context that may be in part functioning as a setting event. In the case of the clinician, he or she might have a checklist or scorecard whereby a checkmark or tally is made when the observed behavior is emitted (or not emitted) by the participant in the presence of certain conditions. Self-monitoring might also be conducted whereby the participant attempts to observe and record data on their own behavior and its relation to potential setting events. Self-monitoring is useful when direct observation by another party is limited or not possible. One should keep in mind that accuracy is questionable with self-monitoring. Without contingencies in place to ensure reliability of data collection, there may be incentives for the participant to inaccurately report the presence of a specific setting event. An example here might be a participant who just experienced a toileting accident and fails to record it on her daily tracking sheet of self-initiated activities outside of the house because she is embarrassed.

Like interviews and rating scales, the direct observation of setting events has potential problems. First, observers might not properly identify all relevant setting events. This is especially true when setting events are not in close temporal or spatial proximity to the behavior of interest or when they are covert events such as headaches, feelings of depression, or food deprivation. Second, direct observation is very time consuming to effectively train observers. Third, direct observation will only provide correlational data on the potential effects of a particular setting event. Causal inferences are not possible.

A last form of identification is through experimental manipulation. This technique is often termed functional analysis. A functional analysis assessment would

require the clinician manipulate directly the presence or absence of a particular setting event and then assess subsequent performance. From experimental manipulation, causal inferences can be made about the relative contribution of an assumed setting event on a targeted behavior. For example, if it is assumed that the administration of a given drug to a participant is responsible for that participant's aggressive behavior at the workplace when prompted to complete tasks, the clinician might withhold drug administration on certain days to determine if drug-free days differ from drug-induced days' levels of aggressive behavior.

As with the previously mentioned methods, there also are potential problems in the functional assessment strategy for identification of setting events. Problems include the extensive time and cost for training of clinicians to identify and subsequently manipulate variables, as well as the increased ethical concerns regarding intensifying or postponing treatment for a problematic behavior. In summary, the clinician should use the assessment method for identifying potential setting events that is best suited for the individual circumstances, and be aware of and attempt to control for potential problems with its implementation.

Through the adoption of a theoretical perspective whereby setting events might influence stimulus–response relationships, and upon the utilization of appropriate identification techniques for such setting events, clinicians might eventually accomplish more effective treatments for the participants they serve.

III. EMPIRICAL STUDIES

The following empirical studies demonstrate that through proper identification and manipulation of a particular setting event(s), one can alter the strength of a stimulus–response relationship. Proper techniques should enhance treatment success.

For example, in 1993 Craig Kennedy and Tina Itkonen examined the effects of setting events on the problem behavior of students with severe disabilities. In a series of two studies they examined the relative frequency of problematic behavior occurrences in the presence and in the absence of hypothesized setting events. One of their studies involved a girl who exhibited both aggressive acts during daily transitions and frequent running away or inappropriate grabbing of objects in the presence of dogs, jewelry, or men. The authors assessed possible setting events for these classes of behaviors via a review of the girl's records, a structured

interview, and direct observation of her behavior. Once it was deduced that the potential setting event influencing the occurrence of her inappropriate behaviors was “awakening late in the morning,” a reversal design coupled with a setting event elimination strategy was introduced. The setting event intervention consisted of providing additional incentives for the girl to awake within a set period of time, along with requiring her to shut off her own alarm clock. Resulting frequencies of her problem behavior reduced dramatically upon the removal of the setting event. Similar results were obtained in the authors' second study that involved a girl whose problem behaviors were eliminated upon the removal of the setting event of being transported to school via the city streets. Here the intervention was simply to transport the girl to school via the highway.

A study conducted in 1997 by Mark O'Reilly demonstrated the correlation between the setting event of otitis media (a recurrent or persistent inflammation or infection of the middle ear) and episodic self-injury in a 26-month-old girl with developmental disabilities. In this study, the participant frequently engaged in back banging and ear poking. Upon completion of assessment interviews with the mother and doctor, it was deduced that her problem behavior occurred around 3 to 10 days a month and was thought to correlate with the presence of ear infections. To further investigate these correlations, a comparison across the naturally occurring conditions of ear infected and ear uninfected was conducted. This comparison yielded high rates of problem behavior during most conditions when the girl had an ear infection, and no rates of the problem behavior when her ears were infection-free. These results led the author to further explore the possibility that the setting event of otitis media might have been enhancing the sensory escape function from noise of the self-abusive behavior. Further functional assessment conditions showed this to be the case.

It is often the case that one particular setting event alters the probability of a given response, as in the above studies. Yet, it may also be possible that a combination of two or more setting events will have a collective effect on behavior. For example, in 1992, Lynette Chandler, Susan Fowler, and Roger Lubeck examined the effects of multiple setting events on the social behavior of preschool children with special needs. In their two studies, they attempted to identify the most optimal combination of setting events to produce the greatest number of social interactions of seven preschoolers. After implementing a series of systematic combinations, they concluded that the ideal combination of setting events to

facilitate peer interactions was (1) the removal of the teacher from the activity location, (2) the inclusion of only a limited number of play materials, and (3) a pairing of the child with a socially skilled playmate.

IV. SUMMARY

Setting events are contextual stimuli that momentarily alter the strength of the relationship between a stimulus and a response. Appropriate identification of setting events can assist the clinician in explanation of potential variability in responding. They can also be useful for the development of more appropriate and effective training opportunities. Reinforcement is not a static process uninfluenced by anything other than a simple discriminative stimulus. Rather, the strength of the discriminative stimulus – response – reinforcement relationship is dynamic. That dynamic relationship is often a direct result of the impact of a given setting event on the current context.

See Also the Following Articles

Forward Chaining ■ Habit Reversal ■ Negative Reinforcement ■ Positive Reinforcement ■ Response Cost

Further Reading

- Kantor, J. R., & Smith, N. (1975). *The science of psychology: An interbehavioral survey*. Chicago, IL: Principia Press.
- Koegel, L. K., & Koegel, R. L. (Ed.). (1996). *Positive behavioral support: Including people with difficult behavior in the community*. Baltimore, MD: Paul H. Brookes.
- O'Donohue, W., & Kichener, E. (Eds.). *Handbook of behaviorism*. New York: Academic Press.
- Sulzer-Azaroff, B., & Mayer, G. R. (Eds.). (1991). *Behavior analysis for lasting change*. Orlando, FL: Holt, Rinehart, & Winston.
- Wahler, R. G., & Fox, J. J. (1981). Setting events in applied behavior analysis: Toward a conceptual and methodological expansion. *Journal of Applied Behavior Analysis*, 14, 327–338.

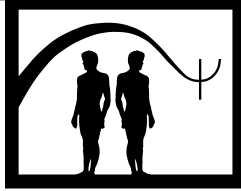

Sex Therapy

Heather J. Meggers and Joseph LoPiccolo

University of Missouri, Columbia

- I. The Evolution of Sex Therapy:
Theoretical Underpinnings
- II. Behavioral, Cognitive, and Systemic Treatment for
Sexual Dysfunctions
- III. Applications and Exclusions
- IV. Empirical Research
Further Reading

GLOSSARY

etiology All of the causes of a disease or abnormal condition.

organic Of, relating to, or arising in a bodily organ; affecting the structure of the organism.

psychogenic Originating in the mind or in mental or emotional conflict.

I. THE EVOLUTION OF SEX THERAPY: THEORETICAL UNDERPINNINGS

A. Early Views of Sexual Dysfunction

Although difficulties with sexual functioning have undoubtedly existed throughout time, early theories of the development and treatment of sexual dysfunctions first began to appear in the late 19th and early 20th centuries. In 1902, Richard von Krafft-Ebing published *Psychopathia Sexualis*, a book that addressed the existence of dysfunctions and deviations alike. Krafft-

Ebing theorized that many sexual disorders resulted from the improper use of sexual energy, creating a state of moral degeneracy. For men, this loss was conceptualized as a waste of semen on nonreproductive activities such as childhood masturbation and excessively frequent sexual activity in adulthood. Mental health professionals at that time advocated preventive treatment through the use of restraining devices that inhibited children's masturbation, such as metal mittens, and through the maintenance of a bland diet in adulthood to avoid overstimulation of the senses.

Sigmund Freud presented a different view of sexual dysfunction in 1905 with the introduction of the Oedipal and Electra complexes. Sexual disorders were thought to be the result of failing to resolve these complexes and becoming fixated at an immature stage of psychosexual development. Treatment did not involve direct attention to sexual functioning, but instead revolved around indirect psychoanalytic approaches, such as insight attainment and transference techniques.

B. Behavioral Sex Therapy

Despite the failure of Freudian therapy in the successful treatment of sexual dysfunction, it was nearly 50 years before Freud's views were challenged by early behaviorists. These early behavioral psychologists posited that anxiety functioned to inhibit normal sexual arousal, resulting in dysfunction. Treatment consisted of techniques to reduce anxiety such as progressive relaxation and systematic desensitization.

In 1966 and 1970, William Masters and Virginia Johnson published their monumental works on the etiology and treatment of sexual dysfunctions. Masters and Johnson expanded on the theories of early behaviorists by stressing an informal social learning theory approach that emphasized the roles that negative messages about sexuality, lack of knowledge about sexuality, and traumatic first sexual experiences play in sexual functioning. In addition, they introduced the concept of sexual problems as self-maintaining cycles of dysfunctional sexual behaviors mediated by anxiety. They theorized that following a negative sexual experience, an individual might develop an anxious, self-evaluative spectator role that interferes with the normal sexual response cycle and results in the maintenance of sexual dysfunction. In addition to the anxiety reduction techniques utilized by early behaviorists, Masters and Johnson included the instruction of specific sexual stimulation techniques in their treatment protocol.

Later additions to the Masters and Johnson model for sex therapy have included elements of both cognitive and systemic theory. An emphasis was placed on a patient's thinking about sex, with various cognitive distortions becoming a major focus of treatment. Moreover, couple systemic considerations such as power struggles and difficulties with intimacy and trust have increasingly been included in both etiological considerations and treatment focus in a variety of sexual dysfunctions. In 1997, Joseph LoPiccolo termed this melding of theoretical approaches "post-modern sex therapy" and acknowledged that the procedures used by behavioral, cognitive-behavioral, and systemic therapists in treating sexual dysfunctions greatly overlap. As a result, the most comprehensive discussion of current treatment approaches to sexual dysfunctions must include an explanation of the theoretical underpinnings of postmodern sex therapy.

C. Post-modern Sex Therapy

Post-modern sex therapy is a therapeutic approach that uses behavioral, cognitive, and systemic methods to treat a variety of sexual disorders that affect both males and females. This approach is based on a theoretical foundation in which the etiology of sexual dysfunctions is considered to be multifaceted, with both psychological and physiological factors contributing to the onset of a particular disorder. As a result, both diagnosis and treatment of sexual dysfunctions must be considered in the context of a combination of behaviors, thoughts, and emotions.

Problems in sexual functioning are thought to have several potential causes that must be considered when designing the treatment approach. According to LoPiccolo, these include psychological factors, such as family of origin learning history, systemic relationship issues, cognitive distortions, and daily life stressors, as well as physiological or medical issues.

1. Family of Origin Learning History

Although Freudian theories of sexual dysfunction have largely been abandoned by modern mental health professionals, the idea that childhood can play a significant role in later sexual development has not. Most sex therapists today believe that childhood and adolescent experiences can play an important role in the development of both healthy and dysfunctional sexual relationships in adulthood. Issues in family of origin learning history often involve negative messages about sexual expression and a lack of sex education. In addition, many women and men who experience sexual dysfunctions have parents who have modeled unaffectionate and unhealthy sexual relationships.

The most common form of sex education for children who later develop sexual dysfunctions is the absence of sex education. Numerous adults who experience sexual difficulties report that they were not told about the positive aspects of sexuality by their families, and they often say that they did not receive any messages at all about sex. As noted by Susan Walen and Richard Perlmutter in 1988, the absence of communication about an issue does not indicate the absence of an underlying message, and often the topics that are never mentioned are the very topics that are seen as the most distasteful and inappropriate for discussion. By refusing to discuss sexuality, many parents set their children up for believing a multitude of myths about sex that they garner from peers, the media, and other unreliable outside sources of information. These can include misinformation about how one gets pregnant, the ways in which sexually transmitted diseases are transmitted, and the ways in which each partner must give and receive sexual pleasure.

Warren and Perlmutter outlined the "secrets of sex in families" that can contribute to the later development of difficulties in sexual functioning. One such secret is that sex is actually a pleasurable way to share feelings of love and affection with a partner, to express oneself as a healthy or happy person, or is a pleasurable form of recreation. Other deleterious family secrets include the secret that masturbation is a normal and healthy way to explore oneself and experience pleasure, the secret that

children can have appropriate sexual feelings, the secret that adolescence is a normal time to experience sexual impulses and urges, and the secret that parents are sexual. In many of these families, the parents hide their affection and sexuality from their children behind closed doors, and children quickly learn that sex is an activity that needs to be hidden from others. Finally, the most serious sexual secrets that families keep are those associated with incest, rape, and paraphilias. Incest, in particular, is a family secret that very commonly leads to adulthood sexual dysfunction.

This lack of sex education not only leads to negative feelings about sexuality, but it also leads to sexual behavioral deficits in adulthood. Because they are discouraged from communicating with others about sexual issues and from sexual self-exploration, many children grow into adults who are ignorant of their partner's and their own anatomy, as well as the sexual response cycle. Common deficits in education that illustrate the problems associated with several sexual dysfunctions include uncertainty about the location of the clitoris, the belief that women must experience an orgasm through vaginal penetration only, the inability to recognize an orgasm when it does occur, the belief that men must ejaculate every time they have intercourse, the belief that men should be able to quickly regain erections after ejaculation, and the belief that orgasm through intercourse is the only acceptable end to sexual activity. These erroneous beliefs often lead to sexual behaviors that are detrimental to a functional sexual relationship, such as by neglecting to properly stimulate the clitoris to orgasm. In addition, cultural myths about sexuality and aging contribute to these cognitive and behavioral causes of sexual dysfunction. For instance, it is frequently thought that men should be able to attain and sustain an erection with little or no direct stimulation even as they get older.

While a lack of sex education is a common denominator in adults who have developed a sexual dysfunction, many children receive direct, harmful messages about the undesirability of sex. Negative messages about sexuality are communicated to children and adolescents in myriad ways. Strict prohibitions against childhood and adolescent masturbation, and parental negativism toward dating and premarital sexual activities are somewhat common methods of providing youth with messages about the shameful of sexual arousal and orgasm. In addition, traumatic first sexual experiences in childhood and adolescence have been found to be a common causative factor in the development of adult sexual dysfunctions. Finally, direct nega-

tive messages about sex and its consequences are often reported by individuals who suffer from a sexual disorder. Children might be told that sex is wrong, immoral, it hurts, or that it is dirty. Many females are informed that women do not enjoy sex, and if they do, then they are "sluts" or "whores."

Direct negative messages about sex have been linked to female orgasmic disorder by many clinicians and researchers. A "typical" history for these women has been described as involving strong parental prohibitions against nudity, masturbation, and sex play; no preparation for the onset of menstruation; a lack of sex education; and severe restrictions on adolescent dating. However, this same history is also common in women who do not later develop a sexual dysfunction. In 1986, Julia Heiman and colleagues reported that women who are both sexually functional and sexually dysfunctional experience similar culturally bound negative messages about female sexuality. It is still not clear what mediating variables may play a role in causing sexual dysfunction in some women, but not in others.

2. Systemic Relationship Factors

In the history of sex therapy, it has often been thought that sexual dysfunctions were extremely distressing to both the diagnosed individual and his or her partner. Marital dissatisfaction and sexual dysfunction were often considered to be separate problems, and assessment and treatment in one arena was compartmentalized such that marital therapy did not deal with sexual issues, and vice versa. More recently, however, it has been noted that sexual dysfunctions can play an important role in the couple's relationship. Indeed, sexual dysfunctions can sometimes be seen to develop in order to fulfill a role or convey a message within the relationship. As a result, post-modern sex therapy recognizes the important psychological needs that a sexual dysfunction can be meeting for an individual. In these situations, the dysfunction can be seen to introduce or maintain a level of homeostasis in the relationship structure. Understanding the psychological and relationship needs that sexual dysfunctions can help to fulfill is an important component of post-modern sex therapy. In 1997, LoPiccolo noted that inattention to the individual or couple dynamic needs that are being met by the sexual dysfunction commonly results in client sabotage and resistance toward therapeutic progress.

In 1988, LoPiccolo and Jerry Friedman formulated a list of several commonly occurring systemic issues that may be both causes and effects of sexual disorders. These issues include a lack of attraction to the partner,

poor sexual skills of the partner, general dyadic unhappiness, fear of closeness or intimacy, a lack of basic trust, differences between the couple in the degree of personal space desired in the relationship, passive-aggressive solutions to a power imbalance, poor conflict resolution skills, and the inability to blend feelings of love and sexual desire. For example, some cases of low sexual desire disorder may reflect other relationship power disruptions. The diagnosed partner may use his or her lack of sexual desire to gain power in a relationship in which he or she feels very little control by becoming the sexual “gatekeeper.” Alternately, the opposite could occur, where the nondiagnosed partner has a vested interest in the maintenance of the dysfunction because he or she gains some power in the relationship due to feelings of guilt in the diagnosed partner. In both instances, careful attention must be paid to the benefits that occur as a result of the dysfunction and treatment must address the underlying problems in the relationship.

3. Cognitive Distortions and Intrapsychic Factors

Cognitive contributions to the development and maintenance of sexual dysfunctions were first recognized by the early behaviorists who claimed that the major etiological factor associated with sexual dysfunction was anxiety. Masters and Johnson called this performance anxiety, a term referring to the excessive worrying about sexual performance that can in itself interfere with sexual arousal, resulting in sexual failure. Male erectile disorder is a sexual dysfunction that is often associated with performance anxiety, as men with this disorder tend to fear repeat occurrences of erectile failure, worry about it excessively, and spend much of their time during sexual encounters monitoring their arousal and strength of erection. As a result, they do fail to attain or sustain an erection, leading to even greater anxiety and the maintenance of a cycle of sexual dysfunction.

Many cognitive distortions play a role in the development and maintenance of sexual dysfunctions. Individuals who have problems with sexual functioning often engage in dichotomous thinking, in which they take an all-or-nothing attitude toward sexual functioning. A man who experiences premature ejaculation, for instance, may feel that if he cannot control his time to ejaculation, then he is a total sexual failure. This type of belief may even occur despite his bringing his partner to orgasm through other methods of sexual stimulation. Catastrophizing is also common, and can be seen when individuals make negative predictions about their fu-

ture sexual functioning and their ability to overcome dysfunction. Imperatives, in which the client makes “should” and “must” statements about their sexual functioning, are characteristic of many people with dysfunctions. For example, a woman who has never experienced an orgasm during intercourse with her partner may tell herself “I should be able to have an orgasm just from having his penis in my vagina. I shouldn’t have to stimulate my clitoris.” Finally, people who experience problems in sexual functioning often engage in mind reading when it comes to the reactions of their partners, which can lead to even more anxiety. A woman who has vaginismus might make attributions about what her partner thinks about her as a person or a sexual being, such as, “He’s thinking I’m frigid and undesirable.”

According to LoPiccolo and Friedman, other intrapsychic and cognitive factors that are important contributors to a variety of sexual dysfunctions include a fear of loss of control over sexual urges, fears of having children, underlying depression, religious orthodoxy, gender identity conflicts, homosexual orientation or conflict, masked sexual deviation, aging concerns, sexual phobias or aversions, anhedonic or obsessive-compulsive personality, unresolved feelings about the death of a spouse, and attempting sex in a context or situation that is not comfortable for the client.

4. Daily Life Stressors and Operant Issues

A fourth psychological factor in the development and maintenance of sexual dysfunctions are the daily life stresses that an individual experiences and the operant value that the dysfunction may have for either partner. An operant value can be defined as a reinforcing consequence for a sexual dysfunction that comes from the external world, such as through the admiration of friends for sticking by a dysfunctional partner, or devoting extra time to work because of the impaired sexual and marital relationship and experiencing financial rewards as a result. Friends and family may admire a woman who devotes extra time to her children and their activities because she has distanced herself from her low-desire husband. As a result, she may have reservations about making real therapeutic gains on the low sexual desire.

5. Physiological or Medical Factors

Sexual dysfunctions are best understood as existing in a multidimensional realm, with both psychological and physiological factors playing differing roles in the development and maintenance of problems. Although some individuals may experience a disorder caused solely by physiological or psychological factors, most

have a complex intermingling of etiologies that are unique to each individual. Many illnesses that affect the functioning of the neurological system, such as diabetes and multiple sclerosis, result in sexual disorders because they interfere with the very system that controls arousal and orgasm. Other illnesses and diseases that result in chronic pain or fatigue can also interfere with sexual arousal and enjoyment of a variety of sexual activities. Finally, many medications have side effects that interfere with functioning by inhibiting sexual responsiveness. These include a variety of psychotropics, particularly antidepressants and anti-anxiety medications, and drugs prescribed for various medical conditions, such as high blood pressure. Marijuana, alcohol, barbiturates, and other street drugs can also have a deleterious effect on sexual functioning.

These five categories not only serve a causative function in many instances of sexual dysfunction, but they can also work in a variety of combinations to maintain problems that are extremely disrupting to the lives of individuals with disorders. For instance, a man may experience his first erectile failure as a result of a medical problem, such as a reaction to an antidepressant. However, even when taken off of the antidepressant, he may continue to experience problems with attaining or sustaining an erection because he continues to make irrational and anxiety-provoking cognitive distortions. Similarly, a woman may originally experience anorgasmia due to the extremely negative messages she received about sex as a child and adolescent, but the problem may be maintained by her tremendously stressful life as a working mother who has little time to relax and resists adding a sexual role to the others for which she has already assumed responsibility. The combination of causative and maintaining factors that contribute to any individual case of sexual dysfunction must be thoroughly examined and treated within the context of fostering a healthy, mutually pleasurable sexual relationship for the dysfunctional couple.

II. BEHAVIORAL, COGNITIVE, AND SYSTEMIC TREATMENT FOR SEXUAL DYSFUNCTIONS

A. Treatment Overview

Post-modern sex therapy addresses the causal and maintaining factors of sexual dysfunction through a variety of behavioral, cognitive, and systemic treatment methods. In 1997, LoPiccolo outlined nine general principles of sex therapy through which couple change

takes place. First, the sexual dysfunction is conceptualized as a disorder of the couple, with both partners bearing a mutual responsibility for treatment. It is important to take the blame out of sexual disorders and facilitate a team approach to treatment. Both partners should be engaged in the treatment process and willing to take on responsibility for the sexual dysfunction and its treatment. In cases where the nondysfunctional partner refuses to actively participate in therapy, the rates of treatment success can be seriously reduced.

Second, in many cases couples have limited knowledge of the basic anatomy and physiology of human sexual response. Consequently, it becomes necessary for the therapist to provide an informational and educational component to treatment. Clients often need to be educated about the process of sexual arousal in both males and females, as well as about human anatomy. For instance, many couples do not know where the clitoris is located, that vaginal lubrication is not automatic, or that men have a refractory period between the time they ejaculate and the time they can attain another erection. A sex therapist will assist their clients in learning about their bodies and the process of sexual arousal and orgasm.

The third principle of sex therapy is to foster an attitude change in clients who have negative attitudes toward the expression of their sexuality. As noted earlier, negative attitudes can come from a variety of sources, including the family of origin. The therapist must work to combat these negative attitudes and replace them with more positive, accepting attitudes toward sexuality.

A fourth mechanism of change in sex therapy is the elimination of performance anxiety. Many individuals who experience problems in sexual functioning possess negative self-fulfilling expectancies about their sexual abilities and how their sexual encounters will progress. There are many strategies used in sex therapy to help clients begin to enjoy the process of sex as opposed to focusing on sexual goals. Participants in therapy are taught that worrying about the outcome of sex guarantees that they will not attain their "goal," because it directly interferes with arousal. Instead, the emphasis is on enjoying the process of sex. This intervention is paradoxical: Often, as soon as clients are no longer worrying about maintaining an erection or attaining an orgasm, they are free to enjoy sex and experience normal sexual functioning.

A fifth goal of sex therapy is to increase communication skills in the couple. Dysfunctional couples often have many communication deficits that directly affect their ability to have satisfying sexual relationships. For instance, couples with sexual dysfunctions often have trouble communicating their likes and dislikes to one

another for a number of reasons. Some couples are embarrassed about such communication, or they may not feel that it is part of their proscribed sexual role. Others may lack the knowledge of how to convey their preferences in an effective manner, resulting in their partners feeling criticized or humiliated by the communication that does take place. Another common difficulty concerns the initiation and refusal of sexual activity, with many couples developing indirect and ineffective ways of telling their partner when they do and do not want to engage in sexual activity. Sex therapy addresses these common problems by teaching couples effective communication strategies for conveying sexual preferences and responses in a clear, open, and supportive manner, and for initiating and refusing sexual activity in a clear, nonhurtful, and nonthreatening manner.

Changing destructive sex roles and lifestyles is the sixth mechanism of change in post-modern sex therapy. Many people have developed life habits that indirectly interfere with sexual functioning in a number of ways. Problems with extended family, children, and careers can all interfere with the sexual lives of adults. In addition, the sex roles that people acquire can interfere with sexual expression in a relationship. For instance, a common problem experienced by two-income households is the idea that the female partner is still responsible for the majority of housework and child care in addition to her career. This expectation leads many women to feel highly stressed and overworked, which in turn interferes with feelings of sexiness and sexual desire. A destructive sex role for men might include the expectation that they always initiate sexual relations, leading to pressure to be the pursuer and to feelings of uncertainty about their own sexual desirability. Sex therapy addresses these destructive lifestyles and sex roles by helping the client to initiate the life changes that will facilitate healthy sexual relationships.

Seventh, sex therapists must often help couples to change disruptive marital systems and enhance the marital relationship. Commonly, sexual dysfunctions are present in unhappy marital relationships. As such, it is unrealistic to believe that a couple can leave behind their disagreements about parenting, finances, or other issues while working solely on sexual issues. Often, therapists must address these issues in conjunction with sexual dysfunction in order to foster a more satisfactory sexual relationship. Current sex therapy frequently involves direct restructuring of the marital relationship.

Physical and medical interventions are sometimes needed to restore healthy sexual functioning. Many medical diseases can interfere with sexual functioning,

including diabetes, heart disease, and neurological conditions such as spinal cord injury, multiple sclerosis, and pituitary/hypothalamic tumors. In addition, many prescribed medications can interfere with the arousal process. Antihypertensive medications and psychotropic medications such as antianxiety, antidepressant, and antipsychotic agents have been shown to interfere with arousal and orgasm for both men and women. Similarly, recreational drugs such as alcohol, marijuana, heroin, and cocaine can negatively impact sex drive, sexual arousal, and orgasm. Finally, hormone levels in the body can also have major effects on sexual functioning. Disruptions in the levels of testosterone, estrogen, and prolactin can suppress sex drive and negatively impact sexual functioning for men and women. As a result, team approaches to sex therapy are often warranted, with the therapist and a medical practitioner working together to improve sexual functioning.

Perhaps the most distinctive element of sex therapy is the behavioral component: changing sexual behavior and teaching effective sexual techniques. Stanley Althof outlined several goals of behavioral techniques in sex therapy in 1989. These goals include overcoming performance anxiety, altering the previously destructive sexual system, confronting resistances in each partner, alleviating the couples' anxiety about physical intimacy, dispelling myths and educating clients regarding sexual function and anatomy, counteracting negative concerns with body image, and heightening sensuality. For each sexual dysfunction, the therapist prescribes a series of specific sexual behaviors for the clients to perform in their own homes. Clients are confronted with the behavioral challenge of both changing their actual sexual behaviors and understanding the problems they have in implementing this change. In 1995, Walter Vandereycken outlined several common behavioral interventions that are used in sex therapy. Vandereycken divided these procedures into two categories: "nondemand" procedures aimed at decreasing sexual anxiety, and "excitement-awareness" procedures to increase sexual arousal. The nondemand interventions include deemphasizing sexual intercourse by placing a temporary ban on coitus, desensitization techniques, relaxation training, sensate focus, and graded noncoital contact and stimulation. Common excitement-awareness procedures include the development of sexual fantasies and imagery, role-play of an exaggerated orgasm, body awareness and self-exploration, directed masturbation, and guided stimulation by the partner. Although some of these behaviors may be similar for different disorders, the treatment for each sexual dysfunction

includes unique behavioral prescriptions that will be described in detail later in this article.

It is important to note that these mechanisms of change are not a step-wise therapy, with each component being undertaken after the previous ones have been mastered. Instead, post-modern sex therapy is a conglomeration of these overriding principles, with the therapist using these techniques in conjunction with one another. Thus, throughout treatment, therapy is seen as a process for which both partners are mutually responsible, the therapist attempts to foster the development of more effective communication skills, and attention is paid to dyadic relationship satisfaction. All the while, specific behavioral modifications in sexual functioning are made.

B. General Strategies in Assessment and Treatment

Sex therapy usually begins with an evaluation and assessment of the particular sexual dysfunction and its impact on the marital relationship. This assessment has historically included taking an extensive sexual history of both partners, interviewed separately. Masters and Johnson advocated the use of a semistructured interview that typically lasted for several hours. However, as pointed out by LoPiccolo in 1995, the utility of this type of interview has not been empirically demonstrated and its application may not be the most efficient use of therapeutic time. Particularly in this time of insurance-placed restraints on the number of therapy sessions a given person is covered for, it is important for the therapist to be mindful of the benefits that a shortened sexual history assessment can provide for the therapeutic process.

Paper-and-pencil questionnaires are also commonly used to assess sexual history and current sexual functioning. The Sexual Arousal Inventory, developed by Peter Hoon, Emily Hoon, and John Wincze in 1976, and the Sexual Interaction Inventory, developed by LoPiccolo and Jeffrey Steger in 1974, are two questionnaires that can be particularly useful in the assessment and treatment outcome phases of sex therapy. These questionnaires can provide valuable information to the therapist by identifying arousal deficits and problem behaviors that can be the focus of treatment. They are also useful tools for identifying significant discrepancies in thoughts, feelings, and behaviors reported by the partners.

A physiological assessment by medical professionals is also indicated in the assessment of several sexual dysfunctions, including male erectile disorder and dys-

pareunia. Although vaginismus is not caused by organic factors, a medical assessment is still warranted to rule out the possibility that dyspareunia has not been incorrectly diagnosed as vaginismus. Premature ejaculation and female orgasmic disorder are not associated through empirical research with organic factors. Physiological assessments should include a pelvic examination by a specialist, such as a gynecologist or urologist, an assessment of current medications and their potential side effects, and tests for thyroid function, endocrine status, and glucose tolerance. In addition, vascular and neurological examinations are especially important in cases of male erectile disorder.

Following these initial assessment procedures, the therapist presents a comprehensive formulation of the etiology and maintenance of the dysfunction to the couple. Their sex histories, family-of-origin dynamics, cognitive styles, current relationship structure, external reinforcers, and any organic factors are used in this formulation, and the couple is informed about how these factors have interacted to create and maintain their sexual problems. This presentation is useful in initiating change procedures and sometimes has positive effects on the sexual problem itself.

After the completion of the assessment portion of therapy, some simple behavioral interventions are made that are common to all of the dysfunctions. First, the couple is asked to refrain from attempting sexual intercourse until it is prescribed by the therapist. Many sex therapists believe that this prohibition of coitus serves to alleviate performance anxiety, allowing the couple to rebuild their sexual relationship from the beginning. Next, the couple is typically asked to complete a series of sensate focus exercises. Sensate focus is a behavioral intervention that focuses the clients' attention on the sensuality of the body, without the pressure attendant upon sexual behaviors such as intercourse. These exercises include sensual touching of the clients' own bodies or their partners', and consist of caressing, hugging, kissing, and body massage. Participants in sex therapy are instructed to tune in to their sensual response to the touching. Sensate focus exercises serve to reduce anxiety in a number of ways, including providing a no-demand experience to the couple, eliminating the "spectator role," and increasing dyadic communication by giving feedback to the partner about what feels good. Breast and genital contact, intercourse, and orgasm are not allowed as part of these exercises. Vandereycken points out that the ban on intercourse and the inclusion of sensate focus exercises in the therapeutic process are of somewhat questionable value because

they have never been systematically studied. However, their use is indirectly supported through their inclusion in several treatment protocols for different sexual disorders that have been empirically validated.

The next step in post-modern sex therapy is dependent on the exact nature of the couple's sexual dysfunction. Following is a description of each of the major sexual dysfunctions listed in the *DSM-IV*, along with the more specific treatment procedures used for each disorder.

C. Gender-Specific Sexual Dysfunctions

Several sexual disorders are unique to males, whereas some are experienced exclusively by females. These gender-specific disorders occur during both the arousal and orgasm stages of the human sexual response cycle. The male sexual dysfunctions include erectile dysfunction, premature ejaculation, and male orgasmic disorder. Disorders that commonly affect women are female arousal disorder, female orgasmic disorder, and vaginismus.

1. Male Sexual Dysfunctions

a. Male Erectile Disorder Male erectile disorder is characterized by an inability to attain or maintain an erection, resulting in an incapacity to complete sexual activities such as intercourse. The etiology of male erectile disorder can be extremely complex, with a primarily psychogenic cause, a primarily organic cause, or most often, an interaction of the two. Neurological diseases such as multiple sclerosis and diabetes, a failure of blood flow to the penis, medication side effects, and surgical damage are all potentially physiological causes of erectile dysfunction. As stated before, a physical evaluation is extremely important in the assessment of this particular disorder. However, as LoPiccolo noted in 1995, the presence of some degree of organic impairment does not always negate the need for behavioral treatment. Men who suffer from mild organic impairment are often more vulnerable to psychological factors of erectile failure. As a result, treating the psychological difficulties can frequently enable a man to experience a fully functional erection even with the mild physiological impairment. Psychological treatment of erectile dysfunction in men with organic causes serves to help the client function at his optimum physiological capacity.

Psychogenic causes of male erectile disorder can include performance anxiety and the spectator role, as well as a lack of adequate physical stimulation of the

penis. Commonly, men who experience difficulty attaining or maintaining an erection enter each sexual encounter with negative expectancies about their ability to "perform" and consequently, they constantly self-monitor their own level of arousal. These men become anxious observers rather than aroused participants. This sort of mindset prevents arousal, and as a result, the dysfunction is cyclically maintained. Problems with erection can also result from poor sexual techniques, such as inadequate stimulation of the penis. Especially as men age, direct stimulation of the penis for some period of time is necessary for the attainment of an erection. However, many couples expect erections to be automatic and effortless, and therefore do not give the penis adequate stimulation. Consequently, the predominant themes in the psychological treatment of erectile dysfunction are the reduction of performance anxiety and the increase of sexual stimulation.

After engaging in general sensate focus techniques, the couple is instructed to add genital contact to their sessions. They are taught the "tease technique" in which the couple is instructed to cease genital contact if the male should attain an erection. The couple can resume penile contact only after the erection is lost. This exercise teaches clients that erections occur naturally in response to stimulation, as long as the couple does not focus on performance. The male is paradoxically instructed throughout sensate focus that, "The purpose of this exercise is for you to learn to enjoy sensual pleasures, without focusing on sexual goals. Therefore, you should try to not get an erection." This demand to not get an erection frees the male to enjoy sensual situations without the accompanying anxieties that have worked against attaining an erection in the past.

After the couple experiences this process several times, they move on to intercourse. Intercourse is also attempted in several steps. First, the male partner lies on his back while the female partner kneels astride him and uses her fingers to push his flaccid penis into her vagina. This procedure, known as the "stuffing technique," frees him from having to have a rigid penis to accomplish entry. Sometimes called "quiet vagina," the woman remains still while his penis is inside of her. Gradually, the couple can add movement by the female gently moving her hips. Finally, the male is instructed to thrust and the couple resumes full sexual activity, with no further restrictions. Throughout this process, the couple is instructed to achieve the woman's orgasm through manual or oral sex, resulting in the reduction of pressure on the male to perform as well as partner

compliance with treatment. In addition, Althof suggests that guided explicit fantasies can be used when the male is preoccupied with performance issues or when he is having difficulty becoming aroused.

This set of procedures seems to be effective in cases where there is no major organic impairment of erection. For men with more severe physiological problems underlying or complicating their erectile dysfunction, however, physical interventions may be warranted. One of several medical procedures may be useful for men who experience erectile failure as the result of a more severe organic impairment.

Penile injections of drugs that cause rigidity, such as prostaglandin E, phentolamine, and vasoactive intestinal polypeptide, can be an effective treatment for men with irreversible erectile dysfunction. These drugs are self-administered by the patient just before intercourse, and they work by dilating the penile arteries. Research indicates that most men who use penile injections experience erections as a result. In their discussion of organic treatment methods for male erectile disorder in 1989, Leonore Tiefer and Arnold Melman warn that this "quick fix" can often be tempting to men who have a more psychogenic basis for the disorder. However, they warn against using this method of treatment for these men, citing potential risks of scarring of the penis, and research results that indicate these types of men are often very dissatisfied with the treatment.

Another nonsurgical and noninvasive treatment method is the use of a vacuum constriction device. A hollow cylinder is placed over the penis, and a hand pump is used to pump the air out of the cylinder, leaving the penis in a partial vacuum. As a result, blood rushes into the penis. The cylinder is removed and a rubber constricting band is placed at the base of the penis to maintain the erection. This treatment method is most often used for men who have erectile dysfunction rooted in diabetes or neurological problems, and it does not have any known negative effects on the body. It can, however, be awkward and can interfere with the spontaneity of sex.

Artificial erections can also be manufactured in men with severe physical problems through the use of a penile prosthesis. This device consists of a semirigid pair of rods made of rubber and wire, and it is surgically implanted in the corpora. This device does not allow for growth of the penis in width or length during sexual activity. Instead, it can be bent up to an erect position when the man wants to have sex, and bent back down for normal wear. An alternative to this type of prosthesis is a hydraulic inflatable system that allows for

tumescence. Inflatable hollow cylinders are surgically inserted into the penis, a reservoir of saline fluid is placed under the abdominal wall, and tubing connecting the cylinders to a pump is inserted in the scrotum. When he wishes to have sex, the man or his partner can squeeze the pump, forcing fluid from the reservoir to the penile cylinders, which expand and produce an erection. Tiefer and Melman caution that because of their invasiveness and annihilation of any capacity to produce an erection should they need to be removed at a later date, penile implants should be considered the last resort in the treatment of erectile disorder.

Finally, the recent proliferation of advertisements for Viagra speak to its popularity as a pharmacological treatment for erectile disorder. Viagra is an effective treatment, showing positive results in 70 to 80% of cases treated. The drug works by reducing venous outflow once blood has been pumped into the cavernous bodies, not by increasing arterial inflow. As such, men who use Viagra still need adequate sexual and emotional stimulation to achieve an erection. Some of the 20 to 30% of cases in which Viagra fails are not actually pharmacologic failures, but failures to provide adequate physical or emotional stimulation. Consequently, the use of Viagra is contraindicated in instances where couple systemic issues are the only etiological factor involved with erectile difficulties. In addition, Viagra is also contraindicated in instances where low desire is the cause of erectile failure, as the drug has not been shown to increase levels of desire.

b. Premature Ejaculation Premature ejaculation is defined as the persistent onset of orgasm and ejaculation with minimal stimulation, before or shortly after intromission occurs. An important determinant of premature ejaculation is that it causes marked distress in the male and/or his partner. Time criterion have had little use in the assessment of premature ejaculation, as differences in foreplay activity, age, and the use of distraction techniques can artificially increase or decrease the duration of intercourse. A more clinically useful conceptualization of premature ejaculation includes the couple's subjective opinions about the appropriateness of duration, and the pleasure and satisfaction that each partner gains from their sexual encounters. If both partners agree that their sexual encounters are negatively influenced by efforts to delay ejaculation, then premature ejaculation is considered a problem.

In 1970, Masters and Johnson reported that premature ejaculation can be treated with direct behavioral retraining procedures that are successful in nearly 100%

of cases. The standard treatment for premature ejaculation involves the “stop-start” or “pause” procedure, introduced by Semans in 1956. With this procedure, the penis is manually stimulated until the man is highly aroused and he feels that ejaculation is imminent. At this point, the couple stops stimulation until the arousal subsides, and they resume stimulation again when the male no longer feels that ejaculation is imminent. The “squeeze” technique can also be added to help the male delay ejaculation during manual stimulation. In this procedure, the female partner firmly squeezes the penis between her thumb and forefinger, at the place where the head of the penis joins the shaft. For some couples, this procedure can be an effective way to reduce arousal even further than that experienced with the stop-start technique. The stop-start and squeeze procedures are repeated many times so that the male can experience an immense amount of stimulation and arousal without the occurrence of ejaculation. Ultimately, the man should experience significantly more total time of stimulation than he has ever experienced before. These behavioral procedures lead to a higher threshold for ejaculation, with the male gradually gaining the capacity for participating in quite lengthy periods of penile stimulation without ejaculation.

After a few weeks of this training when the necessity of pausing diminishes, the focus of behavioral exercises shifts to include intercourse. The couple continues to practice a modified stop-start technique in which the penis is placed in the vagina without any thrusting movements. The most effective intercourse position during this period of treatment is the woman on top position. The “quiet vagina” exercise is utilized, and the male partner is encouraged to make no movement but to feel free to engage in erotic touching of his partner. If this stimulation produces high levels of arousal and a feeling of ejaculatory inevitability, the penis is withdrawn and the couple waits for arousal to drop off. When good tolerance for inactive containment of the penis is achieved, the training procedure is repeated during active thrusting exercises with a variety of sexual positions. After 2 to 3 months of practice, males who undergo treatment for premature ejaculation are generally able to enjoy significantly prolonged intercourse without the need to use pause and squeeze techniques.

In a 1989 publication of a treatment protocol for premature ejaculation, Barry McCarthy stressed the importance of the process of successive approximation in ejaculatory control exercises. The male is taught to become aware of his level of arousal and the point of ejaculatory control when he is still able to stop short of

ejaculation. It is inevitable that the client will have at least one experience during treatment where he pushes the limits too far, and signals for his partner too late to stop the ejaculatory process. McCarthy emphasized that it is important for the therapist to confront the couple with this possibility early in therapy, and to encourage the couple to use it as a pleasurable learning experience about identifying ejaculatory inevitability rather than experience it as a failure in treatment. He also highlighted the importance of ensuring that the female partner's desires and preferences be given equal attention, with both manual and oral stimulation encouraged as a method to bring sexual satisfaction to the woman during the treatment period. The benefits of this are twofold. First, the female partner is more likely to remain invested in the treatment if the couple's sexual encounters are not always completely focused on the male partner's arousal. Second, the male can learn that women can be sexually satisfied in a number of ways that have little or nothing to do with the penis and intercourse, which in turn leads to the alleviation of performance anxieties. Finally, McCarthy suggested that cognitive restructuring procedures used in conjunction with behavioral interventions can have an important effect on the long-term success of therapy. Couples need to learn that sex is a collaborative process in which neither partner bears the responsibility for performing, in which both partners are integral to changing problematic sexual behaviors and maintaining those changes, and in which intimacy and sexuality are integrated to form a stronger sexual relationship for the couple.

c. Male Orgasmic Disorder Male orgasmic disorder is present when a man experiences a recurrent delay in, or absence of, orgasm following a normal phase of sexual excitement. Formerly known as inhibited ejaculation, male orgasmic disorder is a fairly rare sexual dysfunction, and the cause of the problem often remains unclear. Many psychological factors have been theorized as causes for male orgasmic disorder, such as an autosexual orientation and fear of intimacy with the partner, but there is little supporting empirical research. However, etiology has been established with several physiological factors, including multiple sclerosis, medication side effects, and damage to the hypothalamus.

Treatment of male orgasmic disorder is based on many of the standard strategies used with other sexual dysfunctions. Eliminating performance anxiety and ensuring adequate stimulation through paradoxical sensate focus exercises are the basis for treatment. The couple is instructed that during sex the penis is to be

caressed manually and/or orally until the man is aroused, but that stimulation is to stop whenever he feels he might be close to orgasm. This procedure takes the focus of sex off of orgasm, and paradoxically, allows the man to fully enjoy the pleasurable sensations of stimulation. Additionally, in 1977 LoPiccolo reported that the use of electric vibrators, behavioral maneuvers called "orgasm triggers" (discussed in the section on female orgasmic disorder), and having the client role-play an exaggerated orgasm all seem to have some success with the treatment of male orgasmic disorder.

Physiological interventions are indicated when the primary cause is organic in nature. Drugs that increase the arousal of the sympathetic nervous system have been found to be helpful in some cases, as has increased stimulation of the scrotal, perineal, and anal areas. In particular, direct stimulation of the anus through the use of a vibrator has been found to be an extremely effective orgasm trigger in men who suffer neurological damage.

2. Female Sexual Dysfunctions

a. Female Sexual Arousal Disorder and Female Orgasmic Disorder A persistent inability to attain or maintain sexual excitement through the completion of sexual activity describes female sexual arousal disorder; female orgasmic disorder occurs when sexual excitement is normal, but orgasm does not occur. Both disorders can be successfully treated with many of the same behavioral techniques, including education, self-exploration, body awareness, and directed masturbation. These procedures are particularly effective for women who have never had an orgasm through any form of stimulation.

Directed masturbation, a treatment protocol for female arousal and orgasm disorders, has broad empirical support in individual, couple, and group modalities. This program of therapy is described in *Becoming Orgasmic*, a self-help book and accompanying film written by Heiman and LoPiccolo, and published in 1988. The directed masturbation protocol involves nine steps. In the first step, the inorgasmic woman is instructed to use various diagrams and reading materials to learn about her body, her genitals, and the female sexual response. She is also encouraged to work on her attitudes and cognitions surrounding the acceptability of female sexuality, and to examine her own sexual history to identify negative influences that have carried into her current functioning. Step 2 involves the woman exploring her body and genitals through both sight and touch. Next, in Step 3 the

woman furthers her body exploration by locating erogenous zones, with a focus on the clitoris, breasts, and other genital regions.

The woman is directly instructed in techniques of masturbation in Step 4. She is encouraged to target the erotically sensitive areas that she has identified in previous sessions and increase the intensity and duration of stimulation. Step 5 is erotic masturbation, in which an attempt is made to make masturbation more erotic and sexual. The woman is encouraged to develop sexual fantasies, read erotic stories, or view sexually arousing pictures to increase her feelings of arousal.

The sixth step has three elements. If the woman has not yet reached orgasm, she will begin to use an electric vibrator to increase the intensity of stimulation. Women who experience their first orgasm through the use of a vibrator usually go on to have orgasms through other methods of stimulation, but the vibrator can be invaluable to the attainment of the first orgasm. Second, she will be instructed to act out or role-play an exaggerated orgasm. This procedure helps the woman overcome any fears about looking silly or losing control when she has a real orgasm. In the final element of the sixth step, "orgasm triggers," such as holding the breath, contracting the pelvic muscles, tensing the leg muscles, and thrusting the pelvis are used by the woman.

The final three steps of the directed masturbation protocol integrate the partner into treatment. In Step 7, the woman shows her partner how she likes to be touched and how she can have an orgasm. During this step, the partner also shares his or her own masturbation preferences with the woman so that she can feel less inhibited, and to ensure that the learning process is reciprocal. In the next step, her partner brings her to orgasm with manual, oral, or vibrator stimulation, using the woman's instruction and guidance to increase arousal and sexual satisfaction. Finally, in Step 9, the heterosexual couple resumes penile-vaginal intercourse in positions that permit one of them to continue clitoral stimulation.

During this final stage, it is essential to educate the couple that continued stimulation of the clitoris during intercourse is both normal and often necessary for many women to experience orgasm through this sexual behavior. Many women and their partners are wed to the myth that women should be able to experience orgasm through penile stimulation only. Educating them about the myth of vaginal versus clitoral orgasms is often necessary. In addition, it should be noted that the couple's goals can be vastly different—some couples are

not as concerned with an ultimate goal of orgasm through coitus, and these individuals should be encouraged to see their treatment as successful if they learn to experience an orgasm through any method of stimulation that they find acceptable.

Not all women who seek treatment for arousal and orgasm disorders have difficulty becoming aroused or reaching orgasm in all situations. Such types of situational orgasmic dysfunction include only being able to reach orgasm in solitary masturbation, without a partner present, or through a circumscribed sexual activity, such as oral stimulation. It is important to note that sex therapists do not consider lack of orgasm during intercourse to be an indication for treatment, provided that the woman can have orgasm in some way with her partner, and that she enjoys intercourse. However, some women are distressed by their limited orgasmic experiences, and there are treatment techniques that can be utilized in these situations.

Treatment for situational lack of orgasm includes a gradual stimulus generalization approach developed by Antionette Zeiss, Raymond Rosen, and Robert Zeiss in 1977. This procedure helps the woman to expand the ways in which she reaches orgasm through a sequential series of changes in stimulation. For example, a woman who can masturbate to orgasm wants to experience orgasm during intercourse. The therapist will help her to identify a number of small, intermediate steps between the way she has orgasm now and the wished-for orgasm during intercourse with her partner. As a first step, the woman might be instructed to masturbate as usual, with the addition of having her finger passively inserted into her vagina from the beginning of stimulation. This procedure will enable her to learn to experience orgasm with something contained in the vagina. Other intermediate steps in this example might include thrusting the inserted finger, having the partner present while she masturbates, having the partner manually stimulate the clitoris with first her and then his finger inserted, passive containment of the penis in the vagina while the woman masturbates, and passive containment of the penis while the man manually stimulates the woman. Once the woman has been able to reach orgasm through each of these phases, the couple can attempt active intercourse with concurrent direct manual stimulation of the clitoris. By breaking down the differences between masturbation and intercourse into a series of very small and discrete changes, there is a much greater success in broadening the woman's range of orgasmic responsivity.

b. Vaginismus Vaginismus is characterized by the involuntary contraction of the muscles surrounding the outer third of the vagina. These contractions have a spasmodic quality, and they prevent the insertion of a penis or other objects into the vagina. Women who experience vaginismus are often capable of becoming sexually aroused and experiencing orgasms—it is the possibility of penetration that triggers the muscle contractions. However, they may also present with a variety of other disorders, including an aversion to sex, female arousal disorder, or female orgasmic disorder.

Relaxation training, Kegel exercises, and use of progressive dilators inserted in the vagina are the procedures used to treat vaginismus. The woman is taught deep muscle relaxation and diaphragmatic breathing techniques in order to decrease her overall feelings of anxiety and to help her gain volitional control of her vaginal muscles. Voluntary control of the vaginal muscles is acquired through Kegel exercises, in which the woman practices contracting and relaxing the pubococcygeal muscle. Next, the woman is helped to overcome her fear of penetration by using a set of gradually larger dilators that she inserts into her vagina at home and at her own pace. Once the woman has been able to comfortably insert the largest dilator, she can begin to guide her partner as her or she slowly and gently inserts the dilators. It should be stressed to women in treatment for vaginismus that they go slowly and become comfortable with each step and each size dilator before moving on to the next. If a woman or her partner pushes treatment forward at too quick of a pace, the result is often increased anxiety about penetration and a rapid return to experiencing the spastic contractions. In addition, both partners should be educated about the need for effective stimulation of the woman's erogenous zones, so that the woman can learn to associate penetration with vaginal lubrication, pleasure, and arousal. The use of fantasies and erotic materials can also aid in this process.

After the woman and her partner have been able to successfully insert the graduated dilators, heterosexual couples can begin to attempt penile penetration. First, the partner lies passively on his back while the woman kneels above him and gradually inserts his erect penis into her vagina. Again, the couple is encouraged to go slowly, at the woman's pace. When the woman is able to contain her partner's penis in her vagina comfortably, she can begin to move. Once she is comfortable, the partner can begin to thrust and the couple can explore a variety of intercourse positions that are enjoyable to both of them.

D. Nongender-Specific Sexual Dysfunctions

1. Dyspareunia

The *DSM-IV* defines dyspareunia as persistent genital pain associated with sexual intercourse in either a male or a female. Although dyspareunia can occur in males or females, clinically, pain is much more frequently seen in female clients.

Most cases of dyspareunia involve an organic etiology, such as vaginitis, endometriosis, Peyronie's disease, unrepaired damage following childbirth in woman, and prostate conditions in men. However, this dysfunction must also have some element of psychogenic etiology in order to be diagnosed as a true case of dyspareunia. A complete medical examination is necessary to differentially diagnose dyspareunia from other, similar disorders such as vaginismus or simple medical conditions. In males, painful intercourse is almost always related to an underlying medical condition.

Because psychogenic dyspareunia is often attributed to a lack of arousal, the general sex therapy procedures and the specific techniques for enhancing female arousal and orgasm are commonly used. In addition, because dyspareunia is commonly linked with vaginismus and may in fact be an earlier stage of that disorder in some women, the treatment protocol for vaginismus is often used. Artificial genital lubricants and relaxation training can also be effective additions to therapy.

2. Hypoactive Sexual Desire Disorder and Sexual Aversion Disorder

Hypoactive sexual desire disorder, often called low sexual desire disorder, is characterized by the persistent absence of desire for sexual activity. A person with this disorder feels little or no interest in sex, but they do not have negative emotions associated with the sex itself. Sexual aversion, on the other hand, is defined as an aversion to and actual avoidance of sexual contact by a partner and is based on strong negative emotional reactions to sex that include fear, revulsion, and disgust. Differential diagnosis between these two disorders is imperative for good treatment results.

Low desire used to be thought to be more prevalent in women; however, more recent data suggest that it affects males and females at a relatively equal rate. According to a treatment guide authored by Cathryn Pridal and LoPiccolo in 2000, low desire is characterized by a very low level, or absence of, spontaneously occurring sexual interest. A distinction is made between receptive and proceptive sexual behaviors, with

a lack of proceptive behavior most indicative of true low sexual desire. Just as differential diagnosis is important, so is an assessment of comorbid sexual disorders. Often, individuals with low desire also experience another dysfunction, such as lack of erection or orgasm. In these cases, it is difficult to determine if low desire is the cause or effect of other disorders. Careful assessment must be made to determine which disorder should be treated first. For instance, a woman suffering from posttraumatic stress disorder (PTSD) after a traumatic sexual history as a child should not be treated for low desire or sexual aversion until her abuse has been adequately dealt with.

In 1988, LoPiccolo and Friedman described a four-element sequential model for hypoactive desire and aversion that has been widely adopted. The first component of the treatment program, called affectual awareness, focuses on helping the client to become more familiar with his or her negative attitudes, beliefs, and cognitions about sex. Feelings of anxiety, fear, resentment, and vulnerability are uncovered as the client is encouraged to closely examine his or her attitudes about sex. Many clients begin therapy insisting that they do not have negative feelings about sex, but instead, are merely indifferent to it. Pridal and LoPiccolo recommended that therapists dispute this claim by using an "umbrella metaphor." In the umbrella metaphor, the therapist explains that all humans have an innate sexual drive. Their indifference to sex is an umbrella that blocks their awareness of the negative emotions that are working to block this innate sexual drive. During this stage, both partners are encouraged to make lists about the benefits of gaining a sexual drive, but also about the possible risks to each individual if sex drive increases, and the potential risks to the relationship. These lists help the low-drive partner gain some motivation for therapy, as well as point out any potential issues that would result in resistance to therapy. In addition, clients are encouraged to visualize sexual scenes and talk about sex in a more graphic way so that they can more accurately recognize negative emotions that they were not previously aware that they had. Finally, role-plays in which the low-drive partner pretends to have a sex drive and initiates sexual activity with his or her partner can be useful in helping the low-drive client track his or her emotional state during this process. In this way, individuals with low sexual drive can become more aware of their own negative attitudes and cognitions about sexuality.

The second phase of sex therapy for low sexual desire involves insight-oriented therapy. During the insight

phase, clients are helped to understand the underlying causes for the negative emotions that they have identified. Family-of-origin experiences, religious teachings, depression, fear of having children, life stress, unresolved sexual trauma or abuse, masked sexual deviations, gender identity issues, and relationship problems are explored as possible initiating and maintaining causes of the low desire or aversion. In a sense, this and the previous step are preparatory. The more active treatment follows.

Stage 3 involves cognitive and systemic therapy. This phase of therapy serves to alter irrational beliefs that inhibit sexual desire and to identify and modify relationship problems that are suppressing sexual drive. First, clients are taught that irrational beliefs may be the main cause of their emotional reactions, and they are helped to identify self-statements that interfere with sexual desire. Therapist and client generate a list of coping statements that combat the client's irrational thoughts about sexuality and help him or her to cope with, rather than avoid, negative emotional reactions to sexual situations. Typical coping statements might be "If I allow myself to enjoy sex, it doesn't mean I am dirty or bad" and "When I was younger I learned to feel guilty about sex, but I'm grown up now, and I don't have to feel that way anymore." Second, relationship problems are addressed in the dyad. In couples in which one partner is low drive, a power imbalance in the relationship is often found. This disruption in power can be expressed with either the low- or normal-drive partner having a disproportionate amount of power in the relationship. Systemic therapy addresses this issue and works to make the couple feel more equal in both their sexual and nonsexual interactions.

The final element of treatment for low desire and aversion consists of behavioral interventions. These include sensate focus, skills training and other general sex therapy procedures, as well as some interventions that are more specific to these disorders. Frequently, couples in which one partner has low drive experience a drastic decline in nonsexual affectionate behavior. The normal-drive partner might misinterpret simple affectionate behavior such as a hug as an invitation to initiate sexual activity. Consequently, the low-drive partner learns to squelch all affectionate behaviors to guard against this type of misunderstanding. An important component to treatment, then, is to reintroduce these simple affectionate behaviors to the couple. The couple identifies a number of affectionate behaviors that they agree will not be used to initiate sexual activity. Next, treatment focus is turned to the ways in

which sexual activity can be initiated. Once again, role-plays are used so that both partners can illustrate how they do and do not like to be approached for sex. Additionally, they can communicate with one another about acceptable, nonhurtful ways to refuse sexual activity. These types of assertion training and communication skills training exercises help couples learn how to negotiate their sexual relationship without being coercive or rejecting of their partner.

Pridal and LoPiccolo labeled this next set of behavioral procedures "drive induction." They posited that sometimes people do not become aware of their sexual drive until they expose themselves to external cues and stimuli that trigger it, and individuals with low drive have developed an extraordinary ability to avoid these sexually relevant cues. In therapy, then, low-drive clients are asked to begin attending to sexual cues. A number of interventions are used in drive induction. For instance, low-drive clients are asked to keep a "desire diary," in which they record all sexual stimuli, thoughts, and emotions. They are also instructed to watch films that have sexual content, read erotic books and magazines, read collections of sexual fantasies, note attractive people they see, and so forth. Finally, couples are also often asked to develop erotic fantasies, both alone and together. The low-drive partner is instructed to take several "fantasy breaks" during the day in which he or she spends some time fantasizing about the sexual scenes that have been developed.

III. APPLICATIONS AND EXCLUSIONS

Since Masters and Johnson published their groundbreaking work on sexual dysfunctions, most therapists have switched from treating these disorders individually to treating the couple. However, couples originally were accepted for therapy if they had very circumscribed problems in only the sexual area. Those clients with individual psychopathology and severe marital distress were systematically screened out, as were individuals with medically complicated histories. Today, there is a greater focus on treating all of these problems, as sex therapists have become more cognizant of the fact that the incidence of "pure" sexual dysfunction without concurrent marital problems is extremely rare. Sex therapists and marital therapists find it less important to try to distinguish between sexual and relationship problems, because it is often not possible to segregate these areas of distress in people's lives. Instead, couples can be

helped to find ways of showing caring and love, to work on sex roles and role expectations within the relationship, to understand the effects that children have on the relationship, to deal with jealousy and outside interests, and to express their differing needs for intimacy, independence, companionship, and affection.

Similarly, there has also been a greater tendency in recent years to accept clients with major forms of psychopathology. Many nonsexual disorders have been associated with problems in sexual expression in the literature. For instance, low desire, erectile dysfunction, and problems reaching orgasm have all been associated with depression. Axis II disorders, such as antisocial personality and passive-aggressive personality disorders have also been found to severely complicate the treatment of sexual dysfunction. However, the presence of one of these disorders does not prevent successful sex therapy, provided that the therapist addresses the concurrent psychopathology.

Group therapy for both individuals and couples has also been found to be an effective modality for the treatment of sexual dysfunctions. Therapists often facilitate treatment groups for disorders such as female orgasmic disorder, premature ejaculation, and erectile dysfunction. Heiman and Grafton-Becker cited research in their work on female orgasmic disorder that indicates that group treatment, including assertiveness training, education, and directed masturbation procedures, can be nearly as effective as couples therapy. The group modality is particularly valuable for single individuals in that it provides an environment of mutual support and encouragement. The treatment of individuals without partners can be more difficult than couple-based treatment; however, assertiveness and social skills training, in addition to the procedures described above, can be helpful to single people with sexual disorders. Some procedures can be altered to handle the unique problems that arise when treating singles. For instance, in 1978, Bernie Zilbergeld described a treatment modification for premature ejaculation in which single men are taught skills in delaying ejaculation through masturbation and fantasy exercises. Similar modifications can be made for the treatment of other sexual disorders.

Several special populations present unique challenges to the traditional methods of treating sexual dysfunction. Sex therapy with gay men, lesbians, and bisexuals must be inclusive of sexual identity issues, the many variations of homosexuality itself, the fear of AIDS, and the internalization of heterosexism. In addition, some modification to techniques will most likely be warranted.

Treatment of clients who have experienced a sexual trauma such as rape or child sexual abuse can also be challenging. Judith Becker, in a chapter on this topic published in 1988, pointed out that some women who seek treatment for sexual dysfunction have had a history of sexual trauma. These women often present with symptoms of PTSD. Special attention must be paid to these symptoms, and the initial treatment goal should be to alleviate the impact of PTSD on sexual functioning. Finally, sex therapy with the chronically ill requires some adaptation. Cooperative work with a primary health provider, treating the client in an institutionalized setting, and adjustments in the behavioral interventions may be warranted. However, traditional treatment methods such as emphasizing education to help people understand their sexual functions and capabilities, deemphasizing genital sex as a necessary component to all sexual pleasure, and emphasizing the exploration of other forms of sexual expression beside sexual intercourse can contribute to the kind of program that is helpful for those who have to make adjustments in their sexual behavior because of a chronic medical condition.

IV. EMPIRICAL RESEARCH

This article has focused on the clinical techniques currently used to treat a variety of sexual dysfunctions. Unfortunately, much of this knowledge is based on clinical experience, rather than on empirical research. In 1980, LoPiccolo pointed out that much of the empirical literature in sex therapy is actually a series of demonstration projects that do not involve random assignment to experimental conditions, manipulation of independent variables, or assessment with objective, quantified dependent variables. Other methodological problems include the use of mixed-diagnosis samples, indirect outcome measures, and small sample sizes. Additionally, there have been very few studies attempting to identify which components of the total sex therapy package are active ingredients and which are "inert fillers."

William O'Donohue, Diane Swingen, and Cynthia Dopke published a comprehensive review of the empirical literature for female sexual dysfunctions in 1997. In 1999, they, along with Lisa Regev, published a similar article concerning male sexual dysfunctions. They cite methodological problems, a lack of long-term follow-up data, a lack of treatment manuals, and the disregard for several disorders in outcome research as major problems that have contributed to the lack of concrete

information about the efficacy of sex therapy programs. Only approximately 20% of the published studies on male and female sexual dysfunctions met the inclusion criteria for the O'Donohue reviews: random assignment to treatment conditions, and at least one comparison or control group. For in-depth examinations of these studies, please refer to the O'Donohue and colleague reviews. For the purposes of this article, it is sufficient to note that strong arguments exist for further attention to research design and data analysis in the empirical study of sex therapy outcomes.

Despite the weaknesses in sex therapy outcome research, there is great reason to believe that the outlined treatments produce positive results in the majority of cases. As such, they have been validated in a very meaningful way. In 1995, the Task Force on the Promotion and Dissemination of Psychological Procedures included the directed masturbation program for female orgasmic disorder and behavioral treatment for male erectile disorder on their list of well-established treatments. However, further treatment outcome research is needed in order to firmly establish the efficacy of post-modern sex therapy procedures.

See Also the Following Articles

Arousal Training ■ Assisted Covert Sensitization ■
 Aversion Relief ■ Couples Therapy: Insight Oriented ■
 Oedipus Complex ■ Orgasmic Reconditioning ■
 Women's Issues

Further Reading

- Heiman, J., & LoPiccolo, J. (1988). *Becoming orgasmic: A personal and sexual growth program for women (revised and expanded edition)*. Englewood Cliffs, NJ: Prentice-Hall.
- Leiblum, S. R., & Rosen, R. C. (2000). *Principles and practice of sex therapy* (3rd ed.). New York: Guilford Press.
- Masters, W. H., & Johnson, V. E. (1970). *Human sexual inadequacy*. Boston: Little, Brown.
- O'Donohue, W., Dopke, C., & Swingen, D. (1997). Psychotherapy for female sexual dysfunction: A review. *Clinical Psychology Review, 17*, 537-566.
- O'Donohue, W., Swingen, D., Dopke, C., & Regev, L. (1999). Psychotherapy for male sexual dysfunction: A review. *Clinical Psychology Review, 19*, 591-630.
- Zilbergeld, B. (1999). *The new male sexuality* (Rev. Ed.). New York: Bantam Books.

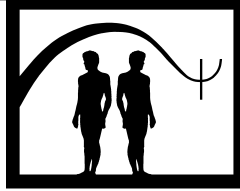

Short-Term Anxiety-Provoking Psychotherapy

John Tsamasiros

P. & A. Kyriakou Hospital, Athens, Greece

- I. Description of Treatment
 - II. Theoretical Bases
 - III. Empirical Studies
 - IV. Summary
- Further Reading

GLOSSARY

clarification The procedure aiming at the restructuring and differentiation of information brought by the patient to make certain points more easily understood.

compromise formation Connotes the product of the unconscious process in which the instinctual gratification (i.e., the discharge of sexual and aggressive instinctual impulses) and the demands of the opposing defensive forces are mutually satisfied through a compromise that partially expresses both tendencies allowing the repressed impulse to find expression in a substitute and disguised form (e.g., symptomatic phenomena).

confrontation The procedure that makes the phenomenon in question evident and explicit, aiming at the overcoming of the evasive and defensive tactics.

defense mechanisms The automatic, complex, and largely unconscious operations (e.g., repression, displacement, reaction formation, projection, etc.) used by the ego as a means of protection against internal (e.g., unacceptable wishes) or external (e.g., events, such as a loss, that elicit anxiety or painful affects) danger situations, aiming at the adaptive restoration of equilibrium.

dynamic Refers to the point of view according to which mental phenomena represent the outcome of a continuous conflict between opposing forces in general (i.e., the id, the

ego, and the superego), and between the unconscious phenomena seeking discharge and a rigorous censorship (i.e., repression) aiming at their exclusion from conscious awareness in particular.

ego The agency of the psychical apparatus that mediates between the id, the superego, and the external reality, aiming at adaptation.

flight into health The phenomenon in which the resistant patient may exhibit a premature and temporary improvement of personal difficulties as a result of the unconscious wish to evade a further psychodynamic exploration of these conflicts.

focalization Refers to the active and collaborative attempt of the patient and the therapist to stay within the confines of the agreed-on focus and to work toward the attainment of specific therapeutic goals. Focalization is instrumental in the shortening of the treatment.

id The agency of the psychical apparatus that contains the instinctual drives.

interpretation The procedure of making the unconscious conscious.

object relations Refers to the distinctive organization of an individual's inner representational world, which stems from his or her interpersonal and developmental history and determines the mode of the individual's intrapsychic and interpersonal functioning. Furthermore, the term object relations, denotes the interplay between the external reality (i.e., interpersonal interactions with actual persons) and the patterns of inner mental representations (i.e., internalized object relations emerging from the interaction of the self with the external object). An inner mental representation is a mental image of the self or an object (self-representation or object representation), which constitute

a complex enduring, cognitive structure within the ego, comprised of dynamic and effective elements. In psychoanalytic theory the term object refers to an actual person, or a thing, or an inner mental representation.

Oedipus complex Refers to the developmentally fundamental constellation of largely unconscious drives, defenses, thoughts, affects, and object relations relating to the child's wish to possess exclusively the parent of the opposite sex, which elicits feelings of rivalry, jealousy, and hostility toward the parent of the same sex and fears of severe retaliation (e.g., castration, loss of parental love) by the perceived rival parent.

Oedipal issues The derivatives of compromise formations (e.g., maladaptive coping strategies) and patterns of object relations (e.g., triangular interpersonal relationships) stemming from an unresolved Oedipus complex.

past-present link The process in which the therapist synthesizes the material brought by the patient in such a way as to help the patient understand the unconscious link between the past feelings for important people and the transference feelings for the therapist (therapist-parent or past-transference link), enabling the patient to utilize the insight to appraise personal behavior from a novel causative perspective, and to achieve a disconfirmation of the non-realistic inappropriate mode of viewing significant people in present life that entangles the patient in circular dysfunctional self-defeating patterns of relating and interacting.

psychodynamic The terms psychodynamic and dynamic are used interchangeably (See dynamic).

regression Denotes a return to an earlier, more developmentally primitive mode of mental functioning.

resistance Any kind of action, thought, or affect, which represents a manifestation of the patient's conscious or unconscious defensive functions and opposing forces, against treatment and the therapeutic progress in general, and the process of making the unconscious conscious in particular.

superego The agency of the psychical apparatus consisting of parental injunctions and inhibitions, as well as ideals and values.

therapeutic alliance The necessary condition for the progression of the psychodynamic work, consisting of an alliance between the patient's higher developmental ego processes and the therapist's facilitating analyzing ego, which alternately signifies the patient's capacity for empathic attunement and active involvement in a joint effort toward the overcoming of the patient's emotional conflicts, and further activates the patient's ability to work cooperatively and purposefully toward the accomplishment of the therapeutic goals.

transference A general, spontaneous, and universal phenomenon consisting of the process of unconscious displacement of feelings, impulses, defenses, thoughts, attitudes, expectations, and patterns of interaction derived from past interpersonal relations onto a person in the present. Transference is characterized by multiformity and ambivalence (i.e., co-existence of opposite feelings), and depending on

its prevailing characteristics can be distinguished in positive (e.g., affectionate) and negative (e.g., hostile). The treatment situation fosters the development and expansion of transference, which is utilized explicitly, and helps in making feasible the resolution of conflict.

transference cure The phenomenon in which the patient may demonstrate an ephemeral symptomatic improvement in an unconscious effort to please the therapist as a result of a developing positive transference.

working through The repetitive process of assimilation and utilization of insight, aiming at the progressive elaboration and overcoming of the resistances that prevent the establishment of enduring adaptive structural, emotional, and behavioral changes.

Short-term anxiety-provoking psychotherapy (STAPP) is a radical, specialized, and research-based type of short-term dynamic psychotherapy (STDP) developed by professor of Psychiatry Peter Sifneos at the Harvard Medical School for the treatment of appropriately selected patients. This article presents the basic technical and theoretical principles of STAPP, as well as, a brief discussion on the research findings concerning treatment's effectiveness.

I. DESCRIPTION OF TREATMENT

STAPP is a kind of brief therapy based on psychoanalytic principles. The psychoanalytic principles include the analysis of transference, resistances, defense mechanisms, and unconscious processes, with the threefold aim of (a) investigating patient's psychodynamics, (b) facilitating the maturational process through the acquisition of insight (i.e., by making the unconscious conscious), and (c) working through the unconscious factors that hamper the accomplishment of the therapeutic goals.

Dr. Sifneos named his technique short-term anxiety-provoking psychotherapy (STAPP) to give emphasis to the basic technical component of his technique that consists of the constructive utilization of anxiety toward the obtainment of a higher level of psychical organization (i.e., increased capacity for anxiety, frustration and ambiguity tolerance, predominance of more adaptive ego defenses, better elaboration and reconciliation of inner conflict, improved affect regulation) and the attainment of more adaptive modes of coping. The STAPP therapist through the appropriate use of anxiety-provoking interventions (clarifications, confrontations, interpretations) is able to increase the emotional intensity during the session and to maintain patient's anxiety at an optimum

level in which it can be utilized as a motivational force toward (a) the understanding of the nature of the nuclear emotional conflict (i.e., the specific emotional conflict—such as the Oedipal conflict—underlying the patient's psychological difficulties) and the recognition of the maladaptive defensive reactions used to deal with it, (b) the achievement of emotional reeducation, and (c) the acquisition of new learning and problem-solving techniques, in a brief period of time. The treatment can be successfully completed in 6 to 14, or at most 20 sessions.

The technique of STAPP consists of specific and intertwined components, which form four successive phases: (a) the patient–therapist encounter, (b) the early therapeutic phase, (c) the central therapeutic phase, and (d) the later therapeutic phase and the termination process.

A. The Patient–Therapist Encounter

The patient–therapist encounter includes two fundamental parameters: (a) the development of a facilitating therapeutic context, and (b) the psychiatric evaluation.

1. *The development of a facilitating therapeutic context:* In STAPP particular emphasis is placed on the development of a strong collaborative relationship between the patient and the therapist. The therapist is very active throughout the treatment. Through the judicious alternating of empathic, anxiety-provoking, supportive, and didactic interventions the therapist is able to establish rapport, to maximize the therapeutic alliance, and to utilize the positive transference to create a safe environment in which self-understanding, new learning, emotional reeducation, and change can take place. This involves the education of the patient about: (a) the importance of the establishment of a full, active, and joint cooperation for the specification, understanding and resolution of the patient's difficulties, (b) the requirements and the focal, goal-oriented, problem-solving, anxiety-provoking nature of the treatment and the ensuing resistances, and (c) the patient's psychodynamics concerning the therapeutic focus. The STAPP patient is considered capable of cooperating efficiently with the therapist focusing on the goal of resolving the emotional conflicts underlying the difficulties successfully over a short period of time, while the attainment of the mutually agreed therapeutic goals is viewed as a joint problem-solving venture.

2. *The psychiatric evaluation represents a global assessment of the patient's personality organization and psychopathology, which consists of five integral components:*

a. *The assessment of patient's presenting complaints:* The evaluator's primary task is to help the patient organize the presentation of chief complaints (i.e., by making the proper questions, and by emphasizing the importance of clarity, specificity, and immediacy for the successful outcome of their joint effort) and to assemble information concerning their onset, development, intensity, duration, sequence, timing, precipitating factors, as well as, other pertinent issues, to form a clear picture of the patient's problems. The presenting complaints of STAPP patients include interpersonal difficulties, specific, mild psychological symptoms, such as anxiety, depression, grief reaction, chronic procrastination, obsessive preoccupation, monosymptomatic phobia, as well as, physical symptoms of psychological origin (e.g., headaches).

b. *The systematic developmental history taking:* The evaluator through the judicious use of open-ended and forced-choice questions is able to obtain a clear and cohesive picture of the patient's emotional development on a longitudinal basis. The history taking follows a successive order from early childhood to the patient's current life. The evaluator investigates certain areas, such as the earliest memories, childhood relations with parents and other family members or key persons, the early family atmosphere and structure, the school history, interpersonal patterns and experiences during puberty, adolescent and early adulthood, the history of sexual development, and the medical history. The systematic history taking is crucial for (a) the identification of areas of conflict, maladaptive reactions, and repetitive difficulties, and (b) the understanding of the emotional problems in psychodynamic terms, which in turn, enables the evaluator to present to the patient a psychodynamic reformulation of his or her presenting complaints.

c. *The using of the appropriate selection criteria:* The evaluator uses five clear-cut criteria for the assessment of patient's ego strength, through which it can be established that the particular patient can be successfully treated in a short period of time. The STAPP candidate must have (a) the ability to circumscribe the presenting complaints (i.e., the patient, with the appropriate support and preparation by the therapist, must be able to make a compromise and to choose one out of a variety of problems for eventual resolution), (b) a history of at least one meaningful relationship (i.e., altruistic, give-and-take) during childhood, (c) the ability to interact flexibly with the evaluator (i.e., to be willing to consider the other person's view and be able to express positive or negative feelings openly and appropriately during the interview), (d)

psychological sophistication (i.e., above-average intelligence and psychological mindedness), (e) a motivation for change, and not for only symptom relief. Motivation for change indicates the patient's willingness to work hard during the treatment assuming an active responsibility concerning the therapeutic task. According to Dr. Sifneos, the patient's motivation for change is probably the most important of all the selection criteria because it has a prognostic value concerning the therapeutic outcome. The evaluation of the patient's motivation for change is assessed on the basis of seven subcriteria: (a) a willingness to participate actively in the evaluation process, (b) honesty in self-reporting, (c) an ability to recognize that symptoms or difficulties are psychological in origin, (d) introspection and curiosity (i.e., self-inquisitiveness), (e) demonstration of openness to new ideas and ability to change, explore, and experiment, (f) realistic expectations of the results of psychotherapy, and (g) willingness to make a reasonable and tangible sacrifice (i.e., the patient is able to make a compromise concerning the appointment time or the fees of therapy) to achieve a successful outcome.

d. *The formulation of a specific focus for the psychotherapy*: The evaluator on the basis of the information offered by the patient constructs a dynamic formulation of the nuclear conflict underlying the emotional difficulties around which the treatment will revolve. The best therapeutic results can be achieved when the foci of the treatment relate to unresolved Oedipal conflicts, grief reactions, and certain difficulties relating to loss and separation issues. Concerning the unresolved Oedipal conflicts, which represent a common focus in STAPP, Dr. Sifneos proposed that there are three categories to be considered: in Category A the patient's attachment to the parent of the opposite sex is based only in the patient's fantasies of being the favorite child, while in reality there is no evidence of an actual encouragement by the parent; in Category B a more complex condition is presented that involves a reinforcement of the Oedipal attachment by the opposite-sex parent; and in Category C, which is the most difficult to resolve, Oedipal issues involve a complicated condition in which there is a combination of a strong reinforcement of the Oedipal attachment and an actual replacement of the parent of the same sex (i.e., as a result of divorce or death).

e. *The "therapeutic contract"*: The evaluator presents the therapeutic focus to the patient and expects an agreement about the resolution of the emotional conflicts underlying it. In addition the outcome criteria are formulated (these involve the

specific therapeutic goals on which the success of the treatment will be evaluated). The mutual agreement concerning the therapeutic focus strengthens the patient's motivation to assume an active responsibility in expanding self-understanding and utilizing the insights to achieve the desirable emotional change. STAPP involves weekly, face-to-face, 45-min-long interviews, which take place at a mutually convenient specified time. The therapist informs the patient that the therapy will be brief but no specified number of sessions is set.

B. The Early Therapeutic Phase

In the early therapeutic phase, the patient's positive feelings for the therapist predominate. The most important technical principle involves the early utilization, and the vigorous and explicit analysis of patient's positive transference feelings. This procedure enables the therapist to establish the development of past-present links and to strengthen the therapeutic alliance.

C. The Central Therapeutic Phase

The central therapeutic phase represents the height of STAPP. The therapist uses repeated anxiety-provoking questions, confrontations, and clarifications in an effort to stay within the confines of the agreed on therapeutic focus, and to establish past-present links that constitute the fundamental technical aspect in STDP. A basic innovative unusual technical aspect of STAPP has to do with interpretations in the form of hypotheses prior to the analysis and clarification of resistances and defense mechanisms. The therapist utilizes the anxiety, which is elicited by the focal interpretive activity, to make explicit the emotional conflicts underlying the focus, as well as, to help to increase the patient's motivation for the acquisition of new more effective problem-solving strategies and for the resolution of old problems. Thus the patient is able to explicitly understand in which way his or her present mode of interpersonal relations is affected by the unconscious repetition of past interpersonal patterns. The patient's expanding awareness over hidden conflicts, fantasies, feelings, needs, and defensive operations, helps the patient to be able to exercise responsibility and control over them. Consequently the therapist by challenging the patient's neurotic entanglements and by providing empathic understanding and encouragement is able to support the patient's capacity to tolerate conflict and to explore new solutions to emotional conflicts. Through this procedure the therapist helps the patient to develop self-understanding and achieve emotional growth.

Even though it has been established through the careful evaluation process that a STAPP patient is sufficiently motivated to decisively achieve the therapeutic goals in a brief period of time, the emotional intensity of the anxiety-provoking focal interaction and the unpleasant realizations, may at times elicit strong resistance and evasive tactics. The therapist through careful note taking records certain verbatim statements of the patient, and at times of resistances is able to repeat the patient's exact words to present the facts which consolidate the patient's interpretations. Another technical tool, which is used for the resolution of the resistance-related impasse, is "recapitulation." This involves the presentation of a synopsis through which the therapist explicates how he or she arrived at the particular conclusion, based on the information that has been provided by the patient. Furthermore, the therapist by reviewing the recorded notes is able to make short-term predictions about the course and future development of treatment.

Patient's resistances and evasive tactics may include discussion of issues that are not relevant to the focus, or regression-like reactions (e.g., the patient may present him- or herself in a state of an apparently overwhelming anxiety) that actually represent a "pseudo-regression." It should be remembered that a STAPP patient has sufficient ego strength and anxiety tolerance. Under those circumstances the therapist's task is to explain to the patient the importance of focalization for the success of their specific agreed-on therapeutic goals and to reestablish the focus. The therapist through the active and systematic avoidance of early characterological issues (such as passivity, dependency, acting out, and manipulative tendencies), which may be used defensively, is able to prevent the emergence and the establishment of actual regressive modes of relatedness, and to accomplish the resolution of patient's nuclear conflicts within a short period of time.

As the therapeutic work is progressing the patient gradually internalizes the therapeutic processes. The demonstrated ability of the patient to utilize the assimilated knowledge to develop new attitudes and behavior patterns, as well as, to generate novel effective ways of dealing with past and present problems, is evidence of progress.

D. The Later Therapeutic Phase and the Termination Process

In the later therapeutic phase the therapist's task is to look out for tangible evidence of change, as well as, to make sure (e.g., through the exploration of specific examples brought by the patient) that the patient's im-

provement does not represent a fortuitous change, or a flight into health, or a transference cure that involve a superficial and transient symptomatic improvement without a clear-cut understanding of the psychodynamics concerning the emotional conflicts underlying the presenting difficulties. The acquisition of sufficient insight about the focal conflicts results in the establishment of tangible evidence of change and signals that the time has come for the termination process. Consequently the termination of the treatment takes place promptly when both patient and therapist agree that the basic therapeutic goals have been accomplished.

II. THEORETICAL BASES

STAPP is based on psychoanalytic theoretical premises consisting of six viewpoints: the topographical, the dynamic, the structural, the genetic, the economic, and the adaptive. A person's behavior or symptoms are interpreted as disguised representations of underlying unconscious processes (topographical viewpoint). The patient's difficulties or symptoms are viewed as an outcome of a conflict and a dynamic interaction in general, and a maladaptive compromise formation in particular (dynamic viewpoint), between: (a) the warded-off pleasure-seeking instinctual drives stemming from the id, (b) the restrictions by the reality-oriented ego that institutes defense mechanisms to maintain psychic equilibrium, (c) the prohibitions imposed by the super-ego (structural viewpoint). In addition, the patient's current conflict and maladaptive pattern of behavior are seen as parts of a continuum from infancy to adulthood (genetic or developmental viewpoint), consisting of two fundamental interrelated factors: (a) the nature of progressions, regressions, and fixations (economic viewpoint) in relation to the psychosexual development (oral, anal, Oedipal, latency, and genital stage), and (b) the quality of interpersonal relations and environmental influences and circumstances to which the individual adjust and to which he or she acts on (adaptive viewpoint).

Dr. Sifneos developed STAPP, while he was the director of the Psychiatry Clinic (from 1954 to 1968) at the Massachusetts General Hospital (a teaching hospital of Harvard Medical School). The prototype for STAPP was a 28-year-old male patient complaining of an acute onset of nervousness and phobias for all forms of transportation, who came to the clinic, requesting therapy to overcome his fears and be able to get married during the next 3 months. Dr. Sifneos decided to proceed with a therapeutic regimen that was successfully completed

in eight sessions. A subsequent follow-up established that a lasting characterological dynamic change had taken place and patient's focal problems had been resolved. The successful results of this treatment encouraged Dr. Sifneos to look at the patient's character structure systematically and to develop criteria for selection of appropriate candidates to receive a similar psychotherapy. It was in this way that the evaluation process was developed, as well as, the anxiety-provoking technique. In sum the evaluation, techniques, and outcome, which were studied and improved over the years have made STAPP a systematic comprehensive and useful psychotherapeutic treatment.

III. EMPIRICAL STUDIES

STAPP represents the oldest type of brief therapy based on systematic research in the United States, and its effectiveness has been validated by several follow-up studies in United States and Europe. Between 1960 and 1987 Dr. Sifneos conducted extensive controlled research studies. These involved follow-up investigation of "experimental" patients who were immediately treated, and wait-list "control" patients who received treatment after a period of time. Impressive follow-up findings were presented, and studies in Europe showed similar and significant long-term follow-up results, as reported in 1985 by Dr. Ragnhild Husby in Norway.

An important educational and research tool in STAPP is the use of videotapes, which Dr. Sifneos called the "microscope of the psychiatrist." The videotape of the evaluation, the treatment, and the follow-up of patients who are willing to participate in research and to give an informed consent, makes the accomplishment of a detailed and systematic analysis of the therapeutic process and outcome, as well as, the accurate comparison of the pre- and the posttreatment condition feasible. The assessment of the efficacy of STAPP in follow-up studies is based on the evaluation of eight specific outcome criteria concerning patient's improvement in psychological or physical symptoms, interpersonal relations, self-understanding, the acquisition of new learning, the development of new effective problem-solving strategies, self-esteem, work or academic performance, and the development of useful new attitudes. According to follow-up outcome studies the STAPP patients after termination are able to efficiently utilize the new learning and problem-solving skills that they have assimilated during their treatment, through a process which Dr. Sifneos called "internal-

ized dialogue," to solve new problems. This process, which facilitates continuous growth and maturation relates to the patient's ability to reconstruct the therapeutic dialogue with the therapist, to reproduce a therapeutic problem-solving effect for the resolution of new difficulties.

IV. SUMMARY

Short-term anxiety-provoking psychotherapy (STAPP) is an innovative, specialized, and systematically studied type of short-term dynamic psychotherapy (STDP), developed by Professor of Psychiatry Peter Sifneos at the Harvard Medical School. It is based on psychodynamic theoretical premises and constitutes the treatment of choice for the resolution of mild neurotic symptoms in appropriately selected patients. The basic technical principles include the establishment of a therapeutic focus, the use of anxiety-provoking interventions, the early utilization of positive transference feelings for the consolidation of a therapeutic alliance and the establishment of past-present links, the avoidance of characterological issues for the prevention of the development of regressive modes of relatedness, and the achievement of an early termination. STAPP is characterized by the establishment of clear-cut specific criteria for the selection of patients (i.e., circumscribed focus, history of a meaningful relationship, flexible interaction with the evaluator, psychological sophistication, and high motivation for change), and the evaluation of the therapeutic outcome (i.e., improvement in symptoms, in interpersonal relations, in self-understanding, in new learning and problem-solving strategies, in self-esteem, in work or academic performance, and in the development of new effective attitudes). The effectiveness of STAPP has been documented by extensive research studies in the United States and Europe.

Acknowledgements

The author gratefully thanks Dr. Peter Sifneos for reviewing the manuscript and offering his valuable comments and advice.

See Also the Following Articles

Brief Therapy ■ Confrontation ■ Interpretation ■ Object-Relations Psychotherapy ■ Oedipus Complex ■ Resistance ■ Supportive-Expressive Dynamic Psychotherapy ■ Working Alliance ■ Working Through

Further Reading

- Brenner, C. (1973). *An elementary textbook of psychoanalysis*. New York: International Universities Press.
- Glover, E. (1953). *The technique of psychoanalysis*. New York: International Universities Press.
- Husby, R., et al. (1985). Short-term dynamic psychotherapy. *Psychotherapy and Psychosomatics*, 43, 1–32.
- Langs, R. (Ed.). (1981). *Classics in psychoanalytic technique*. New York: Jason Aronson.
- Sifneos, P. E. (1968). Learning to solve emotional problems: A controlled study of short-term anxiety-provoking psychotherapy. In R. Porter (Ed.), *The role of learning in psychotherapy* (pp. 87–96) Boston: Little, Brown.
- Sifneos, P. E. (1972). *Short-term psychotherapy and emotional crisis*. Cambridge, MA: Harvard University Press.
- Sifneos, P. E. (1984). The current status of individual short-term dynamic psychotherapy and its future: An overview. *American Journal of Psychotherapy*, 38(4), 472–483.
- Sifneos, P. E. (1987). *Short-term dynamic psychotherapy. Evaluation and technique*. New York: Plenum Medical Book Company.
- Sifneos, P. E. (1992). *Short-term anxiety-provoking psychotherapy. A treatment manual*. New York: Basic Books.
- Sifneos, P. E., Apfel, R. J., Bassuk, E., Fishman, G., & Gill, A. (1980). Ongoing outcome research on short-term dynamic psychotherapy. *Psychotherapy and Psychosomatics*, 33, 233–241.

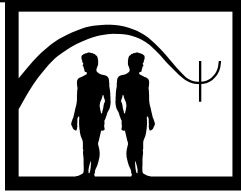

Single-Case Methods and Evaluation

Graham Turpin

University of Sheffield

- I. Approaches and Methods
 - II. Clinical Research and Practitioner Applications
 - III. Basic Principles of Single-Case Design
 - IV. Summary
- Further Reading

In particular, a set of principles underlying the implementation of the single case design within clinical practice is described.

GLOSSARY

external validity Concerns the extent to which experimenters can generalize their findings from one particular set of observations (e.g., individual clients, settings, therapists) to another.

idiographic The study of the individual. Common themes are identified by looking for similarities that emerge across individual profiles.

internal validity Concerns the extent to which observations of change can be interpreted as direct evidence that an intervention had a specific effect on the clinical outcome.

nomeothetic The study of groups of individuals. A common theme is extracted from the collective behavior of the group. This is usually based on the average of the group's responses.

Single-case methods can be defined with respect to psychotherapy, as a collection of techniques for evaluating the efficacy of a specific intervention(s) within a single clinical case or a series of cases. This article overviews the range of approaches and applications of these methods to psychotherapy research and practice.

I. APPROACHES AND METHODS

The fundamental questions within psychotherapy research about which treatments are the most effective or what works for whom are frequently mirrored in the mind of the clinician. Am I using the right approach with this client, are they really showing signs of improvement, should I be adopting a different approach? These questions and doubts are answered through the experience and judgments that clinicians make when reflecting on their practice either alone or when in supervision with other therapists. Nevertheless the search for evidence that therapy has been effective has always been part of the process of psychotherapy.

How can we reliably and objectively demonstrate clinical change within the individual? On a day-to-day basis, effectiveness of our interventions are demonstrated via our own perceptions of what seems to work; the satisfaction of the client that may be expressed verbally in terms of compliments or complaints; behaviorally by gifts, nonattendance, and the unplanned discontinuation of therapy; by comments from carers and relatives; or by peer evaluations during the process of "supervision" or clinical audit. However, do these sources of information really constitute evidence of effectiveness? Even if clinical

change is observed, how confident are we that it was our own specific intervention, as opposed to a myriad of other influences ranging from the client's family through to other possible interventions of the multidisciplinary team, that brought about the real change? Single-case experimental designs have been developed in an attempt to provide proof of effectiveness within the individual. Accordingly, it can be argued that these techniques should provide therapists with an objective means of demonstrating the efficacy of their interventions. As such, they represent one approach to evidence-based practice that the psychotherapists might exploit to demonstrate their own effectiveness to a sometimes skeptical world.

Originally, evidence was presented in the form of what has become known as a "case study," which usually included an extensive account of the client including background history and problems, what happened within therapy frequently based on a session-by-session account, and also the therapist's attempts to understand and account for the process of therapy as described. Indeed, the case study became the major vehicle for documenting the nature of psychotherapy and communicating advances in the understanding of therapy to other practitioners. This approach is typified particularly within writings on psychoanalysis and the classical case studies published by Sigmund Freud.

Although case studies continue to be written, particularly during the course of training psychotherapists, today they are no longer considered as providing sufficient evidence that a particular therapy has been effective. Essentially they have been superseded by what are considered as more scientifically rigorous methods. Generally contemporary clinical research is based around the study of large samples of individuals who have been exposed to various different therapeutic approaches or regimes. So-called robust research methods have been developed relying on double blind procedures and randomized control trials to answer and further tease apart the questions of psychotherapy efficacy. Nevertheless there are circumstances when it is still appropriate to ask questions of effectiveness within a single client by a single therapist. This might arise in the course of developing an innovative therapeutic technique, treating a rare condition, or even as a means for therapists to satisfy themselves and others that their therapy has been effective. The purpose of this article is to describe methods that have been developed for systematically evaluating clinical evidence within the single client.

Single-case methods represent a wide range of approaches that have been used extensively across many different areas of study. The intensive study of the indi-

vidual, as opposed to the usual nomothetic approach of studying groups of individuals, can be readily identified across a range of different disciplines. The clinical case study is widely used within medicine and other clinical disciplines, but individually focused research strategies are also commonplace within educational research, experimental psychology, and sociology. Moreover, although it is common within psychology as a discipline to criticize single-case idiographic approaches on the grounds that they fail to generalize to groups of individuals, many basic laws of behavior within psychology have arisen by the careful and intensive study of just a few selected and usually well-trained individuals. With respect to psychotherapy, single-case methods can be defined as a collection of techniques for evaluating efficacy of a specific intervention(s) within a single clinical case or a series of cases.

The range of applications of single-case approaches is also reflected in a diversity of methods. Even the use of the term "case study" extends from anecdotal reports of therapy published in books through to the publication of brief clinical reports in journals, and formal presentations of case studies. The latter are frequently used as assessments of assumed clinical competence within many forms of psychotherapy training. However, in 1981, Alan Kazdin in a now-classical journal article criticized the traditional clinical case study for being biased and unscientific. The subsequent demise of the clinical case study has given way to a range of more scientifically focused techniques, which are commonly described as "single-case experimental designs." These approaches commonly involve the comparison of data derived from a baseline period prior to when no intervention has been offered, with data obtained from an intervention period. The use of a follow-up assessment some months or years following the treatment is also frequently undertaken. These approaches are often termed AB designs, the letters referring, rather confusingly, to baseline (A) and intervention (B), respectively. Because they usually involve the collection of large amounts of data collected daily over time, they are also referred to as "time series" designs. The comparison between baseline and treatment is also frequently repeated either giving rise to "ABAB" designs or the use of several different measures concurrently that are termed "multiple baseline or phase designs." Occasionally, these designs will be repeated across a small series of individuals and this approach is called "a small N design."

In addition to the quantitative experimental approaches described earlier, the case study has also been developed to yield a range of qualitative methods that

are commonly used within sociology. Indeed, observational case studies of particular services or institutions have resulted in dramatic insights and changes in attitudes. A classic example is Erving Goffman's ethnographic study of institutional life conducted in the 1950s and 1960s. Although qualitative approaches are not the main focus of this entry, their potential for understanding therapeutic processes are becoming increasingly recognized by psychotherapy researchers.

II. CLINICAL RESEARCH AND PRACTITIONER APPLICATIONS

Single-case experimental designs have a wide range of applications, which ought to prove useful to both researchers and practitioners. From a clinical research perspective, not every piece of clinical work will be treated as a potential piece of psychotherapy outcome research. Similarly, most practitioners will not be participating in psychotherapy outcome research. As a means of bridging this gap whereby practitioners become more involved in psychotherapy research, it could be argued that evaluating efficacy within a single clinical case is the bottom line as regards "evidence-based medicine." Indeed, it maybe that single-case methods are about to experience a renaissance as the requirements of demonstrating both the evidence base and clinical effectiveness for specific psychotherapy practices becomes more prevalent due to the influence of the "managed care" movement. David and Robin Morgan have recently made such an argument within an article in the *American Psychologist*.

A. Clinical Research Applications

There are several situations when therapists have a particular reason for evaluating their own work and communicating its outcome within the public domain. The most common reason for employing single-case designs is when the therapist is engaged in an innovative approach to therapy and wishes to disseminate through scientific publication the results of this new treatment approach. Single cases have provided the starting points for many commonly used therapeutic techniques that are widely employed today. For example, the cognitive treatment of panic disorder owes its origins to a series of single cases on the use of rebreathing and reattribution techniques published by David Clark and his colleagues some 20 years ago. Similarly, the cognitive therapy of psychotic symptoms was first published in 1994 by Paul

Chadwick and Max Birchwood as a single-case series. Although these publications by themselves do not meet the full rigors of evidence-based medicine they have provided useful starting points for more systematic approaches to therapy. Indeed, in the case of both these examples, evidence from single-case studies has now been superseded by the findings from randomly controlled trials. Within psychotherapy outcome research, therefore, the single case plays a pivotal position as providing a starting point for the development of new therapies. It is also seen as a means by which regular practitioners may involve themselves in research because the demands of single-case methods tend to be less resource hungry than psychotherapy group evaluations.

Another reason for employing single cases includes the study of rare clinical conditions whereby the limited availability of clients precludes a group evaluation approach, especially in the first instance. Examples of this particular strategy include the evaluation of behavioral treatments of tic disorders and the in-depth investigation of neuropsychological patients with specific and unique head injuries. Single cases can also provide important illustrative material particularly about the practical implementation of new treatment approaches. Such accounts are frequently to be found in the appendices of published studies, which have relied on more traditional group evaluative approaches to outcome research. One particularly, important area for the use of such case material is when therapy is ineffective. Single-case approaches have much to offer the study of treatment-resistant cases. However, the degree to which unsuccessful cases are published and discussed tends to be limited by the implicit bias of scientific journals only to publish positive results. This form of bias may seriously distort the perceived efficacy of treatments, which have been evaluated using single-case approaches. It is usual, therefore, that only positive accounts of new treatment strategies are published at the expense of negative findings. A typical example of this involves the use of "ear plugs" to control auditory hallucinations in psychosis whereby singular and enthusiastically published positive results have tended to give way to later publications of case series that have been more skeptical and negative.

B. Practitioner Applications

The adoption of a single-case approach to clinical work may also have some benefits for clinical practice that are completely independent of research. For example, these approaches can be employed to demonstrate

individual effectiveness of a particular approach to skeptical colleagues or managers. Within the context of cognitive behavioral work, using single-case approaches for data collection facilitates a collaborative relationship between therapist and client that can enhance both the client's motivation and "self efficacy." The approach enables client and therapist to sit down together to identify agreed treatment goals, decide on how individual outcomes should be assessed, and how the impact of therapy can be monitored. It is acknowledged, however, that such an open and goal-directed approach to treatment would not be consistent or appropriate for all forms of psychotherapy.

The demonstration of clinical change using objective measures can be particularly important when working indirectly with care staff. Many researchers have demonstrated that staff's subjective perception of clinical change is frequently biased and may not match more objective change measures, especially for chronic or irregular problems. It has been suggested that this might be due to "recency or memory effects," whereby care staff's perceptions are determined by recent events that then makes it difficult for them to track accurately change over an extended period of time. The use a single-case approach allows a more objective assessment to take place. This can be particularly useful in motivating and informing staff that their efforts do yield positive effects particularly with individuals with challenging and chronic or even deteriorating problems who have previously been resistant to change.

Social work educators have argued that the use of evidence-based techniques such as single-case methods might also enhance the overall effectiveness of practitioners. They have suggested that training in single-case methods enhances clinical skills associated with assessment, formulation, and the implementation of therapy. If this were the case, the routine use of single-case approaches would not only provide the evidence of therapy efficacy but would also lead to enhanced effectiveness. To test these ideas effectiveness of various intervention programs have been compared when therapists have been differentially trained in and encouraged to use single-case approaches. Preliminary evidence from this research would suggest that training in these techniques does enhance therapy and that clients also may have a preference and greater satisfaction for working with a practitioner trained in single-case methods.

Finally, it is commonly believed that single-case methods can only be used by therapists working in either a behavioral or cognitive-behavioral framework. Although, it is undoubtedly the case that many exam-

ples of single-case work are published within behaviorally oriented journals, this doesn't have to be the case. Single cases have been studied using a wide variety of different therapeutic frameworks. What is required, however, are that certain goals of therapy can be established, that they are measurable in some way, and that there is a framework (e.g., formulation) that links the therapeutic model to intervention, together with some hypotheses relating to clinical change. The basic principles underlying single-case work will be further elaborated in the next section.

III. BASIC PRINCIPLES OF SINGLE-CASE DESIGN

Single-case experimental designs rely on several widely recognised and important principles, which have been widely discussed in classic texts such as David Barlow's and Michael Hersen's book published in 1984. These usually include: (a) repeated measurement, (b) stable baselines, (c) single and well-specified treatments, (d) reversibility, and (e) generalizability. To understand implementation of single-case designs, it is essential to appreciate the relevance of these principles. Moreover, it is these characteristics that distinguish the experimental single case from the ordinary case study. If a clinical study is unable to address these principles, it is likely that it will be classified as a case study.

Before expanding on the relevance of the earlier principles it is important to understand what a single-case design is attempting to accomplish. As emphasized by Alan Kazdin and others, the traditional case study is flawed because it relies on post hoc explanations that can be subject to different sources of bias and alternative interpretations. The purpose of single-case design is to identify these potential sources of bias, and control for their influence, and in so doing, to eliminate them as potential alternative explanations for the observed pattern of results that constitutes the case study.

What are the potential sources of confounding that might obscure the interpretation that a particular intervention has had a specific effect within a client on a particular outcome? For example, if during the course of therapy a client's relationship breaks down or a colleague alters the level of prescribed medication, to what extent is any clinical change a function of the therapy provided, the relationship difficulty experienced by the client, the change in medication or a combination of all three? Although some might argue that to attempt to disentangle these factors may be totally artificial, the

single-case design attempts to place on the case study certain limits or boundaries that might distinguish or minimize the impact of these confounding variables.

A. Threats to the Validity of a Case Study

One of the foundations of experimental design in psychology is the identification of confounding variables that need to be controlled to rule out alternative accounts of a study designed to test particular hypotheses. These sources of confounding are frequently referred to as threats to internal and external validity. Internal validity concerns the extent to which the findings can be interpreted in support of the proposition that an intervention had a specific effect on the clinical outcome. A series of possible scenarios exist that if present would severely compromise the study and limit the validity of the conclusions drawn. These circumstances include the following:

- *History*: Here extraneous concurrent events (e.g., relationship break-up, change in medication) may happen alongside the clinical intervention studied. These events may either be known or unknown to the experimenter.
- *Maturation*: This refers to a change process, which may be endogenous to the client and independent of the applied experimental intervention or treatment. For example, neuropsychologists and physiotherapists frequently attempt early interventions aimed at facilitating recovery from brain injuries such as a stroke or a closed head injury. However, if left “untreated,” most individuals with head injuries show a degree of spontaneous recovery in functioning following the injury. Any measurement of clinical change must, therefore, be interpreted against a moving baseline of endogenous change associated with recovery.
- *Testing (reactivity)*: The exposure of a client to the assessment process itself is not a neutral act, particularly when structured forms of assessment such as questionnaires or self-monitoring diaries are employed. The very task of inviting the client to self-assess requires a possible shift in self-awareness and focusing on possible new information. The nature of questionnaires might seek to clarify a client’s understanding or attribution of events and by doing so, challenge their existing attributions and explanations. Thus, the very act of participation and assessment within a case study may bring about therapeutic change. Indeed, such changes are fre-

quently observed during the baseline phase prior to the introduction of any formal intervention.

- *Instrumentation (reliability)*: Nearly every assessment tool, which a clinician will employ, will have associated with it some error of measurement, and it is, therefore, important that these incidental changes in measures across time are not misinterpreted as specific treatment effects.

Other sources of internal confounding include regression to the mean, multiple intervention problems, and instability.

Threats to external validity have also been identified as important sources of confounding that require experimental control. These concern the extent to which experimenters can generalize their findings from one particular set of observations to another. With respect to case studies, generalization refers to the degree to which a finding observed within a single individual can be extended to other individuals and in other settings. Essentially, two sources of bias that might limit generalizability may be identified:

- *Selected individuals/samples*: The degree to which individuals or samples are specifically identified will limit the generalizability of the findings. The more heterogeneous the sample from which individual cases are drawn, the more likely that the results will generalize across individuals. In the case of psychotherapy, the importance of generalizing across variables such as social class, education, gender, and ethnicity will be important for establishing the widespread applicability or otherwise of psychotherapeutic approaches throughout across service provision.
- *Biased interventions/settings*: The setting or the specific manner in which an intervention is delivered might affect the specific outcome within a particular individual. For case studies, the issue here is one of clinical replication. Are results obtained within specialized research clinics by presumably highly trained therapists, generalizable to practitioners attempting to replicate similar interventions within routine clinical practice?

These threats to validity need to be carefully considered by researchers wishing to employ single-case designs. Only by being aware of these threats, can the researcher consider and exclude common alternative explanations regarding the relationship between intervention and outcome. The use of a traditional case study exposes the researcher to a variety of interpretative biases that, at best,

have to be accounted for when interpreting the results and, at worst, may be confounded with specific treatment effects leading to misleading conclusions. To compensate for these biases, “experimental” case study designs have been evolved that attempt to control for or minimize these threats to internal validity. For example, a common control for historical concurrent extraneous events is to repeat or replicate the treatment effect. If a specific treatment-outcome relationship can be observed, and this result is repeated a number of times on different occasions, it is unlikely that some other event unrelated to the intervention will have occurred successively to account for this particular repeating pattern of results. The more consistent the replication of the finding, the less likely it is that some other concurrent event has occurred alongside the specific intervention. Traditionally, group evaluation designs address historical threats to validity by examining replication of findings over a sample of different individuals. For single-case research, the replication is over different occasions within the same individual. Another example of designing against threats to validity concerns maturational effects. As discussed earlier, such endogenous changes may take the form of recovery functions. They may be distinguished experimentally from intervention effects, by observing within an individual the form of the recovery function under baseline conditions in the absence of an intervention, and comparing it following the introduction of the intervention. A specific treatment effect would predict a change in the gradient of any preexisting recovery function.

B. Design Principles

The following principles have been evolved for single-case designs to control for threats to validity and include repeated measurement, stable baselines, single well-specified treatments, reversibility, and generalizability. To understand the rationales underlying these principles, it needs to be acknowledged that their origins extend back to experimental studies of animal learning conducted largely in the middle of the previous century. Essentially, psychologists interested in animal learning conducted single-subject/animal experiments to investigate the effects of changes in various environmental contingencies on patterns of animal behavior. Hence, the knowledge base of animal learning derives very much from single-case experimental studies, together with replications, and has relied predominantly on the visual analysis of the graphical displays of results. This is in marked contrast to group nometothetic approaches, used elsewhere within psychology, and the reliance on statistical testing.

It is these basic principles that have been extended to single-case experimental designs. An obvious reason for this extension was the application of learning theory in the form of applied behavioral analysis to a whole range of human problems, but particularly within the fields of learning disabilities and special education within the United States. This resulted in learning theory paradigms and methodologies being transferred into the clinical domain. It has to be emphasized, however, that the single-case approaches that these methods have inspired, are frequently used to evaluate interventions that are no longer associated with learning theory. In these circumstances, it is possible that rationales developed on the basis of learning theory may no longer apply. An example, which we will return to, is the use of either withdrawal or reversal techniques to demonstrate the specificity of an intervention. From a learning theory perspective, strong evidence of an environmental effect can be demonstrated if the contingencies can be manipulated to obtain withdrawal effects or reversals in the pattern of responding observed. Hence, a particular environmental event (e.g., social praise) could be shown to reinforce particular desirable behaviors (e.g., social interaction) in a young person with learning disabilities, if the behaviors increase when the praise is contingently offered but remains constant or decrease when the praise is withheld. Observation of a direct and repeated effect between the behaviors and the environmental effects provides evidence that the contingencies are reinforcing the behavior. However, this is based on certain learning theory assumptions concerning both the short-term and reversible nature of environmental contingencies. As we discuss later, these assumptions do not apply to the vast majority of interventions that are employed within psychotherapy. The evidence, therefore, that can be gathered from reversal or withdrawal designs is limited only to situations whereby the intervention will have short-term and reversible effects, and if these assumptions cannot be made, then the utility of reversal designs as a principle underlying single case methodology is markedly curtailed.

Bearing in mind the origins and possible limitations of the design principles underlying single case designs, each principle will now be briefly reviewed.

1. Repeated Measurement

Perhaps the most important distinguishing feature between a case study and a single-case experimental study is the number of observations or data points that have been obtained. A basic aim of an experimental study is to demonstrate within each individual intra-subject change

using repeated measures. It is hypothesized that when comparing within an individual measures obtained prior to treatment with those during and following treatment, some therapeutic effect will be observed. The greater number of repeated measures obtained, and the greater the consistency of change across these measures, the more confidence that an effect has taken place. This is analogous to a group design comparing say therapeutic and placebo groups whereby the repeated measures are obtained across the different individuals constituting the groups, as opposed to the single case whereby the repeated measures are derived from a single individual but at many different points in time.

To achieve repeated observations, the measures used have to be easily replicable. This means that they can easily be repeatedly administered, reliable, and relatively free of error or bias. This may discount many traditional forms of psychotherapy outcome evaluation that use extensive psychometric questionnaires or interviews designed only to be used on a single or infrequent sessional basis. Instead, daily measures derived from structured self-report diaries or staff observational schedules are frequently employed. Hence, the case study that includes only a single psychometric measure of pre- and postintervention change should not be considered as a single-case design. However, inclusion of additional repeated daily diary measures would allow such an evaluation to be made. The question arises, therefore, as to what the minimum number of repeated measures has to be obtained? The strict minimum according to Barlow and Hersen is probably at least three baseline and three intervention observations per single measure.

2. Stable Baselines

The basic premise for using repeated measures is that clinical change will be self-evident following the introduction of some therapeutic intervention. The degree to which change is discernible depends both on the magnitude of the therapeutic impact and also on the nature of the preintervention baseline. The greatest confidence about therapeutic impact can only be made when a stable baseline has been obtained. If the baseline is unstable (i.e., it displays an existing trend or slope, cyclical variability or excessive variability or noise), the confidence of detecting therapeutic change is much reduced. It is frequently suggested that baselines should be collected until they demonstrate stability. However, this may not be practical within the psychotherapeutic situation and a frequent question posed is what is the minimum length of baseline acceptable? A review of the size of baselines used in 881 studies published in the *Journal of Applied Behavior Analysis* ranged between 3 and 10

observations. In practice, it is likely that baselines will be obtained perhaps within the second and third sessions as part of an overall assessment process. If derived from daily ratings, it is feasible to collect baseline data ranging from 7 to 20 or so observations across a period of a few weeks that ought to be more than sufficient, although this will depend ultimately on the type of analysis to be employed.

3. Treatments Are Well Specified and Documented

In order to assess the effects of an intervention, it is important that essentially only a single treatment is applied at any one time and that its nature can be specified. Many therapists have difficulties with this limitation because it forces them to assess and formulate the case and prescribe a particular therapeutic approach in advance. However, this does not mean that case reformulation and changes in therapy cannot occur; they need to be, if possible anticipated, and incorporated into the design. Another issue of contention is exactly how is "a single intervention" defined? Again this is the responsibility of the therapist and depends largely on why the case is being evaluated in the first place. Therapists frequently argue that they plan to use a combination of different treatment strategies or techniques. If the aim of the evaluation is to assess the overall impact of this package of strategies, then the package, if it can be defined, becomes synonymous with a "single treatment." Another problem frequently encountered is the presence of other therapeutic work such as medication or other inputs from a multidisciplinary team. Two possible approaches to this common problem are available: to negotiate keeping external therapeutic inputs constant (i.e., no planned changes in medication) or directly involving the other therapists in the design and attempting to evaluate the comparative effectiveness of these other approaches with respect to the psychotherapeutic intervention.

4. Designing against Threats to Validity: Replications, Reversibility, and Withdrawals

A myriad of single-case designs have evolved in an attempt by clinical researchers to rule out the various threats to internal validity that have been previously described. Usually these designs involve complex comparisons of different phases of intervention and baseline manipulated across behaviors, settings, and participants. The logic of many of these designs also originates from applied behavior analysis and the application of fundamental learning theory assumptions. As such it is debatable how relevant this complex myriad

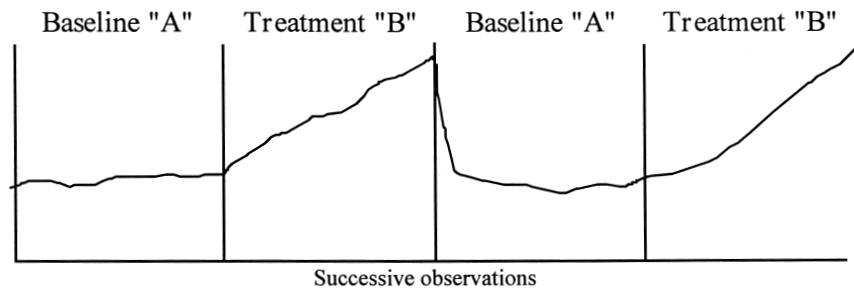

FIGURE 1 Withdrawal and reversal designs. The ideal single case design relies on intrasubject replication and is exemplified by the ABAB withdrawal design. The replication of a treatment effect (i.e., increasing slope) on both occasions that the treatment (“B”) is introduced, and the return to baseline on the second baseline occasion (“A”), are seen as strong evidence that the original treatment effect is real and not spurious.

of designs is for psychotherapeutic applications? Accordingly we have avoided describing these different designs in any great detail. Several of the cited references in Further Reading specify different designs, their rationales, and uses. Instead, we concentrate on the most influential design feature, which surrounds the questions of replication.

It is argued that greater confidence in the impact of treatment on intrasubject change can be demonstrated if the effects can be replicated within repeated measures, across different phases of a design, and that the effect of the intervention on the measures can be directly manipulated through either reversals or withdrawals. Replication is largely a means to protect against either historical or maturational threats to internal validity. Hence, if the results from the simplest AB design (baseline vs. treatment) can be replicated, then it is less likely that some extraneous event can account for the original but replicated change from baseline to treatment. This is in essence the logic of ABAB design (see Figure 1), which is frequently advocated as a standard for experimental single cases. However, within the context of many psychological therapies such designs have important limitations. Essentially, their rationale depends on reversible treatment effects analogous to contingency manipulations employed within applied behavioral analysis. Fortunately, at least for the client, many interventions are considered as long lasting and hopefully resistant to reversal, relying on dynamic intrapersonal changes (e.g., cognitive therapy will promote schema changes). It is, therefore, neither theoretically likely nor ethically desirable that a positive treatment effect can be reversed. Hence, ABAB or ABA designs have their limitations because replication due to withdrawal of treatment and return to baseline may not actually be predicted due to the irreversible nature of the intervention employed.

Non-reversible treatments that are usually identified include psychoeducational approaches, skills-based therapies, schema-directed therapies, altered therapeutic environments, staff attitudes and training, and surgical or long-term pharmacological interventions. Nevertheless, introduction of a brief second baseline can be useful to assess and demonstrate the permanence or otherwise of therapeutic change. This can be practically incorporated into “therapeutic holidays,” whereby clients are encouraged to assess progress by putting aside what has recently been learned or suspending temporarily homework exercises or self-coping techniques. Ethically this is defensible on the principle of demonstrating efficacy to the client of an intensive therapeutic regime. It is also likely, that a second baseline will also be introduced at the termination of treatment in the form of a follow-up to specifically assess the permanence and stability of change. If there has been deterioration in therapeutic improvement, this might argue for the introduction of “booster sessions”: such a protocol would result in baseline and treatment phases not that indistinct from a classic ABAB design. A frequent rejoinder to those that criticize the ethics of single-case designs is that it might be considered a greater ethical problem to conduct psychotherapy in the absence of evaluation per se rather than to attempt evaluation through some manipulation of the therapy itself.

5. Evaluation and Interpretation

It is essential for a single-case design that the therapist has engaged in some critical and systematic evaluation of the data. There have been two competing approaches within single-case research: visual inspection and statistical analysis. Traditionally, single-case data have been analyzed visually using graphical presentation, sometimes presented alongside some simple descriptive statistics such as mean or medians. This tradition derives

very much from applied behavior analysis and emphasizes the utility of complex designs that require phase changes and demonstrate intrasubject replication via reversals and withdrawals of treatment components relative to baseline. However, as the scope for replication based around the assumption of reversible treatments becomes less applicable, some authors have argued for a more systematic approach to evaluation using statistical methods. There has also been a concern that visual inspection might be biased toward “Type one statistical errors” where significant change is expected and inferred but not actually substantiated, and at the same time, biased away from “Type two statistical errors” whereby the inherent variability within single-case data prevents the easy detection of reliable change. Unfortunately, due to a unique statistical feature of single-subject data termed serial dependency, the assumptions underlying most of the commonly used statistical tests are violated and hence, this severely limits their application. Accordingly, application of statistical models of single-case data is a specialized area of evaluation and one that requires serious consideration by the single-case researcher.

Finally, even if change could be reliably inferred between treatment phases and baseline conditions, the meaning of these changes requires interpretation. Due to the design limitations of a single case and threats to both internal and external validity, it is essential that observed differences are not simply considered as treatment effects. The limitations of single-case designs are such that it is essential that the clinical researcher is able to identify and where possible rule out alternative interpretations or threats to validity. It is very unlikely that the rigor of the design will have already excluded these possibilities as maybe the case when employing double-blind, randomized control designs within group comparison studies of psychotherapy outcome.

6. Generalizability

A common misconception about single-case designs is that they involve only a single subject. To derive general explanations or laws of behavior change, effects should be generalizable. The converse of this is that these laws ought to account for known sources of variability, and this is often obscured in group designs. Although a single $N=1$ design has limited generalizability, a series of $N=1$ designs should identify sources of variability and lead to greater generalizability. Different types of generalizability include across individual clients or clients with similar attributes, across different therapists, and across different settings or situations. The issue of generalizability

is resolved, therefore, through replication across different clients, therapists, and settings. Hence, $N=1$ studies lead on to $N=1$ series, small N designs with homogenous subjects and well-controlled conditions. Indeed recent exponents of single-case methods have also described meta-analysis procedures analogous to those used in group outcome studies with which to evaluate and summarize the results from a series of individual studies. Finally, it is also important to ensure that single-case research is not only generalizable but also clinically replicable within ordinary clinical settings.

IV. SUMMARY

We have attempted to review the general principles underlying single-case design and to suggest that they might play a role in helping to establish both the efficacy and effectiveness of psychotherapeutic interventions. Such a methodology might assist psychotherapists to address the combined agenda established by the influential “evidence-based medicine” and “managed care” movements and in doing so, encourage practicing clinicians to evaluate their clinical work and engage in clinical research. However, it should be recognized that much of the work published using single-case methods has derived from more experimentally based psychotherapies and that many of the fundamental principles underlying this approach might be antithetical to some psychotherapies, especially those that are more dynamically oriented. Notwithstanding these potential obstacles to the implementation of single-case approaches, I should like to invite the interested therapist to explore how these approaches might be integrated with their own therapeutic work. To achieve this, it will be important to identify clear clinical formulations, which link to therapeutic strategies. These strategies need to identify various therapeutic goals that can then be assessed as clinical outcomes and reliably and repeatedly measured. In addition, the clinician will also need to be disciplined so as to follow a predetermined therapeutic strategy but also to be sufficiently flexible so as to engage the client and be ready to reformulate and redirect the therapy, as the therapeutic process unfolds.

See Also the Following Articles

Efficacy ■ Outcome Measures ■ Research in Psychotherapy
 ■ Single-Session Therapy ■ Solution-Focused Brief Therapy
 ■ Termination

Further Reading

- Barlow, D. H., & Hersen, M. (1984). *Single case experimental designs: Strategies for studying behavior change* (2nd ed.). New York: Pergamon.
- Bloom, M., Fischer, J., & Orme, J. G. (1999). *Evaluating practice: Guidelines for the accountable professional* (3rd ed.). Boston: Allyn and Bacon.
- Franklin, R. D., Allison, D. B. & Gorman, B. S. (1996). *Design and analysis of single case research*. Mahwah, NJ: Lawrence Erlbaum.
- Hillard, R. B. (1993). Single case methodology in psychotherapy process and outcome research. *Journal of Consulting and Clinical Psychology*, 61, 373–380.
- Kazdin, A. E. (1981). Drawing valid inferences from case studies. *Journal of Consulting and Clinical Psychology*, 49, 183–192.
- Kratochwill, T. R., & Levin, J. R. (1992). *Single case research design and analysis: New directions for psychology and education*. Mahwah, NJ: Lawrence Erlbaum.
- Long, C. G., & Hollin C. R. (1995). Single case design: A critique of methodology and analysis of recent trends. *Clinical Psychology and Psychotherapy*, 2, 177–191.
- Morgan, D. L., & Morgan, R. K. (2001). Single-participant research design: Bringing science to managed care. *American Psychologist*, 56, 119–127.
- Turpin, G. (2001). Single case methodology and psychotherapy evaluation: From research to practice. In C. Mace, S. Moorey, & B. Roberts (Eds.), *Evidence in psychological therapies: A critical guide for practitioners*. (pp. 91–113). East Sussex: Brunner-Routledge.
- Yin, R. K. (1994). *Case study research: Design and methods*. Beverly Hills, CA: Sage.

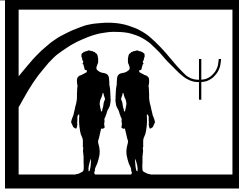

Single-Session Therapy

Brett N. Steenbarger

SUNY Upstate Medical University

- I. Overview
- II. Theoretical Underpinnings
- III. Research Findings
- IV. Summary
- Further Reading

I. OVERVIEW

Single-session therapy is a general term that is used to describe any form of psychotherapy that seeks to address the presenting problems of clients within a single visit. It is hypothetically possible for any form of psychotherapy to be conducted in a single session and, indeed, Freud's case studies include cures that were achieved after one meeting. In practice, however, it is unusual to find either cognitive-behavioral or psychoanalytic brief therapists conducting single-session therapy. This is because the models of change underlying these approaches emphasize the value of repeated experience in building new patterns of thought, feeling, and behavior. The learning models associated with cognitive-behavioral modalities, for example, emphasize the acquisition of skills through deliberate rehearsal. Such practice generally requires more than one visit. (A notable exception would be massed practice in behavioral therapies, where desensitization might be undertaken in a single, extended session, as in the implosive therapy of Levis.) The relationship models underlying brief psychoanalytic therapies stress the importance of creating powerful emotional experiences for clients, which also are rarely undertaken in a highly abbreviated span.

Most single-session therapies draw on contextual models of change that emphasize the constructed nature of client presenting problems. Problems are seen as client construals, not necessarily as illnesses or problems that possess an independent existence. These construals

GLOSSARY

brief therapy Psychotherapy, typically of short duration, in which efficiency in achieving change is an explicit aim. Sometimes referred to as time-effective or short-term therapy.

Ericksonian therapy Psychotherapy, typically brief, derived from the work of Milton Erickson. It seeks to maximize therapist influence through the strategic use of language, the accessing of altered states of mind via hypnosis, and the use of directed tasks.

single-session therapy A form of brief therapy in which there is a planned attempt to address the presenting concerns of clients within a single visit. Often makes use of techniques derived from Ericksonian, strategic, and solution-focused therapies.

solution-focused therapy Form of brief therapy that seeks to identify and/or construct exceptions to client problem patterns and reinforce these as solutions. Inspired by Ericksonian and strategic therapies.

strategic therapy Form of brief therapy that seeks to interrupt and alter self-reinforcing patterns in which attempted solutions to problems actually contribute to their maintenance. Inspired by Ericksonian therapy.

are maintained by elements in the client's intrapersonal and interpersonal contexts and become reified over time. From this perspective, a long-standing problem is not necessarily any deeper than a recent one and might be amenable to short-term treatment. By shifting the contexts in which the client is operating and providing insights and experiences that dislodge problematic construals, therapists can catalyze significant change in a single meeting.

The majority of single-session therapies emphasize the role of the therapist in initiating change, rather than effecting a cure. Although problems can be dislodged and new construals introduced in a single visit, it is generally not possible for clients in single-session therapy to generalize these changes to a variety of life situations. As a result, single-session therapies are not seen as ideal treatment modalities for all people. Commonly cited contraindications for single-session therapy include the following.

- *Chronic, severe presenting problems:* The client with long-standing problems that significantly impair functioning often needs coordinated efforts at rehabilitation, rather than a brief episode of therapy. Although techniques derived from the brief and single-session literatures may be helpful for such individuals, they typically do not meet the full spectrum of client needs.
- *High need for support:* Clients who have poor support systems may want to rely on the therapist as a support and, indeed, may need that support to assist them in leaving an abusive relationship or changing an addictive pattern. A single-session treatment, by definition, cannot offer ongoing support to such individuals and could even prove detrimental to clients with issues related to attachment and separation.
- *Troubled interpersonal history:* Single-session therapies are effective to the degree that they utilize techniques that maximize the influence of the therapist. Clients who have experienced a history of abusive, neglectful, or highly troubled relationships often need an extended period of time before they can learn to trust a therapist. This severely limits the usefulness of single-session work.
- *Low readiness for change:* Clients who are ambivalent about making changes generally need to explore problem patterns and their consequences before developing the motivation to initiate and sustain efforts at change. This generally extends the duration of therapy beyond brief parameters, and certainly beyond the length of a single session.

Although these contraindications are significant, single-session therapies may be more useful for clients than is commonly acknowledged. Studies of utilization of therapy in outpatient settings suggest that approximately one third of all clients only attend a single session, often reporting that the brief intervention was sufficient for their needs. Appropriately utilizing highly abbreviated treatments for clients can preserve resources for others who most need them in capitated settings and clinics with staff limitations. Generally, clients who are the best candidates for single-session therapy display:

- *Adjustment problems, situational problems, and non-severe disorders of recent origin:* Individuals who are not overwhelmed by their presenting problems are most likely to be able to take the results of a single visit and apply them to their lives.
- *High levels of motivation:* Because there will not be future sessions to carry the change process forward, clients who are to benefit from single-session work need to be able to sustain their own efforts at generalization.
- *Awareness of a focal problem:* Limiting therapy to a single session places therapist and client in an action mode from the start. If clients lack a focus for therapy, it is likely that more than one session will be needed to define and implement a therapeutic contract.

Although there are several different approaches to single session therapy, all share features that differentiate them from lengthier brief therapies. These include the following:

- *Beginning therapy before the first session:* A number of writers on single-session work emphasize that change begins at the time the first appointment is made. Often, the therapist will talk with the client at the time of first contact and suggest a task that can be accomplished prior to the first session. By encouraging pretherapeutic efforts at change, therapists can use their single session to focus on positive efforts already under way.
- *Addressing time at the outset of therapy:* Many approaches to brief therapy aim to be efficient but do not expressly address time during the first session. Single-session therapists generally preface treatment with an explanation that one visit is often enough for clients, even as they leave the door open for further meetings as needed.
- *Active attempts to utilize ideas and language introduced by the client:* Single-session therapists do not

have the luxury of stimulating and working through the resistances of clients. Rather, they attempt to build on frameworks already utilized by the client to elicit cooperation.

- *Rapid introduction of impactful interventions:* With a limited time available for catalyzing change, single-session therapists must move quickly from a problem-based mode to one in which new patterns are introduced. Often this is accomplished in ways that will maximize their impact, by employing vivid language, hypnotic suggestions, directed tasks, and novel reframings.

Just as brief therapy appears to represent an intensification of the common factors that account for the effectiveness of all therapies, single-session therapies are, in essence, a distillation of methods utilized in brief treatments. The quick establishment of rapport, rapid definition of a treatment focus, and active introduction of novelty in pursuit of change make single-session therapy a brief version of brief therapy.

II. THEORETICAL UNDERPINNINGS

Much of the writing on single-session therapy owes its inspiration to three strands of practice in the brief therapy literature:

1. *Ericksonian therapy:* A number of authors, including Jay Haley, Richard Bandler, John Grinder, and Stephen Lankton, have attempted to identify the elements of practice that distinguish the work of Milton Erickson. These elements include the creative use of language to influence clients, the introduction of hypnotic trance to shift clients' perception, and reliance on directed tasks to interrupt existing problem patterns. Many of these methods are attempts to bypass the normal, verbal, conscious awareness of individuals and introduce change experientially and emotionally. By affecting clients directly, Erickson found that the duration of therapy could be greatly reduced.

2. *Strategic therapy:* Therapists operating from a systems perspective, including Paul Watzlawick, John Weakland, and Richard Fisch, extended Erickson's pioneering work, creating short-term approaches to therapy that could be used for families and individuals. A central tenet of this strategic approach is that presenting problems are artifacts of self-reinforcing cycles, in which attempted solutions maintain the initial problems. For instance, a spouse hurt and angry over a perceived lack

of attention may attack the partner, producing even further distance. By placing clients in contexts that could not support the self-maintaining cycles, strategic therapists provide powerful experiences that break the old patterns and allow for the introduction of new ones.

3. *Solution-focused therapy:* A new tradition was inspired by the work of Steve deShazer who conceptualized therapy as a search for solutions rather than an exploration and analysis of problems. This solution-focused approach, elaborated by such therapists as William O'Hanlon and Jane and Walter Peller, can be readily adapted to the single-session framework. By focusing on client goals and quickly initiating a search for imagined or experienced exceptions to client patterns, solution-focused therapists are able to quickly move treatment to an action phase, greatly abbreviating the change process.

Common to all three approaches is a postmodern epistemology, which emphasizes that reality is actively constructed, both in the cognitive processes of the individual and in social interaction. When something negative happens on multiple occasions, it becomes an object of attention and may be construed as a problem. Once so identified, the behaviors in question typically elicit further distress and efforts at coping. Many of these dampen distress in the short run, but exacerbate the initial concerns. By introducing novel approaches to the situation, through metaphor, story, or directed task, the therapist aids in the construction of a new reality. This opens the door to more flexible responding and the possibility of developing constructive behavioral patterns.

This postmodern conceptualization of problem formation and change provides much of the rationale of single-session therapies. Many alternate conceptions of therapy emphasize the existence of a problem that must be evaluated and subjected to various therapeutic interventions. The postmodern perspective stresses that the problem, in an important sense, does not exist other than in the eyes of the client; it is part of the client's mental map—not an enduring feature of the landscape. Even relatively small shifts in the map can produce new patterns of thinking, feeling, and acting that can assume a life of their own. This can be observed in the "pivot chords" described by Robert Rosenbaum, Michael Hoyt, and Moshe Talmon, who use ambiguity in client verbalizations to open the door to new ways of construing problematic situations.

An additional theoretical assumption that permeates single-session modalities is the notion that clients essentially possess all they need to overcome their problems.

Rather than view individuals as existing in a deficit state where they need treatment from professionals, single-session therapists emphasize their existing adaptive potentials. This is most clearly seen in solution-focused approaches, in which the emphasis of therapy is on exceptions to presenting problems and patterns. These exceptions may be imagined (“What would life be like if you did not have the problem?”) or may be inferred from the client’s own experience. By framing such exceptions as constructive actions that the client can initiate, the single-session approaches bypass much of the early phase of problem definition and analysis and quickly move to an action stage.

III. RESEARCH FINDINGS

Controlled outcome studies comparing single-session therapy to other forms of intervention have yet to be reported in the literature. Nonetheless, several strands of research represent initial attempts to build an empirical basis for these approaches. Moshe Talmon reports several studies that have found 30% of all clients attending therapy for a single session. Follow-up investigations with those clients found that approximately 80% were satisfied with the limited intervention and reported some or much improvement.

Studies at the Brief Family Therapy Center in Milwaukee have generally supported the effectiveness of solution-focused therapy and have found that pretreatment interventions result in noticed positive change in 60% or more of all clients. This is particularly true of Formula First Session Tasks, which ask clients to observe what is happening when things are going positively. Clients performing such tasks have been found to be more cooperative in therapy than clients not performing the tasks and have reported greater improvement by the second session. Other studies have found that the amount of change-related talk engaged in by therapists and clients is predictive of success.

Although these studies are encouraging, it will remain for controlled outcome studies comparing single-session interventions to other modalities to establish

the long-term success of very brief work and the degree to which outcomes are attributable to specific interventions rather than general factors.

IV. SUMMARY

Single-session therapies are a collection of approaches that attempt to maximize change within a single visit. Most of these approaches owe their genesis to the pioneering work of Milton Erickson and the subsequent development of strategic and solution-focused therapies. Built largely on a postmodern epistemology, they emphasize the constructed nature of client concerns and the role of the therapist in identifying contexts and experiences that allow for alternate constructions. Such approaches are best suited for clients who are motivated to change focal patterns, especially those who are experiencing situational or adjustment concerns and are capable of establishing a rapid therapeutic alliance.

See Also the Following Articles

Brief Therapy ■ Cost Effectiveness ■ Individual Psychotherapy ■ Minimal Therapist Contact Treatments ■ Relapse Prevention ■ Solution-Focused Brief Therapy ■ Termination

Further Reading

- Lankton, S. R., & Erickson, K. K. (1994). *The essence of a single-session success*. New York: Brunner/Mazel.
- Miller, S. D., Hubble, M. A., & Duncan, B. L. (Eds.). (1996). *Handbook of solution focused brief therapy*. San Francisco: Jossey-Bass.
- Rosenbaum, R., Hoyt, M. F., & Talmon, M. (1990). The challenge of single-session therapies: Creating pivotal moments. In R. A. Wells & V. J. Giannetti (Eds.), *Handbook of the brief psychotherapies* (pp. 165–192). New York: Plenum.
- Talmon, M. (1990). *Single session therapy*. San Francisco: Jossey-Bass.
- Watzlawick, P., Weakland, J., & Fisch, R. (1974). *Change: Principles of problem formation and problem resolution*. New York: W. W. Norton.



Solution-Focused Brief Therapy

Anne Bodmer Lutz

Cedarburg, Wisconsin

Insoo Kim Berg

Milwaukee, Wisconsin

- I. Basic Posture
 - II. SFBT Procedures and Techniques
 - III. The Miracle Question
 - IV. Theoretical Foundation
 - V. Follow-up Studies
- Further Reading

GLOSSARY

coping questions Techniques that are designed to empower clients to manage their life more effectively by addressing their coping style.

miracle question Technical intervention in which the client is asked to think in an unlimited range of possibility and to identify changes that they want to see happen.

scaling questions Technical approach that encourages the client to prioritize and put into an ordinal relationship various issues, including efforts to problem solve, as well as problems.

SFBT (Solution Focused Brief Therapy) is an approach to delivering psychotherapy based on a variety of theoretical positions, such as Milton Ericson's ideas and Wittgenstein philosophy of language. SFBT focuses on solutions rather than problems.

Solution-focused brief therapy (SFBT) was developed through the work of Steve de Shazer, Insoo Kim Berg, and their colleagues at the Brief Family Therapy Center in Milwaukee, Wisconsin. It is a model that has

been developed inductively based on 30 years of sessions with clients. It has been used successfully in a variety of settings including rehabilitation centers, psychiatric hospitals, residential treatment centers, child protection agencies, schools, and private practices. This treatment model is based on the hypnotherapeutic work of Milton H. Erickson, as discussed by Haley in 1967, and influenced by the 1974 work of John H. Weakland, Paul Watzlawick, and Richard Fisch of the Mental Research Institute.

I. BASIC POSTURE

As the name suggests, SFBT is defined by its emphasis on solutions rather than problems. Different from problem-based therapies in which a great deal of time is spent assessing problems, understanding in as much detail as possible what a client is doing wrong, or developing hypotheses about what is wrong with the client and family system, and the therapist prescribing solutions, SFBT focuses on finding solutions and gives minimal attention to defining or understanding presenting problems.

A description of the SFBT treatment model includes the following: therapist attitudes, socializing, goal negotiation, miracle question, exception questions, scaling questions, coping questions, and the consultation break and intervention message. In addition, three types of client-therapist relationships are described: visitor type, complainant-type, and customer-type.

Therapists' beliefs and attitudes influence how and what they listen to when talking with clients. SFBT emphasizes attitudes of client competence, and the importance of how language is used in conversation with clients. All therapists, regardless of their approach, come with certain attitudes and philosophies that affect how they do treatment. For example, all therapists are selective in their choice of what they ask about and what they ignore, depending on the underlying assumptions they hold about what is useful and helpful for their clients to talk about. Far from serving the "objective" purpose of "merely" gathering data, the questions therapists actually raise with clients influence and change clients' thinking about themselves. Solutions for clients are not scientific puzzles to be solved by practitioners, but rather changes in perception, patterns of interacting and living, and meanings that are constructed within the clients' frame of reference. The SFBT therapist assumes that clients are competent at conceptualizing an alternative more satisfying future and at figuring out which of their strengths and resources they can draw on to produce the changes they desire. The client is the expert of his or her problems and has legitimate goals and ways to facilitate change. For example, a client with an alcohol problem may want to improve his relationship with his wife and children and may not initially want to stop drinking. Accepting this initial goal as a reasonable first step makes it possible to further examine his desired state of life.

The therapist assumes a collaborative stance, with the client and therapist working together to bring about goals the client decides on. Berg and De Jong in 1996 described exploring and affirming clients' perceptions as clients describe them as a major share of what is done in SFBT. Even when clients are considering extreme actions—suicide or violence—they do so within a context of several associated perceptions. For example, to a client who thinks of hitting a child, an SFBT therapist might say, "What's happening in your life that tells you that hitting your child might be helpful in this situation? What else? Does it work? Suppose you were to do that, what would be different between you and your child? What would be different between you and your other children, the courts, your family?" As clients are respectfully asked about their perceptions, they usually are able to talk about less extreme possibilities. Berg and De Jong in 1996 described the therapist assuming a "not knowing" or curious stance in talking with clients. The therapist is always in the stance of learning the clients' perceptions and explanations, never knowing a priori the significance of the client's experiences and actions.

Finally, the therapist's job is to learn the language of the client. Rather than believing that language describes reality, it is believed that language also conveys information about what the therapist is interested in learning from the client. Being problem focused, clients often use language as if to describe their relationships and experiences, assuming, for example, that "being close" means the same for everyone. Often, although their language is very meaningful to them, it may be vague to a therapist. Clients use language to describe their relationships and experiences. Examples of techniques that begin to clear up the ambiguity are for the therapist to repeat key words used by a client, clarify what a client means by certain words, and use the actual words a client uses in the conversation. The therapist listens carefully for and explores each client's choice of words. This not only demonstrates respect for the client, it also begins a process in which, as therapists speak the client's language, clients begin to speak the solution-focused language of therapists.

II. SFBT PROCEDURES AND TECHNIQUES

All therapy, regardless of model, begins with a phase of socializing and orienting clients to what is to come. de Shazer and Berg describe initial questions directed at areas in which clients are successful or from which they draw satisfaction or esteem. Early on in the conversation, the SFBT listens for and highlights client strengths and successes. For example, beginning a conversation with clients by asking them what they are good at, what they enjoy, their job, hobbies, talents, past achievements, or ambitions for the future begins a dialogue between the therapist and client about identifying issues they both can agree are going well for the client. Client strengths, resources, and abilities are highlighted rather than their deficits and disabilities. This approach tends to look for what is right and how to use it. Asking clients early on what they are good at sets a different conversational path than "what problem brought you here today?" This communicates to the client that the therapist recognizes that even though the client has problems, he or she also has areas that are successful. Often these strengths, although unrelated to the presenting problem, bring early clues about how the client will solve their problems.

Co-constructing goals with clients is a very important feature of SFBT. Clients generally are much more aware of, for example, the problems and what they do

not want in their lives than they are about what they want to be different. Many clients begin the discussion of goals as the absence of problems; however, SFBT conceptualizes goals as the presence of what the client wants. Berg and Miller describe goals as criteria that the client and therapist determine together that would tell them they have succeeded and can end therapy. They include the following: Goals must be important to the client and be viewed as personally beneficial; they must be small enough so they can be achieved; they must be concrete, specific, and behavioral and stated in positive, proactive language about what the client will do instead of what he or she will not do. Goals must also be perceived as involving hard work for the client. For example, instead of drinking, a client may make an arrangement for a designated driver before going out on the weekend, or get to work on time. This is in contrast to a vague goal of improving one's self-esteem or being happy.

III. THE MIRACLE QUESTION

Berg and De Jong describe how the miracle question gives clients permission to think about an unlimited range of possibilities, and identify changes they want to see happen. Because the question has a future focus, it begins to move the focus away from their current and past problems and toward a more satisfying life. The miracle question stated in the following way frequently draws a rich response from clients.

Suppose (pause) after we talk today, you go home (pause) and sometime in the evening you go to bed (pause) and in the middle of the night (pause) while you are sleeping, a miracle happens and the problem that brought you here today is solved (pause), but because this happens while you are sleeping, you don't know that the miracle happened until you wake up in the morning. So when you wake up tomorrow morning, what will make you wonder, "something is different, maybe there was a miracle last night?"

Getting details of the miracle is important and the therapist's follow-up questions are crucial. Asking "what else will be different, what else?" is a helpful question to explore. The more opportunities a client has to rehearse a successful outcome verbally, the more chance the miracle has of beginning in small ways to become real for him or her. The miracle question can be an empowering experience for clients as they begin to imagine a painful life transformed to a more successful

and fulfilling life. The gift of hope and a vision can be a truly healing experience for clients.

Exception finding questions are another tool used in SFBT. An exception to a problem occurs when the client engages in nonproblem behavior (e.g., does not drink, does not feel depressed, and does not fight with his wife). The therapist's job is to listen for and magnify a client's successes through repeated emphasis on those few, but important, exceptions. When repeated often and examined in detail, successes become more real to the client. The client can then begin to see their success and recognize that they actually have taken steps to improve their life. Thus the client can take responsibility and credit for the solution. An example would be exploring in detail those times when a client does not drink: What was she doing?—Who was she with?—Where was she?—What did other people notice during that time? Other questions to ask include inquiring about times when things have gone better between sessions, and helping clients describe times when some pieces of the miracle have already happened before therapy began. Getting as much detail about what was happening during these times (who, what, when, where, how) and including other important persons behaving differently during these times, provide further contextual information in these important moments.

Scaling questions are another useful technique used in SFBT. As deShazer states, "there is magic in numbers." An example of a scaling question is "on a scale from 0 to 10, with 0 representing the worst things could be for you and 10 the day after the miracle, where on the scale would you say you are now?" Frequently, clients will give a rating of "3." The therapist then helps them describe the differences between "0" and "3" and how other people might see those differences, and what it might take to "get all the way up to 3." Suppose a client answers "1." The therapist may respond "How are you able to keep going?" "What gives you the strength to continue?" When a client is asked to put problems, successes, hope, and level of self-esteem on a numerical scale, it gives the therapist useful information about a client's relationships, confidence in change, and self-esteem, and helps to determine an end point for therapy. An example is, "At what number on the scale will you be when things are going well enough that you no longer feel you need therapy?" It can also help the client describe contextual details of his or her experience. An example is, "Where would your mom/dad/best friend/spouse/boss/probation officer say you are on the scale?" Finally, scaling questions can also help clients create small goals for change. Asking a client what will be different when they go from

a 3 to a 4 (not a 10), forces clients to think about taking small, more realistic steps toward change.

Coping questions can also be very useful in SFBT. Questions about how clients are managing their life can be very empowering to clients. Examples, include, "How are you able to keep going when your life feels like it's falling apart?" "How do you manage day to day?" Questioning clients about how they are coping with big problems shifts the conversation from hopelessness to hope and a sense of control. However small it may seem, the small things the client does to "barely cope" are the very things that the client must do more of "one day at a time" in order to create a basis on which to build more successes. "How come you life is not worse?" is used to "blame" the client for their success. Such "positive blame" assigns the responsibility for positive, helpful behaviors to the client.

Frequently, an SFBT session includes a team behind a one-way mirror and the therapist meets with them 10 to 15 minutes before the end of the session to develop a closing message to the client. Working alone (which is the most common practice) and taking a 5 to 10 minute break after 45 minutes of a session allows the therapist to review the session, take time to think about whether there are well-formed goals, and to decide on a feedback message for the client.

SFBT feedback messages include compliments, which are used with all cases and throughout the treatment process. All cultures use compliments as a means of cementing social relationships at all levels. Clients have personal qualities and past experiences that, if drawn on, can be of great help in solving their difficulties and creating more satisfying lives. Compliments can be direct or indirect. During the interview, for example, direct compliments can be developed from times when clients are resilient in the face of hardships, sober for even 1 week, able to hold down a job, care about their children, work hard, or are willing to come get help. Compliments are best when they are based on reality and incorporate the client's language. Indirect compliments are questions that imply that the client has done something positive. For example, "How have you managed to stay sober for one week?" "How have you managed to stay calm when things are so hectic?" This allows clients to speak aloud themselves about the details of their success. When clients are able to speak themselves, they appear more empowered in their ability to find solutions.

Suggestion for homework is frequently prescribed at the end of an SFBT interview. Deciding on what type of intervention to prescribe depends on what stage of relationship the client has with the therapist. SFBT

describes three types of client-therapist relationships: visitor-type, complainant-type, and customer-type. Visitor-type relationships are those in which the client has not yet created a workable goal. Often these clients are mandated through probation officers, employers, or parents. Interventions with these clients focuses on giving frequent positive feedback on what the client is already doing that is helpful and working. Providing these clients with many compliments is often a very different message than what they have frequently heard, and may help make these clients more interested in treatment. Complainant-type relationships involve clients that have created some workable goals, but view their solutions lying outside of their control. In addition to using compliments, suggestions are made to shift the client's perception from someone who is a helpless victim to someone who can create solutions. Interventions encouraging clients to "observe and think" about what they will notice will be different when the miracle happens is an example. Because these clients are observers, but not yet "doers," this meets the client where he or she is. Customer-type relationships are those in which the client is willing to actively "do" something differently, to actually take steps to find solutions in his or her life. Clients are frequently asked to do more of what is working, pay attention to any part of the miracle that is happening, or imagine a miracle day.

IV. THEORETICAL FOUNDATION

The theoretical underpinnings of SFBT come from several sources including social constructionism, Wittgenstein's philosophy of language, and Milton Erickson's ideas on therapy. Social constructionism maintains that people develop their sense of what is real through conversation with and observation of others. Social constructionism holds that reality, as each individual perceives it, is by definition subjective and created through the process of social interaction and the use of language. SFBT asserts that problems occur in interactions between individuals and do not rest within any one individual. People define and create their sense of what is real through interaction and conversation with others, a form of negotiation carried out within the context of language. SFBT helps clients do something different by changing their interactive behaviors or the interpretations of behaviors. This approach makes no assumptions about the "true" nature of problems. SFBT has a strong orientation toward the present and future and further believes that everyone's future is

negotiated and created. How clients are currently living their lives and their future goals are emphasized, thus orienting the client away from the past problem toward the future solution.

This model differs from the traditional “medical model” in a number of ways. Rather than assessing problems, signs, and symptoms, SFBT assesses for solutions, exceptions to problems, and strengths within an individual and his or her social context. It further focuses on past successes, coping strategies, and resources and collaboratively co-constructs a solution with the client.

Language is a resource that is vital to all therapists’ practices and relationships with their clients. The importance of language in SFBT is crucial. Gail Miller and Steve de Shazer in 1998 wrote about how meanings of words are inseparable from the ways in which people use them within concrete social contexts. Problem-focused language emphasizes what is wrong with people’s lives, and frequently portrays the sources of our problems as powerful forces that are largely beyond our control or understanding. In contrast, solution-focused language focuses on finding ways of managing one’s problems. Solution-focused therapists ask, “Since we talk ourselves into problems and solutions anyway, why not emphasize solutions.” This is not to deny the deprivations and injustices in clients’ lives, but to help get through and beyond them. This model uses post-modern assumptions that problems and solutions are talked into being, and meaning is changeable based on our use of language.

V. FOLLOW-UP STUDIES

Having been inductively developed in clinical settings by de Shazer in 1985, Berg in 1994, Berg and Reuss in 1997, and Berg and Kelly, in 2000, rigorous research that shows its effectiveness is only beginning to emerge. There is a great deal of informal studies scattered throughout in a variety of settings. However, a rigorous study design using random selection of population, controlled, and experimental groups, and pre-post measures is just beginning to emerge. We recognize that such data are necessary. What has emerged so far seems to show promise in its effectiveness and cost in terms of human suffering and dollars.

In 2000, Gingerich and Eisengart performed a review of SFBT outcome research. This article critically reviewed a total of 15 studies. Additionally, it reviewed early follow-up studies documenting SFBT outcomes.

Early follow-up studies used follow-up surveys by asking clients at 6 to 18 months whether they had met

their goal. In the first study, de Shazer in 1985 reported an 82% success rate on follow-up of 28 clients. The next year, de Shazer et al. reported a 72% success rate with a 25% sample of 1600 cases. Subsequent studies by De Jong and Hopwood in 1996 and Kiser in 1988 have reported similar results. Other follow-up studies of SFBT have similar, but somewhat smaller success rates and have used subjective outcome measures, such as those by Lee in 1997, Macdonald in 1997, Morrison, Olivos, Dominguez, and colleagues in 1993, and Schorr in 1997. Although these follow-up studies provide feedback on SFBT outcomes, their lack of experimental control does not permit causal inferences to be made about the effectiveness of SFBT.

Gingerich and Eisengart reviewed 15 controlled studies that implemented SFBT, employed some form of experimental control, assessed client behavior or functioning, and assessed end-of-treatment outcomes. These studies were further divided into well-controlled, moderately controlled, and poorly controlled studies based on the number of standards met for assessing empirical support for psychological treatments developed by the American Psychological Association.

The well-controlled studies included studies on depression in college students, parenting skills, rehabilitation of orthopedic patients, recidivism in a prison population, and antisocial adolescent offenders (the studies were those of Cockburn, Thomak, and Cockburn in 1997; Lindfors and Magnusson in 1997; Seagram in 1997; Zimmerman, Jacobsen, MacIntyre, and Watson in 1996; and Sundstrom in 1993). Four found SFBT to be significantly better than no treatment or standard institutional services. Because these studies did not compare SFBT with another psychotherapeutic intervention, they were not able to conclude that the observed outcomes were due specifically to the SFBT intervention as opposed to general attention effects. One study by Sundstrom in 1993 compared SFBT with a known treatment (IPT) and found SFBT produced equivalent outcomes (no significant differences were found). None of the five studies met all of the stringent criteria for efficacy studies and thus one cannot conclude that SFBT has been shown to be efficacious. They do, however, provide initial support for the efficacy of SFBT. The remaining 10 studies contain methodological limitations that preclude drawing firm conclusion, but their findings are consistent with the general conclusion of SFBT effectiveness.

Gingerich and colleagues identify several future areas of need in subjecting SFBT to empirical test. First is the specification and proceduralization of SFBT itself with the consistent use of detailed treatment manuals

and treatment adherence measures. In addition, future efficacy studies will need to compare SFBT with other empirically validated interventions where therapist allegiance is equally balanced between treatments. Other considerations include specification of study sample, selection of the comparison group, adequate sample size, and using conventional diagnostic groupings.

Although the current studies fall short of what is needed to establish the efficacy of SFBT, they provide early support that SFBT is useful to clients, according to Gingerich et al. The wide variety of settings and populations studied suggests a broad range of applications, but this conclusion awaits more careful study.

See Also the Following Articles

Outcome Measures ■ Single Session Therapy ■ Working Alliance

Further Reading

- Berg, I. K. (1994). *Family based services: A solution-focused approach*. New York: Norton.
- Berg, I. K., & De Jong, P. (1996). Solution-building conversations: Co-constructing a sense of competence with clients. *Families in Society: The Journal of Contemporary Human Service*, 77, 376–391.
- Cockburn, J. T., Thomas, F. N., & Cockburn, O. J. (1997). Solution focused therapy and psychosocial adjustment to orthopedic rehabilitation in a work hardening program. *Journal of Occupational Rehabilitation* 7, 97–106.
- De Jong, P., & Berg, I. K. (1998). *Interviewing for solutions*. Pacific Grove, CA: Brooks/Cole.
- De Jong, P. I., & Hopwood, L. E. (1996). Outcome research on treatment conducted at the Brief Family Therapy Center, 1992–1993. In S. D. Miller, M. A. Hubble, & B. L. Duncan (Eds.), *Handbook of solution-focused brief therapy* (pp. 272–298). San Francisco: Jossey-Bass.
- Gingerich, W., (2000). Solution-focused brief therapy: A review of the outcome research. *Family Process*, 39, 477–498.
- Lee, M. Y. (1997). A study of solution-focused brief family therapy: Outcomes and issues. *American Journal of Family Therapy*, 25, 3–17.
- Lindfors, L., & Magnusson, D. (1997). Solution-focused therapy in Prison. *Contemporary Family Therapy*, 19, 89–103.
- Macdonald, A. J. (1997). Brief therapy in adult psychiatry—further outcomes. *Journal of Family Therapy* 19, 213–222.
- Miller, G., & de Shazer, S. (1998). Have you heard the latest rumor about...? Solution-focused therapy as a rumor. *Family Process*, 37, 363–377.
- Seagram, B. C. (1997). *The efficacy of solution-focused therapy with young offenders*. Unpublished doctoral dissertation, York University, York, Ontario, Canada.
- Uken, A., & Sebold, J. (1996). The Plumas Project: A solution-focused goal directed domestic violence diversion program. *Journal of Collaborative Therapies*, IV, No. 2, Summer.
- Zimmerman, T. S., Jacobsen, R. B., MacIntyre, M., & Watson, C. (1996). Solution-focused parenting groups: An empirical study. *Journal of Systemic Therapies*, 15, 12–25.

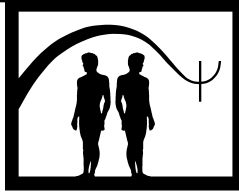

Somatoform Disorders

Ann Kerr Morrison

Wright State University

- I. Description of Treatment
 - II. Theoretical Bases
 - III. Empirical Studies
 - IV. Summary
- Further Reading

GLOSSARY

- behavioral therapy** Psychotherapy directed at changing observable and measurable behavior through a variety of techniques including monitoring, incremental change, shaping, and operant conditioning.
- body dysmorphic disorder** A preoccupation with an imagined defect in appearance.
- cognitive therapy** Psychotherapy directed at identifying and changing dysfunctional thoughts, perceptions, attitudes, and beliefs.
- conversion disorder** A symptom that mimics a neurologic problem (i.e., blindness, paralysis) that is not due to any neurologic problem, other medical condition, or substance but rather is thought to be due to psychological distress from a social stressor or psychological conflict.
- factitious disorder** Physical or psychological symptoms that are intentionally produced to assume the sick role.
- hypnosis** A mental state characterized by relaxation, concentration, and suggestibility in which perception and memory may be altered.
- hypochondriasis** A long-standing worry or fear of having serious illness in which one misinterprets physiologic sensations and minor symptoms.
- iatrogenic** Caused by a physician or his or her treatment.
- narcotherapy** An interviewing and psychotherapeutic technique involving sedative drugs, usually sodium amytal to induce relaxation.
- pain disorder** Pain complaints not completely attributed to a general medical condition. Purely psychological and combined medical and psychological types are described in DSM-IV-TR.
- personality disorder** A pervasive maladaptive pattern of relating to the environment and others that impairs function. Usually personality disorders arise in adolescence or the early adult years.
- primary gain** The decrease in anxiety or other unpleasant feeling attributed to the unconscious suppression of internal drives or conflicts.
- psychoanalytic psychotherapy** Psychotherapy derived from the theories of Freud that emphasizes the use of free associations, dream interpretation, and analysis of transference to bring to awareness repressed emotions and unconscious conflicts. Psychoanalytic psychotherapy focuses these techniques on the current conflicts and problems in the person's life rather than the very early life experiences and conflicts central to classical psychoanalysis.
- psychodynamic psychotherapy** Psychotherapy that incorporates a role for unconscious conflicts and motivations in human behavior but also recognizes the influence of life experience, current situational stressors, and biological predisposition in determining behavior. Techniques and issues emphasized are more varied than in either classical psychoanalysis or psychoanalytic psychotherapy.
- secondary gain** The support obtained from other people or systems due to a symptom or illness or the avoidance of an unpleasant, aversive situation due to a symptom or illness.

selective serotonin reuptake inhibitor (SSRI) Antidepressants that prevent the neuron from recycling serotonin released into the synaptic cleft, thereby increasing the amount of serotonin present at the synapse.

serotonin A neurotransmitter implicated in many mental disorders, especially major depression and obsessive-compulsive disorder.

social learning theory The theory that individual behavior is determined in large part by behaviors one has observed in others.

somatization The general process of presenting physical symptoms and concerns that are not explained by a general medical illness presumably as a manifestation of psychological distress or conflict or social stress.

somatization disorder A long-standing disorder involving multiple physical complaints and many organ systems usually developed at an early age and stable over time.

somatoform disorders The *Diagnostic Statistical Manual of Mental Disorders* category describing disorders that involve physical symptoms not attributable solely to general medical conditions or substances.

supportive therapy Psychotherapy directed at reinforcing a patient's defenses as a way of improving the ability to cope with psychological distress.

I. DESCRIPTION OF TREATMENT

Treatment of individuals with somatoform disorders represents a unique challenge for the psychotherapist in that the core deficit in these individuals is the inability to recognize the role of psychological and social conflicts and stressors in the development of their physical symptoms. These individuals are unlikely to present to psychotherapists for treatment initially and are often resistant to referral for psychiatric or psychological consultation. For many patients with somatoform disorder, the most important therapeutic relationship remains the primary care physician. The mental health consultant may assist this physician in maintaining a therapeutic stance with these often taxing and frustrating patients. For instance, the psychiatrist in this consultant role may assist the physician and patient by confirming the diagnoses and advising the referring physician about the general principles of management of somatoform disorders:

1. Maintain regular, consistent contact with a single physician.
2. Minimize invasive diagnostic procedures and aggressive treatments without objective evidence of physical disease.

3. Gradually, and in a nonconfrontative manner, work toward helping the patient recognize the connection between stressors in their lives and their physical symptoms.

The process of somatization is not limited to individuals with somatoform disorders. Other disorders, especially depression and anxiety disorders, frequently present with prominent somatic symptoms. In addition, individuals with somatoform disorders often suffer from other mental disorders such as depression, anxiety, and personality disorders. Treatment of these co-existing disorders may improve the individual's function even when the somatoform disorder persists.

The somatoform disorders, as described in *DSM-IV-TR* are a heterogeneous group of disorders that currently are lumped together due to the common characteristic of a physical complaint or complaints that are not completely explained by a general medical condition or a substance. Included in this category are somatization disorder, undifferentiated somatoform disorder (an abridged form of somatoform disorder), conversion disorder, pain disorder, hypochondriasis, body dysmorphic disorder, and somatoform disorder not otherwise specified (a residual category for presentations that do not fulfill criteria for the other somatoform disorders). Somatoform disorders vary greatly in the number and type of symptoms presented and systems affected, the duration of symptoms, the age of onset, the gender distribution, and the prognosis. In contrast to factitious disorder, the physical symptoms are not believed to be intentionally produced. Treatment approaches, for somatoform disorders, although unified by the general management principles already described also vary. Despite the fact that many of these disorders, especially somatization disorder (also known as hysteria, or Briquet's syndrome), conversion disorder (also named conversion reaction or hysterical conversion), and hypochondriasis have received much attention in the history of psychotherapeutic theories and treatments, there remains a dearth of well-controlled psychotherapeutic trials specific to each disorder. A general summary of treatment approaches for the principle types of somatoform disorder follows. Details of these treatments are discussed under the Empirical Studies section.

A. Somatization Disorder

Somatization disorder is characterized by the onset at an early age, usually late teens to early 20s but by

definition by age 30 of multiple physical complaints. Females are afflicted over males by a ratio of 10 or 20:1. The disorder by definition has been present greater than 6 months. This disorder has in the past been known as Briquet's syndrome or hysteria. The complexity of the criteria has diminished over the years but still requires the presence of multiple symptoms involving several organ systems. The typical patient has had many surgeries at an early age, preceded by multiple workups for a variety of physical complaints. These individuals seldom seek psychiatric or psychological treatment because from their point of view, their problems are physical not mental in nature. In addition, to multiple surgeries and procedures, these patients may also suffer from iatrogenic side effects from a multitude of medications. Direction to the family physician to schedule regular, not as needed appointments, which include focused physical exams, to minimize testing and treatments and to gradually shift the focus of attention from physical complaints to stressors in the patient's life may help decrease health care utilization and avoid complications of procedures and treatments. Group therapy aimed at coping with the stress of a chronic medical condition has also been recommended. In a group setting, these individuals are said to be capable of recognizing and confronting this pattern of somatizing to an extent not possible in individual therapy. In addition, they may benefit from the support of others with similar conditions.

B. Conversion Disorder

Conversion disorder is characterized usually by only one symptom at a time, and this symptom, by definition, mimics neurologic disease. Historically, the type of symptoms has extended beyond those that mimic neurologic disease but neurologic-like symptoms (seizures, paralysis, numbness, deafness, or blindness) have always also been the most prominent. Commonly, the patient has both underlying diseases as well as conversion symptoms. Conversion disorder also is more common in women than in men and is found in both chronic (greater than 6 months) and acute (less than 6 months) forms. Due to the relatively high rate at which individuals either are later diagnosed with neurologic disease or have concurrent neurologic disease, the recommendation to minimize workups to exclude organic causes, generally made for somatoform disorders, is not applicable to conversion disorder. However once this workup is completed, the same principles of supportive, benign management prevails. Most authors advo-

cate a nonconfrontative yet authoritative explanation that recovery is expected over a relatively brief period of time. An explanation that medical tests do not show signs of any serious progressive disease should be provided without confrontation or argument and without suggesting that the problems are "all in your head." These straightforward prescriptions for recovery allow most individuals to return to normal function. In cases in which suggestions and reassurance alone do not result in recovery, physical rehabilitation and other behavioral techniques such as relaxation and rest may be added. If the stressors presumed to be responsible for the conversion symptom in the first place cannot be ascertained from a standard history, then interviewing techniques such as narcotherapy or hypnosis may be used. The primary purpose of identifying the stressors is to be able to modify them through therapy. Narcotherapy and hypnosis may also be used to enhance the suggestion and expectation of recovery from the conversion symptom. Longer-term psychodynamic therapy is advocated by some for those individuals with chronic or recurrent conversion symptoms. Given that the stressor may well include marital or family issues therapy aimed at these areas may also be necessary.

C. Hypochondriasis

The essential feature of hypochondriasis is fear or worry that a symptom (often a minor physiologic sensation) represents a serious illness. This disorder is equally common in men and women. By definition, this preoccupation with disease must be present for longer than 6 months. The same general principles of conservative management with the primary care physician as principle clinician apply. Treatment of concurrent anxiety and depression is important. Cognitive therapies aimed at diminishing the focus and attention of these patients on physical sensations and reinterpreting these sensations as non-disease events has been used individually and in a group therapy format. Framing these therapies as techniques for dealing with physical distress, rather than a more direct psychological approach, may have positive results.

D. Body Dysmorphic Disorder

The essential feature of this disorder is a belief that a physical attribute is deformed or defective. These patients also do not seek mental health treatment but rather see dermatologists, plastic surgeons, and orthodontists. Psychotherapy using cognitive-behavioral

techniques has seen the greatest use in recent years. Pharmacotherapy, particularly antidepressants which inhibit reuptake of serotonin into neurons, has also been shown to be effective.

E. Pain Disorder

Pain, even when the underlying cause is established, has long been known to be influenced by the psychological and social context in which it is experienced. Likewise, psychological techniques, as well as somatic treatments have long been known to modify the experience of pain. The overlap between pain disorder described as a somatoform disorder (those for which psychological factors are thought to play a major role in pain either alone or combined with a general medical condition) and pain due solely to a general medical condition is great. Pain disorder will not be dealt with extensively in this article, but the management principles of carefully coordinating care with one physician, minimizing potentially dangerous evaluations and treatments (especially addictive drugs and radical surgeries), focusing on improving function despite pain rather than curing all pain, and gradually helping the patient recognize the role of stressors in symptom exacerbation share much in common with management of the other somatoform disorders. Although pain management must be carefully coordinated by a primary physician, the multiple techniques employed often require a multidisciplinary team. Behavior therapy is the psychotherapy employed at least initially in most pain programs.

II. THEORETICAL BASES

As mentioned earlier, the disorders currently considered somatoform are quite varied. Historically, they have been united by an assumption that they represented the physical expression of an unrecognized underlying psychic conflict or a reaction to a social stressor. For somatoform disorders, the production of physical complaints is not believed to be under voluntary control as would be the case for a factitious disorder. More recent theories about the development of somatoform disorders have shifted to the role that social learning, amplification of bodily sensations, and even genetics may play. For somatization disorder, there appears to be a link between childhood trauma, especially physical abuse, illness as a child, growing up with an ill family member, and an increased likelihood of developing this disorder. Family studies of somatiza-

tion disorder in females link it with sociopathy and alcoholism in male relatives. The great importance of establishing a therapeutic alliance, usually with a family doctor, which does not depend on ongoing physical complaints or illness behavior to be maintained ties together many of these etiologic theories. It is postulated that for many of these individuals, being ill themselves was the only way to either receive nurture and care or to avoid or counter mistreatment or abuse. Unfortunately, the frustration that these patients can engender in physicians and the invasive tests and procedures that they demand may easily lead to further abandonment or punishment-like experiences. Some neuropsychological studies indicate individuals with somatization disorder may have deficits in attention and memory as well as frontal lobe dysfunction and greater nondominant hemisphere dysfunction.

Conversion disorder contains in its definition an implication of the etiologic role of stress or conflict in the development of symptoms. These symptoms have been conjectured to have symbolic meaning, that is, being unable to hear due to a torrent of past verbal abuse or being unable to move one's arms after killing another in war or in an accident. However, studies have been unable to uphold this conjecture. Similarly, the belief that patients with conversion present with a "la belle indifférence," showing little reaction or emotion to great impairment has not shown to be more characteristic of conversion symptoms versus impairment, due to an organic cause. The presence of secondary gain, whereby, the patient either derives some positive attention or care for the impairment or avoids some aversive responsibility or consequence, also was once believed to discriminate conversion symptoms from other medical conditions, but this does not appear to be true. Psychosocial factors that increase the likelihood of conversion symptoms include sexual abuse, exposure to medically ill relatives, lower social economic status, less education and a rural background, and having a neurological illness oneself. Theoretical outlook has shifted from one emphasizing unconscious conflicts, that is, aggression, sexuality, dependency, which are symbolically expressed to decrease anxiety and are complicated by a resistant indifference and secondary gain, to one that retains the idea that conflicts and stressors play a critical role in development of conversion symptoms but view these as more transparent to both the therapist and the patient. Treatment has shifted emphasis from longer uncovering insight-oriented psychodynamic psychotherapy to brief supportive therapy, which emphasizes suggestion, reassurance, and the prediction of recovery. This is sometimes coupled

with behavioral and physical therapy approaches to address any issues of secondary gain, deconditioning, and other physical sequela and allow a face-saving mechanism for the patient to use in recovery. Psychodynamic therapy is still recommended by some for more chronic or relapsing cases of conversion symptoms.

Theories regarding the development of hypochondriasis include not only how it arises, but also whether it is a discreet disorder or simply a manifestation of other psychiatric illnesses such as anxiety or depression. With respect to anxiety disorders, analogies have been drawn between hypochondriasis and panic disorder, (both are sometimes involved in misinterpretation of normal physiologic sensations), hypochondriasis, and obsessive-compulsive disorder, (both incorporate the need to constantly check and be reassured that something bad hasn't happened with only temporary abatement of anxiety once reassured), and hypochondriasis and generalized anxiety disorder, (both are characterized by overreacting to and dwelling on common worries, often accompanied by physiologic symptoms of muscle tension, aches and pains, and hypervigilance). Somatic presentations of depression also show considerable overlap with hypochondriasis. Comorbidity is common, and treatment for concurrent conditions, for example with SSRI antidepressants may improve patients' overall function and in some cases ameliorate the hypochondriacal symptoms themselves. Psychodynamic theories have included a variety of beliefs including Freud's theories of object libido and later disturbed object relations, in which anger toward others is displaced as hostility toward the body. Other dynamic theories have described guilt, dependency needs, the need to suffer, as well as anger and hostility toward others as important in hypochondriasis. More recent psychological theories have focused on mechanisms of social learning and cognitive and perceptual distortions such as amplification, either alone or in combination. Hypochondriacal patients seem to misattribute normal physiologic sensations as evidence of underlying disease and believe to be free of serious illness one should be relatively free of any symptoms or distress. They are not, as they believe, more sensitive or accurate in detecting bodily sensations or symptoms, but rather they make errors of misattribution and overreporting. Because these patients then inaccurately identify themselves as ill, they then view themselves as entitled to assuming the sick role.

A direct or indirect experience with the sick role is thought by some to be an etiologic factor in development of hypochondriasis, however, data does not exist to confirm this theory. Cognitive-behavioral therapies

have been developed to address the misperceptions and misattribution which hypochondriacal patients make. These therapies may be more successful and better accepted in the setting of a general medical clinic. As with somatization disorder, the initial focus of therapy may be on coping with physical distress rather than a more overtly psychological approach. The general management principles used for somatization disorder (for instance regular appointments with a single physician and minimizing testing procedures and treatments) are essential for hypochondriasis.

Body dysmorphic disorder has shared with hypochondriasis the debate whether it is a discreet disorder or arises from a spectrum of mood or anxiety disorders, especially obsessive-compulsive disorder. Recent successful treatment approaches with SSRI antidepressants and cognitive-behavioral therapies reinforce the belief that body dysmorphic disorder may be etiologically related to depression and/or obsessive-compulsive disorder. As with the other somatoform disorder, psychodynamic theories regarding the dysmorphic symptoms representing a displacement of a conflict on a body part had been made. Some have also commented on the role that societal preoccupation with appearance may play in the development of body dysmorphic disorder.

As noted earlier, the experience of pain has long been recognized to have a number of psychological, physical, and social determinates. Description of the specific theories of pain is beyond the scope of this article.

III. EMPIRICAL STUDIES

Because the somatoform disorders are quite different one from another, empirical studies typically focus on one specific syndrome, and the results from studies of one disorder should not be generalized across the entire category. With respect to general management principles of somatoform disorders, the most study has been done on somatization disorder. G. Richard Smith and coworkers in 1986 described the positive effects on decreasing health care utilization, without worsening health outcomes or changing patients' satisfaction with care, using psychiatric consultation followed by a letter to the referring primary care physician. The letter describes somatization disorder and recommends management with regularly scheduled appointments, physical exam at each visit, avoiding tests and procedures unless clearly indicated, and discourages physicians from telling patients "It's all in your head." This group published in 1995 a similar study on somatizing

patients who did not meet full criteria for somatization disorder, showing similar positive results following a psychiatric consultation letter. The active ingredient here may be education of and support to the primary care physician. The importance of the therapeutic alliance between the primary care physician and the somatizing patient may need to be attended to in a way not formally done in most primary care settings. The primary care physician is coached to offer an analog of the "holding environment" more common psychotherapy settings. That is, to find a safe, predictable forum for the patient to present their distress albeit in the form of physical symptoms without fear of being rejected or abandoned by or overwhelming the physician, and without the sometimes unrecognized danger of being subjected to unnecessary tests and treatments.

When patients will accept overt psychological treatment, either individually or in a group setting, cognitive-behavioral therapies have been shown to improve the function of patients with somatization disorder as well as the other somatizing patients. As noted earlier, these patients may accept referral for these treatments when they are framed as "stress management." Disorders that have been shown to respond to cognitive-behavioral therapies include somatization disorder, hypochondriasis, body dysmorphic disorder, pain disorders, as well as a number of other illnesses in which somatic complaints figure prominently, including chronic fatigue, irritable bowel, chronic headaches, and non-cardiac chest pain.

Some studies of somatoform disorders, especially hypochondriasis, have attempted to answer whether or not these patients experience physiologic sensation differently or whether the error of somatization occurs secondarily in the area of interpretation, attribution, and reporting. Attempts are beginning to be made to discover whether these differences are learned or genetically determined. Explanatory therapy, an approach that emphasizes educating patients with accurate information about somatic sensations, including instruction regarding the amplification due to selective attention, providing reassurance and clarification and using repetition of this information was advocated by R. Kellner in the 1980s and was reintroduced in 2000 by G. A. Fava and colleagues for the treatment of hypochondriasis. They believe it is a simpler approach than cognitive-behavioral therapy and found it effective in a study of 20 patients.

Conversion disorders, sporadic and usually time-limited impairments, by nature have led to a relative lack of randomized control trials of therapeutic approaches. Anecdotal reports and clinical experience have led most to advocate suggestion and the expecta-

tion of recovery along with behavioral and physical therapy approach.

Supportive therapy to help patients identify and modify the psychological stressor postulated to be responsible for the conversion symptom may also be helpful. Sodium amytal interviews and hypnosis are also employed. However, well-controlled trials regarding these techniques for conversion disorder cannot be found. Further complicating studies is the broad range of conversion symptoms and the varying degree of functional impairment, for instance, hemi-paresis versus pseudo-seizures. Taking into account the methodological weaknesses, there appears to be the most empiric support for suggestive and behavioral approaches. Amytal and hypnosis, although enjoying a long tradition of use for assessment and treatment of conversion disorder, suffer from the lack of control trials regarding efficacy. Some advocate there is enough suggestion of positive result utility that further studies are warranted. K. A. Phillips summarizing psychotherapeutic approaches for body dysmorphic disorder relates that cognitive-behavioral therapy including cognitive restructuring, exposure, and response prevention have been shown effective in body dysmorphic disorder. However, these studies have small numbers of participants, and as with other somatoform disorders more studies are needed.

In contrast to the few studies on body dysmorphic disorder, pain management has a relatively large literature. Pain disorders respond to cognitive-behavioral techniques, which include both cognitive restructuring and operant conditioning. Further review of the empiric studies of pain disorders is beyond the scope of this article.

IV. SUMMARY

The treatment of somatoform disorder involves both commonalities and differences. Those disorders that involve a chronic view of oneself as physically ill, somatization disorder and hypochondriasis, frequently present only to the primary care physician and the management principles of regularly scheduled rather than symptom dependent visits have already been summarized. Also critical is the avoidance of unnecessary diagnostic and therapeutic procedures and interventions. Those somatoform disorders in which a specific distortion of thinking can be identified, hypochondriasis and body dysmorphic disorder, are amenable to cognitive techniques aimed at this belief as well as behavioral therapy to change inappropriate behavioral responses such as reassurance seeking. Conversion disorder usually responds to suggestion, reassurance, and expectancy. Behavioral

and physical therapy may enhance these general techniques. Pain disorder is best treated psychotherapeutically with cognitive-behavioral techniques. Although the somatoform disorders, especially somatization disorder, hypochondriasis, and conversion disorder provided some of the formative clinical material for psychiatry, especially psychodynamic psychotherapy, in practice psychodynamic therapy rarely finds itself at the forefront of treatment of somatoform disorders. In some cases of conversion disorder, particularly those for which the psychosocial stressor or conflict is not immediately apparent or which have a relapsing course, psychodynamic therapy continues to be utilized. In addition, skills in marital and family therapy are sometimes necessary particularly when somatoform disorders have resulted in patterns of secondary gain that involve couples or family systems.

See Also the Following Articles

Cancer Patients: Psychotherapy ■ Comorbidity ■
Medically Ill Patient: Psychotherapy ■ Pain Disorders

Further Reading

Avia, M. D. (1999). The development of illness beliefs. *Journal of Psychoanalysis and Research*, 47(3), 199–204.

- Barsky, A. J. (1998). A comprehensive approach to the chronically somatizing patient. *Journal of Psychosomatic Research*, 45(4), 301–306.
- Barsky, A. J., Stern, T. A., Greenber, D. B., & Cassen, N. H. (1997). Functional somatic symptoms and somatoform disorders. In N. H. Cassem, T. A. Stern, J. F. Rosenbaum, Jellinek (Eds.), *Massachusetts General Hospital handbook of general hospital psychiatry* (pp. 305–336). Chicago: Mosby.
- Epstein, R. M., Quill, T. E., & McWhinney, I. R. (1999). Somatization reconsidered incorporating the patient's experience of illness. *Archives of Internal Medicine*, 159, 215–222.
- Folks, D. G., & Houck, C. A. (1993). Somatoform disorders, factitious disorders, and malingering. In A. Stoudemire, & B. S. Fogel, (Eds.), *Psychiatric Care of the Medical Patient* (pp. 267–287). New York: Oxford University Press.
- Ford, C. V. (1983). *The somatizing disorders: Illness as a way of life*. New York: Elsevier Biomedical.
- Martin, R. L., & Yutzy, S. H. (1997). Somatoform disorders. In A. Tasman, J. Kay, & J. A. Lieberman, (Eds.), *Psychiatry* (pp. 1119–1155). Philadelphia: W. B. Saunders.
- Servan-Schreiber, D., Kolb, R., & Tabas, G. (1999). The somatizing patient. *Primary Care*, 26(2), 225–242.
- Smith, G. R., Rost, K., & Kashner, T. M. (1995). A trial of the effect of a standardized psychiatric consultation in health outcomes and costs in somatizing patients. *Archives of General Psychiatry*, 52, 238–243.
- Waurick, H. M. C., Clark, D. M., Cobb, A. M., & Salkouskis, P. M. (1996). A controlled trial of cognitive-behavioral treatment of hypochondriasis. *British Journal of Psychiatry*, 169, 189–195.

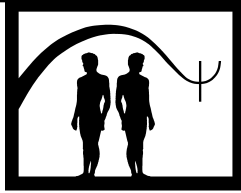

Sports Psychotherapy

Todd C. O'Hearn

Yale University

- I. Performance Enhancement and the Role of the Sports Psychologist
 - II. Family Therapy and the Athlete
 - III. Life Span Development of the Athlete
 - IV. Drug Use among Athletes
 - V. Eating Disorders among Athletes
 - VI. Rehabilitation from Athletic Injury
 - VII. Neuropsychological Assessment and Concussion
- Further Reading

GLOSSARY

anorexia athletica Unofficial diagnostic term used to describe a syndrome found among athletes that closely resembles anorexia nervosa (AN), with the exception that an athlete's muscle mass maintains him or her above 85% of the minimum body weight.

creatine Performance-enhancing drug that increases energy transfer for muscle contraction.

deselection Forced suspension of play or retirement due to lack of physical competitiveness.

human growth hormone Performance-enhancing drug that stimulates skeletal and soft tissue growth.

neuropsychological assessment Systematic evaluation of learning and memory abilities commonly performed after an athlete sustains a head injury.

sports psychology Subspecialty of psychology that develops and applies psychological strategies to enhance and optimize athletic performance.

Yerkes-Dodson inverted U hypothesis Theory stating that optimal performance occurs at moderate levels of anxiety, while low and high levels of anxiety disrupt performance.

Sports psychotherapy is a subspecialty of psychotherapy that addresses the unique challenges and needs presented by athletes when they seek mental health services. Although sports psychotherapy has its roots in the sports psychology movement that has sought to enhance athletic performance, it extends beyond this practical goal. This article will present seven broad categories that illustrate the unique considerations of sports psychotherapy, including common psychological problems among athletes (drug use, eating disorders, and adverse reactions to injury) as well as the special developmental, social, and family factors that affect the athlete's mental health.

I. PERFORMANCE ENHANCEMENT AND THE ROLE OF THE SPORTS PSYCHOLOGIST

Performance enhancement refers to psychological interventions designed to increase an athlete's effectiveness and chances for success in competition. In a rapidly growing subspecialty, these interventions are designed and implemented by sports psychologists who provide consultation to college and professional athletic teams. In February 2001, a special issue of the American Psychological Association's journal *Professional Psychology: Research and Practice* discussed the roles and challenges of sports psychologists. For

example, Frank Gardner noted that, particularly in professional sports, modern-day athletes are regarded as extremely valuable (even a kind of financial investment) and hence worthy of psychological support and protection that might optimize their performance. In the same special issue, Mark Andersen, Judy Van-Raalte, and Britton Brewer observed that sports psychologists often resemble coaches more than they do clinicians and have a correspondingly looser set of boundaries between themselves and their clients. For example, sports psychologists may accompany an athlete to a practice, a training meal, or a game.

Despite the fact that sports psychologists may not be regarded as mainstream clinicians, many of the techniques and interventions they employ are borrowed from psychotherapy treatments. In addition, the immediate goal of a performance enhancement intervention is often to reduce some negative feeling or cognitive state, although the more practical concern is competitive success. For example, performance enhancement interventions are often aimed at changing levels of competitive state anxiety, or the level of tension that an athlete feels at game time. Therapists may be guided by the "Yerkes-Dodson inverted U hypothesis," which states that optimal performance follows moderate levels of anxiety (while low and high levels of anxiety disrupt performance). To achieve this moderate level of anxiety, psychotherapists may use progressive muscle relaxation (PMR), deep diaphragmatic breathing (DDB), guided imagery, or hypnosis. PMR involves periodic tensing and relaxing of all muscle groups, typically beginning with the feet and working up toward the head. DDB involves breathing from the lower diaphragm rather than from the upper chest. Guided imagery involves the use of suggestions to create relaxing images (e.g., lying on the beach), while hypnosis also involves guidance and suggestion but in the context of a qualitatively different state of consciousness. Some therapists prefer PMR, DDB, and guided imagery because they are ultimately self-applied and the athlete can leave treatment with a tool to be used in better controlling his or her anxiety before and during competition.

In 1990, Richard Suinn presented a behavior therapy package called anxiety management training (AMT) designed to enhance athletic performance. In 6 to 8 sessions, athletes are taught self-control methods to manage their anxiety levels, including specific relaxation techniques and strategies to revise cognitive self-statements. AMT emphasizes between-session homework assignments that allow athletes to try the skills they have learned in real competitive contexts.

Sports performance may be indirectly enhanced via the psychotherapeutic exploration of an athlete's social support network. Social support has an established research base as a buffer against injury, stress, and the pressures of competition. Interpersonally oriented psychotherapy is one therapeutic modality that might be used by a sports psychologist to target relationship conflicts that can lead to social isolation. Through experiential role-plays and between-session practice exercise athletes can identify and change the problematic ways in which they interact with others. For example, role-plays may help an athlete get along better with teammates on and off the court, thereby improving the team's chances for success.

II. FAMILY THERAPY AND THE ATHLETE

Family therapy refers to the treatment of both individual and interpersonal problems within the context of a family system. In 1995 and 2000 expositions, Jon Hellstedt has described the "athletic family" as a family system that includes parents and their children who are involved in competitive sports. Although the athletic family is not necessarily destined to be problematic or dysfunctional in a clinical sense, it can be imbalanced if there is an overly intense and narrow focus on one member's sports activity. Family members, parents in particular, often project their own unfulfilled athletic (or financial and social) dreams onto their children, thereby becoming overinvolved and unduly pressuring.

Hellstedt has identified four common targets of psychotherapy with the athletic family: the level of cohesion, the nature of emotional boundaries, triangulation patterns, and developmental impasses in the family life cycle. Family cohesion, while it can provide a source of support and stability, may serve to hide tension and conflict. For example, the tightness of a family system may lead to undermining of a child's autonomy and decision-making; psychotherapy might explore this pattern, along with any unexpressed anger and resentment that accompany it. Boundaries refer to the space that separates the emotional and cognitive systems of different family members. These boundaries have been described as ranging from "enmeshed" (too little space between members) or "disengaged" (too much space between members). Psychotherapeutic intervention is typically directed at the two extremes, particularly the enmeshed boundaries often found among athletic families. Triangulation refers to avoidance of conflict between two people (e.g., parents) by focusing on a third

person (e.g., athletic child). For example, parents may become overinvolved in their child's athletic activity as a way of avoiding their own marital discord. Hellstedt notes that a typical presentation in this regard includes a father who becomes overinvolved with his athletic son to the exclusion of his wife. Developmental impasses in the family life cycle refer to tasks and obstacles that arise as a family negotiates transitions. For example, most children leave home for the first time around age 17 or 18. However, young gymnasts often leave their families for extended periods of time for training, resulting in separation stress occurring sooner than is typical in the family life cycle.

Hellstedt summarizes the broad psychotherapy change goals in working with athletic families: identifying sources of stress, promoting healthy independence from the family, improving communication and problem-solving, negotiating developmental transitions, and developing the supportive capacity of the family while minimizing its role as a source of stress to the athlete.

Besides its relevance to specific athletic families, family therapy has been used as a model for understanding and intervening with sports systems and teams. Athletic teams, like family systems, often pursue goals of conflict resolution and facilitation of healthy cohesion. For example, in 1993 Toni Zimmerman and Howard Protinsky offered the following recommendations when using family therapy techniques in consultation to sports teams: meeting with both players and coaching staff, requiring attendance at consultation sessions, and utilizing family therapy models to monitor problematic patterns. Just as in families, athletic teams can experience damaging coalitions (e.g., coach singling out an athlete as his favorite) and significant communication problems.

III. LIFE SPAN DEVELOPMENT OF THE ATHLETE

Life span development refers to an age-appropriate context in which to better understand psychological issues and problems among athletes. For example, youth participation in sports can result in unique, and potentially negative, consequences. In a 1993 review, Robert Brustad explored how a child's psychological readiness for competition may impact on his or her emotional reactions to athletic activity. Psychotherapy with children who engage in sports competition too young (or perhaps too intensely) may involve discussion of the frustration, low self-esteem, and inappropriate achievement goals that have resulted from this involvement. When parents

place undue pressure on children to perform the whole family can become involved in the problem, thereby necessitating a family therapy intervention to establish more realistic and healthy patterns of encouragement.

Undergraduates involved in intercollegiate sports are another group that have unique psychotherapeutic needs. Treatment must acknowledge their dual roles as both students and athletes. Stress management interventions are common among this group of athletes as they struggle to establish and balance multiple priorities. Particularly in Division I schools that serve as a training ground for professional sports, athletes may be exceedingly goal-oriented. This characteristic can be both an asset (e.g., compliance with psychotherapy homework assignments) and an obstacle (e.g., rigidity in the face of revising unrealistic or unhealthy goals) to treatment. Due to the college environment and related subcultural norms, student athletes often present with substance abuse problems, eating disorders, and adverse emotional reactions to sports injury (see later).

A third set of developmentally influenced issues arises in treatment with elite amateur and professional athletes who are retiring. In a 1993 review, Bruce Ogilvie and Jim Taylor discussed three factors that can precipitate career termination: (1) chronological age, (2) deselection (no longer physically competitive), and (3) injury. Although all three of these precipitants necessitate a process of acceptance in psychotherapy, they each bring additional unique considerations. For example, deselection often leads to marked erosion of self-esteem. Young, highly successful professional athletes who suffer career-ending injuries may need to clarify and revise their self-identity in long-term psychotherapy. Ogilvie and Taylor recommend proactive, preventive interventions for athletes who know they are facing retirement. These interventions might help athletes clarify values and goals beyond athletics, or perhaps encourage expression of feelings of frustration, doubt, and loss.

IV. DRUG USE AMONG ATHLETES

Drugs used by athletes include alcohol, recreational illicit drugs, and performance-enhancing drugs. Although there are no reliable data on the prevalence of substance abuse among athletes, alcohol, marijuana, and cocaine remain the most common recreational drugs of choice. Anabolic-androgenic steroids (AAS) are the most commonly used class of performance-enhancing drugs. AAS maximize gains in muscular strength and size, thereby conferring some competitive advantage to the athlete.

More recently athletes have begun to use human growth hormone and creatine to optimize performance.

An understanding of the reasons for drug use among athletes forms a starting point for many psychotherapeutic approaches to the problem. The question of why athletes abuse drugs has perplexed some members of the sports community who find it puzzling that individuals so committed to physical fitness would knowingly undermine this very commitment. In the case of performance-enhancing drugs, the motivations for use are relatively clear (e.g., the use of anabolic steroids for muscular power, the use of stimulants for cognitive focus and endurance), although these drugs can have unintended and negative psychological side effects. The reasons for athletes' use of other addictive recreational drugs are less clear. In 1991, Jim Taylor hypothesized that athletes at the professional and collegiate levels use recreational drugs because they have not developed effective interpersonal skills to cope with the pressures exerted by the media and fans. The peer pressure that originates in sports team subcultures can be especially potent, leading some athletes to use drugs to ensure acceptance. Finally, especially talented athletes may be less adversely affected by drug use, somehow still able to perform better than average when using, and thus more likely to deny that a problem exists.

Each of these potential reasons for drug use may lead to different psychotherapeutic interventions. For example, social skills training and anxiety management can be emphasized with athletes who are using recreational drugs as a coping strategy. Although the teaching of alternative coping strategies may help athletes who are using recreational drugs, long-term group-based rehabilitation may be necessary if serious addiction has resulted (see later). Psychoeducation may help athletes understand the short- and long-term risks of using performance-enhancing drugs (e.g., cardiovascular complications, liver damage, acne, mood swings, aggressive and antisocial behavior) and this alone may be sufficient in treating the problem, particularly where no addictive process has taken hold.

Confidentiality is a significant concern when athletes seek, or are required to receive, treatment for drug abuse. The potential stigmatizing effects of being labeled a drug abuser can be long lasting. Additionally, athletes may be very concerned about how initiation of treatment will limit their play, fearing that a sudden suspension will destroy the confidentiality of their treatment since teammates may not otherwise know a problem exists.

Long-term psychotherapy treatment programs for drug-abusing athletes, like those for members of the

general population, usually include rehabilitation groups. For example, Alcoholics Anonymous and related 12-step programs may be especially effective if groups are composed of athletes with similar backgrounds. Often, athletes begin this kind of treatment at a residential inpatient (or at least day-treatment) facility where they can be fully immersed in the notion of sobriety and an alternative lifestyle. In the early 1980s, Gregory Collins was involved in one of the first organized programs for treating and preventing drug use among professional athletes. In a 2000 book chapter, Collins describes a self-help model used with the Cleveland Browns football team that included regular meetings of drug-involved players in a group called the "Inner Circle." This group placed a special emphasis on relapse prevention. Because the "Inner Circle" is composed of athletes at different stages of sobriety, members can discuss common pressures and triggers to use substances, provide and share effective support and coping mechanisms, and monitor each other's treatment progress.

Besides treatment of drug abuse, both college and professional sports teams have emphasized prevention. Although mandatory drug testing is one way of detecting a problem for early intervention, athletic staff would rather take action before a problem begins. For example, many teams have adopted programs to disseminate accurate information about drugs and to teach effective coping skills. Some prevention programs include required video and workshop orientations for new players where they are educated not just about drugs and their effects, but also about the availability of support and treatment services.

V. EATING DISORDERS AMONG ATHLETES

Sports that overvalue aesthetic appearance of the body (e.g., dance, gymnastics), low body fat (e.g., swimming, running), or maintenance of body weight (e.g., wrestling, horse-racing) may place athletes at a higher risk for developing eating disorders and related body image distortions. In 1994, Jorunn Sundgot-Borgen used the term "anorexia athletica" (diagnosed Eating Disorder, Not Otherwise Specified in *DSM-IV*) to describe a syndrome that closely resembles anorexia nervosa (AN), with the exception that these athletes do not meet AN diagnostic criteria because their muscle mass maintains them above 85% of the minimum body weight. As a clinical subpopulation, athletes are likely to respond to a distorted body image not just by restricting food intake

but also by overexercising, which can in turn lead to further illness and injury (see later).

In a 1998 review, David Garner, Lionel Rosen, and Declan Barry emphasize the importance of confidentiality in working with athletes suffering from eating disorders, noting that they may be especially sensitive to how coaches and teammates will regard their problems. They specifically discourage the treating clinician from talking to other teammates about the athletes' eating problems. To avoid related marginalization, these authors recommend that athletic activity be suspended only if the athlete poses a physical health risk to himself.

Psychoeducation can be especially useful in psychotherapy with athletes suffering from eating disorders, specifically in motivating healthy dietary behavior change. For example, detailed discussion of the negative effects of restricted calorie intake on physiology and performance (e.g., reduced strength, impaired coordination, slower recovery from competition) can mobilize athletes at least to consider alternative strategies to enhance performance.

Recommended psychotherapeutic treatments for athletes with eating disorders include cognitive-behavior therapy (CBT) or interpersonal therapy for bulimia and CBT for binge-eating disorder. CBT attempts to bring eating habits under control through a system of monitoring and dietary change. Interpersonal therapy focuses on how the athlete's disrupted relationships with others (perhaps teammates) result in the impetus to engage in binge and purge cycles.

VI. REHABILITATION FROM ATHLETIC INJURY

Athletic injuries may result from relatively acute, discrete trauma, or from overtraining/overuse. Although it is rather obvious that athletic injury necessitates physical rehabilitation, only recently have psychotherapists become involved in the recovery process. Psychotherapy may facilitate both physical and emotional recovery. As an adjunct to physical rehabilitation, clinicians may help athletes set realistic goals for recovery, which is particularly important for "overuse injuries" and for those athletes who are characteristically overachieving or overexerting. Psychotherapists may also work to increase motivation about and adherence to rehabilitation regimens. For those athletes who have negative thoughts and attitudes about the prospects for recovery, cognitive-behavioral therapists may help an athlete identify cogni-

tive distortions (e.g., an athlete who catastrophizes by assuming "this is the end of my career") and work to challenge and revise these thoughts. Psychotherapists may also indirectly affect commitment to rehabilitation and recovery rate by facilitating positive, healing imagery (e.g., "picture the tissue repairing itself"). In a 1991 study, Lydra Ieleva and Terry Orlick found that athletes using goal-setting, stress control, positive self-talk, and healing imagery recovered faster than those who did not receive these psychological interventions.

Emotional responses to athletic injury, particularly career-ending injury, often resemble reactions to loss. For example, athletes have been observed to move through Kubler-Ross's five grief stages: (1) denial and isolation, (2) anger, (3) bargaining, (4) depression, and (5) acceptance. A first step in psychotherapy is to normalize this grief process. Before acceptance can be forged, athletes may spend extended periods consumed by anger, depression, and even posttraumatic stress. These emotional problems may necessitate targeted psychotherapeutic interventions. For example, injured athletes may experience a precipitous drop in activities they enjoy or "pleasurable events," a common behavioral trigger for major depression. Therapy may identify alternative pleasurable activities and then use behavioral reinforcement contingencies to improve mood functioning. Alternatively, depression following injury may be understood within a cognitive context—sustaining an injury may provoke feelings of vulnerability and the belief that life is a series of uncontrollable events. Cognitive therapy would attempt to change these unnecessarily extreme and distorted beliefs.

Common defense mechanisms employed by athletes to avoid the unpleasant emotion associated with injury include reaction formation (displaying emotions that are the opposite of what is really felt) and intellectualization (discussing the injury in terms of thoughts and ideas without mention of emotion). Permissiveness to feel anger and sadness, and perhaps even induction of these emotions, is a primary objective of psychotherapy with athletes who are unable or unwilling to acknowledge their feelings.

The process of accepting a career-ending injury may require longer term psychotherapy to address erosion of self-esteem, particularly if an individual's valuation of himself or herself was primarily based on athletic success. This work may involve detailed discussion of what needs were fulfilled by athletic experiences and which alternative activities may now be substituted. Encouragement of seeking role models who have suffered career-ending injuries may help some athletes in

psychotherapy, or even a support group of similar others if available.

Sports injury can be strategically exaggerated or even feigned by an athlete looking for secondary gain. For example, an athlete may wish to avoid some negative event (e.g., having parents watch him play) or acquire some positive benefit (e.g., insurance claim) by being injured. This kind of psychological motivation for injury may be addressed in psychotherapy by skills training that would emphasize (1) identifying more active and direct ways of making or denying requests from others, and (2) satisfying needs in a more forthright fashion.

VII. NEUROPSYCHOLOGICAL ASSESSMENT AND CONCUSSION

Neuropsychological assessment and concussion refers to the evaluation of cognitive functioning (e.g., learning and memory abilities) following a sports-related head injury. A developing body of research has suggested that multiple head injuries can have long-term negative psychological and physical health effects, with some players particularly susceptible to repeated head injury. In 1996, the National Hockey League (NHL) began an experimental pilot program to formally assess players who experienced head injuries. This program was intended to prevent a hasty return to play and thereby minimize the risk and consequences of multiple head injuries. The NHL extended this assessment program league-wide in 1997 while the National Football League also began to institute similar protocols.

In 1999, Michael Collins, Mark Lovell, and Douglas McKeag observed that there is some confusion as to when athletes should be examined because there is no universally accepted definition of concussion (e.g., some

believe that loss of consciousness is central whereas others do not). Although evaluation of postconcussion effects may be conducted in a medical rather than psychotherapeutic context, sports clinicians are expected to be familiar with the testing and typical findings. For example, athletes with a history of concussion may experience slowness in processing speed (i.e., pace of response to verbal and visual stimuli) and decrements in executive functioning (i.e., ability to plan and execute decisions). When psychotherapists work with athletes who have suffered these kinds of effects from multiple head injuries, the content and pace of psychotherapy is usually adapted, as it is among other clients who present special cognitive considerations (e.g., young children, older adults).

See Also the Following Articles

Addictions in Special Populations ■ Cognitive Behavior Treatment ■ Collaborative Care ■ Eating Disorders ■ Family Therapy ■ Substance Dependence: Psychotherapy

Further Reading

- Begel, D., & Burton, R. (Eds.). (2000). *Sport psychiatry: Theory and practice*. New York: W. W. Norton.
- Collins, M. W., Lovell, M. R., & Mckeag, D. B. (1999). Current issues in managing sports-related concussion. *Journal of the American Medical Association*, 282, 2283–2285.
- Gardner, F. L. (2001). Applied sport psychology in professional sports: The team psychologist. *Professional Psychology: Research and Practice*, 32, 34–39.
- Garner, D. M., Rosen, L. W., & Barry, D. (1998). Eating disorders among athletes. *Sport Psychiatry*, 7, 839.
- Russell, W. D. (1996). Utility of family therapy in the field of sport. *Family Therapy*, 23, 33–42.
- Taylor, J., & Taylor, S. (1997). *Psychological approaches to sports injury rehabilitation*. Gaithersburg, MD: Aspen Publishers.

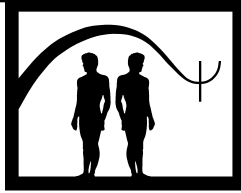

Spouse-Aided Therapy

Paul M. G. Emmelkamp and Ellen Vedel

University of Amsterdam

- I. Description of Treatment
 - II. Theoretical Bases
 - III. Empirical Studies
 - IV. Summary
- Further Reading

GLOSSARY

communication skills training A behavioral procedure designed to decrease stress in a couple by teaching attentive listening skills, effective ways to express positive and negative feelings, and how to request behavioral change in a nonhostile manner.

exposure Repeated confrontation with, or approach to, the object that is avoided.

interpersonal therapy Psychodynamically based treatment that aims to alter negative interpersonal situations that maintain depression. The focus is on one of the following domains: (1) loss, (2) role disputes, (3) role transitions, and (4) interpersonal deficits.

problem-solving training Teaching a set of sequential steps for solving problems that minimizes negative emotional undercurrents while maximizing the identification, evaluation, and implementation of the optimal solutions.

systems theory The basis premise of this theory is that the problem shown by the "identified patient" is a sign that something is wrong with the entire family. Problems of the patient are seen as only a symptom of more basic family problems. System-theoretically derived treatment deals with the relationship between the individual family members and the family system, rather than focusing on overt pathological symptoms.

I. DESCRIPTION OF TREATMENT

For present purposes spouse-aided therapy is defined as any psychological intervention in which the partner of the patient with a psychiatric disorder (e.g., anxiety disorder, depression, substance use disorders) is actively involved in the treatment, and the focus of the intervention is primarily on the psychiatric disorder. This means that marital therapy directed exclusively to the marital difficulties of the couple without due attention to the specific psychiatric disorder involved is not discussed here.

There are several advantages for spouse-aided therapy: (1) The spouse is informed about the psychiatric disorder and the kind of treatment delivered, (2) the spouse can give additional information about symptomatology of the patient and treatment progress, (3) the spouse can be emotionally supported, since living with a patient is often a heavy burden; and (4) the spouse can learn to deal more adequately with disorder-related situations, and, if necessary, general communication between partners can be improved.

A. Anxiety Disorders

In anxiety disorders, two different formats of spouse-aided therapy can be distinguished. In partner-assisted exposure the partner accompanies the patient to each treatment session. The couple receives a treatment rationale, in which the focus is on exposing the patient to phobic situations. The partner can assist in making a

hierarchy, consisting of gradually more difficult exposure tasks. At each session the patient is given a number of exposure homework assignments. The role of the partner is to stimulate the patient to do these exercises, to help in confronting the phobic situations, to accompany the patient if necessary, and to reinforce the patient in mastering these exposure exercises successfully. The actual presence of the partner is gradually faded out during the exposure exercises. At the beginning of each new session, the patient's performance on the exposure tasks and the assistance of the partner are discussed with the couple and new homework assignments are given. More difficult tasks are given only if tasks lower in the hierarchy have been performed successfully. The pace at which the patient works through the hierarchy is determined by the couple. Thus, treatment focuses on the phobia. Relationship problems, if any, are not discussed.

Other spouse-aided approaches in anxiety disorders have focussed on interpersonal difficulties thought to maintain agoraphobic symptoms. These approaches include communication training and partner-assisted problem solving directed either at phobia-related conflicts or at general life stresses and problems.

B. Depression

Partner-assisted cognitive-behavior therapy for depression is based on Peter Lewinsohn and Aaron Beck's individual therapy of depression. It is assumed that depressed individuals do not engage in pleasant activities and hence do not get adequate reinforcement, resulting in mood disturbance. During spouse-aided therapy, partners join all sessions. Treatment focuses on the depression and on ways both partners can deal more adequately with depression-related situations rather than on relationship aspects per se. Therefore, spouses are involved in devising reinforcing activities, in stimulating patients to engage in rewarding activities, and participating in role-playing. Further, spouses are asked to attend to the dysfunctional thoughts of the patient and to discuss these with both patient and therapist. In addition, partners are actively involved in designing behavioral experiments to test (irrational) beliefs and are encouraged to take part in challenging the assumptions held by the patient.

In conjoint interpersonal therapy the partner is involved in addressing patient-related unresolved difficulties in one of the following domains: loss (e.g., of a child or parent), role disputes, role transitions, and interpersonal deficits. Moreover, five sessions of conjoint communication training are included.

In cases with co-occurring depression and marital discord, conjoint behavioral marital therapy may be ap-

plied. Here, the emphasis is not only on the mood disorder, but also on the communication between the partners. Generally, in the earlier phase of therapy problems associated with depression that could hinder a successful application of marital therapy are dealt with. Examples of such problems are complicated grief or a low activity level in the depressed patient. Later on the focus of the therapy is shifted to the training of communication skills in both spouses.

C. Substance Abuse

In general behavioral couple treatment for alcohol use disorders focuses on behavioral self-control and coping skills to facilitate and maintain abstinence, improving spouse coping with drinking-related situations, improving relationship functioning in general, and improving functioning within other social systems in which the couple is currently involved. The degree of emphasis on each of these four domains and the techniques used to target these domains varies across different treatment protocols. Two well-known protocols are the ones used in the Harvard Counseling for Alcoholics' Marriages (CALM) project by Timothy O'Farrell and the Alcohol Behavioral Couple Treatment (ABCT) protocol used by Barbara McCrady. The main differences between these two protocols are that O'Farrell's treatment is designed to be used in conjunction with or subsequent to a treatment focusing on cessation of drinking, whereas the treatment developed by McCrady is designed as a stand-alone treatment. Also, part of the CALM treatment is delivered in a group format whereas McCrady's treatment is delivered during individual couple sessions.

Some techniques often used are the sobriety or Antabuse contract to reduce conflict and distrust between the couple, identifying high-risk situations and teaching both partners alternative skills to cope with these situations, and improving communication between the partners by using role-play to reduce conflict, enhance marital satisfaction, and reduce the chance of relapse.

Behavioral couple treatment for substance use disorders other than alcohol are derived from these (and other) alcohol treatment protocols, focus on the same four domains, and use similar behavioral techniques. Another behavioral intervention in which the spouse is usually involved, but also other family members and other individuals from the patient's network, is Azrin's community reinforcement approach. Consistent with operant conditioning principles, this treatment is designed to remove drinking reinforcing behaviors by teaching family and friends to ignore drinking and reward nondrinking.

Originally designed for treating alcoholics, this treatment has been adapted by Stephen Higgins and colleagues for treating cocaine and other drug abusing patients.

II. THEORETICAL BASES

A. Anxiety Disorders

Systems-oriented clinicians hold that phobias and other anxiety symptoms have interpersonal meaning in relationships. For example, Jay Haley defined the marital relationships of agoraphobic patients as compulsory marriages, in which partners do not stay together out of love but are forced to stay together because of the symptoms. Further, the partners of patients with an anxiety disorder have been described by system-oriented clinicians as negativistic, hostile, compulsive, and anxious. It was assumed that improvement of the anxious patient would lead to an exacerbation of symptoms in the partner and/or to marital distress.

No convincing evidence has been provided that partners of patients with anxiety disorders are psychologically abnormal themselves. However, recent empirical studies comparing agoraphobic and obsessive-compulsive couples with healthy control couples suggest there might be some differences regarding marital satisfaction, adjustment, and interpersonal problem-solving skills. These differences, however, are usually rather small. Nevertheless, this view has given impetus to involving the partner of agoraphobic and obsessive-compulsive patients in the treatment.

B. Depression

Depressed persons are characterized by an aversive interpersonal style to which others respond with negativity and rejection. The interaction of depressed individuals with their partner has been characterized by a lower proportion of positive verbal behavior and a greater proportion of negative verbal and nonverbal behavior. A substantial number of depressed patients presenting for treatment also experience marital distress, whereas in approximately half of the couples who have marital problems at least one of the spouses is depressed. These data suggest that depression and marital distress are closely linked. Furthermore, marital distress is an important precursor of depressive symptoms. In addition, persons who, after being treated for depression, return to distressed marriages are more likely to experience relapse. When patients are asked about the sequence of depression and marital distress,

most patients hold that marital distress preceded the depressive episode. Results of these studies suggest that it might be important to enroll the partner in the treatment of depressed patients.

C. Substance Abuse

From a behavioral or social learning perspective alcoholism is a biopsychosocial process, the course of which is determined by multiple factors. According to this model, alcoholism, as well as other addictive behaviors, are habitual, maladaptive methods for attempting to cope with the stresses of daily living. This maladaptive coping is triggered by internal and external cues and reinforced by positive rewards and/or negative punishment. Formerly spouse-aided interventions with substance use disorders were regarded most appropriate for only a subset of clients with severe marital or family problems. These clients were presumed to be in an "alcoholic relationship" with a specific pathological marital structure, in need of different treatment interventions. Research now points in the direction of also involving a significant other, across a broader spectrum of clients.

Within a behavioral framework drinking or drug taking is assumed to have a negative effect on communication between partners and marital satisfaction, and has also been linked to other marital issues such as domestic violence and sexual dysfunction. Research has differentiated families of alcoholics from healthier control families in that the former typically manifest poor communication, organization, problem-solving, conflict management, and affect regulation processes. However, comparing alcoholic couples with nonalcoholic but distressed couples revealed that the latter group was characterized by similar dysfunctional processes as the former. Alcoholic couples do differ from nonalcoholic couples in that they report more domestic violence. Even in nonalcoholic couples more drinking is associated with increased violence.

There is some evidence that specific behaviors of the spouse can function either as a cue or reinforcer in drinking or drug-taking behavior. Furthermore, marital stability has been found to be positively related to success of treatment. In studies of alcohol abusers recovering without treatment intervention, social support, especially from a spouse, was significantly related to successful changes in drinking behavior. Finally, there is some evidence that restoring marital satisfaction and reducing conflicts reduces the chance for relapse. Taken together, the results of these studies suggest a need to investigate the effectiveness of spouse-aided interventions in substance abuse.

III. EMPIRICAL STUDIES

A. Anxiety Disorders

In contrast to expectations derived from general systems theory, there is no evidence that exposure therapy with patients with agoraphobia or obsessive-compulsive disorder has adverse effects on the relationship or the partners' symptoms. The controlled studies in this area suggest that the relationship remains stable or improves slightly, and no exacerbation of symptoms in the partner of the patient has been reported. Thus, the empirical evidence does not support the systems conceptualization of anxiety disorders as being a symptom of more serious marital problems.

Studies investigating the effects of spouse-aided therapy in individuals with agoraphobia and obsessive-compulsive disorder have indicated partner-assisted exposure to be as effective as treatment by the patient alone. The results of the studies that have been conducted thus far indicate that it is not essential to include the spouse in the exposure treatment of patients with agoraphobia or obsessive-compulsive disorder.

The results of studies that evaluated the efficacy of interpersonal skills training interventions are rather mixed, so no general conclusions are allowed. Treatment focusing on general life stress rather than on relationship difficulties was found to be less effective than exposure by the patient alone. In contrast, studies that focussed on relationship issues in addition to exposure led to slightly better results, especially on follow-up. Notably, this was also the case in couples that were not maritally distressed. Given the finding that criticism of the spouse may be related to relapse at follow-up, this may require specific attention to communication training in couples with a critical partner.

B. Depression

In this paragraph only studies are reviewed in which at least one individual of a couple was clinically depressed. Marital distress hinders treatment of the depressive disorder and, given the link between relapse and being in a distressed relationship, increases the chance of relapse in the future. To date, three controlled studies have shown that conjoint behavioral marital therapy in depressed-maritally distressed couples may be a good alternative for individual cognitive-behavior therapy. Taking the results of these studies together, in depressed-maritally distressed couples behavioral marital therapy seems to have an exclusive effect on the marital relationship, which is not found in

individual cognitive-behavior therapy, while it is as effective as cognitive therapy in reducing depressed mood. Not surprisingly, behavioral marital therapy was hardly effective in depressed patients who did not experience marital problems.

Thus far, only one controlled study has investigated the effects of partner-assisted cognitive-behavior therapy and only one the effects of conjoint interpersonal therapy in depressed individuals. The results of partner-assisted cognitive-behavior therapy were comparable with those of individual cognitive-behavior therapy. Both treatments led to statistically significant improvement on depressed mood, behavioral activity, and dysfunctional cognitions. However, none of the treatment formats affected relationship variables, which comes as no surprise because all couples were non-maritally distressed prior to treatment. Thus, partner-assisted cognitive-behavior therapy was as effective as individual cognitive-behavior therapy in depressed individuals. In addition, conjoint interpersonal psychotherapy was equally effective as individual interpersonal psychotherapy on measures of depressive symptomatology. There was some evidence that the conjoint version was slightly more effective than the individual therapy on relationship variables. Finally, there is some evidence that treatment focusing on the interaction of depressed couples is slightly more effective than antidepressants.

C. Substance Abuse

The results of spouse-aided treatment programs in substance use disorders are encouraging. Research suggests that spouse involvement in the treatment of alcohol and drug use disorders produces significant reductions in alcohol and/or drug use, and improves marital functioning. There are also indications that behavioral couple therapy reduces violence in violent alcoholic couples. It should be noted, however, that most research to date was conducted in academic centers and has focused on white, male, higher educated alcoholic subjects. Typically, subjects in these studies had few other axis I or axis II disorders and were in relatively steady relationships with non-substance-abusing partners. It remains to be shown whether these spouse-aided treatment protocols will be as effective when delivered to other populations in a community setting.

IV. SUMMARY

Spouse-aided therapy consists of psychological interventions in which the partner of the patient with a psy-

chiatric disorder is actively involved in the treatment, which focuses primarily on the psychiatric disorder.

Spouse-aided exposure has shown to be effective in treating anxiety disorders (e.g., agoraphobia and obsessive-compulsive disorders). However, there is little evidence of it being more effective in reducing anxiety symptoms, compared to individual exposure treatment programs. There is some evidence that spouse-aided therapy focusing not only on the phobic disorder but also on communication is more effective than treatment of the patient alone. Specific attention to communication training may be required in anxious patients with an overcritical partner.

Evidence suggests that spouse-aided therapy that focuses not only on the mood disorder, but also on improving communication skills and problem-solving skills of both partners, should be the treatment of choice in maritally distressed patients with dysthymia or major depression. Finally, the results of spouse-aided treatment programs in substance use disorders are encouraging.

Although a number of studies have evaluated the effectiveness and efficacy of spouse-aided therapy in anxiety disorders, depression, and substance use disorders, no conclusions may be drawn from these findings regarding its efficacy in other disorders. There is some clinical evidence that spouse-aided therapy might also be used in chronic pain management and in schizophrenia, but controlled studies are needed before firm conclusions about the effectiveness of spouse-aided therapy in these disorders are warranted.

See Also the Following Articles

Aversion Relief ■ Behavioral Marital Therapy ■ Communication Skills Training ■ Couples Therapy: Insight Oriented ■ Family Therapy ■ Home-Based Reinforcement ■ Homework ■ Interpersonal Psychotherapy ■ Parent-Child Interaction Therapy ■ Psychodynamic Couples Therapy ■ Sex Therapy

Further Reading

- Baucom, D. H., Shoham, V., Mueser, K. T., Daiuto, A. D., & Stickle, T. R. (1998). Empirically supported couple and family interventions for marital distress and adult mental health problems. *Journal of Consulting and Clinical Psychology, 66*, 53–88.
- Beach, S. R. H., Fincham, F. D., & Katz, J. (1998). Marital therapy in the treatment of depression: Towards a third generation of therapy and research. *Clinical Psychology Review, 18*, 835–861.
- Carr, A. (2000). Evidence-based practice in family therapy and systemic consultation: II. Adult focused interventions. *Journal of Family Therapy, 22*, 273–295.
- Daiuto, A. D., Baucom, D. H., Epstein, N., & Dutton, S. S. (1998). The application of behavioral couples therapy to the assessment and treatment of agoraphobia: Implications of empirical research. *Clinical Psychology Review, 18*, 663–687.
- Craske, M., & Zoellner, L. (1996). Anxiety disorders: The role of marital therapy. In N. Jacobson & A. Gurman (Eds.), *Clinical handbook of couples therapy* (pp. 394–410). New York: Guilford Press.
- Emmelkamp, P. M. G., & Gerlsma, C. (1994). Marital functioning and the anxiety disorders. *Behavior Therapy, 25*, 407–429.
- Epstein, E. E., & McCrady, B. S. (1998). Behavioral couples treatment of alcohol and drug use disorders: Current status and innovations. *Clinical Psychology Review, 18*, 689–711.
- McCrady, B. S., Epstein, E. E., & Hirsch, L. S. (1999). Maintaining change after conjoint behavioral alcohol treatment for men: Outcome at 6 months. *Addiction, 94*, 1381–1396.
- O'Farrell, T. J., & Cowles, K. S. (1995). Marital and family therapy. In R. K. Hester & W. R. Miller (Eds.), *Handbook of alcoholism treatment approaches*. Needham Heights, MA: Allyn & Bacon.
- Prince, S., & Jacobson, N. (1995). A review and evaluation of marital and family therapies for affective disorders. *Journal of Marital & Family Therapy, 21*, 377–401.
- Rotunda, J. R., & O'Farrell, T. J. (1997). Marital and family therapy of alcohol use disorders: Bridging the gap between research and practice. *Professional Psychology: Research and Practice, 28*, 246–252.



Stretch-Based Relaxation Training

Charles R. Carlson

University of Kentucky

- I. Introduction
 - II. Review of Clinical Trials
 - III. Technique
 - IV. Representative Clinical Application
 - V. Summary
- Further Reading

GLOSSARY

masticatory muscle pain Chronic muscle pain disorder affecting the muscles used for chewing and moving the jaw.

musculoskeletal pain Pain involving structures of the musculoskeletal system that includes muscles, bones, joints, ligaments, and tendons.

PBS A three-step strategy for reducing muscle tension that focuses on positioning (P), breathing (B), and stretching (S).

self-monitoring Process of making regular assessments of personal behavior or activity for the purpose of understanding the frequency with which those behaviors or activities under study occur.

stretch-based progressive relaxation A progressive relaxation training approach that uses gentle muscle stretches to teach sensory awareness of muscle groups and to promote volitional relaxation.

Stretch-based relaxation training was developed as an alternative to more traditional progressive muscle relaxation procedures focusing on muscle tension exercises to teach relaxation skills. In contrast to the tense-

release strategy of traditional progressive muscle relaxation, the stretch-based approach uses gentle stretches of major muscle groups to teach sensory awareness and volitional control of muscle activity. Results from randomized clinical trials have demonstrated the clinical efficacy of the stretch-based approach for addressing a range of problems that include face pain, neck pain, and general anxiety. This article presents the theoretical rationale, outcome data, and clinical applications of stretch-based relaxation training.

I. INTRODUCTION

Psychotherapists are faced with a broad array of options for conducting relaxation training. Generally, the goal of relaxation training is to reduce activation, both physical and mental, and promote self-efficacy for regulation of internal states. These skills of self-regulation can be used to enhance the management of personal and interpersonal challenges. Although there are a variety of relaxation training approaches, the use of progressive relaxation is often a method of choice.

Progressive relaxation was introduced just after the turn of the 20th century by Edmund Jacobson. As a physician, he became interested in the processes by which his patients controlled their own levels of physical and psychological activity. He believed that control over muscle tension and cognitions could be obtained through guided practice where an individual learned to

manage her or his level of muscle tension and focus of attention. His primary strategy for teaching this control was conscious activation and relaxation of various muscle groups in a systematic manner. Originally, he conceptualized relaxation training as requiring 40 to 60 sessions of deliberate practice in tensing and relaxing various muscles. Often an entire hour-long session was devoted to only one muscle group. This rather laborious technique of relaxation training spurred an interest among other practitioners for developing shorter progressive relaxation training programs.

One of the most popular variants of Jacobson's original relaxation procedure was the abbreviated progressive relaxation (APR) approach developed by Bernstein and Borkovec. The original series of Jacobson's exercises was reduced to 16 major muscle groups in the initial APR training session. Like the Jacobsonian approach, the basic strategy for APR is to tense the muscle group for 15 to 20 seconds and then quickly release the muscle tension and let the muscle relax for an extended period. The sequence of muscles that are relaxed generally begins with the hands then progressively moves upward to the head and down to the feet. There is a substantial literature attesting to the effectiveness of APR for a wide variety of clinical problems, as is documented in Carlson and Hoyle in 1993 and Carlson and Bernstein in 1995. This literature includes information on anxiety disorders, depression, and medical conditions such as headache, insomnia, and hypertension.

There are conditions, however, where the use of muscle tensing strategies is not indicated. In cases where muscle tension increases pain, or there is a history of cardiac disease such as arrhythmias, muscle tensing strategies should be avoided. Furthermore, the muscle contractions used in progressive relaxation training may increase muscle nerve sympathetic activity and not promote general relaxation. Finally, the rationale for use of muscle tension-based strategies that increase tension in order to reduce tension can often be difficult for clients to accept in the initial phase of treatment when pain, tension, or anxiety is intense. Because of these issues, an alternative to the use of muscle tensing exercises for progressive relaxation training is needed.

From a physiological perspective, if a muscle is contracted, a slow, gentle stretch of the muscle that does not overstretch or tear the muscle fibers will foster the relaxation of the muscle when the stretch is released. One common example of this principle is the familiar case of the "Charley horse" in which the muscle spasm of the lower back leg is most easily reduced by stretching that muscle gently (by moving the toes several inches to-

ward the head and holding them in that position) for an extended period of time. Physical therapists and athletic trainers use muscle stretching on a regular basis to quiet contracted, overly active muscles. Muscle stretching results in reduced excitability of the motoneuron pool that can lead to reduced muscle activity, increased blood flow, and less pain. The value of muscle stretching is well-recognized in the empirical literature related to muscle function.

Jacobson's original intent in using muscle tensing exercises was primarily to teach the discrimination of muscle groups so that one's sensitivity to motor activation was enhanced. His ultimate goal for a client was to learn how to relax without the use of muscle tension exercises. The tense-release sequences were not a necessary part of the process of relaxing a muscle, but rather a learning tool to foster the acquisition of relaxation skills by teaching awareness of subtle sensations of muscle tension. Substituting a gentle stretch of a muscle for a contraction of that muscle is an alternative means by which sensory awareness can be improved while at the same time taking advantage of the natural relaxation effects associated with the release of a gentle muscle stretch.

Given this background, muscle stretches were developed for each of the 16 major muscle groups associated with the APR procedures of progressive relaxation. Although muscle stretches of these muscle groups cannot be performed by an individual without using some muscle tension (e.g., stretching the muscles of the lower back leg by gently drawing the toes of the feet toward the head), the focus of the procedures was on the muscle stretches themselves and the sensory experiences following the stretches. The sequence of the muscle stretches began with the lower legs and proceeded upward to the head region. Each of the muscles was stretched for 15 to 20 seconds and followed by relaxation for 60 seconds. An example of the instructions for a muscle stretch of the forehead (frontalis region) from Carlson and Collins follows:

In order to stretch the muscles of the forehead, place the fingertips of both hands slightly above the eyebrows and gently push the fingers upward toward the hairline, stretching the muscles by applying light pressure. When you reach the hairline, hold the stretch by maintaining the upward pressure of your fingers on the skin.

The stretch-based progressive relaxation approach is presented in either a five-session format for individuals or a six-session group format. The protocol includes therapist scripts, home practice guidelines, audiotape

for home practice, and videotape for therapist training. Diaphragmatic breathing entrainment is included in the presentation of the relaxation procedures to aid in relaxation, as well as to assist in the timing of the stretch-relaxation sequences. The goal of this program is to teach volitional skills of relaxation in as efficient manner as possible using a focus on muscle stretching procedures.

II. REVIEW OF CLINICAL TRIALS

Following completion of a successful clinical case study involving the use of the stretch-based relaxation approach to address a generalized anxiety, 24 individuals self-referred for moderate muscle tension and anxiety were assigned randomly to a stretch-based relaxation group, tension-based relaxation group, or a wait-list control group. After the treatments were delivered, participants in the stretch-based group reported significantly less muscle tension at four muscle sites (right trapezius, right brachioradialis, left tricep, and left tricep) and had significantly less electromyogram (EMG) activity in the right masseter region than did participants in the tension-based relaxation group. These preliminary data from this randomized clinical trial indicated that the stretch-based progressive muscle relaxation procedures were effective in reducing both subjective and objective indices of muscle tension in persons reporting moderate tension and anxiety.

Carlson and colleagues then applied the stretch-based approach to persons with masticatory muscle pain disorder. Masticatory muscle pain disorder is a disorder where there is no evidence of temporomandibular joint pathology, but the muscles of mastication (primarily masseter, temporalis, and pterygoids) are painful enough to cause impaired chewing function. A group of 34 persons with masticatory muscle pain were assigned randomly to either a stretch-based relaxation protocol or to a condition in which the participants were asked to rest in relaxed positions. Results revealed that persons with elevated muscle activity assigned to the stretch-based group had greater reductions in EMG activity at both left and right masseter sites than persons assigned to the rest control condition. There were, however, no differences in self-reports of muscle tension between the two groups. For persons with masticatory muscle pain disorders, the use of the stretch-based relaxation approach was an effective means for reducing ongoing muscle activity even though reductions in self-reports of muscle tension did not differ from persons given instructions to relax by assuming positions of rest.

Kay and Carlson in 1992 directly compared the stretch-based relaxation approach to the tense-release and rest control relaxation procedures in a group of 60 persons reporting chronic neck muscle tension. The effectiveness of the procedures was evaluated by having the participants use one of the relaxation strategies after being exposed to a standard laboratory stressor. Participants were randomly assigned to one of the experimental groups and it was found that those assigned to the stretch-based condition reported greater overall reductions in muscle tension and lower left trapezius muscle activity than those assigned to either of the other two groups. Additionally, the stretch-based group had an overall increase in peripheral skin temperature, whereas the other two groups did not. This latter finding suggests that sympathetic nervous system activity was reduced for the participants using the stretch-based relaxation procedures. Overall, these data indicated that the stretch-based relaxation approach provided an effective relaxation strategy for persons with chronic neck tension.

Sherman and colleagues in 1997 evaluated the influence of stretch-based relaxation procedures on the immune function of persons experiencing persistent facial pain. Twenty-one participants were assigned randomly to either a stretch-based relaxation condition or a rest-control condition. Participants in the stretch-based relaxation condition had greater salivary immunoglobulin A (IgA) secretion rates than those in the rest-control condition. These results indicated that stretch-based relaxation training may have benefits beyond reduction of muscle tension for persons with chronic pain conditions.

Finally, Wynn in 1995 and 1998 conducted a series of controlled trials of stretch-based relaxation training with persons at risk for developing hypertension. This first study involved 32 young adult males with a family history of hypertension. Participants randomly assigned to six sessions of stretch-based relaxation training displayed lower heart rate and blood pressure (systolic and diastolic) responses to a laboratory stressor than did a comparable group of persons randomly assigned to a control condition. Additionally, participants trained in stretch-based relaxation reported less anger and anxiety than the controls. These findings were followed-up in a second study of 48 Black American males at risk for developing hypertension. It was found that those randomly assigned to the stretch-based relaxation protocol demonstrated lower diastolic blood pressure reactivity to a laboratory stressor, as well as lower emotional reactivity than did persons randomly assigned to a group that underwent a health

education program as a comparative control. Taken together, these two studies demonstrated the efficacy of the stretch-based relaxation protocol for reducing reactivity to laboratory stressors in persons at risk for the development of hypertension.

Overall, the data from a series of clinical trials support the use of stretch-based relaxation among persons with muscle tension and facial and neck pain, and those prone to excessive reactivity to environmental stressors. One of the shortcomings of the presently available data is that they are based on studies conducted within the clinical laboratory of the primary author of the stretch-based relaxation protocol. Other well-controlled clinical trials outside the author's laboratory are needed to provide independent confirmation of the effectiveness of the stretch-based relaxation approach. Based on the available data, however, there are strong preliminary data indicating the efficacy of the stretch-based progressive relaxation protocol.

III. TECHNIQUE

A. Initial Evaluation

Before beginning stretch-based relaxation training, the clinician should complete a thorough initial evaluation with the client to ensure that relaxation training is appropriate for that individual. The primary concern in this initial consultation is to determine the nature of the presenting complaints and to understand how the use of progressive relaxation training may be of benefit. There are also conditions for which stretch-based relaxation training may be contraindicated. These conditions would include a history of loss of contact with reality or an ongoing thought disorder whereby there would be significant difficulty with interpreting or understanding instructions. Medical conditions such as diabetes or seizure disorders may be contraindicated in some cases, or need to be closely monitored by medical personnel during the training program. Women who are pregnant should have the approval of their health providers before beginning a relaxation program. Any medical condition that requires ongoing medications (e.g., hypertension) also requires an approval of the health care provider responsible for prescribing the medication, because relaxation training may potentially alter how the body responds to current medication intake. Progressive relaxation training has the potential to alter the level of an individual's overall physiological activity, in addition to altering cognitive and emotional processes. Therefore, clients should be

carefully screened for their participation in a progressive relaxation training program.

B. Presentation of Program

There are four elements to the initial presentation of the stretch-based relaxation program. The first element is to provide the client a historical overview of progressive relaxation training and the stretch-based approach. This overview would include a discussion of the natural use of muscle stretching and the value of systematic application of muscle stretching in the stretch-based relaxation protocol. The second element to discuss with the client is the concept of learning the skill of muscle relaxation. The emphasis of the program is to develop specific and effective skills of quieting the body whenever the individual chooses to do so. The third element of the initial presentation involves the importance of regular practice of the skills introduced in the training sessions. Without systematic practice, the skills are difficult to perfect and to employ in ongoing daily routines. Finally, the central focus of the program is on learning relaxation skills that are under volitional control. The program is not about a therapist "relaxing" the individual, but rather it is about the individual learning how to relax themselves with the skills that she or he has learned through regular practice.

C. Introduction to Basic Techniques

The basic series of 14 muscle stretches is introduced by first describing the importance of not invoking or increasing pain with any of the stretch-based relaxation activities. The client must be assured that the program is not centered on "enduring pain" in hopes of future gains. Then the client is told that each muscle stretch is done for 15 to 20 seconds and followed by a 60-second period of relaxation. The stretching of muscles is always done slowly and only to the point at which a slight muscle stretch is felt. Overstretching or "bouncing" of muscles is not appropriate.

After introducing the general approach to stretch-based relaxation, the client is shown each of the muscle stretches that includes both lower legs, both upper legs, the lower right/left back, stomach, chest, forehead, eyes, jaw, right/left neck, lower arms, and upper arms. The stretches are usually performed from a comfortable, reclined position in which the client's head is supported, eyes are closed (not necessary if closing the eyes creates discomfort), hands in curled and relaxed position, and legs are quiet with toes pointing away from one another at a 45 to 90 degree angle. Breathing

slowly and regularly is also part of the relaxation program and will be important in later sessions of practice as a timing mechanism for each of the stretch-relaxation exercises.

Once the introduction of the exercises has been completed, the client is reminded of the importance of maintaining a relaxed and comfortable position throughout the period of training. Any tight clothing (e.g., belt) may want to be loosened for the training session, and if eyeglasses, contact lenses, heavy jewelry or watches are bothersome, they should be removed for the duration of the training session as well. When the client is ready to begin the relaxation training, the therapist can begin with the following instructions from Carlson and Collins in 1997:

Before beginning the first exercise, take time to breathe in and out slowly and regularly (wait 2–3 minutes).

We are ready to begin the exercises now. For each exercise I will first describe the exercise. Then, when I say the words, “ready, begin” I want you to begin the stretch.

The first exercise involves stretching the muscles in the lower right leg. When I say “ready, begin” you are going to stretch the muscles in the lower right leg by pulling the toes of the right foot toward your head until you meet resistance in the muscles along the back of the right leg. Ready, begin the stretch by pulling the toes toward your head until you feel resistance. Hold the toes at that position while you feel the muscles stretching in the back of the right leg. Hold the stretch (wait 15 seconds) and now release the stretch and let the toes return to a resting position. Notice the difference in the muscle sensations in the back of the lower right leg as the muscles are now relaxing. Just let the muscles relax and become quiet (wait 30 seconds). You can help the muscles continue to relax by focusing your attention on the muscles in that lower leg and encouraging them to become less tense (wait 30 seconds).

Each of the remaining exercises follows a similar format and is done in a prescribed sequence. The sequence of the muscle stretches is designed so that if a muscle is activated to perform a stretch, it will then be stretched, in turn, to foster further relaxation of that muscle. The exercises are sequenced to move from the feet to the head region.

Following completion of the relaxation instructions, the client is encouraged to reactivate herself or himself with the following:

At this time, I will begin counting backwards from 5 to 1. With each number you should gain more aware-

ness. When I reach “1” you will be fully alert and ready to begin your next activity but you will still be feeling relaxed and comfortable. 5—begin to move your feet and legs. 4—move your arms and hands. 3—move your head and neck. 2—open your eyes. 1—you should now be alert with your eyes open; feeling relaxed and refreshed. Should you be lying down, you may want to roll to your side or stomach and then begin to lift yourself. That concludes your initial training session.

The relaxation exercise series should be practiced at least once a day for 5 out of the next 7 days. Generally, the training sessions are spaced at one week intervals. Audiotape instructions are available to assist in this home practice as it has been shown by Carlson and Holye in 1993 that audiotapes can improve the effectiveness of relaxation training. It is also helpful for the therapist to review with the client the importance of practice and addressing common beliefs such as “these exercises are so easy, I don’t need to practice,” “I can’t relax, so why would these exercises work,” or “When I relax, I am afraid that...”. Finally, the client should be given some sort of self-monitoring forms to take home to record periodic levels of muscle tension on a daily basis and to record when relaxation practice sessions occurred. One effective self-monitoring strategy involves the use of 10 cm visual analogue scales (anchored at one end with “least tension” and at the other with “most possible tension”) that the client can fill out periodically. These can be quickly and efficiently scored with a computer program. Another recently developed strategy is to use a hand-held computer that has been programmed to prompt for and to accept self-monitoring data.

The stretch-based relaxation protocol has four additional elements of training after the first session. The first additional element involves completing the entire series of stretches with a shortened set of instructions. The second element involves the use of music during the session and the use of breathing to self-pace the stretches. The third element includes muscle scanning, a procedure for taking “mental measurements” of muscle tension throughout the body, skills for reducing any areas of identified tension, and a shortened version of the muscle stretching protocol. The skills for reducing areas of identified muscle tension involve a stepped-process involving changes in posture, control of breathing, and isolated muscle stretches of those muscle areas identified as tense. The posture, breathing, and stretching (PBS) provides a systematic and progressive strategy for managing tension in the natural environment. The shortened version of the muscle stretching protocol begins from the stomach region so that the stretches of the legs and lower back are

eliminated from the relaxation procedures. The fourth and final element of the relaxation program involves coping with thought intrusions, deepening levels of relaxation, and addressing life stressors that may be contributing to muscle tension. Each of these four elements is introduced in each of the subsequent sessions following the initial training session.

IV. REPRESENTATIVE CLINICAL APPLICATION

The use of stretch-based relaxation training in the clinical environment is generally part of a comprehensive and multicomponent approach to problem management. Within many clinical settings, stretch-based relaxation training can provide a foundation on which to build a comprehensive set of self-regulation skills. It is rare that progressive relaxation training is the sole focus of treatment.

This can be illustrated by the sample case of Ms. X. Ms. X was a 48-year-old female who presented with the chief complaint of excessive muscle tension, pain, and anxiety following an automobile accident. During the initial consultation, the client reported that she now had intense and persistent fears associated with being in and driving an automobile. The fears were so acute that she was very anxious and sweated profusely while in the car. Moreover, she was only able to drive very slowly and in certain geographic areas of her community. There were areas of her community that she fastidiously avoided for fear of being in another accident. Ms. X's clinical presentation was consistent with the diagnostic criteria for Specific Phobia of (*DSM-IV*).

After the initial evaluation, Ms. X was presented with a formulation that described the events leading up to the development of her phobia, accounted for the subsequent elaboration of her phobia, and explained its continuation. Additionally, she was presented with a treatment plan that included a program of systematic desensitization. The first step in the treatment plan was to establish skills in control of muscle tension. Since she reported muscle pain in the region of her neck and shoulders, she was first asked to receive medical clearance for relaxation training. Following the receipt of medical clearance, the stretch-based program for progressive relaxation training was introduced.

Following the five sessions of the individual stretch-based relaxation training, Ms. X reported a decrease in overall tension and pain, but her fears of driving remained high. Therefore, the second phase of treatment that included constructing a desensitization hierarchy

and performing systematic desensitization was initiated. The stretch-based relaxation skills, especially the PBS strategy for decreasing noticeable levels of tension, was used during the desensitization program. The treatment ultimately included an *in vivo* session in which the client demonstrated her driving skills while maintaining control over her level of anxiety and muscle tension.

V. SUMMARY

There are many successful approaches to progressive relaxation training as indicated by the substantial experimental clinical literature that is available (for example, see Carlson and Hoyle in 1993 and Carlson and Bernstein in 1995 for reviews). The stretch-based progressive relaxation protocol provides the clinician with an alternative to the traditional tense-release progressive relaxation programs. It is an approach based on fundamental physiological principles and experimental clinical data. Application of stretch-based relaxation can help a client develop a set of self-regulation skills to maintain volitional control of muscle tension. Particularly for persons with musculoskeletal pain disorders, the stretch-based relaxation protocol offers a viable alternative to the tense-release strategies for achieving effective relaxation skills.

See Also the Following Articles

Applied Relaxation ■ Applied Tension ■ Breathing Retraining ■ Pain Disorders ■ Progressive Relaxation ■ Relaxation Training

Further Reading

- Carlson, C. R., & Bernstein, D. A. (1995). Relaxation skills: Abbreviated progressive relaxation. In W. O'Donohue & L. Krasner (Eds.), *Handbook of psychological skills training*. Needham, MA: Allyn & Bacon.
- Carlson, C. R., & Collins, F. L. (1997). *A guided approach to stretch-based relaxation training*, 2nd ed.
- Carlson, C. R., Collins, F. L., Nitz, A. J., Sturgis, E. S., & Rogers, J. L. (1990). Muscle stretching as an alternative relaxation training procedure. *Journal of Behavior Therapy and Experimental Psychiatry*, 21, 29–38.
- Carlson, C. R., & Curran, S. L. (1994). Stretch-based relaxation training. *Patient Education and Counseling*, 23, 5–12.
- Carlson, C. R., & Hoyle, R. L. (1993). Efficacy of abbreviated progressive muscle relaxation training: A quantitative review. *Journal of Consulting and Clinical Psychology*, 61, 1059–1067.
- Carlson, C. R., Okeson, J. P., Falace, D. A., Nitz, A. J., & Anderson D. (1991). Stretch-based relaxation training and

- the reduction of EMG activity among masticatory muscle pain patients. *Journal of Craniomandibular Disorders: Facial and Oral Pain*, 5, 205–212.
- Kay, J. A., & Carlson, C. R. (1992). The role of stretch-based relaxation in the treatment of chronic neck tension. *Behavior Therapy*, 23, 423–431.
- McCubbin, J. A., Wilson, J. F., Bruehl, S., Ibarra, P., Carlson, C. R., Norton, J. A., & Colclough, G. W. (1996). Relaxation training and opioid inhibition of blood pressure response to stress. *Journal of Consulting and Clinical Psychology*, 64, 593–601.
- Sherman, J. J., Carlson, C. R., McCubbin, J. A., & Wilson, J. F. (1997). Effects of stretch-based progressive relaxation training on the secretion of salivary Immunoglobulin A in orofacial pain patients. *Journal of Orofacial Pain*, 11, 115–124.

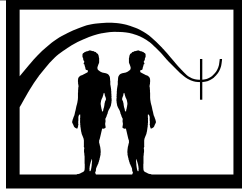

Structural Analysis of Social Behavior

Lorna Smith Benjamin

University of Utah

- I. Description of Treatment
 - II. Theoretical Bases (Conceptual Underpinnings)
 - III. Empirical Studies
 - IV. Summary
- Further Reading

GLOSSARY

- AG and DAG** Attachment group and disaffiliative attachment group. Specific normal and pathological behaviors described by the SASB model.
- case formulation** A specific method of connecting the presenting problems to patterns learned in relation to early caregivers.
- complementarity** Natural interpersonal matches described by the SASB model.
- copy process** Links between current problem patterns and early attachments. The three main copy processes are (1) be like him or her; (2) act as if he or she is still there and in control; (3) treat yourself as did he or she.
- core algorithm** Focus each story on input, response, and impact on the self. Include the ABCs (affect, behavior, and cognition) and try to enhance the growth collaborator while minimizing the regressive loyalist.
- five steps in IRT** (1) Collaboration; (2) learn what your patterns are, where they are from, what they are for; (3) block maladaptive patterns; (4) enable the will to change; (5) learn new patterns.
- growth collaborator** (GC, or Green) is the part of the person that wants to be happier and more functional.
- introjection** SASB model descriptions of what happens when you treat yourself as you have been treated.

IPIR Important person and his or her internalized representation.

regressive loyalist (RL or Red) is that part of the person that is loyal to the old problem rules, norms, beliefs.

SASB Structural analysis of social behavior classifies interpersonal and intrapsychic interactions in terms of attentional focus and two dimensions: love/hate and enmeshment/differentiation. For example, maternal protectiveness consists of focus on other that is friendly and moderately powerful. Complex behaviors can be described by using more than one code. For example, demanding dependency is: TRUST plus BLAME.

similarity SASB model codes when you choose to be like him or her.

I. DESCRIPTION OF TREATMENT

Structural analysis of social behavior (SASB) is to the therapist as a telescope is to an astronomer. You can see some activity in the sky with the naked eye, but there is much more to see and understand if you have an instrument that effectively amplifies available information. In the interpersonal domain, the SASB lens can go beyond the familiar and help the clinician see the quintessence of interpersonal and intrapsychic patterns more clearly. The SASB model also can provide specific predictions about interactions. Of special interest in psychotherapy are the predictions about developmental antecedents and expectable consequences of identified patterns.

The SASB model and technology have been applied by researchers and clinicians to many aspects of psychotherapy, including interpersonal and intrapsychic assessment, therapy process, therapy outcome, and therapy relationship. The model is not limited to any one ideology. It has been successfully used by investigators exploring a variety of approaches such as client-centered, psychodynamic, psychoanalytic, interpersonal, and cognitive-behavioral therapies. Its usefulness extends beyond dyadic individual psychotherapy. There also are published SASB-based reports on individual, marital, family, and group therapy. The SASB system has been used to investigate related problems such as psychopathology, psychophysiology of interpersonal interactions, behavioral genetics, personality, therapist training, and more. For any approach that involves interpersonal or intrapsychic interaction, the SASB system offers precision in description of interactions, predictions, measurement methods (questionnaires for self-ratings, coding system for objective observer assessment), and software (to create well-validated cross-sectional and sequential parameters for use in clinical feedback or research hypothesis testing).

Although SASB technology is useful in a variety of contexts, this article focuses on Benjamin's recommendations for how to use the SASB model to define a specific individual's psychopathology and choose interventions in psychotherapy that consistently target the core of that individual's pathology. These recommendations have emerged from three decades of using the SASB model in research and practice. They are collected under the heading Interpersonal Reconstructive Therapy (IRT). IRT offers a tightly operationalized SASB-based method for assessing a patient's presenting problems, relating them to presumed underlying motivation, developing a treatment plan that explicitly and consistently addresses the organizing underlying motivators of the problem patterns, and then implementing and assessing the success of that treatment plan. Because SASB itself is generic, it is no surprise that IRT directs the clinician to draw from all schools of psychotherapy, using any available method of intervention. The guidelines require that the intervention conform to the case formulation, to the treatment plan, and to the IRT core algorithm. IRT is particularly appropriate for "nonresponders," people who have failed to improve in response to treatment as usual (medications and/or psychotherapy). Typically, these nonresponders carry the label personality disorder. IRT can facilitate profound change in some but certainly not all members of this population. It cannot, for example, help individu-

als who are unable or unwilling to control alcohol or substance use.

The IRT approach will be illustrated by a case example. Mary had an inpatient consultation with L. S. Benjamin following her second overdose attempt. During hospitalization and after discharge, Mary participated in psychotherapy with a graduate student learning IRT. Data presented here were gathered immediately after discharge and 4 months later, at the end of the school semester. Her history and presenting features, like those of many nonresponders, were severe and complex. She began this therapy with most scale scores on a symptom checklist at or beyond the 98th percentile for outpatients. Mary continued therapy with the same therapist through the next school year. She did quite well in that she made no further suicide attempts, needed no additional hospitalizations, discontinued medications, performed well in her new job, and improved in key social relationships. When the student therapist left on internship, Mary terminated earlier than necessary and said she did not need to use our offer of a referral to a new therapist. She failed to return any research forms at that time, but clearly had dropped a palpable distance from her original high level of symptomatology. But neither was she "cured."

Although IRT usually seeks to address the total picture, restricted aspects of Mary's presentation and the related history will be addressed here, because of space limitations. The selected focus is Mary's suicidality, very low self-esteem, and her apparent inability to look after her own interests.¹ These interpersonal and intrapsychic problems will be described in terms of the SASB model, shown in Figure 1.

The poles of the axes of the model, starting at the right-hand side and moving clockwise, are Love, Enmeshment, Hostility, and Differentiation. Points between poles consist of components of the nearest poles. Bold type indicates transitive focus on other; underlined type indicates intransitive focus on self. Italics depict introjected focus from other. For example, **IGNORE** describes behaviors relevant to focus on another person that is hostile and autonomy giving. WALL-OFF involves an intransitive focus on self reacting to another person with hostility and autonomy

¹ IRT theory prescribes that specific affects accompany specific interpersonal positions. Therefore, working with interpersonal patterns can help relieve symptoms. For a simple example, a person who fears rejection may be anxious. Transforming the fear as well as learning to handle actual rejection can reduce anxiety.

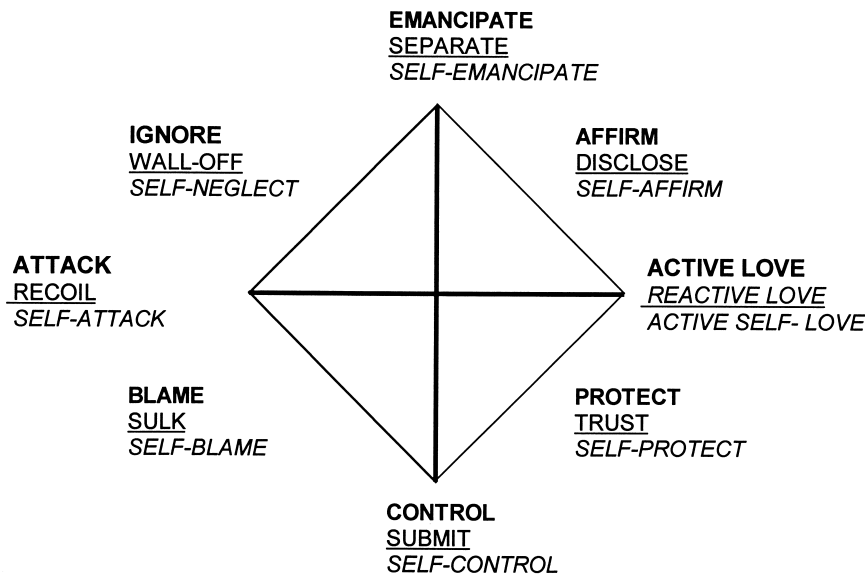

FIGURE 1 The simplified SASB cluster model. The poles of the axes, starting at the right-hand side and moving clockwise are Love, Enmeshment, Hostility, and Differentiation. Points between poles consist of components of the nearest poles (see text for further explanation). From Benjamin, L. S. (1996). *Interpersonal Diagnosis and Treatment of Personality Disorder*, 2nd ed. New York: Guilford Press.

taking. *SELF-NEGLECT* represents uncaring transitive focus on the self that is hostile and autonomy giving. Opposites are located at 180 degrees. For example, **PROTECT** is the opposite of **IGNORE**. Complements are shown by adjacent **BOLD** and UNDERLINED pairs. For examples, WALL-OFF matches **IGNORE** and TRUST complements **PROTECT**.

Mary rated herself and important other persons on the SASB Intrex questionnaires. Selected results appear in Figure 2. The top part of Figure 2 shows the SASB-based description of Mary's self-concept (squares) compared to her view of the way in which she remembered her mother focusing on her when she was a child (diamonds).

A glance at the figure shows that Mary rated her mother high on items describing **BLAME**, **ATTACK**, and **IGNORE**. This picture is highly consistent with the content of the clinical narrative. Mary's mother was alcoholic and spent much of her time in bars. Mary, the oldest child, was responsible for running the household. If mother came home in the middle of the night and found a speck of dirt on a dish in the cupboard, Mary would be yanked out of bed and beaten and forced to wash every dish in the cupboard. The mother called Mary all kinds of names and assured her that no man would ever love her.

The data for Introject show how Mary internalized these messages. The two curves at the top of Figure 2 are similar. Mary's mother **BLAMED** her and she **BLAMED** herSELF. Her mother **ATTACKED** her and she **ATTACKED** herSELF. Mother **IGNORED** her, and Mary **NEGLECTED** herSELF. The current suicidal episode included all these elements. The suicidal attack was a conscious internalization of her husband's rejection and criticism ("Nobody wants to be married to me. I deserve to die") and after discharge from the hospital, she neglected herself markedly. For example, she moved out with essentially no overt protest and then she failed to engage a lawyer. Although she needed money and was a competent worker, she did not groom herself before her initial job interviews.

The lower part of Figure 2 compares Mary's self-concept at the beginning of the outpatient treatment (squares), and 4 months later (diamonds). The two curves are starting to separate, with the later assessment suggesting a shift in the direction of more friendly self-control. Her IRT therapy had initially focused precisely on these issues: the need to engage in more self-control and self-care. Her student therapist was competent and warm (**PROTECTive**) and it is assumed that Mary internalized the structure and caring. The therapist's warm control offered the opposite of

Mother's focus and Introject at Time 1

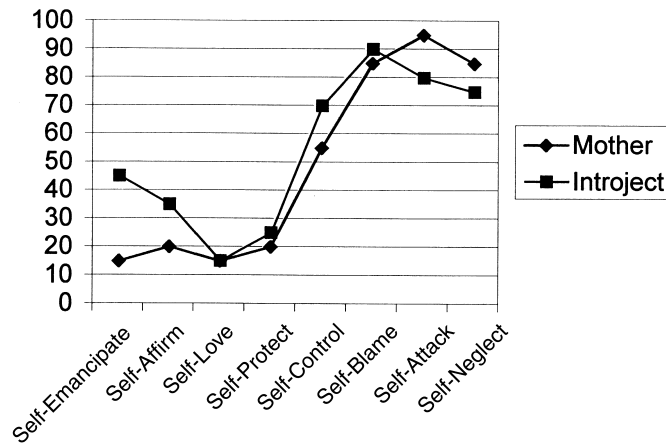

Introject at Times 1 & 2

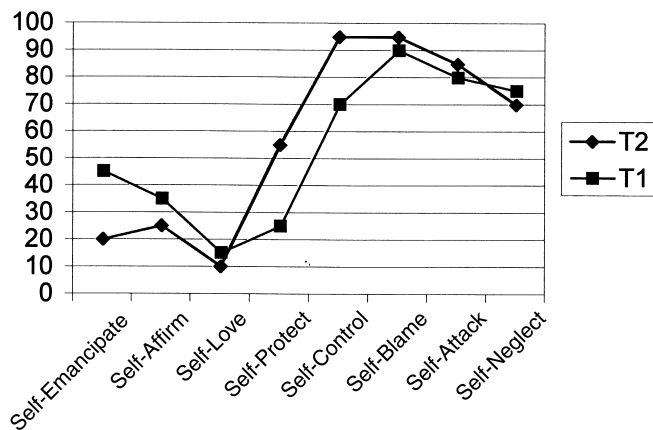

FIGURE 2 Mary's view of her mother is reflected in her introject (top). Her self-protectiveness and self-control began to improve early in IRT therapy (bottom).

Mary's mother's barhopping, coded, IGNORE. As she continued IRT, Mary internalized aspects of this corrective experience, and came closer to (but did not reach) the goal of letting go of the hope of rewriting childhood (discussed below). As time went by, the therapist offered less overt structure. Mary began to work on other skills, which included self-discovery, self-definition, and other "higher level" goals.

In general, the case formulation method in IRT requires that each presenting problem be linked to a key figure (usually a caregiver in childhood) by one of three

copy processes. These are (1) be like him or her; (2) act as if he or she is there and in control; (3) treat yourself as did he or she. These processes of internalization are respectively called identification, recapitulation, and introjection. Usually copy processes are described directly by the SASB predictive principles. Copy process #1 applies the principle of similarity. Mary did not exhibit this process. Process #2 often reflects complementarity. Mary had recapitulated the violence in her relationship with her mother in her first marriage to a violent man. She retained the role of victim. Her second husband was

not physically abusive, but he did specialize in neglect and rejection. She repeated the fate of being unwanted. Process #3 is introjection. As Figure 2 suggests, Mary introjected her mother's violence and degradation as well as the neglect. Copy processes can sometimes be seen in negative image, measured in terms of points 180 degrees apart on the SASB model. For example, Mary showed negative identification with her neglectful mother in that she had been very, perhaps too, protective of her own child.

This idea that patterns of disorder are replications of patterns learned long ago in relation to loved ones is startlingly simple. It is common for patients in IRT to say "I can't believe it, but it really is true: I am just like him!" Copying is universal, and, according to IRT, the difference between normality and pathology is simply in what is copied. Normal parents function from a baseline described by the SASB points **AFFIRM**, **ACTIVE LOVE**, and **PROTECT**, shown on the right-hand side of Figure 1. Normal children complement these behaviors with **DISCLOSE**, **REACTIVE-LOVE**, and **TRUST**. These baseline behaviors, described by SASB as friendly and moderately enmeshed and moderately differentiated, are called the attachment group (AG). Normal people internalize these benevolent ways of relating to themselves and others. Severely disturbed patients, like Mary, are more likely to have lived with baselines of **IGNORE**, **ATTACK**, and **BLAME**, called the disaffiliative attachment group (DAG) of behaviors. Like Mary, they internalize hatred of self and/or others.

The core issue in treatment planning in IRT therapy is to lock on to the motivation that is maintaining the copy processes that implement the problem patterns. Why are the copy processes sustained? For example, why does Mary continue her mother's norm of attacking herself? IRT's answer to the question is that it is for love. Every psychopathology is a gift of love. The "Gift of Love" hypothesis holds that behaving according to the "rules" of the internalized representation of the attachment figures, called important persons and their internalized representations (IPIRs), is an attempt to seek "psychic proximity." Doing things his or her way offers psychic security in the same way that the toddler is reassured by returning to the mother for a hug. This perspective is named the developmental learning and loving (DLL) theory of psychopathology. The fact that people will maintain patterns from childhood despite their enormous cost in adulthood is evidence of the stunning power of early figures in the development of the psyche.

It follows that if the problem patterns reflect early learning through copy process maintained by the gift of

love, then the treatment plan must target that attachment. Somehow, the patient must give up the organizing wishes to rewrite history, or to wreak revenge (followed by reconciliation). The heart of reconstructive change will involve grieving what has been lost and what can never be. The patient must see and accept that childhood cannot be relived better and "righter." Letting go of those wishes is not easy. Tragically, the less secure and the more damaged the person, the more likely he or she is to cling to old fantasies of rescue or restitution. It takes good security and a solid psychological base to be able to let go of old patterns and move on to friendly independence.

IRT attempts to facilitate the development of new bases so that the patient can have the courage to let go and live differently and better. The therapy relationship is part, but not all, of the process of building a new base. Sometimes the parenting figure himself or herself can best serve this role.² The IRT therapist is quite active in helping the patient choose and maintain current relationships that are based in the normal (AG) range of behaviors. This is easier said than done, for there are powerful forces³ that call the patient back to the familiar domain of DAG.

In the effort to transform the gift of love, every intervention in IRT is supposed to comply with three requirements: (1) It must conform to the case formulation, already discussed; (2) in addition, an intervention must implement one or more of five therapy steps; (3) finally, a good intervention implements the core algorithm.

The five therapy steps are (a) collaboration; (b) learning what your patterns are, where they are from, and what they are for; (c) blocking maladaptive patterns; (d) enabling the will to change; and (e) learning new patterns. Each of these five steps can be facilitated by any and all interventions known to the domain of psychotherapy. Therapy techniques are classified in two subgroups depending on whether they facilitate (a) experiencing or (b) self-management. In general, techniques from psychodynamic therapies encourage experiencing (e.g., discovery of ancient patterns and buried feelings through free association). Those from

² This requires that the parent is currently not defensive and, more important, that the therapist is not blaming. The assumption is that the pathology stems from the internalized representation, not the "reality."

³ Complementarity with current figures is one such force for stasis. Most threatening, however, is the fact, that when people give up old patterns, they lose their identity. "I don't know who I am if I am not what I have been." This undefined state can be quite terrifying, and one resolution is to go back to the old ways.

behavioral therapies (e.g., learning and practicing skills in assertiveness) are more likely to invoke self-management techniques. Both domains of intervention are required in IRT: (1) The patient has to experience how it was and is to engage the will to change; (2) once he or she decides to change, learning better self-management can follow. According to IRT, the main difference between psychodynamic and behaviorally oriented therapies is in their relative emphases on (1) and (2).

When choosing an intervention, it often is helpful to think of the patient as, in effect, two people. The part that comes to therapy and hopes to change to function and feel better is called the growth collaborator (GC) or the "Green." The part of the person that wants to remain loyal to old ways is the regressive loyalist (RL), or the "Red." The conflict between the Green and the Red is everpresent and can be understood only after the case formulation is clear. In Mary's case, for example, the Red was often furious when someone showed signs of rejecting her; she was likely to react with self-destructive behavior. The Green, by contrast, would reflect carefully on why Mary was so panicked and angry about being left, and how her behaviors encouraged her husband to avoid her (step 2). For someone still in a problem relationship, these insights can help the patient contain the actions that alienate the spouse (step 3). Later, the patient can consider ways of relating to the spouse that might be more successful (step 5). Unfortunately, the Green cannot do much until the Red has had her say and the patient is truly sick of repeating the pattern. That decision to give up the ancient ways (step 4) is the most critical and most elusive part of therapy. It is facilitated if the therapist can minimize interventions that support the Red, and maximize those that encourage the Green. This can be altogether tricky. For example, after a fight with her husband, therapist efforts to encourage better patterns (help the Green) could easily be seen by Mary as blaming her (excite the Red). By using carefully chosen words informed by SASB codes of the therapy process and the case formulation, the therapist can make interventions that are perceived mostly as Green.

Finally, the core algorithm requires that the clinician extract from the therapy narrative a current episode that reflects the presenting problems. In Mary's case, for example, anything involving rejection, attack, or blame would be highly relevant. The clinician makes sure that each episode is fully explored in terms of (1) input, (2) response, and (3) Impact on self. A second feature of the core algorithm is to remember to attend to three domains, called the ABCs (affect, behavior, and cognition). The third feature of the core algorithm is that the clinician should try to enhance

the Green and minimize the Red. For example, if Mary reports an episode of raging and crying when her date does not show up for lunch, it is appropriate to conduct a verbal walk through her morning up to the point where the rage erupted. This includes consideration of input (what set her off); response (rage and despair); and impact on self ("Nobody will ever love me"). The therapist encourages Mary to describe not only the situation and her behavior (B), but also her feelings (A) and her thoughts (C) about it. This could take most of a session. It would be excellent if the discussion also could contribute to her program of learning about how her repetition of patterns of rejection and abuse is related to the residuals of her attachment to her mother. (Her sexually abusive father also is an important part of Mary's story, but cannot be developed here.) After substantial repetition and lots of support, Mary eventually can "get the picture" emotionally and behaviorally as well as cognitively. That, of course, is the most difficult and challenging step for both patients and therapists. Various additional specific procedures to facilitate that realization and enhance the decision to let go are discussed in Benjamin. When the old wishes are given up, Mary and other IRT patients can give up the quest and the associated repetitions of the family scenario.

II. THEORETICAL BASES (CONCEPTUAL UNDERPINNING)

Bowlby argued that having reliable access to a supportive primary caregiver provides basic security required for independence. He emphasized that security is not the direct result of receiving food or the satisfaction of other needs. Harlow confirmed Bowlby's view of attachment by showing that baby monkeys gained more security and willingness to explore from having a huggable terry cloth laboratory mother that did not provide milk, than from a bare wire mother that did. Harlow suggested that contact comfort is a key component of attachment. Bowlby further proposed that children organize their behavior around internal working models derived from experience with their attachment persons. Copy process theory draws directly on Bowlby's concept of internal working models. Describing an individual's patterns in terms of the SASB model simply makes more explicit the nature of the internal models and their connection to the problem behaviors. Bowlby's work with attachment as a primary drive was revolutionary. Today's burgeoning literature continues to show that early attachment has a profound impact on mental and physical health.

IRT combines the fundamental principles from attachment theory with behavior theory. From behavior theory comes the idea that what works is likely to be repeated. Therapy must therefore identify and change the rewards. Attachment theory provides the definition of what “works.” In other words, psychic proximity is the main “reward.” IRT’s focus on attachment demotes traditional “drivers” such as anger, rage, power, superiority, and the like. These human traits are very much a part of IRT, but they are not considered to be the primary targets of intervention. IRT centers instead on love for an important person and his or her internalized representation (IPIR). Once the loyalty to that internal representation is transformed,⁴ the patient is free to learn and implement an entirely new and better way of living.

III. EMPIRICAL STUDIES

There have been many published studies of the methodological and clinical validity of the SASB model. There have been no formal published studies on the validity of IRT. However, IRT has repeatedly been successfully applied in a difficult-to-treat population, illustrated by Mary. The main measures have been in “testimonials” and in dramatic reductions in numbers of hospitalizations and suicide attempts. Scattered sets of before and after measures using Intrex questionnaires and symptom scales also are encouraging. However, with these severely disordered individuals, treatment may have to last for 2 or more years to achieve definitive and stable remission. The present hope is to conduct formal clinical trials at the University of Utah Neuropsychiatric Institute and possibly with colleagues at the University of Pittsburgh.⁵

IV. SUMMARY

IRT seeks to treat “nonresponders” by directly identifying and transforming the underlying motivations for the interpersonal and intrapsychic problems. The presenting problems are linked specifically to relationships with early caregivers in the form of three types of copy process: be like him or her; act as if he or she is still there and in control; treat yourself as did he or she. The

⁴ It is assumed that the neurologically based templates that have been implementing the problem patterns must be transformed by the new learning.

⁵ Paul Pilkonis and Jennifer Skeem have teams of clinicians engaged in preliminary trials to gather pilot data preparatory to applying for grant support.

motivation for copy process is to implement the rules or values of the persons being copied in order to provide testimony to their beliefs and to achieve reconciliation with them. The treatment implication of this “Gift of Love” hypothesis is that these now impossible wishes must be recognized, grieved, and given up. Then, personality reconstruction can begin. To reach that goal, IRT draws from any and every school of therapy as long as an intervention can achieve one of five therapy steps, use the core algorithm, and fit the case formulation. Assessment of patterns, copy links, therapy process, therapy content, and the effectiveness of therapy steps are greatly facilitated by clarity and explicitness provided by the SASB model and its associated technology.

Acknowledgments

Thanks are expressed to Karla Moras, Linda Kidd, Tracey Smith, and the editors, who made helpful comments on an earlier version of this paper.

This chapter derives from and summarizes portions of Benjamin, *Interpersonal Reconstructive Therapy*, currently in press with Guilford Publications.

See Also the Following Articles

Configurational Analysis ■ Formulation ■ Sullivan’s Interpersonal Psychotherapy

Further Reading

- Benjamin, L. S. (1993). Every psychopathology is a gift of love. *Psychotherapy Research*, 3, 1–24.
- Benjamin, L. S. (1996). An interpersonal theory of personality disorders. In J. F. Clarkin (Ed.), *Major theories of personality disorder* (pp. 141–220). New York: Guilford Press.
- Benjamin, L. S. (1996). Introduction to the special section on Structural Analysis of Social Behavior (SASB). *Journal of Consulting and Clinical Psychology*, 64, 1203–1212.
- Benjamin, L. S. (1996). *Interpersonal Diagnosis and Treatment of Personality Disorder*. Second edition. New York: Guilford Press.
- Benjamin, L. S. (1998). *Reconstructive Learning Therapy for Passive Aggressive Personality Disorder. APA Psychotherapy Videotape Series II*. Washington, DC: American Psychological Association.
- Benjamin, L. S. (2000). SASB Intrex users manual. Salt Lake City: University of Utah.
- Benjamin, L. S. (2001). Known papers and books that use SASB technology. An electronic file that lists nearly two hundred SASB publications; available from Benjamin@Xmission.com.
- Benjamin, L. S. (in press). *Interpersonal reconstructive therapy (IRT)*. New York: Guilford Press.
- Cassidy, J., & Shaver, P. R. (1999). *Handbook of Attachment*. New York: Guilford

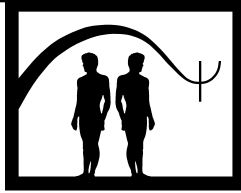

Structural Theory

Alan Sugarman

San Diego Psychoanalytic Society and Institute and University of California, San Diego

- I. Limitation of the Topographic Model
 - II. Structural Theory
 - III. The Id
 - IV. The Ego
 - V. The Superego
 - VI. Structural Conflict
 - VII. Technical Implications
- Further Reading

GLOSSARY

autonomous ego functions *Primary*: Inborn functions that follow a development timetable that unfold sequentially, so long as the environment does not interfere. Includes processes such as cognition, perception, and language. *Conflict free*: Refers to primary autonomous ego functions that arise without precondition of conflict. *Secondary autonomy*: Ego functions that arise out of conflict but become independent of such conflict.

compromise formations The balance of superego injunctions and id demands created by the ego and manifested in fantasies, symptoms, dreams, character traits, etc.

condensation A process whereby a sole idea represents several associative changes and is part of the functioning of the id.

displacement The process employed by the id in which an idea's emphasis, interest, or intensity is detached and passed onto other ideas.

drive derivatives The surface and conscious representation of id drives.

drives Psychic representation of instinctual and biological needs and urges.

ego The psychic structure posited by the structural theory developing out of the id, which functions as a synthesizing agency between the demands of the superego and the pressure for expression in the id. Functions include self preservation, perception, motility, learning, memory, cognition, language, reality testing, and the synthetic function.

ego psychology An offshoot of structural theory developed by Heinz Hartman and David Rapaport emphasizing the role of the ego in mental life.

id Identical to the earlier concept of the System Unconscious. The id is, in the structural theory, the reservoir for psychic representation of the two instinctual drives of libido and aggression.

infantile sexuality The idea that infants and children have sexual intentions, aims, and motivations.

intrapsychic conflicts Conflicts between intentions of the person, both conscious and unconscious, in conflict with the demands of external prohibitions.

libido The instinctual drive oriented towards merging, and is generally thought to be the basis of sexuality.

pleasure principle The economic concept of the organization of the mind under the structural theory that posits the motivating drive as the discharge of excitations, experiences, pleasure.

primary process A type of logic employed by the id in which the pleasure principle guides the direction of behavior. It is a timeless process that modifies distinctions in order to create representations and opportunities for pleasurable discharge.

reality principle The manner in which the ego carries out its work based on a perception and measurement of social reality demands.

resistance A defense aimed towards keeping the unconscious material activated by analysis or psychotherapy from reaching consciousness.

secondary process thinking The mode used by the ego that is based on logic, linear thinking, and time orientation.

structure A group of psychological functions or processes that are organized hierarchically and have a slow rate of change.

superego The psychological structure that represents the internalization of the parents' values and prohibitions and consequently those of the larger social cultural world.

topographical model An early model of psychoanalytic theory developed by Sigmund Freud which characterized mental phenomenon as being unconscious or conscious in postulated functions in a relationship to these qualities of mental life. This thinking included the ideas of systems unconscious, preconscious, and conscious.

I. LIMITATION OF THE TOPOGRAPHIC MODEL

Structural theory, sometimes referred to as the structural model or the tripartite model, refers to Freud's final and ultimate model of the mind that he first introduced with his book, *The Ego and the Id* in 1923, and elaborated in *Inhibitions, Symptoms, and Anxiety* in 1926. This shift in conceptualizing the workings of the mind away from the topographic model that had organized his thinking for over 20 years was prompted by Freud's realization that his topographic theory had too many theoretical inconsistencies to remain viable, and that it could not account adequately for a variety of clinical phenomena, most notably unconscious guilt. Freud came to see that understanding the workings of the mind, particularly the intrapsychic conflicts that give rise to most mental phenomena, needed to be based on something other than the relationship of mental contents and functions to consciousness. Thus, he changed his metaphors for understanding the mind away from the notion that mental contents moved from the depths to the surface. To accomplish this goal and to ensure that his new model more adequately explained the complexity of the psyche necessitated the relinquishing of his constructs of the systems Unconscious, Preconscious, and Conscious.

II. STRUCTURAL THEORY

These layers or stratas of the mind were replaced by what he first called agencies and later called structures—the id, the ego, and the superego. The term

structure is an ambiguous one in psychoanalysis, although most analysts adhere to the definition of David Rapaport that the term refers to a group of psychological functions or processes that are organized hierarchically and have a slow rate of change. The id, ego, and superego are certainly not the only mental structures that comprise the mind. But they are thought to be its superordinate structures, leading Merton Gill to refer to them as macrostructures. It is assumed by most psychoanalysts that the mind is composed completely of these three superordinate structures, each of which can have substructures. The interrelationships within and between these three structures, particularly intrapsychic conflict, are what give rise to most mental phenomena and all psychologically mediated behavior.

Freud did not abandon all of the key concepts that he had developed during his topographic era of model building when he replaced it with the structural theory, however. His important concepts of infantile sexuality, libidinal and aggressive drives, unconscious mental functioning, and internal conflict remained as did more dubious concepts such as psychic energy. But these concepts were modified and integrated into structural theory with varying degrees of conceptual clarity and success. For example, the concepts of unconscious, preconscious, and consciousness were retained. But these concepts now became adjectives, used merely to describe whether any particular mental content or process was within the individual's conscious awareness or not. The terms no longer retained any structural or systemic implications. Despite this fundamental reconceptualization, it is not uncommon, even today, to hear psychoanalysts speak of the Unconscious as though it were a structure, to imply that unconscious mental phenomena are somehow deeper and more primitive than conscious mental phenomena, or to talk about the technical need to make the Unconscious conscious. Such analysts seem not to realize that such ways of thinking about analytic matters are outdated and at odds with how we have come to understand the workings of the mind.

III. THE ID

Nonetheless, conceptual overlap between the earlier topographic model and the later structural one remains important in understanding the intricacies as well as the necessity for utilizing structural theory in clinical situations. Perhaps the clearest overlap between the two models involves how Freud formulated the id. The id is virtually identical with the earlier concept of the system

Unconscious. Thus, it is the reservoir for psychic representations of the two instinctual drives, libido and aggression. As such its contents revolve around the basic, pleasure-seeking urges of mankind. It operates according to the pleasure principle and is organized according to the logic (or lack thereof) of the primary process. Freud retained his concept of psychic energy when he developed the structural model and he used differences in the nature of psychic energy to explain differences between structures of the mind. Psychic energy was thought to be mobile and its discharge rapid in the id, allowing for the clinical manifestations of primary process thinking—condensation and displacement. Drives were thought to be relatively unfused in this structure. Freud was drawn to the analogy of the id as a wild, untamed horse that had to be broken by the rider, the ego. Thus, he saw the ego as developing out of the id so that the individual could adapt to reality rather than run amok as the id's drives were given free rein. Freud viewed the contents of the id as dynamically unconscious; that is, they were defended against so as not to reach conscious awareness and cause unpleasure. He thought that they could only be known through their surface manifestations—what came to be called drive derivatives. More recent theorists such as Charles Brenner have questioned this dichotomy, arguing that the concept of drives is a purely theoretical and abstract one. To the degree that drive derivatives are the real clinical phenomena encountered, their availability to consciousness is a graded one. It is simply at odds with clinical experience to speak of completely unconscious drives.

IV. THE EGO

The ego is generally accepted as the most important structure of the mind in understanding the ability of humans to adapt and to survive in the world. In fact, it is so important that psychoanalytic thinkers such as Heinz Hartmann and David Rapaport developed an offshoot of structural theory, called ego psychology, between the late 1940s and the early 1960s. Their ideas are generally subsumed under the rubric, structural theory, today. But their wish to highlight the importance or even preeminence of the ego among the structures of the mind is worth noting. As will be described later, it has major implications for the clinical practice of psychoanalysis. Freud described the ego as developing out of the id because of the necessity to mediate between the drive wishes of the id and the demands and restrictions of external reality. As development proceeds, the ego comes to balance superego injunctions

along with these other pressures. Thus, it is the source of compromise formations manifested in fantasies, symptoms, dreams, character traits, and so on. The ego accomplishes this complex task of mediating between the id, superego, and external reality according to the reality principle and through the use of secondary process thinking. The ego psychologists emphasized that the ego's structure was so complex and its mode of organization so substantially different than that of the id that it seemed more likely that both structures evolved out of an originally undifferentiated psychic matrix. This model of the mind developing through progressive differentiation is far more in keeping with modern concepts of developmental psychology than is Freud's metaphor of the rider ego.

Regardless of how one understands its origins, the ego remains understood as the "coherent organization of mental processes" that Freud described. Its most important clinical function is that of defense. That is, the ego monitors the conscious awareness and/or expression of id impulses and uses a wide array of defense mechanisms to keep them from arousing excessive unpleasure or causing danger to the individual. The ego does not just defend against the id, however. Defenses are just as readily deployed against the superego or against perceptions of external reality.

Defense is also not the only ego function. In *An Outline of Psychoanalysis* Freud discussed other ego functions including self-preservation, perception, motility, and learning. Later memory, cognition, language, reality testing, and the synthetic function of the ego were described by psychoanalysts including Anna Freud, Hartmann, Kris, and Loewenstein, Bellak, Arlow, and Brenner. All agree that it is impossible to develop a comprehensive list of ego functions because the mind is so complex. Nonetheless a particularly useful delineation of 12 ego functions that can be empirically measured has been developed by Leopold Bellak and his collaborators. These 12 functions include reality testing; judgment; sense of reality of the world and of the self; regulation of drives, affects, and impulses; object relations; thought processes; adaptive regression in the service of the ego; defensive functioning; stimulus barrier; autonomous functioning; synthetic-integrative functioning; and mastery-competence. This list is neither exhaustive nor theoretically consistent. But it does demonstrate the complexity of the ego and does offer a method of quantitative research.

Many of these functions also help to clarify another reason that the ego psychologists objected to Freud's idea that the ego developed out of the id. Freud's idea carried with it the notion that all ego functions arise

out of intrapsychic conflict and are influenced by the id. Reality testing, for example, was thought to arise out of hallucinatory wish fulfillment conflicting with external reality. In contrast Heinz Hartmann argued that many ego functions are primarily autonomous. That is, they are inborn and follow a developmental time table that will unfold sequentially as long as the environment does not interfere. Processes such as cognition, perception, and language, for example, are conflict-free. Conflict was not necessary for their genesis or development. Other ego functions achieve what Hartmann called secondary autonomy. That is, certain functions or personality traits may originally develop out of conflict but over the course of development become functionally autonomous. Thus, conflict-related behaviors can become independent of their roots. This concept helps to explain the imperviousness of certain fantasies or character traits to interpretation, despite the therapist's ability to analyze and interpret all the various conflicts that gave rise to it.

V. THE SUPEREGO

The superego was the third structure of the mind in Freud's structural theory. In large part it is this structure and the clinical phenomena that it elucidates that caused Freud to develop his structural model in the first place. Prior to giving up the topographic model, Freud struggled to understand the phenomenon of unconscious guilt and its clinical manifestations, particularly the negative therapeutic reaction and issues pertaining to masochism. To explain these phenomena, he offered the concept of the superego as the internalization of the parents' values and prohibitions. He described it as developing out of the ego and becoming a full-fledged structure in its own right as part of the child's oedipal resolution. This latter point continues to be debated in the literature. Some contemporary structural theorists such as Paul Gray argue that the superego is just a specialized ego function and not a structure in its own right. In contrast some child psychoanalysts have noted the presence of a fully functioning superego far earlier than oedipal resolution and have argued that its function as a separate mental structure needs to be kept conceptually separate from the developmental level of the drives against which it is pitted. Despite these subtleties of theory, most psychoanalysts see the superego as crucial in understanding behavior. In essence it functions both as a conscience and as an internalized set of ideals, both of which are significant motivators of behavior.

VI. STRUCTURAL CONFLICT

These three structures of the mind—id, ego, and superego—function both on their own and interact in ways that determine every aspect of human behavior. But it is important to realize that calling structural theory a tripartite model is somewhat misleading. This is because external reality plays a far more prominent role in structural theory than it did in the earlier topographic model. Because the structural model stresses the importance of adaptation to an external environment, external reality is viewed as placing demands on the ego's mediating abilities just as much as the id and the superego. Thus, the compromise formations that the ego organizes to balance these sources of pressure must take into account reality's demands also.

The clinical implications of this model generally involve its role in intrapsychic conflict. Conflict between any of the structures can occur as can intrastuctural conflicts wherein subprocesses or functions of each structure conflict with each other. Examples of the former include an ego defense arrayed against an id drive or a superego injunction deployed against an id drive or an ego function. An intrastuctural conflict might involve competing ideals within the superego, for example. The fantasies, symptoms, behaviors, or character traits for which patients seek therapy are understood as compromise formations involving the ego's attempt to mediate the conflicts between these structures and external reality.

VII. TECHNICAL IMPLICATIONS

Only recently have psychoanalysts delineated a manner of working with patients that follows logically from this structural model. Fred Busch and Paul Gray are the two psychoanalysts most closely associated with a contemporary structural approach to technique. In essence, this way of working with patients emphasizes the need to expand the patient's autonomous ego functioning by teaching him or her to observe intrapsychic conflict as it becomes manifest in sessions. The patient is taught to closely observe his or her associations with a particular lookout for evidence of resistance. Resistance is monitored carefully with the analyst listening to and teaching the patient to listen for moments in the analytic process when resistance to the direct and unfettered expression of thoughts or feelings occurs. The patient learns to oscillate between being in analysis and observing the free associations that characterize the psychoanalytic process.

The goal of an analysis shifts from the topographic emphasis on making the unconscious conscious so that core unconscious fantasies can be changed to gaining mastery over them by thinking about them. Resistance analysis gains center stage in analytic technique guided by structural theory rather than being a means to an end with the end being making unconscious mental contents conscious. Self-analysis becomes a key criterion for termination, as patients master the analytic way of thinking and apply it to their own associations, particularly noticing unconscious defensive activity aimed at keeping thoughts out of awareness.

This approach to analytic technique is based on the realization that the way in which the ego handles its task of mediating the other structures and reality determines psychological health. Thus, the way in which a person thinks, and the amenability of that thinking to analytic interventions, are more important than the contents of that thinking. Oedipal, preoedipal, narcissistic, and so on refer to mental content. But structural theory, in contrast to earlier analytic models, focuses on mental structure. Analysts now try to help the patient to reestablish mental connections that have been disrupted by defense rather than to recover memories or fantasies. Structural theorists such as Busch or Gray take the ego's synthetic function seriously. Thus, insight becomes directed at understanding the workings of the patient's mind instead of at deep, hidden, mental content. New solutions to conflict emerge as a result of bringing the conflict between unconscious wishes and defenses or superego under the scrutiny of the autonomous ego.

Toward this end, vicissitudes of conflict are addressed by the analyst as they appear in sessions. Busch points out that the ego is regressed when in the midst of conflict so that thinking becomes preoperational and concrete. Thus, interventions by the analyst must be concrete and immediate in order to be grasped by the patient's regressed ego. Conflict, as it occurs in the associational processes, can be seen more readily by the patient than unconscious content, which is more abstract, and less immediately visible. Furthermore, interpretations of deep unconscious content as practiced under the topographic model risk analytic change occurring on the basis of identifying with the analyst's authority rather than on any expansion of the ego's ability to perceive and master conflict. Finally, the structural model postulates that the ego defends against unconscious id contents because they would stimulate excessive anxiety or guilt if they became conscious. To address these contents directly without first exploring and modifying the anxieties that motivate the defense will only increase the patient's anxiety and resistance.

Although such technical implications may seem obvious, they have only been elucidated over the past 15 years. Until then psychoanalysts practiced according to an implicitly topographic perspective despite their belief that they were operating from a structural orientation. This state of affairs was due primarily to Freud's writings on technique having been published during his topographic era of theorizing. He never returned to the theory of technique after formulating his structural model. Thus, too many psychoanalysts clung to outdated ways of working or of formulating their work because of their wish to remain true to Freudian technique. Even today it is not uncommon to hear analysts interpret unconscious anger, for example, before they have interpreted and understood the patient's reluctance to be aware of his or her anger. Furthermore, psychoanalysts of orientations other than Freudian have continued to misunderstand structural theory so that their critiques of so-called Freudian technique seem appropriate to technical concepts of the topographic era and not relevant to a truly structural approach to psychoanalytic practice. Modern day or contemporary structural theory offers a model and way of working with patients that is the most comprehensive and integrative of psychoanalytic approaches today. It is capable of integrating the clinical findings of self-psychology or object relations theory while retaining all of Freud's brilliant insights into the organization of the mind and the way in which this organization affects behavior.

See Also the Following Articles

Intrapsychic Conflict ■ Oedipus Complex ■ Structural Analysis of Social Behavior ■ Topographic Theory ■ Transference Neurosis ■ Unconscious, The

Further Reading

- Bellak, L., Hurvich, M., & Gediman, H. K. (1973). *Ego functions in schizophrenics, neurotics, and normals*. New York: Wiley.
- Boesky, D. (1995). *Structural theory*. In B. Moore & B. Fine (Eds.), *Psychoanalysis: The major concepts*. New Haven, CT: Yale University Press.
- Busch, F. (1995). *The ego at the center of clinical technique*. Northvale, NJ: Aronson.
- Gray, P. (1994). *The ego and analysis of defense*. Northvale, NJ: Aronson.
- Moore, B., & Fine, B. (Eds.). (1990). *Psychoanalytic terms and concepts*. New Haven, CT: Yale University Press.
- Sandler, J., Holder, A., Dane, C., & Dreher, A. V. (1997). *Freud's models of the mind*. Madison, CT: International Universities Press.

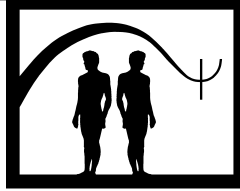

Substance Dependence: Psychotherapy

Kathlene Tracy, Bruce Rounsaville, and Kathleen Carroll

Yale University

- I. Description of Treatment
 - II. Theoretical Bases
 - III. Empirical Studies
 - IV. Summary
- Further Reading

GLOSSARY

community reinforcement approach Interventions based on learning theory that are designed to rearrange significant aspects of local communities, such as vocational, family, and social activities, to differentially support a non-substance-using lifestyle.

disease model approach Interventions that help the individual who abuses substances accept that they have an illness or disease and surrender by acknowledging that there is hope for sobriety through accepting the need for help from others and a higher power. A major goal is fostering active participation in self-help groups (e.g., AA, NA, CA).

methadone maintenance A pharmacological approach to the treatment of opioid dependence in which the individual who abuses opioids is maintained on an agonist, methadone, that has action similar to that of the abused drug but is considered to be less harmful.

substance abuse (DSM-IV criteria) A maladaptive pattern of substance use not due to dependence leading to significant impairment or distress that is characterized by one or more of the following occurring at any time in a 12-month period: recurrent substance use resulting in failure to fulfill major role obligations at home, work, or school; recurrent substance use in physically hazardous situations; recurrent

substance-related legal problems; continued use despite having persistent or recurrent interpersonal or social problems exacerbated or caused by the effects of using.

substance dependence (DSM-IV criteria) A maladaptive pattern of substance use leading to significant impairment or distress that is characterized by three or more of the following occurring at any time in a 12-month period: tolerance; withdrawal; taking the substance in larger amounts or for longer periods than intended; expressing a desire to cut down on use or unsuccessful efforts to cut down or stop using; spending large amounts of time obtaining the substance, using, or recovering from the substance's effects; important social, occupational, or recreational activities have been given up or reduced because of the substance use; and continued use despite recurrent physical or psychological problems that is made worse or caused by the use.

therapeutic community An intervention that supports the individual's submission to group ideology of abstinence from substances. Every aspect of the individual's daily life is regimented often through confinement, structure, and daily work assignments.

Given the place of this article in a volume describing a variety of psychotherapeutic approaches, this article focuses on those aspects of individual and group therapy that are unique to the treatment of substance dependence. This article presents guidelines on therapy applicable to those both dependent on alcohol as well as those dependent on other drugs.

I. DESCRIPTION OF TREATMENT

Some form of psychotherapy or behavioral therapy is usually considered as a treatment option for virtually all patients seeking treatment for substance use disorders. Treatment seekers typically represent the more severe end of the spectrum of community members who meet criteria for current substance use disorders. Most of those who seek treatment do so only after numerous unsuccessful attempts to stop or reduce substance use on their own. The alternatives to psychotherapy are either pharmacological or structural limitations from access to drugs and alcohol such as in residential setting. Both these alternatives have limited effectiveness if not combined with psychotherapy or counseling. Removal from the substance-using setting is a useful and, sometimes, necessary part of substance treatment but is seldom sufficient, as is shown by the high relapse rates typically seen from residential detoxification programs or incarceration during the year following the patient's return to the community.

The major strategy that is now common to all currently practiced psychotherapies for individuals who abuse substances is to place primary emphasis on controlling or reducing substance use, while pursuing other goals only after substance use has been at least partly controlled. This means that either (a) the therapist employs techniques designed to help the patient stop substance use as a central part of the treatment, or (b) the therapy is practiced in the context of a comprehensive treatment program in which other aspects of the treatment curtail the patient's use of substances (e.g., methadone maintenance, disulfiram for alcoholics, residential treatment). Because people who abuse substances frequently react to increased anxiety or other dysphoric affects by resuming substance use, anxiety-arousing aspects of treatment are typically introduced only after a strong therapeutic alliance has been developed or within the context of other supportive structures (e.g., inpatient unit, strong social support network, methadone maintenance) that guard against relapse to substance use when the patient experiences heightened anxiety and dysphoria in the context of therapeutic exploration.

Psychotherapy to treat substance abuse can occur in a variety of settings. For example, individuals who are severely dependent remain unsuccessful at achieving abstinence may become inpatients or be admitted to a detoxification program. While in the detoxification program, the individual may receive brief directed psychotherapy that focuses mainly on controlling the impulse to use. In partial hospitalization or residential

treatment programs, psychotherapy offered is typically longer in duration, and not only focuses on the impulse to use, but also includes a greater representation of managing and changing behavioral aspects that contribute to or maintain the person's substance use. In outpatient treatment settings, psychotherapeutic treatments often include all the components previously mentioned as well as an opportunity to engage in longer-term treatment that can address broader issues in the patient's life that may indirectly play a role in the individual's ability to remain abstinent.

Beyond setting differences, psychotherapy for substance use disorder may be delivered in a range of different modalities, such as group or individual. Major advantages to group substance treatment are: (a) cost savings, (b) given the social stigma attached to having lost control of substance use, having group members who acknowledge similar problems can provide comfort, (c) group members who have longer periods of abstinence can model that attempting to stop using is not a futile effort, (d) group members can act as social supports, and (e) the public nature of the group can provide powerful incentive to avoid relapse. Principal advantages to individual substance treatment are: (a) privacy for members whose careers or reputations may be damaged from more widespread knowledge of their substance use, (b) increased flexibility to address problems that are uniquely relevant to that patient, (c) easier resolution of logistics surrounding therapist caseloads where often there are not enough substance abuse clients to form a group or deterrent from individuals having to wait to engage in treatment until the group is formed, and (d) therapists may use the one-to-one relationship to explore relational elements not possible in group treatment.

II. THEORETICAL BASES

The history of individual psychotherapy for substance abusers has been one of importation of methods first developed to treat other conditions. Thus, when psychoanalytic and psychodynamic therapies were the predominant modality for treating most mental disorders, published descriptions of dynamics of substance abuse or of therapeutic strategies arose from using this established general modality to treat the special population of individuals who abuse substances. Likewise, with the development of behavioral techniques, client-centered therapies, and cognitive-behavioral treatments, earlier descriptions based on other types of patients were followed by discussions of the special modifications needed to treat substance abuse.

Although always present as a treatment option, individual psychotherapy has not been the predominant treatment modality for substance abusers since the 1960s, when inpatient 12-step informed milieu therapy, group treatments, methadone maintenance, and therapeutic community approaches came to be the fixtures of substance abuse treatment programs. In fact, these newer modalities derived their popularity from the limitations of dynamically informed ambulatory individual psychotherapy when it was used as the sole treatment for substance abusers. Many reported problems with dynamic treatment. Some of the difficulties reported for this form of treatment were premature termination, reaction to anxiety-arousing interpretations with resumption of substance use, erratic attendance at sessions, difficulties posed by attending sessions while intoxicated, and failure to pay fees because money was spent on drugs and alcohol.

Most schools of therapy, with widely varying rationales and strategies, have been adapted for potential use to treat substance abuse. Rather than focus on specific techniques associated with the different approaches, this article focuses on two topics that can guide substance abuse therapy within a variety of different schools: (a) specialized knowledge needed to apply psychotherapy to treat substance abuse, and (b) common goals and strategies that must be addressed by psychotherapists.

A. Areas of Specialized Knowledge to Treat Substance Abuse

1. Understanding the Effects of Using

The principal areas of knowledge to be mastered by the beginning therapist are the pharmacology, use patterns, consequences, and course of addiction for the major types of abused substances. For therapy to be effective, it is useful not only to obtain the academic knowledge about frequently abused substances, but also to become familiar with street knowledge about drugs (e.g., slang names, favored routes of administration, prices, availability) and the clinical presentation of individuals when they are intoxicated or experiencing withdrawal from the different abused substances. This knowledge has many important uses in the course of individual therapy with individuals who abuse substances.

First, it fosters a therapeutic alliance by allowing the therapist to convey an understanding of the addicted person's problems and the world in which he or she lives. This is an especially important issue when the therapist is of a different background from the patient who abuses substances. In engaging the patient, it is

important to emphasize that the patient's primary presenting complaint is likely to be substance abuse, even if many other issues are also likely to be amenable to psychotherapeutic interventions. Hence, if the therapist is not comfortable and familiar with the nuances of problematic drug and alcohol use, it may be difficult to forge an initial working alliance. Moreover, by knowing the natural history of substance abuse and the course of drug and alcohol effects, the clinician can be guided in helping the patient anticipate problems that will arise in the course of initiating abstinence. For example, knowing the typical type and duration of withdrawal symptoms can help the individual recognize their transient nature and to develop a plan for successfully completing an ambulatory detoxification.

Second, knowledge of substance actions and withdrawal states is crucial for diagnosing comorbid psychopathology and for helping the person who is addicted to understand and manage dysphoric affects. Most abused substances such as opioids or cocaine are capable of producing constellations of symptoms that mimic psychiatric syndromes such as depression, mania, anxiety disorders, or paranoia. Many of these symptomatic states are completely substance induced and resolve spontaneously when substance abuse is stopped. It is frequently the therapist's job to determine whether or not presenting symptoms are part of an enduring, underlying psychiatric condition or a transient, substance-induced state. If the former, then simultaneous treatment of the psychiatric disorder is appropriate; if the latter, reassurance and encouragement to maintain abstinence are usually the better course. Over the last decade, co-occurrence of psychoactive substance use disorders with other psychiatric disorders have become much more widely recognized and are of common occurrence in most treatment facilities.

Third, learning about drug and alcohol effects is important for detecting when patients have relapsed or have come to sessions intoxicated. It is seldom useful to conduct psychotherapy sessions when the patient is intoxicated, and when this happens the session should be rescheduled for a time when the patient can participate while sober.

2. Understanding Treatment Philosophies

A second area of knowledge to be mastered by the psychotherapist is an overview of treatment philosophies and techniques for the other treatments and self-help groups that are available to patients who abuse substances. As noted earlier, the early experience of attempting individual psychotherapy as the sole treatment of the more severe types of substance abuse was

marked by failure of an early dropout. Hence, for many individuals who abuse substances, individual psychotherapy is best conceived of as a component in a multifaceted program of treatment to help them overcome a chronic, relapsing condition.

Another major function of knowing about the major alternative treatment modalities for substance abusers is to be alert to the possibility that different treatments may provide contradictory recommendations that may confuse the patient or foster the patient's attempts to sabotage treatment. Unlike a practitioner whose treatment is likely to be sufficient, the individual psychotherapist does not have the option of simply instructing the patient to curtail other treatments or self-help groups while the treatment is taking place. Rather, it is vital that the therapist attempt to adjust his or her own work to bring the psychotherapy in line with the other treatments. It is also important to note that many treatments with high levels of empirical support are not the treatments most widely used clinically.

B. Common Goals and Strategies for Substance Abuse Psychotherapy

This section reviews issues presented by persons who abuse substances that should be addressed, if not emphasized, by any type of individual or group psychotherapy that is likely to be effective. As noted in reviewing the difficulties encountered by early psychodynamic practitioners, the central modification that is required of psychotherapists is always to be aware that the patient being treated is a substance abuser. Hence, even when attempting to explore other issues in depth, the therapist should devote at least a small part of every session to monitoring the patient's most recent successes and failures at controlling or curtailing substance use and being willing to interrupt other work to address slips and relapses when and if they occur.

Implicit in the need to remain focused on the patient's substance use is the requirement that psychotherapy with these patients entails a more active therapist stance than does treatment of patients with other psychiatric disorders such as depression or anxiety disorders. This is related to the fact that the principal symptom of substance abuse, compulsive use, is at least initially gratifying, and it is the long-term consequences of substance use that induce pain and the desire to stop. In contrast, the principal symptoms of depression or anxiety disorders are inherently painful and alien. Because of this key difference, substance abuse psychotherapy typically requires both empathy and structured limit setting, whereas the need for limit

setting is less marked in psychotherapy with patients who are depressed or anxious.

Beyond these key elements, this section also elaborates on key tasks that are common to most approaches to psychotherapy for substance use: enhancing motivation to stop substance use, teaching coping skills, changing reinforcement contingencies, fostering management of painful affects, and improving interpersonal functioning. Although different schools of thought about therapeutic action and behavior change may vary in the degree to which emphasis is placed on these different tasks, some attention to these areas is likely to be involved in any successful treatment.

1. Enhancing Motivation to Stop Substance Use

Even at the time of treatment seeking, which usually occurs only after substance-related problems have become severe, patients usually can identify many ways in which they want or feel the need for drugs or alcohol and have difficulty developing a clear picture of what life without substances might be like. To be able to achieve and maintain abstinence or controlled use, individuals who abuse substances need a clear conception of their treatment goals. Several investigators have postulated stages in the development of ones' thinking about stopping use, beginning with precontemplation, moving through contemplation, and culminating with determination as the ideal cognitive set with which to get the most out of treatment.

Regardless of the treatment type, an early task for psychotherapists is to gauge the patient's level of motivation to stop substance use by exploring the treatment goals. In doing this, it is important to challenge overly quick or glib assertions that the patient's goal is to stop using substances altogether. One way to approach the patient's likely ambivalence about treatment goals is to attempt an exploration of the patient's perceived benefits from abused substances or perceived needs for them. To obtain a clear report of the patient's positive attitudes toward substance use, it may be necessary to elicit details of the patient's early involvement with drugs and alcohol. When the therapist has obtained a clear picture of the patient's perceived needs and desires for abused substances, it is important to counter these exploring advantages of a substance-free life.

As noted earlier although virtually all types of substance abuse psychotherapies address the issue of motivation and goal setting to some extent, motivational therapy or interviewing makes this the sole initial focus of treatment. Motivational approaches, which are usually quite brief, are based on principles of motivational

psychology and are designed to produce rapid, internally motivated change by seeking to maximize patients' motivational resources and commitment to abstinence.

2. Teaching Coping Skills

One enduring challenge of treating substance abuse is to help the patient avoid relapse after achieving an initial period of abstinence. A general tactic for avoiding relapse is to identify sets of circumstances that increase an individual's likelihood of resuming substance use and to help the patient anticipate and practice strategies (e.g., refusal skills, recognizing and avoiding cues for craving) for coping with these high-risk situations. Examples of approaches that emphasize the development of coping skills include cognitive-behavioral approaches such as relapse prevention, in which systematic effort is made to identify high-risk situations and master alternative behaviors and coping skills intended to help the patient avoid substance use when these situations arise.

3. Changing Reinforcement Contingencies

As substance abuse worsens, it can take precedence over concerns about work, family, friends, possessions, and health. As compulsive substance use becomes a part of every day, previously valued relationships or activities may be given up so that the rewards available in daily life are narrowed progressively to those derived from substance use. When substance use is brought to a halt, its absence may leave the patient with the need to fill the time that had been spent using drugs or alcohol and to find rewards that can substitute for those derived from use.

An example of an approach that actively changes reinforcement contingencies is the approach developed by Steve Higgins and colleagues that incorporates positive incentives for abstinence into a community reinforcement approach (CRA). This strategy has four organizing features that are grounded in principles of behavioral pharmacology: (a) substance use and abstinence must be swiftly and accurately detected, (b) abstinence is positively reinforced, (c) substance use results in loss of reinforcement, and (d) emphasis on the development of competing reinforcers to substance use.

4. Fostering Management of Painful Affects

Dysphoric affects are the most commonly cited precipitant for relapse, and many psychodynamic clinicians have suggested that failure of affect regulation is a central dynamic underlying the development of compulsive substance use. To foster the development of mastery over dysphoric affects, most psychotherapies include techniques for eliciting strong affects within a

protected therapeutic setting and then enhancing the patient's ability to identify, tolerate, and respond appropriately to them.

5. Improving Interpersonal Functioning and Enhancing Social Supports

A consistent finding in the literature on relapse to substance abuse is the protective influence of an adequate network of social supports. Gratifying friendships and intimate relationships provide a powerful source of rewards to replace those obtained by drug and alcohol use, and the threat of losing these relationships can furnish a strong incentive to maintain abstinence. Typical issues presented by individuals who abuse substances are: (a) loss of or damage to valued relationships occurring when using substances was the principal priority, (b) failure to have achieved satisfactory relationships even prior to having initiated substance abuse, and (c) inability to identify friends or intimates who are not, themselves, abusing substances. For some types of psychotherapy, working on relationship issues is the central focus of the work (e.g., interpersonal therapy, supportive-expressive treatment), whereas for others, this aspect is implied as a part of other therapeutic activities such as identifying risky and protective situations.

Again, although most approaches address these issues to some degree in the course of treatment, an approach that strongly emphasizes the development of social supports are traditional counseling approaches, 12-step facilitation, and other approaches that underline the importance of involvement in self-help groups. Self-help groups offer a fully developed social network of welcoming individuals who are understanding and, themselves, committed to leading a substance-free life. Moreover, in most urban and suburban settings, self-help meetings are held daily or several times weekly, and a sponsor system is available to provide the person in recovery with individual guidance and support on a 24-hour basis, if necessary. For psychotherapists working with substance abuse, encouraging the patient to become involved in a self-help group can provide a powerful source of social support that can protect the patient from relapse while the work of therapy progresses.

III. EMPIRICAL STUDIES

In general, the existing literature on behavioral treatment for substance dependence suggests the following:

1. To date, most studies suggest that psychotherapy is superior to control conditions as treatment for substance

abuse. This is consistent with the bulk of findings from psychotherapy efficacy research in areas other than substance use, which suggests that the effects of many psychotherapies are clinically and statistically significant and are superior to no treatment and placebo conditions.

2. No specific type of behavioral treatment has been shown consistently to be superior as a treatment for substance abuse or for other types of disorders as well. However, behavioral and cognitive-behavioral therapies may show particular promise.

3. The studies examining the differential impact of effectiveness of psychotherapy on those who abuse substances with and without coexistent psychopathology indicate with some consistency that those therapies shown to be generally effective were differentially more effective with patients who presented with high levels of general psychopathology or depression.

4. The effects of even comparatively brief psychotherapies appear to be durable among substance users as they are among other populations.

A. Specific Psychotherapy Approaches

In the following section we briefly describe some of the most promising behavioral therapies for substance use that have at least a minimal level of empirical support from randomized clinical trials. Although this is not exhaustive, many of these approaches are making their way into the field.

B. Contingency Management Approaches

Perhaps the most exciting findings pertaining to the effectiveness of behavioral treatments for cocaine dependence have been the recent reports by Higgins and colleagues discussed briefly earlier in the article. In this approach, urine specimens are required three times weekly to systematically detect all episodes of drug use. Abstinence, verified through drug-free urine screens, is reinforced through a voucher system in which patients receive points redeemable for items consistent with a drug-free lifestyle that are intended to help the patient develop alternate reinforcers to drug use (e.g., movie tickets, sporting goods). Patients never receive money directly. To encourage longer periods of consecutive abstinence, the value of the points earned by the patients increases with each successive clean urine specimen, and the value of the points is reset when the patient produces a drug-positive urine screen.

A series of well-controlled clinical trials demonstrated (a) high acceptance, retention, and rates of abstinence for patients receiving this approach relative to standard 12-step-oriented substance abuse counseling, (b) rates of abstinence do not decline substantially when less valuable incentives are substituted for the voucher system, (c) the value of the voucher system itself (as opposed to other program elements) in producing good outcomes by comparing the behavioral system with and without the vouchers, and (d) although the strong effects of this treatment decline somewhat after the contingencies are terminated, the voucher system has been demonstrated to have durable effects.

Moreover, the efficacy of a variety of contingency management procedures (i.e., including vouchers, direct payments, and free housing) has been replicated in other settings and samples, including cocaine-dependent individuals within methadone maintenance, homeless substance abusers, and freebase cocaine users. The use of contingency management procedures has also been effective in reducing substance use in individuals with schizophrenia and substance disorders in addition to individuals who may be homeless.

These findings are of great importance because contingency management procedures are potentially applicable to a wide range of target behaviors and problems including treatment retention and compliance with pharmacotherapy (i.e., including retroviral therapies for individuals with HIV). For example, in 1996, contingency management may be used effectively to reinforce desired treatment goals (e.g., looking for a job) in addition to abstinence.

However, despite the very compelling evidence of the effectiveness of these procedures in promoting retention in treatment and reducing cocaine use, these procedures are rarely implemented in clinical treatment programs. One major impediment to broader use is the expense associated with the voucher program; where average earnings for patients are about \$600.

Recently developed low-cost contingency management (CM) procedures may be a promising approach to bring these effective approaches into general clinical practice. For example, Nancy Petry and colleagues have demonstrated that a variable ratio schedule of reinforcement that provides access to large reinforcers, but at low probabilities, is effective in retaining participants in treatment and reducing substance use. Rather than earning vouchers, participants earn the chance to draw from a bowl and win prizes of varying magnitudes. In a study of 42 alcohol-dependent veterans randomly assigned standard treatment or standard treatment plus CM, 84% of CM participants were retained in treatment throughout

an 8-week period compared to 22% of standard treatment participants. By the end of the treatment period, 69% of those receiving CM had not experienced a lapse to alcohol use, but only 39% of those receiving standard treatment were abstinent. A controlled evaluation of this promising approach for the treatment of cocaine dependence is ongoing.

C. Cognitive Behavioral/Relapse Prevention Therapy

Another behavioral approach that has been shown to be effective is cognitive-behavioral treatment (CBT). This approach is based on social learning theories on the acquisition and maintenance of substance use disorders. Its goal is to foster abstinence through helping the patient master an individualized set of coping strategies as effective alternatives to substance use. Typical skills taught include: (a) fostering resolution to stop drug use through exploring positive and negative consequences of continued use, (b) functional analysis of substance use, that is, understanding substance use in relationship to its antecedents and consequences, (c) development of strategies for coping with craving, (d) identification of seemingly irrelevant decisions that could culminate in high-risk situations, (e) preparation for emergencies and coping with a relapse to substance use, and (f) identifying and confronting thoughts about substance use.

A number of randomized clinical trials over the last decade with several diverse cocaine-dependent populations have demonstrated: (a) compared with other commonly used psychotherapies for cocaine dependence, CBT appears to be particularly more effective with more severe cocaine users or those with comorbid disorders, (b) CBT is significantly more effective than less intensive approaches that have been evaluated as control conditions, and (c) CBT is as or more effective than manualized disease model approaches. Moreover, CBT appears to be a particularly durable approach, with patients continuing to reduce their cocaine use even after they leave treatment.

D. Motivational Approaches

For individuals with severe dependence who deny the seriousness of their involvement, a course of individual therapy in which the patient is guided to a clear recognition of the problem may be an essential first step toward more intensive approaches. Motivation enhancement treatment (MET) sets out to accomplish this in a brief therapy approach (i.e., 2–4 sessions). In-

cluded in these sessions are typically emphasis on personal responsibility for change with advice and change options, objective feedback of impairment, therapist empathy, and facilitation of patient self-efficacy.

MET has been used to treat a variety of substance disorders, including marijuana dependence. Although marijuana is the most commonly used illicit substance, treatment of marijuana abuse and dependence is a comparatively understudied area to date, in part because comparatively few individuals present for treatment with a primary complaint of marijuana abuse or dependence. Currently, no effective pharmacotherapies for marijuana dependence exist, and only a few controlled trials of psychosocial approaches have been completed. In 2000, Robert Stephens and associates compared a delayed treatment control, a 2-session motivational approach, and the more intensive (14-session) relapse prevention approach and found better outcomes for the two active treatments compared with the delayed-treatment control group, but no significant differences between the brief and the more intensive treatment.

E. Family Therapy

Early intervention with individuals who abuse alcohol has historically been approached in some settings by addressing past crisis caused by the alcohol abuse into one dramatic confrontation by family and friends. This therapeutic approach is designed to combat denial by having family and individual close to the person present the negative effects of the individual's use in attempts to move the individual to agree to get treatment.

Moving beyond initial confrontation, others have included family in ongoing aspects of treatment. Edward Kaufman has identified three basic phases of family involvement in treatment: (a) developing a system for establishing and maintaining a drug-free state, (b) establishing a workable method of family therapy, and (c) dealing with the family's readjustment after the cessation of drug abuse. Where these three stages may vary is based on the substances abused, stage of the addiction, family reactivity, and gender of the individual.

M. Duncan Stanton and William Shadish in 1997 conducted a meta-analysis across 1,571 cases reviewing drug abuse outcome studies that included family couples therapy. Family therapy was seen as more beneficial than individual counseling, peer group therapy, and family psychoeducation. In addition, family therapy had higher retention rates than non-family therapies and was seen as a cost-effective adjunct to methadone maintenance.

F. Manualized Disease Model Approaches

Until very recently, treatment approaches based on disease models were widely practiced in the United States, but virtually no well-controlled randomized clinical trials had been done evaluating their efficacy alone or in comparison with other approaches. Thus, another important finding emerging from recent randomized clinical trials that has great significance for the clinical community, is the effectiveness of manualized disease model approaches. One such approach is 12-step facilitation (TSF). It is a manual-guided, individual approach that is intended to be similar to widely used approaches that emphasize principles associated with disease models of addiction and has been adapted for use with cocaine-dependent individuals. Although this treatment has no official relationship with Alcoholics Anonymous (AA) or Cocaine Anonymous (CA), its content is intended to be consistent with the 12 steps of AA, with primary emphasis given to Steps 1 through 5 and the concepts of acceptance (e.g., to help the patient accept that they have the illness, or disease, of addiction) and surrender (e.g., to help the patient acknowledge that there is hope for sobriety through accepting the need for help from others and a “higher power”). In addition to abstinence from all psychoactive substances, a major goal of the treatment is to foster active participation in self-help groups. Patients are actively encouraged to attend AA or CA meetings, become involved in traditional fellowship activities, and maintain journals of their self-help group attendance and participation.

Within Project MATCH, TSF was found to be comparable to CBT and motivational enhancement therapy in reducing alcohol use among 1,726 individuals with alcohol dependence; the findings from these studies offer compelling support for the efficacy of manual-guided disease model approaches. However, it is critical to recognize that the evidence supporting disease model approaches has emerged from well-conducted clinical trials in which therapists were selected based on their expertise in this approach and were trained and closely supervised to foster high levels of adherence and competence in delivering these treatments, and it remains to be seen whether these approaches will be as effective when applied under less-than-ideal conditions.

G. Combined Treatment Approaches

1. Combining Psychotherapies

At times it can be useful to combine different psychotherapies to treat patients who have ongoing spe-

cialized needs such as in the case of co-occurring disorders or if they are at a point in their treatment where they can benefit from combined approaches that address specific areas of concern. An example of the latter would be individuals in the initial stages of treatment receiving MET in conjunction with relapse prevention to address early treatment issues of decreased motivation to stop using that often occurs initially due to the uncertainty of how life would be without substances.

An example of the former would be combined treatments for posttraumatic stress disorder (PTSD) and substance dependence. Many women receiving substance treatment also meet the criteria for current PTSD. This may often cause the individual to experience a greater severity in the course of their illness than those who have only one of these. Other examples of combined treatments for patients who have co-occurring diagnoses include relapse prevention and exposure therapy for individuals who also have obsessive-compulsive disorder and relapse prevention and motivational long-term approaches for individuals who also have psychotic disorders.

2. Combining Psychotherapy with Pharmacotherapies

At times psychotherapy may be combined with pharmacotherapies to enhance adherence to the pharmacotherapy or synergistically enhance the effects of both treatments. Even when medications have been proven to be effective, dropout from treatment and compliance have still been a problem. Moreover, there has been no study that has demonstrated that the addition of psychotherapy did not help the medication effect.

The most powerful and commonly used pharmacologic approaches to substance abuse are maintenance on an agonist that has an action similar to that of the abused substance (e.g., methadone for opioid addicts, nicotine gum for cigarette smokers), use of an antagonist that blocks the effect of the abused substance (e.g., naltrexone for opioid addicts), the use of an aversive agent that provides a powerful negative reinforcement if the substance is used (e.g., disulfiram for alcoholics) and use of agents that reduce the desire to use the abused substance (e.g. naltrexone and acamprosate for alcoholics). Although all of these agents are widely used, they are seldom used without the provision of adjunctive psychotherapy, because, for example, naltrexone maintenance alone for opioid dependence is plagued by high rates of premature dropout and disulfiram use without adjunctive psychotherapy has not been shown to be superior to placebo.

Several studies have evaluated the use of contingency management to reduce the use of illicit drugs in addicts who are maintained on methadone. In these studies, a reinforcer (reward) is provided to patients who demonstrate specified target behaviors such as providing drug-free urine specimens, accomplishing specific treatment goals, or attending treatment sessions. For example, methadone take-home privileges contingent on reduced drug use is an approach that capitalizes on an inexpensive reinforcer that is potentially available in all methadone maintenance programs. Maxine Stitzer and George Bigelow, in 1978 and 1986, did extensive work in evaluating methadone take-home privileges as a reward for decreased illicit drug use. In a series of well-controlled trials, this group of researchers has demonstrated (a) the relative benefits of positive (e.g. rewarding desired behaviors such as abstinence) compared with negative (e.g., punishing undesired behaviors such as continued drug use through discharges or dose reductions) contingencies, (b) the attractiveness of take-home privileges over other incentives available within methadone maintenance clinics, and (c) the relative effectiveness of rewarding drug-free urine screens compared with other target behaviors. More recently in 1998, Andrew Saxon and colleagues further demonstrated that take-home doses of methadone serve as a reinforcer for abstinence among methadone maintenance program participants by showing fewer restrictions on their availability make them even more effective.

In 1996 and 1998, Kenneth Silverman and colleagues, evaluated a voucher-based CM system to address concurrent illicit drug use, typically cocaine, among methadone-maintained opioid addicts. In this approach, urine specimens are required three times weekly to systematically detect all episodes of drug use. Abstinence, verified through drug-free urine screens, is reinforced through a voucher system in which patients receive points redeemable for items consistent with a drug-free lifestyle that are intended to help the patient develop alternate reinforcers to drug use (e.g., movie tickets, sporting goods). In a very elegant series of studies, the investigators have demonstrated the efficacy of this approach in reducing illicit opioid and cocaine use and producing a number of treatment benefits among this very difficult population.

IV. SUMMARY

Psychosocial treatments should be considered as a treatment option for all patients seeking treatment for

substance use disorders. The treatment itself can take place in a variety of settings including inpatient, residential, partial hospitalization, or outpatient treatment. In more controlled settings the frequency and duration of sessions increases.

Through our review of the literature, it becomes evident that individuals who abuse substances are a heterogeneous group reflecting much diversity. To address this diversity in treatment, it is useful to consider multidimensional outcomes. Consequently, no one form of treatment or psychotherapy is typically seen as universally effective across all substance disorders. However, one major strategy common to all currently practiced psychotherapies is to place primary emphasis on reducing substance use, while pursuing other goals only after substance use has been at least somewhat controlled.

The history of individual psychotherapy to treat substance abuse arose from using already established therapeutic strategies adapted for use to treat a special population of individuals who abuse substances. Most schools of therapy that have been adapted to address substance-related problems share common knowledge and common goals or strategies that must be addressed to provide successful treatment to substance-using populations.

The main areas of knowledge to be mastered by the beginning therapist are pharmacology, use patterns, consequences, and the course of addiction for the major types of abused substances. It is important to go beyond textbook knowledge to street knowledge of frequently abused drugs as well as understand the clinical presentation of intoxicated individuals or withdrawal from different substances to fully understand the clinical picture and to aid alliance.

Common goals and strategies related to substance abuse psychotherapeutic treatment include enhancing motivation to stop using, teaching coping skills, changing reinforcement contingencies, fostering management of painful affects, and improving interpersonal functioning and social supports. The therapist needs to take a more active stance than in the treatment of other disorders such as depression or anxiety disorders due to the principal symptom, compulsive use, being initially gratifying until the long-term consequences of use induce pain and desire to stop.

Our review of rigorously conducted efficacy research on psychotherapies for substance abuse provides support for the use of a number of innovative approaches: individual substance counseling, and cognitive behavioral treatment for cocaine dependence; community reinforcement treatment with contingency management for cocaine dependence; and contingency

management approaches combined with methadone maintenance in the treatment of opioid dependence as well as use with a wide range of other substance use disorders including alcohol dependence. Manualized disease model approaches have been as effective to other forms of psychotherapeutic substance abuse treatments. Substance psychotherapies have been combined with pharmacotherapies to enhance adherence to pharmacotherapies or synergistically enhance the effects of both treatments. Future studies are needed to evaluate the usefulness of combined psychotherapy approaches and further investigate less rigorously studied treatments.

See Also the Following Articles

Addictions in Special Populations: Treatment ■
 Adjunctive/Conjoint Therapies ■ Comorbidity ■
 Controlled Drinking ■ Gambling: Behavior and Cognitive
 Approaches ■ Matching Patients to Alcoholism Treatment
 ■ Psychopharmacology: Combined Treatment

Further Reading

- Carroll, K. M. (1998). Treating drug dependence: Recent advances and old truths. In W. R. Miller & N. Heather (Eds.), *Treating addictive behaviors* (2nd ed., pp. 217–229). New York: Plenum.
- DeRubeis, R. J., & Crits-Christoph, P. (1998). Empirically supported individual and group psychological treatments for adult mental disorders. *Journal of Consulting and Clinical Psychology, 66*, 37–52.
- McLellan, A. T., Arndt, I. O., Metzger, D. S., Woody, G. E., & O'Brien, C. P. (1993). The effects of psychosocial services in substance abuse treatment. *Journal of the American Medical Association, 269*, 1953–1959.
- McLellan, A. T., & McKay, J. R. (1998). The treatment of addiction: What can research offer practice? In S. Lamb, M. R. Greenlick, & D. McCarty (Eds.), *Bridging the gap between practice and research: Forging partnerships with community based drug and alcohol treatment* (pp. 147–185). Washington, DC: National Academy Press.
- Stanton, M. D., & Shadish, W. R. (1997). Outcome, attrition, and family-couples treatment for drug abuse: A meta-analysis and review of the controlled, comparative studies. *Psychology Bulletin, 122*, 170–191.

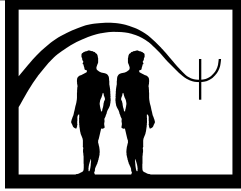

Successive Approximations

Patricia A. Wisocki

University of Massachusetts, Amherst

- I. Description of Use
- II. Theoretical Bases
- III. Empirical Studies
- IV. Summary
- Further Reading

GLOSSARY

operant conditioning The process of increasing or decreasing the frequency of a behavior by altering the consequences that follow the performance of that behavior.

reinforcement Consequences that increase the likelihood that a behavior will increase.

systematic desensitization A therapeutic technique for anxiety reduction in which anxious clients are relaxed and exposed to an incremental, graded series of anxiety-provoking elements that approximate the ultimate event feared by the clients.

Successive approximations are responses that gradually increase in resemblance to the final behavior that is being shaped as part of a therapeutic program to develop new behavior. Shaping is the process of reinforcing responses that successively approximate the final desired behavior. Responses are reinforced that either resemble the final behavior or that include components of the final behavior. As new approximations are reached successfully and reinforced, the earlier ones in the sequence are allowed to extinguish.

I. DESCRIPTION OF USE

Before using successive approximations, a shaping program must be established. The shaping program consists of the following sequence: (1) a determination of the goal behavior and the criteria for successful performance; (2) a determination of the elements that resemble the goal behavior in gradually increasing steps (successive approximations) and a decision about the size of the intervals between steps; (3) a determination of the reinforcers to be given contingently as the incremental behavior is produced; (4) the application of the program. The goal behavior may be anything that the organism is physically capable of producing. It should be clearly specified in ways that may be unambiguously measured. In determining the elements that approximate the goal behavior, it is important to find a beginning point that has some resemblance to the final behavior. The beginning point may be as elementary as raising a hand, turning a head in a particular direction, or making a mark on paper. Progressive sequences of responses leading to the goal behavior and the intervals between the responses must also be determined. These are the successive approximations. The intervals between responses must be small enough so that the organism is able to succeed more often than not, for reinforcement is not given for failed responses. The interval must not be so small, however, that the organism becomes bored or inattentive. The organism may be reinforced at the same step for a short period of time in

order to practice the response, but the demands for performance must be gradually increased sequentially so that the organism does not stop altogether at one step before reaching the goal.

II. THEORETICAL BASES

The procedure of response shaping by successive approximations was developed in the laboratories of Charles Ferster and B.F. Skinner in 1957, where pigeons were trained to peck at a response key. The birds were reinforced at first when their heads moved forward and ignored for all other behaviors. Once the forward movements occurred at a high rate, additional movements in the desired direction of the final goal of key pecking were reinforced. Reinforcements were withheld until the birds moved their heads in gradually increasing distances. Finally, the birds were reinforced for moving their heads in a position directly across from the response key. The pecking response could not fail to occur and the birds were reinforced only for pecking the key, the final desired behavior.

This technique is derived from the operant conditioning theoretical perspective, which holds that when rewarding consequences immediately follow the performance of a particular behavior, that behavior will increase in frequency. The principles of operant conditioning describe the relationship between behavior and environmental events, called antecedents and consequences, that influence behavior. This relationship is called a contingency. Antecedent events are those stimuli that occur before a behavior is exhibited, such as instructions, sounds, and gestures. Behaviors include actions made by an organism in response to the antecedent events. Consequences are those events that follow the performance of the behavior. For a consequence to affect behavior it must be contingent or dependent on the occurrence of that behavior.

In 1958 Joseph Wolpe reported on his work in the development of methods to reduce the laboratory-created experimental neurosis (anxiety) of cats. Wolpe gradually exposed the animals to a series of rooms that successively approximated the features of the room in which the anxiety had originally occurred. When the animals displayed a slight reduction in anxiety in the other rooms, Wolpe encouraged them to eat, reasoning that if the animals could engage in responses that competed with the anxiety response, the anxiety would be overcome. This systematically applied procedure was successful.

Using this information from the laboratory, Wolpe conceptualized the effects of the procedure from the viewpoint of classical conditioning in which environmental cues are said to elicit anxiety or fear responses. Anxiety may then be eliminated by conditioning an alternative response that is incompatible with it. For humans Wolpe used deep muscle relaxation as the competing response to anxiety. While relaxed, anxious clients were exposed to anxiety-producing stimuli, either in imagination or in real life. The stimuli were presented in gradually increasing intensity and resemblance to the original anxiety stimuli (i.e., successive approximations to the original event). As relaxation becomes associated with the anxiety events, the anxiety is reduced. Wolpe called this procedure "systematic desensitization."

III. EMPIRICAL STUDIES

Successive approximations is not a clinical technique per se, but a way of presenting material within a number of procedures. There has been no research on successive approximations independent of the clinical techniques in which it is embedded. The procedures of shaping and systematic desensitization have, however, been extensively reviewed and are presented elsewhere in this book.

IV. SUMMARY

Successive approximations are responses that gradually increase in resemblance to the final behavior that is being shaped as part of a therapeutic program. They are an element in the operant conditioning procedure of shaping and in the classical conditioning procedure of systematic desensitization.

See Also the Following Articles

Convert Reinforcer Sampling ■ Negative Reinforcement ■ Operant Conditioning ■ Positive Reinforcement ■ Progressive Relaxation ■ Reinforcer Sampling ■ Systematic Desensitization

Further Reading

Ferster, C., & Skinner, B. F. (1957). *Schedules of reinforcement*. New York: Appleton-Century-Crofts.
 Kazdin, A. (1989). *Behavior modification in applied settings*, 4th ed. Pacific Grove, CA: Brooks/Cole.
 Wolpe, J. (1958). *Psychotherapy by reciprocal inhibition*. Stanford, CA: Stanford University Press.

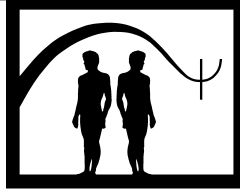

Sullivan's Interpersonal Psychotherapy

Maurice R. Green

New York University

- I. Introduction
- II. Theoretical Bases
- III. Therapeutic Range
- IV. Technique
- V. Summary
- Further Reading

self-system The envelope of all the security operations.

transference The distortion of present experience by past experience as reflected in the patient toward the therapist.

I. INTRODUCTION

GLOSSARY

counter-transference The personal reaction of the therapist to the patient including distortions that the therapeutic training helps him or her restrain.

field of awareness The content of the therapist's conscious attention to the interaction with the patient.

modifying the introject The therapist uses insight to modify by understanding the specific content he or she is experiencing directly from the patient.

object relations theory Within the traditional psychoanalytic framework W.R.D. Fairbairn introduced object relations to refer to the relations between the patient and a significant other person.

preverbalization Thoughts and feelings that give rise to specific language.

schizophrenia A term introduced by Bleuler to replace the term dementia praecox, referring to cognitive and emotional disturbances of a severe degree. Now a term designating a set of syndromes characterized by severe disturbances in thinking and reality perception.

security operations Verbal and nonverbal efforts of many kinds to prevent or ward off anxiety.

selective inattention Perceptions not attended to because they might arouse anxiety.

Harry Stack Sullivan's technique of psychotherapy was strongly influenced by his exquisite sensitivity to any sign of a patient's distress or discomfort in interaction with a therapist—himself or other. His theory of interpersonal psychiatry was the foundation for his practice of psychotherapy. He called his method of psychotherapy participant observation because the significant data included the psychiatrist's thoughts and feelings as well as those of the patient. Although Sullivan expressed an appreciation of Freud's work, it had little influence on his own thinking, which was firmly based on the philosophy of experience.

Sullivan was first and foremost an American psychiatrist, as Helen Swick Perry has brilliantly documented in her book *Psychiatrist of America*. However respectful and sensitive, he was firm, vigorous, and well-disciplined in his approach—contrary to the opinion of his critics who accused him of being too protective of his patients.

Sullivan had an extensive correspondence with Alfred Korzybski who, together with Kurt Lewin, organized their observations to a theoretical field in which many vectors of different force operated simultaneously with their counterparts in interpersonal transactions. Therefore, some part of a personality would

enhance parts of another personality while other parts might diminish or suppress aspects of the other person. This could be elaborated with topological diagrams to clarify the ideas.

II. THEORETICAL BASES

Early in his career, Sullivan published a paper in his journal *Psychiatry* authored by Albert Dunham describing the important work of the American philosopher Charles S. Pierce and comparing it to the European philosophers on the nature of human responses. Pierce's three categories of experience, firstness, secondness, and thirdness, are logically parallel to Sullivan's prototoxic, parataxic, and syntactic modes of experience.

The prototoxic mode of Sullivan is more or less equivalent to the Firstness of Pierce—that is, immediate, instant, forever, here and everywhere, with no differentiation before or after—"unione mystica." With differentiation and past, present, or future, here and there, we have the category of Secondness and the early part of the Parataxic mode, which includes myth, superstition, dreaming, and metaphor. Thirdness includes the logical, consensually validated, or scientific—which is the Syntactic mode of Sullivan.

Sullivan introduced the term interpersonal for the first time in psychiatry in order to emphasize that the treatment, the work that was being done, was something that was done between two people, the patient and the psychiatrist, and not something that was being done to the patient by the psychiatrist. This was also emphasized in his term participant observation, which refers to the psychiatrist and the patient working together on the patient's difficulties in living in order to clarify them and to help the patient develop insight and better ways of coping more effectively.

The purpose of psychiatric treatment is to enhance the development of the syntactic mode of experience, including the range of communication by word, gesture, and movement, between persons—interpersonal processes. In that way the problems of living that are contributing to the patient's distress and/or disablement can be clarified and addressed. Sullivan avoided the terms unconscious, preconscious, and conscious for their lack of precision and consistent meaning. He preferred to use the field of awareness, which ranged in content from unavailable to marginal to focal in its spectrum. This field spectrum can become wider or narrower with specific interactions, verbal or otherwise, blocked or opened up, as the interpersonal area

changes, including the illusory or projected personification of "good me," and "bad me," "not me," as well as those of "good other," "bad other," and "non-other." In this context the psychiatrist or other mental health expert must manifest a precise sensitivity to nuances of speech and subtlety of movement. In this way the psychiatrist could avoid provoking anxiety that interfered with communication while eliciting information that was associated or accompanied by some anxiety. This has been described by others in the literature as coping with the mechanisms of defense. It is described later by Anna Freud in her well-known work *The Ego and Mechanisms of Defense*. Although Sullivan advocated various measures to minimize anxiety he vigorously opposed fraudulent reassurance or falsehood in any form. In his work with the severely mentally ill, he would sometimes use alcohol or mild sedation to help open up channels of communication.

III. THERAPEUTIC RANGE

Sullivan used the term parataxic for the phenomenon of transference and counter-transference—that is, generalizations from past experience that may not be appropriate to the present encounter, and may contribute to distressing interactions with others. As a participant observer, the therapist may reinforce some projections and diminish others. The content of this field of interaction was called the social geography or social landscape by Leston Havens. Sullivan insisted on obtaining detailed and precise descriptions of feelings and context—in one instance having a patient describe the New York subway system.

Sullivan also liked to set some distance by referring to a third party. He said that it is much easier for patients to tell the therapist what is important and unimportant, even about the therapist, if they talk about a third party. Sullivan objected to the patient lying on a couch with the therapist sitting behind the patient. Sullivan preferred to sit alongside the patient at an angle, which is the way I practiced analysis for 25 years, as did Clara Thompson, my training analyst. Sullivan referred to the content of transferences carried by the patient as false expectations, projections, and misconceptions.

For example, Sullivan said:

If a patient says to me "You must think I'm terrible" and I don't feel that is just hysterical drama, but means something, I am apt to say, quite passively "about what?" as if I had not heard anything about such a

notion. Quite frequently, just because my reaction seemed so astonished and annoyed, they tell me, and to that extent I have gotten somewhere.

Thereby he reduces the transference.

Sullivan was more interested in therapeutic change than he was in cognitive insight. This could be seen as deconditioning or in object-relations theory as modifying the introject. In some ways Sullivan's method is analogous to play therapy, with the transference projected onto the narrative or the world "out there."

In addition to correcting the transferences in a profoundly collaborative way, he used what can be called counterprojective statements. These statements talk about the important figure in the patient's life, which draws attention and projection to them. Sullivan may then join the patient in expressing appropriate feelings toward these persons such as desperation and rage. Sullivan was remarkably and dramatically effective with paranoid patients. The first step was establishing empathy with the paranoid person's rage and expressing it. At the same time Sullivan would avoid a direct face-to-face confrontation but would sit alongside the patient, joining the patient in a collaborative effort to look at the world from the patient's side. Third, he would cite some experiences of his own at distressing institutional behavior. However, this must be authoritative and not susceptible to being experienced by the patient as patronizing or false.

Sullivan examined and treated a variety of patients, but his central focus was always on schizophrenia and, to a lesser degree, obsessive-compulsive disorder. He saw conversion hysteria as a substitutive disorder wherein physical symptoms substituted for achievement in promoting an enfeebled self-esteem, and preventing anxiety, that is, the type of anxiety caused by a threat to one's sense of being a worthwhile human being.

Sullivan described the three most basic requirements for the effective psychotherapy of persons with schizophrenia. First, the therapist must review with the patient a survey of his or her conflicted growth and adaptation as skillfully as possible. Second, the therapist must provide some type of healthy "corrective" experiences in the patient's living of his or her life. Lastly, there is collaboration of the patient with an enlightened physician skilled in penetrating self-deceptions with the goal of improving the patient's self-esteem and social competence.

In assessing Sullivan's remarkable success at Sheppard Pratt Hospital it is important to note the linkage to the type of onset: Out of 100 patients who had slow insidi-

ous onset only two went on to a full recovery. Of 78 who had an acute onset, 48 showed marked improvement with most others experiencing a full recovery, according to (Sullivan in 1962.) In the Sheppard Pratt program Sullivan did very little psychotherapy directly with the patients but worked through a staff that he carefully selected, personally trained, and closely supervised.

Sullivan became interested in the criminal mind, the psychopath or sociopath, that had no empathy for fellow human beings, and no concern for anyone's welfare except their own. He expressed an opinion that they were not quite human, and that they should be studied by a method of studying animal behavior. However, he never developed this idea any further.

IV. TECHNIQUE

In his own psychotherapy practice Sullivan preferred to work indirectly with as much collaborative style as could be achieved. By sitting alongside or at an angle to the patient the two together could look at the "social geography" of the patient's life, examining the important relationships therein. In Sullivan's language this would "loosen or attenuate" the parataxes, or in object-relations theory modify the introjects. A corollary of this would be the counterprojective statements that would move the transference (parataxes, distortions) back to the original figures from the patient's past. In doing so Sullivan might not only refer to the significant figure (parent, sibling, etc.) and point it out, but also supply the appropriate feeling of hurt, anger, or rage in a corrective emotional experience.

Sullivan's verbal psychotherapeutic interventions could be described in four categories: interrogative, imperative, rhetorical, and declarative. Although the interrogative direct questions are obviously necessary, the imperative is only subtly apparent in the fundamental rule of free association—the verbal expression of empathy is rhetorical as it communicates the imaginative projection of one's own consciousness into the consciousness of another person. Declarative statements usually are made to clarify or interpret, but Sullivan used them also to direct attention elsewhere, away from the patient and therapist to the social field of other people. This is similar to doing play therapy with children. Thus these counterprojective statements move attention away from the patient; they point to the critical figures, and express appropriate feelings by the therapist toward those critical figures, setting an example for the patient. These counterprojective statements are

especially useful in treating a paranoid patient or a psychotic transference. Again this is analogous to using play objects in treating children. Sullivan, in speaking of reconstructing the past, said, "What I would have seen if I had been there." The advantages gained are a clearer perspective on the past, differentiation of the structure (family, teacher, friend) internalized from the past, and best of all, freedom from the past.

In the beginning of this work, and in fact throughout the course of therapy or participant observation, the emphasis and direction were always on the concrete sharing of feelings and experiences in which the feelings and thoughts of the therapist were as important to share when appropriate as were the patient's. However, the therapist's only gratification from this experience was exercise of their competence and the pay that was received. He or she would not pursue friendship, gratitude, prestige, or anything else.

Sullivan never accepted general, vague, or speculative statements at face value. He would always try to pin down specifically and concretely what the patient was referring to, and that way the patient might become more aware of something that previously he or she had not paid attention to. Naturally, this required a very intense concentration on the part of the therapist, and a very disciplined approach to paying attention to what the patient meant by what was said. Therefore, theoretical hypotheses, structures, and jargon are completely avoided in accumulating very accurate and precise information. Therefore, Sullivan advocated questions that would be more productive than the interpretations. He also recommended attention to nonverbal communication of feelings such as a facial expression, tilting of the head, or a raising of the eyebrows that would communicate something to the patient that would be helpful in bringing out more useful data. In confronting delusional ideas that were communicated by the patient the therapist can show his or her puzzlement or questioning but should never flatly contradict or show a nonacceptance of this. The therapist should never pretend that he or she understands something when he or she does not. It is much better to say frankly that he or she does not understand and to ask for clarification or further explanation. In asking such questions the therapist might prefer indirect questions as they are less likely to be anxiety provoking, and they may yield more information than a direct question does. Indirect questions might also bring more attention to the interpersonal aspects of what was going on in the interaction between the two people referred to, rather than an attribute of somebody. Of course, at all times with either direct or indirect inquiry such questions for seeking more useful

information and helping the patient should not in any way undermine the patient's self-esteem.

Sullivan was also very active as a therapist. He was opposed to the more traditional psychoanalytic position of passively listening to whatever the patient brings out. Instead, the therapist pursues data, striving for more details and more precise information until the issue is very clear and the patient understands it, and can go on to the next thing. Sullivan not only tended to avoid interpretations but he even objected to the word interpretation, which has an authoritarian aspect to it. Instead of using the word interpret he would employ words like comment, inquire, point out, indicate, and so on. There is a difference of viewpoint. He also recommended when pointing out particular aspects or data to a patient that the therapist should not try to do too much all at once but rather pace oneself properly so the patient has time to assimilate it, and express his or her own reaction to it. The therapist thus allows the interaction between the two of them to be productive, rather than to cut it short by overloading the patient with too much information at one time.

The thrust of the patient's work with the therapist is to become more aware of what goes on between himself or herself and other people, particularly the ones who are most significant in their life. To the extent that he or she can formulate this in words and share it with another person, namely the therapist, he or she is able to be in better health, and to be more effective in dealing with his or her problems in living. Therefore the work of therapy very often consists of paying attention to many small details that help the patient become more aware and to be able to use this awareness more effectively.

Sullivan believed very strongly that there was an innate movement toward health in the person and this thrust toward mental health would be more active as the barriers to it were removed in the collaboration between the therapist and the patient. Therefore, the therapist was never seen as curing the patient or making the illness go away; the therapist was seen as helping the patient be healthier and more competent in handling the emotional and personal problems of their life.

Sullivan uses the term anxiety in a way that is different from its general use in medicine and everyday life. He uses it as a category of all kinds of emotional anguish such as fearfulness, tenseness, guilt, inferiority feelings, shame, self-loathing, eerie feelings of personality change, and all other forms of emotional distress. Anxiety can vary in degree from a scarcely noticeable fear to incapacitating panic. There has to be some anxiety in order to know that you are getting somewhere, doing something useful; therefore, it is important for the therapist to (as it were) keep the

finger on the pulse of anxiety to keep it manageable and constructive rather than interfering.

Sullivan was very skeptical about the value of direct reassurance. He saw that many schizoid and obsessional patients were able to respond to direct reassurance by having no response whatsoever and not allowing it to have any impact on them. Therefore indirect assurance was the only kind of assurance that would be effective. Sullivan was also very skeptical about the expression of admiration, gratitude, and affection from the patient. He did not believe that patients had enough feelings for themselves to be able to afford to appreciate him much. He believed patients may feel worthwhile only because this wonderful person is interested in them, but that is not very clinically useful and is not going to do them much good in their lives. It is much better that they discover how more effective and competent they are than they thought; and if that means disappointment in the therapist, that is beneficial. Being disappointed in themselves and feeling more inadequate is not of benefit, and indicates that their therapy is not going too well.

Sometimes the therapist can pick up anxiety that is blocking the patient by listening carefully to the pauses, missing data, and distortions in an account that the patient is giving them. The anxiety tends to block out an awareness of events, and things happening in the event, so by paying close attention, one may pick up on what is missing, and then find out what the anxiety was, and what it was all about. Rather than giving empty reassurance to the patient's anxiety, it is better for the therapist to specify the nature of the anxiety and the context in which it arose. For example, if the patient is feeling very angry with his parents it may make him feel guilty to point that out. It might be helpful for the person to be oriented to where he is emotionally because the anxiety interferes with the process. It may seem like stating the obvious, but when a person is in the midst of a breakup of a relationship, it may be useful to simply spell out the distress that the person is experiencing in the context of the breakup and how natural and normal it is to suffer such distress. Some people feel ashamed and embarrassed that they are a patient seeking help from a mental-health expert for their problems. This can be spelled out with the patient and put into its proper context. In doing such explorations with a patient, Sullivan was particular in adhering to objective data taking place in real time and a real place, and to not encourage the patient to go off into descriptions of fantasies. This is something he did not encourage and did not think was valuable. He believed it might even encourage unrealistic thinking; daydreaming might be present at times but it does not solve any problems.

Sullivan used the term security in a much broader sense to mean the opposite of anxiety: a sense of personal adequacy, or personal worth, personal value, or strong self-esteem and a complete lack of the negative feelings of worthlessness and other emotional distress. He saw the polar opposites of anxiety and security as being in a continual state of movement, trying to balance against each other like opposite ends of a see-saw. The ways of enhancing security and avoiding anxiety were called security operations by Sullivan and they could be either healthy or unhealthy. A healthy security operation increased a person's effectiveness and emotional health, and an unhealthy one could impair the interpersonal relationship. They are different from the Freudian notion of defense because the notions of defense occur in a hypothetical mind-structure and are not observable, whereas the security operations of Sullivan are behavioral.

Sullivan's whole system might be called a cognitive behavioral system. One of the unhealthy or sometimes healthy security operations is selective inattention. This occurs when individuals observe only a part of what is happening in their environment between them and authorities so that they pay attention to some things and avoid paying attention to others. This is analogous to Freud's concept of repression. Selective inattention is always an ongoing activity between two or more people whereas repression can be something between a person and himself in his mind. Sullivan was a fairly rigorous taskmaster in keeping the patient focused on the matter at hand, and not letting the patient go off into empty discussions of trivial subjects that were not particularly relevant to the basic problems for which help is being sought. Sullivan also discouraged pseudo-compliance wherein a patient becomes very eager to please and agrees with everything the therapist says without really confronting his or her issues. It is a way of dismissing the whole investigation with faint praise. Another way of avoiding confronting something that is painful or distressing is to get angry about something that is not to the point, and in the angry exchange the therapist may be put on the defensive unless he or she realizes what is happening.

The self-system is not exactly the same thing as the ego of psychoanalytic theories. The self-system that Sullivan refers to is what is characteristic of the individual and what defines that individual as a person that is known. Thereby the self-system protects patients against distress and enables them to live as comfortably as possible so that they can feel (that is, identify) who they are, and that they are worthwhile and recognized as such. The self-system is not something that exists as a thing in

time and space. The self-system is simply a verbal convenience, a phrase to refer to an envelope of protective movements and ethics that the patient makes to avoid distress. The therapist must therefore use his or her skill to enable the patient to feel more worthwhile, and safer, and with more self-esteem while exploring relationships and experiences that might provoke embarrassment, shame, or other kinds of distress.

Sullivan paid great attention to this aspect of giving a kind of reassurance that was not sentimental, false, or difficult for the patient to assimilate. He would indirectly always provide a way for patients to see themselves with greater dignity and self-respect. Nonetheless, as Sullivan rigorously pursued the details of the patients' experiences with the important other persons in their life, it would provoke some distress. Sullivan was very careful to note this distress and to try to be helpful with it. Sometimes he would suggest a healthier, more constructive, way of dealing with a problem situation that the patient had never considered. When the patient is presented with the novel approach it must be something reasonable and practicable for the patient to follow.

Behavior and feeling patterns that recurrently characterize interpersonal relations—the functional interplay of persons and personifications, personal signs, personal abstractions, and personal attributions—make up the distinctively human sort of being. Sullivan characterized the manifestations in the interpersonal relations of activities as integrating, disjunctive, or isolative. He sometimes referred to the zones of interaction in which behavior takes place in interpersonal relationships, such as the oral zone, genital zone, anal zone, muscular activity zone, and so on. But he rarely referred to these zones.

In the course of treating very seriously ill persons Sullivan noticed that they sometimes manifested what he called a malevolent transformation. This occurs when the therapist or another person has shown a greater manifestation of tenderness and expression of a caring closeness to the patient than the patient is able to bear in his own experience of himself. Therefore the patient manifests a sense, or a feeling of hatred and hostility, and may even attack the person who is being tender and loving to him.

Sullivan did pay some attention to dreams but he never referred to it as dream interpretation. He would pick out salient features of the dream and then present them to the patient to ask the patient what the patient thought of it. For example, there was a dream of a Dutch windmill that the patient had in which everything was rack and ruin and when the patient finished reporting the dream Sullivan picked out two details,

that the windmill was beautiful, active on the outside but utterly dead and decayed within, and the patient responded, "My God, my mother." Although this might be seen by others as interpretation it actually was presenting some details to the patient in such a way that the patient was able to use the dream, and use these details to get some insight into the relationship with his mother that he had not seen before. Sullivan not only showed a great respect for dreams and their content but he also showed much respect for the fantasies a patient might present. He objected strongly to the dismissal of these fantasies as mere wish-fulfilling fantasies. He insisted that they might actually provide some creative foresight and planning for the future.

The therapist needs to be aware of what he or she is communicating nonverbally to the patient as well as what the patient is communicating to him or her consciously or otherwise. Sullivan was against the idea of the therapist sitting behind the patient where he or she could not be seen, which reduces nonverbal communication to some extent, but of course it did not eliminate it. Sullivan was very much aware of the particular meanings that vary from one language or culture pattern to another. When therapists are not familiar with the language, or the cultural context of the patient, they may be misled by words or gestures from the patient. Because of Sullivan's experience with anthropology he was able to bring a much more sensitive cross-cultural awareness to his work.

In a case seminar with Dr. Kvarnes, an associate at Chestnut Lodge, Sullivan brought out the importance of looking at the apparent devotion and love of the patient's parents for him and seeing what there was in it that could be constructive for the patient. It could also be harmful in being overprotective. Sullivan was exquisitely sensitive not only to overprotective movements and gestures by significant people in the patient's life but also to overindulgence, which can be equally sabotaging of the patient's self-esteem.

A personified self is the whole fabric of how the patient presents himself and sees himself in relation to other people. He may mean that when important people around him are upset he retreats and withdraws. If they upset him, also, that may mean that he cannot stand stress very well. However, he might mean that he has much inner emotional calm and secure self-respect that will enable him to cope with stress in a very effective manner.

Another area that is useful to explore is what the patient imagines about his future. It is good to encourage the patient to speculate about what he will be doing 3 years or 5 years or 10 years from now. However, if this arouses undue feelings of despair and hopelessness, one

should not permit that to go on. In every case, in all categories of illness and types of patients, Sullivan was rigorously pursuing the precise and exact data of the patient's experience: What did occur, when did it occur, where did it occur, who was there, what did they say, what did they do, and so on. Sometimes the patient gets upset without the therapist knowing what the upset was triggered by, and what it is all about; one cannot let that pass. The therapist must investigate it and find out what has upset him, and what can be done about it.

Sullivan sometimes used what he called preverbalization when things were not going well with a patient; this is not the same thing as Freudian free association. Free association is usually employed as a method of therapy over a period of months or a year, whereas Sullivan used preverbalization as a tool for alleviating a block or a difficulty in communication. When there has been stagnation, he asked the patient to tell him everything that came to his mind about this particular aspect of his life. In the course of the interview in clarifying and straightening out misunderstandings, and the events and experiences of the patient's life, it was important for him to not only avoid any jargon himself but also to discourage the patient from using technical terms such as psychosis, complex, and so on. That way he could get down to the "nitty-gritty" and not be bogged down in terms of which neither person knew exactly the meaning.

Sullivan felt very strongly that the patient should get a summary of the important content of the interview or the course of treatment at some point. This could be done just before saying goodbye. The course of treatment could be summarized after each session. The therapist could give a summary of what was noteworthy in the session, and an anticipation of what will be looked for in the next meeting. In the course of such summaries the therapist may repeat the fact that he or she is a skilled person who has special training and knowledge; that the therapist is there to help clarify the problems that the patient has, and to help resolve them. This helps to keep the therapist/patient relationship on a professional level and reminds the patient of what he or she is about, and not to get lost in various distortions of what the therapist would like or fears or other anticipations that are not grounded.

Sometimes a patient who is grateful toward the therapist may experience a sexual urge to show his gratitude by submitting to a sexual experience, to giving the therapist sexual pleasure. In such cases the therapist needs to simply express an appreciation, and point to the fact that such an experience would be destructive to the therapeutic relationship. The professional nature of their relationship must be preserved so that work

can go on, and the patient can get the most benefit from the relationship.

Sullivan was very familiar with the phenomenon of loneliness and stressed the important and powerful role it could play, referring to it as a driving force.

Sullivan had considerable experience of loneliness in his childhood and adolescence. He emphasized very strongly the importance of intimacy, and the devastating character of its lack from infancy throughout development to early adult life. He called loneliness or the need for intimacy one of the major integrating tendencies of life. He carefully separated it from other needs such as the need for satisfaction of lust.

Sullivan was very interested in the subtle and sometimes minute consequences of personal statements made to a patient. For instance, when a nurse told him some information about a patient, he was careful not to invade the patient's privacy by frankly communicating this to him. Instead he would do it indirectly so that the patient did not feel that people were spying on him. He did not want to undermine the patient's sense of confidence in the nurse's interest and her communication with him. He expected that their privacy would be fully respected. For example, the patient might confide something to the nurse that Sullivan felt was important to investigate and so Sullivan might say to the patient that he did not know how the nurse got this idea but he was glad that she was interested enough to speak to him about it. He would then ask the patient what he thought about it and what it was all about. In that way he got into it without violating the confidentiality of the nurse/patient relationship and at the same time he was able to explore this important information.

V. SUMMARY

In conclusion, it must be emphasized that Sullivan avoided jargon, theoretical systems, and language pertaining to such. He was very compassionate and at the same time very vigorous in collecting significant data from the patient that would be useful and helpful to the patient in living his or her life. Sullivan said that growth is still possible for the fortunate ones: If they are fortunate the growth goes on and on, they observe, formulate, and validate more and more; at the same time foresight continues to expand so that they can foresee their career line, not as it inevitably will be, but in terms of expectation and probability, perhaps with provisions for disappointment. Sullivan viewed a human as an enduring pattern of human relationships and also as a whole person, unique and alone. To him

the structure of our human being and the core of our self-esteem is one with the continuity of specific kinds of relationships. The integrity of the self is one with the integrity of relating to others; reality of the self is one with the reality of the relationship, the "I am" of identity with the "you are" of identity—the enduring patterns of relatedness, with the whole person, alone in his uniqueness, related in his humanness.

See Also the Following Articles

Cognitive Behavior Therapy ■ Countertransference ■ History of Psychotherapy ■ Interpersonal Psychotherapy ■ Object Relations Psychotherapy ■ Rational Emotive Behavior Therapy ■ Schizophrenia and Other Psychotic Disorders ■ Transference

Further Reading

- Chapman, A. H. (1978). *Treatment technique of Harry Stack Sullivan*. R. G. Kvarnes & G. H. Parloff (Eds.). New York: Brunner/Mazel.
- Chryanowski, G. (1977). *Interpersonal approach to psychoanalysis. A contemporary view of Harry Stack Sullivan*. Halsted Press.
- Dillingham, J. C. *A Harry Stack Sullivan Case Seminar: Treatment of a young male schizophrenic*. S. Jacobson, R. G. Kvarnes, & I. M. Ryckoff (Eds.). New York: W. W. Norton & Co.
- Perry, H. Swick. (1982). *Psychiatrist of America*. Cambridge, MA: The Belknap Press of Harvard University Press.
- Sullivan, H. S. (1962). *Schizophrenia as a human process*, H. S. Perry (Ed.). New York: W. W. Norton.
- Sullivan, H. S. (1964). *The fusion of psychiatry and social science*. H. S. Perry (Ed.). New York: W. W. Norton.

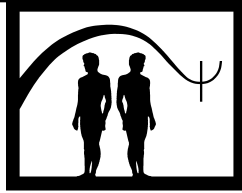

Supervision in Psychotherapy

Stephen B. Shanfield

University of Texas Health Science Center at San Antonio

- I. Conduct of Supervision
 - II. Termination
 - III. Evaluation
 - IV. Characteristics of Therapists
 - V. Learning to Be a Supervisor
 - VI. Outcome of Supervision
- Further Reading

GLOSSARY

evaluation Feedback in supervision allows the therapist to take distance from the therapy and is a form of ongoing evaluation.

parallel process The therapist re-creates the therapy in the supervision. This parallel process provides a guide to understanding the therapy.

supervision A relationship between a supervisor and a therapist to help the therapist more effectively engage in a purposeful relationship with a patient.

supervisor An individual experienced in psychotherapy and teaching.

therapist An individual engaging in helping patients with psychological problems.

ticeship to learn the craft of psychotherapy. A hermeneutic model provides an understanding of this process. The model holds that supervision is concerned with the meaning found in the supervisor–student interaction about patient-related issues. This is craft learning that as Alan R. Tom notes implies “an inexhaustible rule structure” because the “application of routinized skill sequences often fail to bring about desired results.” The skilled therapist has the ability to analyze situations and has a broad range of therapy strategies that are then applied to a specific situation. In supervision, the student provides data about what occurred, and new knowledge is constructed in the supervisory interaction. Issues cluster around problems, which are analyzed by supervisor and student who then revise strategies for dealing with them. Over time there is an increasing understanding of problems, and the focus is on new concerns. The supervisory interaction provides new ways of framing problems and strategies to deal with them. The supervision process allows for the resident to take distance from psychotherapy and provides a method of ongoing evaluation of the psychotherapy.

I. CONDUCT OF SUPERVISION

A basic task of the supervisor is to provide a trusting relationship in which the student therapist can openly discuss work with the patient. An accepting and non-judgmental attitude provides the context for the therapist

to share unique concerns raised by the patient in an atmosphere of safety. Indeed, the alliance with the supervisor is at the center of supervision experience. So valued is this relationship that many former trainees view supervision as one of the most important elements of training. The supervisor allows the therapist's story about the therapeutic encounter to develop. Indeed, the identification and the tracking of the therapist's central and affectively charged concerns about the patient are essential elements of supervision. Different terms describe the therapist's concerns: blind spots, conflicts, difficulties, dilemmas, impasses, issues, lack of mastery, lead or main themes, problems, troubles, worries, and from the educational literature, messes.

A focus on the therapist's immediate experiences and an orientation to the specifics of the material are also essential to supervision. Indeed, therapist's concerns should be dealt with in the context of the material. Inquiry should be kept within the parameters described by therapist staying close to the understanding of the moment. For example, recommendations for interventions should be linked to issues presented by the therapist. Seemingly general questions should be reframed to focus on specific issues raised in the session. Similarly, each session is taken on its own understanding. Themes from previous sessions should be acknowledged in the changing context of current material. This is disciplined behavior on the part of the supervisor.

An accurate view of the patient using data provided by the therapist has the effect of affirming the therapist's observational and reporting skills. Even what is not discussed is perceived as an affirmation that the therapist's conduct with the patient is adequate.

Early, the novice therapist has to learn how to handle the data of the psychotherapeutic interaction and to maximize the production of new information. They learn over time how to discern problems and be able to share them with the supervisor. The task of the supervisor is to facilitate such discussion. In addition, a language of discourse develops between teacher and student about the patient interaction. The student's language and conceptual framework best guide this development.

Technical comments and jargon terms are used sparingly and in the context of the therapist's data. In addition, theoretical discussions are generally infrequent. This is in keeping with an early report by Joan Fleming and Theresa Benedict of the supervision of psychoanalytic candidates who called these discussions "surplus learning." Although scientific data and theory enhance reflection, such discussion should be also tied to the specifics of the material presented by the therapist.

The downside of not being in touch with the student therapist's concerns and not exploring underlying issues as well as interfering with the development of the therapists' story is to leave the novice therapist without direction or insight into the care of the patient. This leads to the therapist feeling discounted, devalued, and resentful.

Different methods of presentation of material from therapy sessions yield different information and are suitable for different tasks. Videotapes as well as audiotapes of actual sessions minimize distortion of what goes on in the therapy session. Videotapes have particular value early on in the supervisory experience. Discussion of videotaped data can alert the student therapist to the complexities of the interaction and are useful in group supervision. Audiotapes and detailed notes of the therapy (called process notes because they are filtered through the therapist) are more commonly used in supervision. In part, the use of each is a matter of personal preference. Audiotapes require a review of the tape by the therapist before the supervisory session. This allows the therapist to be an active participant. A downside of audiotapes as well as videotapes is that they are inefficient. For instance, observation of supervision using audiotapes reveals that considerable time is spent listening to the tape with minimal interaction between supervisor and therapist. Here, both supervisor and therapist are observed looking at the tape recorder as if it were the patient. Some supervisors base their discussion on the therapist's free-flowing summary of the session. Although this method addresses the therapist's understanding of the therapy it may be more suited to supervision of experienced therapists who have learned the complexities of therapeutic interaction. Notes drawn from an actual session force the therapist to capture the interaction and focus on problems raised in the interaction.

A. Focus of Comments: Parallel Process

The therapist recreates his or her view of the therapy in the supervision. In this sense, the therapist's data parallels what goes on in the therapy. An awareness of this parallel process provides a guide for the supervisor to help the therapist understand the therapy and is at the heart of supervision. The various levels of feedback implicitly use the parallel process strategy.

In terms of frequency, comments made by supervisors are directed at four levels:

1. Understanding the patient
2. Relationship of patient to therapist

3. Relationship of the therapist to patient
4. Relationship of therapist to supervisor in the context of understanding the patient

1. Understanding the Patient

The bulk of supervisory comments are directed to helping the therapist further understand the patient's actions, thoughts, and feelings. This is done through reframing the therapist's understanding of the patient. Questions about the meaning of a patient's comments should have continuity with the material and be asked in an open-ended manner. This leads the therapist to develop a broader understanding of the patient and the interaction.

Special attention is necessary for highly charged clinical dilemmas. These often involve the therapist's concerns about safety for themselves or for patients who are self-destructive, suicidal, angry, or violent. Guidance about dealing with these situations helps defuse the therapist's sense of helplessness. However, supervision based solely on management of difficult patients is better suited for supervision of more structured clinical experiences such as patients who are seen in an emergency center.

2. Relationship of Patient to Therapist

The most frequent relationship comments are directed to helping the therapist understand the patient's view of therapy or that relationship to the therapist.

3. Relationship of Therapist to Patient

Less frequent, although highly valued by therapists, are comments directed to deepening the therapist's understanding of concerns about his or her role in the interaction. The supervisor can reframe the interaction to help the therapist understand the role in the interaction. The highest praise is for the supervisor who uses a strategy of helping the therapist understand responses to the patient. This is a strategy for deepening the therapist's understanding that is particularly useful when the therapist feels immobilized. This level of discussion catches deeper levels of vulnerabilities and encourages the therapist to be more appropriately direct and active. Moreover, such concerns are highly personal. They can take many years to fully professionalize and can remain active for a considerable period of time after training.

Supervisors of developing professionals often acknowledge therapist's concerns about the impact of personal life experiences on the care of their patient. These concerns can involve poignant and emotionally intense experiences. Some are coincident with similar experi-

ences in the patient's life. These include the impact on treatment of their own depression, transition to chief residency, impending marriage, divorce, pregnancy, and adoption of a child, or grief over the death of a loved one. Former therapists remain thankful for such discussions years after the supervisory experience and rate these supervisors as among the best of their training.

An adult developmental perspective is useful for understanding therapists' interest in discussing personal issues that affect their work. For therapists, the domain of work and caring for patients is at forefront of their lives. Usually, one other domain, perhaps two, are also operative in therapists' lives. The other domains include intimate relationships, family, religion, and community. Activity in these domains allows for the expression and gratification of deep values and needs. An important element in the professional developmental process involves integrating work with the other domains. This is a highly personal process that can involve considerable emotional conflict.

4. Relationship of Therapist to Supervisor

A discussion of the therapist-patient relationship in the context of the supervisory relationship can highlight issues in the therapy but has to be easily integrated with the therapist's data. This level of discussion is used infrequently but can be quite helpful in dealing with therapist's issues.

II. TERMINATION

Novice therapists worry about how well they are doing with their patients and how their patients will do after termination. Many worry that they have failed their patients and feel guilt over possible inappropriate termination plans. Some have unrealistic expectations of outcome and what can reasonably be accomplished. Discussion of expectations of outcome should be ongoing rather than just at termination. In addition, discussion of termination should focus both on clarification of the therapists' expectations of outcome as well as patient outcome.

III. EVALUATION

The feedback provided by the supervisor is a form of ongoing evaluation. This is called formative evaluation and is in contrast to the evaluation given at the end of a teaching period called summative evaluation. Here the

supervisor summarizes what has occurred over the course of the supervision and provides recommendations for ongoing learning.

IV. CHARACTERISTICS OF THERAPISTS

The novice therapist's lack of experience in the conduct of psychotherapy can result in considerable emotional intensities. Indeed, the intensity of concerns about competence is easy to underestimate. Such concerns involve a sense of inadequacy to the task, feeling at a loss of how to conduct oneself with patients, and that others can do better. These underlying concerns can be acknowledged but do not need to be a major focus of discussion. Rather, the value of a sympathetic supervisor who acknowledges personal concerns provides a framework for helping the therapist achieve a sense of mastery. Indeed, development into a mature therapist takes years after training. With time, the student develops a personal style.

The ability among therapists to discuss and deal with problems varies considerably and guides the supervisor in the level of discussion. Indeed, supervisors adapt to the pace of the therapist's learning and adjust their discussion to the level of the therapist. Indeed, once a supervisory relationship is established, because of the variation in therapist abilities, it is difficult to discern the year of training by the level of sophistication of the presentation or the discussion. The range of therapist abilities mitigates against stage theories of learning supervision. Such theories posit stages of development as a psychotherapist based on year of training. These theories do not emphasize the personal development of the therapist.

V. LEARNING TO BE A SUPERVISOR

Discussing supervisory dilemmas with experienced colleagues is useful. This can be done in an ongoing group and is helpful for supervisors at all levels of experience. This discussion can aid the supervisor in understanding whether the problem is specific to the interaction, or a general problem that the therapist has with other supervisors. For instance the therapist may not be able to be open about discussing concerns about

the patient. Such discussion can empower the supervisor to make appropriate interventions and also replicates the supervision process. Reading papers and texts on supervision is useful in orienting the supervisor to the conduct of supervision. However, they are often general and need to be applied to a specific situation.

Learning to be a supervisor is a matter of experience with a number of different therapists. Most supervisors initially model their behavior on their supervisory experiences during their training. They draw from these relationships until they develop a distinct supervisory style of their own. This also takes years to develop. Interestingly, supervisory behaviors become relatively stable even with different therapists.

VI. OUTCOME OF SUPERVISION

The intended outcome of the supervisory interaction is the transfer of new understanding to the patient encounter along with the transfer of patterns of interaction to other psychotherapeutic encounters.

See Also the Following Articles

Bioethics ■ Documentation ■ Economic and Policy Issues
 ■ Education: Curriculum for Psychotherapy ■
 Informed Consent ■ Legal Dimensions of Psychiatry
 ■ Working Alliance

Further Reading

- Fleming, Joan, & Benedek, Theresa. (1966). *Psychoanalytic supervision*. New York: Grune and Stratton.
- Packer, M. J. (1985). Hermeneutic inquiry in the study of human conduct. *American Psychologist*, 41, 1081–1093.
- Sergiovanni, Thomas J. (1985). Landscapes, mindscapes, and reflective practice in supervision. *Journal of Curriculum and Supervision*, 1, 5–17.
- Shanfield, Stephen B., Matthews, Kenneth, & Hetherly, Vron. (1993). What do excellent psychotherapy supervisors do? *American Journal of Psychiatry*, 150, 1081–1084.
- Shanfield, S. B., Hetherly, V., Matthews, K. L. (2001). Excellent supervision: The therapist's perspective. *Journal of Psychotherapy Practice and Research*, 10(1), 23–27.
- Tom, Alan R. (1980). Teaching as a moral craft: A metaphor for teaching and teacher evaluation. *Curriculum Inquiry*, 10, 317–323.
- Watkins, C. Edward (Ed.). (1997). *Handbook of supervision*. New York: John Wiley and Sons.

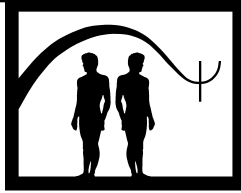

Supportive-Expressive Dynamic Psychotherapy

Lester Luborsky
University of Pennsylvania

- I. Description of Treatment
 - II. Theoretical Bases
 - III. Applications and Exclusions
 - IV. Empirical Studies
 - V. Case Illustrations
 - VI. Summary
- Further Reading

empirically validated treatments Treatments that are designated as effective because of their relative performance in comparative treatment studies.

meta-analysis A collection of data across many studies that is summarized quantitatively.

researcher's allegiance The belief of a researcher in a treatment's efficacy—the bond between researcher and treatment.

GLOSSARY

alliance The concept of the therapeutic alliance, which refers to the positive bond that develops between patient and therapist.

blinding The use of controls on human judgments where the judges are restricted from access to information that could contaminate them.

cognitive-behavioral therapy A well-known form of psychotherapy that is built on the concepts of belief systems and consequent dysfunctional attitudes.

core conflictual relationship theme (CCRT) A method of formulating the essence of the relationship pattern between patient and other people, including the therapist. It is derived from the repetitions of the themes across the narratives in the sessions.

correlation A statistic in which the level of association of one item with another is computed.

dynamic A well-known theory of psychotherapy based on Sigmund Freud. It involves an assessment of both conscious and unconscious aspects of behavior and the concept of conflicts among the patient's wishes and other behaviors.

empirical As used here, it refers to the inclusion of a reliance on quantitative methods for data analysis.

I. DESCRIPTION OF TREATMENT

Supportive-expressive (SE) dynamic psychotherapy is now a standard form of psychotherapy. It was developed in the early 1940s at the Menninger Foundation and it has continued to be practiced there and in many other places around the world. In 1984, I published a book on supportive-expressive dynamic psychotherapy explaining the principles, procedures, and empirical supports for doing that psychotherapy.

The attractions to therapists for practicing this form of psychotherapy are multiply based: (1) it is a dynamic psychotherapy, (2) it is adaptable in terms of treatment length and applicability to patients with a wide range of severity and wide spectrum of diagnoses, and (3) it has the convenient capacity to be able to mix supportiveness and expressiveness so that the more severely sick patients are treated by greater supportiveness and lesser expressiveness and vice versa for less severely ill patients.

My books describe the two main formats of SE: time open-ended and time-limited psychotherapy. In 1998, Howard Book dealt with time-limited treatment and gave

an unusual example: a verbatim complete case as treated by SE short-term psychotherapy. For most treatments the decision about the use of short-term versus open-ended treatment can be made even before the treatment starts, or sometimes in the early sessions. Most commonly, the time open-ended treatment is the preferred choice because with that the length of treatment tends to be a function of the patient's needs and wishes. When time-limited psychotherapy is the option chosen, it tends to be based on considerations of the limited time available, or considerations of the needs of a research protocol or of the preferred practice in a particular treatment setting.

A. How to Begin a Supportive-Expressive Psychotherapy

1. Treatment Arrangements

In the opening phase of psychotherapy, usually in the first session, treatment arrangements must explicitly be made. They include the frequency of sessions (usually one or two per week), the cost of each session, the method of payment, the handling of missed sessions, and a guide for the patient's style of speaking—the patient should speak about whatever is on the patient's mind, as well as the patient can.

2. Setting Goals

In the early phase of treatment, the setting of goals is essential. In the early sessions, and throughout the treatment, the patient should specify what it is that he or she wishes to change. That is a crucial first step because it can lead to achievement of the goals and to changes in the patient's goals. Both the patient and the therapist should be working toward the achievement of the same goals, and progress is gauged in terms of the achievement of these goals.

3. Development of the Therapeutic Alliance

The hope of both patient and therapist is that in the early sessions, and certainly as the treatment goes on, a relationship will be formed between patient and therapist of greater trust, rapport, and alliance. As examined by Safran, Muran, and Samstag in 1994 at times there is an oscillation between movement toward a rupture in the alliance that is usually followed by a movement toward reestablishing a positive relationship.

4. Focusing Interpretations around the Core Conflictual Relationship Theme

Starting early in the treatment, the therapist, and then the patient, will be able to understand and

respond more effectively to the patient's problems. The therapist, by following the Core Conflictual Relationship Theme (CCRT) method described in 1998 in Luborsky and Crits-Christoph, will be able to formulate the central relationship problem. It is this pattern that will help the therapist to focus interpretive responses on aspects of the central relationship pattern and it is this focus that helps the therapist to shape the treatment into a focal treatment. The word "focal" means that the treatment is based on the gradually greater understanding of the main relationship pattern, which continues throughout the treatment and thereafter. There are likely to be major changes in understanding and behavior in the course of the treatment, but mostly there is a broadening, deepening, working through, and a mastering of the central theme.

B. Supportive Procedures and Principles

According to the dynamic theory of psychotherapy, a supportive relationship is vital.

1. Sigmund Freud in 1913 advised that the therapist's basic attitude should be as a sympathetic listener. Most comparative studies of psychotherapies actually have similar amounts of supportiveness, as shown in 1983 in Luborsky, Crits-Christoph, Alexander, Margolis, and Cohen. The most necessary supportive component, of course, is that the therapist is there to be helpful and to help the patient achieve the patient's goals and that the patient recognizes this.

2. In most psychotherapies a rapport with the patient is developed, which, in turn, develops into a therapeutic alliance. The alliance tends to improve when progress has been made and is recognized; in turn, the alternative sequence can also be that when progress has been made the alliance tends to improve, as shown by Tony Tang and colleagues in 2000.

3. A variety of measures of the alliance have been developed. These measures include two main types: self-report measures (for example, for self-ratings of the helping alliance), and the observer-judged alliance measures as developed by Luborsky in 1976 and 2000.

4. Paradoxically, the joint search for understanding can be classified under supportiveness as well as under expressiveness, for it can be both—the giving of interpretations can be experienced by the patient as supportive and the giving of interpretations also provides the patient with understanding.

C. Expressive Procedures and Principles

The other broad category of technique besides supportiveness is expressiveness. Expressiveness refers to the state of the patient that permits the patient to express his or her thoughts and feelings as fully as possible. The therapist then uses what is expressed by the patient to frame interpretations of the main relationship themes that are drawn from aspects of the CCRT as described by Luborsky, a theme that is reevaluated by the therapist in each session. The patients then use the therapist's responses, as well as their own knowledge of themselves to advance in mastery of their relationship conflicts. This sequence is essentially what is done in dynamic psychotherapies and in psychoanalysis.

The therapist tries to help patients to be free enough to share thoughts about themselves and their main problems in several ways:

1. Within each session, the therapist often responds to the patient by offering facets of the CCRT. The therapist should not try to encompass the entire CCRT in each of the few interpretations given, but instead, presents the separate components from time to time, so that the patient has a chance to build up a concept of the broader pattern of the relationship themes.

2. In the course of each treatment, there will be times in the sessions in which the patient's alliance moves toward a near-rupture, as noted earlier. These alliance shifts tend to occur when the patient experiences the relationship with the therapist in terms of a major negative pattern in the patient's CCRT.

3. Some expressions of the components of the CCRT can be thought of as a test of the relationship with the therapist. It has been shown in Weiss and Sampson and their research group in 1986 by examination of patients' responses that it is helpful for the treatment that the therapist pass the test.

4. The movements toward mastery are an important aim in psychotherapy. In the course of the sessions, most patients will succeed in achieving improved mastery of the relationship conflicts as shown by Brin Grenyer in 1996.

D. Ending Treatment

Both in time open-ended and in time-limited treatment, as the treatment ending approaches, the patient and therapist remind each other of when the termina-

tion will take place, so that they will be prepared. If a reference to termination does not happen spontaneously from the patient's side, the therapist will often bring it up.

Treatment endings tend to correspond to the achievement of the patient's goals; patients tend to complete treatment when they have achieved at least some of their goals, and even in a time-limited treatment some of the goals tend to be achieved.

A common event toward the end of treatment is the resurgence or reemergence of the initial symptoms. This event typically implies that the patient experiences the anticipation of not seeing the therapist at a time when the patient does not recognize that he or she has enough of a reliable internalized image of the therapist and the treatment. Usually, even a brief review by the therapist of the meaning of such recurrence of initial symptoms tends to bring back the patient's level of control.

II. THEORETICAL BASES

My 1984 book on the principles of psychotherapy explained and exemplified the principles for doing supportive-expressive psychotherapy. These principles were mostly based on Sigmund Freud's 1912 and 1913 writings on dynamic psychotherapy and on SE adaptations of Freud by Robert Knight in 1945 and other collaborators, including Karl Menninger.

III. APPLICATIONS AND EXCLUSIONS

One of the attractions of SE psychotherapy is its broad applications in terms of degrees of severity and varieties of diagnoses. Even the most severely ill patients can be treated through modifications of the method in terms of increased supportiveness and decreased expressiveness of SE psychotherapy, whereas the reverse is feasible for less severely ill patients.

IV. EMPIRICAL STUDIES

There are about 50 studies dealing with the uses and the effectiveness of supportive-expressive psychotherapy. Some representative studies are given in the Further Reading section of this article and in the books by Luborsky.

These are two typical examples of empirical studies: (1) Supportive-expressive psychotherapy for depression has been frequently studied, as reviewed in the 1984 book, the SE patients performed well. One of these studies is a comparison of patients diagnosed with major depression versus with chronic depression; there were no significant differences in outcomes in these two groups; (2) in the National Institute for Drug Abuse study of cocaine addiction four treatments were compared: supportive-expressive psychotherapy, cognitive-behavioral psychotherapy, drug counseling, and group psychotherapy. The results were that the supportive-expressive and cognitive-behavioral groups were not significantly different in their outcomes, but the most effective of the four in this study was the drug counseling.

It is also worth noting that the comparisons of one form of psychotherapy with another form of psychotherapy tend to show nonsignificant differences between them. This was true for supportive-expressive psychotherapy as well as for other psychotherapies. To cite some examples: In 1983, Woody, Luborsky, McLellan, and colleagues found nonsignificant differences between supportive-expressive psychotherapy and cognitive-behavioral psychotherapy for opiate addicts. In the psychotherapy for cocaine abuse, supportive-expressive and cognitive-behavioral therapies were not significantly different in their outcomes and also were not as effective as drug counseling, as reported by Crits-Christoph, Siqueland, and colleagues in 1999.

A meta-analysis summarizing the results of comparisons of different psychotherapies, such as Paul Crits-Christoph's in 1992, showed nonsignificant differences were most common. In 1993 analysis by Lester Luborsky and Louis Diguier showed a similar nonsignificant tendency.

In conclusion, there is not a lot of reliable consistent evidence for the special advantages of any one psychotherapy over another. In fact, the major positive evidence from comparative treatment studies is marred by a major limitation, that is, treatment comparisons are not done blindly by the researchers and perhaps cannot even be done blindly. The probable effect of this is that the differences in researcher's allegiance to forms of psychotherapy correlates very highly with the differences in outcomes of the treatments—the correlation is .85, according to a study by Luborsky, Diguier, and Seligman in 1999! Until such findings have appeared, the research field has been involved in a highly enthusiastic search for what are called “empirically

validated treatments.” The outcomes of these treatment comparisons have, in fact, even become part of advertisements as the “winners” of these comparisons. Unfortunately, the facts are that the field has to recognize the ambiguity of comparative treatment results, as just stated.

In summary, in practice it has become clear that the “empirically validated treatment comparisons” are ambiguous in their implications. The combination of the ambiguity introduced by the researcher's allegiance effect, as well as of the older problem of nonsignificant differences among the treatments compared, means that the field has a distance to go in terms of generating a trustworthy set of comparisons of one form of psychotherapy with another.

V. CASE ILLUSTRATIONS

Howard Book in 1998 offered a vivid, complete, and highly instructive book including a case illustration of a supportive-expressive psychotherapy in a generally well-functioning patient who developed a very positive alliance with her therapist.

Another example explains in greater detail the operation of the CCRT. Mr. EH, age 18, was a college student with problems of guilt, anxiety, sporadic pain in his penis, difficulty in dealing with a new girlfriend, and resentment of his parents. As a youngster he had never felt close to his father but had felt very close to his mother. He often felt he could not experience closeness from others. The seriousness of his conflicts were difficult to evaluate. They seemed either a worsening of normal adolescent development with intense guilt over sex or there was a thought disorder involved with his wishing to be an exalted spiritual leader. The start of his treatment also showed that he had difficulties in being assertive and becoming separate from his family.

The relationship episodes in his session 3 contained six condensed examples. These six relationship episodes are followed here by a CCRT formulation in which the most frequent components are summarized: He wishes to be close, the other person rejects him, and he feels rejected, ashamed, and upset. What follows below are brief summaries of the six relationship episodes that he told during session 3 of his psychotherapy and the CCRT scoring of each one. This CCRT, as is usual, formed the basis for the interpretations given by the therapist:

CCRT Scoring	Precis of First Six Relationship Episodes
	<i>Mother #1</i>
W: To get info about sex (W1): To get closeness RO1: Rejection RS1: Feel rejected RS2: Shame RS3: Upset	This might have been a dream. Mother says it didn't happen. Up until we moved, when I had questions about sex, mother would explain to me. One day I asked and she said, "Sorry E. we can't talk about that anymore. You're getting to that age." Bothered me 'cause my young sister went into fits of laughter.
	<i>Mother #2</i>
W: Get in bed with parents (W1): To get closeness RO1: Rejection RS1: (Rejected)	Mother said this never happened: we, brother and I—before sister was born—when it was really cold, would sleep with parents. Parents took my brother in bed with them and they wouldn't take me.
	<i>Therapist #3</i>
W: To get rapport (W1): To get closeness RO1: Rejection RS1: Feel blank (empty)	T: What's happening now? P: I feel generally unresponsive. I'm getting a headache, tense, been thinking all week about relating all this stuff to what I was 10 years ago (sigh) and not getting any—I mean, nothing comes out ... like groups of guys who have embarrassing silences. It proves no perfect rapport exists. I feel blank.
	<i>Mother #4</i>
W: To kiss mother RO1: M. criticizes him RO1: Rejection, kissing stopped RS1: Rejected, out in the cold	Before I went to school I always used to kiss mother. I'm not sure it was a big thing, but it was a big thing when it stopped. She made a big thing about how I didn't want to kiss her anymore. I was suddenly out in the cold again.

(W1): Closeness to girlfriend RO: Doesn't like me RO1: Rejection, broke off RS2: Self-blame RS1: Rejected ("severed") RS3: Upset	<i>E (girlfriend) #5</i> I'm beginning to feel a lot of resentment to E (girlfriend). I went with her for a couple of years. It's just been severed. I'm fearful of seeing her and feeling something for her. She just doesn't give a damn. Bothered me I used to be so screwed up about her.
(W1): To get a response RO1: Rejection RS: Resentment RS1: Rejected	<i>Mother #6</i> One thing that started my resentment against my parents. I told her about E (girlfriend) that everything was cut off. I said E's not writing and it upsets me. She said, "Well, I'm sure about you and you aren't sure about her." That really cut me up because she ... she ... a ... assumes between us is like between E and me.
<i>N</i>	<i>Total CCRT Formulation</i>
6 Wish 1 6 Response from other 1 6 Response from self 1 2 Response from self 2 2 Response from self 3	W1: To be close RO1: Rejection RS1: Feel rejected RS2: Shame RS3: Upset, anxious

VI. SUMMARY

Supportive-expressive psychotherapy is a common form of dynamic psychotherapy. Its main principles are basically derived from Sigmund Freud's as these were shaped by clinicians at the Menninger Foundation, starting around 1940. In each session the therapist allows the patients to express themselves in their own way and to choose their own goals. A main technique for helping the patient is provided by the therapist who formulates the patient's main conflictual pattern of relationships in terms of the Core Conflictual Relationship Theme. It is the patient's main pattern of relationships, especially those that are conflictual; this pattern of relationships is derived from narratives about relationships that the patient tells during each session. The treatment is called

supportive-expressive because supportiveness and expressiveness are the two main techniques that the therapist uses. When the treatment conditions are more supportive, the therapist provides support when needed; when the help is more expressive, the therapist provides help with understanding by using what the patient expresses in interpretations. The length of the treatment is either time open-ended or time-limited. The treatment comes to a close when the main goals have been achieved and there has been sufficient occasion to work through the meanings of termination in order to optimize the retention of the gains.

See Also the Following Articles

Cognitive Behavior Therapy ■ Psychodynamic Couples Therapy ■ Psychodynamic Group Psychotherapy ■ Time-Limited Dynamic Psychotherapy

Further Reading

- Book, H. E. (1998). *How to practice brief psychodynamic psychotherapy: The core conflictual relationship theme method*. Washington, DC: American Psychological Association.
- Crits-Christoph, P. (1992). The efficacy of brief dynamic psychotherapy: A meta-analysis. *American Journal of Psychiatry*, *149*, 151–158.
- Crits-Christoph, P., Connolly, M., Azarian, R., Crits-Christoph, K., & Chappell, S. (1996). An open trial of supportive-expressive psychodynamic psychotherapy in the treatment of generalized anxiety disorder. *Psychotherapy*, *33*, 418–430.
- Crits-Christoph, P., Siqueland, L., Blaine, J., Frank, A., Luborsky, L., Onken, L. S., et al. (1999). Psychosocial treatments for cocaine dependence: Results of the National Institute on Drug Abuse Collaborative Cocaine Treatment Study. *Archives of General Psychiatry*, *56*, 493–502.
- Freud, S. (1912/1958a). The dynamics of the transference. In J. Strachey (Ed. and Trans.), *The standard edition of the complete psychological works of Sigmund Freud* (Vol. 12, pp. 99–108). London: Hogarth Press.
- Freud, S. (1912/1958b). Recommendations to physicians practicing psycho-analysis. In J. Strachey (Ed. and Trans.), *The standard edition of the complete psychological works of Sigmund Freud* (Vol. 12, pp. 111–120). London: Hogarth Press.
- Freud, S. (1913/1958). On beginning the treatment (Further recommendations on the technique of psycho-analysis). In J. Strachey (Ed. and Trans.), *The standard edition of the complete psychological works of Sigmund Freud* (Vol. 12, pp. 121–144). London: Hogarth Press.
- Grenyer, B. F. S., & Luborsky, L. (1996). Dynamic change in psychotherapy: Mastery of interpersonal conflicts. *Journal of Consulting and Clinical Psychology*, *64*, 411–416.
- Knight, R. P. (1945). The relationship of psychoanalysis to psychiatry. *American Journal of Psychiatry*, *6*, 777–782.
- Luborsky, L. (1977). Measuring a pervasive psychic structure in psychotherapy: The core conflictual relationship theme. In N. Freedman & S. Grand (Eds.), *Communicative structures and psychic structures* (pp. 367–395). New York: Plenum Press.
- Luborsky, L. (1984). *Principles of psychoanalytic psychotherapy: A manual for supportive-expressive (SE) treatment* (pp. 1–270). New York: Basic Books.
- Luborsky, L. (in press). Psychoanalytic therapies. In A. F. Kazdin (Ed.), *Encyclopedia of Psychology*. Washington DC: American Psychological Association; Oxford University Press, USA.
- Luborsky, L., & Crits-Christoph, P. (1998). *Understanding transference* (2nd ed.). Washington, DC: American Psychological Association.
- Luborsky, L., Diguier, L., Luborsky, E., & Schmidt, K. A. (1999). The efficacy of dynamic and other psychotherapies: Is it true that “everyone has won and all must have prizes?”—An update. In D. Janowsky (Ed.), *Psychotherapy in the 1990s—Indications and outcomes* (pp. 3–22). Washington DC: American Psychiatric Press.
- Luborsky, L., Diguier, L., Seligman, D. A., Rosenthal, R., Krause, E. D., Johnson, S., et al. (1999). The researcher's own therapy allegiances: A “wild card” in comparisons of treatment efficacy. *Clinical Psychology: Science and Practice*, *6*, 95–132.
- Luborsky, L., Rosenthal, R., Diguier, L., Andrusyna, T. P., Levine, J. T., Seligman, D. A., et al. (in press). The Dodo bird verdict is alive and well—Mostly! *Clinical Psychology: Science and Practice*.
- Safran, J. D., Muran, J. C., & Samstag, L. W. (1994). Resolving therapeutic alliance ruptures: A task analysis investigation. In A. O. Horvath & L. S. Greenberg (Eds.), *The working alliance: Theory, research, and practice* (pp. 225–255). New York: John Wiley & Sons.
- Weiss, J., Sampson, H., & the Mount Zion Psychotherapy Research Group. (1986). *The psychoanalytic process. Theory, clinical observations, and empirical research*. New York: Guilford.
- Woody, G., Luborsky, L., McLellan, A. T., O'Brien, C., Beck, A. T., Blaine, J., et al. (1983). Psychotherapy for opiate addicts: Does it help? *Archives of General Psychiatry*, *40*, 639–645.

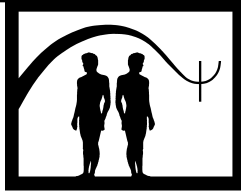

Symbolic Modeling

Michael A. Milan

Georgia State University

- I. Description
- II. Theoretical Basis
- III. Empirical Findings
- IV. Summary
- Further Reading

instruction manuals, and books. Silent reading, as well as imagining a model or one's self engaging in behavior, are considered covert forms of symbolic modeling.

GLOSSARY

- imitation** The behavior of an observer that is similar to that of a model and that occurs subsequent to the observation of modeling.
- model** The individual or character who is observed and demonstrates the behavior that is to be imitated.
- modeling** (1) The act of demonstrating the behavior that is to be imitated and (2) the general term describing the treatment procedure.
- observer** The individual who observes and imitates the behavior of the model.

Symbolic modeling is one of two general forms of modeling: live and symbolic. In live modeling, the model is actually present and models behavior "live." In symbolic modeling, the model is not actually present but instead is pre-recorded, drawn, or described. Symbolically modeled behavior is typically presented on videotape or film; in animated or still cartoons; and in narratives read aloud by another, listened to on audiotape, or read silently to one's self from printed handouts,

I. DESCRIPTION

In its most basic form, symbolic modeling is a process in which one individual sees, hears, or reads a depiction of the behavior of a real or fictional individual or character and then engages in behavior that is similar to the behavior that was observed. Although the initial research on modeling focused on overt motoric behavior, more recent research has also explored the effects of modeling on covert affective and cognitive behaviors. The results of that research confirmed that modeling is indeed an important contributor to the acquisition and modification of both overt and covert behaviors, and that the manner in which modeling produces its effects is generally the same for both overt and covert behavior.

Although symbolic modeling alone can have powerful effects, it is often a part of multicomponent programs designed to teach social skills, such as assertiveness, anger management, and self-control. It is also often a component of programs designed to treat anxiety disorders, such as social phobias, agoraphobia, and animal phobias. Symbolic modeling can serve five general functions: It can teach a new behavior or skill that is demonstrated by a model; it can reduce anxiety by depicting a model

engaging in a feared activity or making contact with a feared situation with no untoward consequences; it can encourage or disinhibit behavior by depicting positive consequences following modeled behavior; it can discourage or inhibit behavior by depicting negative consequences following behavior; and it can elicit or facilitate behavior by serving as a prompt to engage in the behavior at a particular time or place.

II. THEORETICAL BASIS

Since first recognized and studied by psychology, what is now typically referred to as modeling has been known by a variety of other terms, including observational learning, vicarious learning, identification, copying, matching-to-sample, and contagion. In their efforts to understand the modeling process, researchers have examined several theoretical issues raised by modeling and imitation, four of which will be discussed here. The first issue is whether the ability to imitate is innate or acquired. The general consensus among scientists in the field now is that the ability to imitate a broad range of behaviors modeled by a variety of both live and symbolic models is primarily an acquired skill.

The second issue involves the role of operant conditioning in modeling and imitation. Researchers have concluded that operant conditioning plays an important role in the acquisition and modification of overt, motoric behavior, as when a mother reinforces an infant when the infant produces a vocal sound similar to that the mother has made and as a result is more likely to imitate that and other vocalizations, or a child observes other children behaving aggressively and then does so as well.

The third issue involves the role of respondent conditioning. Again, researchers have concluded that respondent conditioning is primarily involved in the acquisition and modification of covert, emotional behavior, as when a child is terrified by a filmed depiction of a traumatic event happening in a dark room and as a result is fearful of dark rooms. Conversely, symbolic exposure to fear-producing stimuli can contribute to the deconditioning or extinction of anxiety responses in the treatment of anxiety disorders.

The fourth issue involves the adequacy of operant and respondent conditioning in the explanation of the full range of modeling and imitation phenomena. Cognitive theorists claim that conditioning theories ignore central processes. The cognitivists in general, and ad-

vocates of a social learning theory explanation in particular, postulate that a consideration of the action of a variety of intervening variables, such as anticipation, symbolic coding, and cognitive organization is necessary for an adequate understanding of the effects of modeling.

III. EMPIRICAL FINDINGS

Both live and symbolic modeling have long been accepted as an important contributor to the acquisition and modification of behavior. The major advantages of live modeling are that it typically allows more participatory learning and greater individualization of the content, pacing, and repetition of the modeled material to maximize its impact on the observer than does symbolic modeling. The major advantages of symbolic modeling are that it typically allows the modeling of behavior in situations that cannot be either practically or safely created live, it permits the widescale dissemination and cost-effective utilization of the modeling materials in a variety of settings, and it enables the assignment of homework or "self-study" modeling experiences as part of the course of treatment.

Several guidelines for the effective use of modeling have been identified. They address the characteristics of the observer, the characteristics of the model, and how modeling is conducted. The findings most relevant to the design of modeling programs will be noted here. The observer must have an adequate repertoire of imitation skills. If an assessment of the strengths and weaknesses of the observer indicates that the observer has not mastered the ability to imitate, imitative behavior must be taught.

The observer must attend to both the model and to the relevant aspects of the modeled behavior. Again, if assessment indicates that the observer does not have these skills, they must be taught; if the observer has these skills but does not use them, prompts must be provided and/or contingencies must be arranged to foster their utilization. Finally, the observer must imitate the modeled behavior. If the observer does not, impediments must be identified and eliminated and/or contingencies must be analyzed and altered to foster imitation.

To maximize the effects of modeling, the model should be similar to the observer and/or have high status or prestige for the observer. The modeled behavior should be expected to result in naturally occurring positive consequences for the model, such as the granting

of a request, rather than arranged consequences, such as the award of a token. Modeling should portray a naturally occurring positive outcome for the model as a result of the modeled behavior. Models should be portrayed as coping successfully with the problems or tasks confronting them rather than achieving complete mastery and/or exhibiting flawless performance. To the degree possible, a variety of models using a number of variations of the skills being taught should be shown dealing with a range of problems or tasks in an array of settings appropriate to the observer.

The difficulty or complexity of the modeled behavior should be matched to the characteristics and abilities of the observer. More difficult or complex behavior should be broken down into components or approximations and taught in sequence. Self-instructions should be taught in order to assist observers to guide themselves through expected performances and deal with impediments to successful outcomes if they arise. Observers should be taught to evaluate their behavior, identify the strengths and weaknesses of their performances, and then self-reinforce for the strengths and determine how the weaknesses may be remediated. The modeled behavior should be actively practiced by the observer after it is modeled, and the practice should include feedback, reinforcement, and correction. Finally, arranged prompts and reinforcement that have been used to foster acquisition and performance of the modeled behavior should be faded out during the course of training to maximize the likelihood that the behavior will occur and maintained under natural conditions.

IV. SUMMARY

Symbolic modeling consists of a recording, depiction, description, or imaginal portrayal of behavior. The person demonstrating the behavior is termed the model; the actions of the model are termed modeling; the person observing the model is termed the observer; and the subsequent behavior of the observer that is similar to the modeled behavior is termed imitation. Explanations of symbolic modeling and imitation rely on operant conditioning, respondent conditioning, and cognitive social learning processes. Modeling has been shown to be effective in the teaching of overt behavior, such as social skills and anger management,

and in the treatment of covert behaviors, such as fear and anxiety.

Successful modeling programs should include an assessment of the observers' strengths, weaknesses, and natural environment. The program should then be matched to observers' strengths, weaknesses, and the characteristics of their natural environment. Factors to be considered include the attributes of models, and the complexity and natural consequences of the modeled behavior. A variety of models, situations, and behaviors resulting in successful outcomes should be presented. Coping rather than mastery should be emphasized, and ample opportunities to practice and refine imitative performance should be provided. Prompts and reinforcement should be used as necessary to facilitate learning and performance and then faded out to foster success in the natural environment.

See Also the Following Articles

Behavior Rehearsal ■ Coverant Control ■ Heterosocial Skills Training ■ Modeling ■ Role-Playing ■ Self-Statement Modification

Further Reading

- Bandura, A. (1969). *Principles of behavior modification*. New York: Holt, Rinehart and Winston.
- Bandura, A. (1977). *Social learning theory*. Englewood Cliffs, NJ: Prentice-Hall.
- Bandura, A. (1986). *Social foundations of thought and action: A social cognitive theory*. Englewood Cliffs, NJ: Prentice-Hall.
- Martin, G., & Pear, J. (1999). *Behavior modification: What it is and how to do it*. Upper Saddle River, NJ: Prentice-Hall.
- Mineka, S., & Hamida, S. B. (1998). Observational and non-conscious learning. In W. O'Donohue (Ed.), *Learning and behavior therapy* (pp. 412–439). Boston: Allyn & Bacon.
- Mineka, S., & Zinbarg, R. (1996). Conditioning and ethological models of anxiety disorders. In D. Hope (Ed.), *Nebraska Symposium on Motivation, Vol. 43. Perspectives on anxiety, panic, and fear* (pp. 135–211). Lincoln: University of Nebraska Press.
- Mitchell, Z. P., & Milan, M. A. (1983). Imitation of high-interest comic strip models' appropriate classroom behavior: Acquisition and generalization. *Child & Family Behavior Therapy*, 5, 15–30.
- Spiegler, M. D., & Guevremont, D. C. (1998). *Contemporary behavior therapy*. Pacific Grove, CA: Brooks/Cole.

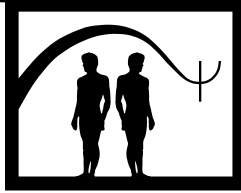

Systematic Desensitization

F. Dudley McGlynn

Auburn University

- I. Description of Treatment
 - II. Theoretical Bases
 - III. Applications and Exclusions
 - IV. Empirical Studies
 - V. Case Illustration
 - VI. Summary
- Further Reading

GLOSSARY

conditioned inhibition In the learning theory of Clark L. Hull the repetition of a learned response is accompanied by the buildup of a fatigue-like tendency to not respond called reactive inhibition. Stimuli present at the time of reactive inhibition become conditioned stimuli for inhibition or conditioned inhibitors.

counterconditioning An approach to learning associated with the theory of Edwin R. Guthrie; a relevant stimulus is maintained intact while a substitute response is practiced in its presence.

exposure technology Associated with Isaac Marks; refers to a therapeutic orientation according to which prolonged exposure to fear cues is the sole requirement for treatment success, and no interest is shown in how or why exposure produces beneficial outcomes.

extinction Associated with Ivan P. Pavlov's learning theory; denotes the repeated presentation of a conditioned stimulus in the absence of any unconditioned stimulus. Sometimes refers to the response decrement that follows from repeated presentations of a conditioned stimulus alone.

habituation The decrement in a response due to repeated, predictable presentations of a stimulus. Sometimes habituation is said to be limited to unconditioned responses. Usually habituation refers to decrements in the neural substrate of behavior.

hierarchy As used in behavior therapy; a listing of verbal scenarios that describes situations in which a fearful person gradually confronts fearsome objects and/or events.

progressive relaxation training An approach to learning how to relax developed by Edmund Jacobson. Different groups of muscles are repeatedly tensed and relaxed in sequential order "up" or "down" the body while the different feedback from tense versus relaxed muscles is contemplated and deeper relaxation is suggested.

reciprocal inhibition The physiologist C. S. Sherrington's term that denotes the inhibition of neuronal activity by the activation of other, reciprocally inhibiting, neuronal activity. As used by Joseph Wolpe reciprocal inhibition refers to the inhibition of sympathetic activation by parasympathetic dominance.

spatiotemporal hierarchy A hierarchy for systematic desensitization in which increasing the fearsomeness of successive scenarios is accomplished by reducing the times and/or distances separating the patient from the frightening encounter.

SUD scaling The patient is taught to assign numbers from 0 (calm) to 100 (terrified) that reflect the level of fear or subjective units of discomfort (SUDs) associated with targeted activities or objects.

thematic hierarchy A hierarchy for systematic desensitization in which increasing the fearsomeness of successive scenarios is accomplished by increasing the clarity or poignancy of focal themes such as "being watched," "being criticized," "suffocating," "being confined."

Systematic desensitization is a venerable behavior therapy technique developed by Joseph Wolpe for the treatment of fear- and anxiety-related disorders. Systematic desensitization includes three basic procedural elements. The patient is taught to relax his or her voluntary musculature using a procedure known as progressive relaxation training. Concurrently the patient and therapist develop detailed descriptions of realistic encounters with the objects and/or events that provoke fear or anxiety, and arrange those descriptions in order of fearsomeness. Finally the patient is guided to visualize the scene descriptions in increasingly fearsome order while taking care to maintain a relaxed muscular state. In addition, treatment based on systematic desensitization often entails encouragement to rehearse the targeted encounters in real life after they have been visualized calmly. Systematic desensitization helped launch the behavior therapy movement and was the first psychological treatment that produced behavioral improvement reliably.

I. DESCRIPTION OF TREATMENT

A. Relaxation Training

As noted above one basic procedure in the use of systematic desensitization is training the patient to relax the voluntary musculature. Usually the training is done according to the “progressive relaxation” techniques that were developed by Edmund Jacobson during the 1930s. Ideally relaxation training is done using a procedural guide and detailed transcripts such as those in the manual provided by Douglas A. Bernstein and Thomas D. Borkovec in 1973 and in the book provided by Marvin R. Goldfried and Gerald C. Davison in 1976. Ordinarily the available transcripts for relaxation training provide the following: (1) a subdivision of the skeletal musculature into a number of muscle groups, usually 16; (2) a set of instructions that will produce tension in each of the muscle groups; and (3) another set of instructions that focus attention on the different sensations that arise from tense versus relaxed muscles. In the widely used manual of Bernstein and Borkovec there are transcripts also that subdivide the muscles into eight and four separate groups.

The 1976 book by Goldfried and Davison contains valuable information about how to set the stage for relaxation training, including information about such things as the purpose of relaxation training and how being deeply relaxed will feel. After the stage is set ac-

ording to those or similar guidelines the therapist is ready to begin. The first step in relaxation proper is to demonstrate various exercises that will be used, exercises that create discernible tension in several groups of muscles. The second step is to encourage the patient to seek clarification about the exercises and, as needed, to repeat one or more of the demonstrations. In the third step the therapist reads the relaxation transcript with a few points in mind: (1) A training “trial” for a muscle group is a tension-relaxation cycle. After instructions for tensing a specific muscle group have been read, 10 seconds or so are allowed for maintaining the tension. At that time instructions for relaxing or “letting go” are read, after which another 20 seconds or so are allowed for relaxing and for attending to feedback differences from tense versus relaxed muscles. (2) Each muscle group is used for at least two consecutive trials. (3) The muscle tension should be easily discernible but not extreme. (4) The muscle groups will be relaxed in some progression (i.e., from the feet to the head-neck).

Some therapists provide patients with tape-recorded relaxation instructions and encourage them to practice relaxing at home. There is evidence that “live” relaxation is better than taped relaxation. Hence, taped relaxation is best viewed as an adjunctive procedure. If home practice of relaxation is important, then the patient should be instructed to record and submit regularly a diary of when, where, and how well he or she relaxed on each occasion.

B. Hierarchy Construction

Relaxation training usually takes from five to seven sessions. During this time the therapist and patient can construct what is known as a “desensitization hierarchy” provided that care is taken to construct the hierarchy when the patient is not relaxing. Behavioral assessment will have provided the information necessary to begin hierarchy construction. The information will include a complete and detailed listing of the various cue-stimuli for fear as well as a tentative arrangement of the fear stimuli according to groups. Each group of fears that has a common thread will ultimately be arranged into a single hierarchy or increasingly fearsome listing of targeted scenarios.

The most common types of desensitization hierarchies are spatiotemporal hierarchies and thematic hierarchies. In spatiotemporal hierarchies, increasing the fearsomeness of successive scenarios is accomplished by decreasing the times and/or distances that separate the patient from targeted encounters. For example, the

times and distances separating a socially phobic student from a dreaded classroom speech can be reduced systematically from days, to hours, to minutes. In thematic hierarchies, increasing the fearsomeness of successive scenarios is accomplished by increasing the clarity or poignancy with which the scenario captures the fearsome theme. Given the same socially phobic student, for example, the successive scenarios in a public-speaking hierarchy could entail increasing scrutiny and/or increasing likelihood of failure. Choosing between spatiotemporal and thematic hierarchies is not always straightforward, nor is grouping disparate fears to form thematic hierarchies. The most common approach to the problem of grouping is to use traditional phobia categories. Wolpe, for example, arranged 14 “different” fears into four hierarchies: acrophobia, agoraphobia, claustrophobia, and fears related to illness.

The most common procedure for constructing desensitization hierarchies was developed by Wolpe and is called SUDs scaling. In this procedure, the patient is first taught to assign a numerical value of 0 subjective units of discomfort (SUDs) to reflect absolute calmness, and to assign a numerical value of 100 SUDs to reflect the most extreme fear imaginable. Each potentially useful scenario in a given hierarchy is then assigned a SUDs rating and the scenarios are ordered in terms of increasing fearsomeness. Then scenarios are dropped and new ones added until the first scenario (hierarchy item) is rated near 0 SUDs, and the zenithal scenario is rated near 100 SUDs. As is described later, each hierarchy of fearsome scenarios provides for systematic “exposure in imagination” to attenuated, then intermediate, than maximally fearsome forms of the cue stimuli for fear. Each successive scenario should be more fearsome than the last but the difference should not be over 10 SUDs at any point in the hierarchy and should be quite small toward the upper end of the hierarchy. The scenarios incorporated into the hierarchy should sample comprehensively the objects, events, situations, or themes that cue fear responses. Each scenario should be relatively complete and, where possible, relatively concrete. Initial hierarchies can be modified as desensitization proceeds and response to treatment can be monitored.

C. Systematic Desensitization

Systematic desensitization proper typically is performed in one of two ways. In the “orthodox” procedure the patient is first exposed to abbreviated relaxation training. (Abbreviated relaxation training is

accomplished, after thorough training, by using fewer than 16 muscle groups, for example 8 or 4 groups as described by Bernstein and Borkovec.) Next the therapist instructs the patient to visualize for 10 to 15 seconds the least aversive hierarchy scenario and to signal by elevating an index finger if the visualization is accompanied by discomfort or fear. If the patient does not signal the presence of fear, then he or she is instructed to relax and, later, to visualize the scenario again. If the visualization occasions no fear on this second trial, then a 30 to 60 second period for relaxing follows and the next scenario on the hierarchy is presented for visualization. This process is repeated again and again as progressively more fearsome scenarios are visualized. Should the patient signal that fear is present, he or she is instructed to stop visualizing and relax. After time for relaxation the scenario is visualized again. If the fear signal recurs, then the therapist repeats the previously desensitized scenario and, after relaxation, repeats the troublesome scene. If the patient still signals the presence of fear, then the therapist and patient construct, on the spot, a new scenario that stands between the troublesome scenario and the last one that was successfully negotiated. Orthodox imaginal desensitization is complete when the most fearsome scenarios are visualized without fear signals.

Joseph Wolpe introduced the “improved” procedure for systematic desensitization in 1973. Here again treatment begins with abbreviated relaxation practice. Then the patient is instructed to visualize the appropriate scenario and to signal, by raising an index finger, when the imagery is clear. The therapist allows 10 to 15 seconds after a signal for the patient to continue visualizing fearsome material, then instructs the patient to drop the images and report orally a SUDs rating of the fear experienced during visualization. In this procedure visualization of each fearsome scenario is repeated until the patient reports 0 SUDs. “Improved” desensitization in imagination is complete when the patient visualizes the zenithal scenario(s) and reports that no fear was experienced.

Beyond the basic techniques discussed earlier there are a number of important considerations at the level of procedure. Discussions of specific procedures are available in Wolpe’s various books and in the book by Goldfried and Davison. The following subset of those recommendations shows the flexibility of the approach.

1. The therapist should view any hierarchy as tentative and should be prepared to add, modify, or delete exact scenario descriptions as needed.

2. Multiple hierarchies should be dealt with simultaneously; no more than three or four scenarios in any given hierarchy should be dealt with during a given session.

3. Desensitization proper should last 20 to 30 minutes per session; sessions should occur at daily to weekly intervals.

4. Once a particularly troublesome scenario has been visualized calmly, it should be visualized repeatedly before the next one is attempted.

5. Throughout desensitization the patient should be reminded to include himself or herself as a participant in the scenarios. He or she is not merely visualizing fearsome situations, but is visualizing himself or herself behaving within the fearsome scenarios.

6. The patient should be encouraged to participate in the targeted real life scenarios after they have been imaginably desensitized; such participation should lag somewhat behind progress in imaginal desensitization.

II. THEORETICAL BASES

There are a dozen or so theories that explain how or why systematic desensitization brings about fear reduction. Many of them are only partial theories, nearly all are *post hoc* in nature. Theorizing about the causal efficacy of desensitization represents in microcosm many of the ills that have plagued general and clinical psychology for the past half century.

A. The Legacy of Learning Theory

The psychology of learning during the 1930s and 1940s incorporated several competing theoretical systems (e.g., the systems of Edwin R. Guthrie, Clark L. Hull, and Edward C. Tolman). There was not much disagreement about experimental data. The major facts of acquisition, extinction, generalization, discrimination, and the like were, for the most part, consensually endorsed. Nonetheless there was spirited argument at the seemingly basic levels of “what” was being learned, “what” was being unlearned, and so forth. Hull spoke of “habits.” Tolman spoke of “expectancies.” Guthrie spoke of S-R bonds.

Joseph Wolpe chose to articulate his explanation of desensitization effects using the language of Hull (see below). When he did so he invited rejoinders in the languages of Guthrie and Tolman. Once Joseph Wolpe’s ideas gained some notoriety, these rejoinders did not take long to appear. Guthrie’s language was used in the

assertion that systematic desensitization embodies “counterconditioning.” Tolman’s language was used in the argument that desensitization works, in part, by engendering optimistic “expectancies.”

B. The Psychotherapy Environment

The field of psychotherapy during the 1950s and 1960s also incorporated competing theoretical systems. Arnold Lazarus, for example, listed 36 psychotherapy systems in evidence as of 1967, adding that his list was incomplete. There was not much disagreement at the level of data in the psychotherapy field either. With the noteworthy exception of Carl Rogers and his followers, data did not play an important role in system development. From such a variegated and uncritical psychotherapy environment, it was inevitable that some would seize on opportunities to explain Joseph Wolpe’s impressive results by recourse to their own preferred explanatory constructs. Thus, the beneficial effects of desensitization were said to depend on “the therapeutic alliance,” on fortuitous psychodynamic accompaniments of desensitization treatment, and the like.

C. Empirical Problems

During the late 1960s and early 1970s scores of articles appeared that were intended to provide experimental answers to the theoretical questions made outstanding by the legacies of learning theory and the environment of psychotherapy. For one example, the outcomes of experiments on systematic desensitization with and without muscular relaxation were styled as evaluating “counterconditioning” versus “extinction” as explanatory vehicles. Unfortunately, the substantive yield from the many papers was confusing and contradictory; theorists remained free to “pick and choose” experimental support for the various explanations afforded by learning and psychotherapy theories.

D. Theories of Fear Reduction from Systematic Desensitization

By and large theories of the active mechanism(s) of systematic desensitization have not been theories at all. Rather, they have been uniformly *post hoc* (and often vacuous) claims that desensitization effects represent something else such as extinction, habituation, counterconditioning, deconditioning, and the like. Furthermore, these and similar concepts have been used

uncritically, even interchangeably, as if the early behavior therapist acquired the lexicon of animal learning but little else.

1. Reciprocal Inhibition and Habituation

According to the reciprocal inhibition theory, systematic desensitization reduces anxiety by causing the cues for the anxiety to become cues for anxiety inhibition. Anxiety is composed of conditioned sympathetic responses. The occurrence of sympathetic responsivity during aversive imaging can be reciprocally inhibited by the parasympathetic underpinnings of concurrent muscular relaxation, provided that the imaging is graduated in fearsomeness. When reciprocal inhibition of the sympathetic response occurs during aversive imaging, the act of imaging acquires an anxiety-inhibiting function. This happens via a mechanism known as conditioned inhibition. Hence systematic desensitization reduces anxiety via conditioned inhibition based on reciprocal inhibition.

According to the habituation theory, systematic desensitization reduces anxiety due to habituation of sympathetic responses to clinically targeted stimuli. Sympathetic responsivity during aversive imaging is made to habituate over repeated imaging trials in much the same way that an orienting reflex habituates over the course of exposure to repeated novel stimuli. Theoretical accounts of habituation differ in minor ways and these differences appear in different renditions of how habituation is produced by systematic desensitization. Muscular relaxation plays a significant role by hastening or facilitating the rate of sympathetic response habituation.

2. Counterconditioning and Extinction

According to a theory based on counterconditioning, systematic desensitization reduces anxiety by causing the cues for anxiety-related behaviors to become cues for other behaviors. The display of emotional behaviors during conditioned aversive stimulation is prevented by rehearsing competing behaviors. (Relaxation is customary but any nonanxious behavior would suffice in principle.) In due course the conditioned aversive stimuli call forth the competing behaviors instead of the anxiety-related behaviors. Muscular relaxation plays a role by providing the substitute behaviors.

Throughout much of the early behavior therapy literature, clinically focal fears were regarded as conditioned emotional (Pavlovian) respondents. Accordingly, systematic desensitization was said to work by promoting respondent extinction. The role of muscu-

lar relaxation, in tandem with graduated exposures, was that of arranging for presentations of fear signals to be unreinforced.

3. A Variant of Exposure Technology

Beginning with Isaac Marks in the mid 1970s, most contemporary writers describe systematic desensitization as a variant of exposure technology. On the surface that characterization is not unreasonable because imaginal exposure is a prominent aspect of the procedure, and *in vivo* exposure is recommended adjunctively. However, characterizing systematic desensitization as a variety of exposure flies in the face of well-known history and does nothing to explain how systematic desensitization works.

4. Cognitive and Social Reinforcement Theories

Albert Bandura and Wallace Wilkins have both offered theories that explain the beneficial effects of systematic desensitization. Initially during the 1970s Albert Bandura developed his broadly applicable idea that “a sense of self-efficacy” is fundamental to success in psychological therapy. Relatively high self-efficacy influences successful outcomes by promoting persistent and vigorous self-change efforts. According to Albert Bandura systematic desensitization operates by increasing self-efficacy; the stronger self-efficacy promotes continued self-change efforts, and so forth.

In 1971 Wilkins offered a fairly elaborate theory explaining the beneficial effects of systematic desensitization. Among Wilkins’ assertions are that systematic desensitization works because the therapist fosters an expectation of therapeutic success; because feedback during treatment affords information that the patient is improving; and because systematic desensitization teaches one how to control the onset and offset of fearsome imagery.

5. Other Theoretical Approaches

The notions that systematic desensitization effects arise from the therapeutic alliance and from fortuitous psychodynamic processes were alluded to earlier. Others have argued that systematic desensitization effects might rest on covert modeling of fearless behavior, or on social reinforcement of motoric approach responses, or on reinterpretations of the meanings of fearsome images. There is also the plausible notion, based on the contemporary work of Peter J. Lang, that systematic desensitization works by modifying the bioinformational import of fearsome imaging.

III. APPLICATIONS AND EXCLUSIONS

Over the past three decades creative clinicians have found numerous applications for relaxation-based fear treatments such as systematic desensitization and its variants. The most common applications have involved various specific phobias and social phobia. But applications to other anxiety-related disorders are not rare. Among the specific phobias with which systematic desensitization has been used are those related to death, injury, disaster, illness, water, storms, animals, birds, reptiles, airplanes, automobiles, injections, ambulances, sanitary napkins, and childbirth. Applications related to social phobia have included "social situations," heterosexual interactions, and authority figures. Among the other anxiety-related disorders treated heretofore with systematic desensitization are asthma, recurring nightmares, repetitive cleansing, chronic diarrhea, and urinary urgency.

For the past two decades clinicians have been opting for *in vivo* treatments that, in the aggregate, are called exposure technology. Hence, the first choice point in deciding to use systematic desensitization for any phobia or anxiety-related disorder is to establish that *in vivo* techniques are not feasible.

After a decision is made to consider using systematic desensitization there must be a relatively thorough assessment of the controlling stimuli for fear and the details of fearful responsivity. (Assessment of the sort used for diagnosis and for exposure treatment is rarely adequate.) Such specific assessment will afford answers to four important questions. (1) Can the cue-stimuli for fear be described in fairly concrete terms? (2) Does the patient show four or fewer different sets of fears? (3) Does the patient report clear imagery related to the fear cues? (4) Does the patient report or manifest fear, arousal, or discomfort while visualizing the relevant fear scenes? Affirmative answers to these questions prompt consideration of treatment via systematic desensitization.

Wolpe has written extensively on complications that arise from attempting systematic desensitization with inappropriate patients. Some patients simply cannot learn to relax. Others display what might be called a fear of relaxing or of "letting go." Still other patients do not seem to be able to conjure up the requisite imagery or to picture themselves as part of the targeted scenarios. Problems at these levels should prompt reconsideration of whether it is possible to use some sort of *in vivo* exposure procedure.

IV. EMPIRICAL STUDIES

Early reports about the successes of systematic desensitization did much to promote behavior therapy and the conditioning formulation of psychopathology on which behavior therapy was based. However, the tenor of those early reports was influenced by the Protestantism of that era; the subsequent four decades have witnessed some moderation of those early claims and no small amount of controversy.

A. Early Clinical Reports

The first reports of clinical success with systematic desensitization were reported by Joseph Wolpe via a series of papers published from 1952 to 1962. These papers were shadowed by a series of similar reports provided by Arnold Lazarus from 1957 to 1965. An extraordinarily thorough review of these and other early reports was prepared by Gordon L. Paul and published in 1969.

1. Joseph Wolpe

In his influential 1958 book, *Psychotherapy by Reciprocal Inhibition*, Joseph Wolpe reported that nearly 90% of 210 patients were either improved or much improved following treatment with his new methods. Gordon Paul pointed out later that some of those 210 patients were treated with methods other than systematic desensitization. He reanalyzed Wolpe's original reports, identified 85 patients who had been treated with systematic desensitization alone, and reported success in 78 (92%) of those 85 cases. He reported also that follow-up contacts with 21 patients after periods of 6 to 48 months yielded no report of relapse. In some cases the effects of systematic desensitization were gauged by direct observation and by reports from unbiased others. By and large, however, "success" was defined as self-reports of improved responses in the presence of previously anxiety-eliciting stimuli encountered in the natural environment.

2. Arnold Lazarus

In 1957 Arnold Lazarus and Stanley Rachman provided the first report of success when systematic desensitization was used by a therapist other than Joseph Wolpe. Through the first half of the 1960s Lazarus provided very careful case reports and summaries about a total of 220 patients with whom systematic desensitization had been used. The presenting problems were quite diverse; they included social anxieties, generalized

anxiety, panic, and numerous phobias including agoraphobia. Of these 220 diverse cases Lazarus counted 190 as successes based on therapists' Likert-type ratings of patients' functioning in several adaptively significant arenas. He also acquired corroborative reports from referral sources in 70% of his cases.

3. Other Early Reports

The successes reported by Joseph Wolpe and Arnold Lazarus prompted numerous other reports about treating anxiety-related conditions with systematic desensitization. By 1969, Gordon L. Paul was able to locate 51 separate reports of individual cases or clinic series and several reports of systematic desensitization applied in groups. Successful outcomes were not universal in these reports, but there were relatively few failures.

B. The First "Controlled" Experiments

The earliest behavior therapists sought scientific support for the efficacy of their treatments. Thus when early experimental work done by Peter J. Lang and by Gordon L. Paul provided that support it received unprecedented attention.

1. Peter J. Lang

In 1963 and again in 1965 Peter J. Lang and his colleagues reported early experiments in which snake-fearful college students were exposed to standardized forms of systematic desensitization. In the aggregate the experiments achieved impressive control over sources of unwanted variance in the dependent-variable measures; they succeeded in supporting the argument that temporal pairing of muscular relaxation and graded imaging of snake-related scenarios was specifically responsible for observed reductions in avoidance and reported reductions in fear of snakes. They also provided 6-month follow-up data supporting the specific effect of systematic desensitization. Overall, 15 participants who nearly completed the standard course of systematic desensitization improved significantly by contrast with 10 participants who did not complete the standard course of desensitization, with 10 participants exposed to a procedural control for experimental demand/placebo influences, and with 11 participants who served as untreated controls.

2. Gordon L. Paul

In 1966 Gordon L. Paul reported an experiment that remains a methodological reference point three decades

later, and that still affords the most convincing evidence available of the specific effectiveness of systematic desensitization. The participants were 96 college students most of whom would now be diagnosed as having generalized social phobia with particular problems in the domain of public speaking. After extensive assessment each of 74 participants was assigned to one of four experimental conditions that, taken together, served to compare the effects of systematic desensitization with those of insight-oriented psychotherapy under conditions that controlled for influence from experimenter (therapist) bias and from major extratherapeutic sources of variance. Fear during a standardized public speaking task was assessed by self-reports, by demonstrably reliable behavioral observation, and by pulse-rate and palmar sweat measures. The group treated with systematic desensitization improved significantly more than did any other group on fear measures in all three domains. Posttreatment differences were maintained as judged by self-reports acquired 2 years later from carefully selected respondents.

C. Analogue Experiments

The behavior therapy movement was up and running by 1970 complete with several new books, three new journals, and two new societies. In this context the early experiments reported by Peter J. Lang and his colleagues spawned scores of experiments in which pretreatment and posttreatment measures of fear of snakes among college students were used to evaluate the effects of systematic desensitization. Some of the experiments compared the effects of systematic desensitization with the effects of competing behavior-influence packages, notably implosive therapy and imaginal flooding. Most of the experiments compared the effects of systematic desensitization with those procedural variations that were germane for one reason or another. Many questions were asked. Is muscular relaxation training necessary for fear reduction with systematic desensitization? Must the imaging instructions proceed along a graded, increasingly fearsome hierarchy of scenarios? Must the participant be permitted to govern his or her own rate of progress along the scenario hierarchy?

Notwithstanding the effort and ingenuity that went into the so-called "snake desensitization studies" they afford very little by way of characterizing the clinical efficacy of systematic desensitization. This is true for at least two reasons. First, in the intellectual climate of the day the efficacy of systematic desensitization was virtually axiomatic; therefore most of the research was intended

to answer other questions, such as questions about the “active ingredients” or causal mechanism(s) that explain the success of the approach. Second, the quality of systematic desensitization research with snake-fearful participants fell off sharply very soon after Lang’s original reports; since 1972 the external validity of empirical generalizations based on orthodox “snake desensitization studies” has been very much in doubt.

D. Current Status

Throughout most of the decade of the 1960s systematic desensitization was clearly the treatment of choice for phobias and for other anxiety-related conditions. That popularity was based on the reports of clinical cases and series noted earlier and, in part, on the zeitgeist in which Joseph Wolpe’s formulations appeared. Toward the end of the decade the work of Albert Bandura and his students began to receive attention also; phobia treatments such as graduated participant modeling began to compete with systematic desensitization. During the middle 1970s Isaac Marks began arguing persuasively that exposure to fear signals is the common element of the successful phobia treatments and that *in vivo* or real-life exposure is all that is needed for clinical success. Thus was born the approach known as “exposure technology.”

One outcome of the competing efforts of Albert Bandura and Isaac Marks was an abrupt decline of interest in systematic desensitization. Thus when reports of experiments on the systematic desensitization of snake-fearful (and test-anxious and shy) college students disappeared suddenly from the mainstream literature in 1972 there was nothing about systematic desensitization to take their place. For the past 28 years the empirical literature has contained only episodic case reports about unusual or otherwise interesting applications of the procedure.

Because of the dearth of new data for a quarter century and the widely suspect external validity of “analogue” studies, there are essentially two ways to attempt answering questions about the efficacy of systematic desensitization. One can study and evaluate polemic papers, including papers based on meta-analytic studies, that include statements about clinical outcomes and/or one can retreat to information found in the early clinical series and experiments reported by people such as Joseph Wolpe, Arnold Lazarus, Peter J. Lang, and Gordon L. Paul. The polemics have occurred mainly between Joseph Wolpe and Isaac Marks who have championed the causes of systematic desensitization and exposure technology, respectively. The early clinical series and ex-

periments were, as noted earlier, reviewed in painstaking detail, by Gordon L. Paul in 1969.

V. CASE ILLUSTRATION

The narrative that follows describes the treatment of a 45-year-old, married, white female (Helen) who had severe dental phobia. Behavioral interviewing revealed a clear history of aversive conditioning that involved both pain and ridicule during her extremely rare dental visits. The patient’s goal in seeking treatment was to tolerate many sessions of restorative dental treatment. (She could more easily have been a candidate for dentures than for full-mouth restoration; she resisted dentures citing the implication of old age.)

A. Assessment

Early on Helen flatly refused to try direct exposure to dental care under any conditions. Systematic desensitization was then considered as a preparation for subsequent real-life exposure, provided that assessment data supported the use of systematic desensitization.

Initially a suitable dentist was contacted and together Helen and I visited the dentist’s office in order to promote concrete imagery during the upcoming assessment. (The visit required a promise that no interaction with the dentist other than a “hello” would be expected.) Time was taken for Helen to get sufficient information for detailed mental pictures of the sights and sounds of that specific environment, and to tell that dentist about her fear.

A widely used structured interview produced diagnoses of claustrophobia and social phobia. (Usually fear of pain or of other oral discomfort plays a central role in dental fear and avoidance; the picture for Helen was surprising, especially given an apparent history of pain-related aversive conditioning.) Questionnaires, role-plays, and imaginal rehearsals were used to pinpoint the kinds of events that made Helen anxious and to describe her fear in three-channel terms. (For example, a questionnaire about the details of claustrophobia established that she was concerned with confinement but not with suffocation.) Helen was identified as a candidate for systematic desensitization in imagination based on the criteria in Joseph Wolpe’s 1990 book. Importantly she reported clear imagery and considerable discomfort, including perceived heart-rate increase, during imaginal rehearsals of selected dental-visit scenarios. The kinds of events that made Helen anxious did, indeed, have more to do with confinement and with criticism than with pain.

B. Relaxation and Hierarchy Construction

An eight-session course of relaxation training was undertaken twice weekly using transcripts from the 1973 manual of Douglas A. Bernstein and Thomas D. Borkovec. During the last two sessions four muscle groups were used in order to set the stage for systematic desensitization. In general four repetitions of tension-relaxation cycles were used. Helen had no means of playing tape-recorded relaxation instructions. She was encouraged to relax at home when possible but no records were kept.

During several of the eight visits, at times when Helen was not relaxing, two initial hierarchies for systematic desensitization in imagination were prepared. The hierarchies were developed with an orthodox SUDs-scaling procedure based on scenarios initially provided by both of us. There was difficulty developing separate hierarchies for confinement and for devaluation/criticism that had the necessary gradations in SUDs. After considerable work we decided to begin with one hierarchy that contained scenarios related both to confinement and to devaluation/criticism. In addition we imbedded scenarios of both kinds in a spatiotemporal sequence that began 4 weeks before the first dental visit and that ended in the dental operator. In the end the hierarchy included 21 scenarios that were at or near 5 SUDs apart from one another. Representative items include "Thinking about the dental visit one week away," "The assistant telephones to remind you two days before the appointment," "The dentist looks startled and asks you if you have ever brushed your teeth," "Reclining in the dental chair with tubes in your mouth so you cannot move."

C. Systematic Desensitization

Systematic desensitization occurred over 12 weekly visits. Each time it was preceded with 8 minutes of four muscle-group relaxation training. Then imaginal rehearsals of the hierarchical scenarios were begun. By and large the procedure involved "orthodox" systematic desensitization as described earlier. In general the actual desensitization trials lasted between 15 and 18 minutes. Each scenario was visualized calmly four times in succession before going to the next. No more than three scenarios were completed in any single session. Care was taken to end the trial on a successful item. On five occasions a scenario prompted repeated anxiety signals and a new, intervening scenario was used.

Beginning in the third week Helen was instructed to begin real-life practice of the spatiotemporal and behavioral aspects of the visualized scenarios. She was encouraged to not go too fast; to practice a week or so behind her progress along the imaginal gradient. As systematic desensitization progressed the dentist participated as an *in vivo* partner; various, long-duration *in vivo* exposure visits were added to the imagined scenarios.

VI. SUMMARY

Systematic desensitization is a venerable behavior therapy for fear and anxiety. Usually it entails remaining deeply relaxed while visualizing a series of increasingly fearsome scenes in which the patient confronts targeted events or situations. There are many theories about how systematic desensitization reduces fear; most "theories" are *post hoc* claims that systematic desensitization instantiates some other training regimen or process such as respondent extinction, habituation, counterconditioning, or self-efficacy augmentation. Joseph Wolpe's original theory of how systematic desensitization works appeals to learned inhibition of anxiety that is based on parasympathetic inhibition of sympathetic activation. Criteria have been developed to identify good candidates for systematic desensitization (e.g., there are four fears or fewer, there is evidence of a capacity for clear imagery, there is evidence of emotional discomfort while imaging frightening material). Scores of case studies and reports of clinical series attest to the efficacy of systematic desensitization. Several now classic experiments show the efficacy of systematic desensitization also. Much research on the outcomes of systematic desensitization was done in a way that renders it of little value. By and large research on the effects of systematic desensitization disappeared from the literature when exposure technology replaced systematic desensitization as the treatment of choice for phobic complaints. However, the earliest case studies and clinical series suffice to support the claim that systematic desensitization is effective and should be considered when *in vivo* exposure is not feasible or is initially refused. A case is described in which a 45-year-old female is treated for dental phobia that was based on claustrophobia and on social phobia.

See Also the Following Articles

Coverant Control ■ Emotive Imagery ■ Exposure ■ Eye Movement Desensitization and Reprocessing ■ Habit Reversal ■ Relaxation Training ■ Self-Control Desensitization ■ Successive Approximations

Further Reading

- Bernstein, D. A., & Borkovec, T. D. (1973). *Progressive relaxation training*. Champaign, IL: Research Press.
- Goldfried, M. R., & Davison, G. C. (1976). *Clinical behavior therapy*. New York: Holt, Rinehart & Winston.
- McGlynn, F. D., Mealiea, W. L., & Landau, D. L. (1981). The current status of systematic desensitization. *Clinical Psychology Review, 1*, 149–179.
- Paul, G. L. (1969). Outcome of systematic desensitization I: Background, procedures, and uncontrolled reports of individual treatment. In C. M. Franks (Ed.), *Behavior therapy: Appraisal and status* (pp. 63–104). New York: McGraw-Hill.
- Paul, G. L. (1969). Outcome of systematic desensitization II: Controlled investigations of individual treatment, technique variations, and current status. In C. M. Franks (Ed.), *Behavior therapy: Appraisal and status* (pp. 105–159). New York: McGraw-Hill.
- Thorpe, G. L., & Olson, S. L. (1997). *Behavior therapy: Concepts, procedures, and applications* (2nd ed.). Needham Heights, MA: Allyn & Bacon.
- Wolpe, J. (1976). *Theme and variations: A behavior therapy casebook*. Elmsford, NY: Pergamon.
- Wolpe, J. (1990). *The practice of behavior therapy* (4th ed.). Elmsford, NY: Pergamon.



Tele-Psychotherapy

Ann Oberkirch

Yale School of Medicine

- I. Introduction
 - II. Technology: Video
 - III. Technology: E-Words
 - IV. Tele-Psychotherapy Today
 - V. Impediments, Controversies, and Caveats
 - VI. Clinical Tales and the Tele-Transference Issue
 - VII. Two Preliminary Studies
 - VIII. Tele-Psychotherapy Tomorrow
- Further Reading

the other end incoming analogue data are converted back to digital. Download speed, which is variable at best is 50 kbps, and upload is 33 kbps.

satellite Speeds are on par with DSL and cable. Requires a rooftop dish.

videoconferencing Long distance meetings occurring with both picture and sound transmitted between two or more locations. Ideally transmission occurs in real time and there is perfect synchronization of voice and sound.

GLOSSARY

bandwidth Data transfer speed for telecommunication data.

cable The widest pipes and the fastest but speed will vary. Pipelines are shared with neighbors, and are not dedicated lines like DSL. The maximum theoretical download speed is 27 gigabits per second. Upload speed may be 128 to 384 kbps.

chat rooms Virtual containers for instant e-mail correspondences from disparate locations.

DSL A digital subscriber line has no standard speed. Speeds vary from 256 kbps to 1.5 Mbps and thus are considerably faster than ISDN.

e-mail Electronic mail sent via the Internet.

fixed wireless Requires an antenna on the roof; download speed 1 to 2 mbps, and upload 256 kbps.

ISDN Integrated services digital network begins with a guaranteed 64 kbps, or two lines at 128 kbps, or four lines at 256 kbps or higher. Data can be compressed as well to speed transmission.

POTS Plain old standard telephone has the slowest speed. Data are transmitted in analogue wave form. A computer modem converts outgoing digital data to analogue and on

I. INTRODUCTION

Tele is a prefix from the Greek *tele* meaning at a distance, or far off. Thus, tele-psychotherapy is simply a term for psychotherapy conducted at a distance instead of taking place in the usual office setting with all participants physically present in one room. Tele-treatment is usually assumed to include new technology, either videoconferencing or e-words.

Videoconferencing technology has advanced sufficiently to deploy psychotherapeutic services that can span the globe, or even transmit to a space vehicle. At the present time, researchers funded by NASA are planning the psychological and medical care for a Mars probe planned for the end of this decade. Treatment will soon be supported from one end of our solar system to another. Truly, psychotherapy has been liberated from the office!

There is nothing new in psychotherapy occurring long distance. Letters have always been sent by surface mail from patient to therapist and vice versa, and

should be considered a valid part of treatment. The telephone, as well, has routinely been used for brief consultation or full scheduled visits. Certainly, the initial call that plans the first visit and introduces the participants to each other is a form of tele-psychotherapy, although rarely recognized as such.

Telephone psychological support services have a long history, and provide much needed round-the-clock services sometimes with a more user-friendly interface than traditional medical settings. While suicide hot lines may be staffed by nonprofessionals, the ready access to a sympathetic voice has often sustained the troubled through difficult times.

Students who go off to be educated at a distant locale frequently remain in telephone relationships that are well established and proven salutary. Face-to-face visits are held at vacation times. Many adult patients who are attached to their therapists move, and choose to remain in a well-known trusted helpful partnership, rather than start over again with someone new. These patients should, and often do, have an occasional live office visit.

A colleague in psychoanalysis explained that at the beginning of the week she traveled to a city 3 hours away for an evening session, stayed overnight in a hotel, and had a visit the following morning, and then participated in two more telephone visits before the weekend. While this is unusual, it is not unheard of. Other patients traveling for work or pleasure, or simply too busy to commute to the therapist in the midst of a day of activities, will opt to keep a therapy appointment by phone, if the therapist is agreeable. This is more likely in the west than in the east. There are numerous surreptitious stories of telephone treatments. However, until now, the practice of telephone psychotherapy has always been utilized within treatments that began in a traditional office setting.

Today our new technology allows for treatments to begin outside an office container. What should we make of this psychotherapeutic brave new world? This article will introduce you to tele-psychotherapy: good or bad, safe or risky.

There is much reason for optimism: As new standards for telecare are written, and new regulatory law is encoded, good treatments will prevail, not wild teletherapies, and new, effective and improved telepsychotherapies will be developed. We are at the point that quality care can be universal, if only we will share our resources.

II. TECHNOLOGY: VIDEO

Top-quality telephone or computer-driven videoconferencing has images that are similar to television or

movies. The transmission of separate pictures is not detectible, and lip synchronization is perfect. Often there is little or no delay caused by distance, and communication flows easily. From the wide array of videoconferencing tools, equipment can be utilized with a guaranteed verisimilitude, the ideal, or for the most modest investment, inexpensive video that is unreliable, and/or so poorly reproduced that it is nearly useless. The quality of images relates to one factor: cost. The more money spent on equipment, software for computer applications, and transmission links, the better the result.

Videophones are now available that are simply telephones that can be plugged into a standard phone jack and produce excellent pictures. The image may appear on a lightweight portable phone screen that easily fits into an ample pocket or purse, or on a larger stationary telephone unit's screen, or displayed on a computer screen, or at the most lifelike projected on a television screen. These phones may have regular or plain old telephone system transmission links (POTS), or ISDN phones that utilize linkages two to four times as wide as POTS telephones. The best of them, often bought by the government to be used by the CIA, FBI, or military, cost well over a thousand dollars. The advantage of POTS videophones is ubiquity. The best videophones scramble information so privacy is almost guaranteed, hence their utility for the government.

Videoconferencing can also be conducted between computers with no telephones involved. When the widest pipe lines (known as broadband) are sending digital information, excellent images result. The cost of an individual long distance phone call is not incurred with every meeting, which is considerable when the videoconference lasts for a standard psychotherapeutic hour and crosses one or more oceans. The users pay a monthly fee for renting the broadband attachment (e.g., cable, ISDN, or DSL) to the local phone line. Such private stable computer linkages are often established between hospitals and satellite clinics. These networks may be set up by one of the large videoconferencing companies who sell their own connecting software or done more simply by downloading videoconferencing software off the web to go with a single PC.

Small clinics that cannot underwrite such expensive private networks can turn to the Internet for video transmission help. At least two companies will now permit downloading of videoconferencing software without charge into a PC/Windows based personal computer: CUSeeMe from White Pine and Microsoft's Netmeeting. With the addition of a 70 dollar videocamera on both ends, and an attachment to a high speed

link like cable or DSL, without the addition of special software of equipment sold by the top videoconferencing companies, reliable intermediate quality images will result. For a military clinic in Hawaii with patients on a tiny island thousands of miles away, some video is far better than none, and improves care well above that done with mere sound.

Lower cost computer-driven video and low end videophones are, of course, available for pure POTS transmission, although diminishing expense is unfortunately correlated with decreasing quality. This would occasionally allow a therapist to receive video alongside audio, but the images are most likely to be delayed, and are prone to breaking up or fragmenting into component data, and transmission most often cannot be guaranteed, as crowded Internet lines prevent the flow of data at peak times. Thus, when a subject moves, the image conveyed breaks up into tiny parts or fragments. This is a disconcerting experience to view. The intermittent distorted weird displays are unsettling, and are not conducive to serious psychotherapeutic work.

How does videoconferencing compare to a real office visit? Is it nearly as useful? How much evaluative data are lost when a therapy patient is seen in only two dimensions? What happens when scent/olfaction is lost as a sensory cue? How much do we rely on intuition, whatever that is, as an evaluative measure and how much is it dependent on the actual sharing of physical space? How long will it take a generation of computer savvy people to process the mysteries of each other with a virtual contact? We have much to learn, but this should not hold us back.

III. TECHNOLOGY: E-WORDS

In the beginning, the portal of entry to the web was a computer. Access today can be instantaneous with a mere handheld wireless device that can fit in one small palm, even a child's. Alternatively a modestly priced electronic gadget designed only to link to the Internet equipped with a keyboard and large screen will do. The Internet's transmission of words, pictures, and other data is astonishing; the effluent is rapidly changing our civilization. Information of serious or dubious value is readily available for global consumption. The latest news can be read almost as it happens with the flick of a switch on a tiny unit. Nearly anyone can search the most knowledgeable medical databases from nearly anywhere. Sophisticated patients may know as much or more than their doctors about their illnesses as chat groups or bulletin boards run by victims of illnesses

often provide the best information for dealing with disease. The Internet world has spun us topsy-turvy, replaced some pomposity with humility, and occasional ignorance with knowledge, and allowed a cave in a wilderness to headquarter a global terrorist war. The facile flow has brought all of us closer together, for good and for evil.

Groups, sometimes patients, can meet in real time in chat rooms that include participants from all over our planet. At the present time, these virtual settings allow only verbal messages, but in the near future, when broadband and POTS are near equally priced, and information that creates images races along, these virtual rooms will have multiple video-streams, one from each source. A dyad, or therapy pair, can now talk via instant messaging and share live real time e-conversation, usually typed and sometimes spoken.

E-mail is ubiquitous: The good news is the telephone has not deleted the written word, indeed letter-writing has returned in spite of television usurping hours spent on reading; the bad news is that much e-mail, whether spoken or typed, like much surface mail, is junk.

Amidst the deluge of e-correspondences, however, are useful interactions between therapists and patients. E-mail contact has a bad reputation because of the exploitation of cyberspace for felonious "activities". However, imagine the gain for a fragile person who can send a letter (albeit an e-letter) to a therapist at any time of night or day. In the loneliest hours when most are asleep, this may make the difference between life and death.

Properly used, the Internet will alter psychotherapy practice for the benefit of patients. Today, cyberspace is the "wild west," anything goes. Rest assured, this will not last.

IV. TELE-PSYCHOTHERAPY TODAY

A spare room in a centrally located community building can quickly be converted into a satellite psychotherapy clinic with the simple addition of a videoconferencing system, a scheduling administrator, and the requisite broadband link to a clinic with available psychotherapy staff. The earliest utilization of tele-psychotherapy has been the most natural: The technology has enabled the development of satellite clinics providing care in communities that cannot support full mental health clinics themselves.

The psychiatric and psychological sections of meetings for telemedical professionals have nearly always included clinical presentations from countries and states

with large remote areas with low population density including Australia, Newfoundland, Norway, Alaska, Arizona, Michigan, and New Mexico, as well as other more exotic locales. These papers recount the benefit and efficacy of tele-treatments. The presentations are inspirational and usually have scenic photographs: one side of the videolink may be a well-known center of excellence, while the other is a few huts in the wilderness sometimes surrounded by reindeer and locked in by snow and ice. The patients, if depicted, are overwhelmingly grateful that care is available at long last for conditions that heretofore have gone neglected. The tele-psychotherapeutic visits are presumed to be almost as good as the real thing, and are justified as providing virtual care where real office care cannot exist.

A secondary proliferation of tele-psychotherapeutic services has been to prisons that are intentionally built far from population centers. A videoconferencing link allows for flexibility of delivery of services that could not be supported by importing mental health staff or exporting prisoner-patients with the requisite guard staff and a driver.

The United States Department of Health and Human Services Commission endorses long-distance treatment as the legitimate embrace of new technology by creating the first reimbursement codes for tele-psychotherapy, although in rural areas only. The preference for rural telemedicine and telepsychotherapy is echoed as well by the governmental agencies that fund telemedical programs: They are only willing to support programs in rural settings. Urban clinicians need not apply.

The military, of course, uses tele-treatments for troops and support staff who are stationed routinely in remote locations. The earliest implementation of the most sophisticated equipment would be allocated toward saving lives, hence tele-psychological services would be supported only when physical health needs are fully deployed. It is not yet widely accepted that providing adequate psychological support after the horror of battle and injury, if possible, speeds recovery from medical injuries.

Tele-treatments are slow in developing outside remote areas. There is little research on the potential exploitation of this new technology to improve delivery of care for patients who require the careful purview of a vigilant therapist with some exceptions. A project from Massachusetts General evaluates videoconferencing for OCD by Lee Baer and colleagues. A researcher from London, Paul McLaren, studies the use of videoconferencing in psychiatry in urban settings by inpatient units seeking specialty consultation at other hospitals.

Medical schools in and outside the United States show enormous zeal for developing consultation programs that bring in patients from distant locales. Many of these projects are developing to bring income into institutions facing funding cuts while they are simultaneously finding new and improved models of patient care. The comparative indifference to exploring the potential benefit of this new technology for local use seems shortsighted and overly cautious. In general, the prevailing opinion of tele-psychotherapy is that it is a second-rate alternative to in-the-flesh real care. Still, there is a surprising lack of creative effort for planning new techniques for conducting psychotherapy using this technology. Perhaps one explanation of this relative indifference is that grant money for pure clinical work is difficult to find. Much psychiatric research is drug company based, hence scientific research devoid of pharmaceuticals is more difficult to support. If this technology promises to bring relief of suffering to patients, and this opinion is popularized, scientific scrutiny is certain to ensue, although this seems not likely to occur soon. Today's adolescents have rich social lives in virtual settings sometimes all over the world, but the adult scientist generation is not yet ready to mine these virtual settings for clinical gain.

Psychotherapy in cyberspace or e-therapies are developing quickly. A web search will find a variety of dotcoms selling web treatments, and more added each day. The preponderance of e-psychotherapies are offered by nonmedical clinicians, and it is often difficult to evaluate the credentials of the practitioners. A minority of these web clinics include telephone conversations alongside e-mail chat. E-mail treatment is inexpensive but many clinicians believe it is of dubious value, hence you get what you pay for. How can words alone be beneficial to patients? If e-mail help is limited to informational help, rather than counseling or treatment, and goals are limited, and conceptually understood, it seems feasible that some useful parameters for e-service could be defined. If a life is saved by a well-timed persuasive e-comment, how would we discover this unknown benefit? The rapid condemnation of all e-services without exploring individually what each is doing seems hasty and gratuitously cautious.

Many psychotherapists exchange e-mail with patients. When this mail is sent within an active clinical exchange, the interaction is similar to a voice mail message, and is simply a new component of treatment. E-dialogue is another way for our patients to reach us, to confess secrets hard to admit face to face, to let us know more of aspects of a distraught inner self, and

therefore provide more grist for the mill of an ongoing therapy.

V. IMPEDIMENTS, CONTROVERSIES, AND CAVEATS

Why hasn't tele-psychotherapy been embraced far and wide by practitioners with technical savvy when it seems such a logical extension of office treatment? The primary obstacle is probably money. As yet, there are no reimbursement codes for billing tele-psychotherapeutic videoconferencing visits unless your clinical work is done in rural areas. The managed care companies that underwrite much psychotherapy in the United States have not yet discerned that tele-psychotherapeutic visits are likely to save considerable funds when conducted in rural and urban settings. The studies demonstrating this have simply not been done yet.

There is also no reimbursement for e-mail correspondence, rural or otherwise. When clinicians permit e-mail correspondence, they either have to do this as a gift of time, or a billing arrangement must be agreed on with the individuals involved. When the patient's psychotherapy coverage is within a managed care program, the clinician is breaching the managed care contract by charging for e-mail treatment time. The concerned clinician is faced with an unpleasant dilemma when supplementing office visits for a fragile patient with an e-mail correspondence. If this exchange is done without fee, does this generosity have a tinge of self-sacrifice by the clinician? How would this effect the treatment over time? Alternatively, if a billing arrangement is set behind the back of managed care rules, what message does this give the patient about the therapist's ethics? There is no good solution given today's managed care contractual agreements for clinicians.

The solution might be to limit e-mail correspondence to self-pay patients. A policy of this sort would enhance the development of tiered mental health services with the best care given to the wealthiest patients who can afford to self-pay out of discretionary funds. This seems an unfortunate division of services for discerning who gets the most flexible treatment. Another solution might be to create public sector services for everyone offered by one government agency instead of our current complex system. We are a long way in the United States from a unitary mode.

In countries with government health care coverage for all citizens, it will probably prove easier to establish tele-psychotherapeutic practice. The complex chal-

lenges of finding liability coverage for clinicians for novel tele-treatments would be dealt with by a central authority, and reimbursement for telecare for all citizens could be efficiently planned. In the United States with its complex health care apparatus, each independent clinician will have to struggle to find tele-treatment liability coverage usually through a professional society. At the time of this writing there is scant malpractice liability coverage sold for tele-psychiatry by psychiatric insurers. The American Psychiatric Association is unfortunately not likely to make this available anytime soon even as an add-on to the usual malpractice package. Teletreatment programs operating out of medical schools and graduate psychology and social work departments that self-insure the malpractice of staff clinicians will have more flexibility.

The logical way to bill for e-mail time is by bytes of time or minutes. Just as lawyers charge for varying lengths of time, psychotherapists might do the same. But the reimbursement system in American medicine (and psychotherapy falls into this category) is by service code, roughly but not precisely based on time. How long will it take to convert the standard procedure code system to a more flexible scheme for tele-psychotherapeutic care that above all else should have flexibility for session lengths whatever the method of delivery? Since this constitutes a radical change in reimbursement structures, it is likely to be slow in coming. Another more novel approach for payment of e-mail correspondence might be a monthly set fee for e-mail privileges.

The regulatory barriers to tele-psychotherapy are enormous, and are likely to be more complicated in the future, not less. In the United States, licensures for psychotherapeutic practice is issued by state. Clinicians are credentialed to practice locally. Tele-psychotherapy would be confined to a geographic area when large clinics establish satellites, but how are clinicians to be licensed when the primary clinic is in one state and the satellite(s) in another? The medical-legal issues are compounded even more when the treatment is between two nations or several. The European Union is establishing guidelines for telemedical care that will enhance the flow of treatment within these countries. The World Health Organization has a larger global focus as it seeks to establish telemedical rules for all nations. It too is working on guidelines for telemedical practice. Ultimately, the nations of the world will have global pacts for telemedical and tele-psychotherapy treatments, protection of patient privacy regulations, conventions for flow of medical data, and even, one hopes, global pharmaceutical rules so patients who travel may

easily get telemedical treatment and medications whenever they happen to be.

Today, whenever a therapist conducts tele-treatment with a patient in another country, or another state or province, the clinician is already operating in a legal gray area. Videoconferencing and telephone sessions held interstate or between national jurisdictions are not always clearly legally permissible, although they are also not quite against the law. For instance, does the clinician require a license to practice where the patient is located, however distant? Some would argue that an affirmative reply is correct, others not.

The G8 telemedical study group has members roughly comparable to the top eight global industrial powers. One of their strong recommendations is that when telemedical treatment is done, the license and governance in the location of the medical clinician should govern the transaction. Thus, clinicians will only require licenses, malpractice liability, and liability releases in one jurisdiction, not every location they are treating patients. It is not known, as sensible as this notion is, whether local governments will go along with such rules. How will chauvinism restrain itself from rearing its ugly head and launching protective turf battles? How will psychotherapy regional societies sit back and allow distant clinical intruders to compete for their available patient pool? Neither seems likely, although the alternative possibilities are dismal.

Who will be responsible for monitoring long distance treatments? Will this be done by the medical/psychotherapy societies in the clinician's jurisdiction or in the patient's? There is little agreement so far on what is considered adequate care utilizing videoconferencing, and even less of a consensus regarding e-word or text-based treatment. Standards of care must be determined, but given the paucity of scientific data on tele-psychotherapy, how will these be set? Interest in tele-treatment is not adequate yet for sufficient research to be funded to make these assessments. When agreement is finally reached, will it be possible to allow enough flexibility so creative clinicians can continue to generate new and exciting techniques and methods? Alas, in psychiatry, practice guidelines geared to protect patients and guarantee a high standard of care are being established that may eliminate deviation from a strict conservative norm. So in the short term patients are protected, at grave risk of an overall atrophy of creativity in the field.

The privacy issue has evoked much concern. When videoconferencing networks with a few private linkages are established, it is easy to create encryption of

data and sufficient firewalls around the database server so the patients are as close to guaranteed privacy as is possible. But when the Internet is used for videoconferencing, or for e-mail, for modestly funded programs or treatments, how will privacy of data be promised if it flows between many servers that cannot be regulated by clinician or patients?

In the United States, extensive standards governing both privacy and security of health information are being developed and implemented under HIPAA (the Health Insurance Portability and Accountability Act of 1996). This law threatens high fines and even criminal penalties for unauthorized release of information. The security requirements will mandate some form of access control or encryption to protect electronic data traveling over a communications network. Other countries are enacting similar legislation. But how will every psychotherapist know these rules and follow them when the available unregulated Internet is so seductive?

The issue about which there is the most controversy is the entire matter of cyberspace psychotherapy or treatment by e-mail. Is it simply bad treatment and therefore negligent only designed to make a fast buck for its purveyors? Or are there circumstances when e-care might be appropriate or necessary? If so, what are these? Robert Hsiung, M.D., at the University of Chicago, is editing a book on e-therapy. He is well suited to do this as he runs a message board for patients with a million hits per month that he monitors himself, clearly not an easy task. Dr. Hsiung believes that e-care should not be carelessly relegated to tele-psychotherapeutic malpractice without a careful exploration of its salutary potential. But how will we decide what e-care is helpful and what is not in the face of the paucity of evidence-based clinical research to allow these determinations to be made based on scientific data?

Horror stories exist of Internet fraud: self-appointed therapists with no training setting up shop on the web. Who should regulate such practice? Should there be monitoring for consumer, or in this case, patient protection? Is this monitoring an invasion of privacy? Who will decide? No doubt, in time government commissions will develop to scrutinize web businesses, including all psychotherapeutic transactions, but if both parties have encryption and firewalls, this will not be an easy task.

One caveat: If you are going to utilize e-mail in your existing psychotherapeutic practice, make sure your patients know how often you read your letters. You do not want a new patient or anyone to send you an e-note full of suicidal ideation, homicidal yearnings, confessions of

horrific crimes, or any other shared desperate feelings that you should have acted on but instead missed with dire consequences, because you had not had sufficient time to review your mail.

We have so much to discover and learn about tele-psychotherapy. The best of us is only an e-treatment toddler awkwardly staying up and finding the correct path.

VI. CLINICAL TALES AND THE ISSUE OF TELE-TRANSFERENCE

Patient confidentiality has been protected by eliminating or altering identifying data.

A. Case History I

Thomas is a tall, elegant, middle-aged man with a large brood of interesting tow-headed children. He has had two brief courses of psychotherapy with me several years apart each involving e-technology. He came to his first visit with great reluctance, and arrived incredibly late to underscore that sentiment. He had always taken great pride in his competence and independence, and like many people, stigmatized psychiatric illness, and felt any need for treatment was an embarrassing weakness. His father had service-connected bipolar disease related to battle experiences during World War II; he viewed this man with both sympathy and pity. He sought help from me when he realized he was losing control of his most valuable commodity, time, and had given up any hope of remedying the situation himself.

His first treatment occurred when Internet access was considered quite precious and was sold by the minute, and was usually a privilege for the wealthy or a perk of academia. Thomas was neither. He described how he sat in his office at the end of a grueling day of back-to-back meetings, and signed on to the web to relax. Soon he found himself in chat rooms where he easily found women offering delightful e-company. Conversations would go on for hours, and were quite expensive. He found himself lying to his wife about his unusual long evening hours at the office. He was horrified by his dissembling, and the huge expense for his e-habit. He felt addicted to the web and its chat rooms, and his self-reproach for this loss of control was enormous. He believed he loved his wife and did not understand his incessant web flirtations.

In the past he had had several serious episodes of depression that he waited out; all of these had a seasonal

component. His usual state was mildly ebullient: He needed little sleep, and his productivity was impressive. His only impulsive behavior in the past was with food; to his chagrin his weight went up and down. He exercised long hours to control his girth given his tendency to eat too much.

During several months of treatment, which involved an extraordinary number of cancellations, which he easily rationalized away as due to urgent situations at work, we discussed his marriage, its strengths and weaknesses. While it was apparent to me that Thomas was lonely in what appeared to be a faltering marriage, he had not allowed himself to acknowledge this. He saw his addiction to the web as analogous to overeating; and just as his weight would go up and down, so would his Internet time.

Thomas is a highly intelligent fellow. He enjoyed the opportunity to explore his past, his marriage, his parents' commitment to each other, and the nature of their relationship to him, and even our cautious study of his relationship with me. In time, he acknowledged how disappointed, sad, and bored he felt with his wife. His web friendships, which developed into romances, were thrilling.

One day he announced he was done with therapy, although he had just made a plan to meet one of his web girlfriends across the country during a business trip. He had never before considered infidelity and given his lapsed Catholicism, he would not abandon the sacrament of marriage without much soul-searching. Apparently he was not to do that with me as an accomplice.

Years later, Thomas contacted me again. He was now involved in a real love affair and was considering leaving his wife, and no, he had never met his cross country date when last we met. He was becoming increasingly depressed, and anxious about his confusing situation. His lover was pressuring him to end his marriage so she could leave her annoying husband, but he found himself reluctant to tear apart his children's family while they were still quite young. He enjoyed their company enormously and did not want to give up daily contact with them. Leaving his wife would be easier, though even this would be daunting.

At first his anxiety was nearly incapacitating and required the aggressive use of a tranquilizing SSRI antidepressant. When both his wife and his lovers' husband learned of the affair, not surprising given the frequent mid-day and evening assignations, he became deeply suicidal. Despite this, he refused to come in for office visits with the frequency his serious illness required, claiming work obligations. This explanation had already

seemed a convenient cover for his avoidant behavior, which had not responded to interpretation.

I knew him well enough to understand his need to distance himself, even at a time when he felt extremely fragile, could not be altered. This very private man had to maintain his boundaries with me, no matter what the cost, including the risk of suicide. He was unwilling to plan telephone visits claiming an absence of privacy on all his phones; he was terribly worried that someone would listen in. (This treatment was before personal cell phones.)

So I turned to the web to supplement his visit schedule as the only alternative to having information from him about his level of potential lethality, and thus a site for titrating his medications frequently, and a place to nurture him with well-chosen words. I insisted he maintain an e-mail correspondence with me, daily when necessary at a frequency determined by me, so I could follow the depth of his suicidal ideation. His treatment consisted of a weekly visit and for a month near daily e-mail notes. During this time, he decided to end his affair and concentrate on improving his marriage. When his suicidal depression improved, we slowly weaned his e-mail nurturance.

He continued his treatment with decreasing frequency while he described the benefits of his newly discovered focus on his marriage. His wife was now experienced as his long lost best friend. The privacy each partner needed to sustain a long commitment did not allow for intimate lovemaking, and he adjusted to the lost thrill of his love affair versus the reliability of his marriage.

One day he cancelled a visit for what seemed like a spurious reason. A nonjudgmental inquiring e-mail went unanswered. Once again, his real and virtual treatments ended abruptly.

Thomas' second treatment could have been fore-shortened when he became acutely suicidal but refused to allow me to determine the appropriate pace of our office meetings given his life-threatening illness. It was obvious that any attempt on my part to challenge or control him would have met with complete resistance, and the likely premature disruption of his treatment. My suggestion that we turn to a virtual conversation allowed for an ongoing discourse that could not be held elsewhere. Had we only had a weekly office visit with no supplementation, I would have never known if Thomas was safe. He could not be counted on to contact me if he became dangerously low. Plus I knew he could be overwhelmed by urges he could not control as he had been with spectacular binges of sweets. We both recognized that he might have become overwhelmed with suicidal impulses. The virtual conversations al-

lowed for daily care, which he needed, without what for him would have been an overwhelming intensity of intimate real office dialogue. Thank goodness there was e-mail. It may have kept him alive.

B. Case History 2

Anna lives in Hong Kong with her husband and children. Her spouse has a lucrative and interesting job that pulled the family from a much appreciated community on the east coast. Anna's oldest daughter has just hit menarche, the youngest is still in diapers, and there are a few sons in between. Anna feels she should be content with the opportunity to live in a fabulous city especially with her recent affluence. Instead she is miserable. Her mother-in-law contacted me for help.

Anna, like many expatriates, is homesick and misses her family, her home, her language, and her culture. She speaks eloquently about her many travails, but she believes she should be happy. She is pensive about the origin of her gloom, offers biological and philosophical explanations, and also is deeply ashamed.

There are no English-speaking psychiatrists in her Asian city that she can find despite a circle of expatriate friends. She does not know the local language so cannot utilize local care. I agreed to have telephone consultations with her only if she had office visits with me regularly when she returns to the states on visits.

That was 6 months ago and since then she has sometimes been quite ill. One serious downswing reminded her of a postpartum illness when she stayed in bed for a month and had both infanticidal and suicidal thoughts. She often has high energy spells with racing thoughts and not infrequent fabulous shopping sprees at the many terrific stores.

I have arranged to have medication sent abroad to her but only products with a wide margin of safety. I have told her she needs more effective but riskier pharmaceuticals, but am waiting to prescribe mood stabilizers until we have videoconferencing visits. I hope this caution makes sense to her; I have explained that I need to see her if I am giving her a medicine that can be toxic. Voice alone will not give me adequate diagnostic cues.

We are planning a video link soon, so more aggressive care is imminent. In the meantime, she is feeling euthymic right now, though she doubts this will last long.

Anna's telephone psychiatric consultations will soon be enhanced with the addition of videoconferencing. She is likely to be my only transcontinental patient until telepsychiatric liability is available for long-distance care. Her telecare is untraditional but given her circumstances, it seemed the most reasonable alternative.

C. Case History 3

Maureen at 50 is finally happily married, though little else about her life is pleasurable. She sought my help about a year ago when her last psychiatrist moved away and she felt perilously close to a suicide. She did not want to do this to her beloved spouse, though she cared little for her own life.

She was often morbidly ill as a young woman and her arms are covered with innumerable scars from self-mutilation. She now will not wear clothing that shows her arms as she is so ashamed of these revealing white lines. So she hides beneath hand-woven fabrics in an interesting palette. Her overeating, always a problem, has recently gotten completely out of control. She has doubled her weight. An all too familiar feeling of deadness will not abate and she wonders, without any tears, if she will ever feel alive again, not that she cares much.

Recently a pain in her abdomen turned out to be the result of rare benign tumors in both kidneys. The largest was embolized, but her extreme discomfort continues and it seems likely that surgery will be necessary. During her weekly psychotherapy visits, she cracks black comedic jokes, and converses with my two French mastiffs, but says little to me.

Early on in her care, she accepted my invitation to send e-mails with reports of her food intake. We were not able to successfully curb her binge eating, though she described her struggles with control, and other critical emotional events. Recent notes are of visits with this specialist and that. She also in e-writing reveals her fears, her despair, and her anguish, all of which cannot be spoken. As her mood disorder does not respond to pharmaceuticals, we rely on therapy, real and virtual, to control her demons and one hopes, slowly heal her many wounds. She is witty and talented, and I am determined to enliven her—this will require ingenuity on both our parts, but luckily we have an abundance of patience. She has done so well in the past in overcoming her slicing impulses, there is room for optimism.

Maureen's e-mail correspondence is much like Thomas'. Her letters allow for self-revelation that is impossible to achieve face to face. She can accept warmth and kindness from me in writing that would seem disingenuous in my consulting room where she spends her time amusing me. Her e-treatments sometimes seems like the most useful treatment but I know she values our meetings as well. I like and respect her and recognize her talents that too often have been ignored. Our shared pleasant hours are salutary given the abuse in her childhood.

Many therapists will eventually use videoconferencing or e-mail in a similar fashion. Patients will insist on this

flexibility, and therapists will comply. Teletreatments will be common, and will be understood to be nothing more or less than traditional care expanded by technology.

The relationship between patient and therapist will be equally available for scrutiny as an office treatment. Transference is a term that describes our predilection for misinterpreting relationships due to prior experiences usually in our childhoods. Thus an adult neglected in childhood will too easily find adult insult and injury. Tele-relationships will take longer to develop intensity but despite this attenuation, the full panoply of emotions will ensue. To be sure: tele-treatment will have transference aspects, despite the altered venue.

VII. TWO PRELIMINARY STUDIES

By early 1999, the web was suddenly abuzz with exciting activity. America Online was selling inexpensive global connectivity, and Amazon.com was selling books. How could this new technology be a potential source of benefit to my patients? The answer was not obvious.

After attending my first telemedicine conference in the fall of 1999, I decided to try out the technology in my practice to reduce the stress of separation at the time of my holidays, which seemed overwhelmingly distressing for some of my most fragile and dependent patients. These accounts are strictly anecdotal, there was never any plan to produce verifiable data. I was simply trying out what might be helpful in the most preliminary way. If my conclusions were positive, scientific studies might be warranted later.

A. Study 1: January 2000

The editor of a prominent telemedical journal suggested that low-cost videophones might suffice for long distance telepsychiatric treatment. Shortly before a trip to London for a conference sponsored by this colleague, I ordered six such videophones. Five were handed out to five fragile patients most likely to find the break in treatment troubling. The sixth phone went to England with me.

1. Results

2/5 Patients acted out by not appearing for their scheduled tele-visits.

3/5 had televisits with images appearing at a sluggish frame rate that had no semblance of reality. Voice and picture were poorly synchronized, not only did image lag way beyond sound, but the picture itself fragmented with movement creating a psychedelic effect.

1/5 A bipolar male used to long distance telephone treatment declared the video of no benefit.

1/5 A paranoid schizophrenic woman would not look at the camera, though her husband enjoyed the unique experience of a trans-Atlantic video-conversation

1/5 A bipolar woman was delighted with her video-talk with me and believed seeing me defused her anguish.

2. Conclusion

Low end videoconferencing is minimally better than telephone without video. Clinically useful videoconferencing should approximate real time with well synchronized movement and sound.

B. Study 2

I had announced a holiday to Nepal and invited patients to e-mail me if necessary during my lengthy absence. My practice would be covered by a local psychiatrist during this hiatus, but e-mail greetings were available during recuperative stays in Kathmandu between treks.

1. Results

Eighteen patients wrote, five more than once. No patient required a single visit with another psychiatrist during my holiday, or needed a day hospital or inpatient stay.

2. Conclusion

An e-mail during a long break in treatment may obviate the need for an office visit by another clinician. Such e-mails may alleviate suffering due to separation anxiety as well. Reimbursement for such e-mail correspondence might save on the overall cost of treatment.

VIII. TELE-PSYCHOTHERAPY TOMORROW

Today we are nearly at launch position for tele-psychotherapy (to use the space exploration metaphor again). Our current treatment model, except in rural areas, presumes patients will come to our offices for visits. In the not too distant future, the usual visit will be virtual. This will enable patients to access care from anyplace they happen to be that has appropriate telecommunication links.

In the case of a disaster, whether natural or man-made, health care relationships will be established almost immediately by bringing in videoconferencing

and other telemedical equipment, if necessary, linked by remote satellite. When counseling is available immediately for victims, posttraumatic stress disorder will be prevented or diminished in at-risk populations.

Videoconferencing equipment will soon be on airplanes to calm nervous passengers, or support flight attendants handling challenging situations. Internet in real time will allow patients with phobias to find support as they fly. Such equipment will be on board ships, and even on space crafts!

Troops in combat will wear dog tags with lifetime medical histories; medics will carry small terminals to transmit this information to ships nearby, or to consultants across the ocean. Just as medically compromised patients will have access to improved immediate treatment, tele-psychotherapies will soon be supported for many emergencies.

Group therapies will be held with streaming video from disparate sites. Imagine the AA meeting with members from all seven continents.

If managed care has damaged the relationship between therapist and patient, tele-psychotherapy will promote healing of the wounds. Tele-treatment will restore the therapy relationship to the primacy it deserves, while the utmost of patient privacy will be guaranteed with encryption.

Someday we will have global conventions on licensing and global pacts on pharmaceutical distribution for people on the move.

Of utmost importance, should we develop and share our resources generously, is that rich and poor alike all over the globe could have access to the wisdom of our best clinicians. At last, worldwide excellent treatments are potentially an achievable goal, if only we make this our priority.

See Also the Following Articles

Cost Effectiveness ■ Economic and Policy Issues ■
Online or E-Therapy ■ Virtual Reality Therapy ■
Working Alliance

Further Reading

- Baer, L., Cukor, P., Jenike, M. A., et al. (1995). Pilot studies for use of telemedicine for patients with obsessive-compulsive disorder. *American Journal of Psychiatry*, 152, 1383-1385.
- Baer, L., Elford, D. R., & Cukor, P. (1997). Telepsychiatry at forty; what have we learned? *Harvard Review of Psychiatry*, 5, 7-17.

- Hawker, F., Kavanagh, S., Yellowlees, P., et al. (1998). Telepsychiatry in South Australia. *Journal of Telemedicine and Telecare*, 4, 187–194.
- Hill, J., Allman, L., & Ditzler, T. (2001). Utility of real-time video teleconferencing in conducting family mental health sessions: Two case reports. *Telemedicine Journal and e-Health*, 7, 55–59.
- Kennedy, C., & Yellowlees, P. (2000). A community-based approach to the evaluation of health outcomes and costs for telepsychiatry in a rural population: Preliminary results. *Journal of Telemedicine and Telecare*, 6 (suppl 1), 155–157.
- McLaren, P. M., & Ball, C. J. (1997). Interpersonal communications and telemedicine: Hypotheses and methods. *Journal of Telemedicine and Telecare*, 3, 5–7.
- McLaren, P. M., Blunden, J., Lipsedge, M. L., et al. (1996). Telepsychiatry in an inner-city community psychiatric service. *Journal of Telemedicine and Telecare*, 2, 57–59.
- McLaren, P., Mohammedali, A., Riley, A., et al. (1999). Integrating interactive television-based psychiatric consultation into an urban community mental health service. *Telecare Journal of Telemedicine and Telecare*, 5 (suppl 1), 100–102.
- Simpson, J., Doze, S., Urness, D., et al. (2001). Evaluation of a routine telepsychiatry service. *Journal of Telemedicine and Telecare*, 7, 90–98.
- Simpson, J., Doze, S., Urness, D., et al. (2001). Telepsychiatry as a routine service—the perspective of the patient. *Journal of Telemedicine and Telecare*, 7, 155–160.

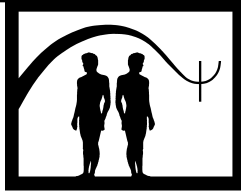

Termination

Georgiana Shick Tryon

City University of New York Graduate School and University Center

- I. Overview
- II. Theoretical Bases
- III. Empirical Research
- IV. Summary
- Further Reading

GLOSSARY

termination The end of psychotherapy.

All therapeutic relationships come to an end. This chapter discusses theoretical formulations and empirical findings concerning psychotherapy termination.

I. OVERVIEW

The ending of psychotherapy is commonly referred to as termination. The 1994 ethical standards of the American Psychological Association (APA) specify that therapists should terminate treatment with a client when the client does not require further therapy, or the client is not benefiting or is being harmed by continued service. Ideally, client and therapist make a mutual decision to discontinue therapy when the goals of treatment have been met.

In reality, however, the termination sometimes occurs because just one of the parties decides that it is time to

end treatment. Client and therapist do not always agree on when termination should occur. Termination is sometimes forced on both client and therapist. Neither party may wish to terminate, but one of them may be moving to a new location or agency, insurance policies may limit therapy to fewer sessions than client and/or therapist view as sufficient, or agencies may have a rigid session limit.

The APA ethical standards require therapists to discuss termination with their clients and to provide “appropriate pretermination counseling.” The nature of this pretermination counseling is not specified in the standards, but therapists are instructed to provide referrals for clients when appropriate. In 1994, Mathilda Canter and other colleagues who helped to construct the APA standards suggested that termination discussions should at least summarize the treatment and plan for the future. Oftentimes this future planning includes provision of referrals to other therapists and/or invitations to return to therapy in the future should the client encounter further difficulties.

II. THEORETICAL BASES

In 1993, Stephen Quintana summarized the major theoretical formulation of termination. He indicated that termination has been conceptualized from a psychoanalytic perspective as having two components—loss and development. The loss component was

hypothesized to sometimes reach crisis proportions. It has received some attention with researchers such as Hans Strupp and Jeffrey Binder stating in 1984 that therapists must work to ensure that clients do not suffer a relapse of symptoms because of the loss of their relationships with their therapists. Therapists are also hypothesized to be affected by their loss of relationship with clients. In 1981, Rodney Goodyear argued that therapists who had not grieved past losses sufficiently were most likely to be disproportionately saddened by termination with clients. Quintana stated that some theorists even believed that anxiety surrounding termination has led many researchers to avoid studying the process of termination altogether.

In 1933, Freud conceptualized that the loss triggered by psychotherapy termination facilitates the formation of an internal representation of the lost person (i.e., the therapist). The client compensates for the loss of the therapist by developing his or her own internal resources to replace what the therapist provided. Thus, termination is also viewed as a time of personal development. The client is viewed as maturing under the careful direction of the therapist much in the same manner that a child matures under parental guidance. When the client terminates therapy, he or she carries important internalized aspects of the relationship with the therapist that will facilitate the formation of new relationships with others.

Quintana updated this developmental conceptualization of termination to focus greater attention on the client's contribution to the therapeutic progress. He indicated that therapy is a process of continuing maturation of the client, and that termination is a time to call attention to the client's growth and the therapist's support of the client's progress. Quintana believed that termination is an opportunity to review the client's role in the therapeutic progress. In this way, the client clarifies what he or she did to facilitate change, and should problems arise after termination, the client may use these techniques to handle them. Finally, Quintana endorsed a conceptualization of termination as a sad time because of the loss of the relationship with the therapist that is tempered by the knowledge that the client has outgrown the relationship. Thus, termination represents a time to bid farewell to therapy and move on to new relationships. Quintana compared termination to graduation.

III. EMPIRICAL RESEARCH

Even though termination occurs in all therapy relationships very little research has been conducted on the

termination process. Simon Budman and Alan Gurman suggested in 1988, that for many clients, therapy is an ongoing activity in their lives. They presented evidence that the majority of clients have had previous therapy, and 50 to 66% of clients who terminate will return to therapy within a year. This would tend to dampen the loss felt at termination, because therapy would not really be terminated in the sense that most clients return for further help in the future.

In 1985, Judith Marx and Charles Gelso asked 72 former clients at a university counseling center to indicate the most common behaviors and feelings surrounding their therapy terminations. Over 70% of the sample stated that they and their therapists summarized the therapy, assessed goal attainment, and planned for the future. Contrary to expectations, clients indicated significantly more positive than negative emotions surrounding termination. Clients also reported that more termination work was done when loss had been a theme of therapy, when the client had a closer relationship with the therapist, and when there had been more therapy sessions. The results supported a developmental view of termination rather than a conceptualization of termination as a crisis or loss.

In 1992, Stephen Quintana and William Holahan extended Marx and Gelso's research to therapists by asking 85 therapists what termination activities they engaged in and having them rate their clients' reactions to termination. Each therapist was asked to choose two recent short-term therapy cases—a case in which the therapy outcome was successful and a case where the therapy outcome was unsuccessful. Like Marx and Gelso, Quintana and Holahan found that clients' reactions (as rated by their therapists) to therapy termination were significantly more positive than negative. Not surprisingly, in unsuccessful cases, clients were significantly more likely to devalue therapy. The ranking of termination activities by therapists corresponded closely to client rankings of activities in the Marx and Gelso study. In successful cases, however, therapists were more likely to discuss the course of counseling, client affective reactions to termination, and the end of counseling than in unsuccessful cases. This research suggested that therapists did a more complete job of discussing termination issues with clients from successful therapy cases than from unsuccessful cases.

In 1993, Susan Boyer and Mary Ann Hoffman tested the hypothesis that therapists' reactions to termination would be affected by the impact of previous losses in their lives and their perceptions of clients' sensitivity to loss. They asked 165 licensed psychologists each to

think of a client that they had seen for a minimum of 25 sessions. Therapists rated how sensitive they perceived these clients were to loss. Therapists also answered questions about their own grief reactions to past and present losses as well as questions about their perceptions and feelings surrounding termination with the client. They found that therapists' past grief reactions, present grief reactions, and perceived client loss predicted therapists' anxiety surrounding termination. Therapists' loss and perceived client loss, however, were unrelated to therapists' feelings of satisfaction with termination.

IV. SUMMARY

Termination is the capstone of psychotherapy. It should be a time when all that has gone before is discussed and solidified before the client leaves. Yet we know little about the process of termination. The results of the few studies of termination process suggest that for most clients and therapists psychotherapy termination is a relatively positive event rather than a traumatic loss. These findings support Qunitana's notion that termination serves a developmental function in which clients bid farewell to a relationship that they have outgrown. Loss appears to play a role in termination particularly when client and/or therapist have suffered past or present losses. In these cases, therapists are frequently more anxious about terminating, and loss is an important part of client-therapist termination discussions.

Study results show that most termination discussions cover what transpired during treatment, participants' feelings, and plans for the future. This seems to be particularly true when the outcome of therapy has been positive. When therapy has not been as successful, however, there is less discussion of the end of therapy, clients' reaction to termination, the course of therapy, and the client-therapist relationship. Thus, unsuccessful therapy is mirrored in a less thorough termination experience.

Much more research on the psychotherapy termination process is needed. Many variables need to be explored relative to termination. In particular, it is important to study client and counselor characteristics as they relate to the termination process.

See Also the Following Articles

Bioethics ■ Cost Effectiveness ■ Engagement ■
 Informed Consent ■ Outcome Measures ■
 Relapse Prevention ■ Resistance ■ Working Alliance

Further Reading

- Gelso, C. J., & Woodhouse, S. S. (2002). The termination of psychotherapy: What research tells us about the process of ending therapy. In G. S. Tryon (Ed.), *Counseling based on process research: Applying what we know*. Boston: Allyn and Bacon.
- Hill, C. E., & O'Brien, K. M. (1999). *Helping skills: Facilitating exploration, insight, and action*. Washington, DC: American Psychological Association.

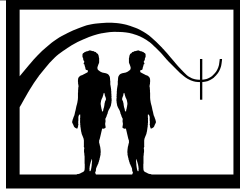

Therapeutic Factors

T. Byram Karasu

Albert Einstein College of Medicine/Montefiore Medical Center

- I. Introduction
 - II. Nonspecific Therapeutic Factors
 - III. Specific Therapeutic Factors
 - IV. The Relationship as a Therapeutic Factor
 - V. An Integration: The Past and the Future
- Further Reading

spiritual therapy A form of treatment based on six tenets of transcendence of soul and spirit—love of others, love of work, love of belonging, belief in the sacred, belief in unity, and belief in transformation.

GLOSSARY

analytic (or psychodynamic) therapy A primarily long-term, in-depth treatment concerned with conflictual intrapsychic forces, especially early libidinal urges and repressed childhood memories, which are uncovered and worked through via the interpretation by the analyst of the meaning of the patient's verbalizations.

behavior therapy (or behavior modification) Techniques of conditioning, shaping, and/or training—usually active, structured, time-limited, and directive—for the alteration of maladaptive symptoms and behaviors.

cognitive therapy A form of behavior therapy that addresses irrational beliefs and distortions of thinking, based on the fundamental idea that how a person perceives and structures the world determines personal feelings and behaviors.

existential approach (or analysis) A form of therapy that posits that a person's decisions, commitment, and responsibility for "choosing the future" give meaning to life, whereas choosing the past leads to boredom, meaninglessness, and despair.

interpersonal therapy A form of treatment that focuses on current life events—especially grief, developmental transitions, role disputes, and social deficits—based on the fundamental thesis that disorders are the result of unsatisfactory relationships and social maladaptation, the consequence of the individual's attempts to adapt to surroundings.

I. INTRODUCTION

In an attempt to comprehend therapeutic factors in the total range of psychological treatments, one needs to differentiate the nonspecific elements that all psychotherapies are presumed to share, and the specific elements that may distinguish one school from the others. This article discusses the former under the headings of affective experiencing, cognitive mastery, and behavioral regulation, and the latter under the headings of analytical, behavioral, and experiential schools, each with its own variations. The therapeutic aspect of the therapist–patient relationship is discussed in its various forms: transference and working alliances, and teacher–pupil and person-to-person relations. In clinical practice, these therapeutic factors are not categorical distinctions, but overlapping phenomena. An integration of past and present therapeutic factors is proposed.

II. NONSPECIFIC THERAPEUTIC FACTORS

The following features have been repeatedly cited as basic to all psychotherapies: an emotionally charged,

confiding relationship; a therapeutic rationale (myth) that is accepted by patient and therapist; the provision of new information, which may be transmitted by precept, example, and/or self-discovery; the strengthening of the patient's expectation of help; the provision of success experiences; and the facilitation of the arousal of one's emotions. In their 1980 comprehensive analysis of the benefits of psychotherapy, Mary Lee Smith, Gene V. Glass, and Thomas I. Miller concluded that the weight of the evidence that now rests in the balance so greatly favors the general factors interpretation of therapeutic efficacy that it can no longer be ignored. Thus, above and beyond (or in addition to) the specific features of major modalities that technically differentiate them from one another, a number of universal conditions of therapeutic change have been hypothesized that unite all forms of treatment.

Aside from equivocal research findings from extensive comparison studies of outcome, other lines of support have been cited for a universality thesis. These include cross-cultural, historical, and religious examinations of the recurrent nature of healing agents, particularly the "placebogenic" roles of suggestibility, persuasion, trust, and hope, in changing or curing patients throughout the ages; the paucity of proof that special technical skill, type of training, theoretical orientation, or professional discipline is significantly related to therapeutic results; and, within the past decade, controlled studies of some commonly shared ingredients of successful outcome.

A. Affective Experiencing

Some form of strong emotional arousal was probably the primary tool in the psychotherapeutic cures of primitive man. Often seances were conducted in the presence of a select group of individuals (the psychotherapists of their day), and emotional excitement was induced through smoking, drinking, drugs, and rhythmic music. Such affectively charged situations facilitated patient regression and eased the confession of sins. This type of affective purging process was the prototype for the earliest known structured psychotherapeutic attempt to deal with man's problems.

The specific Freudian version of this was the now-classic "cathartic method," whereby abreaction occurred, with the emergence of repressed memories through the technique of free association. Behavior therapies have also had their affective counterparts in reproducing anxiety-evoking stimuli in imagination or *in vivo* (with or without the accompaniment of relaxation techniques for purposes of systematic desensitization).

Flooding and implosion procedures, for example, re-create high-intensity exposure to feared objects or situations, with the expectation that patients will experience their anxiety as fully as possible and, exhausted with fear and relief, will no longer respond as they used to. Similarly, aversion therapy, by presenting an unpleasant and sometimes painful stimulus, at least temporarily disrupts emotional equilibrium as a precursor of change through reconditioning.

By far the most extensive resurgence of the therapeutic use of emotional arousal and release occurs in the "experiential" approaches. Reichian therapy, Lowenian bioenergetics, and Rolfian structural integration aim to express the affect trapped in the body posture not by analyzing defensive character armor as Wilhelm Reich originally did, but by physically manipulating the muscles that underlie it. Psychodrama enacts the expression of feelings through dramatic improvisations, while uninterrupted lengthy marathon sessions seek emotional access through the by-products of physical exhaustion. Comparably, primal scream and Morita use prolonged isolation and sensory deprivation to lower resistance and break down cognitive defenses—the former expressed in a sobbing, screaming, seizurelike episode to recapture the pain of the primal past, the latter by activating anxiety and distress as a preparatory step toward the creation of a state of spiritual readiness for rediscovering the beauty of life. A basic rationale for such diverse methods is that they aim to facilitate therapeutic change by producing excessive cortical excitation, emotional exhaustion, and states of reduced resistance or hypersuggestibility.

Emotional arousal is one of the major effective ingredients of successful psychotherapy. Following a strong abreaction, there occurs a period of exhaustion that produces heightened acceptance in which the patient appears bewildered, dependent, and eager to find a comforting solution from the therapist. Three experiments by Rudolf Hoehn-Saric in 1978 showed that heightened arousal made patients more receptive to suggestion and therefore more willing to change attitudes than they were under low-arousal conditions. Arousal combined with cognitive confusion yielded even better results than arousal in patients with undisturbed cognitive functions. Heightened arousal under conditions of cognitive disorganization helped to "unfreeze" attitudes necessary for change. Thus, affective experiencing—as a universal change agent in the psychotherapies—may be globally defined as arousing excitement and responsiveness to suggestion: unfreezing and expression of feelings.

The major roles and functions of affective experiencing thus are to set the emotional state for receptivity to

change, to ease the cathartic release of repressed material, and to facilitate patient accessibility by reducing resistance and breaking down defenses. In short, the patient, through the dislodging of persistent chronic attitudes, is made more available for a new cognitive paradigm. However, Hoehn-Saric's results also reflect the finding (often observed clinically) that intense emotional arousal, however profound and necessary to set the stage for therapeutic change to occur, is difficult to sustain. Attitude changes that occurred were short-lived, and repeated interventions were required for such change to be established into a more stable new position. This observation parallels Sigmund Freud's earlier acknowledgment of the limitations of the cathartic method and his significant theoretical transition from release of repressed affects and traumatic memories to their systematic exploration and understanding, that is, from catharsis to insight as the ultimate aim of therapy. It is also consistent with the research conclusion that although heightened arousal under conditions of cognitive organization helps to unfreeze an attitude, it does not necessarily lead to a new solution unless it is followed by cognitive learning.

That is, perhaps the major role of affective experiencing is to emotionally prepare the patient for new cognitive input. Indeed, pure catharsis is considered most effective only in certain limited psychiatric conditions. Moreover, "peak experiences," which may offer attractive opportunities for rapid change, often do not carry over beyond the immediate encounter. In fact, when three therapy groups of differing duration were compared, the curative value of catharsis appeared to diminish in the longest-term group. Thus, some form of affective experiencing appears to be universally applicable, but perhaps largely as a preliminary stage of treatment. Ideally, this means that it should be succeeded by, or combined with, other therapeutic agents that have complementary roles and functions, to maximize or prolong its effectiveness.

B. Cognitive Mastery

All therapies, in some measure, provide the patient with cognitive mastery, whether they offer the classical, well-timed interpretations of Freudian psychoanalysis or, as in Albert Ellis's rational-emotive therapy, have the therapist "sing along" with the patient a litany of the patient's irrational false beliefs. Cognitive mastery thus refers to those aspects of treatment that use reason and meaning (conscious or unconscious) over affect as their primary therapeutic tools, and that attempt to achieve

their effects through the acquisition and integration of new perceptions, thinking patterns, and/or self-awareness. A prototype of a cognitive change agent is the therapeutic application of insight, defined as the process by which the meaning, significance, pattern, or use of an experience becomes clear—or the understanding that results from this process.

Historically, primitive faith healing and the early stages of psychotherapy were very much alike in that neither initially attempted to provide insight. However, while faith healing continued only to maximize suggestion (essentially through affective experiences), Western psychotherapy became distinctive in departing from the primitive mode by moving into a second state—to correct problems by explaining them rationally. Going somewhat farther along this line, although the foundation of all therapies is the phenomenon of therapeutic suggestibility, primitive therapies are based almost entirely on irrational belief and dependency, whereas Western scientific therapies are more often founded on rational insight and independence.

Insight (through free association and interpretation) has been considered a *sine qua non* of the psychoanalytic process, yet all psychotherapies provide opportunities for change through cognitive channels—by means of explanation, clarification, new information, or even confrontation of irrational and self-defeating beliefs. Behavior therapies, once considered the antithesis of an insight-oriented approach, have increasingly incorporated cognitive learning techniques into their repertoire. Over time the behavioral model of treatment has radically changed from that of conditioning to social learning and information processing. The behavioral technique of thought stopping developed by David Wolpe, a cognitive variation of classical conditioning methods to extinguish anxiety, can be considered an early example of this change in approach. Albert Ellis's rational-emotive therapy, William Glasser's reality therapy, and Aaron Beck's cognitive therapy all share in direct attempts to correct stereotyped, biased, or self-defeating thinking patterns and dysfunctional attitudes and values, whereas others, like Victor Frankl's logotherapy and William Sahakian's philosophical therapy, are directed to the most profound cognitive reappraisals of life and its meaning. Even the most actively experiential therapies use cognitive techniques; for example, Gestalt "experiments" can be considered cognitively as a structured interpretation.

Thus, cognitive mastery as a universal therapeutic agent may be defined as acquiring and integrating new perceptions, thinking patterns, and/or self-awareness,

whether this is effected through interpretations, explanations, practical information, or direct confrontation of faulty thoughts and images. In contrast to affective experiencing, it serves as a rational component of treatment—to inform, assess, and organize change and to establish or restore ego control. Despite their therapeutic utility in providing a new perspective, meaning, or way of thinking, cognitive approaches are not always sufficient as change agents. Put succinctly, not all change is attributable to insight and not all insight leads to change.

In the final analysis, the criteria for attaining lasting insight must be judged by its personal and social consequences. In short, new thinking (or insight) that has been achieved in therapy must be worked through and incorporated into one's actions and behavior in everyday life; it must be transferred from the structured and safe confines of the therapist's office and put into active practice in the real world outside treatment. Thus, cognitive mastery, like affective experiencing, needs to be complemented by other therapeutic change agents. More specifically, although an affective experience may prepare the patient for cognitive learning, the latter requires gradual assimilation and behavioral application of new input, if therapeutic effects are to endure.

C. Behavioral Regulation

Behavior modification approaches have directly sought behavioral change as an active goal, and learning to self-regulate or control one's habitual responses has become the thrust of their therapeutic efforts. Methodologically, this has meant the use of an extensive repertoire of reinforcement and training techniques based on research in experimental animal and human social learning laboratories—from classical conditioning to explicit rewards and punishments, to shaping and modeling methods in imagination and *in vivo*.

Nonetheless, as already implied, behavioral regulation as a major change agent is no longer limited to the classical confines of a conditioning model; nor is it restricted to the immediate territory of the behavior therapies. Even psychoanalysis, which has been considered relatively weak as a model for behavioral change, and whose therapists must ideologically refrain from direct suggestion or deliberate manipulation, is by no means exempt from the use of behavioral regulation, at least implicitly. All therapies, albeit in less systematic and sometimes unintentional ways, use methods of behavioral reinforcement, feedback, and modeling. Analytic interpretation influences behavior by labeling, defining a problem, providing permission, implying a course of action, facilitating foresight, and the like. Indeed, re-

search has experimentally demonstrated that subtle cues can shape the responses of patients. Examination of actual excerpts of Carl Rogers's so-called nondirective therapy confirmed that even incidental nods or "hmmms" by the therapist positively reinforced client responses. On a more inaccessible level, unconscious identification with the therapist is considered an essential aspect of shaping and modeling the patient's behavior. In the final analysis, all therapy may be a matter of emotional, cognitive, and behavioral learning.

III. SPECIFIC THERAPEUTIC FACTORS

Although universal features undoubtedly exist, this does not mean that we must *ipso facto* minimize differences in psychotherapy. There are comparative conceptual studies of various forms of psychotherapy that typically cite striking contrasts among them. More recently, experimental studies of different schools have lent some scientific support to the separatist stance. Exemplary of such findings are the systematic studies of analytically oriented psychotherapy versus behavior therapy, supporting the view that these are highly contrasting styles of treatment. Moreover, the treatment procedures created, developed, and chosen in one society or within the context of a particular belief system, may not be transposable to another. This is especially evident in attempts at cross-cultural psychotherapy.

The current state of the art attests to the lack of clarity and lack of resolution of the specificity versus non-specificity controversy in explaining what is the quintessence of the therapeutic cure. This conflicting state of affairs is further compounded by comparative studies of various psychotherapies, which suggest that one's espoused theoretical orientation regarding the nature of the healing process may not always be synchronous with one's actual practices. In a comparison research study of Freudian, Kleinian, Jungian, and Gestaltist therapists, descriptive ratings of the different approaches in action did not differentiate the respective schools of thought, the investigators (and, no doubt, the proponents themselves) naturally expected.

A. Analytical Schools

For the analytic therapist the ultimate task, in its most parsimonious and famous form, is to make conscious the unconscious. The ongoing therapeutic charge is to facilitate the emergence and comprehension of unconscious content. That is, such a therapist seeks to

undo the repressed material of the patient and to overcome the patient's natural resistances to this endeavor. The therapist attempts to accomplish this by means of a slow and scrupulous unraveling of the largely historical meanings of mental events and the characteristic ways in which they may serve to ward off the underlying conflicts through defensive camouflage. Understandably, the analytic goal is thereby a long-range one, perhaps even interminable. At best this concept of cure means opting for total personality reorganization in the final resolution of neurotic conflicts. The most crucial manifestation of this is the resolution of the Oedipal conflict, which is traditionally regarded as requisite for a healthy personality. This ultimate integration of personality would translate itself into final mastery of ego over id impulses or, as classically stated by Freud, "where id was, there ego shall be."

There are believed to be four successive stages in attaining therapeutic insight: (1) preparation, which is characterized by frustration, anxiety, a feeling of ineptness, and despair. It may be accompanied by much trial-and-error activity relevant to the solution of a certain problem and the falling into habitual patterns or ways of thinking, foreseeing no apparent solution to the problem; (2) incubation or renunciation, in which one desires to hide or escape from the problem and is resistant or unmotivated in therapeutic or insightful efforts; (3) inspiration or illumination, in which the whole problem becomes illuminated, and a solution or solutions suggest themselves (often there is a flood of vivid ideas and a sense of finality accompanied by a conviction in the truth of the insight); and (4) elaboration and evaluation, in which the validity of the insight is checked against external reality.

Furthermore, insight is most therapeutic when it meets all of the following specifications: (1) consistency, whereby the deductions based on the original insight are stable and logically sound, regardless of the truth or falsity of the particular content of the insight; (2) continuity, whereby insights must take place within some existing theoretical framework or stream of tradition in which the insight can be tested; (3) personal consequences, whereby the insight must be judged by the fruit it bears in terms of the ultimate use to which the insight is put; and (4) social consequences, whereby the acquisition of insight should allow the person to interact with others in a more honest and meaningful manner.

1. Variations on the Analytical Theme

The prototypic embodiment of the psychoanalytic or psychodynamic theme is, of course, classical psychoanalysis. The variations on the dynamic theme reflect

overt and covert modifications of theoretical conceptualizations as well as methodological and technical applications in practice. These include attempts to partially or completely transcend the biological focus of Freud with more interpersonal, social, ethical, and cultural considerations (e.g., Alfred Adler, Karen Horney, Harry Stack Sullivan, Erich Fromm, Frieda Fromm-Reichmann, and Alfred Meyer); to extend or enhance the ego with earlier or more adaptive endowments (e.g., Federn and Melanie Klein); to enlarge man's temporality with a time focus on his primordial past (e.g., Jung), his present and/or his future (e.g., Adler, William Stekel, Otto Rank, and Rado); to expand treatment procedures by altering the range and goals of treatment (e.g., Otto Rank, Franz Alexander, Helena Deutsch, and Albert Karpman); to shift from ego to self psychology (e.g., Heinz Kohut), to narcissism as a character disorder (e.g., Otto Kernberg) to develop guidelines for short-term psychotherapy with anxiety-provoking techniques (e.g., Peter Sifneos), and even brief treatment of serious illness within the context of a single interview (e.g., David Malan); to revise the role of the therapist's personality and relationship to the patient by making the therapist a more direct, flexible, and/or active participant (e.g., Adler, Sullivan, Rank, Alexander, Stekel, Sandor Ferenczi, and Victor Rosen); to emphasize the developmental approach to diagnosis and treatment (e.g., T. Byram Karasu, James Masterson) at perhaps the opposing end of the analytic spectrum, to restore the psychophysical balance of man by focusing equally on the physical half of the psychophysical split (e.g., Sandor Rado and Jules Masserman) and/or substituting an approach to therapeutic cure from the somatic side by trading the traditional change mode of insight for a reversal back to the earlier catharsis by means of the bodily release of conflictual tensions (e.g., Wilhelm Reich).

The fundamental goals of the interpersonal approach relate to the need to maintain good interpersonal relations and social adaptability; they include reconstruction of present maladaptive relationships and, where possible, restoration of past losses. This means both coping with immediate stressful interactions and forming better or new relationships by developing problem-solving strategies and mastery in social skills. In 1984 Gerald Klerman and Myrna Weissman formulated a short-term, manualized form of interpersonal therapy (IPT), specifically applicable, but not limited to, depression.

In practice, a seasoned dynamic therapist is more broadly defined. This refers to the integration of drive, ego, object relations, and self approaches, and to the more global synthesis of conflict and deficit models.

This integrative model of psychotherapeutic practice acknowledges the joint impact on psychic structure formation of unresolved conflictual urges and wishes interfaced with early environmental deficiencies and traumas in the real-object world of the patient. In terms of treatment, it recognizes the pivotal roles of both erotic and narcissistic transferences in the therapist–patient relationship and in the respective stances and strategies of the listening and empathic presence.

B. Behavioral Schools

For the behaviorist, all problems are construed as pedagogical in nature, and therefore alterable only through direct teaching and learning of new behavioral associations, that is, stimulus–response connections. The patient must be taught new alternatives that have to be repeated and practiced within as well as outside the therapy situation. These alternative modes of functioning do not occur simply as a concomitant of cognitive or emotional understanding of one’s problems—the patient needs to rehearse the new alternatives directly. Thus, in direct contrast to the psychodynamic schools, the behavioral approaches have tended to sustain the view that insight is not only unnecessary but can hinder the treatment of deviant behavior.

One implication of the behavioral view of the mode of therapeutic action is that change can presumably occur within a short period of time. In contrast to the dynamic therapists, behaviorists generally believe that all treatment of neurotic disorders is concerned with habits existing in the present, and their historical development is largely irrelevant. Moreover, some behaviorists have even suggested that it is possible to have a situation in which symptoms have been removed, with no knowledge at all their etiology.

Although all behaviorists may be viewed as seeking change through direct conditioning, shaping, or training, the classical conditioning paradigm sees all therapeutic learning or change (not just behavior therapy) as occurring within the reciprocal inhibition framework, incorporating the substitution of relaxation for anxiety in the reduction or elimination of symptoms. However, more critically, the difference between behavior therapy and other therapeutic modalities is that in the latter, counterconditioning of relaxation over anxiety occurs indirectly unsystematically, whereas in behavior therapy this process is overt, systematic, and under the direct control of the therapist.

In Jan Ehrenwald’s 1966 words, the behavioral schools of psychotherapy actively relinquish “the methods of the

couch” and replace them with “the methods of the classroom and the pulpit.” Behavior therapists have at their disposal a large variety of conditioning, training, and other directive techniques. This repertoire may include any or all of the following: the more classical conditioning techniques of systematic desensitization combined with deep muscle relaxation, implosion, or assertiveness training; the operant techniques of positive or negative reinforcement, such as aversiveness training; shaping or modeling; and/or the direct transmission of advice, guidance, persuasion, and exhortation. The latter methods more typically reflect the means by which behavior modification has been extended recently to the teaching or conditioning of attitudes underlying specific behaviors, methods of philosophical indoctrination, or cognitive programming.

The behavioral counterpart of the psychodynamic procedure of working through is behavioral rehearsal within the confines of therapy, as well as assignments to be worked on outside of therapy; these are important parts of the total regimen. For example, the patient might be directly trained in certain social skills that may first be role-played or rehearsed within the course of therapy, and then explicitly instructed and tested out in outside, real-life situations, and reviewed in subsequent sessions.

1. Variations on the Behavioral Theme

Three broad types of behavior therapies or behavior modification are considered under the umbrella of the behavioral theme: one, based on the early classical Pavlovian paradigm, primarily uses systematic desensitization or extinction of anxiety techniques (e.g., reciprocal inhibition therapy); a second type, based on an operant paradigm, uses direct reinforcement by means of reward/punishment procedures (e.g., token economy); and a third type, based on a human social learning paradigm, is contingent on direct modeling or shaping procedures (e.g., modeling therapy). The last type extends to a variety of new systems of directive psychotherapy that expressly aim at attitudinal or philosophical restructuring, albeit using methods of the behaviorist’s laboratory. Such so-called integrity therapies share the fundamental learning or problem-solving stance, yet are usually more actively advisory and/or exhortative in their therapeutic techniques (e.g., Albert Ellis’s rational therapy, William Glasser’s reality therapy, and William Sahakian’s philosophic psychotherapy).

Another way of viewing the scope of these behavioral variations is through the evolution of their targets of change, from external to internal alterations in man’s learnings. The earlier behavior therapeutic systems

addressed overt behaviors and fears (e.g., Wolpe); the more recent systems are directed to more covert values and beliefs (e.g., Ellis). The most contemporary approaches even venture into the reaches of inaccessible and involuntary mental and physiological states and responses, such as heart rate, blood pressure, and brain waves (e.g., biofeedback).

Whereas in typical behavior modification, alterations in overt behavior are viewed as an end in themselves, with the cognitive approach they are considered a means to cognitive change. In 1979, Aaron Beck formulated a short-term, manualized form of cognitive-behavior therapy (CBT). The goals of this approach have been succinctly stated as: (1) to monitor negative, automatic thoughts (cognitions); (2) to recognize the connections between cognition, affect, and behavior; (3) to examine the evidence for and against the distorted automatic thoughts; (4) to substitute more reality oriented interpretations for these biased cognitions; and (5) to learn to identify and alter the dysfunctional beliefs that predispose the person to distort his or her experiences.

The major cognitive aims or processes of change have four successive components: recognition of faulty thinking through self-monitoring, modification of thinking patterns through systematic evaluation, empirical testing of the validity of automatic thoughts and silent assumptions, and self-mastery by means of homework and everyday practice on one's own. The initial phase of treatment, which aims at symptom reduction, emphasizes the recognition of self-destructive thoughts, whereas the subsequent phases, which aim at prophylaxis, concentrate on the modification of specific erroneous assumptions within and outside the treatment sessions. To isolate, control, and change illogical thinking—the cognitive concept of cure, treatment is organized to elicit and subject to rational examination the actual mental contents of conscious depressive ideation (current automatic thoughts, silent assumptions, attitudes, values, daydreams) and to trace their impact on dysphoric feelings and behaviors in current concrete situations. CBT has recently been applied to disorders other than depression. Its ultimate purpose is self-control and self-mastery—patients explicitly rehearse and train themselves to recognize and restructure their own faulty cognitions so that they can cope better in the future.

C. Experiential Schools

The experiential schools of psychotherapy trade intellectual cognition and insight for emotion and experi-

ence, forsaking the there and then of the distant past for the here and now of the immediate present. Experiencing is a process of feeling rather than knowing or verbalizing; occurs in the immediate present; is private and unobservable, but can be directly referred to by an individual as a felt datum in his own phenomenal field; acts as a guide to conceptualization; is implicitly meaningful, although it may not become explicitly so until later; and is a preconceptual organismic process. The many implicit meanings of a moment's experiencing are regarded not as already conceptual and then repressed; rather, they are considered in the awareness but as yet undifferentiated. Here therapeutic change occurs because of a process of experiencing in which implicit meanings are in awareness, and are intensely felt, directly referred to, and changed—without ever being put into words.

One variation of this thesis, especially applicable to Roger's client-centered therapy, reflects the underlying positive belief that every organism has an inborn tendency to develop its optimal capacities as long as it is placed in a optimal environment. The patient is offered an optimistic self-image and the understanding that the patient is basically good and full of potential. Therefore, the therapist does not need to challenge or shape the patient, only to offer a warm and understanding milieu that will enable the patient to unfold latent potentials.

Unlike transference, which is dependent on the revival of a former interpersonal relationship, experiential encounter works through the very fact of its novelty. Through encounter the therapist serves as a catalyst in whose presence the patient comes to realize his or her own latent and best abilities for shaping the self. In this behalf, there are schools of psychotherapy within the experiential theme that recoil at the idea of therapeutic technology. These schools, which are predominantly existential, renounce technique as part of their philosophy of understanding human existence. They feel that the chief block in the understanding of man in Western cultures has been an overemphasis on technique and a concomitant tendency to believe that understanding is a function of, or related to, technique. Rather, they feel that what distinguishes existential therapy is not what the therapist would specifically do, but rather, the context of the therapy. In other words, it is not so much what the therapist says or does, as what the therapist is. However, in this regard the existential schools of psychotherapy have been criticized for their vagueness about technical matters in the conduct of psychotherapy.

The experiential schools aspire to flexibility or innovation in their actual methods, as long as these methods

are useful in the therapist's attempt to experience and share the being of the patient. Here the aim of all techniques would be to enter the phenomenological world of the patient. In direct contrast to the view of the analytic therapist, the experiential therapist does not concern himself or herself with the patient's past, the matter of diagnosis, the aspiration of insight, the issue of interpretation, or the subtle vicissitudes of transference and countertransference. Unlike the behavioral therapist, the experiential therapist expressly does not set goals for the patient and does not direct, confront, or otherwise impose his or her personality on the patient with directives in the form of behavioral instructions or problem-solving preferences.

Although they share the same basic faith in the therapeutic encounter and an emphasis on feelings, schools under the experiential umbrella are often antiverbal in approach. Such schools (e.g., Gestalt therapy) view overintellectualization as part of the patient's problem, that is, a manifestation of defense against experiencing or feeling, and discourage it as part of the therapeutic endeavor. These therapies attempt to accentuate activity over reflection, emphasize doing rather than saying, or, at the minimum, aim to combine action with introspection. The goal of experiencing oneself includes developing the patient's awareness of bodily sensations, postures, tensions, and movements, with an emphasis on somatic processes. Awareness of oneself as manifested in one's body can be a highly mobilizing influence. The main thrust of therapy is therefore to actively arouse, agitate, or excite the patient's experience of self, not simply to let it happen.

Among the techniques for expressing one's self-experience in such schools is the combination of direct confrontation with dramatization, that is, role-playing and the living out of a fantasy in the therapeutic situation. This means that under the direction (and often the creation) of the therapist, the patient is encouraged to play out parts of the self, including physical parts, by inventing dialogues between them. Performing fantasies and dreams is typical and considered preferable to their mere verbal expression, interpretation, and cognitive comprehension. In variations of the somatic stance, body and sensory awareness may be fostered through methods of direct release of physical tension, and even manipulations of the body to expel and/or intensify feeling.

In yet other attempts to unify mind, body, and more especially, spirit, the immediate experience of oneself by focusing on one's spiritual dimension is sought. This is most often accomplished through the primary technique of meditation. The ultimate state of profound

rest serves to transcend the world of the individual ego, forming a higher reality or state of consciousness that the individual ego subserves. Major methods of will training and attention focused on a special word sound or mantra, for example, serve to create an egoless transcendent state.

1. Variations on the Experiential Theme

The therapeutic systems that have evolved under the experiential theme represent various approaches, each propelled by the immediate moment and geared toward the ultimate unity of man. These include the following: (1) a philosophic type, which reflects existential tenets as a basis for the conduct of psychotherapy and pivots on the here-and-now mutual dialogue, or encounter, while retaining essentially verbal techniques (e.g., Carl Roger's client-centered therapy and Victor Frankl's logotherapy); (2) a somatic type, which reflects a subscription of nonverbal methods and aspiration to an integration of self by means of focusing attention on subjective body stimuli and sensory responses (e.g., Fritz Perls' Gestalt therapy) and/or physical motor modes of intense abreaction and emotional flooding in which the emphasis is on the bodily arousal and release of feeling (e.g., Alexander Lowen's bioenergetic analysis and Janov's primal scream therapy); and, finally, (3) a spiritual type, which emphasizes the final affirmation of self as a transcendental or transpersonal experience, extending one's experience of self to higher cosmic levels of consciousness that ultimately aim to unify one with the universe. This is primarily accomplished by means of the renunciation of the individual ego. The establishment of an egoless state can occur by meditation (i.e., relaxation plus focused attention) in which one reaches a state of profound rest (e.g., Transcendental Meditation). Such a spiritual synthesis may be amplified by various techniques of self-discipline and will training, for example, practice of disidentification (e.g., Assagioli's psychosynthesis).

A most recent "variation on a theme" crosses the boundaries of the above three schools. Dialectical Behavior Therapy (DBT), originated by Marsha Linehan, Ph.D., in 1993, empirically supported multimodal psychotherapy, initially developed for chronically parasuicidal women diagnosed with borderline personality disorder (BPD). DBT blends standard cognitive-behavioral interventions with Eastern philosophy and meditation practices, as well as shares elements with psychodynamic, client-centered, Gestalt, paradoxical, and strategic approaches. DBT structures the treatment hierarchically in stages. It is based on Linehan's biosocial theory, whereby

etiology of this dysfunction lies in the transaction between a biological emotional vulnerability and an invalidating environment.

IV. THE RELATIONSHIP AS THERAPEUTIC FACTOR

The patient's relationship to the therapist embodies one of the most powerful forces in the therapeutic enterprise. Psychotherapeutic changes always occur in the context of an interpersonal relationship and are to some extent inextricable from it. In the next section, these therapeutic relations are discussed under the three headings of transference-therapeutic; teacher-pupil; and person-person. Again, they are far from being categorical distinctions. Rather, they simultaneously occur in different combinations and emphases.

A. Transference Relations and Working Alliances

Deliberate, systematic attention to the vicissitudes of the special relationship between therapist and patient is crucial to the conduct of the psychoanalytic approach. It constitutes both the subject and the object of analysis. Historically, two stances—transference versus nontransference—have been described in portraying the psychodynamic psychotherapies: the primary stance with regard to the making of the transference relationship and, more recently, the secondary stance with regard to the making of a working or therapeutic alliance. Despite increasing acceptance of combining them in the therapeutic situation, these represent dual postures, even antithetical to each other, both in their essential purposes and in the actual requirements they make of the therapist.

The primary stance reflects Freud's original recommendations: (1) that the analyst be like a mirror to the patient, reflecting only what is reflected by the patient and not bringing personal feelings (attitudes, values, personal life) into play; and (2) that the analyst follow a posture of privation or rule of abstinence, that is, technical motives must unite with ethical ones in preventing the therapist from offering the patient the "love" that the patient will necessarily come to crave. These two basic requirements are traditionally made of the analyst, if the analyst must remain relatively removed and anonymous, a deliberately dispassionate observer and reflector of the patient's feelings. Such a therapeutic relationship is necessarily asymmetrical.

Conversely, the more recent concept of a working or therapeutic alliance reflects an alternatively nonregressive, rational relationship between patient and therapist. Although still in the service of analyzing transference and resistances, it means that the therapist aims at forming a real and mature alliance with the conscious adult ego of the patient and encourages him or her to be a scientific partner in the exploration of these difficulties. The real object need of the patient, deliberately frustrated by the transference relationship, is relatively satisfied by the therapeutic alliance. This therapeutic alliance has several variations and names, that is, working alliance, holding environment, corrective relationship, and empathic relationship. For example, self psychology introduced a new concept to psychology—the self, an experiential construction, the perceiver's own experience. Here the therapist provides an empathic atmosphere to foster development of a coherent self, and facilitates not so much insight as transmuting internalization, to crystallize the self. He or she is therapeutic through contemporary self-object functions for the self within an interpretive framework.

B. Teacher-Pupil Relations

The nature of the therapeutic relationship between therapist and patient in the behavioral therapies is an essentially educative, teacher-pupil relationship. It is a deliberately structured learning alliance in which, at its best, attention is drawn to the more current and presumably constructive aspects of the patient's personality in collaborating on the course of therapy. Here the behavior therapist has been depicted as a learning technician or social reinforcement machine. Although this rubric may apply to all therapies to greater or lesser degrees, usually the behavioral therapist openly regards him or herself as an instrument of direct behavioral influence or control, one who directly and systematically manipulates, shapes, and inserts individual values in the therapeutic encounter. In a comparable context, the therapist shapes personal behavior so as to be a social reinforcer for the patient. If the therapy does not proceed smoothly or effectively, the behavior therapist revises the behavioral plan or schedule to better fit the patient to treatment.

Behavior therapy deliberately does not dwell on the therapist-patient relationship; at most, it does so secondarily, only to the extent that this is seen to be important in securing the patient's cooperation with the therapist's treatment plan. The behavior therapist's use of warmth, acceptance, and any other relationship

skills is common but relegated to the realm of secondary “relationship skills” that are not crucial therapeutic requirements for desired change to occur in the patient.

The term *collaborative empiricism* has been coined to characterize the major therapeutic relationship in cognitive therapy—CBT, a specific form of behavior therapy for treatment of depression—in which the therapist is continually active and deliberately interacting with the patient. The two participants have been further depicted as an investigative team; the content of each depressed thought is posed as a hypothesis to be tested by two scientists, who collect all the evidence to support or refute that hypothesis. Under the collaborative empiricism model, the major role of the therapist is primarily educative—to instruct and advise the patient in rational thinking and to provide active guidance during systematic reality testing, which is considered intrinsic to the cognitive approach. The therapist actively points out automatic thoughts, helps to identify cognitions from the patient’s report of recent experiences, reviews patient records, assigns homework, and provides concrete feedback. Often part of this tutorial approach is a direct problem-solving, question-and-answer format, with which the therapist and patient can jointly explore the patient’s cognitions.

Interpersonal therapy (IPT) shares elements with both the psychodynamic and cognitive approaches as it addresses four major foci or problem areas: interpersonal role disputes, especially between family members; difficult role transitions in coping with developmental landmarks or significant life events, such as getting married or divorced, having a child, changing careers or retiring from work; interpersonal deficits, including inadequate social skills; and abnormal grief reactions. It emphasizes the solving of interpersonal problems and entails supportive and behavioral strategies as well as both directive and nondirective exploratory methods—information, guidance, reassurance, clarification, communication skills education, behavioral modification, and environmental management. Didactic education techniques and environmental interventions are largely used in initial efforts to ameliorate overt symptoms, whereas support, exploration, behavioral modification, and social skills training are subsequently applied to specific interpersonal issues.

C. Person-to-Person Relations

Although methods may vary, the real here-and-now therapeutic dialogue or mutual encounter, between therapist and patient is the *sine qua non* of many of the

experiential schools. It is an emotionally arousing human relationship in which each person tries to communicate honestly, both verbally and nonverbally. These approaches to psychotherapy ideologically aspire to an egalitarian treatment model. The human alliance is not of analyst to patient or teacher to student but of human being to human being. Here the therapist is still presumably an expert; but, if he or she is not first of all a human being, the expertness will not only be irrelevant, but even possibly harmful. Rogers stated that if the patient is viewed as an object, the patient will tend to become an object. Therefore, this type of therapist says in effect: “I enter the relationship not as a scientist, nor as a physician who can accurately diagnose and cure, but as a person, entering into an interpersonal relationship.” Naturally, what one construes to fall within the domain of personal or real in a therapeutic relationship is open to interpretation. The state of the art of therapeutic factors suggests that new paradigms are necessary to combine and transcend diverse perspectives of schools. As there are transcending non-specific elements, there are also transcending dimensions to all specific therapeutic relations and techniques.

The psychotherapeutic relationship possesses certain qualities of other relationships, such as between parent–child, teacher–student, and friend–friend, but it is also quite different from them. It is not natural, induced, or intended. It seems spontaneous but is not random, in fact, calculated. It has an intuitive quality but is learned, in fact, cultivated. It seems informal, but is quite serious. There is a system to this relationship—psychotherapy requires the systematic use of the human relationship. Based on the degree of consolidation of the patient’s psychic apparatus, the therapist may modulate his or her activities to establish and maintain the relationship with the patient, no matter what technique used; and he or she may use any technique. Yet all techniques are implemented interpersonally, even prescribing of a medication.

The relationship is potentially a healthy medium in and of itself. The cumulative aspect of the interpersonal relationship was an inspiration for the emergence of the Sullivanian school. For analytically oriented therapists, their schools’ contributions of four patient–therapist relationships (transferential, therapeutic alliance, object relations, self-object) are diagnostic and formative. The analytical therapist’s first task is to establish a relationship, but the second task is to explore what that relationship reveals. For the nonanalytical practitioner, there are the patient’s relational predispositions. The therapist does not need to use the relationship as a

formative technique but must be aware that whatever technique used, these relationships will come to play.

V. AN INTEGRATION: THE PAST AND THE FUTURE

With shifting paradigms, every therapist must synchronize with the patient, not unlike meshed teeth of a cogwheel, and become a presence in the patient's psychic life. The technique evolves from such a presence. It has been said that the relationship is never sufficient. The technique alone is not feasible. The first task, the most fundamental technique, would be how to establish and maintain the therapeutic relationship. The second task is to apply any technique that is potentially useful and within the range of the therapist's competence and patient's receptivity.

Finally, we must not forget that there were "therapeutic factors" long before such a term was invented. Our professional ancestors used overarching teachings of their religions, the knowledge of their times, and their cultural myths in the service of the healing arts. Today, we can benefit from our professional ancestors by learning ways of the soul and the spirit, and by incorporating these into "spiritual psychotherapy," as recently described by T. Byram Karasu. Six tenets of transcendence incorporate the fundamental thesis that the way to soulfulness is through love—love of others, love of work, and love of belonging; and the way of spirituality is through believing—belief in the sacred (reverence for all life), belief in unity (i.e., oneness with nature and the universe), and belief in transformation (i.e., sense of the continuity and renewal of the life

cycle)—the combination of which may turn out to be the superordinate therapeutic factors.

See Also the Following Articles

Behavior Therapy: Theoretical Bases ■ Cognitive Behavior Therapy ■ Existential Psychotherapy ■ Interpersonal Psychotherapy ■ Patient Variables: Anaclitic and Introjective Dimensions ■ Psychoanalysis and Psychoanalytic Psychotherapy: Technique ■ Working Alliance

Further Reading

- Bugental, J. (1987). *The art of the psychotherapist*. London: Norton.
- Friedman, A. (1988). *Anatomy of psychotherapy*. Hillsdale, NJ: The Analytic Press.
- Karasu, T. B. (1992). *Wisdom in the practice of psychotherapy*. New York: Basic Books.
- Karasu, T. B. (1996). *Deconstruction of psychotherapy*. Northvale, NJ: Jason Aronson.
- Karasu, T. B. (1999). Spiritual psychotherapy. *American Journal of Psychotherapy*, 53, 143–162.
- Karasu, T. B. (2001). *The psychotherapist as healer*. Northvale, NJ: Jason Aronson.
- Pine, F. (1990). *Drive, ego, object and self*. New York: Basic Books.
- Sheikh, A., & Sheikh, K. (1996). *Healing east & west: Ancient wisdom & modern psychology*. New York: John Wiley and Sons.
- Weil, A. (1995). *Spontaneous healing*. New York: Fawcett Columbine.
- White, M. (1993). *Therapeutic conversations*. New York: Norton.
- Wilson, E. O. (1998). *Consilience: The unity of knowledge*. New York: Knopf.

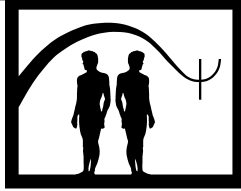

Therapeutic Storytelling with Children and Adolescents

Everett K. Spees

Devereux Cleo Wallace

- I. Description of Treatment
 - II. Theoretical Basis
 - III. Applications and Exclusions
 - IV. Empirical Studies
 - V. Case Illustrations
 - VI. Summary
- Further Reading

GLOSSARY

arousal A heightened emotional or cognitive state in response to sensory input or internal neural stimuli.

attunement Alignment of the therapist and clients' emotional states so that each can experience the other's subjective world. This permits the sense of emotional communication and connection often described as "being together" and "feeling felt." The nonverbal signs of eye contact, body gestures, facial expressions, and tone of voice communicate the state of mind of each member of a dyad through the orbitofrontal cerebral cortex. Neurophysiological mechanisms use these stimuli to integrate several domains of the human experience, including emotional regulation, response flexibility, consciousness, social relationships, and the evaluation of meaning. Misattunements lead to emotional dysregulation, which require "interactive repair" through a sufficient number of beneficial interpersonal experiences for the child or adolescent to achieve or regain emotional regulation. Storytelling supports the "secure attachment" developmental state. This state tolerates arousal of excitement, interest, and enjoyment, and emotional resonance, which allows these pleasure effects to persist.

imagery The arousal of mental images through sensory neural stimuli.

resonance The mutual emotional alignment of the mental states of two individuals that persists within the mind of each individual after the direct interaction is no longer present. Secure developmental attachments allow children to tolerate the resonance of high-intensity emotional states without discomfort, while children with less secure attachments may experience affect blocking.

transitional phenomena Refers to a metaphorical dimension of living that does not belong to an external or internal reality, and a place that both connects and separates outer and inner. Donald Winnicott conceived of it as the area where cultural experience, creativity, playing, stories, and being occur. Contemporary developmental neurobiologists relate transitional phenomena to the complex neural interactions observed in attunement and resonance.

The stories that people tell are the container that holds their world together and gives meaning to their lives.

Andrew Ramer

I. DESCRIPTION OF TREATMENT

Stories within a psychotherapeutic setting can facilitate positive interpersonal interaction between therapist and client, and can provide emotional enrichment and inner cognitive resourcefulness. Either therapist or

client, in individual, family, or group therapy, may initiate the story. The setting can be a private office or an inpatient or outpatient institutional facility.

Both client and therapist often experience pleasure and camaraderie from following unwinding plots that stimulate mental images through curiosity, dilemma, suspense, delight, fear, and relief. Intimacy can occur because both therapist and client reveal much of themselves, their personal interests, values, attitudes, and playfulness. Clients may be able to speak of their issues more comfortably and indirectly in story or metaphor form than in explicit conversation. Developmental neurobiologists have suggested that metaphoric and story experiences help young people to organize emotions and integrate social experience through a process of "interpersonal neurobiology" of the developing mind.

Of particular value in therapy are young people's autogenic (spontaneous) stories, metaphors, and self-narratives, because these encode information about their developmental experiences, emotional maturity, and ability to achieve interpersonal synergy. The therapist who uses storytelling skillfully with these goals in mind can often build an alliance with young patients.

Early in the first encounter a well-chosen story may allay some of the child's natural anxiety, fear, and distrust, while energizing memory, emotion, and self-awareness. As psychotherapy progresses, stories can continue to serve treatment goals. Often the mutual exploration of an evolving spontaneous metaphor becomes the core of the helping enterprise.

One of the author's 7-year old clients enthusiastically referred to the stories in the therapy sessions as "word movies," thereby innocently naming the pleasant images he had experienced. At the start of each group session he would eagerly ask, "Will we have word movies today?"

Useful resources are increasingly available for the therapist interested in developing a storytelling approach, and customizing it to the specific client needs and clinical settings. Planning the therapist stories in advance, selecting an environment free of interruption, and orchestrating the necessary neurobiological dynamics that accompany effective storytelling, is necessary to optimize their therapeutic value. These necessary dynamic elements include attunement, resonance, imagery, modeling, transference, countertransference, social interaction, and interpretation, as shown in Table I.

TABLE I
Developmental, Neurobiological, and Dynamic Principles in Storytelling Sequence

<i>Storytelling component</i>	<i>Developmental/neurobiological correlate</i>
Private area	Allows focusing on group experience
Free of interruptions	Fosters attunement and resonance
Familiar staff members present	Provides comfort, safety, and trust
Drama, animation, stage props	Activates five senses, emotional arousal
Audience vocal participation	Activates interpersonal awareness
Vaguely mysterious storyteller persona	Excites curiosity, memories, images
Children gather around	Corporate experience is to be shared
Name recognition	Each child recognized, valued
Refocusing client's attention	Attunement gateway to rich experience
Storyteller's first story	Example of model structure to be realized
Children participate	Child plays role in enactment of model
Applause, discussion	Recognition, gratitude, challenging
Feedback from the children	Each child's peer input valued, used
Children volunteer their story	Opportunity for meaning making
	Permission to resonate and experiment
	New insights on personal self-narrative
"Storyteller hat," "storyteller seat"	Child earns status from staff and peers
	Social rewards for risk taking
Applause, discussion	Child's risk-taking is reinforced by peers
	Value of peer approval is learned
Staff attention to emotion and content	Can we decode child's emotional clues?
	What themes trigger arousal or anxiety?
Revealing autobiographical narratives	Child risks self-disclosure
"Oscar" calls	Narrative bridging object
Assessing the emotional experience	Transference, countertransference, synergy?

The mix of each of these elements varies with who is present at the storytelling session, who tells the stories, how interesting and well-told the stories are, how the group interacts socially, and many other factors. Because of the calls to memory and the unconscious, no two storytelling experiences are ever identical for an individual participant. Listening to children's after-story interpretations makes that phenomenon clear. Each child hears a unique story, and each storytelling is a unique never-to-be-repeated telling for the storyteller, because it is mysteriously nuanced by the presence and interaction of the listeners.

Knowledge of current literature and resources in storytelling presented in this article may facilitate selection, creation, and use of story techniques that can be shaped to specific client circumstances through the art of the therapist, and the use of client autogenic stories.

II. THEORETICAL BASIS

Storytelling and metaphors supplied by psychotherapists and clients are a universally recognized resource for developing rapport with children, and a technique that has a venerable reputation among psychotherapists since the early work of Helmut von Hug-Hellmuth, a Vienna psychiatrist, in 1913. He liked to make up disguised stories with young clients that might begin, "I used to know a little boy a lot like you who used to wet his bed, too, but he learned how to get over it." Over time the client would gradually begin to guess that he himself was the true protagonist, the "little boy" in the therapist's story.

Contemporary and later influential psychotherapists such as Sigmund Freud, Carl Jung, Anna Freud, Bruno Bettelheim, Milton Erickson, and Erik Erikson also advocated their own distinctive theories and treatment goals in the use of stories and metaphors, and commented on their relationship to play and dreams. David Gordon wrote in 1988, "Metaphors, in the form of fairytales, parables, and anecdotes, are consciously and unconsciously used by therapists in order to assist a client in making changes he wants to make."

Freud, through analysis of his own dreams, as well as those of his patients, gradually became aware of the resemblance of dreams to Greek tragedies and to mythology. Using the Sophocles *Tragedy of King Oedipus*, Freud made his interpretation of the Oedipus myth into one of the cornerstones of his scientific psychological system. He came to believe that the "Oedipus complex" was a critical key to the understanding of the history and evolution not only of social interaction, morality, and reli-

gion, but of normal and abnormal child development as well. As he put it, the Oedipus complex, with its unconscious guilt of imaginary patricide and incest, was "the kernel of neurosis." Carl Jung carried his teacher's ideas even further. He observed early in his psychoanalytic training that the powerful revelational emotional reactions and remembered experiences that occurred through the language of dreams, stories, metaphors, and childish play might relate to the presence of universal unconscious archetypes or archaic symbols that operated in the unconscious. Because of his theory that in the unconscious of modern man existed a vestige of the active mind of primitive man that was overtaken by later concessions to logic and written language, he later referred to archetypes as natural symbols or primordial images. The extensive findings of similar archetypal themes in his investigation of primitive cultures and myths from around the world, and in studies of medieval alchemy symbols, reinforced the validity of Jung's concept of archetype.

This wider cultural anthropological theme was further developed by Jung's friend Joseph Campbell, whose *The Hero with a Thousand Faces* in 1968 popularized Jung's concept of a universal subconscious archetype by showing the remarkable similarity of myths and legend themes from many unconnected cultures of the present and past. Not surprisingly Campbell's favorite lifelong venue was the New York Museum of Natural History.

Freud, Jung, and Campbell also called attention to important gender themes in human development. Myths and fairy stories frequently depict conflicts between maternal and paternal imperatives metaethically encoded in matriarchal and patriarchal social systems. These powerful archetypal images arouse both conscious and unconscious emotions. Homer's *Odyssey* provides us good examples in the protagonists Odysseus and Penelope. Penelope, the matriarch, embodies love, fidelity, care, and nurture and protection of children. She values ties to her (and Odysseus's) bloodline, ties to the earth (a live tree branch grows through the marital bed), universality, tolerance, acceptance of natural phenomena, longing for peace, and tender humanness. The woman's womb may produce many brothers and sisters to every human being, and all should have a chance to thrive. Meanwhile, Odysseus, the patriarch, embodies the archetype of adventurousness and risk-taking, obedience to divine authority, and a hierarchical order in society. In place of the feminine concept of equality of offspring and impartiality toward each, with Odysseus we encounter the concept of the favored son. Odysseus is as sexually promiscuous as his wife is

chaste. He is crafty and ruthless in combat and takes the lives of many mothers' sons in order to win honor and fame for himself. He pillages cities, takes his enemies' treasure and his enemies' wives and children as slaves or concubines, and desecrates nature by killing bulls, cutting down trees, making bonfires, and raising elaborate buildings. Through recklessness and offense to the gods he loses all his comrades, ships, and plunder, and returns home alone to desolated families, leaving a trail of corpses behind. He arrives home just in time to slaughter all of Penelope's suitors, thereby keeping his honor and winning more fame. Having no womb to make children, the patriarchal archetype makes words, fame, commerce, theology, waste, and war.

In the Judeo-Christian Scriptures God is envisioned as a patriarch and patron, whose preexistence and authority mysteriously emanated from "the Word." The Gospel of St. John begins with the patriarchal vision, "In the beginning was the Word, and the Word was with God, and the Word was God." These gender themes preserved since the dawn of the human record continue to be relevant to the world we now inhabit, and are alluded to in a recent genre of gender psychology books that began with John Gray's *Men Are from Mars, Women Are from Venus*.

David Hicks, Headmaster at Darlington School, in Rome, Georgia, commented in a homily in 2001 on the persistence of metaethical archetypal themes, "Now, the influence of the world and the mind runs both ways. The world ultimately reflects the minds of those who inhabit it. At the same time, our minds mirror the world we inhabit" (and, we might add, the stories that reinforce these archetypes).

Using storytelling and metaphor allows the therapist access to a domain of childhood usually off limits to adults because storytelling can bypass both client anxiety and emotional resistances.

Richard Kopp in 1995 classified these resistances as both those known to the client (secrets actively avoided) and not known to the client (unconsciously avoided), both of which can be a barrier to learning the issues that prevent "living a free and full life." Because it specifically avoids confronting resistances, storytelling to and by children is usually more successful than direct questioning in assessing a child's attitudes, emotional intelligence, moral intelligence, assumptions, inner drives and conflicts, and the child's developing self-narrative. With children in groups, important information about the social interaction with peers and caregivers can also be assessed. Storytelling is also compatible and used with every major discipline of psychotherapy, and many psychotherapists use stories routinely.

III. APPLICATIONS AND EXCLUSIONS

The author conducts a regular weekly storytelling group for children ages 5 to 12 at a 300-bed child and adolescent psychiatric facility in Westminster, Colorado. One group of clients is inpatient, one is a day hospital group, and another a public school day-hospital group. Group size varies from 5 to 15. In addition, the author regularly uses selected storytelling along with autogenic autobiographical poems and fairy tales in a weekly adolescent values group with 10 to 20 clients ages 12 to 18. Because the ability to fathom abstract ideas and to activate the imagination is a necessary part of understanding metaphor and stories, young clients who suffer from, for example, developmental disability, obsessive-compulsive disorder, psychosis, or profound sedation from psychotropic drugs may not be able to benefit from storytelling. These children may have such a limited vocabulary or a concrete or unimaginative perception that the point of proverbs and metaphors may be a complete mystery to them. In fact, in every storytelling group the ability of children to attune, resonate, focus, engage, and interact varies, depending on many factors, including their developmental level, their degree of anxiety, their psychoactive medication, their underlying behavior disorder, and their ability to be playful.

For these reasons advance consultation with unit staff in planning a group helps the storyteller therapist understand each child's handicaps as well as to avoid distractions and logistical missteps. Children who are oppositional, acting out, or completely somnolent due to medication are best excluded from the storytelling activity group until their behavior permits their ability to participate and not distract others. On the other hand even some children who speak slowly or have speech impediments, are shy, or have other difficulties, should be allowed and encouraged to tell their stories if possible, and the therapist leader should help the other group members to be patient and respectful of the handicapped individual. This models the social values of tolerance and compassion. The presence of familiar unit staff members to calm or redirect children who are inattentive or who "act out" during a group is essential, since the storyteller is engaged and cannot take time out to deal with unexpected individual behavior. Fortunately the enthusiasm carried over by children and staff from week to week often makes the storytelling group familiar, popular, eagerly awaited, and fun. Because children are aesthetically discriminating, quality stories may help children overlook distractions. Both

children and adolescents prize stories that are imaginative, dramatic, novel, subtle, intricate, and well told. Not infrequently children will request repetition of a story that they liked from the previous week.

IV. EMPIRICAL STUDIES

The quest for identifying the exact neurobiological pathway(s) by which storytelling and metaphor connects with development, consciousness, and unconscious goes back as far as Friederich Nietzsche, who coined the term “the third ear” in *Beyond Good and Evil* in 1886. Nietzsche proposed that with this imaginary extra ear we are able to hear and recognize the metaphorical language of our intuition.

J. L. Despert and H. W. Potter in 1936 reached the following conclusions from their clinical experience in therapeutic storytelling:

1. The story is a form of verbalized fantasy through which the child may reveal his or her inner drives and conflicts.
2. A recurring theme generally indicates the principal concern or conflict, which in turn may be corroborated with other clinical evidence (e.g., dream material).
3. Anxiety, guilt, wish fulfillment, and aggressiveness are the primary trends expressed.
4. The use of stories appears to be most valuable when the child determines the subject of the story.
5. The story can be used as both a therapeutic and an evaluation device. These observations are still valid.

Donald Winnicott wrote in 1971 of a “third area” of reality, as a dimension in which cultural experience is located between interior and exterior reality. He speculated that in this third area the young person experiences play, humor, metaphor, and stories as “transitional phenomena.” Winnicott believed that the role of the child psychiatrist was to help the child who was unable to play attain the state of being able to play, and that “psychotherapy takes place in the overlap of two areas of playing, that of the patient, and that of the therapist.”

Winnicott also described his experience with finding an unconscious meeting ground with children. He wrote of a “sacred moment” in the initial interaction of client and therapist when the child, aided by storytelling, believes that he or she is being understood in a common metaphorical language. He noted that the function of this sacred moment could either be to allow deep work

during the first interview or serve as a “prelude to longer or more intensive psychotherapy.”

Bettelheim, like Winnicott, was also highly aware of the “enchanted moment and place” phenomenon that stories could provide. He pointed out in 1975 an important subtlety of Grimms’ and other traditional fairy tales: “The unrealistic nature of these tales ... is an important device, because it makes obvious that the fairy tale’s concern is not useful information about the external world, but about processes taking place in an individual.” Milton Erickson, who was himself a gifted and creative storyteller and metaphor artist, theorized in 1979 on the basis of extensive hypnotherapy experience that the location of the “third ear” of Nietzsche or “third area” of Winnicott was a specialized neuroanatomical site in the right cerebral hemisphere containing the primary process locus for processing not only metaphorical language but psychosomatic symptomatology as well. Erickson believed that this anatomical localization could account for the more rapid improvement in psychosomatic complaints when metaphorical and hypnotherapy rather than standard psychoanalytical approaches were employed.

Neurobiological research with infants by Daniel Siegel in 1999 and by Alan Schor in 2001 and the earlier work of Daniel Stern has identified primary processing in human preverbal and verbal stages of development that correlates with the appearance of symbolic and metaphoric thought, often described as nonlinear, nonsequential, metaphorical, and nonlogical. This neurofunctional distinction was made to contrast it to cognitive thought, which is said to be linear, sequential, nonmetaphorical, and logical. S. Engle in 1999 theorized that this primary processing helps explain the objective basis by which self-composed stories may serve as the “most essential symbolic process” for reflecting on and describing experiences. Siegel, a developmental neurobiologist, described findings that the mind encodes internal and external experiences represented in different forms and creates a sense of continuity across time by linking past, present, and future perceptions is within the narrative process. The autobiographical self-narrative is a key evolving integrative process that influences the nature of interpersonal relationships, and is central to secure attachment relationships, and to how one constructs reality. These and other developmental findings about childhood and adolescence suggest ways to use neurobiologically advantageous strategies for storytelling with young clients suffering from mental or behavior issues.

In case there has been any doubt about the significant role of storytelling, Siegel stated that from the developmental neurobiological standpoint, “Storytelling

becomes a proxy to the damaged or missing attachment relationships that are causing emotional despair and rebellion.”

The hospital setting for a child away from family and among strangers and peers with behavioral problems may not seem so hospitable or safe. Consequently the therapeutic storyteller must make efforts to create a safe, comfortable, quiet environment so that each child can process as much sensory experience and emotion from the stories as possible, and feel free to contribute autogenic stories. The identification and timing of neurobiological factors, as well as psychodynamic concepts that can optimize the storytelling and autogenic narrative process, are summarized in Table I. The observation that adults outside the mental health setting also benefit from directed storytelling suggests that the effect is perennial and universal. Business leaders have recently written about the benefits of storytelling in the workplace to promote morale and teambuilding.

Theologians in recent years have reemphasized the narrative structure of the Scriptures and recommended narrative technique for homilies and teaching. More recently the U.S. Military Academies Academy Character and Leadership Divisions have adopted the practice of bringing in distinguished retired military officers to tell young cadet classes their personal stories of moral leadership struggles. For mentoring, small groups of cadets are given the opportunity to team with these elders.

The foregoing data support the author's belief that therapeutic storytelling facilitates the development of beneficial interpersonal relationships between client and therapist. Although each person experiencing a story has a unique psychic experience, stories activate important emotional and cognitive neural pathways that promote emotional enrichment and inner cognitive resourcefulness. Clarissa Pinkola Estes, the Jungian psychotherapist, poetic storyteller, and author of *Women Who Run With the Wolves*, once commented that we humans come not only from dust, but from stardust as well.

For children and adolescents whose brief life history has often been filled with grievous injustices such as parental neglect, physical and sexual abuse, violence, rejection, arrests, and pain, the redemptive personal attention, respect, ability to win peer approval, and the chance to develop a self-narrative through storytelling sessions may reopen an area of development and relationships that had been sealed. By approaching a side door rather than the main door, psychic resistance can often be bypassed so clients can willingly enter into a health-restoring personal psychotherapy program, the goal of which is to promote social and emotional maturation and healthy personal autonomy.

V. CASE ILLUSTRATIONS

Therapeutic storytelling preparation begins with finding and using or reworking story sources. Each therapist probably has at least a few and perhaps many favorite stories, and we encounter new stories daily in the various media. In general, little of the available children's story literature is immediately appropriate for psychotherapy storytelling. However, many of the following resources have been useful to the author in understanding, selecting, and working with a broad spectrum of storytelling options and psychotherapeutic approaches.

Jack Zipes' retranslation of classical folktales and his astute commentary on their archaic and modern cultural context, including feminist revisions, has enhanced their usefulness to psychotherapy. His books, such as *The Oxford Companion to Fairy Tales* in 2000, provide the therapist with a good background analysis of the genre. The Zipes references, taken in chronological order published from 1989 to 2000, make a thorough introduction to storytelling, as well as reviewing the state of academic "fairytale-ology." Bruno Bettelheim, who was intrigued by fairy tales and used them in therapy with adolescents, took off a year on sabbatical to write a book discussing his application of Freudian analysis to selected Grimms' (and other) fairy tales, and his 1975 publication *The Uses of Enchantment*, has been well received. Bettelheim's opinion was that fairy tales attract us because they permit our vicarious wish fulfillment in a seemingly perfect enchanted world. At the same time he said they help to affect sexual drives in a positive way, thus aiding resolution of oedipal tendencies and sibling rivalry.

Zipes, a nonpsychologist, disagreed with Bettelheim's analysis, writing that the appeal of the stories was more likely due to our desire to deal indirectly with repressed modern issues such as parental abuse, neglect, brutality, and our parental desire to abandon our children. Zipes wrote in 1995 that traditional fairy stories were originally written in raw detail for adults, and that the substitution of happy endings in order to dilute them for children was a travesty.

Ronald Murphy, a Jesuit priest and professor of German, pursued the religious themes in Grimm's fairy tales. Murphy journeyed to Germany for a detailed study of personal books, manuscripts, annotated personal Bibles, and other Grimm family items. In *The Owl, The Raven, and the Dove* in 2000, Murphy reconstructed from notations and background material in these original sources, the influences of Christian theology, oral culture, and German pagan mythology, choosing five selected fairy tales edited by Wilhelm Grimm.

William Bausch, another Catholic priest, published an extensive anthology of multicultural stories in several books (1996 to 1999), including *The Wizard of Oz*, with commentaries, which are potentially useful in psychotherapy, religious education, and homily composition. Recently other concerned educators have compiled story anthologies directed toward moral education of young people.

A recurrent dilemma in preparing traditional folktales or stories so that they are age appropriate and suitable for young mental health clients is how to maintain the charm and feel of the stories while making them more contemporary for young listeners. Ideally one should aim to preserve the authenticity, flavor, and meaning of the archaic story, as much as possible, although finding ways to deal with brutality, anti-Semitism, and sexual offenses may be a struggle.

John Stephens and Robyn McCallum in their 1998 *Retelling Stories, Framing Culture: Traditional Story and Metanarratives in Children's Literature*, showed how in traditional folktales and legends the encoded metaethics might impact the hearer on a deep moral or social level. They summarize the not-so-obvious cultural and ethnic baggage directed at the original audience, which they term the metanarrative in epics such as *The Arabian Nights*. In their opinion such ancient tales may transmit "implicit and usually invisible ideologies, systems, and assumptions that operate globally in a society to order knowledge and experience." Obviously the psychotherapist needs to consider these cultural and ethical overtones carefully for their positive or negative impact on today's clients.

Several resources have targeted specific children's behavioral health problems, such as kidney failure, bedwetting, and chronic illness, and the stresses from disruption of family life by divorce, useful for therapists who prefer modern stories. George Burns in his *101 Healing Stories: Using Metaphors in Therapy* in 2001 ranks high on the list of useful resources. Burns not only provides numerous engaging therapy stories, but he comprehensively discusses how to identify story resources from our own life experiences, from our patients, and from the secular world. He gives detailed, thought-provoking advice on how-to, and how-not-to develop and use stories with clients, and how to select and shape stories for specific client needs. Unlike other literary presentations, he comprehensively lists and discusses his interpretation of the psychodynamic themes in each of his healing stories from a psychoanalytic standpoint.

Lee Wallas in 1985 contributed 19 lively stories that she developed spontaneously in her Ericksonian hyp-

notherapy practice. She examines her personal experiences and insights about how she happened to hit upon these themes and develop the stories in the course of treating clients with various neuroses.

Richard Gardner in 1993 published his mutual storytelling techniques, *Storytelling in Psychotherapy with Children*, in which he relies upon autogenic (spontaneous undirected) stories told by the client, sometimes involving hypnotherapy. Gardner's therapeutic technique evolves from intense involvement with the client in therapy and, like Wallas, using reflections about the client's clinical problem as the kernel of a new story within the same metaphor and with the same characters used by the client. The therapist then tells the unique "new story" to the client in a way that suggests alternative methods for the client to deal with the problem issue(s). Gardner elaborates on further innovations including dramatized mutual storytelling, storytelling games, and bibliotherapy (the use of books in the therapeutic process).

Gardner's colleague, Jerrold Brandel in *Of Mice and Metaphors* in 2000, described his personal experience and his own modifications of Gardner's reciprocal storytelling technique. Brandel used the term "re-visioning" for his method of modifying struggling youngsters' own stories therapeutically and then "bouncing them back" to the client with the remedial editing and interpretation as part of a dynamic storytelling game. He might inquire of the client, for example, "How would you like this story to end?"

In 1997 Carlissa Pinkola Estes compiled a collection of deep and thought-provoking feminist fairy tales, *Women Who Run With The Wolves*, in both print and audiotape. She has used these in Jungian psychotherapy and hypnotherapy. Her tapes, published by the Sounds True Company in Boulder, Colorado, are a fascinating resource for grasping the immense possibilities of psychotherapeutic storytelling. Her audio performance of Hans Christian Anderson's *The Red Shoes* is an excellent example. She follows the story with a detailed and valuable interpretation of the Jungian insights of the fable. This author has found this story compelling in sessions with adolescent clients, who unerringly relate the theme of self-destructive obsession to their own life situation.

Ellen Wachtel in her 1994 *Treating Troubled Children and their Families*, wrote about helping parents compose and tell stories to their child at home as part of his or her therapeutic program, especially when there is poor clinical progress with conventional treatment methods. She reminds us of the immense pedagogical and spiritual value of parental life anecdotes that satisfy the child's developmental need to assimilate family

tradition and parental role modeling as part of a healthy attachment and evolving self-story.

Personal storytelling tutorials, for example Nancy Shimmel's 1992 *Just Enough to Make A Story*, offer useful guidelines and some prime examples. Her title story highlights human persistence and thrift, and the underlying purpose of stories. It is about a tailor who buys a bolt of cloth to make himself an overcoat. When the overcoat begins to wear out he cuts it into a jacket, after further wear he pares it down into a vest, then a hat, and finally there is only enough to make a button. When the button is worn out there is "only enough left to make a story."

Zipes, in *Creative Storytelling: Building Community, Changing Lives* in 1995, offers novel ideas and model tales for telling, although he shares his skepticism about using stories for psychotherapeutic goals. Several authors, including Gianni Ronardi in *The Grammar of Fantasy* in 1973 have given memorable advice on inventing stories for telling.

Internet resources are considerable, and include "The Storytelling Ring," a popular site with a variety of public domain story resources (e.g., the interesting Southern mystery stories at www.themoonlitroad.com or www.storyteller.net). Friends, relatives, and community members, and especially senior citizens, often have poignant or funny anecdotes that can be creatively reworked.

Therapists may wish to seek out community storytelling groups in order to observe presentation techniques and content. Even more useful is the easily obtained opportunity to volunteer as a storyteller at a local library or elementary school. Another resource is the Storytelling Magazine and the live storytelling festival audiotapes of the National Storytelling Network.

A. Immediate Preparation

Ideally, the therapist should review the story list prior to the session. Preparation includes memorizing newly adapted stories, rehearsing, and developing an agenda on the evening before a group. When only one story is to be used the author selects it to fit a specific topic and proverb for that day. For example, if the group topic is coping with adversity, a story of the "Rapunzel" genre might fit.

B. Running the Group

A comfortable and private office is favorable for individual client stories during a treatment session. Storytelling with a group in a mental health center is more logistically demanding. One needs to find a

space free of interruptions and arrange for familiar staff to be present.

Drama, animation, stage props, and audience participation enhance the choreography of this activity, while activating sensory and emotional pathways in the participants. Token costume items like a Turkish hat or cowboy jacket, according to the therapist's taste and intentions, can help the drama effect. The children gather around in chairs or sit on the floor with name cards in front of them so that the storyteller can identify and address each child by name. The first action of the group session is to refocus the children's attention by various techniques such as group singing, or asking the children to quietly listen to and identify various white noise sounds such as a down-pour in a rainforest or a faraway train. These sounds can come from an inexpensive electronic generator operated by the storyteller. Alternatives might include juggling or harmonica playing by the storyteller.

Once attention is refocused, the storyteller begins, choosing first a story in which the children participate by repeating phrases, assuming roles, or making sounds to accompany the narrative. For example, in a story about a train trip designated children provide the sound effects of the "All aboard!," others the train wheels sound, and still others the train whistle at the appropriate times.

When the first story and applause are through, the storyteller asks for feedback from the children. What were their impressions and feelings during the story? What did the story mean to them? How did they feel when they were hearing it? Were they surprised or puzzled by some story element? Each child usually interprets the story somewhat differently. If a child is reluctant to share a personal interpretation, asking the child to briefly repeat the story aloud may be useful.

Next three children are recruited sequentially to tell an autogenic story. Offering the child a special "storyteller hat," and allowing the child to occupy a special "storyteller seat" can enhance the honor of this selection. Following each child's story there comes applause and feedback comments from the peers about each story. The staff and the therapist pay attention to the body language, facial expressions, emotion, and content of each child's story and the social interactions of others in the group. When clients tell revealing autogenic stories, their body language tends to become busier than usual. Sometimes a "poorly functioning" child surprises everyone with dramatic and sensitive stories, or with the ability to repeat someone else's story verbatim even though he appeared not to be paying attention.

Occasionally between stories the therapist's cellular phone "rings," because "Oscar" is phoning. The therapist explains that Oscar (the mythical caller and narrative continuity object) is a wizened old storyteller with a gruff voice. He "calls" to ask about the children's stories and describes where he is located geographically, and what his activities are. Recently Oscar reported that he was riding on a porpoise's back in the Bahamas.

The children are charmed but skeptical about Oscar. In every group meeting, and even in the cafeteria or while crossing the campus, the more experienced children ask the therapist whether Oscar will call in that day.

After three rounds of therapist and children's stories the author concludes the group by asking each child one-by-one to step up directly in front of him, hand the storyteller his or her name card, look the storyteller in the eye, and state which "word movies" he or she enjoyed. In that final moment of eye contact the therapist attempts to assess the magnitude, richness, and meaning of the emotional experience that child and the storyteller have shared during the hour, and to look for any signs of emotional upset.

VI. SUMMARY

Therapeutic stories generated by both therapist and client are valuable tools in individual and group therapy with children and adolescents. When used as part of any psychotherapeutic approaches they enhance the ability of the clients' developing minds to make beneficial alliances with staff and therapists, and to further develop their personal self-narrative. Developmental neurobiologists believe that storytelling acts as a substitute for unhealthy attachment relationships that are at the root of many behavioral disorders in children and adolescents. Taking advantage of the neurobiological and social mechanisms that occur during storytelling helps the therapist optimize the setting and choreography of storytelling.

In an era of cost-cutting pressure on behavioral health care providers, and an increasing reliance on psychoactive drugs, therapeutic storytelling as described in this article may be one of the truest forms of psychotherapy still being practiced. An important bonus to the use of stories is that they are a lively and enjoyable activity. Stories encourage children to share their experience and redevelop its meaning in an environment of human warmth, safety, trust, and curiosity.

Acknowledgment

This article could not have been completed without the impeccable assistance of Ms. Pam Roth, research librarian at Presbyterian/St. Luke's Medical Center in Denver, Colorado, and the help of my family.

See Also the Following Articles

Animal-Assisted Therapy ■ Art Therapy ■ Biblical Behavior Modification ■ Bibliotherapy ■ Child and Adolescent Psychotherapy: Psychoanalytic Principles ■ Dreams, Use in Psychotherapy ■ Emotive Imagery ■ Parent-Child Interaction Therapy ■ Primary-Care Behavioral Pediatrics ■ Transitional Objects and Transitional Phenomena

Further Reading

- Anon. (1992). *A storytelling treasury*. Tales Told at The National Storytelling Festival. Five Audiotapes Recorded Live. Twentieth Anniversary Edition. Little Rock, AK: August House.
- Bettelheim, B. (1975). *The uses of enchantment. The meaning and importance of fairy tales*. New York: Vintage Books.
- Engel, S. (1999). *The stories children tell: Making sense of the narratives of childhood*. New York: W.H. Freeman.
- Gardner, R. A. (1995). *Storytelling in psychotherapy with children*. Northvale NJ: Jason Aronson.
- Kopp, R. (1995). *Metaphor therapy. using client-generated metaphors in psychotherapy*. New York: Bruner/Mazel.
- Maguire, J. (1998). *The power of personal storytelling. Spinning tales to connect with others*. New York: Putnam.
- Murphy, G. R. (2000). *The owl, the Raven, and the dove. The religious meaning of the Grimms' magic fairy tales*. New York: Oxford University Press.
- Ronardi, G. (1973). *The grammar of fantasy. An introduction to the art of inventing stories*. New York: Teachers and Writers Collaborative.
- Schimmel, N. (1992). *Just enough to make a Story: Inventing stories*. Berkeley, CA: Sisters Choice Press.
- Siegel, D. (1999). *The developing mind. Toward a neurobiology of interpersonal experience*. New York: Guilford.
- Spees, E. (2001). Stimulating emotional and moral intelligence: Innovative values groups for adolescents. *Annals of the American Psychotherapy Association*, 4, 14-17.
- Stephens, J., & McCallum, R. (1998). *Retelling stories, framing culture. Traditional story and metanarratives in children's literature*. New York: Garland.
- Wallas, L. (1985). *Stories for the third ear. Using hypnotic fables in psychotherapy*. New York: W.W. Norton.
- Zipes, J. (Ed.). (2000). *The Oxford companion to fairy tales. The western fairy tale tradition from medieval to modern*. New York: Oxford University Press.

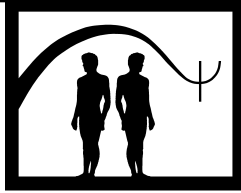

Thought Stopping

Melanie L. O'Neill and Maureen L. Whittal

University of British Columbia Hospital

- I. Overview and Description of Thought Stopping
 - II. Theoretical Bases
 - III. Early Empirical Studies
 - IV. The Impact of Thought Suppression
 - V. A Cognitive Alternative to Thought Stopping
 - VI. Summary
- Further Reading

GLOSSARY

counterconditioning A method to remove the original association between fear and the trigger for the fear and to replace it with a new trigger that is incompatible with fear.

covert sensitization A procedure in which an inappropriate response to a stimulus (e.g., a sexual response to children in an adult male) is broken by attempting to associate the stimulus with a new incompatible response (e.g., associating children with discomfort that may be produced by a puff of air in the eye).

escape conditioning A noxious stimulus is paired with anxiety/fear to terminate the fear and a more appropriate response is put in place (e.g., repeatedly pairing an intrusive thought with an electric shock. Over time the intrusive thought declines because of its association with the electric shock).

obsessive-compulsive disorder (OCD) An anxiety disorder that is characterized by the presence of obsessions and/or compulsions. Obsessions are defined as repetitive, unwanted, senseless thoughts, images, or impulses that may be repugnant or horrific. Compulsions are defined as overt behaviors or mental acts that are typically done in response to the obsession and function to decrease the anxiety. They

are time consuming, excessive, and senseless. Persons are often aware that they are unnecessary but cannot stop themselves.

Thought stopping (TS) is a behavioral technique used to minimize the distress associated with unwanted intrusive thoughts. Clients are asked to sit with their eyes closed and verbalize a typical sequence of problematic thoughts. During this time the therapist suddenly shouts, "Stop!" The therapist then highlights that the thoughts did stop and proceeds to repeat the procedure several times until the client is able to subvocally disrupt the maladaptive thoughts.

I. OVERVIEW AND DESCRIPTION OF THOUGHT STOPPING

Joseph Wolpe describes TS as useful in the elimination of undesirable thoughts that are unrealistic, unproductive, and anxiety producing. Although used frequently by behavior therapists in the 1970s and early 1980s, TS has received relatively little rigorous empirical attention. Uncontrolled case studies and anecdotal reports of TS are generally favorable when used as both a stand-alone procedure or in conjunction with other cognitive and behavioral techniques. Our purpose is to summarize this work and draw conclusions about the usefulness of TS as a therapeutic technique.

Last, we will introduce a cognitive alternative to TS that has produced some initial success for clients with obsessive-compulsive disorder.

TS was introduced by James Alexander Bain and J. G. Taylor under the premise that thought control is important for positive mental health. Although TS is often viewed as an overly simplistic technique, it actually requires a thorough behavioral analysis. In 1977, Joseph Cautela and Patricia Wisocki suggest that the behavioral analysis should include a client's comprehensive list of disturbing and uncontrollable thoughts with particular importance placed on any overt or covert behaviors that have harmful societal implications (e.g., thoughts of seeking revenge).

Target thoughts are agreed on and the rationale for their elimination is discussed. Cautela recommends that clients be asked to close their eyes and raise their finger once deliberately thinking of the target thought(s). When the client raises a finger, the therapist loudly shouts "Stop!" that typically produces a startle response. The therapist explains that one is unable to think of two things at the same time (stop and the target thought[s]) and proceeds to teach the client the procedure for his or her own use by encouraging the client to subvocally yell "Stop!" These rehearsals continue in-session for approximately 10 min or for 20 trials until the procedure is learned. Therapists emphasize that with the repeated and daily use of TS, the target thought(s) will gradually decrease in frequency until they disappear altogether. Subsequent sessions might allot 5 min for TS rehearsals including variations of the procedure (e.g., snapping a rubber band on the wrist instead of yelling "stop," substituting another word for "stop," visualizing a stop sign instead of yelling "stop").

II. THEORETICAL BASES

The theoretical underpinnings of TS are vague and sparse. Indeed, since the early 1970s, reservations concerning the adequacy of supporting theoretical arguments for TS have been expressed. Wolpe and Taylor did not discuss a conceptual basis for TS, however, Cautela and Wisocki suggested that the more likely interpretations include escape conditioning and counterconditioning.

Within the escape conditioning paradigm, TS functions to replace an inappropriate discomforting response with an appropriate alternative. In 1943, C. L. Hull contended that behaviors that reduce discomfort,

such as anxiety, are associated with establishing a habit. Avoidance also strengthens a habit because it prevents clients from experiencing anxiety.

An anxiety-provoking thought is triggered by an internal or external cue. Counterconditioning is thought to function by replacing the old response with a new response in the face of the identical trigger. For example, once trained in progressive muscle relaxation, clients are instructed to think of the anxiety-provoking trigger while relaxed. The rationale behind this technique is that it is impossible to feel fear and relaxation at the same time. In 1958, Wolpe used a counterconditioning procedure and called it systematic desensitization. Cautela and Wisocki hypothesized that TS could be used to assist in the development of the new response.

III. EARLY EMPIRICAL STUDIES

Historically, TS was used in the treatment of obsessions, however, the technique has been used as an intervention for a variety of different disorders including smoking cessation, drug and alcohol dependence, psychosis, depression, panic, agoraphobia, generalized anxiety, and body dysmorphic disorder. Although numerous uncontrolled single case studies concluded that TS is a viable behavioral technique, there is little methodologically sound research with larger sample sizes to support the use of TS. After a thorough review of the literature in 1979, Georgiana Tryon concluded that the effectiveness of thought stopping had not been demonstrated. Another limitation preventing stronger conclusions about the efficacy of TS is the lack of a standard procedure when using TS. Many studies provide minimal detail regarding the procedure and use a variety of TS procedures in conjunction with various other techniques such as relaxation and self-monitoring.

TS is often used to treat obsessional difficulties. For example, in 1974 Raymond Rosen and Betty Schnapp reported that TS was helpful for a man who was ruminating about his wife's infidelities. In 1971, by instructing patients to snap a rubber band on their wrist in response to an obsessional thought, Michael J. Mahoney decreased the frequency of obsessive ruminations. In 1971, Toshiko Yamagami had success reducing color obsessions with four variations of TS. In 1982, Helen Likierman and Stanley Jack Rachman compared TS and habituation training for 12 individuals with obsessions and found little therapeutic benefit for both procedures. Of the six individuals in the TS group, four improved, one became worse, and, with one it was unclear.

TS has also been used in smoking cessation treatment. In 1974, Wisocki and Edward Rooney compared the effectiveness of TS, covert sensitization, and attention placebo in decreasing the number of cigarettes smoked. Initially, TS and covert sensitization significantly reduced smoking, however, this difference disappeared at 4-month follow-up. Another study conducted by Yves Lamontagne, Marc-Andre Gagnon, Gilles Trudel, and Jean-Marie Boisvert in 1978, compared four different treatments, including TS, group discussion, and wearing a badge, all with self-monitoring compared to self-monitoring alone. All treatments initially reduced the frequency of smoking; however, it was TS and self-monitoring that maintained a significant decrease at 6-month follow-up.

In another class of problems, Makram Samaan in 1975 reported that TS was successfully used to treat auditory and visual hallucinations in one client who did not experience a relapse 20 months after treatment. In 1979, John O'Brien applied TS to two cases of agoraphobia with no relapse at 1-year follow-up. However, the efficacy of TS is difficult to determine because the client received 1 year of treatment that included self-monitoring and some cognitive therapy. In 1978, John Teasdale and Valerie Rezin compared TS to placebo control for 18 individuals with symptoms of depression. TS had little effect in reducing the frequency of depressive thoughts or the intensity of depressed mood.

The previous paragraphs suggest that the efficacy of TS is based on single cases but its general usefulness is in question. Rachman and Padmal de Silva may have inadvertently discovered one reason why TS is not helpful as a strategy. In a survey of people who lived in the general community, these researchers found that over 90% reported a multitude of intrusive thoughts, images, and impulses. The results of these and related studies suggest that experiencing unwanted intrusive thoughts is a completely natural, normal phenomenon. If so, the elimination of these thoughts through TS or other deliberate suppression attempts may be futile, at best, and harmful, at worst.

IV. THE IMPACT OF THOUGHT SUPPRESSION

Recent work in the area of thought suppression has confirmed that attempting to distract, ignore, or suppress thoughts may serve to increase their frequency. Dan Wegner's investigations on the effects of thought suppression have revolutionized the understanding of

disorders characterized by persistent unwanted thoughts. In a series of two experiments, Wegner demonstrated that subjects who were asked to not think of a white bear during a 5-min time period actually thought of a white bear more frequently than another group of subjects who were told that it was okay to think of a white bear.

In a review of the literature in 1999, Christine Purdon indicated that thought suppression has now been identified as both a causal and/or maintaining factor in generalized anxiety disorder, specific phobia, posttraumatic stress disorder, obsessive-compulsive disorder (OCD), and depression. According to this line of research, purposely suppressing thoughts is associated with an unexpected and surprising increase in their frequency. For example, Paul Salkovskis and his colleagues in Great Britain have suggested that active and deliberate thought suppression in the form of neutralization is critical in the development of obsessions. Students who experienced frequent unwanted intrusive thoughts that they felt necessary to neutralize had their intrusive thoughts recorded and were asked to either neutralize the thought or distract themselves from it. Those students who neutralized the thought reported significantly more anxiety and a greater urge to neutralize when the thought was presented a second time.

V. A COGNITIVE ALTERNATIVE TO THOUGHT STOPPING

The work of Wegner, Salkovskis, and Purdon has demonstrated that thought suppression increases the frequency of the target thought(s). TS can be considered a form of thought suppression or control and will thus likely serve to increase the frequency of the thoughts. For example, if clients have a belief that they must be in control of their thoughts and emotions at all times, experiencing an unwanted thought (which we know from the work of Rachman and de Silva is a normal, natural phenomenon) will produce anxiety and the need to try to control the thought. Attempts at thought control often involve ignoring, distracting, or suppressing the thought. These strategies serve to increase attention to the thought process, likely making the thoughts more noticeable and seemingly more frequent. The apparent increase in the frequency of the unwanted thoughts likely serves to further heighten anxiety, attention to the thought process, and precipitate additional attempts at thought control. A vicious circle can quickly develop.

As part of recent developments in cognitive behavioral treatments for OCD, Maureen Whittal and Peter McLean have described a process coined “come and go.” Clients are encouraged to experience the intrusive unwanted thought and not try to control it (i.e., do not try to ignore, suppress, distract or anything else that will serve to get rid of the thought). Rather, clients are instructed to let the thought leave naturally, typically when another thought logically takes its place. Clients are instructed to practice this “come-and-go” strategy and their usual style of thought control on alternate days and predict their anxiety and the frequency of intrusive unwanted thoughts on each of the days. Clients invariably predict that letting thoughts come and go will result in higher levels of anxiety and more frequent intrusive thoughts. They are often surprised that letting go of their efforts at thought control (i.e., letting thoughts come and go) lessens the anxiety and typically lowers the frequency of the target thought(s).

To date to the best of our knowledge, this “come-and-go” strategy has been tested only with clients with OCD. However, it is likely that it would also be helpful for other disorders that feature repetitive unwanted thoughts (e.g., eating disorders, impulse control disorders, and body dysmorphic disorder).

VI. SUMMARY

Thought stopping (TS) is a behavioral procedure used to minimize the distress and anxiety associated with unwanted intrusive thoughts. Clients are asked to sit with their eyes closed and verbalize a typical sequence of problematic thoughts. During this time the therapist suddenly shouts “Stop!” The therapist then highlights that the thoughts did stop and proceeds to repeat the procedure several times until the client is able to subvocally disrupt the maladaptive thoughts.

Although used frequently by behavior therapists in the 1970s, TS has received relatively little rigorous empirical attention. Uncontrolled cases studies and anecdotal reports of TS are generally favorable when used as

both a stand-alone procedure or in conjunction with other cognitive and behavioral techniques. The few studies utilizing rigorous empirical methodology in their investigations of the efficacy of TS have been equivocal.

Recent empirical studies with thought suppression have demonstrated the paradoxical increase in thought frequency. TS can be considered a form of thought suppression or control and will, thus, likely serve to increase the frequency of the thoughts. With this in mind, Whittal and McLean developed a cognitive alternative to TS termed “come and go” that has shown success in treating individuals with OCD. The authors suggest that letting thoughts come and go will also be helpful with other problems that feature repetitive, unwanted thoughts (e.g., eating disorders, impulse control disorders, other anxiety disorders).

Acknowledgments

The authors wish to express their appreciation to S. Rachman, Ph.D. and Simon Rego, Psy. M. for providing comment on earlier versions of this manuscript.

See Also the Following Articles

Control-Mastery Theory ■ Covert Control
 ■ Extinction ■ Orgasmic Reconditioning

Further Reading

- Wegner, D. M. (1989). *White bears and other unwanted thoughts: Suppression obsessions and the psychology of mental control*. New York: Penguin.
- Wegner, D. M. (1994). Ironic processes of mental control. *Psychological Review*, 101, 34–52.
- Whittal, M. L., & McLean, P. D. (1999). CBT for OCD: The rationale, protocol, and challenges. *Cognitive and Behavioral Practice*, 6, 383–396.
- Wolpe, J. (1958). *Psychotherapy by reciprocal inhibition*. Stanford, CA: Stanford University Press.
- Wolpe, J., & Lazarus, A. A. (1966). *Behavior therapy techniques: A guide to the treatment of neuroses*. Toronto, Ont.: Pergamon Press.

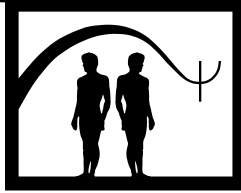

Time-Limited Dynamic Psychotherapy

Hanna Levenson

Levenson Institute for Training

Thomas E. Schacht

James H. Quillen College of Medicine

Hans H. Strupp

Vanderbilt University

- I. Description of Treatment
 - II. Theoretical Base
 - III. Empirical Studies
 - IV. Case Illustration
 - V. Summary
- Further Reading

GLOSSARY

attachment theory Pertains to how children become comfortable or anxious in relationship to their caregivers' behavioral and emotional responses; such attachment patterns are presumed to carry over into adult relationships.

behavioral A therapeutic approach that emphasizes that behaviors are learned (according to learning principles such as reinforcement and extinction) and therefore can be modified using these same principles.

case formulation The process of diagnosing problems for psychotherapeutic intervention. Case formulation differs from diagnosing psychopathological categories. Rather than producing a diagnostic label, case formulation seeks to create a minitheory linking current presenting problems with recurrent problem patterns and underlying core-ordering processes.

cognitive A therapeutic approach that emphasizes that how one interprets events in the world determines an individual's behavior and feelings; interventions therefore focus on changing the way one thinks and evaluates.

manualized treatment A psychotherapy with principles and techniques that have been specified in a written manual developed to specify the treatment variable in research contexts. Manualized treatments usually include associ-

ated psychometric instruments for measuring therapist's adherence to the precepts of the manual.

metacommunication Refers to communications in which the process of communication or the relationship between the communicators becomes the topic of conversation. In psychotherapy, metacommunication functions as a form of interpretive intervention focused on clarifying the ongoing interpersonal process between the patient and the therapist.

psychodynamic A therapeutic approach that emphasizes unconscious processes, the influence of early experiences, conflict, transference/countertransference, and resistance.

schema Stable, enduring, often unconscious, cognitive structures for screening, coding, evaluating, and organizing stimuli into patterns.

transference The tendency to reenact experiences and relationship patterns from past relationships in the therapeutic relationship.

working models A mental framework of what can be expected from others derived from both observation and inner schemas.

Time-limited dynamic psychotherapy (TLDP) is an interpersonal, time-sensitive approach for patients with chronic, pervasive, dysfunctional ways of relating to others. This article will present TLDP theory, assumptions, goals, formulation, intervention strategies, a clinical illustration, and empirical findings. The goal of TLDP is to help patients change their dysfunctional, interpersonal patterns by fostering new experiences and

new understandings that emanate from the therapeutic relationships.

I. DESCRIPTION OF TREATMENT

A. Definition

Despite proponents dating to the 1920s, for decades the general response of the psychoanalytic establishment to short-term therapies was unreceptive. However, intense interest in brief dynamic therapy resurfaced in the 1970s and early 1980s, and by the 1990s brief intervention had become a treatment of choice for most patients. Confidence in the basic viability of brief therapy was buttressed by empirical research demonstrating that the majority of patients who benefit from psychotherapy do so within the first 6 months, and that success rates are not necessarily dependent on treatment duration.

Time-limited dynamic psychotherapy was developed with the intention of helping clinicians have more successful outcomes when treating patients with self-defeating interpersonal behaviors—the so-called difficult patient—seen in brief treatment. It was designed to target the specific subgroup of patients whose symptomatic problems (anxiety, depression, etc.) are embedded in underlying core patterns of recurrent dysfunctional interpersonal relationships and whose enactment of these dysfunctional patterns generalizes into the therapeutic relationship. When originally conceived, a liberal time limit of 25 to 30 hours was proposed. Currently the time frame is in the 15 to 20 session range, with the therapist maintaining a time-sensitive or focused approach rather than emphasizing a stipulated number of fixed sessions. The focus is not on symptom reduction per se, but rather on altering the way one relates to others and the self. More ambitious or perfectionistic goals, such as extensive personality reconstruction or plumbing the unconscious origins of experience, are generally inappropriate for TLDP.

Consistent with a general trend toward manualizing therapies for research purposes, the principles of TLDP were originally set forth in a manual published in 1984 under the title *Psychotherapy in a New Key*, authored by Hans Strupp and Jeffrey Binder with collaboration from Thomas Schacht. A subsequent volume produced a decade later by Hanna Levenson provides an updated perspective on TLDP. Levenson's approach places more emphasis on change through experiential learning, whereas the 1984 manual stresses insight through interpretation.

B. Assumptions Essential to TLDP Treatment

There are three core assumptions underlying the practice of TLDP.

1. Maladaptive interpersonal patterns acquired early in life underlie many presenting complaints of symptomatic distress and functional impairment.

Early experiences with parental figures inform the child as to what can be expected from others and what is necessary to maintain connectedness with them. These experiences from the building blocks in the mind of the child of what eventually become mental representations or working models of relationships in general.

2. Maladaptive interpersonal patterns acquired early in life persist and are maintained in current relationships, including reenactment in the therapeutic relationship.

Although one's dysfunctional style is learned early in life, according to the TLDP model, the individual's way of seeing the world must be supported in the person's present adult life for interpersonal difficulties to continue. For example, if one's parents were harsh and demanding, it would be understandable if such a child grew into a placating, deferential adult. Displaying such a subservient manner, such a person might inadvertently and unconsciously pull for others to respond in controlling ways—echoing the behavior of the parents.

This recursive focus is consistent with a systems-oriented approach, which holds that if you change one part of the system, other parts will shift as a result. In this manner, "pathology" does not exist solely within the individual, but rather resides in the totality of the interpersonal system that maintains the behavior. From a time-limited viewpoint, this emphasis on the present enables the therapy theoretically to be completed in a shorter amount of time, because the focus is on what is happening in the current interpersonal world of the individual rather than on an archeological dig into one's past.

The relationship that evolves between therapist and patient can be understood as a microcosm of the interpersonal world of the patient. The patient relates to the therapist in ways that are characteristic of interactions with significant others (i.e., transference), and hooks the therapist into responding in a complementary fashion (i.e., countertransference). Although this reenactment of interpersonal difficulties in the therapeutic relationship poses difficulties for the alliance, it is inevitable and also provides the opportunity to transform the therapeutic relationship into a specialized context for reflecting on and changing interpersonal patterns. In

such a manner, the therapist has the opportunity to see the maladaptive interactions evolve in the therapeutic relationship and to discern dysfunctional patterns. Because such patterns are presumed to be sustained through present interactional sequences, the therapist can concentrate on what is happening in the session to alter the patient's experience and understanding.

As pointed out earlier, the therapist in attempting to relate to the patient is unwittingly enlisted into a reenactment of the patient's dysfunctional pattern; in other words, in addition to observing, the therapist becomes a participant in the interaction or a participant observer. The therapist is pushed and pulled by the patient's style and responds accordingly. The therapist's transactional reciprocity and complementarity are not viewed as a "mistake," but rather as a form of interpersonal empathy or role responsiveness. Eventually, the therapist must realize how he or she is replicating this interpersonal dynamic with the patient, and use this information to change the nature of the interaction in a healthier direction.

3. TLDP focuses on one chief problematic relationship pattern.

The emphasis in TLDP is on the patient's most troublesome and pervasive interactive pattern. Although other relationship patterns of less magnitude and inflexibility are important, in a time-limited format pragmatics dictate focusing on the most central interpersonal schema.

C. Goals

1. *New Experience*

The first and major goal is for the patient to have a series of new experiences through which he or she develops a different appreciation of self, of therapist, and of their interaction. These new experiences provide a foundation of experiential learning through which old patterns may be relinquished and new patterns established. The formulation of each particular case (see later) determines what specific types of new experiences will be most helpful in disconfirming the patient's interpersonal schemata and thereby undermining his or her maladaptive style. The concept of a corrective emotional experience described more than 50 years ago by Alexander and French is relevant. They suggested that with experiential learning individuals could change even without insight into the etiology of their problems. It is our current thinking that experiential learning broadens the range of patients who can benefit from a brief therapy format, leads to greater generalization to the outside world, and permits therapists to use a

variety of techniques and strategies in addition to traditional insight-promoting clarification and interpretation. For example, with the placating individual mentioned earlier, the goal might be for him to experience himself as more assertive and the therapist as less punitive within the give and take of the therapeutic hours.

2. *New Understanding*

The second goal of providing a new understanding focuses on helping patients identify and comprehend the nature, etiology, and ramifications of their dysfunctional patterns. To facilitate such an understanding, the TLDP therapist can point out repetitive patterns as they have manifested with past significant others, with present significant others, and with the therapist in the here-and-now of the sessions. Metacommunication occurs when the ongoing process of interpersonal transaction between the patient and therapist becomes the content of the therapeutic dialogue. Therapists disclosing their own reactions (i.e., interactive countertransference) to the patients' behaviors can be of benefit in this regard. In this way, patients can begin to recognize relationship patterns and discern their role in perpetuating the very dysfunctional interaction they wish to change.

D. Patient Suitability

TLDP may be helpful to anyone for whom adequate descriptions of their interpersonal transactions can lead to a dynamic focus. It is designed, however, for people who have lifelong interpersonal difficulties. Table I contains the five major selection criteria and four major exclusionary criteria for ascertaining a patient's suitability for TLDP.

E. Formulation

1. *The Cyclical Maladaptive Pattern*

In long-term treatments, therapists may rely on the patient's spontaneous organizing abilities to bring coherence, over time, to the tacit themes and patterns of their difficulties. However, a time-limited therapy requires a more systematic approach, a core theme or dynamic focus, which acts as a guiding beacon to direct and organize therapeutic activity. In TLDP this core theme is the repetitive dysfunctional interactive sequence that is both historically significant and also a source of current difficulty. This cyclical maladaptive pattern (CMP) provides a framework for deriving a dynamic, interpersonal focus for TLDP. It forms an organizational structure for the various components that contribute to the idiosyncratic vicious cycle of reciprocal interactions. By creating

TABLE I
Selection Criteria for Time-Limited
Dynamic Psychotherapy

Inclusionary

1. Patient is sufficiently uncomfortable with his or her feelings and/or behavior to seek help via psychotherapy.
2. Patient is willing and able to come regularly for appointments and talk about his or her life.
3. Patient is willing to consider the possibility that his or her problems reflect difficulties in relating to others.
4. Patient is open to considering the possibly important role that his or her emotional life plays in interpersonal difficulties.
5. Patient evidences sufficient capacity for relating to others as separate individuals so that identifiable relationship predispositions can be enacted in the therapeutic relationship and then collaboratively examined.

Exclusionary

1. Patient is not able to attend to the process of a verbal give-and-take with the therapist (e.g., patient has delirium, dementia, psychosis, or diminished intellectual status).
2. Patient's problems can be treated more effectively by other means (e.g., patient has specific phobia or manic-depressive illness).
3. Patient cannot tolerate the active, interpretative, interactive therapy process, which often heightens anxiety (e.g., patient has impulse control problems, abuses alcohol and/or substances, or has a history of repeated suicide attempts).
4. Patient's problems are primarily due to environmental factors (e.g., social oppression, imprisonment, poverty).

Adapted from Strupp & Binder (1984) and MacKenzie (1988).

a narrative that incorporates the elements of the CMP, the clinician is guided in developing a treatment plan. A successful CMP should describe the nature and extent of the interpersonal problem, lead to a delineation of the goals, serve as a blueprint for interventions, enable the therapist to anticipate reenactments, and provide a way to assess if the therapy is on track.

2. Constructing the CMP

To derive a TLDP formulation, the therapist uses four categories to gather, organize, and probe for relevant information.

1. Acts of the self. These acts include the thoughts, feelings, motives, perceptions, and behaviors of the patient of an interpersonal nature. "I enjoy social gatherings because I am the life of the party!"

2. Expectations of others' reactions. This category pertains to how the patient imagines others will react to him or her in response to some interpersonal behavior (Act of the Self). "I expect that if I go to the party, everyone will want to talk with me."
3. Acts of others toward the self. This third grouping consists of the actual behaviors of other people as observed (or assumed) and interpreted by the patient. "When I went to the party, people were so concerned with making a big impression on the host, that no one spoke to me."
4. Acts of the self toward the self. In this section belong the patient's behaviors or attitudes toward oneself. "When I left the party, I told myself that it was their loss and felt better."

By linking information in these categories together, a narrative is formed from which emerges themes and redundancies in the patient's transactional interactions. This narrative forms the CMP describing the patient's predominant dysfunctional interactive pattern. The therapist then sets the goals for the treatment by considering what specific types of experiential interactions and new understandings would help weaken the strength, rigidity, and repetitiveness of the patient's CMP.

F. TLDP Strategies

Implementation of TLDP does not rely on a fixed set of techniques. Rather it depends on therapeutic strategies that are seen as embedded in a therapeutic relationship. The Vanderbilt Therapeutic Strategies Scale (VTSS) was designed to measure therapists' adherence to TLDP principles. The 10 items that contain TLDP specific strategies are included in Table II.

In general these therapeutic strategies emphasize clarification and understanding of actions and experiences in the here-and-now rather than excavation of the patient's past. Although a search for historical antecedents may help to clarify current events, archeological exploration of the patient's life history is subordinate to a thorough reconnaissance of present experiences, behaviors, and circumstances. In TLDP the patient and therapist collaboratively "make" the patient's life story, as contrasted with the traditional unilateral "taking" of a life history.

II. THEORETICAL BASE

Historically, TLDP is based in an object-relations, interpersonal framework with roots in attachment theory.

TABLE II
Vanderbilt Therapeutic Strategies Scale

TLDP Specific Strategies:

1. Therapist specifically addresses transactions in the patient–therapist relationship.
2. Therapist encourages the patient to explore feelings and thoughts about the therapist or the therapeutic relationship.
3. Therapist encourages the patient to discuss how the therapist might feel or think about the patient.
4. Therapist discusses own reactions to some aspect of the patient's behavior in relation to the therapist.
5. Therapist attempts to explore patterns that might constitute a cyclical maladaptive pattern in the patient's interpersonal relationships.
6. Therapist asks about the patient's introject (how the patient feels about and treats himself or herself).
7. Therapist links a recurrent pattern of behavior or interpersonal conflict to transactions between the patient and therapist.
8. Therapist addresses obstacles (e.g., silences, coming late, avoidance of meaningful topics) that might influence the therapeutic process.
9. Therapist provides the opportunity for the patient to have a new experience of oneself and/or the therapist relevant to the patient's particular cyclical maladaptive pattern.^a
10. Therapist discusses an aspect of the time-limited nature of TLDP or termination.

Reproduced with permission from Butler, S. F., & Center for Psychotherapy Research Team. (1995). Manual for the Vanderbilt Therapeutic Strategies Scale. In Levenson, H. *Time-limited dynamic psychotherapy: A guide to clinical practice*. pp. 243–254. New York: Basic Books.

^a Item written by H. Levenson.

According to object relations theory, people are innately motivated to maintain human relatedness. Basic tenets of interpersonal theory hold that, all else being equal, people learn to treat themselves in a manner that is complementary to how they are treated by others. Therefore, images of the self and others are considered to be products of social interactions. This relational view contrasts with that of classical psychoanalysis, which holds that drives for sex and aggression and their derivatives take preeminence. From a relational perspective, psychopathology results when recurrent dysfunctional interactions cause the individual to engage in patterns of maladaptive behavior and negative self-appraisal. Although recent applications of TLDP are grounded in psychodynamic theory, they also incorporate cognitive, behavioral, and systems approaches.

III. EMPIRICAL STUDIES

A series of studies done at Vanderbilt University in the 1970s found that therapists have difficulty being therapeutically effective when their patients are negative and hostile; in fact, the therapists themselves can often become hooked into responding with negativity, hostility, and disrespect. These findings led Hans Strupp and colleagues to develop TLDP.

Time-limited dynamic psychotherapy does not belong to the new research paradigm of the so-called empirically validated therapies (EVTs). Rather, TLDP was created to support a long tradition of basic research into the elementary processes distinguishing effective psychotherapy from interventions that are less effective or even harmful. Whereas the EVT concept furthers the idea that it is the technique of treatment that is most important, TLDP, in contrast, stems from a research tradition that underscores the importance of so-called common factors such as the personal qualities of the therapist, the interpersonal nature of the therapeutic relationship, and the quality of the therapeutic alliance. Thus, rather than producing an empirically validated “treatment” per se, TLDP research has sought to validate underlying generic therapeutic principles. TLDP was constructed to provide a fertile arena for investigating these principles, but it is by no means the only therapeutic environment in which similar research could be or has been conducted.

Although the primary emphasis of research has not been to demonstrate that TLDP is effective for particular disorders, many patients in studies involving TLDP have improved. Research on TLDP outcomes found that a majority of patients at a Veterans Administration outpatient clinic achieved positive interpersonal or symptomatic benefit, with almost three-quarters feeling that their problems had lessened by termination. Long-term follow-up of these patients revealed that patient gains were maintained and slightly bolstered, with 80% feeling helped. Other analyses indicated that patients were more likely to value their therapies the more they perceived that the sessions focused on TLDP-congruent strategies such as trying to understand their typical patterns of relating to people. A study examining relational change found that following TLDP, patients significantly shifted in their attachment styles (from insecure to secure) and significantly increased in their secure attachment themes. Other empirical studies have found that patients' images and treatment of themselves are a reflection of the way they were treated by their therapists, and that these internalizations are associated with better outcomes.

With regard to case formulation, empirical research suggests that the TLDP-CMP is a reliable and valid procedure. CMPs from patients who had completed TLDP were read by five clinicians unfamiliar with the cases. Based only on these CMPs, the clinicians' independent ratings showed high levels of interrater agreement with regard to the patients' interpersonal difficulties. Further analyses indicated that there was considerable overlap in problems the raters said should have been discussed with those that actually were discussed. Also the therapies were found to have better outcomes the more they stayed focused on CMP relevant topics. Another study found that themes derived from CMPs corresponded to themes obtained from another psychodynamic formulation method.

With regard to training in TLDP, research has demonstrated that although a programmatic effort to train experienced therapists in TLDP was successful in increasing therapists' use of TLDP strategies, many of the therapists did not reach an acceptable level of TLDP mastery within the training period. Further inquiry into the data also revealed some unintended and potentially untoward training effects. For example, after training the therapists were more willing to be active and as a consequence made more "mistakes," inadvertently becoming less supportive and delivering more complex communications to patients.

In another training study, psychiatry residents and psychology interns changed their attitudes and values about brief therapy in a more positive direction as a result of a 6-month seminar and group supervision in TLDP. In a multisite investigation, similar attitudinal shifts have been found with experienced clinicians who attended 1-day TLDP workshops.

IV. CASE ILLUSTRATION

Ms. R. was a professional woman in her early forties, married for 15 years with three children. She sought psychotherapy for chronic symptoms of depression and anxiety that had been present for several years. Exploration of the interpersonal context of the presenting complaints indicated that Ms. R. frequently experienced others as emotionally distant or uncaring. She responded with complementary interpersonal distancing. For example, she felt that her husband had been unsupportive with child rearing and during a past time of physical illness but rather than expressing her concerns and wishes to him, she concealed her resentment and withdrew from sexual relations without explanation. Ms. R.'s description of her family of origin mir-

rored her current marital relationship. She did not feel close to her siblings. Her relationship with her father was notable for unrequited wishes for greater closeness and involvement. In a prior attempt at psychotherapy, Ms. R. found herself wishing for more time with the therapist, but could not bring herself to reveal this, ultimately choosing instead to discontinue therapy.

From the opening moments of the first interview, her TLDP therapist focused on Ms. R.'s current problems, especially as they were reflected in relationships with others and in concerns and expectations regarding the therapist. The beginning of the therapeutic relationship was a primary source of clues for a focal theme. Ms. R. expressed concern about the cost of treatment and added that she had not felt able to discuss this with her husband. She indicated that she was having second thoughts about therapy, and wondered if treatment would be a mistake. The therapist invited associations that eventually linked Ms. R.'s descriptions of uncomfortable affective states to accompanying interpersonal contexts. A search for similarities in patterns across contexts clarified how Ms. R.'s ambivalence about therapy stemmed from a fear that participation in treatment would disturb her marriage. In response to a comment from the therapist inviting associations to her apparent anger and resentment, Ms. R. reported a fear that her husband would perceive her seeking therapy as a rejection of him. She then wondered if therapy might also represent an indirect act of aggression toward him. Such early clarifications and interpretations allowed the therapist to assess Ms. R.'s capacity to participate in collaborative inquiry and probed her response to the work of therapy.

In emphasizing the interpersonal context of Ms. R.'s presenting complaints, the therapist set the stage for identification of a focal theme. In Ms. R.'s case, a theme was identified the essence of which was: "If I ask for what I want, I will be disappointed and will feel useless and worthless. If I don't want to be hurt or abandoned, I must always be polite and must do what others want. I must avoid standing up for myself and must never express anger toward men and must always subordinate my wishes to theirs. If something goes wrong in my relationships, it must be my fault and I am responsible for correcting the situation." Consistent with this theme, Ms. R. often perceived others as withholding what she wanted or needed, and as unresponsive to issues of relationship fairness that were important to her. Although the superficial expression of this theme takes the form of a subdued and unemotional exterior, there is a subtextual theme of covert hostility that finds indirect expression in complementary withholding, in withdrawal, or in subtle or passive forms of aggression.

The therapist used this theme as a heuristic to guide construction of organizing questions and comments designed to stimulate the patient's curiosity and foster collaborative effort. Even as Ms. R. was discussing her husband, other comments, behavior, and perceptions suggested that she often felt similarly toward the therapist. For example, she expected that the therapist would criticize her for her reluctance to tell her husband about seeking psychotherapy. Ms. R. expressed a fear that she would run out of things to say, and that the therapist would respond judgmentally and would refrain from helping her, leaving her cruelly tongue-tied. Similarly, when the therapist agreed to accept her into a time-limited 25-session treatment immediately following the initial interview, she did not experience this as a helpful gesture, but rather perceived the offer of help as a form of coercive pressure, as if the therapist had said: "You can be my patient, but only on my terms and my schedule, and you must choose now." The potential for such transference enactment was continuously in the background of the therapist's awareness.

As treatment progressed, Ms. R. and the therapist reencountered examples of the enactment of this focal theme in narratives about primary childhood relationships, other current family relationships, romantic relationships including her current marriage, and her relationship with the therapist. Within a few sessions, this dynamic focus was sufficiently salient that the therapist proposed to Ms. R. that working on the manifestations of this theme become a primary goal for their continuing sessions.

In future sessions, Ms. R.'s primary task was to verbalize whatever came to her mind. However, she often began her sessions with an awkward silence and an aloof stare that most likely reflected the vigilance associated with ingrained expectations that others will be displeased with her. At the beginning of therapy, as expected according to the principles of interpersonal complementarity, the therapist alternately felt bored, irritated, or subtly dismissive in response to Ms. R.'s criticality and withdrawn stance. For example, in the third session, the therapist, annoyed with the patient's indirect criticism of him, began to think about a highly successful intervention he had made with a previous patient. As he was in the midst of this self-congratulatory reverie, he lost track of what Ms. R. was saying. His emotional distance echoed the behavior of Ms. R.'s husband (and others in her life) and in fact was a reenactment of the very CMP that had become the focus of the therapeutic work.

Ms. R., hurt by her therapist's inattention, started to berate him and then trailed into a series of self-deni-

grating statements with sullen affect. The therapist, reflecting on this transactional process in the moment, realized that he had been countertransferentially responding to Ms. R.'s behavior and attitude. Rather than defensively denying his inattentiveness, the therapist admitted his lapse, and helped Ms. R. to express directly her disappointment and anger toward him. Together they explored the interactional sequence leading up to their mutual disconnect. The therapist did not punish Ms. R. or excuse his own dismissive behavior, but rather welcomed hearing her feelings, thereby providing her with a reparative interpersonal experience. As other such reenactments were therapeutically addressed, they became fewer and farther between.

For much of the therapy the therapist was able to support, clarify, elaborate, and link Ms. R.'s concerns to the core theme. Connections between Ms. R.'s current experience and the past helped to clarify Ms. R.'s perception of her circumstances, while also highlighting their anachronistic character and underscoring elements of distortion associated with transference experience. Exploration of the past was important, but clearly subordinate to the therapist's endeavors to stay close to the patient's emotional experience. To this end, the therapist used simple evocative language and avoided complex constructions or abstract interpretations that were likely to move the patient away from her affective experience. Redundant encounters with the focal theme provided repeated opportunities for discussion and corrective emotional experience derived from the contrast between Ms. R.'s transference expectations and what actually occurred with the therapist. In this portion of the work, both the process and the content of the therapeutic dialogue had a healing impact. Indeed, the therapist's behavior often spoke more loudly than his words. A verbal profession of support for Ms. R.'s autonomy would have been of little value if the therapist's conduct simultaneously expressed criticism or infringed on that same autonomy.

Numerous examples of such corrective emotional experiences occurred as the therapy progressed. The therapeutic dyad encountered numerous variations on the focal theme, each a different facet of the theme's pervasive presence in Ms. R.'s life. Around the 20th session, Ms. R.'s concerns turned urgently to the impending termination date. She pressed the therapist for reassurance that therapy would not really have to stop at the agreed time. In response, the therapist maintained the same exploratory stance that had carried the relationship forward from the beginning. Thus, the therapist expressed curiosity about the patient's emotional experience and

her wishes and fears associated with the anticipated end of the therapeutic relationship. The therapist did not attempt to reassure Ms. R. that everything would be OK or that the treatment had accomplished enough. Instead, he treated her responses to termination in the same manner as all other material that Ms. R. had brought to the therapy—as expressions of her central relationship issues.

As termination approached, Ms. R. initially pressed the therapist with rational arguments, protesting that while she had become much more aware of her automatic interpersonal predispositions, she needed much more therapeutic time to master alternative responses. When these arguments failed to elicit the desired amendment to the scheduled termination, Ms. R. then regressed temporarily, sarcastically stating that the therapist was putting her through hell and then withholding further disclosure by refusing to discuss her feelings. Despite Ms. R.'s provocative conduct, the therapist managed not to respond with complementary intensity or negative reaction, but instead maintained a gentle, receptive, and supportive curiosity. The therapist acknowledged Ms. R.'s experience of loss, empathized with her perception that she felt like a helpless child being summarily dismissed by an unfeeling parent, and clarified this fear of rejection and abandonment as a recapitulation of earlier traumas as expressed in the focal theme. The therapist also pointed out the realistic limitations of the therapy, emphasizing what Ms. R. had gained rather than what she imagined she may have foregone by terminating treatment at this time. In this way, the termination phase continued the primary work of the therapy, while also assisting the patient in a corrective emotional experience, namely experiencing the loss of the therapist via normal grief and mourning, rather than as a maladaptive resentment from perceived deprivation.

At their last session, Ms. R. indicated acceptance of the termination and reported that she felt "ready." She framed the termination positively via a metaphor of graduation, rather than negatively via analogy to divorce, abandonment, or ex-communication as would have been expected based on her focal theme. She verbalized comfort in the knowledge that further therapy was possible in the future if she encountered difficulties that she could not master on her own. She and the therapist parted with a sincere and warm good-bye.

V. SUMMARY

TLDP was developed to help therapists treat difficult patients within a brief therapy format. In TLDP, problems are defined in terms of a dynamic focus that formulates dysfunctional interpersonal patterns. The treatment process includes development and maintenance of a therapeutic alliance in the face of the patient's dysfunctional patterns and the therapist's own interpersonal proclivities. Therapeutic strategies include observing the inevitable reenactment of those patterns in the therapeutic relationship, metacommunicating about them, and providing opportunities for experiential learning.

See Also the Following Articles

Brief Therapy ■ Efficacy ■ Manualized Behavior Therapy ■ Minimal Therapist Contact Treatments ■ Outcome Measures ■ Single-Session Therapy ■ Solution-Focused Brief Therapy ■ Termination ■ Supportive-Expressive Dynamic Psychotherapy

Further Reading

- Benjamin, L. S. (1993). *Interpersonal diagnosis and treatment of personality disorders*. New York: Guilford.
- Henry, W. P., Schacht, T. E., & Strupp, H. H. (1986). Structural analysis of social behavior: Application to a study of interpersonal process in differential psychotherapeutic outcome. *Journal of Consulting and Clinical Psychology, 54*, 27–31.
- Henry, W. P., Schacht, T. E., & Strupp, H. H. (1990). Patient and therapist introject, interpersonal process, and differential psychotherapy outcome. *Journal of Consulting and Clinical Psychology, 58*, 768–774.
- Levenson, H. (1995). *Time-limited dynamic psychotherapy: A guide to clinical practice*. New York: Basic Books.
- Levenson, H. (1998). *Time-limited dynamic psychotherapy: Making every session count. Video and viewer's manual*. San Francisco: Levenson Institute for Training.
- Messer, S. B., & Warren, C. S. (1995). *Models of brief psychodynamic therapy: A comparative approach*. New York: Guilford.
- Schacht, T. E., & Henry, W. P. (1994). Modeling recurrent patterns of interpersonal relationship with structural analysis of social behavior: The SASB-CMP. *Psychotherapy Research, 4*, 207–220.
- Strupp, H. H., & Binder, J. L. (1984). *Psychotherapy in a new key: A guide to time-limited dynamic psychotherapy*. New York: Basic Books.
- Wachtel, P. L. (1997). *Psychoanalysis, behavior theory, and the relational world*. Washington, DC: American Psychological Association.

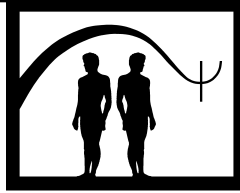

Timeout

Rebecca S. Griffin and Alan M. Gross

University of Mississippi

- I. Description of Treatment
 - II. Theoretical Bases
 - III. Empirical Studies
 - IV. Summary
- Further Reading

This article will further define the concept of timeout, suggest typical methods for successful implementation of the timeout procedure, discuss the theoretical bases on which the technique relies, and identify several empirically supported variations of the technique.

GLOSSARY

functional analysis Assessing a set of circumstances (e.g., through observation, interview, collection, and analysis of data) to identify and target variables that are influencing problematic behavior.

operational definition (of a behavior) A clear, specific description of a behavior so that it can be more easily targeted for change. For example, rather than targeting general “non-compliance,” it is easier to target more specific “refusal to comply with direct instructions provided by an adult.”

positive reinforcement (or reward) A situation or event, often pleasant in nature, which, when delivered contingent on the occurrence of a behavior, results in an increase in frequency of that behavior.

punishment An event following a behavior that thereby decreases the likelihood that the behavior will recur in the future.

Timeout is a punishment technique such that, following an act of negative behavior, a child spends a brief period of time in an environment less reinforcing than that in which the behavior originally occurred.

I. DESCRIPTION OF TREATMENT

Timeout is a disciplinary technique that, when used correctly and consistently, can be quite effective in reducing maladaptive behavior patterns of children. Although several major principles of behavior modification may be involved with the use of timeout, the procedure is in its most basic form a punishment procedure, because it denies a child access to activities or situations that are sources of positive reinforcement. Thus, the term “timeout” suggests that a child is shifted from being in a reinforcing environment to being in an unpleasant or less reinforcing environment. It is important to note that timeout appears to be most effective when used in combination with other techniques, such as rewarding appropriate behaviors, and therefore encouraging greater frequency of positive behavior.

A. When to Use Timeout

The use of timeout can be effective for children from toddlerhood through adolescence, and in some cases even for adults, and can be used in many different

settings. Schoolteachers often find the technique quite useful in handling classroom disruptions. The procedure is also valuable in working with individuals with developmental delays, inpatient residents in psychiatric settings, children who are aggressive toward siblings or peers, or in families with children who are defiant or noncompliant. Timeout can reduce behaviors such as tantrums, aggression, inattention, refusal to follow directions, inappropriate social comments or actions, or self-injurious behavior.

B. Functional Analysis

Before considering the use of timeout on a consistent basis, a functional analysis should be conducted to identify typical patterns of problematic behavior. A functional analysis can be conducted through the use of both formal and informal methods. Formal methods might include a distinct written operational definition of the target behavior, noting when and where the behavior does and does not occur (e.g., percentage of the time, duration of incidents, number of occurrences per time period). The graphing or charting of trends might be helpful both before and after starting the timeout strategy so that changes in patterns of behavior are easily evident. More informal methods of functional analysis might involve making notes on a calendar or simply being more attentive to potential triggers of behavioral outbursts. Jill Taylor and Michelle Miller provide several classroom case examples illustrating how a thorough functional analysis can lead to successful timeout implementation, or can help identify why the procedure is not producing desired results.

Whether formal or informal methods are used, the goal of the functional analysis is to determine typical antecedents and consequences of the child's actions. Determining the contingencies that could be reinforcing the undesired behavior can help the adult anticipate under what circumstances the behavior is likely to occur. In addition, this information can be used in setting realistic goals for timeout. It is important to set a clear goal (e.g., decrease the behavior by a certain amount) and to recognize and reward the child as positive changes happen and when goals are met.

C. Type of Timeout

Jennie Brantner and Michael Doherty defined three major categories of timeouts: isolation, exclusion, and nonexclusion. Isolation timeout is one in which a child is taken to a solitary, non-reinforcing area, separate in location from where the inappropriate behavior oc-

curred. At home or at school, this might be a hallway or other specified room (where the adult can monitor the child, but without reinforcers present). Alternately, exclusion timeout means that the child is not actually removed from the room where the behavior occurred, but is also not allowed to participate in or view ongoing activities. An example of this would be having the child sit in a chair facing the wall. Russell Barkley suggests a modification of these ideas for use in public places, such that the child can be placed in a quiet corner facing the wall or can be taken to the car for a timeout.

The third category of timeout is nonexclusion, meaning that the child is able to view ongoing activities but the child's participation is restricted for a period of time following undesired behavior. Brantner and Doherty identified three further variations of non-exclusion timeout. The first variation, titled contingent observation, requires the child to sit on the periphery of activities and watch what is occurring, which might include observing others continue to receive reinforcement. Another variation is removing reinforcing materials, or giving a "timeout" to the television, toys, games, or stereo being used by the child. This seems particularly effective for older children or adolescents. A third variation of non-exclusion time-out is simply ignoring the child, so that reinforcement is not being provided for a period of time. This could include turning away from the child or refusing to interact for a period of time.

To choose which type of timeout will be most effective, one must consider the disruptiveness of the behavior itself, the age, and developmental level of the child (i.e., a very young child may be far less receptive to an isolation timeout), whether or not the behavior occurred in a group setting, and any potential reinforcers in the setting where the behavior occurred (e.g., peer attention). Charles Wolfgang offers several examples of charts useful for record keeping if timeout is to be implemented in a school or group setting, and emphasizes the importance of implementing timeouts without allowing ridicule or social reinforcement from peers. Russell Barkley offers suggestions for training parents to use the technique, such as modeling the procedure for parents and dealing with frustration commonly experienced when implementing a new timeout program. Barkley also offers several adaptations in the procedure, such as incorporating a token economy system and taking additional measures to deal with a child's noncompliance with timeout.

D. Duration of Timeout

There has been considerable debate among researchers and behavior modification experts regarding

the appropriate duration of timeout. The effectiveness of different lengths of time has been empirically tested and has produced varying results. Therefore, there is no absolute standard regarding how long a child should remain in a timeout. Some experts suggest a range of 1 to 5 min, whereas others suggest lengths of up to 20 min for older children. A typical rule of thumb is to require 1 min for each year of a child's age (e.g., a 5-year-old should receive a 5-min timeout). This rule seems logical, because a younger child will likely possess less patience than will an older child. However, this should not be an inflexible standard, because a child's developmental level should also be considered. For example, a 8-year-old who is developmentally delayed might receive beneficial effects from a timeout much shorter than 8 min in duration. For any child, use of a kitchen timer or buzzer can avert arguments or incessant questioning about when timeout has ended.

In determining appropriate timeout length, each child should be considered on an individual basis. The importance is to achieve the aversive and punishing nature of the timeout. That is, too short a timeout might not be perceived as aversive, whereas too long a timeout prevents opportunities to practice other behaviors. In either case, inappropriate duration of a timeout will ultimately be less effective in achieving the ultimate goal: reducing maladaptive behavior.

E. Providing Instructions

Before implementing timeout, the child must know ahead of time what the rules are and what consequences to expect when they are broken. R. Vance Hall and Marilyn C. Hall provide guidelines for explaining timeout to an individual. The adult must first explain to the child the specific target behaviors that will result in a timeout and convey that timeout will be enforced each and every time that behavior occurs. The length of timeout should be preestablished, and the child should know what indicates the end of a timeout. The adult should explain where the child is to spend timeout, and this designated area should be used consistently. If a "timeout chair" will be used, Russell Barkley suggests leaving the chair out for a few weeks to serve as a reminder of consequences. After explaining the entire procedure, younger children might benefit from practicing or role playing a pretend timeout, so they will know what to expect under real circumstances.

The child must also understand that certain behaviors can extend the duration of timeout. For example, screaming, arguing, leaving the timeout area, or other similar conduct should each extend the timeout (e.g., 1

minute for each infraction). The adult must enforce this rule, even if it initially leads to very long timeouts. Without enforcing this procedure, the child might manipulate his or her way out of the consequences and likely attempt that same tactic in later timeout sessions.

When a child's behavior actually warrants a timeout, the adult must deliver consequences in a calm, neutral manner. Russell Barkley suggests redirecting the behavior, waiting a 5 sec count, then warning the child that a timeout will occur if compliance with the request does not occur, waiting another 5-sec count, and if the child fails to respond appropriately, then direct the child to the timeout area. Many variations on this sequence can occur, depending on the child and the infraction. On the end of timeout, the child should be required to resolve the issue or behavior which necessitated timeout in the first place (e.g., if the timeout was for refusing to put away his toys, the child should put away his toys immediately following timeout). Otherwise, the child might begin using timeout as an escape from responsibilities. Consistent rewards, positive attention, and praise should be offered when the child demonstrates positive behavior following a timeout. In starting a new timeout program, the adult should initially expect resistance from the child, particularly if tantrums have been an effective ploy in the past. However, the adult must be willing to enforce timeouts in the same manner each time the behavior occurs. Without consistency, the technique will not be effective and will end up being more work for the adult than it is designed to be when used correctly.

F. When Timeout Does Not Work

If timeout seems ineffective, several factors could be the cause. Perhaps the target behavior is too vague, and the child is having difficulty understanding what behaviors are appropriate. On the other hand, perhaps the "timein" (time spent engaging in supposedly reinforcing activities) is not really rewarding. Thus, timeout might not seem so terrible an option. It could be that the child is using misbehavior and subsequent timeout as a way to gain attention or avoid being in particular environments. In addition, perhaps reinforcement is not being provided for positive displays of behavior. Adults who work to increase positive interactions with the child on a regular basis will be offering a more rewarding "timein," which builds a positive and supportive relationship and offers a little more leverage when disciplining the child.

Even if applied in a consistent and straightforward manner, some children react drastically to timeouts.

These reactions might include severe temper tantrums, physical aggression toward the adult, refusal to go to the timeout area, or leaving the timeout area before the required amount of time has been served. Adults must be prepared for these reactions so they can be dealt with accordingly. If a child is very young, he or she may be physically placed in the timeout area or restrained gently in the chair. If a child refuses to go to or repeatedly leaves the timeout area, extra time may be included or additional punishment (e.g., taking away other privileges) can be utilized.

II. THEORETICAL BASES

Timeout is based on the principle of punishment. Alan Bellack, Michel Hersen, and Alan Kazdin note that in his conceptualization of punishment, B. F. Skinner differentiated between two classes of punishment: one in which existing (often rewarding) stimuli are removed, and one in which new (often unpleasant) stimuli are introduced. A negative punishment (e.g., timeout) would fit into the first class, whereas a positive punishment (e.g., spanking) would fit into the second class. Barkley suggests that use of punishment should only be considered as an alternative after rewards or incentives fail to encourage positive behavior. He also notes that punishment usually fails to be effective when presented in a situation in which no regular positive interactions occur. Therefore, parents must accept some responsibility in finding ways to encourage positive behavior, as well as anticipating potential behavior problems. Simply reacting to negative behavior may encourage helplessness or guilt in a child, because few positive interactions are likely to occur on a consistent basis.

Karen Harris noted that the most important defining characteristic of an effective timeout is the discrepancy between "timein" and "timeout" environments. A timeout will not be perceived as a punishing event if the environment from which the child was removed was never rewarding to begin with. This idea also emphasizes the need for praise and positive social interactions between the adult and child, so that the child will value the "timein."

III. EMPIRICAL STUDIES

In considering length of timeout, Jennie Brantner and Michael Doherty reviewed timeout studies across different types of problem behaviors and in various set-

tings. They were able to conclude that short intervals of timeouts (i.e., 5 min or less) can be quite effective with many populations and in many different settings. Successful use of the timeout technique has been documented with normal children in a family setting; with individuals in inpatient psychiatric settings; with defiant, assaultive, or delinquent adolescents; and in classroom settings at virtually all age and educational levels (to treat behaviors such as noncompliance with rules or inattentiveness). Timeout procedures can also be quite effective in working with autistic children and with children, who are mentally retarded particularly in dealing with aggressiveness or to shape new behaviors such as correct toileting habits. Timeout has been proven to be effective in dealing with a variety of undesirable behaviors, such as aggression, defiance, noncompliance with rules, temper tantrums, being argumentative, inappropriate social interactions, or engaging in self-injurious behavior. A timeout can also serve as a punisher during any type of training task, if the individual already understands and is capable of the desired response.

Robert Jones, Howard Sloane, and Mark Roberts targeted aggressive behavior, comparing the effectiveness of an immediate timeout versus a "don't" instructional command, which included "don't" directives, reinforcement for compliance, a warning for noncompliance, and finally a timeout for noncompliance with the warning. The immediate timeout proved more effective in reducing aggression, possibly because the "don't" procedure offered less immediate consequences and provided more social reinforcement and attention for misbehavior.

David Reitman and Ronald Drabman described an adjustment in implementing timeouts with children who typically become verbally noncompliant. The procedure is called "Read My Fingertips" and has the adult nonverbally add additional minutes to the timeout, by touching each finger one by one, increasing the timeout one extra minute for each argumentative word spoken by the child. If the child understood the procedure ahead of time, the authors found the technique highly effective in reducing arguing that typically followed a directive to go to timeout.

R. M. Foxx and S. T. Shapiro implemented a nonexclusionary "timeout ribbon" procedure for use in a group setting with children with mental retardation. Following positive behavior, such children were given colored ribbons to wear and received edible reinforcers every few minutes for maintaining appropriate behavior. When misbehavior occurred, a timeout was issued,

meaning that the child's ribbon was removed, and the child received no reinforcement for a brief period. The procedure was found to be useful in reducing undesirable behavior, it did not noticeably disrupt the group as a whole, and the teacher was usually able to continue the procedure alone without extra staff on hand to assist.

There are countless studies and reviews (e.g., Karen Harris; Bellack, Hersen & Kazdin; Brantner and Doherty) examining specific cases and providing continued support for the effectiveness of timeout, particularly when compared with other behavior modification procedures. Although timeout may not work for every individual, there is abundant data to suggest that its use can be quite beneficial in many cases and across many settings.

IV. SUMMARY

When implemented consistently and in combination with reinforcement for positive actions, timeout can be a beneficial method for decreasing negative behavior. As a punishment technique following misbehavior, timeout prevents an individual's access to a more rewarding environment for a brief period of time. There are various subcategories of timeout, which can be adjusted depending on an individual's age, developmental level, and setting in which timeout will be used. A functional analysis can help clarify target behaviors and goals for change, as well as encourage recognition and reward for positive change. Alternate methods of discipline should be in place if timeout fails to be successful. Although timeout may not be successful for every possible situation, there is much evidence to suggest its efficacy across numerous settings and populations.

See Also the Following Articles

Applied Behavior Analysis ■ Conditioned Reinforcement ■ Contingency Management ■ Functional Analysis of Behavior ■ Good Behavior Game ■ Negative Reinforcement ■ Positive Reinforcement ■ Primary-Care Behavioral Pediatrics ■ Response Cost ■ Token Economy

Further Reading

- Barkley, R. A. (1997). *Defiant children: A clinician's manual for assessment and parent training* (2nd ed.). New York: Guilford Press.
- Bellack, A. S., Hersen, M., & Kazdin, A. E. (Eds.). (1990). *International handbook of behavior modification and therapy* (2nd ed.). New York: Plenum.
- Brantner, J. P., & Doherty, M. A. (1983). A review of timeout: A conceptual and methodological analysis. In S. Axelrod & J. Apsche (Eds.), *The effects of punishment on human behavior* (pp. 87–132). New York: Academic.
- Foxx, R. M., & Shapiro, S. T. (1978). The timeout ribbon: A nonexclusionary timeout procedure. *Journal of Applied Behavior Analysis, 11*, 125–136.
- Hall, R. V., & Hall, M. L. (1998). *How to use time out* (2nd ed.). Austin, TX: Pro-Ed.
- Harris, K. R. (1985). Definition, parametric, and procedural considerations in timeout interventions and research. *Exceptional Children, 51*(4), 279–288.
- Jones, R. N., Sloane, H. N., & Roberts, M. W. (1992). Limitations of "don't" instructional control. *Behavior Therapy, 23*, 131–140.
- Reitman, D., & Drabman, R. S. (1996). Read my fingertips: A procedure for enhancing the effectiveness of time-out with argumentative children. *Child & Family Behavior Therapy, 18*(2), 35–40.
- Taylor, J., & Miller, M. (1997). When timeout works some of the time: The importance of treatment integrity and functional assessment. *School Psychology Quarterly, 12*(1), 4–22.
- Wolfgang, C. H. (1999). *Solving discipline problems: Methods and models for today's teachers* (4th ed.). Boston: Allyn and Bacon.

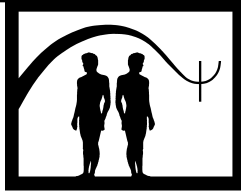

Token Economy

Paul Stuve and Julian A. Salinas

Fulton State Hospital and The University of Missouri School of Medicine

- I. Description
 - II. Theoretical Bases
 - III. Applications and Exclusions
 - IV. Empirical Studies
 - V. Case Illustration
 - VI. Summary
- Further Reading

GLOSSARY

backup reinforcers Goods and privileges purchased with tokens that provide the token with its reward value.

change agent Person who administers reinforcers to a client contingent on the performance of a behavior or set of behaviors according to a prescribed plan.

extinction A reduction in the frequency of a behavior upon the cessation of its reinforcement.

generalized reinforcers Secondary reinforcers that are associated with a wide variety of reinforcing stimuli. Money is an example.

law of association by contiguity A fundamental law of learning that states that two events will come to be associated, or mean the same thing, if they are contiguous or occur together.

law of effect A fundamental law of learning that states that the frequency of a behavior is dependent on its resulting effects or consequences.

level system A supplementary system to a token economy program that involves different stages through which clients progress according to their mastery of specific behavioral competencies. Each stage, or level, is associated with more

demanding reinforcement contingencies. The goal of such level systems is often to remove the use of tokens entirely.

negative punishment (response cost) The removal of a desirable event following a behavior that serves to reduce the frequency of that behavior.

negative reinforcement Increasing the frequency of a behavior by removing aversive stimuli as a consequence of that behavior.

positive punishment (aversion) The application of an aversive event following a behavior that serves to reduce the frequency of that behavior.

positive reinforcement Increasing the frequency of a behavior by applying desirable stimuli as a consequence of that behavior.

primary reinforcers Stimuli that have an “unlearned” reinforcing value. These are things that are critical to our survival, such as water, food, and sleep.

prompts Events that initiate a behavior, which is subsequently reinforced. These include a specific instruction of the expected behavior and its associated consequence.

punishment Arranging consequences of a behavior to decrease the frequency of that behavior.

reinforcement Arranging consequences of a behavior to increase the frequency of that behavior.

secondary reinforcers Stimuli that gain reinforcing value after being associated with primary reinforcers.

social reinforcers Social stimuli, such as attention, facial expressions, and verbalizations, that come to have a reinforcement value after being associated with other reinforcers.

stimulus sampling Procedure whereby clients are permitted to try a variety of reinforcers at no cost to generate interest and increase the likelihood that they will purchase the reinforcer with tokens once the sampling period is over.

time-out from reinforcement Removal of the client from all sources of reinforcement for a specified period of time to reduce the frequency of a particular behavior. Usually takes place in an isolated room or quiet area.

token Any symbolic material that can be exchanged for backup reinforcers. Tokens often consist of coins, poker chips, or cardboard squares.

I. DESCRIPTION

A token economy program (TEP) is a system whereby clients earn tokens in exchange for engaging in designated target behaviors. In some TEPs, clients will also lose tokens or be “fined” in response to engaging in inappropriate behaviors.

Just as we use money to buy the things we want, clients in a TEP exchange their tokens for a variety of desirable backup reinforcers, including food, beverages, magazines, toiletries, CDs, potted plants, toys, crayons, school supplies, and other desirable goods. Clients in residential settings may be given the opportunity to purchase a private bedroom, room furnishings, or home passes. Persons in TEPs in correctional settings often spend tokens to buy the privilege to wear their own, rather than institutional, clothes.

Backup reinforcers are available to the clients at specified times during the day, often through a well-stocked “token store” that functions like a small convenience store. In addition, other things purchased with tokens include time to watch TV or play a video game, trips to town for movies or other leisure events, and other desirable privileges. Because most people engage in such behaviors at a high rate when given the opportunity, these high-frequency behaviors are often used as reinforcers in TEPs. Improving the selection of backup reinforcers available, instituting time-limited sales, and holding auctions of highly desirable items all enhance token spending and associated client performance.

Tokens are disbursed by a change agent (e.g., psychiatric aide, educator, or parent) contingent on the performance of desired behaviors by the client. Change agents play active roles in TEPs, including informing the client of the contingencies for earning, spending, and/or losing tokens, and providing prompts as needed. In addition, as the goal of token economy programs is often for a behavior or set of behaviors to take place and be reinforced in the “natural” environment, token reinforcement and prompts are often withdrawn once consistent rates of the desired behaviors have been achieved. Change agents therefore deliver social

reinforcers in addition to tokens to help maintain behavior when tokens are withdrawn. In addition, the transfer from a token economy back to a natural environment may include a transition from tokens to more abstract credit vouchers and eventually to money. This transition may be facilitated by a level system, whereby clients demonstrating the acquisition of certain competencies are “promoted” to a higher level that has more demanding contingencies associated with the client’s improved functioning. The highest level of such a program could include elimination of tokens.

II. THEORETICAL BASES

B. F. Skinner’s pioneering work in operant conditioning is generally credited with providing the theoretical foundation for the development of token economies. It is assumed that basic laws of learning account for the occurrence of behaviors, whether adaptive or maladaptive, and these same laws can be extended to change these behaviors through the thoughtful engineering of environmental events.

Two major laws synthesize theories of learning and have been validated by a body of basic and applied research. The law of effect states that the frequency of a behavior is dependent on the resulting consequences, or effects. Thus, behavior is strengthened or weakened by what follows it in the environment. In fact, a consistent finding has been that the more immediately a consequence follows a behavior, the greater effect it will have. Reinforcement always has the effect of increasing the likelihood or recurrence of behavior. In positive reinforcement this is done by adding a positive or desirable event (e.g., tokens) to the environment when a behavior occurs. In negative reinforcement, it is accomplished by removing an unpleasant or aversive event from the environment after a behavior occurs. A patient who utters threatening comments in a therapy group that she dislikes will have this behavior negatively reinforced if she is subsequently asked to leave the group (removal of an aversive event) and can be expected to make such statements with greater frequency to avoid that group.

Decreasing the frequency of a behavior is accomplished by removing reinforcement, or extinction. For example, some research shows that self-injurious behavior (e.g., head banging, hair pulling) in children with disabilities generally results in attention from caregivers (e.g., verbalizations of concern, physical intervention). Often, this attention positively reinforces

the self-injurious behavior. Brian Iwata and colleagues have repeatedly demonstrated that when such attention is withdrawn, a marked decrease in self-injury ensues.

Behavior can also be decreased by use of punishment. In positive punishment, this consists of applying an aversive event (e.g., spanking a child) following the target behavior, whereas in negative punishment the consequence involves removing a desirable event (e.g., removing a child's privileges). Punishment is most effective when used for brief periods and in combination with reinforcement for desirable behaviors. It is not recommended for use by itself.

The second law of learning is the law of association by contiguity. It states that two events will come to be associated if they are contiguous or occur together. Thus, things that are not reinforcing in and of themselves can become reinforcing by pairing them with things that are. By pairing tokens with a primary reinforcer such as food, the tokens become secondary reinforcers. Eventually, through association with a variety of primary and secondary reinforcers, tokens will become generalized reinforcers.

III. APPLICATIONS AND EXCLUSIONS

Because the operant conditioning principles on which TEPs are founded apply to all behavior, it is not surprising that TEPs have been developed to deal with a large variety of populations and target behaviors. They have been found to be effective in increasing exercise regimens in chronic pain patients; reducing cigarette smoking in psychiatric outpatients; improving outpatient therapy attendance and participation; reducing alcohol consumption and illicit drug usage in outpatient alcohol and substance abusers; increasing dietary compliance for individuals with diabetes or renal problems; promoting weight loss; improving word finding and decreasing misarticulations in aphasic patients; reducing temper tantrums, teasing, and other "acting out" by children in the home; eliminating thumb sucking; increasing self-care skills, social interaction, and exercise in geriatric patients; reducing stuttering; eliminating enuresis and encopresis; decreasing chronic nail biting; and improving marital satisfaction.

Token economy programs have also been applied to broader social issues, with successful implementations resulting in increased bus use at a major university, increased safety practices (and reduced injuries) at a pit mining operation, increased seat-belt use in young-

sters, and increased litter control at a residential facility for individuals with mental retardation.

As should be apparent by now, participants for TEPs are not identified by focusing on psychological syndromes or diagnostic categories. Rather, the focus of the TEP is on the frequency and intensity of target behaviors. Thus, a TEP in a psychiatric hospital may focus on increasing grooming and hygiene, basic conversational skills, and vocational skills, and on decreasing assaultive and other maladaptive behaviors. It does not focus on treating "schizophrenia." Similarly, the social skills and academic skills of youth residing in correctional facilities may be addressed by a TEP. The TEP is not, however, used to treat "delinquency." In fact, although this article appears in the *Encyclopedia of Psychotherapy*, a TEP is not a "psychotherapy" or "treatment" per se. Rather, it is an extremely flexible organizational system used to deliver a wide range of plans for changing behavior. As Gordon Paul and Robert Lentz explained in 1977, the treatments delivered by two TEPs may be no more related to each other "than the action of heroin is related to that of penicillin, even though both are administered by injection."

IV. EMPIRICAL STUDIES

The bulk of the research on TEPs focuses on four populations: psychiatric patients, individuals with mental retardation, schoolchildren, and correctional populations. Although it is certainly possible to apply diagnostic labels to these groups, it is important to reiterate that the focus of TEPs is on identifiable behaviors and not syndromes. Common targets across these populations include enhancing "motivation," increasing social and adaptive behaviors, and decreasing maladaptive and dangerous behaviors.

A. Psychiatric Patients

The first TEP for psychiatric inpatients with severe disabilities was implemented at Anna State Hospital in Illinois in the 1960s by Teodoro Ayllon and Nathan Azrin. Their research demonstrated that changes in the patients' off-ward job choices and increased performance of the non-preferred jobs resulted through use of token reinforcers. In another TEP at a VA hospital, John Atthowe and Leonard Krasner reported that previously catatonic, withdrawn, or isolated patients demonstrated a significant lessening of apathy indicated by requesting and receiving overnight passes with family,

going to the canteen, and engaging in a variety of social interactions on the ward such as playing pool or card games (where betting was done with tokens).

Other target behaviors addressed by early TEPs with psychiatric patients included grooming and hygiene, bedroom care, attendance and participation in group activities, general cooperativeness with ward rules, and social functioning. Scores of publications show patient improvements in all of these areas, as compared to either their own pre-TEP behaviors, or to behaviors of patients on non-TEP wards.

In addition to these increases in appropriate and adaptive behaviors, psychiatric patients in TEPs have shown decreases in inappropriate and maladaptive behaviors as well. Some of these reductions occurred without being directly targeted, apparently as side effects of improvements in adaptive areas of functioning. Other TEPs have directly targeted such behaviors, generally by withholding reinforcement or using token fines. Results over the years show reductions in screaming, ritualistic behaviors, mannerisms, responsiveness to hallucinations, and the frequency of delusional talk. In addition, TEPs have shown dramatic decreases in threatening and assaultive behaviors, with corresponding reductions in use of seclusion and restraint with patients. Research shows that decreases in PRN or "as needed" medication usage as well as reductions in dosage of routine medications is common for TEP patients. In fact, some studies show that behavioral interventions such as the TEP are effective with psychiatric patients even in the absence of medications. Gordon L. Paul and colleagues reported that patients diagnosed with schizophrenia in a social learning program, which included a TEP, were able to be withdrawn from all psychiatric medications without a deterioration in functioning.

Finally, although discharge from inpatient settings and subsequent community tenure are affected by a number of political, financial, and social factors, TEP patients have nevertheless demonstrated decreased lengths of inpatient stay, increased rates of discharge, and decreased numbers of readmissions in comparison to non-TEP patients.

B. Individuals with Mental Retardation

Token economy programs for individuals with mental retardation (MR) have had similar results to those for psychiatric inpatients. Bathing, grooming, toileting, bed making, feeding, tooth brushing, and washing/combing hair have all been shown to increase for individuals with MR in TEPs. Improvements are also seen in voca-

tional skills (punctuality and attendance, production rates, task quality) and academic skills (test preparation, study behaviors). Some TEPs even permit banking of tokens and will teach check-writing skills to their clients with MR to access tokens saved in this manner. Social behavior has also been affected, from behaviors such as making eye contact and asking questions to more complex skills like proper noun-verb agreement, correct grammar, appropriate use of articles or pronouns, and even speech volume and dysfluencies. For younger individuals, increases have been shown in cooperative and competitive play in comparison to solitary or parallel play.

Inappropriate behaviors of individuals with MR have been targeted as well. Research has demonstrated that aggression, rocking behaviors, and self-injury are responsive to treatment programs using token reinforcement, time-out from reinforcement, extinction, and token fines.

C. School Children

Schools have been a popular setting for TEPs, with participants including "normal" children as well as children with a variety of problems including learning disabilities, attention deficit hyperactivity disorder, and emotional disturbances. Participants have spanned the age range from elementary through high school and beyond.

A large TEP undertaking reported by Howard Rollins and colleagues in 1974 included more than 700 inner-city students in Grades 1 through 8. Students in the 16 TEP classrooms demonstrated increased attentiveness and superior improvements in IQ and academic achievement measures than students in the 14 non-TEP control classrooms. Other researchers have obtained similar results, including improved completion of homework and increased basic academic skills as measured by task completion, accuracy, and grades. These improvements are reported in "normal" children as well as those who demonstrate learning disabilities, hyperactivity, and emotional difficulties. In addition, TEPs have been successfully used to improve articulation in children with speech disorders and have even been successful in enhancing writing skills as measured by use of different adjectives, verbs, and story beginnings, and as rated by outside blind reviewers.

A comparison of multiple methods for controlling disruptive behaviors in the classroom was reported by K. Daniel O'Leary and colleagues, who examined the effects of rearranging the structure of the class periods, posting and reviewing of behavior rules, using praise

and extinction, and finally adding a token economy. All methods were generally ineffective until the TEP component was added. Similarly, Marcia Broden and colleagues decreased disruptive behaviors as well as improved study behavior through use of a simple timer and a TEP. The timer went off at random intervals, at which time students who were quiet and in their seats received tokens. This and other research finds TEPs to be effective in reducing relatively minor disruptions (talking in class, being out of one's seat, interrupting, arguing), as well as more serious disruptive behaviors, such as threats and verbal or physical assaults.

As an alternative or supplement to individual contingencies, many classroom TEPs make use of group contingencies. In such an arrangement, it is the behavior of the entire group or class rather than the individual student that determines how much reinforcement each student receives. The "Good Behavior Game," developed by Harriet Barrish and colleagues, divides students into groups or teams, with each team earning or losing points depending on the behavior of the group's members. The team with the best score at the end of a specified time period receives reinforcement. Research using this game has successfully demonstrated its use to reduce disruptive behavior in the classroom. Variations on group contingencies in TEPs were examined by Ronald Drabman and colleagues. In different conditions, tokens were earned individually based on individual performance, or by the entire group based on the behavior of the best behaved child, the worse behaved child, or a randomly chosen child. Disruptive behavior decreased in all conditions, with no significant differences between them. Other research comparing individual versus group contingencies has reported similar results.

Although medications are often used to treat hyperactivity and disruptive behaviors in children, some researchers have found TEPs to be equally effective in controlling these behaviors. TEPs also have the added benefit of improving academic performance, a result not typically found with medication alone.

D. Correctional Populations

Token economy programs with youth engaging in criminal behaviors have also yielded favorable results, although these programs are generally conducted in institutional settings and not traditional classrooms. TEPs have resulted in improved self-care skills, conversational skills (including use of proper grammar), social functioning, classroom behaviors, academic skills, and vocational skills. Some programs, such as the Achievement Place program described by Elery Phillips

and colleagues, involve using a client as a change agent to dispense tokens, levy fines, and assign jobs and other tasks. This innovative feature results in improved performance of target behaviors. In addition, decreases in aggressive and threatening behaviors have been reported, often through the adjunctive use of time-out from reinforcement and token fines.

Token economy programs in adult prisons have met with varying degrees of success. An effort in Missouri focused on the state's most problematic prisoners and involved a tiered token/point system. Prisoners initially earned tokens for lack of threatening or assaultive behaviors and for cooperating with the rules and could purchase privileges such as increased opportunities to shave and shower, exercise, and possess personal items. Improvement in behavior resulted in advancement through a level system and eventually a switch to points instead of tokens, with greater opportunities to access backup reinforcers such as visits to the commissary, outside phone call privileges, and paid "vacation" days from work. Plagued with legal problems throughout its existence, including charges of violating prisoners' rights, the program generally failed to meet its goals of returning its difficult prisoners to the general population and was closed after two years.

Less ambitious prison TEPs have been successful in improving compliance with basic prison routines (getting up on time, keeping cell neat, performing cellblock chores) and increasing academic skills in prisoners, including earning GEDs. Backup reinforcers in some innovative programs have included offering appointments with parole board officers, and even opportunities to go fishing or visit a women's prison.

E. Failures of TEPs

In spite of the success indicated here, research consistently shows that a small number of individuals fails to respond to TEPs. This may be due to individual differences in responsiveness to the contingencies arranged in a particular TEP. For example, providing cigarettes as a backup reinforcer to a non-smoking client is not likely to be very motivating. Similarly, offering reinforcers to a client who is unfamiliar with them may not generate much interest. Teodoro Ayllon and Nathan Azrin addressed this through the use of stimulus sampling. By permitting patients to "sample" new or unfamiliar backup reinforcers (e.g., attending a local fair or a concert) at no cost, they were able to increase interest in those reinforcers once token charges were reinstated.

Other TEP clients may not respond because they lack the skills necessary to perform the target behavior, or because they do not understand the relationship between the target behavior and the reinforcement. Devising individualized contingencies and personalized reinforcers can improve responsiveness in a TEP.

Finally, inadequate implementation of the TEP can attenuate client responsiveness. Some research shows that client change is related to the accuracy with which staff adhere to the planned contingencies. Inadequate training and/or oversight of the TEP can lead to poor results.

F. Generalization

Research indicates that gains made in TEPs do not always last after the token reinforcement has ended. Generalization of gains made in TEPs typically requires some advance planning and should not be expected to simply happen. Strategies for accomplishing this include a gradual rather than sudden cessation of token usage combined with a corresponding increase in naturally occurring reinforcers such as social praise. Other strategies include lengthening the delay between the behavior and the reinforcement, and providing reinforcement in a variety of settings so that the behavior is not limited to a narrow range of cues.

V. CASE ILLUSTRATION

Joe, 33, has spent most of his adult life in state psychiatric facilities. Periodically he gains discharge, only to be readmitted within a period of months. His current hospitalization has lasted over 3 years.

Joe typically spends his day in his bedroom. He rarely talks to anyone and only ventures out for coffee, cigarettes, and meals. He goes weeks without bathing, requiring strong staff encouragement or assistance on those occasions that he does bathe. Joe responds to auditory hallucinations and can frequently be heard talking and yelling at "Uncle Ed," his abusive and now-deceased uncle whom Joe believes is the source of his voices. At times, Joe assaults staff members and other patients in response to directives from "Uncle Ed."

On March 1, Joe is admitted to the hospital's TEP with identified goals of increasing socialization, improving self-care skills, decreasing responsiveness to hallucinations, and reducing/eliminating aggressive behaviors. Program staff orient Joe and explain the TEP to him, inducing a discussion of how to earn and spend tokens. Joe immediately begins a period of stimulus sampling, whereby all backup reinforcers are available to him free

of charge so that he may be exposed to a wide variety of things that he may later wish to purchase with tokens. The free availability of backup reinforcers is gradually reduced over the next few days, and by March 5th Joe must have tokens to access his coffee and cigarettes. At first, Joe becomes angry when he does not receive a free cup of coffee and assaults a staff member. He receives a token fine for his behavior, which must be paid before he can purchase backup reinforcers for himself. Joe has similar incidents over the next few days but eventually realizes that assaulting others will not get him a cup of coffee, and by March 10th Joe is engaging in some simple behaviors to earn tokens. He starts attending a few scheduled treatment groups and begins to shower a couple of times a week. However, Joe doesn't use soap or shampoo while showering and only stands under the water for about 1 min. A decision is therefore made to individualize Joe's target behavior for showers. The next day, Joe earns a token for staying in the shower for 3 min. Eventually, he must use soap and then shampoo to earn his token. The change agents work closely with Joe to help him develop these skills. Slowly, over the course of about 2 weeks, Joe's showering skills advance to the point that he is taking full showers, with good use of soap and shampoo. His hygiene and grooming have improved immensely, and Joe smiles when staff compliment him on his appearance.

As Joe spends more time out of his room, he begins to notice other patients leaving the ward for vocational activities. He expresses an interest in this, but learns that he must be at Level 2 in the TEP to work, and he needs to participate in semistructured social activities to reach that level. Joe reluctantly begins showing up at a couple of the evening card games scheduled on the ward. When he discovers that he cannot earn tokens if he talks to his hallucinations, he angrily retreats to his room. Eventually, after this behavior costs him tokens in a number of activities, Joe begins to reduce the frequency of responding to hallucinations. By April 14th, Joe is promoted to Level 2 and starts attending work. Token payment for work activities is delayed at this Level, and patients are paid in a lump sum at the end of the week as the first step in gradually weaning them off the token economy.

While walking to and from work each day, Joe notices the Recreation Center on campus, as well as some of the gardens and nearby benches. His attendance and participation in other treatment groups starts to improve, as Joe tries to earn additional tokens to spend on grounds passes. An aggressive incident at work on May 10th results in a token fine and the loss of Level 2. Joe is frustrated and becomes sullen and withdrawn for a few days. Staff once again hear him speaking to "Uncle

Ed.” However, after 3 days Joe shows up for the morning exercise group where he earns a token and receives a good bit of social praise from the staff. Joe focuses on regaining Level 2, and succeeds on May 22nd.

By late June, Joe rarely isolates himself in his bedroom. His aggressive behaviors are well under control, and he no longer talks to “Uncle Ed.” Improvements in his group attendance and work performance result in a promotion to Level 3 on June 30th. Joe now receives a large weekly deposit of tokens into his “bank account,” instead of receiving physical tokens at the time he performs each target behavior. He must learn to budget his token supply for an entire week, because no new token deposits will be received before the next week. Joe struggles with this for a few weeks, and often runs out of tokens after only 3 to 4 days, but with some teaching he learns to manage his funds for the entire week.

By late July, Joe is ready to make brief visits to local group homes in preparation for discharge. He continues to participate in treatment at the hospital during the day but starts engaging in evening and weekend leisure events at the group home where he wants to live. There are no tokens at the group home, and this is an additional step in helping Joe move from the token economy back to the community. When Joe is promoted to Level 4 on August 5th, he starts carrying money again and is taken off the token economy entirely. Staff continue to provide Joe with lots of social praise for engaging in positive and adaptive behaviors. By September 8th, Joe is ready for discharge.

VI. SUMMARY

Leonard Krasner once described TEPs as “the most advanced type of social engineering currently in use.” Since their inception in the early 1960s, TEPs have been used to improve basic hygiene and grooming, social functioning, and vocational skills, and reduce agitation,

assaultiveness, and other maladaptive behaviors. They have improved academic skills and have reduced classroom disruptions in schoolchildren. Individuals in correctional settings show improved social skills and rule compliance. Most participants respond favorably to TEPs, but poor implementation, including inadequate training or oversight, will reduce their effectiveness. In addition, people respond differently to reinforcement contingencies, and this will also affect the effectiveness of the TEP. Finally, planning for generalization can help ensure that client improvement continues after the token reinforcement has ended. Forty years after its inception, the token economy remains a powerful tool for changing an enormous array of behaviors with a wide range of populations in a variety of different settings.

See Also the Following Articles

Applied Behavior Analysis ■ Behavioral Contracting
 ■ Contingency Management ■ Good Behavior Game ■
 Negative Punishment ■ Negative Reinforcement ■
 Positive Punishment ■ Positive Reinforcement
 ■ Response Cost

Further Reading

- Ayllon, T. (1999). *How to use token economy and point systems*. Austin, TX: Pro-Ed.
- Kazdin, A. E. (1977). *The token economy*. New York: Plenum.
- Kazdin, A. E. (1982). The token economy: A decade later. *Journal of Applied Behavior Analysis*, 15, 431–445.
- Parker, H. C. (1996). *Behavior management at home: A token economy program for children and teens*. Plantation, FL: Specialty Press.
- Paul, G. L., Stuve, P., & Cross, J. V. (1997). Real-world inpatient programs: Shedding some light – A critique. *Journal of Applied and Preventive Psychology*, 6, 193–204.
- Paul, G. L., & Lentz, R. J. (1977). *Psychosocial treatment of chronic mental patients*. Cambridge, MA: Harvard University Press.



Token Economy: Guidelines for Operation

Teodoro Ayllon and Michael A. Milan

Georgia State University

- I. Historical Antecedents of the Token Economy
 - II. Overview of the Token Economy
 - III. Establishing and Operating a Token Economy
 - IV. Effectiveness of the Token Economy
 - V. Summary
- Further Reading

GLOSSARY

backup reinforcer The positive reinforcers for which tokens are exchanged.

Premack principle The finding that the opportunity to engage in high-probability activities will serve as a reinforcer for engaging in lower probability activities.

radical behaviorism Based on the work of B. F. Skinner, it is the theoretical orientation that posits that behavioral principles provide an explanation and understanding of the full range of human behavior, thought, and emotion.

target behavior A desirable or undesirable behavior to be increased or decreased in the token economy program.

token The item earned or lost when desirable or undesirable target behavior occurs and which is exchanged for backup reinforcers.

I. HISTORICAL ANTECEDENTS OF THE TOKEN ECONOMY

Token economies have a long history. Perhaps the earliest description of what would now be considered a token economy was provided by Alexander Maconochie in the mid-1800s. While warden of the Norfolk Island,

Australia prison, Maconochie concluded that the punitively oriented, torturous methods of inmate management common at that time did nothing to prepare offenders for a productive life in the community but instead increased the likelihood that they would return to their criminal ways when released. In an effort to bring humane management practices and meaningful rehabilitation programs to his prison, Maconochie developed a mark (token) system in which inmates earned marks for appropriate behavior and lost marks for inappropriate behavior. The inmates, in turn, used marks to purchase food, clothing, and privileges. Promotion through a levels system within the prison and even eventual release from prison were also determined by the number of marks accumulated.

It was not until the mid-20th century work of Ayllon and Azrin with severely disturbed psychiatric patients on one ward of a large state hospital and the work of Arthur Staats and his colleagues with children in a preschool setting that the token economy found acceptance and widescale use in modern psychology. Their work is a pioneering example of the extension of basic research conducted in the tradition of Skinner's radical behaviorism into applied settings.

II. OVERVIEW OF THE TOKEN ECONOMY

Stuve and Salinas provide a detailed description of the token economy in their contribution to this encyclopedia.

Our contribution therefore begins with only a brief overview of the token economy. We then offer a number of suggestions or guidelines for the operation of token economies that are based on both a consideration of published works in the area and our personal experience operating token economies in applied settings.

As Stuve and Salinas indicate, a token economy is a reinforcement-based motivational program that is used to encourage desirable, adaptive behaviors and to discourage undesirable, maladaptive behaviors. It differs from other reinforcement programs in that an artificial or contrived reinforcer (the token) is introduced to mediate the relationship and bridge the delay between behavior and more natural reinforcing consequences, such as extra recreational activities or special foods. Desirable behaviors are followed by the award of tokens, which are then exchanged for the natural reinforcers. Similarly, undesirable behavior is followed by the loss of tokens, which reduces or prevents access to the natural reinforcers. Token economies are typically employed with groups of individuals, such as all students in a classroom, all persons with developmental disabilities in a sheltered workshop, all psychiatric patients in a hospital ward, all delinquents in a group home, or all prisoners in a cell block. However, token reinforcement programs can also be used with individual children, adolescents, or adults. When this is done the program is usually referred to as a token or point system rather than as a token economy.

III. ESTABLISHING AND OPERATING A TOKEN ECONOMY

Token economies should be predominantly, if not exclusively, positive rather than punitive. That is, the target behaviors that lead to token award should far outnumber those that lead to token loss, and the participants should earn access to far more backup reinforcers than they are denied. Similarly, tokens should be awarded when earned by engaging in desirable target behaviors rather than given at the start of a day, for example, and taken away as punishment when desirable target behaviors are not exhibited. By emphasizing positive consequences for desirable behavior and for behavior that is incompatible with undesirable behavior, the token economy fosters cooperation and a sense of community among clients and staff while preventing the alienation and resistance that often is seen in punitively oriented programs. By so doing, the token economy fosters a positive attitude about the token economy, active participa-

tion in the token economy, and constructive relationships with those who carry it out on a day-to-day basis. Punitively oriented token economies tend to do just the opposite and explain much of the alienation and resistance commonly seen in such programs.

The major components of the token economy are the target behaviors, the tokens, and the backup reinforcers. In addition, the token economy includes the schedules relating target behaviors to the award or loss of tokens and the exchange of tokens for the acquisition of backup reinforcers. The token economy also includes provisions for the training and monitoring of staff, the use of behaviorally based methods for the development of the target behaviors to be reinforced, and procedures to ensure that behavior change is maintained as the client leaves the token economy. Finally, all aspects of the operation of the token economy and the progress of clients are monitored on a regular basis.

A. Target Behaviors

The token economy exists to increase and maintain desirable behaviors and to decrease and eliminate undesirable behaviors. In general, targeted desirable behaviors are those that contribute to or result in successful community adjustment and the living of a satisfying and productive life. Targeted undesirable behaviors are those that interfere with or prevent those outcomes. Quite often, the positive character of the token economy may be enhanced by targeting the desirable incompatible opposite behavior of an undesirable behavior for token award, rather than targeting the undesirable behavior for token loss.

The target behaviors should be in accord with the mission and goals those settings have established for themselves and their clients. A program for persons incompetent to stand trial that targets the signs and symptoms of mental illness, for example, is inadequate unless it also targets or even emphasizes the skills necessary to competently stand trial. Some behaviors may be targeted for all clients in the token economy. The target behaviors should also be based on an assessment of the strengths or abilities and the problems or deficiencies of the individual clients. As a result, clients may have several target behaviors in common, as well as several target behaviors that are unique to themselves or a small number of other clients.

The target behaviors or, in some instances, the products of the target behaviors should be described in unambiguous terms that make them observable and countable by a second party. This serves several

important functions that advance the treatment effort. First, the clients know exactly what is expected of them and act in a manner that will earn tokens or avoid their loss. The staff also know exactly what is expected of the clients and can accurately award or deduct tokens accordingly. In addition, the objective definition of target behaviors reduces conflict between clients and staff about the occurrence or nonoccurrence of target behaviors that typically occurs when more subjective criteria are employed. Similarly, the clear specification of target behaviors fosters consistency in the manner in which different staff, often on different shifts, work with clients. Finally, the more objectively defined the target behaviors, the less likely it is that clients will be effective in manipulating staff by arguing, for example, that a staff member is discriminating against them by treating them more harshly than other staff members.

B. Tokens

Tokens should be awarded as quickly as possible, if not immediately, following a desirable target behavior and taken away as quickly as possible, if not immediately, following an undesirable target behavior. The tokens themselves should be tangible, durable, portable, counterfeit-proof, and personalized in a manner that allows their accumulation by participants. In a very real sense, a country's financial economy is a token economy, and the characteristics of these tokens are a good model for the tokens in any token economy. In general, the nickels, dimes, and quarters of the United States' economy are tangible, durable, and portable. These coins can be accumulated in considerable numbers, and are virtually counterfeit-proof. They can also be easily carried by staff and can be awarded to clients immediately following a desirable behavior. Perhaps the greatest problem the currency in the United States' economic system poses is that it is not personalized and as a result individuals can and do acquire these tokens through theft and other means without engaging in appropriate and desirable target behaviors.

Rather than use "real" money, of course, token economies typically employ other items as tokens. What is used as a token in a token economy is limited only by the ingenuity of the staff of the program. One example is the poker chip or similar item, perhaps personalized with a number or letter to discourage illegitimate acquisition through theft or coercion. Another example is the daily punch card on which staff punch holes in circles as clients earn tokens and cross off punched-out circles as clients spend tokens. At the end of the day the cards are

collected by staff who determine the number of unexpired tokens, punch that number into the next day's cards, and distribute the individualized cards at the start of the next day. Still another example is a checkbook banking system in which clients are told to add tokens to their account as they earn tokens and write checks as they spend tokens. At the end of the day staff balance each account and inform the clients of their balance at the start of the next day.

The tokens in the three representative examples range from concrete or tangible to abstract or intangible. Where along that continuum the token should fall is dependent on the characteristics of the client population. Young preschool children should be provided more concrete or tangible tokens, whereas older adult offenders would most probably function well with more abstract or intangible tokens. When making that decision, one should keep in mind that one cannot err in the direction of using tokens that are too concrete or tangible.

C. Backup Reinforcers

The backup reinforcers are the natural reinforcers that give value to the tokens. The token economy should not deprive any clients of anything to which they are entitled by the Constitution or by statute. The backup reinforcers therefore are additions to these legally mandated minimums. They may involve access to additional amounts or enhancements of entitlements, such as additional exercise time or special foods, as well as anything to which the client is not legally entitled. In general, backup reinforcers fall in several categories. These consist of edibles or consumables, such as special food or drink; activities, such as extra recreational or computer game time; material objects, such as special athletic shoes or posters; and independence, such as reduced supervision or movement through progressively less restrictive levels in a structured levels program. Each can be considered a to-be-earned privilege.

A number of strategies may be used to identify backup reinforcers. The most straightforward consists of asking the clients what they would like and would work for. Another is based on the Premack principle and involves observing clients during free or unstructured time to identify the things they are most likely to do. These may then be used as backup reinforcers for the typically lower probability target behaviors. Finally, the staff can be asked what they believe will serve as backup reinforcers for their clients. It is important to note, however, that the information gathered through these strategies results only in the identification of

potential backup reinforcers. The reinforcing properties of the potential backup reinforcers must be tested to determine whether they are true backup reinforcers. This is done by assessing whether clients will engage in target behavior to earn tokens and then exchange the tokens for the potential backup reinforcers.

What is reinforcing to one client may or may not be available to another client. The token economy must therefore offer a variety of backup reinforcers to ensure that there are sufficient reinforcers for all participants. Although some backup reinforcers may motivate most or all clients, additional backup reinforcers that function as such for only a few or, perhaps, only one client should also be made available to ensure that the unique interests of all clients are addressed. The backup reinforcers should be available to clients on a regular basis. Some should be available several times a day, others several times a week, and perhaps still others several times a month or only on a monthly basis. The schedule of availability of backup reinforcers is dictated, in part, by the characteristics of the clients, and a token economy cannot err in the direction of making backup reinforcers too frequently available to clients. Finally, the backup reinforcers must be available only through the token economy. The availability of "bootleg" backup reinforcers, that is, backup reinforcers that may be obtained through other means, will dilute or negate the reinforcing properties of backup reinforcers and should be prevented.

D. Additional Considerations

The token economy should be fair or balanced. That is, the backup reinforcers should be commensurate with the target behaviors. This is accomplished, in part, by ensuring there is a rich and variable array of backup reinforcers available to the clients, and by ensuring that the number of tokens earned is in accord with the nature of the to-be-rewarded target behaviors and the number of tokens expended are in accord with the nature of the to-be-purchased backup reinforcers. These ratios should be adjusted as participation in the token economy dictates. Clients should be included in the decision-making process to both better ensure fairness is maintained and to offer them the therapeutic benefit such involvement brings to the treatment setting. The token economy should also be as simple or straightforward as possible so that the relationship between target behaviors, point award or loss, and backup reinforcers is clear to all clients. Conditions, exceptions, and qualifications that obscure the direct relationship between target behavior, tokens, and backup reinforcers will work to dilute the effects of the token economy.

Although the token economy itself may provide experiences that foster a structure and an appreciation of the quid pro quo relationship between privileges and responsibilities that prepare individuals for life in the community, its greater power lies in its ability to motivate clients to participate in therapeutic and rehabilitative programs and activities. These should be identified while developing the target behaviors of each client's individualized treatment program. Staff require training to carry out the token economy and its treatment programs, or to support the staff that do. The general skills necessary to carry out a token economy include, among others, how to shape behavior, the use of prompting to increase desirable behavior and redirection to decrease undesirable behavior, how to use social reinforcement when awarding tokens and backup reinforcers, and the use of behavioral momentum, differential reinforcement, and chaining to further encourage appropriate behavior or discourage inappropriate behavior. Training in specific therapeutic skills is necessary to carry out the treatment programs called for by the characteristics and special needs of the client population. These should be in accord with the profession's movement toward the identification and adoption of empirically based treatments.

A monitoring system is an important part of the token economy. Not only should clients' progress be monitored and assessed on a regular basis, but the performance of the staff in carrying out the token economy should also be monitored and assessed on a regular basis. When the monitoring of clients indicates that their progress is not as is expected, changes in both the clients' individualized treatment plan and the design or implementation of the token economy should be considered and implemented as called for. When the monitoring of staff indicates that their performance is not as is called for, retraining and more intensive supervision should be considered and implemented as called for. More important, however, staff should participate in a positive organizational behavior management program to sustain high levels of work performance and morale.

Special procedures should be implemented to phase out the token economy when clients are eligible to move to another treatment setting or into the community. The general strategy to be followed is to give clients progressively more responsibility for the management of their own behavior. This may be done by moving clients through a structured levels program or by moving from the token economy to self-management in the absence of levels. One might begin, for example, by relaxing a requirement that staff evaluate clients' performance and award tokens as clients assume more responsibility for

evaluating their performance of their target behaviors and awarding or deducting their tokens accordingly. Similarly, the next phase might involve the clients assuming responsibility for exchanging tokens for backup reinforcers. Finally, the tokens might be eliminated and clients assume full responsibility for continuing to engage in their target behaviors and, in exchange, have full but reasonable access to backup reinforcers. Staff should continue to monitor clients throughout this process to ensure that performance is sustained. Transitional programs should ensure that improvements are maintained as clients leave the token economy setting. These programs range from training those who will work with the clients in the additional behavioral skills employed by the token economy staff to training them to continue token economy procedures, if such prosthetic arrangements are deemed necessary.

IV. EFFECTIVENESS OF THE TOKEN ECONOMY

Maconochie's anecdotal reports indicate that the recidivism rate for inmates released from his program on Norfolk Island was markedly lower than that for other prisons in the British colonies. More recent empirical research provides general confirmation of the effectiveness of properly designed and implemented token economies. Perhaps the most influential of the empirical studies is Paul and Lentz's thorough-going experimental comparison of milieu therapy and social learning therapy with a severely disturbed psychiatric population in a large state hospital. They defined the milieu approach as consisting of increased social interaction and group activities, expectancies and group pressure directed toward normal functioning, more informal patient status, goal-directed communication, freedom of movement, and treatment of patients as responsible people rather than custodial cases. The social learning approach was described as the systematic extension of principles and techniques derived from basic research on learning to clinical problems, specification of specific behaviors for change, emphasis on response-contingent consequences, and the use of token economy programs.

In general, Paul and Lentz found the token economy to be superior to the milieu program in terms of both in-hospital improvement and then postrelease adjustment

during a year and a half follow-up period. It was also found to be the more cost effective of the two approaches. The milieu approach, in turn, was found to be superior to routine hospital care for both the in-hospital and postrelease indices of program effectiveness. Findings such as these ensured that the token economy would become an important component of many treatment programs for persons with mental illness as well as in educational settings, training schools, and prisons.

V. SUMMARY

The token economy employs a conditioned reinforcer to mediate between clients' behavior and its more natural positive reinforcement. It is an effective motivational system to encourage desirable behavior and discourage undesirable behavior. It is also effective in ensuring clients' participation in individually prescribed treatment programs. Although simple in concept, it requires sophistication in implementation as well as staff training and continued monitoring to ensure its effectiveness.

See Also the Following Articles

Behavioral Contracting ■ Contingency Management ■ Good Behavior Game ■ Job Club Method

Further Reading

- Ayllon, T., & Azrin, N. (1968). *The token economy*. New York: Appleton-Century-Crofts.
- Ayllon, T., Milan, M. A., Roberts, M. D., & McKee, J. M. (1979). *Correctional rehabilitation and management: A psychological approach*. New York: John Wiley & Sons.
- Chambless, D. L., Baker, M. J., Baucom, D. H., Beutler, L. E., Calhoun, K. S., Critis-Christoph, P., et al. (1998). Update on empirically validated therapies, II. *The Clinical Psychologist*, 51, 3–16.
- Machonocie, A. (1847/1973). *Norfolk Island*. Hobart, Australia: Sullivan's Cove.
- Paul, G. L., & Lentz, R. J. (1977). *Psychosocial treatment of chronic mental patients*. Cambridge, MA: Harvard University Press.
- Paul, G. L., Stuve, P., & Menditto, A. (1997). Social-learning program (with token economy) for adult psychiatric patients. *The Clinical Psychologist*, 50, 14–17.
- Premack, D. (1959). Toward empirical behavior laws: I. Positive reinforcement. *Psychological Review*, 66, 219–233.

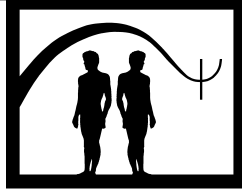

Topographic Theory

Alan Sugarman and Keith Kanner

San Diego Psychoanalytic Society and Institute and University of California, San Diego

- I. Sexual Traumas
 - II. Topographic Theory
 - III. System Unconscious
 - IV. System Preconscious
 - V. System Conscious
 - VI. Importance of Topographic Model
- Further Reading

GLOSSARY

defense The methods used by the ego to master and control id impulses or superego injunctions.

drives Another term for Freud's instincts. Two drives were postulated by Freud—sexual and aggressive. These were the major factors motivating the operation of the mind in his topographic model. They continue to be considered important but not the only motivating factors by modern psychoanalysts.

libidinal wishes Wishes infused with affectionate or sexual urges thought to be ubiquitous in human functioning.

libido The hypothetical psychic energy attached to the sexual instincts.

narcissism Love for the self. Modern-day psychoanalysts use the term primarily to refer to issues of self-esteem. Narcissistic defenses refer to defenses designed to protect or enhance self-esteem, for example.

object relations Refers to relationships to other people. In psychoanalysis, it is the internal representations of self and others that are important in motivating and mediating interpersonal interactions. A developmental distinction is often made between dyadic and triadic object relations. The former refer to relationships modeled on preoedipal

experiences where the major goals of the child revolve around need satisfaction by the mother. Triadic relations are seen as more mature, implying oedipal engagement and the increasing mental complexity implicit in being aware of needs and wishes toward one parent vis-à-vis the other parent.

psychic determinism The tenet that all mental acts have meanings and causes. Psychoanalysis assumes that such causes have to do with mental phenomena that preceded the act in question.

resistance The manifestation of defense within the treatment process whereby the patient opposes the analyst's interventions.

transference The process by which the patient displaces onto the therapist or analyst feelings, impulses, attitudes, or defenses derived from important interactions in the past.

Topographic theory refers to Freud's second phase in developing his psychoanalytic model. It lasted from 1897 until he introduced his structural model in 1923. This phase was marked by rapid, significant evolution in psychoanalytic theory and technique. Many key concepts from it continued to inform psychoanalytic theory and practice including drives, unconscious mental functioning, defenses, unconscious conflict, object relations, and narcissism. Dream analysis, the importance of transference and resistance, and the importance of insight in bringing about psychoanalytic cure stem from Freud's interest in delineating the topography of the mind.

I. SEXUAL TRAUMAS

The most decisive clinical finding that led Freud to abandon his previous affect-trauma model and to develop his topographic one was his finding that the sexual traumas remembered by his hysterical patients thought to cause their symptoms had often not happened. He came to this startling conclusion when he realized that every patient blamed her problems on perverse actions of her father. The likelihood of such pervasive sexual abuse seemed too great to accept as Freud gained more experience with his new talking cure. Furthermore, he himself developed similar memories in his self-analysis. Yet he knew definitively that such actions had not truly happened. These realizations left Freud with the problem of how to account for the existence of such false memories as seemingly a part of the human condition. Puzzling over this problem, he realized that such memories were actually fantasies, fantasies from which he deduced the existence of sexual drives. The concept of defense was brought in to explain the patient's distortion of fantasies into memories. Thus was born the notion of intrapsychic conflict.

II. TOPOGRAPHIC THEORY

But Freud went far beyond the concepts of unconscious libidinal fantasies conflicting with defenses as he tried to understand a host of normal and pathological human characteristics during this stage of his thinking. In order to explain dreams, jokes, slips of the tongue, various types of psychopathology, and aspects of clinical technique he found it necessary to map out the terrain or topography of the mind. His topographic theory differentiated areas of the mind and mental characteristics according to their relationship to consciousness. A spatial metaphor of proceeding from the depths to the surface of the mind was used. Three regions or systems in the mind were delineated: (1) the system Unconscious; (2) the system Preconscious; and (3) the system Conscious. The mental contents of the system Unconscious, instinctual drives and wishes, were thought to be continually pushing to be discharged into the system Conscious. But the unpleasant affects anticipated were they allowed to emerge into consciousness gave rise to defenses that attempted to maintain them in the system Unconscious or to distort their expression so that only partial and disguised discharge was allowed into the system Conscious. This model of mental functioning, thought to give rise to the neurotic symptoms

that Freud treated in his patients, led to the technical dictum of that era—make the unconscious conscious. Thus, Freud advocated that analysts impart insight of their patients' unconscious mental contents, and that this insight would lead to symptom relief.

The spatial metaphor that Freud relied on during this stage of his thinking was most clearly delineated in the seventh chapter of the *Interpretation of Dreams*, which he published in 1900. The model of the mind as composed of three systems or regions that he constructed was based on the concept of the reflex arc. This model held that mental contents had to proceed from the system Unconscious through the system Preconscious before becoming accessible to conscious awareness in the system Conscious. Each of these systems or regions of the mind had distinct characteristics, all of which combined to make mental functioning highly complex. Boundaries were thought to exist between each system, although the rigidity of the boundaries varied. When the mind was in a state of equilibrium or harmony, the boundaries between the regions were thought to be vague, but the dividing lines became quite defined during episodes of conflict.

III. SYSTEM UNCONSCIOUS

The system Unconscious was the most important system in this model. Indeed, the idea of unconscious mental functioning remains central to psychoanalytic understanding of normal and abnormal behavior to this day despite the concept of the system Unconscious having been eliminated. The idea that all behavior and psychological functioning have unconscious determinants remains central to psychoanalysis. Joseph Sandler and his colleagues have pointed out that this hypothesis assumes that the greatest portion of the mind operates outside conscious awareness. It follows from the assumption that most psychological adaptation occurs unconsciously. The principle of psychic determinism, so important in psychoanalytic theory, applies to unconscious mental functions and contents as well as conscious ones.

Perhaps the most noteworthy aspect of the system Unconscious are the contents that Freud thought it contained—the instinctual drives. The overall structure of the mind during this stage in his thinking was thought to occur so that instinctual drives from the system Unconscious could be controlled and expressed in a way that took into account both external reality and the need to allow drive gratification, albeit in disguised

and attenuated forms. These contents of the system Unconscious were emphasized to play a dominant role in the individual's development and ultimate psychological functioning. Freud described the concept of instinctual drives as "a concept on the frontier between the mental and the somatic" in his 1915 paper, *Instincts and Their Vicissitudes*. He seemed to see the concept as a mental representation of somatic stimuli. Initially he emphasized only libidinal drives although aggression in the form of the death instinct was eventually added to psychoanalytic theory later in his life. But the aggressive drive has never been formulated as clearly as the libidinal one despite the indisputable importance of aggressive impulses in mental functioning.

Four components of the libidinal drive were described by Freud. The first was the pressure of the drive, by which he meant the degree to which it pressed for discharge. Freud was struck by the peremptory quality of libidinal urges; they seemed to exert a degree of pressure to act far more compelling than most other human urges. The aim of the instinctual drive was satisfaction. Satisfaction could only be obtained at the source of the instinct. The source referred to the part of the body from which the instinct was thought to derive. Oral impulses, for example, derived from the oral cavity and so could only be satisfied at that source. Finally the object of the drive is that person or object through which satisfaction is obtained. These objects can be part of one's own body. The wide range of perversity known to the human condition demonstrates how variable this component of instinctual drives can be.

The system Unconscious was postulated by Freud to be characterized by a number of unique processes. Perhaps the most important was what he called the primary process in contradistinction to the secondary process, which he saw as characterizing the systems Preconscious and Conscious. Underlying this concept of the primary process was Freud's economic model wherein he believed that a special form of energy, psychic energy, contributed to all mental functioning. Freud believed that the energy in the system Unconscious was freely mobile so that instinctual energy could shift between separate ideas, parts of ideas, memories, and so on, without consideration of logic or time. Thus, ideas could be combined or shifted in ways that the conscious mind would be unable to understand or accept. As a result unconscious thinking is often characterized by displacement or condensation. The former allows one idea to stand for another in the system Unconscious whereas the latter involved a fusing of two ideas that might not be logically compatible. These two

primary process mechanisms—displacement and condensation—are what made dream analysis so complicated and interesting a task for Freud. In order to make the unconscious conscious, the analyst needed to decipher the unconscious mental contents that were disguised by these two primary process mechanisms.

Other unique characteristics of the system Unconscious were also described by Freud. Thus, he described its timeless nature. Temporal considerations were thought to be irrelevant in this system. Furthermore, it operated on the basis of the pleasure principle with no regard for reality constraints or logic. No distinction between memories of real or imagined experiences occurred in the system Unconscious. Furthermore, contradiction did not exist nor did negation. In this way opposites could be experienced as identical in the system Unconscious. Finally words (symbols) and that which they symbolized were experienced as identical in this system according to Freud.

IV. SYSTEM PRECONSCIOUS

The second deepest system or region of the mind according to Freud was the system Preconscious. It was defined as lying between the systems Unconscious and Conscious with its major task being to protect the system Conscious from being inundated by the instinctual drives of the system Unconscious. Freud's topographic model hypothesized that the system Preconscious developed gradually from the influence of both unconscious instinctual wishes and external reality. Over the course of childhood it was thought to become increasingly differentiated from the systems Unconscious and Conscious. Helping in this differentiation was the development of defenses that Freud first called censorship and later repression in this stage of his model development. Thus, the system Preconscious formed a censorship at its boundary with the system Unconscious in order to prevent the instinctual wishes from gaining direct access to the system Conscious. It is important to note that this defensive or censoring function of the system Preconscious was thought to operate unconsciously. But this type of unconscious was descriptive in nature, in contrast to the dynamically unconscious contents of the system Unconscious. That is, functions and contents in the system Preconscious were said to be capable of becoming conscious were attention directed at them. In contrast, the contents and functions of the system Unconscious are actively maintained as unconscious by the energetic force (counter

cathexis) that the preconscious censorship directs against them. This distinction between descriptively and dynamically unconscious content and functions remains relevant today.

Unlike the system Unconscious's operation according to the pleasure principle, the system Preconscious was postulated to adhere to the reality principle. Thus, the unconscious wishes that it allowed to pass through into the system Conscious were closely examined and modified to ensure that they would facilitate the individual's self-preservative needs and could be integrated with the individual's moral-ethical ideals. Secondary process thinking characterized the system Preconscious in order to ensure these adaptational needs also. Causality, logic, and temporality characterize the secondary process wherein language becomes the most important vehicle for harnessing the instinctual drives. The psychic energy assumed to characterize secondary process thinking was described as bound energy by Freud. Sandler and his colleagues have emphasized the multiple and complex functions the system Preconscious was thought to include: (1) unconscious scanning of thoughts and feeling states; (2) censoring of instinctual wishes and their derivatives; (3) formation of organized memory systems; (4) reality testing; (5) binding of psychic energy; (6) control of access to consciousness and motility; (7) affect modulation and development; (8) defensive functioning; (9) fantasy production; and (10) symptom formation.

V. SYSTEM CONSCIOUS

Freud described the system Conscious as being on the mind's surface. Unlike the two deeper regions, its contents were all conscious. Nonetheless the limitations of attention prevented all contents from being the focus of conscious attention at any one time. This system received input from both the system Preconscious and from stimuli of the external world. Thus, its contents were described as sliding back easily into the system Preconscious when conscious attention was completely removed from them. Accordingly, conscious contents are more fleeting than contents of the other systems. Self-preservation requires that the individual always be open to new perceptual experiences. Thus, attention cathexis was thought to be an important part of this system. It was described as based on psychic energy that had been neutralized of sexual or aggressive qualities. Otherwise the system Conscious was similar to the system Preconscious in its underly-

ing structure. The reality principle dominated as did secondary process functioning.

VI. IMPORTANCE OF TOPOGRAPHIC MODEL

The topographic model remains important theoretically because all of Freud's papers on clinical technique were written during this stage in his thinking. Thus, it has continued to exert a prominent influence on psychoanalytic technique despite having been replaced with the structural model in 1923. Paying attention to transference and resistance, studying dreams as the royal road to the unconscious, and interpreting the unconscious content inherent in transference and resistance manifestations came to characterize the psychoanalytic process during this era. As mentioned above, the major curative factor was thought to involve making the unconscious conscious. These technical prescriptions are likely to still sound accurate to many today despite being based on an outdated theoretical model. In fact, Paul Gray has lamented what he calls a developmental lag in the psychoanalytic theory of technique wherein analysts have been slow to realize that the technical implications of the structural model call for a very different technique than that described earlier. Working in a topographic manner leads analysts to interpret unconscious mental content without analyzing the defenses that keep such content unconscious. This approach ignores the need to understand the motives for the defense. Failure to do so renders the patient vulnerable to maintaining these defenses. Also, interpretations that ignore defense can increase the patient's anxiety and, hence, resistance. Gray and his adherents have delineated the different technical implications of the structural model. Nonetheless, many contemporary analysts practice in a topographically informed manner without realizing that they are doing so or that such ways of working are outdated. Thus, it remains important to understand the topographic model as it may be some time before it becomes no longer used.

Furthermore, aspects of the topographic model remain important, even to those analysts whose theoretical understanding has been updated. Certainly the distinction between unconscious and conscious phenomena remains clinically relevant, as does the concept of psychic conflict. Unconscious, preconscious, and conscious are now used as adjectives describing mental processes and not as nouns depicting regions of the mind. The topographic concepts of instinctual drives also remain relevant. These concepts have been revised in an at-

tempt to make them more scientifically viable. Furthermore, psychoanalysts have expanded the number of motivational factors that impel human behavior beyond sexual and aggressive impulses. Nonetheless, sexual and aggressive wishes remain quite important clinically and need to be addressed and analyzed in psychoanalytic treatment.

A major contribution of the topographic model not discussed earlier, but one that is quite important on the modern-day psychoanalytic scene, is that of object relations. The idea that individuals build up a subjective world of mental representations of self and important others, and that this representational world is a crucial component of the psyche is explicit in almost every variant of psychoanalytic theory adhered to today. Recognition of this fact has led analysts to a new acceptance of the inevitability of countertransference enactments. Such enactments are now thought to provide useful understanding about the patient rather than indicating psychopathology in the analyst or therapist. Object relations models have led to new ideas about what is curative in psychoanalytic treatment and to new technical prescriptions including the judicious use of self-disclosure on the part of the treater.

Many fail to recognize that Freud's key papers, *On Narcissism* and *Mourning and Melancholia*, written at the height of his topographic thinking, contain the seeds of all subsequent object relations models. Both these papers involve his explicit delineation of the importance of object relations in understanding psychopathology and in deriving treatment strategies. In those papers he laid out the importance of developing representational boundaries between self and other as well as the role of internalization in giving rise to important emotional states. Thus, the topographic model continues to exert a modern influence.

Joseph Sandler, one of the most prominent psychoanalytic thinkers of the last four decades, has argued for a more direct viability of the topographic model, albeit in a modified form. He believed that the transition from the topographic to the structural model left gaps and inconsistencies in conceptual understanding and in clinical technique; he believed that these could be overcome by a modification of the topographic model—what he called the three box model. He used this three box model to highlight the necessity for conceptualizing a second censor between the second and the third box or system of the mind. This censor gives the second box or system depth, acknowledging the clinical reality that unconscious ego activities have a

range of closeness to consciousness. Even more important, this second system or box is oriented to the present, not to the past. It creates current unconscious fantasies and thoughts as ways of maintaining psychic equilibrium and helping to defend against the infantile, preemptory, and potentially disruptive fantasies of the first box as they push toward actualization.

The second censorship occurring between the second and third systems attempts to avoid shame, embarrassment, and humiliation. In essence it is a narcissistic defense. The contents of the third box are surface or conscious expressions of second system thoughts, impulses, wishes, and fantasies. Sandler believed that the technical importance of this model is to distinguish between the past Unconscious of the first box and the present Unconscious of the second. It is the present Unconscious content that lies behind the second censorship and is closest to consciousness. Sandler believed that his model would help analysts to avoid the topographic era strategy of interpreting deep or past unconscious content before having dealt with less deep, present unconscious content. He advocated that the analyst listen for current unconscious content that was being censored. Thus, his modification of the topographic model is an attempt to deal with the same sort of technical problems as that of contemporary structural theorists such as Paul Gray or Fred Busch. Their approaches are currently gaining greater acceptance than Sandler's three box model. Nonetheless, his efforts do highlight the continued attraction of topographic theory to many contemporary psychoanalytic practitioners.

See Also the Following Articles

Intrapsychic Conflict ■ Object Relations Psychotherapy ■ Oedipus Complex ■ Structural Theory ■ Transference ■ Neurosis ■ Unconscious, The

Further Reading

- Dowling, S. (Ed.). (1991). *Conflict and compromise*. Madison, CT: International Universities Press.
- Gill, M. M. (1963). *Topography and systems in psychoanalytic theory*. New York: International Universities Press.
- Moore, B., & Fine, B. (1990). *Psychoanalytic terms and concepts*. New Haven, CT: Yale University Press.
- Ritvo, S., & Solnit, A. (1995). Instinct theory. In B. Moore & B. Fine (Eds.), *Psychoanalysis—The major concepts* (pp. 327–333). New Haven, CT: Yale University Press.
- Sandler, J., Holder, A., Dare, C., & Dreher, A. (1997). *Freud's models of the mind, an introduction*. Madison, CT: International Universities Press.

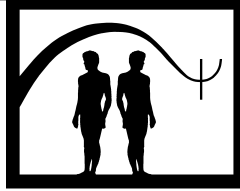

Transcultural Psychotherapy

Thomas E. Heise

Medical University of Hannover

- I. Introduction
 - II. The Historical Perspective
 - III. Migration
 - IV. Transcultural Contexts
 - V. Applied Transcultural Psychotherapy
 - VI. Summary and Outlook
- Further Reading

GLOSSARY

culture-bound-syndrome (CBS) Term coined by P.-M. Yap (1967/1974) as pertaining to only locally spread diseases in opposition to current psychiatric diagnoses. Today they are seen as strongly culturally influenced diseases, finding their explanatory roots in folk medical beliefs. Examples include koro/suoyang, paleng, amok, latah, susto, brain-fag, and ogba nje.

emic Culture-specific understanding; research by an insider; emphasized by the new cross-cultural psychiatry, comparing cultural aspects (e.g., A. Kleinman, B.J. Good, R. Littlewood, M. Lipsedge).

ethnopschoanalysis Term, first used by G. Devereux in 1972, for a kind of work initiated by G. Róheim in 1932 and continued separately by P. Parin, G. Parin-Matthèy, and F. Morgenthaler in 1963. According to Devereux psychological and sociocultural explanations must be used separately. Modern interpretations of his ideas are controversial.

ethnopsychiatry Study of psychiatric diseases in other cultures. The term was first used by Devereux around 1950. He saw one of its tasks as being to create a culturally neutral psychotherapy.

etic Useful for global generalizations; a culture transcending view, as opposed to emic; research by an outsider.

immigrants first generation—5 phases Initially (1) the preparation for and (2) the act of migration. Communication barriers because of language problems are predominant. Overcoming many psychological problems by excessive effort, that is, (3) overcompensation occurs. However, this can have a negative impact, and (4) decompensation, occurs, especially on retirement. (5) Adaptation takes more than one generation.

immigrants second generation Mostly well-spoken new language, frequently hiding the problem of different meanings and losing their parents' language. Torn between traditional values of the family and place of origin and modern values of the new surrounding.

immigrants third and later generations On the surface mostly well adapted if belonging to a more educated social class, but—often unconsciously—still influenced by the family's cultural heritage. If belonging to a lower social class, they still might have difficulties in learning the new language sufficiently, while also not learning their original language well enough.

interpreters Should be neutral persons, not family members, trained in being translators without commentaries or cotherapeutic interventions.

qigong A therapeutic combination of movement, breathing, and hovering awareness as one example of therapeutic methods in traditional Chinese medicine (in addition to herbs, acupuncture, etc.). Many traditional medicines are used in diagnosis and treatment by their respective immigrants, often without mentioning it. Their traditional explanations of their disease might play an important role in Western psychotherapy.

shaman A traditional healer, found in most traditional cultures. He uses altered states of consciousness (ASC) if he is a real initiated healer.

transcultural psychotherapy (a) Using traditional methods from other cultures in Western psychotherapy. (b) Concerning all the sociocultural problems involved in the psychotherapeutic treatment of immigrants or refugees, deriving from the encounter of the two (or more) respective cultures. Often an interpreter is necessary.

I. INTRODUCTION

Mental health services rely not only on the physical body but also on the psyche, brain, mind, and soul. The body itself with its different physical afflictions, diagnoses, and treatments is viewed quite differently depending on the cultural context, according to Payer in 1996. Mental problems and sociocultural factors are so closely interrelated that they cannot be viewed separately, as discussed by Westen in 1996. With an ever-growing worldwide multiculturalism, it is imperative to integrate the results of international research. This concerns all theories of psychoanalytic, behavioral, humanistic, and other psychodynamic counseling and psychotherapy. To improve our understanding of transcultural psychotherapy I will introduce historical perspectives. Some of the main factors to be considered are aspects of migration and transcultural contexts. Short case studies, each emphasizing a particular facet, will illustrate this point.

II. THE HISTORICAL PERSPECTIVE

The foundation of transcultural psychotherapy is based on Middle European psychiatry. Known and unknown variations of familiar "mental illnesses" were discovered in distant and "exotic" countries. The scientific founders were Van Brero, who worked in the 1890s, and Emil Kraepelin in 1904. Their comparative psychiatric works dealt with mental disorders in Indonesia. Bronislaw Malinowski's work in 1924 on *Mother-Dominated Family and Oedipus Complex* represented a milestone in which he refuted Sigmund Freud's hypothesis on the general validity of the Oedipus complex by recording his observations on the Trobriand tribe in the Pacific. He was able to show that the complexes arising within the family core were a consequence of the social structure of the tribe or people. Nevertheless, he recognized the significance of Freud's attribution to the influence of the early childhood years. In 1957 Erik H.

Erikson followed with his studies on *Childhood and Society*, a comparison between the North American Indian Yurok and Sioux tribes. Margaret Mead did her research with a scientific and objective point of view and described the customs and traditions of different races. In 1959 Mead introduced *Gender and Temperament in Primitive Societies* and was primarily interested in how children were raised within these societies. She was known as a representative of "Culture-Gestalt-Psychology," and her results are considered controversial.

Paul Parin, Golda Parin-Matthey, and Fritz Morgenthaler investigated African cultures according to psychoanalytical criteria. In the 1950s Georges Devereux coined the expression "ethnopsychiatry," and in 1972 he published the book *Ethnopsychanalysis*. According to his ethnological studies, stress is traumatic when, within the respective culture, defense mechanisms are absent. He understood culture as a system of defense mechanisms. In 1982 he stated that shamans were mentally disturbed. The fact that in 1996, Asian shamans and African medicine men were invited to speak at the first World Congress of the "World Council for Psychotherapy," in Vienna, shows that today this situation is seen quite differently. Devereux's aim in 1970 was "the introduction of teaching and practice of cultural neutral psychotherapy," as described in 1982. This kind of psychotherapy should not be based on the attributes of any particular culture, but should be "comparable to affective neutral psychoanalytical therapy." Since this originated only in Devereux's culture, it is actually a contradiction in itself.

Jeanne Favret-Saada, a psychoanalyst and ethnologist like Devereux, introduced epochal standards to her field of research by participating in conversations and witchcraft ceremonials with the natives. These "natives" were not even "exotics" but a rural group of people from the western part of France. Favret-Saada allowed herself to become personally involved, and in doing so, pioneered a new scientific approach. Thus, in 1977, she added a third method of research. In 1966, R. Pike derived the already familiar "etic" approach, from linguistics, to be applied to ethnology. This meant gaining more culture-general information from scientific studies, in contrary to the rather culture-specific "emic" approach, which enabled a better understanding of the cultural aspects from the natives' point of view. Favret-Saada, as an insider among these "natives," was able to put herself into the position of examining the culture from both points of view, changing dialectically from inside to outside. These aspects were also considered by psychiatrists such as Christian Scharfetter, who, in 1987, published the book

Ethnopsychotherapy. His ideas were based on his own experiences with the Theravada-Buddhism method of meditation, and many discussions concerning altered states of consciousness (ASC). Thomas Heise used a similar method. He studied traditional Chinese medicine (TCM) for more than 2 years in China, and, in 1996, published the book *China's Medicine in Germany*, which also covered a broader view of "psychiatric-psychotherapeutic" aspects of TCM. Another book by Heise, published in 1999, dealt with *qigong* in the People's Republic of China, its historical development, theory, and practice. Michael Harner in 1972, 1973, and 1980 and Roger Walsh in 1990 also based their scientific books about shamanism and healing on their own experiences and participation. Similarly, Stanislaw Grof, in his works since the 1970s, investigated many traditional therapies in order to find common roots. He made the workings of the various subconscious layers and ASC more intelligible and understandable.

Eric Wittkower, Wolfgang Jilek, and Louisa Jilek-Aall influenced transcultural psychiatry in many ways. Wittkower in 1978 described its aim as the "identification of quantitative and qualitative differences when comparing mental illnesses in the various cultures, the investigation to determine these differences and the application of this knowledge for the treatment and prevention of mental illnesses." In 1980 he was concerned with the cultural and transcultural aspects of psychotherapy. On the one hand he placed emphasis on the introduction of foreign cultural methods to the West, such as yoga and Buddhist meditation, and on the other hand, on the use of Western psychotherapy outside the Western culture complex.

Based on his experiences in Taiwan in 1980, Arthur Kleinmann did research on the way in which cultural symbols and meaning influence the perception and expression of symptoms and therapeutic mechanisms. In 1985, he emphasized the theme in *Culture and Depression*. Wolfgang Pfeiffer concentrated on the analysis of dialogue and migration problems as well as on the contact between various medical systems. Having lived in Indonesia, he dealt in particular with those of Asia. His first work, *Transcultural Psychiatry*, published in 1971 and revised in 1994, is a phenomenological collection of culturally influenced expressions, corresponding to the various psychiatric groups of diagnoses. Erich Wulff, who worked in South Vietnam for 7 years, studied the methods of comparative psychiatry, and emphasized the social requirements for these methods, and thus their historical significance and subjectivity. Karl Peltzer, who spent many years researching in different parts of Africa, supported these ideas and coined the expression

"postanalytical ethnopsychological research." In 1994 he published *Psychology and Health in African Cultures: Examples of Ethnopsychotherapeutic Practice*.

On the whole we can see in the historical development of transcultural understanding a start with a rather Eurocentric and limited approach. Scientists looked for the well known in foreign countries. The second step showed a deeper involvement into different cultures, but no change of scientific ideology, which only began with the third step. Here the dialectical switch between subjective involvement during field research and more objective scientific evaluation gave rise to new ideas. These are not limited to pure psychoanalytical or behavioral thinking and are more sincerely tolerant and humanistic, grounded on interdisciplinary cultural studies.

III. MIGRATION

Another pragmatically important topic concerns immigrants. They arrive for different reasons in historically varying waves, and experience specific stages of more or less successful adaptations to their problems. In Germany, for example, early research on the mentally related illnesses of foreign workers (*Gastarbeiter*) at the end of the 1970s was abandoned and thereafter temporarily forgotten. Other countries with a colonial or immigrant history were confronted with this problem to a greater degree. In the past two decades, in England and the United States, this has led to a growing literature on counseling. These perspectives on counseling apply to therapy as well. In past years the geriatric ailments of the "foreign workers" in Germany, the second and third generation of immigrants, and the increasing inflow of new immigrants and political refugees produced an escalation of problems in mental health and psychotherapy. It was found that for refugees suffering from posttraumatic stress disorder (PTSD) it is of utmost importance to assess the preflight personality, the circumstances that caused the flight, its conditions, and coping abilities. Around 20 years ago, *Counseling Across Cultures* was published by Paul. B. Pederson and colleagues. It deals not only with the specific ethnic groups in North America, but also with international students and refugees, gender conflicts, ethics, and cultural empathy. In 1989, Patricia D'Ardenne and Aruna Mahtani published the book *Transcultural Counselling in Action*, which demonstrated practical aspects of the transcultural therapist-patient relationship. That same year, Colleen Ward issued the volume *Altered States of Consciousness and Mental Health: A Cross-Cultural Perspective. Handbook of Multicultural Counseling* by Joseph G. Ponterotto

and co-workers discusses theoretical and practical statements. A book series on multicultural counseling covers themes such as *Preventing Prejudice* by Ponterotto, *Improving Intercultural Interaction* by Richard Brislin and Tomoko Yoshida, *Assessing and Treating Culturally Diverse Clients* by Freddy Paniagua, *Overcoming Unintentional Racism in Counseling and Therapy* by Charles Ridley, and *Multicultural Counseling with Teenage Fathers* by Mark Kiselica. Colin Lago and Joyce Thompson compiled the book *Race, Culture and Counseling* and Suman Fernando published *Mental Health in a Multi-Ethnic Society*. The latter two books deal particularly with the problems of biological and cultural racism and the different, often multiprofessional management of inpatient and outpatient institutions for the care of mentally disturbed foreign citizens.

One prominent French author, Tobie Nathan, published such works as *The Madness of Others: An Essay on Clinical Transcultural Psychiatry* in 1986, and *The Influence That Cures* in 1994. Initially, he held the opinion that the ethnopschoanalytical background was of prime importance. Later, however, he changed his mind and stated that patients could also be healed using the therapeutic means of their respective cultures. In 1998, Marie Rose Moro, who worked especially with immigrant children emphasizing the aspect of family therapy, published a book on these topics. In the Netherlands, in 1996, Joop De Jong developed, among other things, a handbook on transcultural psychiatry and psychotherapy. A number of German books show, by their titles alone, that there are numerous problems in the search for better solutions: Heribert Kentenich, Peter Reeg, and Karl-Heinz Wehkamp, 1990, *Between Two Cultures: Why Does a Foreigner Become Ill?*; Horacio Riquelme, 1992, *Other Realities—Other Approaches*; Eckhardt Koch, Metin Özek, and Wolfgang M. Pfeiffer, 1995, *Psychology and Pathology of Immigration: German-Turkish Perspectives*; Peter Möhring and Roland Apsel, 1995, *Intercultural Psychoanalytical Therapy*; Jürgen Collatz, Ramazan Salman, Eckhardt Koch, and Wielant Machleidt, 1997, *The Medical Report with Special Emphasis on Transcultural Issues: Quality Safeguarding of Social-Legal and Social-Medical Reports for Working Immigrants in Germany*; Thomas Heise, 1998, *Transcultural Psychotherapy: Helping to Treat Foreign Citizens*; and Heise, 2000, *The Situation of Transcultural Counseling, Psychotherapy and Psychiatry in Germany*.

Traumatization can occur as a result of ethnic, religious, sexual, or economic pursuit, if the preflight personality cannot cope. These differences must be taken into account when determining therapy, which varies for immigrants in the various generations. Each subjective

reality is based on the individual's identity, perceptions, and experiences. Neglecting its relation to culture, diagnosis may be inadequate, the patient does not feel accepted personally, and therapy is likely to fail. For evaluating the five phases of migration (see Glossary) important issues include reflecting on the cultural influence of one's own behavior; being able to investigate another person's cultural background, if necessary with interpreters; reflecting on one's own prejudices and the cultural and historical relativity of values; understanding each other sufficiently; and being able to find acceptable solutions in a multicultural teamwork. According to Sluzki in 1996, the therapist must help the migrant to prepare to accept times of feeling lonely, to encourage him or her to learn the new language and new customs as quickly as possible, to get as much new information as necessary, and in order not to lose continuity, to remain in contact with compatriots and enhance the personal environment with pictures from the past or other symbols.

IV. TRANSCULTURAL CONTEXTS

There are many cultural barriers to communication and we are only aware of some of them. Less evident are attitudes toward one another; nonverbal behavior; customs and traditions of greeting and meeting; personal theories of communication; political differences; fear, perception, and expectations of one another; systems of belief and ethics; view of personal and institutional power; notions of acceptable and unacceptable behavior; patterns of interpersonal relationships; ways of learning, working, and living; and views of illness and disease as well as of therapy regarding meaning for oneself and others. In 1980 Geert Hofstede determined some main criteria in 40 different nations and distinguished between small and large "power distance" (the acceptance of the distribution of power in society), weak and strong "uncertainty avoidance," collectivist and individualist, and feminine and masculine dimensions.

In approaching different philosophical assumptions, as Lago and Thompson showed in 1996, general views of the world will be compared.

The Western system emphasizes a material ontology, appropriating a high value to the acquisition of objects. External knowledge derived from counting and measuring is assumed to be the basis of all knowledge. The logic of this conceptual system is dichotomous (either-or), like the basis of computer technology and other technological processes that are repeatable and reproducible. In consequence, identity and self-worth tend to be based on external criteria, such as status symbols.

In the Asian conceptual system, the ontology of a cosmic unity, as taught in Buddhism, Taoism, Shintoism, and Hinduism, is of the highest value, emphasizing the cohesiveness of the group and traditionally the interplay with nature. Thus the Asian logic does not separate the body, mind, or spirit. Harmony is necessary to make the internal and external cosmos, in their interrelatedness, a balanced model of unity. In consequence identity and self-worth are based on being and an internal and external reality.

The African system emphasizes both a spiritual and a material ontology, valuing above all the interpersonal relationship between women and men. Self-knowledge is assumed to be the basis of all knowledge. One acquires knowledge through symbolic imagery and rhythm. The logic is based on co-unity, and through this process, everything in time and space is interrelated through human and spiritual networks. In consequence identity and self-worth are intrinsic.

For the sake of brevity, these views of the world indicating such tendencies may seem somewhat simplistic. Transcultural psychotherapy should try to be aware of these different processes, cosmologies, and values and their consequences.

V. APPLIED TRANSCULTURAL PSYCHOTHERAPY

According to findings by Fernando in 1996, ethnic minorities are more often diagnosed as schizophrenic, compulsorily detained under the Mental Health Act, given high doses of medication, and not referred to psychotherapy. A research survey conducted on behalf of the Royal College of Psychiatrists in 1991 and reported by Lago and Collins in 1996, showed that 85% of the 2000 respondents believed that depression was caused by life events and that psychotherapy, not antidepressants, was the most appropriate form of assistance. A study by Bebbington and colleagues of 297 randomly selected women demonstrated a significant excess of marked life events in acute cases of psychiatric disorders (50%) compared to chronic cases (16.7%) and noncases (27.9%). The effect of chronic social difficulties was even more pronounced (33.3%) than, and independent of, the effects of life events. Here psychotherapy would be helpful.

We should keep in mind that we must not be intimidated by this subject, since a good education in psychotherapy equips one with all the tools necessary and can be effectively applied here. One must simply be more eager, more neutral and tolerant, more open minded and more empathetic, and display these atti-

tudes in various ways. Patients want our help and will give us every possible assistance, if asked for, in understanding them in their cultural background. Let us use their cultural expertise by asking "What does this mean to you?" If they do not speak our language fluently, a neutral interpreter is needed and not an emotionally involved family member. If after the translating job we ask the interpreter separately for some commentaries, most of them will recognize our interest and be glad to help us. In order to broaden this point of view I will provide additional important aspects followed by short case histories, in full reported by Heise in 1998.

The term transcultural psychotherapy contains two aspects that are expressed in the prefix "trans." The monocultural aspect of illness should be transcended with regard to the diagnosis and also to the manifestation of the illness itself as a dis-ease. This kind of mental illness may arise in certain individuals as a result of the encounter of two different cultures. This fact must be taken into account in an empathetic and unprejudiced manner. A neutral attitude toward affect and culture and feigned objectivity as shown in the classic psychoanalysis with its rules of abstinence is not adequate.

In medical reports and testimonies the pathogenetic and therapeutic differences between political refugees with either acute depressive decompensation or posttraumatic stress disorders are of great importance. The task of the physician, as sometimes opposed to that of official authorities, may be challenging in the case of foreigners.

Case History 1: Pathogenetic and Therapeutic Differences between Two Kurdish Refugees with Acute Depressive Decompensation

A young Kurdish patient, accompanied by his father and older brother, was brought for examination. He suffered persistent abdominal pain and had already undergone unsuccessful surgery. The dependence on his family, who after 3 years were still awaiting political asylum, due to predominantly economic reasons, resulted in a conflict with his wish to return to his relatives in Turkey. No inpatient treatment was required for this case. The doctor treating the patient sent a letter recommending that the boy return to Turkey. The second case concerned a Kurdish female from Iraq, an accepted political refugee. Her husband, who as a physician had treated Kurdish rebels, was therefore killed by the Iraq authorities. She, due to administrative and domestic problems, had attempted to kill herself along with her little son. This case required inpatient treatment with client-centered therapy with the help of an interpreter.

The patient received support regarding her social problems, and finally gained enough self-confidence to cope alone with her difficulties. The medical role had to be determined regarding contact between the patient and the authorities for foreign citizens.

Some patients feel bewildered because of the foreign land and people, and have even more problems discussing their difficulties and emotions. Here, the use of guided affective imagery therapy according to Hanscarl Leuner, art therapy, Gestalt-therapy, or bodily oriented methods are helpful to understand, for example, depressive disorders followed by psychosomatic complaints. In addition it helps to introduce the "talking cure."

Case History 2: Guided Affective Imagery Therapy as the Turning Point in the Psychotherapy of a Russian Female with Chronic Reactive Depression

A Russian immigrant came for psychiatric help with acute suicidal thoughts and admitted to suffering from headaches and depression for 2 years. With the help of an interpreter, she was able to build up a sufficient basis of trust during client-centered psychotherapy, according to Carl Rogers, to give an account of her rape incident. She was raped by an unknown person after her arrival in Germany and had not yet summoned the courage to inform her husband of this event. As she had great difficulty in coming to terms with negative feelings or even to speak of them, the guided affective imagery therapy was invoked twice to help her express her feelings and thoughts. Only two themes (flower and mountain) were necessary to give her access to her split feelings. Of particular interest were the specific transference relation, the recalling of the situation, the confrontation with her feelings, the catharsis, and the reaction toward the symbolic image. Talking about the two images helped her to visualize her partnership conflict. After painting them she tried to speak about solutions, first in therapy and later with him.

This procedure proved effective and the patient was then able to relate the whole story to her husband. Finally, she succeeded in improving her newly found verbal abilities so that she was able to carry out a constructive discussion with her husband concerning their relationship, and also to take part with him in partner discussions. She was seen in the outpatient clinic for 8 more months. In these partner discussions her resistance to "talk" started again. The therapist introduced breathing and relaxation exercises that the

patient could manage with increasing ease. Three months later, she indicated she was ready to take up the discussions once more.

The topic "guilt" brought back the accusation of her husband that she was also guilty as she had not offered enough resistance to her rapist. It then became evident that for the Jewish family of the husband, the topic "guilt" with reference to "why didn't they kill us like the others?", played a major role in association with the persecution of the Jews in Russia.

Before this admission to the psychiatric department, the patient had already experienced three occasions when she had tried to talk about these same problems with Russian-speaking therapists without success. During the first phase of her illness, she was treated by a neurologist in Moscow in order to find the organic reasons for her symptoms. The diagnosis offered was a psycho-vegetative complaint with labile personality traits, while symptoms increased again on the way to Germany. She later consulted a Russian guest doctor (not a psychotherapist or a psychiatrist) and here misunderstandings arose in the communication between him and the doctor treating her for her psychiatric symptoms, most likely due to incorrect translation. Finally, she was treated as an outpatient by a Russian psychiatrist practicing in Germany who, on the one hand, showed a preference to administering medication and, on the other, forgot about the mutual influences of the involved cultures, and never spoke to her without her husband. Therefore, in this part of the therapy, the "trans" cultural element was disregarded. To avoid any similar retraumatizations, transcultural sensibility training should be introduced to medical and, in particular, psychotherapeutic and psychiatric education.

Problems of translation, interpreters, a mono- or bi-cultural approach, and a change in the therapeutic procedures (verbal – nonverbal) were discussed. This shows that language, ethnicity, and culture are not identical. All conscious or unconscious processes, interactions, and experiences are culture related, family related, and individual related. These can be clarified to make therapy successful.

The diversity of so-called schizophrenic manifestations is transculturally even more obvious. Therefore, diagnosis and therapy must take into account both the individual and the cultural diversity. Other cultures might even present a more adequate way to cope with psychotic experiences. In the delusion of being possessed the understanding of the patient's bio-socio-psycho-spiritual world view is paramount. This, in addition to the application of client-centered psychotherapy according to Carl

Rogers and the inspiration by transpersonal psychology, may prove more helpful in transcultural psychotherapy. An understanding of the cultural “differences” of the patient helps to build up the patient’s self-esteem.

Case History 3: A Korean Patient’s Delusion of Being Possessed

A Korean priest of a Christian sect was responsible for inflicting a patient of the same nationality with short-term exogenous psychosis by means of a syncretistic atmosphere and deprivation of sleep. This led to an attempted suicide. Mutual trust between patient and doctor was developed by therapeutic intervention according to Roger’s client-centered therapy. Further anamnestic details were obtained, particularly in connection with the dead grandmother who was a *mudang* or shaman priestess. Knowledge of the patient’s cultural background explained her reaction of feeling possessed by a bad spirit, and we, by showing a neutral respect for this particular culture, including the involved shamanism, presented the patient with a favorable prognosis for successful therapy. The conclusions resulted in a transcultural–transpersonal portrayal for diagnosis and treatment; it became obvious that there were syncretistic factors, but no real shamanistic transformation act or traditional healing process involved.

The second “trans” aspect concerns, on the one hand, the intracultural cooperation between the indigenous medical system of the immigrant and the Western medical system. On the other hand, it deals with intercultural cooperation. This may be in the form of influence or inclusion of aspects and methods from traditional medical systems together with our Western medical system. Some patients have better access to psychotherapeutic measures from other cultures. The use of foreign and archaic instruments in music therapy or therapeutic means from traditional Chinese medicine or Indian ayurvedic or Arab unani-tibb medicine may prove effective.

Case History 4: Treatment of Hallucinatory Psychosis with Complementary *qigong* Exercises

Taiji quan (T’ai Chi Ch’uan) “shadow boxing” and *qigong* (Ch’i Kung) meditative “breathing exercises” are therapeutic methods based on traditional Chinese medicine (TCM), like herbal medicine or acupuncture. There are several forms of exercises, some of which are becoming more popular in the Western sphere. At first glance only the movements bear a vague resemblance

to our established forms of gymnastic exercises, but the exercises based on TCM are, in fact, far more advanced. By means of a balanced form of movement according to the *yinyang* concept, the meridians are harmonized and the activated subtle energy *qi* also contributes to balancing the associated functional organic system. According to TCM theory, certain emotions and mental conditions are associated with specific organs, and with the help of these exercises, a psychotherapeutic effect is obtained. It was shown in a recent study by Heise in 2002, that *qigong* reduces in psychosis significantly state anxiety after each session and trait anxiety on the long term (STAI) and depression and psychoticism (SCL-90-R), increases relaxation and ability for enjoyment, helps exhaustion and achievement, and diminishes cenesthesia (case histories).

The 40-year-old patient complained of hearing voices for 4 years. The physical problems in his arms and legs and his headaches had persisted for 3 years and were induced by voices with their lips on his body. He initially tried to block out the voices by “drowning” them with beer, then gave up drinking, and since one year, had only consumed limited amounts of alcohol. The patient could for the first time be convinced of the advantage of persistent high-potency neuroleptics while undergoing day clinic therapy. Organic causes were ruled out and analgesic medication reduced. During the group therapies he demonstrated an aggressive inhibition with withdrawal tendencies on confrontation with conflicts. In addition, he took part in 5 of the above mentioned *qigong* therapy group sessions, and then a further 11 sessions on an outpatient basis following discharge. During day clinic therapy, the patient appeared to be considerably more relaxed, more lively, and more socially active with increasing clarity of mind, and experienced reduced physical pain and fewer headaches with weaker and less aggressive auditory hallucinations. It was noted on *qigong* therapy that even at the beginning he was able to rapidly develop the special “*qi*-feeling.” On discharge from the day clinic he reported that immediately after the *qigong*, the voices disappeared for an hour and the headaches became less frequent. He felt an inner calm. Up to the 6th session he admitted to changes in his condition with regard to the voices and the “headaches,” showing a slight improvement. The physical pains disappeared completely. He executed these exercises independently twice a week, and continued to do them when followed-up for research purposes 1 month and then 4 months later, as he found they helped to combat the

more aggressive voices, which now appeared about two times each week. He then received his third kind of a typical neuroleptics, and although he was unable to differentiate between these medications, he was aware that they had a certain beneficial effect on his condition, but less so than the *qigong* exercises, which he would practice whenever needed.

In order to deal with ethnocentric feeling and thinking, new solutions are required for the basic points of transcultural psychotherapy. These are not yet statistically validated, but need further investigation in this rather new field of research. Special issues are the question of value and purpose (“honor”) regarding self-responsibility and self-realization in different cultures together with its role in psychotherapy. For example, a supervisor of the same foreign culture in an analytically oriented self-experience group for social and medical professionals may help to combat hostility toward foreigners. He reduces defense mechanisms, because he has overcome these troubles himself.

Weekend seminars to discuss crisis intervention with youngsters of the same culture, using the group analytical method, may be effective in reducing violence. Thus underaged refugees may have the opportunity, during this session, to discuss, in an appropriate manner with their peers, their traumatic experiences of leaving their parents and their native culture. Different psychotherapeutic forms such as hypnotherapeutic and cognitive-behavioral therapeutic techniques may be effective, as well as ritual techniques and eye movement desensitization and reprocessing (EMDR) developed by Francine Shapiro and published in 1997, as discussed by Foa and colleagues in 2000 and Sack and co-workers in 2001.

For therapists treating in a foreign country, in their mother tongue, with deep psychological, systemic, and behavioral therapeutic elements, transference–countertransference and the risk of regression are important factors. Sociocultural circumstances influence drinking habits and drug consumption strongly and should not be disregarded in any therapy, according to Lala and Straussner in 2001.

Systemic individual and family therapy (mono- and bicultural) is resource- and solution-oriented by means of esteemed and engaged neutrality combined with respectful curiosity, as discussed by Krause in 1998. In addition to the routine service of psychotherapeutic-sensitive trained interpreters, the patient is also an expert in his culture. This induces a paradigmatic change.

Positive psychotherapy developed by Nossrat Peshchian in the 1970s is derived from the narrative el-

ements of Middle Eastern fables. This kind of therapy judges bodily feelings, senses, achievements, social contacts, and fantasy regarding future decisions. A comparison of giving life meaning in Eastern and in Western cultures is often added in this transcultural approach, similar to other humanistic psychotherapies.

All of these therapeutic methods concentrate on the way each individual interacts with his or her environment. The respective cultural background is responsible for influencing and molding the senses of perception and sensitivity of each human being. Culture is a term incorporating the material cultural relics and daily customs, everything that language makes “producible,” “approachable,” and “conceivable.” This includes specific conditionable senses of perception (particularly apparent in the Yogis and Masters of the hard *qigong*) and metaphysical experiences, speakable and unspeakable expectations, and constructed models. All of these are attitudes that are more or less “culture-bound,” without calling them a “culture-bound-syndrome.” However varied the climate and the people they originate from may be, common denominators may remain with regard to the same generation, gender, spirituality, (un-) employment, wish for a better life of one’s children, and so on.

All of these points need to be considered within the complete context of therapy—consciously or unconsciously. Certainly it would be more beneficial if this were to happen consciously and thus not uncontrolled. The rationalized, verbalized, and cognitive element has prevailed in the culture of the Western world over the past 2000 years; this is understandable when one reflects on its historical development. However, domination of this kind of thinking must not be accepted to such an overwhelming extent. Therapeutically, it is significant to attempt to discover the other elements in oneself, which one has either never or rarely recognized before, or which have not had the chance to develop properly. A feeling of amazement or astonishment must be produced, which leads to a realigning of the thoughts by thinking twice. This change of “sense(s)” cannot only be achieved by verbal tactics but also by other therapeutic techniques. This change of the senses may give another sense and meaning to living. This initiates a healing process that materializes into the human system and its culturally influenced relationships toward fellow humans and the cosmos, as a whole, in an intrapersonal, interpersonal, and transpersonal way. The therapist is the catalyst of this process, acting as a mediator to promote the self-curing efficacies of the patient.

It is interesting to note what effect this has on therapists, regarding their personal and professional development in relation to their feeling toward their own native culture, when one is constantly identifying with the patients and their foreign cultures, having to distance themselves in the next moment to assume the role of the catalyst once more.

VI. SUMMARY AND OUTLOOK

Many countries are faced with an increase in multi-culturally based problems for which not only political but also specific psychotherapeutic solutions must be sought. On the basis of a bio-socio-psycho-spiritual view of humanity, there are two main tasks for “transcultural psychiatry and psychotherapy.”

1. Adequate care that is suitably based on the individual and cultural background of mentally disturbed immigrants, along with their family and other close relations, is of prime importance. This should include a necessary and learnable sensitization of the therapist to cultural diversity, complemented by the use of professional interpreters when necessary.

2. With disregard for Americo- and Eurocentrism and school disputes, the vast area of transculturally comparative therapy research is concerned with offering the best forms of therapy to suit the requirements of the patients. Clarification for the culturally diverse self-understanding of mental illnesses in patients from other countries will ensue as a matter of course.

The experiences of many psychotherapeutic measures of other traditions are becoming of increasing interest in the Western world. For thousands of years these methods have demonstrated their value. These may not only be felt bodily but may be also related in language that uses subtle energetic–functional terms (not to be misinterpreted as purely symbolic). Consequently, methods taken from other cultures that influence the psyche are playing a more significant role in an increasingly globalized and multicultural society.

The future of psychotherapy will most likely be submitted to culturally reciprocal influences, which will not only affect the diagnostic criteria and the general attitude of life but also expectations regarding psychotherapy. Discussions in China have shown that Western forms of psychotherapy are gradually becoming better known and accepted; however, many Chinese emphatically be-

lieve that the use of Western methods in conjunction with their own methods and thinking will bring about some changes in Western psychotherapeutic procedures in China. In 1993, Louis Yang-ching Cheng, Fanny Cheung, and Char-Nie Chen described these mutual influences regarding practice in Hong Kong and for Chinese people in general. Sylvester Ntomchukwu Madu, Peter Baguma, and Alfred Pritz reported in 1996 the same relating to Africa. We must recognize that one culture can offer its therapeutic methods to other cultures, as discussed by Xudong in 2001 and Peseschkian in 2001. But it is up to each individual culture to decide what to accept, what to alter, and what to refuse.

See Also the Following Articles

Bioethics ■ Cultural Issues ■ Multicultural Therapy
■ Race and Human Diversity

Further Reading

- Bebbington, P., Hamdi, E., & R. Ghubash (1998). The Dubai Community Psychiatric Survey, IV. *Social Psychiatry and Psychiatric Epidemiology*, 33, 501–509.
- Devereux, G. (1982). *Normal und anormal. Aufsätze zur allgemeinen Ethnopsychiatrie*. Frankfurt: Suhrkamp.
- Fernando, S. (Ed.). (1996). *Mental health in a multi-ethnic society* (2nd ed.). London: Routledge.
- Foa, E. B., Keane, T. M., & Friedman, M. (2000). *Effective treatments for PTSD*. New York: Guilford.
- Heise, T. (Ed.). (1998). *Transkulturelle Psychotherapie*. Berlin: VWB-Verlag.
- Hiscox, A. R., & Calisch, A. C. (Eds.). (1998). *Tapestry of cultural issues in art therapy*. London: Jessica Kingsley.
- Jacobs, M. (Ed.). (1996). *Jitendra, lost connections. In search of a therapist*. Buckingham and Philadelphia: Open University Press.
- Kareem, J., & Littlewood, R. (Eds.). (1992). *Intercultural therapy: Themes, interpretation and practice*. Oxford: Blackwell Scientific.
- Krause, I.-B. (1998). *Therapy across culture*. London: Sage.
- Lago C., & Thompson, J. (1996). *Race, culture and counselling*. Buckingham and Philadelphia: Open University Press.
- Lala, S., & Straussner, A. (Eds.). (2001). *Ethnocultural factors in substance abuse treatment*. New York: Guilford.
- Parin, P., Morgenthaler, F., & Parin-Matthey, G. (1963). *Die Weißen denken zuviel*. Zürich: Atlantis.
- Payer, L., & White, K. L. (1996). *Medicine and culture: Varieties of treatment in the United States, England, West Germany, and France*. New York: Owl.
- Pedersen, P. B., Draguns, J. G., Lonner, W. J., & Trimble, J. E. (Eds.). (1996). *Counseling across cultures* (4th ed.). London: Sage.

- Rowan, J. (1998). *The transpersonal. Psychotherapy and counselling* (2nd ed.). London: Routledge.
- Sack, M., Lempa, W., & Lamprecht, F. (2001). Metaanalyse der Studien zur EMDR-Behandlung von Patienten mit posttraumatischen Belastungsstörungen. *Psychotherapie, Psychosomatik, Medizinische Psychologie*, 51, 350–355.
- Sluzki, C. E. (2001). Psychologische Phasen der Migration und ihre Auswirkungen. In T. Hegemann, & R. Salman (Eds.), *Transkulturelle Psychiatrie* (pp. 101–115). Bonn: Psychiatrie-Verlag.
- Smith, P. B., & Bond, M. H. (1998). *Social psychology across cultures* (2nd ed.). Hertfordshire: Prentice Hall Europe.
- Ward, C. (Ed.). (1989). *Altered states of consciousness and mental health: A cross-cultural perspective*. Newbury Park, CA: Sage.
- Westen, D. (1996). *Psychology: Mind, brain and culture*. New York: Wiley.
- Wittkower, E. D. (1978). Probleme, Aufgaben und Ergebnisse der transkulturellen Psychiatrie. In E. Wulff (Ed.), *Ethnopsychiatrie*. Wiesbaden: Akadem. Verlagsges.

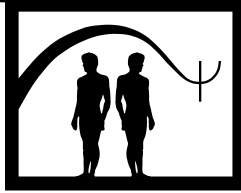

Transference

Eric R. Marcus

Columbia University College of Physicians and Surgeons and Columbia University
Psychoanalytic Center for Training and Research

- I. Introduction
- II. History
- III. Function
- IV. Types
- V. Transference Neurosis
- VI. Phases of Transference
- VII. Use in Psychotherapy
- VIII. Applications of Transference
- IX. Summary
- Further Reading

GLOSSARY

personality Characteristic attitudes and behavioral reaction patterns based on temperament and experience.

resistance Unconscious defenses to psychoanalytic treatment or to the transference. Resistance is a term for defenses that are used against the treatment process or against the transference.

transference The transfer of feelings about childhood relationships onto the experience of the relationship with the analyst.

transference resistance Unconscious blocks to experiencing the development of the transference; defenses against the transference.

I. INTRODUCTION

Transference refers to feelings the patient has for the analyst. The term transference was first used by Freud

to refer to the neurotic feelings that were displaced or transferred from formative relationships in the patient's childhood. Transference is of crucial importance to psychoanalytic treatment because transference reactions help bring into consciousness the content and organization of the patient's unconscious self and object representations, and can dramatically demonstrate the effect of constituent conflicts, defenses, and compromises. Transference is the patient's experience in the present that comes closest to those formative relationships from the past.

As psychoanalysis widened its purview beyond mental symptoms to include the analysis of personality, the definition of transference was broadened to include all feelings the patient had for the psychoanalyst. This broadened definition included emotional reactions in the here and now that are basic to personality function.

II. HISTORY

The term transference was first used by Sigmund Freud, who discovered the phenomena in the course of his earliest treatments. He at first felt these transference reactions prevented easy and thorough reports of the emotional associations to symptoms connected to the patient's history. Seen perhaps most clearly in fears about a judgmental attitude in the analyst, Freud thought such transference anxieties could block the treatment by inhibiting a full report of symptoms and

associations. Therefore Freud at first felt that transferences were resistances to the treatment and were to be confronted by the psychoanalyst and consciously overridden by the patient. Later, Freud realized that these transference resistances were unconscious and were characteristic of the patient's personality defenses and adaptations. They displayed important aspects of the patient's symptoms. Freud further realized that the transference resistances often encoded and expressed the same themes as the patient's illness.

III. FUNCTION

Freud therefore began to focus on the transference and discovered that as the transference was allowed to intensify, the pathological attitudes and conflicts central to personality defenses rose to conscious intensity. This emotional intensity gave an experience of emotional validity to the treatment that was invaluable. Patients could see the emotional truth in their conflicts and compromise formations. Freud saw there was often little else that encoded so directly, so consistently, and so intensely these basic personality conflicts and compromise adaptations. When these compromise formations are part of personality attitude, the transference and personality disorder coincide. Analysis therefore more and more focused on transference, which became a hallmark of psychoanalytic treatment.

IV. TYPES

The emotional content of transference material may vary. The dominant theme of the content of the emotional transference is then used as a label to categorize different types of transference reactions.

The maternal transference involves the emotional experience of the analyst as a mothering figure. Conflicts about dependency needs and frustration, usually mobilizing intense conflicts between aggression and tender care, comprise the typical conflicts of this type of transference. Often associated with the personality features of the primary mothering figure, together with the child's reaction to the maternal personality, the two combine to form the projections onto the analyst, and the reactions to these projections, that form the maternal transference.

There is a similar transference possible to issues of authority and competition, often with fears of punishment. This type of material may be associated with the patient's early experiences of the father's personality. They condense together with the patient's personality

reactions and the inevitable conflicts of growth and development. Together these form the projections onto the analyst, and the reactions to those projections, that are classically labeled the paternal transference.

Of course, sibling transferences (typically of competition and aggression), grandparent transferences (typically of tender care and an absence of competition), as well as transferences from other important figures during the patient's formative years are not only possible but probable.

Transferences may also be categorized according to the dominant emotional reaction. Erotic transferences involve sexual content irrespective of the formative figure involved. Aggressive transferences involve the emotional experience of anger. Idealizing transferences involve the projection of perfection. Denigrating transferences are the projection of feelings of devaluation.

Combinations of transferences are more the rule than the exception. The particular combinations are not just mixtures but highly specific condensations that reveal basic emotional compromise formations achieved in an attempt at emotional adaptation to constituent conflicts.

Because of these strong basic emotions and their combinations, containing the transference reaction both to the treatment setting and to the capacity of the patient to experience and describe rather than enact, the analyst must take great care in both the nurturing and containing of these reactions. The method of nurturing involves interpretation of resistances to the transference and the method of containing involves interpretation of the effects of the transference intensities. This is basic to psychoanalytic technique.

One of the most intense, most difficult to manage, and potentially destructive forms of transference and transference neurosis is the negative therapeutic reaction. In this form of transference, intense negative feelings are focused either on the analyst, the patient, or both as a result of the psychoanalytic treatment. Paradoxically, the reaction happens when things seem to be going well in the treatment. The negative therapeutic reaction is a reaction to accurate interpretation by the analyst, which then triggers an intense aggressive and guilt response. The danger is that the treatment may break off before the opportunity to thoroughly analyze the triggering factors, the constituents, and the destructive compromises inherent in the negative therapeutic reaction. The destructive nature of this reaction is often operating unconsciously at a lesser intensity throughout the patient's life and experience of themselves. It is one reason for life stalemate, life failure, chronic unhappiness, and self-destructive behavior.

V. TRANSFERENCE NEUROSIS

The focus on transference manifestations led Freud to the discovery of the transference neurosis. In the transference neurosis, the entire range of the patient's personality and neurosis is displayed in the psychoanalytic treatment relationship, and focused on the analyst and the treatment. This intense emotional involvement of the patient with the analyst and with the analytic treatment can reveal in great detail the emotional conflict elements and their psychopathological compromises. The analysis of the transference neurosis may take up the better part of the middle phase of psychoanalytic treatment.

Crucial to the use of the transference neurosis is the ability to catalyze its engagement, to manage its intensity, to analyze and interpret its meaning, to progressively unfold its developmental layers, and to show its relevance to the patient's symptoms and personality dysfunctions. It is for this reason especially that psychoanalytic training is long, arduous, and involves personal analysis for the practitioner.

Because transference is such a direct and felt experience, psychoanalytic technique attempts to bring it to an optimal level of intensity. This is why patients in analysis are seen many times per week and use the couch. Frequent sessions allow the intensity to build. Use of the couch helps because normal social interaction may dilute transference emotional reactions with reality representations or with reality experiences. Placing the patient out of sight of the analyst and reducing social interaction can increase the intensity, and therefore the consciousness of the transference.

Transference occurs as a part of all relationships but is not necessarily as consistently intense, nor verbalized, nor are its antecedents studied in an attempt to change. The transference neurosis can emerge in psychoanalytic treatment because the analyst is skilled at managing intensity. The analytic setting provides a safe setting because of the dependability, confidentiality, and lack of any agenda in the analyst other than the care of the patient.

VI. PHASES OF TRANSFERENCE

The different phases of psychoanalytic treatment can be defined in relationship to the transference. In the first phase, the transference is beginning to be catalyzed and engaged through the analysis of resistances to the transference. In the middle phase the transference neurosis forms, intensifies, progresses, and is ana-

lyzed. During the middle phase a deeper understanding of the transference and its origin occurs. During this phase, the insights from the analysis of the transference neurosis are applied to the patient's problems and pathological personality adaptations and these applications are worked through. The termination phase of analysis is the phase of resolution of the transference neurosis. During this phase, because of gains made in the analysis that resulted in psychological change, the neurotic transference reaches a kind of emotional conclusion. It then becomes less intense and disengages from the reality person of the analyst.

VII. USE IN PSYCHOTHERAPY

Transference is also triggered and used in psychodynamic psychotherapy. Although the focus may not be consistently on this level of the work with the patient, emotional reactions in and to treatment are used by the therapist to understand patients' reactions to people and problems that are the focus of treatment. The transference is thus a textbook of the patient's personality reactions to be read carefully by the analyst and analyzed thoroughly in psychoanalysis. Although not necessarily analyzed so thoroughly with the patient in psychodynamic psychotherapy, the transference is as crucial to the treating psychotherapist as it is to the psychoanalyst. The problem may be that because the psychotherapy is less intense, the exact nature of the transference is unclear. However, even in less intense or briefer treatments, the transference may be strong enough to reveal itself at least partially. Even this is useful to the treating analyst, who applies the information to understanding the patient's problems even if the transference is not usually the primary focus of psychodynamic psychotherapy.

VIII. APPLICATIONS OF TRANSFERENCE

Transference is important in all medical treatment. Emotional reactions may help or impede any form of helping relationship. In medical treatments, the most common cause of noncompliance to medication is an emotional problem in the doctor-patient relationship. In psychopharmacology treatments, patients may resist their medication because of emotional relationships they have either with the treating doctor or with the medication itself. The sophisticated psychopharmacologist understands these transference reactions and interprets especially the patient's attitudes toward medication.

Psychopharmacologists psychologically sophisticated in this way achieve better compliance with medication regimens and therefore better outcomes. Likewise, the sophisticated cognitive-behavioral therapist is attuned to even nascent transference reactions to the treatment or to themselves. This is especially so where either the reactions are negative resistances to the treatment or where the reactions are so idealizing that they imply the power of change is in the therapist rather than in the patient. Cognitive-behavioral therapists are adept at either sidestepping such transferences or including the attitudes as targets for their treatment. Their treatment aims at giving patients more conscious control over aspects of these attitudes that interfere with their treatment and support their symptoms.

The role of transference in all medical care is so powerful because illness tends to trigger emotional regression in patients, as does the setting of care in which trust and hope are to be vested in someone else, a dependency situation most like early childhood. Because of its application to medical care, to teaching, to social services, and even to institutions, the concept of transference is perhaps Freud's widest contribution.

IX. SUMMARY

All schools of psychoanalysis make use of transference. Ego psychology uses it to understand mental structure, its constituent conflicts, and compromises. Object relation theorists use it to understand the contents and functions of object relations. Self psychologists use it to understand the state of empathic attunement. Transference is basic to psychoanalysis.

See Also the Following Articles

Countertransference ■ Free Association ■ Intrapsychic Conflict ■ Resistance ■ Transference ■ Neurosis ■ Unconscious, The

Further Reading

- Freud, S. (1915). *Observations on transference love*. (Standard ed. vol. 12.) London: Hogarth Press.
- Sandler, J., Dare, C., & Holder, A. (1992). *The patient and the analyst* (2nd ed.). Madison, CT: International Universities Press.

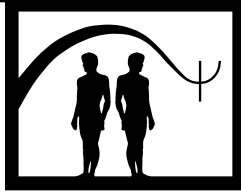

Transference Neurosis

Alan Sugarman and Claudia Law-Greenberg

San Diego Psychoanalytic Society and Institute and University of California, San Diego

- I. Freud's Concept of Transference
 - II. Greenson's Concept of Transference Neurosis
 - III. Legitimacy Controversy
 - IV. Structural Basis
 - V. Summary
- Further Reading

GLOSSARY

compromise formation Any mental phenomenon that is the product of internal conflict and expresses all components of the conflict.

conflict Opposition between mental forces. These forces can be instinctual or Freud's structures of the mind (id, ego, superego).

countertransference The analyst's feelings toward the patient. Some restrict the term to the analyst's emotional responses to the patient's transference.

defense The methods used by the ego to master and control id impulses or superego injunctions.

ego The hypothetical construct defined in Freud's structural model to enable the mind to organize its various components and to adapt to the external world.

libido The hypothetical psychic energy attached to the sexual instincts.

psychic energy Freud believed there was a quantifiable mental energy, similar to physical energy, that fueled the activity of the mind. Two major types of psychic energy were postulated—sexual energy (libido) and aggressive energy.

repression The particular defense mechanism of the ego by which a conflictual mental content or process is rendered unconscious.

resistance The manifestation of defense within the treatment process whereby the patient opposes the analyst's interventions.

structural model Freud's final model of the mind introduced in 1923 in *The Ego and the Id*. The mind was conceived of having three structures (the id, ego, and superego). Interaction between these three structures is thought to account for all mentally mediated behavior.

topographic Freud's earlier model of the mind in which its systems were defined in terms of their accessibility to consciousness. Despite the topographic model having to be discarded because of its theoretical inconsistencies and clinical failings the term *topographic* remains useful for describing mental contents and functions in regard to their degree of consciousness.

transference The process by which the patient displaces onto the therapist or analyst feelings, impulses, attitudes, or defense derived from important interactions in the past.

The phenomenon of transference neurosis is arguably the most important (and perhaps most controversial) concept in the psychoanalytic theory of technique. For almost 50 years its presence or absence has been used to determine whether a psychoanalytic treatment process is, in effect, true psychoanalysis or whether it is psychoanalytic psychotherapy. Merton Gill, in 1954, was one of the earliest psychoanalysts to differentiate psychoanalysis from psychotherapy based on whether or not the patient had developed a regressive transference neurosis in the treatment that could be resolved by interpretation. Leo

Stone, another prominent analyst of that era, concurred with Gill. But by the time of Gill's death, Gill, himself, as well as others had repudiated both his definition of transference neurosis and its centrality to the analytic process.

I. FREUD'S CONCEPT OF TRANSFERENCE

Understanding this reversal and arriving at an adequate modern-day understanding of both the concept and its role require that one study its origins in Freud's thinking. As with most of Freud's other technical concepts, the term transference neurosis predates the introduction of his structural model. Hence the concept was never reformulated or adequately integrated into Freud's new manner of thinking, leading to inconsistencies and ambiguities that continued to affect how the concept is used today. Freud first introduced the concept of transference in *Studies in Hysteria* when he discussed the "false connection" between feelings arising outside the treatment situation and those directed toward the therapist. That is, he recognized that feelings and thoughts originally experienced in regard to significant figures in the patient's life, usually from childhood, were displaced onto the analyst. Soon transference was viewed as a displacement of libidinal ties into the treatment situation.

In his *Introductory Lectures*, Freud introduced the concept of transference neurosis as a diagnostic category that included both hysterical and obsessional neuroses. Such transference neuroses were thought to be the most amenable to a successful psychoanalytic treatment because patients suffering from them were able to form a relationship with the analyst and to be influenced by their transference to the treater. Patients suffering from transference neuroses were differentiated from those suffering from narcissistic neuroses (paranoids, melancholics, and schizophrenics). Freud thought that the latter group had no capacity for a transference relationship with the therapist and, therefore, was incapable of being helped by psychoanalytic treatment.

Earlier in his thinking Freud had first understood transference as a resistance to the remembering of the past. At that stage in the evolution of his theory and technique, such resistance was quite important given that psychoanalytic cure was thought to occur when the patient was made aware of previously unconscious mental contents, usually sexual fantasies from the past. By 1912, however, Freud raised the analysis of transference to the forefront of analytic technique. He described the transference neurosis as the replacement of

the patient's clinical neurosis with an artificial neurosis "through which the patient could then be cured through the therapeutic work" in his 1914 paper, *Remembering, Repeating, and Working Through*.

The transference neurosis was described as the creation of an intermediate region between illness and real life. This newly created condition was said to contain all of the conflicts or elements of the clinical neurosis, making them amenable to therapeutic intervention. In essence, Freud came to understand the transference neurosis as a phenomenon in which the libido shifted from the original object(s) and associated internal conflicts into the transference where it became concentrated on the analyst. The original conflicts were then experienced with emotional immediacy in the relationship with the analyst. The analyst could then analyze these conflicts in a context of intense affectivity that allowed their historical or unconscious roots to become evident. Fresh repression was avoided, and the freed up psychic energy then became available to the patient's ego.

II. GREENSON'S CONCEPT OF TRANSFERENCE NEUROSES

This understanding of the transference neurosis held sway in American psychoanalysis into the early 1970s. It was given the greatest legitimacy by Ralph Greenson, arguably the greatest clinical analyst of his era, in his tome, *The Technique and Practice of Psychoanalysis*. Greenson made it clear that he viewed the development of a transference neurosis to be a central dimension of the psychoanalytic process. He described its phenomenology as involving an increase in the intensity and duration of the patient's preoccupation with the analyst and the analytic process. This intensified interest in the analyst is usually experienced by the patient as a mixture of love and hate as well as defenses against these emotional reactions triggered by anxiety and guilt. Reactions to the analyst were described as varying. They could be intense, explosive, subtle, or chronic; such constellations of affects become omnipresent once the transference neurosis takes hold. As the patient's preoccupation intensifies, his or her symptoms and instinctual demands revolve around the analyst while simultaneously remobilizing all the old neurotic conflicts. The transference neurosis, therefore, was described by Greenson as a repetition of the patient's past neurosis.

Greenson argued that the classical psychoanalytic attitude toward the transference neurosis must be to foster its development. The analyst has to safeguard the analysis to allow the best opportunity for a transference

neurosis to develop. According to Greenson, contaminations or intrusions into the analytic space, such as the analyst's personal characteristics or values, can inhibit or limit the development of the transference neurosis. Thus, they must be avoided. He took pains to warn that the analyst's countertransference could impede the development of a transference neurosis. For example, undue warmth was thought to risk inhibiting the patient's hostile transference whereas incomplete transference interpretations could produce a treatment stalemate.

III. LEGITIMACY CONTROVERSY

By 1987, however, the phenomenon of transference neurosis was being called into question on a variety of grounds. An entire issue of the journal *Psychoanalytic Inquiry* was devoted to the question of its legitimacy—hence the title of that issue, “Transference Neurosis, Evolution or Obsolescence.” Arnold Cooper was perhaps the harshest critic of the concept among the contributors to that volume. He argued that using the occurrence of a transference neurosis to differentiate psychoanalysis from other therapies left psychoanalysis in a difficult position because of the lack of precision in both the definition and the phenomenological recognition of the transference neurosis. Highlighting the term's conceptual ambiguity, he pointed out that those analysts who argued that the transference neurosis involved a heightened emotional experience of the analyst were at odds with Freud who had emphasized that the transference neurosis should be manifested more in memory than in enactment in the analytic situation. Cooper also quoted the writings of the early British analyst, Edward Glover, who had emphasized that transference neuroses developed only with regard to certain types of patients, generally those suffering from phobic, conversion, or obsessional symptoms. Thus, Glover did not see the occurrence of a transference neurosis as a differentiating factor for a psychoanalytic process.

Cooper also criticized the notion that the transference neurosis recapitulates the infantile neurosis. He pointed out the vagueness in defining the concept of the infantile neurosis. Some use the term to refer to the hypothetical childhood neurosis that presumably predated the adult one; others use the term to indicate oedipally based conflicts, while still others define it as concrete, observable, childhood, neurotic symptoms. To the extent that this concept is used in vague or inconsistent ways, it becomes impossible to describe the transference neurosis as a reactivation of it in any coherent fashion.

The connection between the concept of the transference neurosis and the infantile neurosis has also led to debate about the degree to which the transference neurosis is a regressive phenomenon. By the mid 1970s, some analysts, most notably Jacob Arlow, had argued that it was a fallacy to consider the analytic process and the activation of a transference neurosis as regressive. Rather than promoting regression, Arlow argued that the analytic situation created a context in which regressive aspects of the patient's mind could emerge in a clearly observable fashion. Merton Gill extended this view while pointing out that the transference neurosis did not involve the revival of the infantile neurosis. He challenged the entire thesis that an earlier developmental state could literally be reactivated. Rather, he believed that earlier developmental experiences that exert an active influence on present-day behavior did so because they remained active in the patient's personality. As such, he argued that such active influences would be manifested in patients' transferences to the analyst.

Such a position leads into another area of unclarity about the definition of transference neurosis. Traditionally, the concept of transference neurosis has been distinguished from the concept of transference. As mentioned earlier, the former concept has been used to distinguish a psychoanalytic process from a merely psychotherapeutic one in which many transferences develop. The latter are more fluctuating, less organized, and less intense than the sort of full-fledged transference neurosis described by Greenson. However by 1984, Gill was taking issue with this distinction. Thus, he argued that the reason for the more intense transference neurosis was not the difference in the type of treatment process involved. He believed, rather, that it was the analyst's failure to interpret earlier manifestations of transference in the treatment process that led to transferences intensifying to the point where they could not be ignored by the analyst. Thus, this sort of transference neurosis was thought by him to be a sign of poor technique, not of psychoanalytic process. For Gill there was no important clinical distinction between transference and transference neurosis. Instead he argued for early and consistent interpretation of the transference wherever it might be ferreted out in the patient's associations. Gill's technical strategy for transference interpretation has remained a minority view in psychoanalysis although his disinclination to distinguish transference from transference neurosis continues to be embraced by a number of psychoanalysts.

Charles Brenner is another prominent psychoanalyst who criticized the concept of transference neurosis. He argued, similarly to Gill, that there was nothing to be

gained theoretically or clinically by distinguishing transference neurosis from transference. Brenner argued that the term *transference* was sufficient, and that transference manifestations were compromise formations that needed to be analyzed in the same manner as any other compromise formation.

Despite these debates about the nature of the transference neurosis and its role in psychoanalytic technique, the concept continues to be valued by most theorists of analytic technique. Both editors of the *Psychoanalytic Inquiry* issue devoted to the topic concluded that transference neurosis remains a useful clinical concept and one that distinguishes psychoanalysis from psychotherapy. Nathaniel London was probably the most eloquent on the subject. He argued that the distinction between transference and transference neurosis is complex and significant, that the emergence of a transference neurosis does distinguish a psychoanalytic from a psychotherapeutic process, and that those analyses in which a full-fledged transference neurosis fails to emerge are more limited in their clinical results.

These conclusions leave psychoanalysts with the problem of defining the transference neurosis and accounting for successful clinical analyses in which one has not been manifested. A modern view is that the latter problem rests on the former. That is, many contemporary analysts believe that the apparent lack of a transference neurosis reflects a problematic definition rather than an actual failure to develop one. Too many psychoanalysts continue to think of a transference neurosis in the way that Freud did when he developed the concept. That is, it is defined as a displacement of childhood libidinal and aggressive wishes or fantasies from the parents onto the analyst in a particularly organized and emotionally intense fashion. But this definition arose from the topographic era of Freud's thinking when unconscious impulses were viewed as the explanation of most psychopathology and personality traits. The advent of the structural model in 1923 offered a more complex way of understanding transference (and, hence, transference neurosis). Freud, himself, never integrated his concepts of transference or transference neurosis with his structural model. Thus, many analysts continued to think of these concepts in a topographic manner without realizing it.

IV. STRUCTURAL BASIS

Anna Freud, in her 1936 volume, *The Ego and the Mechanisms of Defense*, offered a structurally based un-

derstanding of transference. She discussed three types of transference. It is her transference of defense that is most appropriate to a modern-day understanding. This type of transference involves the patient's projecting or externalizing significant aspects of his or her defensive structure into the analytic situation, particularly the relationship with the analyst. Thus, patients who are reported not to develop a full-fledged transference neurosis generally are found, with closer scrutiny, to be using a variation of transference of defense. Rather than displacing unconscious drive impulses onto the analyst, they externalize their defensive structure into the analytic situation and relationship with the analyst. In these instances, the defensive structure generally involves prominent defenses against feeling or becoming aware of strong emotions toward others. The apparent absence of a transference neurosis is, in actuality, an intense one whereby the analyst is treated with the same emotional detachment and/or fearfulness that characterize the patient's relationships with most important objects in his or her world, including internal representations of the parents. Thus, analysis of the transference neurosis with such patients involves the consistent confrontation, exploration, and interpretation of their distancing defenses and the reasons for them. Such work is generally quite productive but requires significant activity on the part of the analyst. Nonetheless, working in this fashion generally demonstrates the fallacy of assuming the absence of a transference neurosis and deepens the analytic work in the same way that analyzing the more obvious forms of transference neuroses do.

Those analysts who practice in this manner tend to agree that it is this work—the analysis of the transference neurosis—and all its complexity that allows for the important conflicts that cause the patient's symptoms or personality problems to be experienced and mastered by the patient in an emotionally vivid fashion. The intensity of feeling and firsthand quality of such work allows for conflict mastery far more than other nontransference elements of the analytic process. Although not scientifically demonstrated, such work does not happen in psychotherapy because the reduced frequency of sessions prevents the emergence of the sort of transference neurosis just described, although certainly transference manifestations do occur and can be worked with in a fashion that is therapeutically useful.

V. SUMMARY

In summary, the concept of transference neurosis continues to be a valuable one in psychoanalysis. It

distinguishes psychoanalysis from other forms of psychotherapy, even psychoanalytic psychotherapy. Analysis of the transference neurosis remains a crucial aspect of the analytic process, one that many continue to view as the most important in promoting mastery of conflict. Thinking in terms of the transference neurosis serves as a useful guideline for the practicing analyst. After a certain point in analysis, most analysts begin to look for the emergence of one and to attempt to understand when one is not apparent. Utilizing a contemporary structural approach to analysis allows psychoanalysts in the latter situation to more carefully observe and listen to the patient's material for evidence of the defensive aspects against deeper feelings toward the analyst, defenses that the analyst brings to the patient's awareness to analyze the reasons that the patient feels it necessary to keep the analyst at such emotional distance.

See Also the Following Articles

Countertransference ■ Intrapsychic Conflict ■
Oedipus Complex ■ Resistance ■ Structural Theory ■
Topographic Theory ■ Transference ■ Unconscious, The

Further Reading

- London, N. L. (1987). Prologue. *Psychoanalytic Inquiry*, 7, 457–463.
- London, N. L. (1987). Discussion. In defense of the transference neurosis concept: A process and interactional definition. *Psychoanalytic Inquiry*, 7, 587–598.
- Moore, B. E., & Fine, B. D. (1990). *Psychoanalytic terms and concepts*. New Haven, CT: Yale University Press.
- Stone, L. (1995). Transference. In B. E. Moore & B. D. Fine (Eds.), *Psychoanalysis. The major conflicts*. New Haven, CT: Yale University Press.
- Wallerstein, R. S. (1995). *The talking cures*. New Haven, CT: Yale University Press.

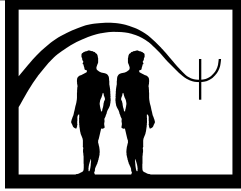

Transitional Objects and Transitional Phenomena

Arnold Wilson and Nadezhda M.T. Robinson

Columbia University Center for Psychoanalytic Training and Research and St. Mary Hospital

- I. D. W. Winnicott
 - II. Transitional Objects
 - III. Winnicott as Theoretician
 - IV. Transitional Objects
 - V. Illusion
 - VI. The Future
- Further Reading

GLOSSARY

illusion A belief or experience that is based on unconscious material and is experienced as real.

objective External reality, that which is outside the individual and separate from the individual.

subjective Unconscious material such as drives, impulses, wishes, and fears that is particular to the individual and cannot be objectively defined.

transitional object An object, typically a soft toy, chosen by an infant or child. Irreplaceable, the object is imbued with the child's feelings for and experience of his or her primary caretaker. The child uses the transitional object to aid the transition from primary dependence to independence.

transitional phenomena Individual experiences characterized by the interplay of unconscious material and objective reality in forming a novel emotional experience or state.

It is not unusual for parents or caretakers to intuitively allow children the use of some kind of object, oftentimes soft and furry, less frequently hard and with

rough edges, that becomes a special kind of beloved possession of the child. Blankets, teddies, things that easily mold to the flesh, that keep a telltale smell, that survive the transition from toddlerhood into latency, ideally serve such a purpose. It is little short of miraculous how adults recognize the life-sustaining urgency of the need for the child to cling to these possessions. Such objects are often named “momma” or some such appellation that implies an understanding that the object is a stand-in for the mother, providing similar soothing and comforting, and herein lies a key paradox of childhood—the child's ability to separate from the mother begins in holding firmly to her, or at least a rendition of her. Thus, the necessary separation from primary caretaker takes place with the assistance of some symbolic object (the transitional object) that provides the continuity of closeness to the primary caretaker.

I. D. W. WINNICOTT

This paradox—that separation can come to exist only in the context of a symbolic continuity—is the sort of recognition D. W. Winnicott set about to explore in his career. A British pediatrician turned psychoanalyst, Winnicott saw thousands of infants and mothers in London during the World War II years, while developing a remarkable oeuvre that remains influential to this day. Never a systematic thinker, his uncoordinated insights into mother–child relations, the inner life of

infants and children, the relations between aggression, security, and creativity—remain the stuff to which many contemporary investigators turn for inspiration and guidance. In this article, the reader will recognize a certain allusive and poetic use of language. This is more Winnicott's than our style, for in order to grasp and communicate what Winnicott was trying to convey, one must remain true to his style of discourse.

II. TRANSITIONAL OBJECTS

In 1951, Winnicott published his classic paper "Transitional Objects and Transitional Phenomena," which investigated the relationship between symbol formation, maternal caregiving, and the development of creativity and, in fact, the mind itself. To Winnicott, the main function of a transitional object is to "start each human being off with what will always be important for them: a neutral area of experience which will not be challenged."

Winnicott provides sufficient material for a thorough understanding of transitional objects and transitional phenomena in his first paper on the topic. He presented these concepts with rich examples from infant observation and analytic work with adults. The topic appears in later articles but is only minimally refined or elaborated there. In the 1951 paper, Winnicott defines transitional objects and transitional phenomena, describes the key concepts, and identifies areas of further exploration, which have been taken up by theorists such as Paulina Kernberg, Arnold Modell, and Peter Giovacchini.

III. WINNICOTT AS THEORETICIAN

It is helpful here to say a bit about Winnicott the theoretician. Strictly speaking, Winnicott was less of a theoretician than he was a pragmatic yet intuitively driven observer. A member of the so-called middle school, his theoretical roots are both Freudian as well as Kleinian, especially in his uncanny understanding of the role of aggression in early mental life. His writings have contributed many fundamental concepts to the body of psychoanalytic thought (for example the good-enough mother, primary maternal preoccupation, the capacity for concern, and hate in the countertransference) which are not so much particular to a comprehensive theory as they are critical to what we might call the experience of being. Fogel explicates this in an article titled "Winnicott's Antitheory" wherein he explains that

Winnicott was traditionally analytic in his theoretical beliefs but obviously singular and unique in terms of his distinctive application and elucidation of the concepts that stand alongside traditional theory. Transitional phenomena and objects are good examples of this. Truly grasping what Winnicott meant is crucial in order to undertake clinical work with children or psychoanalytic work with adults yet this knowledge does not necessarily alter in any way one's theoretical foundation. Thus, it is a challenge to fully describe Winnicott's concepts of transitional objects and transitional phenomena. On the one hand, understanding what he was trying to convey makes available an intellectual and, Winnicott would hope, experiential knowledge of self and other that deepens our contact with others. On the other hand, one will not find any particular alteration to one's structural understanding of the individual or technical view of the practice of psychotherapy on the basis of the knowledge.

IV. TRANSITIONAL OBJECTS

A transitional object is an object that is chosen, or, to be more explicit, Winnicott says "created," by the infant and that stands for the breast or object (bottle, caregiver's face) of the first relationship. It is developmentally appropriate, indeed a positive indicator of a healthy maternal-child bond, typically develops first between 6 and 9 months, and lasts often into the preschool years. It is the child's first possession and original "not-me" object. By this, Winnicott means that the child is sufficiently developed to have a growing sense of object permanence and constancy (see Piaget for discussion of object permanence.) Thus, the child is able to conceive of the transitional object's separateness from himself. Object use begins with an infant's use of fist-in-mouth, then thumb, then some mixture of fingers and thumb, and finally the infant moves to the use of an object. There is a gradual progression toward the use of objects that are part of neither the mother nor the infant but represent the shared experiences of both.

Certain features mark the relationship between the transitional object and infant. Perhaps most remarkable is the infant's assumption of possession of the object and the environmental cooperation with that. Caregivers hesitate to wash well-loved transitional objects and households are collectively turned inside out when a transitional object goes missing. The transitional object is "affectionately cuddled" and "excitedly loved

and mutilated.” The transitional object possesses a reality and vitality of its own. It is cocreated by the infant’s objective perception of the object and his or her subjective projections of relating (in this case, loving and being loved) onto the object.

Winnicott talks of the “fate” of the transitional object in further defining it as well as further illustrating the depth and a particularly unique feature of his theory. Winnicott proposes a “third area” of “existing” or human life, which is where transitional phenomena grow and live. For the purposes of this article, they shall be called the first and second areas, as Winnicott did not name them. The first area is the fundamental reality of individual experience. It is the inner life, intrapsychic world, or “personal psychic world” in Winnicott’s words. Here we find the genesis of dreams, hallucinations, and the creative process. The first area of existence is our store of preferences, idiosyncrasies, and “neuroses.” The second area is the external world of the individual composed of our relations with others, standards of conscience, and the various roles we fulfill (husband, wife, worker, friend, parent, sibling). Winnicott calls this the “expanding universe which man contracts out of.”

Transitional phenomena illustrate the joining of the first and second areas of consciousness, which Winnicott calls the “cultural life of the individual.” This third area is the meeting of the objective–subjective, personal–political, internal–external realms of individual experience. Using the example of the teddy bear as transitional object, we see that the teddy is an external object (second area) real to the infant and his extended external reality (parents, siblings, etc.). Yet, the teddy also represents the material of the infant’s inner life (first area) to the extent that the teddy is a cuddling, nurturing, soothing, nonretaliatory object of his or her aggression, and a constant reliable feature of his or her existence. The infant has made the teddy with the imbuing of these unconscious features while also, for the first time, using an object outside himself to serve as a receptacle for internalized experiences. It is useful to note here Winnicott’s famous phrase that “there is no such thing as a baby.” Winnicott’s view of infant and mother are as a union, the “nursing couple” and, according to the infant’s perceptions, the mother does not exist without him or her; indeed, mother exists because of him or her. With the development of transitional objects, and by implication, the ability to live in the third area, the infant is demonstrating his or her ability to perceive the external world as separate while simultaneously giving away his or her reliance on the unconscious/first area. The use of transitional objects

demonstrates the emergence of the baby as separate from his or her primary caretaker.

The transitional object sits in the middle of the continuum between the subjective and objective. It is slowly moved more and more toward the objective as the child grasps reality, develops reality testing, and is confronted with the inevitable frustrations of external reality. Thus, the fate of the transitional object is to “fade away” but never leave. The object loses its importance in the maintenance of and elaboration of unconscious material; other mechanisms such as play, language, and interpersonal interactions serve this function. But, Winnicott argues, we see the vestiges of transitional objects and the vibrancy of transitional phenomena in the human activities of art and the appreciation of creativity and religion.

Winnicott is especially concerned with the ability to symbolize that the use of transitional objects implies. Symbolization implies a broader human activity, interesting to Winnicott, which is the use of illusion. The transitional object simultaneously serves the infant’s unconscious life of merger and union and external life of independence and self-reliance.

Here we arrive at another particular element of Winnicott’s thought and the aspect of the theory of transitional phenomena that continues to be the focus of theorists and practitioners today.

From birth and thereafter the human being is concerned with the problem of the relationship between what is objectively perceived and what is subjectively conceived of. . . . The intermediate area to which I am referring is the area that is allowed to the infant between primary creativity and objective perception based on reality testing. The transitional phenomena represent the early stages of the use of illusion, without which there is no meaning for the human being in the idea of relationship with an object that is perceived by others as external to that being.

V. ILLUSION

Winnicott’s exploration of the use of illusion was not without precedent at the time. Freud in 1920 had described his grandson’s ability to symbolize his own reality and existence through play when briefly separated from his mother. Muensterberger describes two theorists whose work predates Winnicott’s and is clearly in the same vein. Geza Roheim described the activity of filling one’s mind with thoughts of the people and relationships we are separated from as the “theory of an

intermediate object as stabilization between a trend that oscillates between clinging and going exploring.” The reference here to the “intermediate object” is very similar to Winnicott’s term the “intermediate area” and in fact, Roheim is clearly describing a transitional object (i.e., teddy bear) that helps the infant feel grounded enough to explore. Roheim later writes of the transitional phase “located somewhere halfway between the pure pleasure principle and the reality principle.” Again, this description is very similar to Winnicott’s description of the 1st, 2nd, and transitional areas of human experience. Here, Roheim is referring, in part, to an earlier work by Hermann, called seminal by Muensterberger, which is titled “To Cling—to go in Search.” Hermann’s view, very similar to Winnicott’s, is that the infant requires a link between his or her inner experience and emerging external experience. When the link is concretized, it is a transitional object. The link may also be imaginal (the memory of a connection with a significant other) in which case, the memory lives and is sustained in the transitional area.

VI. THE FUTURE

Winnicott’s concepts also provided the framework for generations of future papers. The most important aspect of his paper, in terms of the advancement of the field, is the explication of the transitional phenomena. Green states “It is easy to see that Winnicott has in fact described not so much an object as a space lending itself to the creation of objects.” Indeed, after his death his wife Clare described how Winnicott considered this one of his most important achievements and it is evident that transitional phenomena, this area of the experiential field is the groundwork for much of his more important work including primary maternal preoccupation, playing in reality, and the facilitating environment. Describing transitional phenomena is a bit like describing a fog—we can only present the outline of it against the land and sky, note its thinner aspects, and watch its movement and effect. The transitional phenomenon is in fact an experience and one further complicated by its straddling of the objective and subjective experiences of the experienter.

Winnicott described transitional phenomena as “an intermediate area of experience” and further stated “I am therefore studying the substance of illusion.” This is a most remarkable statement for Winnicott to have made. The use of illusion is at the heart of the transitional phenomena. Here, Winnicott draws our atten-

tion to the activity of the early infant in perceiving the breast (or substitute) as created by and for him or her by virtue of the good-enough mother’s repeated presentation of the breast at the moment the baby requires it—and early on, before the baby “knows” he or she requires. “The mother’s adaption to the infant’s needs, when good enough, gives the infant the *illusion* that there is an external reality that corresponds to the infant’s own capacity to create.” Our appreciation of and reliance on illusion is therefore with us from our earliest days. “From birth therefore the human being is concerned with the problem of the relationship between what is objectively perceived and what is subjectively conceived of.” Gradually, reality seeps into the infant’s sense of omnipotent control of the environment (still perceived as aspects of himself or herself) and the infant is confronted with the reality of the objective world. The good-enough mother allows the gradual impingement of reality, understanding the infant’s need to be disappointed and thereby develop reparative capacities. The place where the objective and subjective meet, where our experience is created by the interaction between our subjective material and objective reality remains and is exercised in our appreciation of the arts, practice of religion, and ability to symbolize our daily experience lives. Winnicott called it the “neutral area of experience which will not be challenged.” We do not argue with a person who cries during a soulful passage of a cello concerto or who believes in the sacrament of the Eucharist, nor do we argue with the poet who draws meaning from the curve of an arm. Only when an individual requires us to endorse the “objectivity of his subjective phenomena” do we “discern or diagnose madness.” It is when a delusional patient asks us to believe a plot involving the FBI and CIA is the true source of his or her pervasive sense of danger, importance, and isolation that we see the bullying imposition of subjective experience in the intermediate/transitional realm of experiencing.

The nature of illusion and the transitional phenomena are important to current theorists for two general reasons. First, theorists who use clinical data to expand theory have advanced the importance of illusion; second, clinicians use theory to understand clinical material. While current theorists are typically psychoanalytic theorists, because Winnicott’s theory is best applied to any two individuals conducting a relationship it is widely applicable. Clinically, researchers like Paulina Kernberg use the concept of transitional objects to identify her patients’ abilities and frustrations of mediating internal impulses and fantasies while managing

an overwhelming and confusing experience of the external world. Kernberg's most ill patients develop no transitional object use or maintain a transitional object that is cruel, rejecting, and a poor receptacle for feelings of love, hope, and forgiveness. Kernberg uses the theory of transitional objects to further clarify her patients' functioning. Peter Giovachinni in 1987 explicates the use of transitional objects and of transitional phenomena in adult borderline states from a broad clinical, phenomenological perspective. He expands the theory of the transitional object in his consideration of the borderline patient's inability to regulate affect states and adaptively use projection, thereby making impossible the use of a transitional object. Arnold Modell in 1962 detailed the idea that the adult borderline patient lives in an inner world devoid of transitional phenomena, starkly reality bound, with all the attendant harshness and abrasions of the unmitigated reality of life. In all applications, the theory of transitional objects and transitional phenomena is useful in understanding the intra- and interpersonal functioning of an individual.

Theoretically, Green tells us that Winnicott's place is in guiding any analytic work that does not strictly adhere to the tenets of classical analysis. Green states "It seems to me that the only acceptable variations of classical analysis are those whose aim is to facilitate the creation of optimal condition for symbolization." Symbolization is a transitional phenomenon. It is Winnicott's explicit assumption that reality acceptance is a never-ending task and that the intermediate area of experience, illusion, or transitional phenomena (all different names for the same, unchallenged experience) provide relief from the ongoing tension of relating internal and external reality. This experience is what many good therapists attempt to create and sustain for their patients. More precisely, therapists and patients work to cocreate this experience. The intermediate realm of experience is activated in what Winnicott termed "the holding environment," is present in unconditional positive regard, and whatever the orientation, facilitates the therapist's ability to understand his or her patient in a meaningful and intimate, beyond-language way.

Winnicott left a legacy of literature that remains vital, challenging, and inspiring. Moreover, he left detailed insights about what it means to be human, to love, to mourn, to long for, and to hope. His concept of the transitional object is one of his better known contributions. Perhaps teddy bears and blankies appeal to all of us, regardless of age. It would be a underestimation of Winnicott's contribution to characterize his

thoughts on transitional phenomena as primarily about soft cuddly toys. He described a realm of experience, never before or since captured with such elegance, wherein we have the capacity to be moved by art, find solace in religion, and use illusion in various ways to adapt and meaningfully mediate one's constant grappling with reality.

In this article, the theory of transitional objects and phenomena was presented. Additional considerations of more current applications of the theory were also presented. It is the authors' hope that the reader has been both awed and bemused by Winnicott.

See Also the Following Articles

Animal-Assisted Therapy ■ Child and Adolescent Psychotherapy: Psychoanalytic Principles ■ Dreams, Use in Psychotherapy ■ Parent-Child Interaction Therapy ■ Primary-Care Behavioral Pediatrics ■ Therapeutic Storytelling with Children and Adolescents

Further Reading

- Bak, R. C. (1974). Distortions of the concept of fetishism. *Psychoanalytic Study of the Child*, 29, 191-214.
- Busch, F. (1974). Dimensions of the first transitional object. *Psychoanalytic Study of the Child*, 29, 215-229.
- Busch, F., Nagera, H., McKnight, J., & Pezzarossi, G. (1973). Primary transitional objects. *Journal of the American Academy of Child Psychiatry*, 12, 193-214.
- Coppolillo, H. P. (1967). Maturational aspects of the transitional phenomenon. *International Journal of Psycho-Analysis*, 48, 237-246.
- Coppolillo, H. P. (1976). The transitional phenomena revisited. *Journal of the American Academy of Child Psychiatry*, 15, 36-48.
- Escalona, S. K. (1953). Emotional development in the first year of life. In M. J. E. Senn (Ed.), *Problems of infancy and childhood* (pp. 11-12). New York: Josiah Macy Jr. Foundation.
- Fogel, G. (1992). Winnicott's antitheory and Winnicott's art. *The Psychoanalytic Study of the Child*, 47, 205-222.
- Gaddini, R., & Gaddini, E. (1970). Transitional objects and the process of individuation. *Journal of the American Academy of Child Psychiatry*, 9, 347-365.
- Galenson, E., & Roiphe, H. (1971). The impact of early sexual discovery on mood, defensive organization, and symbolization. *Psychoanalytic Study of the Child*, 19, 448-469.
- Green, A. (1978). Potential space in psychoanalysis: The object in the setting. In S. A. Grolnick & L. Barkin (Eds.), *Between Reality and Fantasy* (pp. 167-191). New York: Jason Aronson.
- Hong, K. M. (1978). The transitional phenomena: A theoretical integration. *The Psychoanalytic Study of the Child*, 33, 47-78.

- Jacobson, E. (1964). *The self and the object world*. New York: International Universities Press.
- Kahne, M. J. (1967). On the persistence of transitional phenomena into adult life. *International Journal of Psychoanalysis*, 48, 247–258.
- Kernberg, P. (1988). Children with borderline personality organization. In C. J. Kestenbaum & D. T. Williams (Eds.), *Handbook of clinical assessment of children and adolescents*. Vols. I & II. (pp. 604–662). New York: New York University Press.
- Kernberg, P. (1989). Childhood psychosis: A psychoanalytic perspective. In S. Greenspan & G. Pollock (Eds.), *The course of life*. Vol. III. *Middle and late childhood* (pp. 115–134). Madison, CT: International Universities Press.
- Modell, A. H. (1963). Primitive object relationship and the predisposition to schizophrenia. *International Journal of Psycho-Analysis*, 44, 282–292.
- Muensterberger, W. (1962). The creative process: Its relation to object loss and fetishism. In *The Psychoanalytic Study of Society* (Vol. 2). New York: International Universities Press.
- Stevenson, O. (1954). The first treasured possession. *The Psychoanalytic Study of the Child*, 9, 199–217.
- Tolpin, M. (1971). On the beginnings of a cohesive self. *The Psychoanalytic Study of the Child*, 26, 316–352.
- Winnicott, D. W. (1953). Transitional objects and transitional phenomena. *International Journal of Psycho-Analysis*, 34, 89–97.

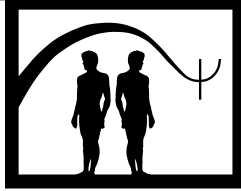

Trauma Management Therapy

B. Christopher Frueh

Medical University of South Carolina

**Samuel M. Turner
and Deborah C. Beidel**

University of Maryland at College Park

- I. Description of Treatment
 - II. Theoretical Bases
 - III. Empirical Studies
 - IV. Summary
- Further Reading

tion of patient education, exposure therapy, social skills training, and relevant homework assignments.

GLOSSARY

exposure therapy A well-established behavioral treatment for anxiety disorders, it involves exposing individuals to feared thoughts, images, or other stimuli repeatedly and for prolonged periods in the absence of any actual threat until anxiety is reduced via habituation.

habituation A progressive decrease in the vigor of autonomic responses or behavior that may occur with repeated presentations of the eliciting stimulus.

posttraumatic stress disorder An anxiety disorder that may follow traumatic experiences (e.g., combat, physical and sexual assault), which is characterized by symptoms of re-experiencing the trauma (e.g., nightmares, “flashbacks”), emotional numbing and avoidance, and arousal (e.g., insomnia, hypervigilance, anger).

Trauma Management Therapy is a multicomponent behavioral treatment program for chronic combat-related posttraumatic stress disorder (PTSD). It is a comprehensive treatment designed to address all aspects of the clinical syndrome seen in veterans, via a combina-

I. DESCRIPTION OF TREATMENT

Trauma Management Therapy (TMT) is a multicomponent behavioral treatment program for chronic PTSD in veterans. It is a comprehensive treatment designed specifically to target various aspects of the clinical syndrome associated with chronic PTSD, particularly reducing emotional and physiological reactivity to traumatic cues, reducing intrusive symptoms and avoidance behavior, improving interpersonal skills and emotion modulation (e.g., anger control), and increasing the range of enjoyable social activities. The program is designed to incorporate exposure therapy, the PTSD psychosocial treatment approach with the most empirical support, with a social skills training component designed specifically for veterans with PTSD. It is a comprehensive treatment designed to address all aspects of the primary clinical syndrome seen in veterans, via a combination of patient education, exposure therapy, social skills training, and relevant homework assignments. It is important to note that this treatment is not merely a combination of exposure and traditional social skills training procedures. Rather, it includes strategies designed to remedy specific difficulties seen in veterans with chronic PTSD, and the particular sequencing and timing of the individual components are

thought to contribute to its overall effectiveness. The major components of TMT are described next.

A. Education

All patients are provided with a general overview of chronic PTSD, including common patterns of expression, issues of diagnosis, comorbidity of other anxiety and Axis I disorders, etiological pathways, and a review of current treatment strategies. This phase is important for ensuring that veterans not only develop a realistic understanding about treatment prognoses, but also an overall positive expectancy regarding the efficacy of behavioral treatment. Finally, this phase is used to educate veterans about the treatment they will be receiving and what will be expected from them regarding their participation in TMT.

B. Exposure Therapy

Individually administered intensive exposure therapy is included as the first active component of TMT, because it has been shown to effectively address the unique features of each patient's fear structure, allowing for a reduction in general anxiety, physiological reactivity, and intrusive symptoms. Patients are exposed imaginatively to feared or anxiety-producing stimuli in a prolonged fashion until there is a decrease in fear and anxiety (i.e., until habituation is obtained) within session. Repeated contact with the feared stimulus hastens the habituation process and, with sufficient pairings, the stimulus loses its ability to elicit the fear response. Typically, most veterans with PTSD escape or avoid feared stimuli, which functions to increase the intensity of the fear response. The goal of exposure therapy is to provide prolonged contact with the feared stimuli of sufficient duration that within session habituation occurs. Repeated pairing across a number of days also is important and hastens the habituation process. Fourteen sessions of exposure therapy are administered early in the sequence so that veterans may experience relatively quick relief from acute symptoms of PTSD, enabling them to then concentrate on developing emotional control and improving their social functioning. All sessions are terminated following a 50% reduction in within session reactivity to the traumatic cues, with reactivity monitored physiologically (i.e., heart rate) and/or by patient ratings of subjective distress. Based on our experience with PTSD, and data on behavioral treatment of other anxiety disorders, exposure sessions usually average about 90 min in duration.

C. Programmed Practice

The programmed practice component of TMT is implemented in the final seven individual exposure sessions and is a form of exposure that does not require therapist accompaniment (i.e., it is "homework"), but requires careful planning on the part of the therapist and patient together. Examples of suitable exercises focusing on traumatic combat fears include self-directed imaginal sessions at home, which may serve as an initial step toward *in vivo* activities, such as watching movies (e.g., *Platoon* or *Hamburger Hill*), visiting war memorials or museums, speaking with other veterans or loved ones about war experiences, and visiting airfields or helicopter pads. Experiences should also be devised that require the veteran to engage in other feared activities, the avoidance of which may interfere with quality of life. Examples of suitable activities include social events, shopping, attending movies, eating in a restaurant, etc.

D. Social and Emotional Rehabilitation (SER)

A highly structured group (3–5 people) social skills training component (SER) was developed to target PTSD features that are not improved by exposure therapy only. In other words, interpersonal difficulties, commonly associated with chronic PTSD, such as social anxiety, social withdrawal, excessive anger and hostility, explosive episodes, marital and family conflict are targeted via a number of specific interventions. SER includes instruction, modeling, behavioral rehearsal, feedback, and reinforcement. Following each SER session, veterans are given homework assignments to allow further practice and consolidation of newly acquired skills. A series of symptom-specific strategies were sequenced to build on one another in a cumulative fashion and are designed to serve multiple functions. One purpose is to teach veterans the requisite skill foundation for effective and rewarding social interactions. Patients with PTSD vary widely with respect to basic social skill, but most have room for improvement. In addition to general social skill, the program is divided into four components that target specific areas of dysfunction.

1. Social Environment Awareness

Social environment awareness involves teaching the nuances of when, where, and why to initiate and terminate interpersonal interactions. Veterans are taught the

verbal and nonverbal mechanics of successful social encounters, including identification of appropriate conversation topics, attentional and listening skills, and effective topic transitions.

2. Interpersonal Skills Enhancement

Interpersonal skills enhancement is devoted to teaching how to establish and maintain friendships, appropriate telephone skills, and assertive communication. This component is designed to help patients learn those skills that are necessary to engage in new and diverse social activities to increase their social repertoires and the likelihood that social interactions will become intrinsically rewarding.

3. Anger Management

Anger Management involves teaching veterans how to better manage anger and other intense emotions. It is designed to reduce temper outbursts and the problematic expression of anger. This component is designed to give patients a range of strategies for expressing their anger, problem solving, improving their emotional modulation, communicating assertively with others, so that verbal and physical violence do not continue to disrupt their relationships with others.

4. Veteran's Issues Management

Veteran's Issues Management teaches how to improve communication regarding combat trauma and military issues with nonveterans, to increase the understanding of significant others. In addition, veterans are also taught to identify and challenge negative and dichotomous thinking patterns, which limit their quality of life by reducing their involvement with others.

E. Treatment Implementation

TMT consists of 29 treatment sessions ideally administered over a period of about 17 weeks. Sessions initially occur three times a week through the Exposure phase, then twice a week at the start of SER, and then once a week for the final 10 weeks of the program (see Table 1).

II. THEORETICAL BASES

A. The Clinical Syndrome

In 1980 the American Psychiatric Association's *Diagnostic and Statistical Manual (DSM)* formally defined

TABLE 1
TMT Session Overview

Week	Session	Format	Treatment component
1	1	Individual	Education
1	2-3	Individual	Exposure
2	4-6	Individual	Exposure
3	7-9	Individual	Exposure + Prog. Practice
4	10-12	Individual	Exposure + Prog. Practice
5	13-15	Individual	Exposure + Prog. Practice
6	16-17	Group	SER: Social Environment Awareness
7	18-19	Group	SER: Interpersonal Skills
8	20	Group	SER: Interpersonal Skills
9	21	Group	SER: Interpersonal Skills
10	22	Group	SER: Interpersonal Skills
11	23	Group	SER: Anger Management
12	24	Group	SER: Anger Management
13	25	Group	SER: Anger Management
14	26	Group	SER: Anger Management
15	27	Group	SER: Veterans' Issues Management
16	28	Group	SER: Veterans' Issues Management
17	29	Group	SER: Veterans' Issues Management

and recognized the cluster of acute symptoms often seen in victims of traumatic events (e.g., combat, sexual and physical assault), naming this condition post-traumatic stress disorder (PTSD). It is defined by six basic criteria: (1) the historical antecedent of a traumatic event that involves both actual or threatened death or serious injury, and an intense response of fear, helplessness, or horror; (2) persistently reexperiencing the traumatic event through intrusive memories, dissociative flashbacks, recurrent distressing dreams, and/or psychological or physiological reactivity on exposure to associated cues; (3) the avoidance of stimuli associated with the event, or a numbing of general responsiveness, including efforts to avoid thoughts and feelings related to the trauma, efforts to avoid activities or situations that arouse recollections of the trauma, loss of interest in significant activities, social detachment, and/or reduced affect; (4) the existence of persistent symptoms of increased arousal such as hypervigilance, sleep disturbance, irritability or outbursts of anger, impaired concentration, and/or exaggerated startle response; (5) duration of the disturbance for at least 1 month; and (6) the pervasive effects of the disturbance causing clinically significant

distress or impairment in social, occupational, or other important areas of functioning.

Posttraumatic Stress Disorder is frequently chronic, and many combat veterans still suffer severe symptoms from wars fought 30 (Vietnam) or 50 (WWII) years ago. Epidemiological estimates of PTSD put the current prevalence at as high as 15% and lifetime prevalence as high as 31% for veterans exposed to war zone trauma. Given that over 3 million American soldiers served in the Vietnam war alone, and many more have served in other foreign conflicts, the potential number of veterans currently with PTSD is well above the half-million mark.

Complicating the syndrome is the fact that PTSD is typically accompanied by multiple co-occurring mental disorders, including substance abuse (73–84%), major depression (26–68%), psychotic symptoms (15–40%), and panic attacks (21–34%), among others. Furthermore, chronic PTSD is also associated with a diverse set of symptoms associated with social maladjustment, poor quality of life, sleep disturbance, medical illnesses, and general symptom severity. This includes social avoidance, memory disruption, guilt, anger, social phobia, suicide attempts, and other debilitating behavioral features, such as unemployment, impulsive or violent behavior, and family discord. In fact, it is notable that a majority (69%) of veterans seeking treatment for PTSD within VA specialty clinics seek disability payments for the debilitating occupational impairment they experience. It recently has been documented that the costs associated with PTSD are extremely high and make PTSD one of the costliest mental disorders to society.

Although PTSD symptoms currently are grouped into three primary clusters, symptoms of reexperiencing (nightmares, intrusive memories, “flashbacks”) and associated physiological reactivity, are what best distinguish PTSD from other affective or anxiety disorders. Supporting the prominence of autonomic symptoms are data from studies examining physiological responding in people with PTSD. Most notable is the finding of heightened reactivity. In these studies, combat veterans with PTSD have significantly larger blood pressure and heart rate responses during fear-relevant cue exposure than do combat veterans without PTSD.

B. Rationale for Exposure Therapy

Exposure therapy is a well-established behavioral treatment for a wide range of anxiety disorders (e.g., phobias, obsessive-compulsive disorder), which involves exposing individuals to feared thoughts, images, or other stimuli repeatedly and for prolonged periods of

time. The rationale for this treatment is based on two-factor theory. As applied to the condition of PTSD, first, stimuli (e.g., combat images or sounds) that were once paired with actual danger and horror in combat now elicit a similar autonomic response (e.g., increased heart rate) and fear. Second, as a result of this fear response, those with PTSD tend to avoid or escape from such stimuli as much as possible. Thus, habituation to the stimuli never occurs, and the maladaptive condition is maintained. Exposure therapy involves exposing individuals to feared stimuli (e.g., combat images or sounds) repeatedly and for prolonged periods in the absence of any actual threat until habituation allows for a progressive decrease in the vigor of autonomic responses (e.g., heart rate). Therefore, anxiety and fear are reduced via habituation. In the case of individuals with PTSD, such exposure is usually accomplished, at least initially, via imaginal procedures, and is often then complimented later by *in vivo*, or “live,” exposure experiences.

III. EMPIRICAL STUDIES

A. Treatment of PTSD

There are surprisingly few data available regarding treatment outcome for veterans or civilians with PTSD. To date only a relatively small number of randomized clinical trials of pharmacological and psychotherapeutic treatments have been published. Although a range of psychotherapeutic strategies for chronic PTSD have been suggested, cognitive-behavioral treatments, usually emphasizing various methods of exposure therapy, have been the most carefully studied and show the most promise.

1. Exposure Therapy for PTSD

Among civilians with PTSD, exposure has been found to be efficacious in a number of randomized, controlled trials. Exposure therapy has been found to be superior to stress inoculation training, progressive relaxation, supportive counseling, and wait-list control groups; and it is equally effective as cognitive therapy.

Among veteran samples, intensive exposure has proven partially efficacious for chronic PTSD, although the data are not as strong as for civilians. In an early trial, exposure therapy was compared to a wait-list control group using Vietnam veterans ($N = 24$). At post-treatment, the exposure group scored significantly lower than the control group on some clinical measures and received lower therapist ratings of startle responses,

memory disturbance, depression, anxiety, irritability, and legal problems. These improvements were maintained at 6-month follow-up. Significant differences were not found for emotional numbing, sleep disturbance, or any measure of social adjustment. In another study, veterans who received both “imaginal flooding” and “standard” treatment were compared to a group of yoked patients who received “standard” treatment only ($N = 14$). The exposure group showed superior outcome on patient ratings of sleep, nightmares, and intrusive thoughts, but no differences were found for heart rate, and only minimal differences were found for measures of trait anxiety, depression, and violent tendencies. Again, the treatment appears to have been only partially efficacious. Another study included the use of physiological recordings (e.g., heart rate) and self-report inventories to assess outcome in inpatient veterans treated with exposure or individual counseling. Participants receiving exposure showed modestly superior improvement across most psychological and behavioral rating measures, but no significant differences were found between the groups on physiological parameters. Further, regardless of treatment condition, those participants who showed decreased physiological responding were improved on psychological inventories at 3-month follow-up. This suggests that reductions in physiological responding was a critical element of efficacious therapy and might be a predictor of long-term treatment success. Finally, results from two uncontrolled studies support the partial efficacy of exposure for treating PTSD symptoms in veterans.

Data from these studies indicate that exposure therapy helps reduce the hallmark features of chronic PTSD and much of the general anxiety that accompanies it. In fact, according to the consensus statement on PTSD by the International Consensus Group on Depression and Anxiety exposure therapy is the psychotherapy of choice for the disorder. However, exposure does not have a significant effect on the “negative” symptoms of PTSD (e.g., avoidance, social withdrawal, interpersonal difficulties, occupational maladjustment, emotional numbing), nor on certain aspects of emotion management (e.g., anger control). This is because exposure is narrowly focused on anxiety and fear reduction and hence does not address other features of the disorder. Specifically, exposure does not address basic skill deficits, impaired social functioning, unemployment, or anger control problems. In essence, exposure therapy does not address the many problems often associated with any chronic mental disorder. Thus, many scientists have suggested that a behavioral treatment program,

targeting specific areas of dysfunction via different behavioral strategies is necessary to address the complex symptoms associated with this condition—hence, the development of Trauma Management Therapy.

2. Trauma Management Therapy

The efficacy of TMT was examined in an open trial with 15 male Vietnam combat veterans with PTSD. The veterans participating in this study had a mean severity rating of 6.09 on the 7-point rating scale of the Clinical Global Impressions scale, indicating that the sample was severely ill. Demographics were as follows: six were African American (40%) and nine were Caucasian (60%). The mean age of the sample was 47.9 ($SD = 2.1$; range = 44 to 52 years), mean education level was 12.7 ($SD = 1.2$), 8 (53%) were married, 6 (40%) were employed full-time, 5 (33%) had a prior history of arrests, 7 (47%) had a prior history of psychiatric hospitalization, 7 (47%) received some level of VA disability payments for PTSD prior to treatment, and 11 (73%) currently were seeking disability payments or increases in existing disability payments. Acute psychiatric diagnoses other than PTSD included major depression, panic disorder, social phobia, and obsessive-compulsive disorder. Personality disorder diagnoses included borderline, avoidant, and schizoid. Overall, 15 (100%) were diagnosed with a co-occurring acute psychiatric disorder, and 11 (73%) with a co-occurring personality disorder. The combination of the multiple psychiatric disorders and extreme severity ratings indicate this was a severely ill sample.

Eleven patients were included in the analyses because 4 of the 15 (27%) dropped out during the course of treatment. One veteran discontinued after a few sessions of exposure treatment without giving a reason. The remaining three dropped out after successfully completing the exposure phase and all reported benefiting from the treatment; two of these veterans dropped out because their employment took them to another city, and the other cited transportation problems for not being able to participate in the SER phase.

To summarize the results, significant pre- to post-treatment improvement on most of the outcome variables was noted (see Table 2), suggesting that TMT is a promising treatment for the chronic and multifaceted symptoms associated with combat-related PTSD. Over the course of 4 months significant improvements were made on most critical features of PTSD. Symptom reductions occurred across problematic features of sleep disturbance, nightmares, flashbacks, social withdrawal, heart rate reactivity; significant improvements were

TABLE 2
Pre- and Posttreatment Data for Outcome Variables (N = 11)

	Pre-	Post-	<i>t</i>	<i>p</i>
Clinician ratings				
Hamilton Anxiety	33.91 (9.38)	23.26 (4.20)	4.88	.0003***
Clinical Global Impression	6.09 (.70)	4.00 (.78)	6.10	.0001***
Clinician PTSD scale	82.46 (19.23)	65.55 (8.51)	2.77	.0099**
Patient symptom ratings				
Sleep (hours/wk)	30.55 (8.64)	36.09 (8.85)	4.45	.0006***
Nightmares (freq./wk)	9.73 (5.12)	5.55 (3.14)	4.44	.0007***
Flashbacks (freq./wk)	9.00 (5.53)	6.27 (4.65)	2.95	.0073**
Social activities (freq./wk)	.55 (.69)	2.55 (.93)	8.56	.0001***
Physiological reactivity				
Heart rate	89.73 (9.81)	77.00 (8.65)	5.34	.0002***
Self-report inventories				
Social Phobia Difference	94.67 (21.62)	85.00 (20.28)	1.97	.0423*
Beck Depression	28.91 (9.66)	28.64 (8.70)	.14	.4441
Spielberger Anger Scale	34.82 (13.64)	35.82 (10.38)	.40	.3480

* $p < .05$; ** $p < .01$; *** $p < .001$.

noted on clinician ratings of general anxiety, PTSD symptoms, and overall level of functioning.

Because TMT significantly improved patients' social functioning across a number of dimensions, the outcome generally appears to be superior to findings reported for combat veterans in treatment studies using exposure therapy only or other nonexposure treatments. Furthermore, the patients' overall ratings of their treatment indicate that they considered it a credible and positive therapeutic experience, and all but one said that they would encourage other veterans with PTSD to participate in TMT. Although significant improvement was found on many measures, the clinical syndrome was not remediated entirely, which is usually the case even for most "successful" treatments of anxiety disorders and most other severe psychiatric conditions. Nevertheless, overall the new treatment strategy appears to have resulted in broad improvement across the wide symptom spectrum of PTSD in a sample of veterans typical of those in most VA settings.

For purposes of examining component efficacy, assessments were administered after completion of exposure therapy at midtreatment (Session 15), but prior to the commencement of SER. These data indicate that veterans responded with significant improvement after completion of the exposure therapy phase, but only on certain symptoms (e.g., nightmares, flashbacks, physiological reactivity, sleep, and general anxiety). Significant improvement in the frequency of social activities occurred only after the implementation of social skills

training, suggesting that this deficiency improved only after specific intervention with the SER component. This validates the need for a broad-based intervention to address the entire PTSD syndrome. Research is pending to extend these results for TMT in randomized, controlled efficacy research.

IV. SUMMARY

Posttraumatic stress disorder (PTSD) is a severe and chronic anxiety disorder that may follow traumatic experiences (e.g., combat, physical and sexual assault). The clinical syndrome is characterized by symptoms of reexperiencing the trauma (e.g., nightmares, "flashbacks"), emotional numbing and avoidance, and arousal (e.g., insomnia, hypervigilance, anger), as well as severe impairment of social functioning. Research shows that intensive exposure therapy helps reduce the hallmark features of chronic PTSD (e.g., symptoms of intrusion, physiological reactivity) and much of the general anxiety that accompanies it and is considered to be the psychosocial treatment of choice. However, exposure therapy does not have a significant effect on the "negative" symptoms of PTSD (e.g., avoidance, social withdrawal, interpersonal difficulties), nor on certain aspects of emotion management (e.g., anger control). Although exposure may reduce maladaptive arousal and fear, it does not address basic skill deficits, impaired relationships, or anger control problems. Trauma Management Therapy

(TMT) is a multicomponent behavioral treatment program for chronic combat-related PTSD designed to address all aspects of the clinical syndrome in veterans. It utilizes a combination of patient education, exposure therapy, social skills training, and relevant homework assignments. Preliminary evidence from an open trial shows that overall TMT appears to result in broad improvement across the wide symptom spectrum of PTSD, including social functioning, in veterans treated within the VA. Research is pending to extend these results for TMT in randomized, controlled efficacy research.

See Also the Following Articles

Exposure *in Vivo* Therapy ■ Grief Therapy ■
Post-Traumatic Stress Disorder ■ Self-Control Therapy

Further Reading

- Ballenger, J. C., Davidson, J. R., Lecrubier, Y., Nutt, D. J., Foa, E. B., Kessler, R. C., McFarlane, A. C., & Shalev, A. Y. (2000). Consensus statement on posttraumatic stress disorder from the International Consensus Group on Depression and Anxiety. *Journal of Clinical Psychiatry*, *61* (suppl. 5), 60–66.
- Davidson, J. R. T. (2000). Pharmacotherapy of posttraumatic stress disorder: Treatment options, long-term follow-up, and predictors of outcome. *Journal of Clinical Psychiatry*, *61* (suppl. 5), 52–56.
- Frueh, B. C., Turner, S. M., & Beidel, D. C. (1995). Exposure therapy for combat-related PTSD: A critical review. *Clinical Psychology Review*, *15*, 799–817.
- Frueh, B. C., Turner, S. M., Beidel, D. C., Mirabella, R. F., & Jones, W. J. (1996). Trauma Management Therapy: A preliminary evaluation of a multicomponent behavioral treatment for chronic combat-related PTSD. *Behavior Research and Therapy*, *34*, 533–534.
- Foa, E. B., Keane, T. M., & Friedman, M. J. (2000). *Effective treatments for PTSD*. New York: Guilford Press
- Keane, T. M., Fairbank, J. A., Caddell, J. M., & Zimering, R. T. (1989). Implosive (flooding) therapy reduces symptoms of PTSD in Vietnam combat veterans. *Behavior Therapy*, *20*, 245–260.
- Kessler, R. C. (2000). Posttraumatic stress disorder: The burden to the individual and to society. *Journal of Clinical Psychiatry*, *61* (suppl. 5), 4–12.
- Kulka, R. A., Schlenger, W. E., Fairbank, J. A., Hough, R. L., Jordan, B. K., Marmar, C. R., & Weiss, D. S. (1990). *Trauma and the Vietnam war generation: Report of findings from the National Vietnam Veterans Readjustment Study*. New York: Brunner/Mazel.
- Turner, S. M., Beidel, D. C., Cooley, M. R., Woody, S. R., & Messer, S. C. (1994). A multicomponent behavioral treatment for social phobia: Social Effectiveness Therapy. *Behaviour Research Therapy*, *32*, 381–390.



Unconscious, The

Alan Sugarman

*San Diego Psychoanalytic Society and Institute and
University of California, San Diego*

Caroline DePottel

San Diego Psychoanalytic Society and Institute

- I. Introduction
 - II. Concept of the Unconscious
 - III. The Drives
 - IV. The Role of Psychic Energy
 - V. Characteristics of the Unconscious
 - VI. Conceptual Problems
 - VII. Three Box Model
 - VIII. Unconscious Fantasy
- Further Reading

GLOSSARY

cathexis Freud used this term to refer to changes in direction or quantity of psychic energy. Generally it means interest, attention, or emotional investment.

hermeneutic school This approach to psychoanalysis argues that the psychoanalytic process and theory should be understood as a humanities discipline, not a natural science. Thus, it disregards concepts such as causality to focus on the coherence theory of truth. Criteria such as internal consistency, coherence, comprehensiveness, and therapeutic efficacy are more important than empirical proof.

instinctual drives Freud's two drives, sexual and aggressive, were considered to be the major factors motivating the mind. They continue to be considered important but not the only motivating factors by modern psychoanalysts.

I. INTRODUCTION

The notion that most mental processes occur outside of consciousness and that these unconscious contents

and functions exert tremendous influence on virtually all psychologically mediated behavior is perhaps the most central and long-standing of Sigmund Freud's many contributions. Although his definition and understanding of the role of unconscious phenomena have been revised and expanded, every practicing therapist who uses a psychoanalytic or psychodynamic orientation is always considering the role of unconscious psychodynamics in the symptoms and personality traits their patients want to change. Technical strategies for utilizing and working with these unconscious phenomena have evolved, but the basic idea that these phenomena are important and must receive therapeutic scrutiny has stood the test of time.

II. CONCEPT OF THE UNCONSCIOUS

The concept of the Unconscious was described in various sections of *The Interpretation of Dreams*, most notably Chapter 7, by Freud in 1900 as he delineated his topographic model wherein the regions of the mind were defined by their closeness to consciousness. But it was not until 1915 in his paper, "The Unconscious," that Freud elaborated on what he called the system Unconscious in detail. He began that paper by reviewing the justification for the inference of such a system. Thus, he pointed out what psychologists of most theoretical persuasions have come to acknowledge—that is, it is simply untenable to assume that everything that

occurs in mental life can occur in the conscious mind. Even recent cognitive and information processing models acknowledge that the conscious mind can only be aware of a fraction of the contents and processes occurring in mental life. One has only to reflect on daily phenomena such as arriving at one's destination while driving without remembering any details of stopping for traffic lights, making turns, and so on, to be struck by the evidence supporting the occurrence of unconscious mental processes.

Freud also argued that it was conceptually necessary to postulate the existence of an unconscious mind to explain the many gaps in the contents of consciousness (e.g., slips of the tongue, dreams). Such gaps were simply unintelligible using only the information provided by the conscious mind. In fact, many of the books and papers of Freud's topographic stage of thinking (1897–1923) were devoted to demonstrating the unconscious logic of these consciously illogical phenomena. Dreams, slips of the tongue, jokes, and neurotic symptoms were all studied and shown to be comprehensible once one grasped the role of the system Unconscious in their genesis and subsequent maintenance. In fact, Freud was able to argue for the legitimacy of assuming that others also had unconscious minds as he was able to make sense of their previously unintelligible behavior by illuminating its unconscious meanings.

The basic thesis of the topographic model was that the mind was organized into three systems or regions, the systems Unconscious, Preconscious, and Conscious, organized to prevent the contents of the system Unconscious from breaking into and overwhelming the system Conscious so that the individual could continue to attempt to adapt to the constraints of reality while allowing enough discharge of the contents of the Unconscious to avoid excessive frustration, unpleasure, or symptomatology. In essence, the mind's major function was one of maintaining some sort of homeostatic equilibrium between the contents of the Unconscious and the need to behave in the external world in a manner that enhanced the individual's self-preservation.

III. THE DRIVES

What made this task difficult was the nature of the contents of the system Unconscious. Most of its contents were understood by Freud to be instinctual drives—generally libidinal ones. Freud had been driven by clinical necessity to postulate the presence of unconscious sexual drives in 1897 when he realized that the sexual abuse reported by his patients generally

involved fantasies and not the actual reality that he had assumed during his previous affect-trauma stage of thinking. These sexual fantasies were theorized to derive from libidinal instincts in the system Unconscious, instincts that had a powerful, preemptory quality, always pushing the individual to discharge his or her accumulated sexual tension in the real world.

But to blindly run amok, seeking gratification of the multiplicity of sexual urges available to humanity, would place the individual at great risk for not surviving. The same could be said for the aggressive instinctual urges that Freud described later in his life. Thus, the mind needed to function so as to keep these libidinal and aggressive contents repressed, that is, in the system Unconscious. Thus, Freud hypothesized the existence of a censor at the boundary between the systems Unconscious and Preconscious. Freud always believed that some form of special energy, what he called psychic energy, provided the means by which the system worked. Each system had its own psychic energy to serve its functions. Explaining how censorship worked in his 1915 paper, he said, "there is a withdrawal of the preconscious cathexis, retention of the unconscious cathexis, or replacement of the preconscious cathexis by an unconscious one." Another form of energetic cathexis, what Freud called an anticathexis, was also used to buttress repression. In this way the mind could keep the potentially most self-destructive or unpleasurable instinctual impulses from moving into the system Preconscious, from where they could make their way into the system Conscious. Some discharge of instincts had to be allowed to prevent excessive internal tension from occurring. Discharge generally occurred through the system Preconscious disguising the contents of the Unconscious and depleting them of some intensity before allowing their derivatives to proceed into the system Conscious.

IV. THE ROLE OF PSYCHIC ENERGY

Freud also described the system Unconscious as being organized and functioning in very different ways than the other two systems. In large part these differences were due to the primary process that characterized the system Unconscious. Primary process referred to the earliest, developmentally most immature form of mental activity according to Freud. In many ways it corresponds to what cognitive psychologists call preoperational thinking. Such thinking seeks immediate and complete discharge of drive impulses by attaching psychic energy (*cathexis*) to the visual memory traces of

the object that gratified the drive in the past. Primary process mentation was characterized by the occurrence of both displacement and condensation. Displacement refers to immature thinking whereby one idea within a drive-connected associative network comes to symbolize another idea. *Pars pro toto* thinking is one example of displacement. For example, the color blond may come to symbolize the person toward whom the drive-wish was directed who had blond hair. Likewise, situations wherein the whole represents a part is another example of displacement. Condensation was the other primary process mechanism described by Freud. In condensation one mental content (idea, memory trace, etc.) can represent several others. For example, the occurrence of a church in someone's dreams might represent at the same time both wishes toward a particular figure who had been religious as well as memories of one's religious training. To account for the fluidity by which primary process thinking operated, Freud introduced the idea that the system Unconscious was characterized by mobile psychic energy that easily shifted from one mental content to another toward the goal of wish fulfillment.

V. CHARACTERISTICS OF THE UNCONSCIOUS

The system Unconscious was also said to operate according to the pleasure principle. Freud described the instinctual wishes that made up the contents of the system Unconscious as peremptory. They were so compelling that he believed they sought pleasurable discharge and the parallel reduction of unpleasurable tension at all costs. Drive stimulation was thought to arouse unpleasurable tension in what Freud called the psychic apparatus, and to push toward consciousness and motility so that satisfaction of the drive-wish could be achieved. As the wish proceeded through the other systems of the mind, its pressure for direct and immediate discharge often aroused conflict, leading the censorship between the systems Unconscious and Preconscious to transform it. If disguised sufficiently, such drive derivatives would pass into the system Conscious and provide instinctual gratification. Otherwise, they would be repressed and maintained in the system Unconscious by the censor. Thus, the contents of the system Unconscious included both the infantile sexual and aggressive drive wishes as well as their repressed derivatives that had originally been allowed into consciousness, but had subsequently aroused enough conflict that they were re-repressed.

As the individual developed, virtually all primitive sexual and aggressive wishes were said to be repressed and capable of conscious expression only after being disguised thoroughly by the system Preconscious. Repression of a drive derivative could occur at any time that it aroused unpleasure, generally in the form of anxiety, in an individual. In this way the system Unconscious was thought by Freud to be constantly changing as new repressions occurred. Strong repressions of drive wishes early on were said to serve as fixation points encouraging later repressions to regress to the fixation point.

The system Unconscious was also described by Freud as having other characteristics that differentiated it from the systems Preconscious and Conscious. First it was timeless. Mental content and processes in this system were not affected by the passage of time or the concept of time. This characteristic was necessary to explain the clinical finding that childhood instinctual derivatives continued to play such vivid roles in the psyches of adult patients. Implicit in the concept of the pleasure principle was the notion that reality was disregarded in the Unconscious. This contributed to another special characteristic—the equating of psychic reality with external reality. That is, in the system Unconscious, memories of actual occurrences were treated as no different than imagined experiences. Thus, no reality–fantasy boundary existed. Contradiction was also said not to exist in the system Unconscious. Mutually incompatible ideas could be maintained simultaneously and without conflict because of this. Negation also did not exist in the system Unconscious. Finally words were treated as things in the system Unconscious so that the symbol of a concrete thing was treated as though it were the thing it symbolized.

It is impossible to overstate the importance of the system Unconscious during Freud's topographic era of model building. Treatment was guided by the dictum that the analyst needed to make the Unconscious conscious. Helping the patient to become aware of the unconscious drive wishes that were being repressed was believed to bring about cure, in part, by releasing the psychic energy that had been dammed up, and by alleviating the unpleasant sensation of drive frustration as well by insight. Dreams were described as the royal road to the Unconscious and psychoanalysts were taught to devote particular time and energy to unraveling the disguised unconscious wishes being expressed in the dream. The primary process mechanisms described earlier were of particular importance as knowledge of them became necessary in deciphering the symbolism of the dream.

VI. CONCEPTUAL PROBLEMS

Despite the many technical and theoretical contributions of this era, clinical findings and theoretical inconsistencies led Freud ultimately to replace the topographic model with the structural one and to give up the concept of the system Unconscious. As he gained greater appreciation for the complexity of defensive functioning, particularly the fact that it, too, operated unconsciously, he realized that organizing the mind in terms of its accessibility to consciousness was no longer clinically useful. In essence, he realized that his patients' symptoms and character traits were caused by conflicts between unconscious wishes and unconscious defenses. That is, the conflicting elements were both unconscious. At this point, consciousness or the lack of it ceased to serve a differentiating function. Furthermore, he became increasingly aware of the need to deal clinically with the phenomenon of unconscious guilt. Yet there was no easy way to explain this concept in terms of topography. He needed the construct of a superego, which he described when he replaced the topographic theory with his structural one in *The Ego and the Id* in 1923. From that point, to speak of the Unconscious as a noun became theoretically anachronistic. Today it should be used only as an adjective, describing mental contents or processes that are not conscious. Some analysts fail to grasp this point, however, and still talk of an Unconscious. Unfortunately adhering to an outdated concept often leads to outdated formulations about the process of psychoanalysis or psychotherapy and how it cures.

Nonetheless, unconsciousness remains an important concept. The contents of the system Unconscious—instinctual wishes—are now thought to reside in the id, a mental structure that retains most of the structural characteristics of the system Unconscious, in particular the pleasure principle and the mechanisms of the primary process. But psychoanalytic treatment no longer is geared toward making these contents conscious as a curative approach. The discovery of unconscious defensive functioning as well as unconscious superego prohibitions has led to a therapeutic strategy whereby psychoanalysts make their patients aware of the occurrence of mental conflict as it occurs in their thoughts during treatment sessions. The patient's attention is drawn to the evidence of such conflict and whichever aspect of it is most easily accessible to the patient at any particular time. This work leads to the exploration of unconscious defenses and their motives at one time, the analysis of unconscious superego injunctions or ideals at another time, and the elaboration of unconscious wishes at still another. But the point of the strat-

egy is to expand the ego's awareness of such conflict, its elements, and the motives that cause it so that conscious ego mastery can occur. Drive satisfaction or tension reduction are no longer relevant to analytic cure, although the focus on unconscious features of mental functioning continue to remain important.

VII. THREE BOX MODEL

Joseph Sandler has also introduced what he calls the Three Box Model in which he tries to retain a place for the system Unconscious. In essence, he divides it into a Past Unconscious and a Present Unconscious in an attempt to argue the importance of interpreting the Present Unconscious content over ones from the Past Unconscious. Although most current-day analysts would support this technical dictum to interpret present before past, his theoretical modification has failed to receive widespread support. Other theoretical models, particularly the contemporary structural theories of Paul Gray and Fred Busch, offer similar technical emphases while not falling into the difficulties that describing the Unconscious as a system entail.

VIII. UNCONSCIOUS FANTASY

Another clinical arena in which the phenomenon of unconscious functioning remains salient today is the concept of unconscious fantasy. Freud first introduced the concept in *Formulations on the Two Principles of Mental Functioning* in 1911. He talked of an aspect of thinking that was split off and kept free of reality constraints. Fantasizing or daydreaming continued to operate according to the pleasure principle. Symptoms, dreams, moods, and character traits were all traced to derivatives of unconscious fantasies. Anna Freud, using the structural model, applied the concept of unconscious fantasy to explain defenses such as identification with the aggressor and denial in fantasy. Repressed masturbatory fantasies were shown to disrupt certain ego functions and to distort important object relations.

But it is Jacob Arlow who has brought this concept to current-day prominence while demonstrating its clinical utility. He pointed out that decisive conflicts during an individual's life become organized into a number of stable unconscious fantasies that provide constant stimulation to an individual's mind. In this sense they form a schema through which subjective experiences are perceived, interpreted, and reacted to. Such fantasies are organized hierarchically and group around

drive wishes, allowing for different versions of the fantasy. Arlow described such fantasies as developing early in life, but only with the resolution of the Oedipus complex. These fantasies provide what hermeneutically oriented psychoanalysts have called narratives, giving a plot to the individual's life that organizes his or her multiplicity of experiences into a few consistent and cohesive themes. Needless to say, they are important in maintaining ego identity.

Unconscious fantasies are usually the basis for neurotic symptoms and character traits. Generally the development of these clinical phenomena can be traced to an event that is reminiscent of a persistent unconscious fantasy built around a corresponding traumatic event. But equally as often unconscious fantasies lead to selective perception and responding. It is important to realize that unconscious fantasies involve the contribution of the ego and superego, and not just instinctual wishes from the id. Arlow has shown how fetishism can involve an unconscious fantasy that women have penises, which can fend off castration anxiety. Such a fantasy serves a defensive function.

Arlow has gone on to explain the technical importance of the concept of unconscious fantasy. He explained that the analyst needs to infer the presence of an unconscious fantasy from the patient's associations and to show the patient how its derivatives affect the patient's actions and mental life. An example described by Arlow was a patient who could only perform sexually if he fantasized spanking a woman. Analysis of this fantasy led the patient to realize his need to be in charge and not to see the female genital that made him anxious. Such realization allowed him to be more assertive with his wife and subsequently to have a successful sexual experience with her. Arlow has also said that the analyst's ability to empathize with and to understand the patient requires the ability to allow an unconscious fantasy to be evoked in the analyst that is similar to that of the patient's. Thus, the concept of un-

conscious fantasy remains another example of the continued importance of the concept of unconscious mental functioning in clinical practice.

It is impossible and technically unwise to ignore unconscious mental functioning when doing psychodynamic psychotherapy or psychoanalysis. Unconscious resistances are both inevitable and problematic if they are not analyzed. They lie at the core of patients described today as treatment resistant. Likewise, becoming aware of unconscious intrapsychic conflict is crucial in expanding the patient's consciousness and mastery of his or her own mind. Thus, unconscious phenomena remain as important as ever in psychodynamically oriented treatment as long as therapists are careful not to think of an Unconscious with the technical implications carried by that outdated concept.

See Also the Following Articles

Intrapsychic Conflict ■ Oedipus Complex ■ Structural Theory ■ Topographic Theory ■ Transference Neurosis

Further Reading

- Arlow, J. A. (1995). Unconscious fantasy. In B. E. Moore & B. D. Fine (Eds.), *Psychoanalysis: The major concepts* (pp. 155–162). New Haven, CT: Yale University Press.
- Arlow, J. A., & Brenner, C. (1964). *Psychoanalytic concepts and the structural theory*. New York: International Universities Press.
- Brakel, L. W., Kleinsarge, A., Snodgrass, M., & Shervin, H. (2000). The primary process and the unconscious experimental evidence supporting two psychoanalytic presuppositions. *International Journal of Psycho-Analysis*, 81, 553–569.
- Moore, B. E., & Fine, B. D. (1990). *Psychoanalytic terms and concepts*. New Haven, CT: Yale University Press.
- Sandler, J., Holder, A., Dare, C., & Dreher, A. V. (1997). *Freud's models of the mind*. Madison, CT: International Universities Press.



Vicarious Conditioning

E. Thomas Dowd

Kent State University

- I. Description of Treatment
 - II. Theoretical Bases
 - III. Empirical Studies
 - IV. Summary
- Further Reading

GLOSSARY

- classical conditioning** Conditioning that is based on the association of one stimulus with another.
- continuous reinforcement schedule** A schedule in which reinforcements are given after every response.
- coping model** A model who initially performs the target behavior imperfectly or hesitantly but becomes better with repetition.
- intermittent reinforcement schedule** A schedule in which reinforcements are given fewer than once every response, according to a predetermined order. The schedules are fixed interval, variable interval, fixed ratio, and variable ratio.
- mastery model** A model who performs a target behavior perfectly and without hesitancy from the beginning.
- model** Someone who performs a target behavior and is reinforced or punished for it under observation.
- operant conditioning** Conditioning that is based on the reinforcing or punishing consequence of a behavior.
- target behavior** The behavior to be reinforced (increased in probability) or punished (decreased in probability).
- vicarious conditioning** Conditioning that occurs by an observer by watching a model perform the target behavior and being reinforced or punished for performing it. Also known as vicarious learning or vicarious reinforcement.

I. DESCRIPTION OF TREATMENT

In vicarious operant conditioning, the observer is exposed to a model who is reinforced or punished for performing a certain behavior. It is important that the model actually be observed being reinforced or punished for performing the behavior, not simply observed performing it, or vicarious conditioning will not occur. Usually it is important that the observer be repeatedly exposed to the model because conditioning may not occur after a single exposure. In addition, conditioning may not occur because the observer did not see the important features of the modeled behavior or may have no memory of it. It is helpful if the modeled behavior is symbolically represented by images or words or is mentally rehearsed. The observer, of course, must have the means to carry out the target modeled behavior.

In vicarious classical conditioning, the observer is exposed to a model who behaves fearfully when confronted with a feared object (such as a snake) or who has negative consequences occur when exposed to an object (such as being scared by a large animal or in association with that animal). As a result of making these observations, the observer may likewise learn to fear these objects or situations.

Whereas vicarious operant conditioning may require several trials and multiple models to become firmly established, vicarious classical conditioning may occur in a very few or even single trials or exposures. It is likely

that the majority of human anxiety responses are learned in this manner because most people have not had personal experiences with many of the events or people they fear.

II. THEORETICAL BASES

Vicarious conditioning is theoretically based on the modeling paradigm as developed by Albert Bandura. In modeling, individuals may show increases or decreases in various target behaviors by observing a model being reinforced (to increase target behavior) or punished (to decrease target behavior). It is not necessary that the observing individual be directly reinforced or punished for behavior change to occur. This process has been called vicarious learning, vicarious conditioning, or in some instances, vicarious reinforcement.

Vicarious conditioning is the analogous process to *in vivo* or directly experienced conditioning. According to the operant conditioning paradigm, the observing individual watches a model being reinforced for performing a certain behavior and the probability of the observer subsequently exhibiting that behavior increases as well. Observation of rewarding consequences occurring to a model for exhibiting a certain behavior, such as aggressiveness, may increase the probability of the observer performing that behavior in the future. By contrast, observation of a model being punished for exhibiting aggressive behavior may decrease the likelihood of, or inhibit the observer from performing, a similar aggressive act.

In vicarious classical conditioning, an observer watches a model becoming afraid of certain activities or animals as a result of seeing these stimuli paired with fear-producing situations. For example, the observer may see a model being bitten by a large furry dog, and subsequently fears large furry dogs without having been personally bitten. Indeed, the conditioning may generalize to a fear of large furry objects in general or to animals other than dogs.

Vicarious conditioning has been thought to be a major contributor to fear and anxiety disorders in people because people are commonly afraid of, or anxious about, situations or events that they have never experienced directly. It is also thought to account for a higher level of aggression in individuals who have not themselves been exposed to aggressive responses. Vicarious conditioning can develop through familial influences, subcultural influences, or symbolic modeling by the mass media because, for example, the latter provide ample models for violence and aggression.

Bandura has described several mechanisms or functions by which vicarious conditioning may occur. There is the informative function, in which the model's actions and response consequences provide information to observers about the probable consequences to them if they engage in similar actions. There is the motivational function, in which seeing others reinforced (or punished) can act as a motivator for the observer to perform similar actions. There is the valuation function, in which observers may come to value certain things if they see a model being reinforced for similar things. There is the influenceability function, in which observers may be influenced more by models' actions that respond positively to reinforcing consequences than by those who resist such consequences. In other words, observers tend to be more influenced by modeled responsiveness than by modeled resistance. Finally, there is the emotional learning function, in which an observer's emotional reactions are aroused by the model's emotional reactions while undergoing the rewarding or punishing consequences. This last function is essentially a form of classical conditioning in which an observer's fear responses may be enhanced or reduced by the model's fear responses or lack of them.

Observing the model gradually and perhaps hesitantly approach the feared situation or be reinforced for initially imperfect responses may be especially useful. Bandura found that a coping model, who performed the behavior gradually, imperfectly, or hesitantly was a more effective model than a mastery model, who performed the behavior perfectly, quickly, or without hesitation. People may respond better to a coping model because of perceived similarity to themselves. A coping model appears to be more like them whereas a mastery model may make them feel too inadequate and therefore not be imitated. Of course, it is important that the observers see the model as similar to themselves so that they may reasonably assume that the rewarding or punishing consequences would likely happen to them as well. For example, rewarded aggression occurring to a soldier model may not result in an increase in aggression in a civilian observer. The model and observer are not similar enough. Likewise, similarity of model and observer in such attributes as gender, age, and race may enhance the modeled vicarious conditioning effect whereas dissimilarities may reduce it. The use of multiple models may also enhance vicarious conditioning.

It should be noted that the standard laws of conditioning also apply to vicarious conditioning. For example it has been shown that conditioning that has been

established on an intermittent reinforcement schedule is acquired more quickly and established more firmly than that which has been established on a continuous reinforcement schedule. Whereas vicarious extinction may require many repeated trials, vicarious conditioning can often be accomplished in a few trials. In the case of highly intense or emotionally involving experiences, one-trial conditioning may occur.

III. EMPIRICAL STUDIES

There has been considerable research on the effectiveness of vicarious conditioning. Not only has it been found to be quite effective, it can be superior to direct reinforcement. This phenomenon is especially true if the tasks to be reinforced are more conceptual than manual. Vicarious conditioning is certainly more pervasive than direct conditioning, and likely accounts for the majority of human learning. In fact, a large number of behaviors exhibited in everyday life are probably conditioned vicariously by observing models being reinforced for performing these actions. The amount of vicarious classical conditioning has been found to be related positively to arousal level generated by psychological stress. It has been shown that the need for approval can increase the conditioning effect of vicarious reinforcement. Vicarious and instructional conditioning have been found to be major sources of childhood fears, more so than with adolescents, although they have often been combined with direct conditioning. Childhood fears have in fact been reduced or eliminated by this procedure. Vicarious conditioning has been found to be effective in eliminating maladaptive response patterns and increasing and maintaining new adaptive behaviors in children with mental retardation. It has been successfully implemented to train these children in more prosocial behaviors. It was found that children who were shown films in which a model showed either a fear response or a positive emotional response showed a lower rate of responding to the fear stimulus and a higher rate of responding to the positive stimulus. These effects were easily overridden by instructional and reinforcement conditions, however, and proved to be temporary. Only minimal cues from a model may be required for vicarious conditioning to occur as was demonstrated by one study that found that information about the model's heart rate was sufficient for it to occur. Thus, vicarious conditioning may

account for a large part of human learning and be relatively easy to implement.

IV. SUMMARY

Vicarious conditioning is theoretically based on Albert Bandura's conditioning through modeling paradigm. It is analogous to direct trial conditioning, the difference being that it occurs when an observer learns by seeing a model performing a target behavior that is reinforced or punished. It is important that the observer actually see the model being reinforced for performing the behavior, not simply observed performing the behavior. Social behaviors, such as aggression and violence, are likely learned by this process. Vicarious conditioning can also occur through the classical conditioning paradigm whereby an observer sees a model learn to be afraid by being exposed to a noxious stimulus paired with an activity or event. Most human fears have likely been acquired by the latter process. Vicarious conditioning has been shown through research to be at least as effective as direct conditioning and possibly more so. It is a highly effective method for learning under a wide variety of situations and can be flexibly adapted to many conditions. Vicarious conditioning may be especially useful in learning conceptual material as opposed to manual skills. Mastery models may be less useful than coping models. Especially with vicarious classically conditioned fear, relatively few trials may be needed for conditioning to occur.

See Also the Following Articles

Classical Conditioning ■ Operant Conditioning
 ■ Response Cost ■ Self-Control Desensitization
 ■ Vicarious Extinction

Further Reading

- Bandura, A. (1977). *Social learning theory*. Englewood Cliffs, NJ: Prentice Hall.
- Minetka, S., & Tomarken, A. J. (1989). The role of cognitive biases in the origin and maintenance of fear and anxiety disorders. In T. Archer & L. G. Nilsson (Eds.), *Aversion, avoidance, and anxiety: Perspectives on aversively motivated behavior*. Hillsdale, NJ: Erlbaum.
- Ollendick, T. H., & King, N. J. (1991). Origins of childhood fears: An evaluation of Rachman's theory of fear acquisition. *Behaviour Research & Therapy*, 29, 117-123.

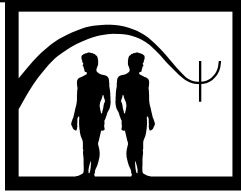

Vicarious Extinction

E. Thomas Dowd

Kent State University

- I. Description of Treatment
- II. Theoretical Bases
- III. Empirical Studies
- IV. Summary
- Further Reading

vicarious learning Learning that occurs by an observer by watching a model perform the target behavior and being reinforced or punished for performing that behavior.

I. DESCRIPTION OF TREATMENT

In vicarious operant extinction, the observer is first exposed to a model who is reinforced or punished for performing a certain behavior. It is important that the model actually be observed being reinforced or punished for performing the behavior, not simply observed performing it, or vicarious learning will likely not occur. Then, the reinforcer or punisher is removed so that the observer simply sees the model performing the behavior. As a result, the observer is less likely to exhibit the behavior (if previously reinforced) or to suppress it (if previously punished).

In vicarious classical extinction, such as is commonly used to extinguish conditioned fearful avoidance behavior, the observer is first exposed to a model who behaves fearfully when confronted with an object, such as a snake, or who has negative consequences occur when exposed to an object, such as being knocked down by a large dog. As a result of seeing the model, the observer learns to fear the objects as well. Then the model is observed approaching the object (e.g., the snake) without fear or approaching the object (e.g., the dog) without adverse consequences. As a result, the observer is likely to feel less fear and to engage in less avoidance behavior in the future.

GLOSSARY

- classical conditioning* Learning that is based on the association of one stimulus with another.
- copying model* A model who initially performs the target behavior imperfectly or hesitantly but becomes better with repetition.
- extinction* A change in behavior that occurs when it is no longer reinforced or punished.
- intermittent reinforcement schedule* A schedule in which reinforcements are delivered fewer than once for every response, according to a predetermined order. The schedules are fixed interval, variable interval, fixed ratio, and variable ratio.
- mastery model* An expert model who performs the target behavior perfectly and without hesitancy from the beginning.
- model* Someone who performs a target behavior and is reinforced or punished for it.
- operant conditioning* Learning that is based on the reinforcing or punishing consequence of a behavior.
- thin reinforcement schedule* A schedule in which few reinforcements are delivered for each response, for example, one reinforcement for every 50 responses.
- vicarious extinction* Extinction that occurs by watching a model perform a behavior that is no longer reinforced or punished.

It is important that this extinction process be repeated a number of times, sometimes a large number of times, so that the previous learning will in fact extinguish. Overlearned or traumatic learning experiences may require many extinction trials. It may also be helpful for the model to exhibit gradual approach behavior to a feared object rather than approaching it too quickly. Finally, it may be helpful to use coping models for individuals who are fearful and avoidant themselves whereas mastery models may be more useful if precise skill development is desired in the relative absence of fear.

II. THEORETICAL BASES

Vicarious extinction is theoretically based on the modeling paradigm as developed by Albert Bandura. In modeling, individuals may show increases or decreases in various target behaviors by observing a model being reinforced (to increase target behavior) or punished (to decrease target behavior). It is not necessary that the individual be directly reinforced for behavior change to occur. This process has also been known as vicarious learning.

Vicarious extinction is the analogous process to *in vivo* or directly experienced extinction. According to the operant conditioning paradigm, the observing individual, after having vicariously learned a particular behavior by watching a model being reinforced for performing that behavior, now watches the model no longer being reinforced for exhibiting that behavior. Thus, the observer's target behavior likewise diminishes over time for lack of reinforcement.

In vicarious classical conditioning, an individual may have vicariously learned from a model to fear and therefore avoid certain activities or animals (such as avoiding members of the opposite sex or avoiding dogs) by watching a model learning to fear them (perhaps by being consistently rejected or by being knocked over by the dog). In vicarious extinction, the observer no longer sees the model performing fear-producing behaviors with adverse consequences (being rejected or knocked over); in fact the observer may see the model approach the dog without problems occurring. Thus, the fear that has become associated with either stimulus is gradually extinguished as the observer learns that the activities are safe.

Observing the model gradually and perhaps hesitantly approach the feared situation without problems occurring may be especially useful. Bandura found that a coping model, who performed the behavior gradually

or imperfectly, was a more effective model than a mastery model, who performed the behavior perfectly or quickly. People may respond better to a coping model because of perceived similarity. It looks more like them whereas a mastery model may make them appear too inadequate and therefore not to be imitated.

It should be noted that the standard laws of learning also apply to vicarious learning. Therefore, the standard laws of extinction also apply to vicarious extinction. For example, it has been shown that learning that has been established on an intermittent reinforcement schedule is much more resistant to extinction than behavior acquired on a continuous schedule of reinforcement. Thus, vicarious learning that has been established on an intermittent reinforcement schedule would likewise be more resistant to vicarious extinction than that established on a continuous schedule. Likewise, a very thin vicarious reinforcement schedule would produce greater resistance to vicarious extinction than one involving a large number of reinforcers per response.

It is difficult to explain how fearful avoidance responses can be extinguished without ever being initially elicited. Bandura explains this by a dual-process theory of avoidance behavior. A conditioned aversive stimulus evokes emotional arousal that controls to some extent instrumental responding, and therefore if the arousal capacity of a fear-producing stimulus is extinguished, both the motivation and the avoidance stimulus are eliminated.

III. EMPIRICAL STUDIES

In the 1960s, there was substantial research conducted on vicarious extinction of fear and avoidance behavior, much of it conducted in Albert Bandura's laboratory. Vicarious classical extinction was found to be quite useful in extinguishing fear of certain animals in young children. Bandura and his colleagues also found that multiple models were more effective than single models in eliminating animal phobias in children, at least from posttest to follow-up. They also found that live modeling with participation (seeing an actual model perform the behavior with guided practice by the observer in performing the same behavior) was more effective than symbolic modeling (watching a film of the model performing the behavior) or systematic desensitization. Modeling appeared to account for about 60% of the behavior change and 80% of the attitude change. Guided participation accounted for the rest of the variance. Relaxation did not appear to

increase the effectiveness of symbolic modeling alone in reducing fear arousal.

Other research, including some doctoral dissertations dating from the 1970s, has been conducted on vicarious classical extinction designed to reduce fear arousal and avoidance behavior and has found it to be effective in reducing sex anxiety in women, reducing frigidity, reducing fear of dogs through films (symbolic modeling), and reducing fear of snakes. Multiple models were again found to be more effective than single models. One study comparing systematic desensitization and vicarious symbolic extinction found greater improvement for systematic desensitization. Another study comparing symbolic desensitization, symbolic modeling, and live modeling combined with guided participation (contact desensitization) found the latter to be the most effective.

IV. SUMMARY

Vicarious extinction is theoretically based on Albert Bandura's learning through modeling paradigm. It is an analogous process to *in vivo* extinction, the difference being that the former occurs when an observer sees a model performing a behavior that is no longer

reinforced, rather than not being reinforced (extinguished) directly. It was shown through research conducted in the 1960s and early 1970s to be an effective technique for extinguishing fear and avoidance behavior. It is more flexible and adaptable than *in vivo* extinction because the observer does not have to experience the extinction directly. However, live modeling combined with guided participation, which is essentially a combination of vicarious and *in vivo* extinction, was found to be more effective than other forms of vicarious extinction alone.

See Also the Following Articles

Classical Conditioning ■ Operant Conditioning ■
Self-Control Desensitization ■ Vicarious Conditioning

Further Reading

- Bandura, A. (1969). *Principles of behavior modification*. New York: Holt, Rinehart & Winston.
- Bandura, A., & Menlove, F. L. (1968). Factors determining vicarious extinction of avoidance behavior through symbolic modeling. *Journal of Personality and Social Psychology*, 8, 99–108.
- Spigler, M. D., & Guevremont, D. C. (1993). *Contemporary behavior therapy*. Pacific Grove, CA: Brooks/Cole.

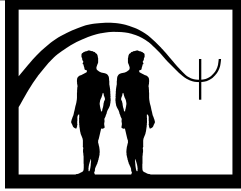

Virtual Reality Therapy

Max M. North and Sarah M. North

Kennesaw State University

- I. Description of Virtual Reality Therapy
 - II. Theoretical Base of Virtual Reality Therapy
 - III. Empirical Studies
- Further Reading

GLOSSARY

virtual reality A technology that enables users to enter computer-generated worlds and interface with them through sight, sound, and touch.

Virtual reality therapy (VRT) is a new modality of therapy that enables clients to confront what troubles them and deal with irrational behavior using virtual reality technology. VRT is changing deeply held concepts about how human beings can overcome psychological disorders.

I. DESCRIPTION OF VIRTUAL REALITY THERAPY

VRT brings clients face-to-face with their deepest fears in a nonthreatening environment. That is the key. Entering a computer-generated world, clients know the situation is harmless, yet the re-creation of fearful scenes is lifelike, enabling them to deal with their fears

in a realistic setting, confronting them through sight, sound, and touch.

VRT is similar to behavior therapy in its focus on exposing clients to fear-provoking stimuli. It differs from traditional behavior therapy modalities in that VRT computer graphics and various display and input technologies create real-life situations in the laboratory. These produce a sense of presence, so that the client feels immersed in the frightening scene. VRT can overcome some of the difficulties inherent in traditional treatment of psychological disorders. In traditional therapy, the therapist often has to imagine what is going on in the mind of the client. In VRT, the therapist can see how a phobic client reacts to fearful situations and is able to provide on-the-spot guidance. VRT generates stimuli of much greater magnitude than standard *in vivo* techniques can produce. It offers the added advantage of greater variety, efficiency, and economy in creating situations that might be either difficult or impossible with traditional techniques.

The centerpiece of VRT technology is a stereoscopic head-mounted video display with a head-tracking unit, along with a device that produces auditory and tactile stimuli (Figure 1). The effect can be startling, especially when the client is exposed to lifelike situations that have always produced fear. A set of VRT scenes is created before the therapy sessions begin. In the first laboratory session, which lasts approximately 20 minutes, the VRT client gets familiar with the virtual reality equipment. During this session, the client is asked to eliminate any virtual reality scenes that do not necessarily cause



FIGURE 1 A typical virtual reality system with head-mounted display and head-tracking unit for use in VRT treatment.

anxiety. The client is asked to rank the remaining scenes from least to the most threatening. For the next eight weekly sessions, which last 15 to 20 minutes each, VRT is conducted in a standard format, tailored to individual needs.

The VRT session begins with the least fearful scene. Discomfort is measured every few minutes with the Subjective Units of Disturbance (SUD) scale. Clients rate their discomfort on a scale of 0 to 10. They progress systematically through each level of discomfort, and then are exposed to the next most threatening scene. Clients control their progress through the hierarchy of scenes. However, if the SUD score is 2 or less, the therapist may urge them to move up to the next level or next scene. Each new weekly session begins where the previous session ended. In addition to client-controlled subjective measurements, such as SUD, objective measurements of discomfort are also used. For instance, a heart-monitoring device, such as EEG/EMG, can be employed to monitor physical reactions.

II. THEORETICAL BASE OF VIRTUAL REALITY THERAPY

The principal aim of VRT is to help reduce or eliminate anxiety and fear. Phobias are nearly always linked to people's reactions to specific situations. VRT focuses on re-creating those situations in a controlled environment. When people encounter these disturbing situations under nonthreatening conditions they find ways to deal with them. In VRT, they learn new responses to old disturbing situations, thus gaining more control over psychological disturbances and their symptoms.

III. EMPIRICAL STUDIES

In testing military navigation software in a virtual reality setting in 1992, Dr. Max North and Dr. Sarah North discovered that it made some of the participants very fearful. They concluded that this technology could not only trigger phobias but could be used to combat these and other psychological disorders. Since then, they have successfully conducted numerous studies of VRT applied to specific phobias, such as fear of flying, heights, being inside a dark barn, crossing a river in an enclosed bridge, and being in the presence of various animals. Fear of public speaking; obsessive-compulsive behavior, and other psychological disorders were also found to be responsive to VRT treatment. These research activities have established a paradigm that is increasingly attracting scientists from the computer science, psychology, and medical fields.

As clients looking into the VRT head-mounted video display turn their heads, the scene changes appropriately. Visual, auditory, and tactile stimuli create a virtual world, with which the client can enter and interact. This controlled environment allows the client to reexperience events that have caused any psychological imbalance, and, most significantly, it takes place in the presence of the therapist. VRT, like current imaginal and *in vivo* modalities, generates stimuli that are unusually effective in therapy. Moreover, virtual reality generated stimuli are of greater magnitude than standard traditional techniques. VRT allows successful treatment of disorders that have often been difficult or impossible to treat with traditional techniques. A classic example is treatment of the fear of flying phobia. A virtual scene makes clients feel they are actually flying over cities. As VRT treatment progresses, these clients gradually become desensitized.

A substantial number of research activities have confirmed the success of VRT in treating psychological disorders. Table I shows a sampling of these innovative applications.

Mental and physical health risks associated with VRT can be greatly minimized by taking precautionary measures, as pointed out by Stanney in 1995. Clients at risk for psychological harm are primarily those who suffer from panic attacks, those with serious medical problems such as heart disease or epilepsy, and those who are (or have recently been) taking drugs with major physiological or psychological effects. A professional screening process will help identify these risks. Questions regarding physical and mental disabilities must be a standard part of the admissions process, and persons with these

TABLE 1
A Brief Report of Prior VRT Applications

<i>Disorder to combat</i>	<i>Experiment conducted</i>	<i>Researchers</i>
Fear of flying	Several case studies involving fear of flying were successfully conducted. After clients were exposed to virtual aerial views, they were given real world tests. A virtual helicopter and virtual commercial airplanes were used to fly the clients over realistic terrain. Afterwards, when clients flew long distances in real airplanes, they reported significant reduction in anxiety levels.	North et al., 1994 North et al., 1995 North et al., 1996 North et al., 1997a Hodges et al., 1996 Wiederhold et al., 1998
Fear of heights	Virtual scenes that were created for two major controlled studies and several case studies included balconies of various heights, an elevator, a canyon, bridges, and a series of balloons. The result: Clients comfortably accomplished real-life situations involving heights.	Rothbaum et al., 1995 North et al., 1996
Agoraphobia (fear of being in certain places or situations)	A major controlled study centered on helping clients who suffer from being in places from which escape might have been either embarrassing to them or impossible. Several virtual scenes were created for this study. The scenes included a dark barn, a cat in the dark barn, a covered bridge over a river, empty room, and a few more related virtual scenes based on the request of the clients. In general, a subjective measurement showed that a majority of the clients' subjective measurements indicated their anxiety level was reduced and they became more comfortable in comparable real-life situations.	North et al., 1995, 1996
Autism	The challenge here was to create scenes of altered reality, of the kind clients were experiencing. Traditional treatments had often been ineffective for these clients. The virtual scenes closely tracked the distortion of environment that clients had personally perceived. This enabled them to gain new insight and to better understand the real situation.	Strickland, 1996
Body experience (eating disorders)	In this study, clients were exposed to a virtual environment that let them experience a modified body image. A partial reduction in negative feelings of body dissatisfaction was reported.	Riva, 1997a, 1997b
Fear of public speaking	Several case studies were conducted using a virtual auditorium with no audience initially. As treatment progressed, more audience and varieties of sound effects were introduced. Clients' symptoms reduced significantly, and they gained greater confidence in real-world speaking experiences after the therapy.	North et al., 1997b
Fear of closed spaces (claustrophobia)	Clients in several case studies were confronted with closed spaces in a virtual house. The spaces could be resized to suit the clients' progress, allowing them to gradually cope with their fear of closed spaces and significantly reduce their anxiety level.	Botella et al., 1998 Booth et al., 1992
Fear of driving	Volunteers tested the effectiveness of virtual reality technology in automobile driving situations. They were exposed to scenes that ordinary drivers might find themselves in, such as a series of stops, turns, heavy traffic, nearby buildings, and various hazards. Phobic participants significantly and consistently reported more anxiety than the nonphobic clients.	Schare et al., 1999
Posttraumatic stress disorder	In a case study, a Vietnam veteran was immersed in virtual jungle scenes, encountering thick foliage and armed combat, including machine guns and other weapons. The client reported significant decrease in symptoms as treatment progressed.	Hodges et al., 1999

(continues)

TABLE 1
(Continued)

Disorder to combat	Experiment conducted	Researchers
Obsessive-compulsive disorder	Another case study involved a young client who had trouble remembering to take supplies she needed for school each day. She was encouraged to prepare a virtual schoolbag with all the articles she would need on a particular day. After treatment she reported more confidence in remembering what to take to school each day.	North et al., 2000
Attention deficit disorder	A virtual classroom scene was created to help a client stay focused on studying. She was exposed to an increasing number of classroom distractions, as well as activities that could be seen outside the window. VRT was shown to be more effective than previous traditional treatments had been.	Rizzo, 2000

characteristics must be excluded from VRT experiences. Additionally, some otherwise healthy people experience symptoms ranging from headaches to epileptic seizures when exposed to certain visual stimuli. Clients must be closely observed by therapists at all times. Both the client and the therapist must agree beforehand to terminate quickly the virtual reality session if there is any evidence of significant physical or psychological distress. As a routine precaution, the therapist should ask clients to sit in a chair rather than stand during the VRT procedure. It is also recommended that the therapist use a modified head-mounted display so clients can partially see their physical body, choose the head-mounted display with a narrower field of view, and, most important, keep the sessions brief (between 15 and 20 minutes). This configuration reduces the degree of immersion while increasing the physical and psychological safety of the clients. There is a need for more research in this area. In the meantime, it is strongly recommended that researchers take appropriate steps to minimize client risks.

Therapists must keep in mind that symptoms of anxiety while under VRT are distinctly different from simulation sickness. Anxiety symptoms evoked under VRT are the same as real world experiences, including shortness of breath, heart palpitations (irregular or rapid heartbeat), trembling or shaking, choking, numbness, sweating, dizziness or loss of balance, feeling of detachment, being out of touch with self, hot flashes or chills, loss of control, abdominal distress, and nausea.

See Also the Following Articles

Cinema and Psychotherapy ■ Emotive Imagery ■ Online or E-Therapy ■ Post-Traumatic Stress Disorder

Further Reading

- Booth, R., & Rachman, S. (1992). The reduction of claustrophobia. *Behavior Research and Therapy*, 30, 207–221.
- Botella, C., Baños, R. M., Perpiñá, C., Villa, H, Alcañiz, M., & Rey, A. (1998). Virtual reality treatment of claustrophobia: A case report. *Behavior Research and Therapy*.
- Hodges, L. F., Rothbaum, B. O., Alarcon, R., Ready, D., Shahr, F, Graap, K., et al. (1999). Virtual Vietnam: A virtual environment for the treatment of Vietnam war veterans with post-traumatic stress disorder. *CyberPsychology & Behavior*, 2.
- Hodges, L. A., Rothbaum, B. O., Watson, B. A., Kessler G. D., & Opdyke, D. (1996). Virtually conquering fear of flying. *IEEE Computer Graphics & Applications*, 16, 42–49.
- North, M. M., & North, S. M. (2000). Virtual reality combats obsessive-compulsive disorders (OCD). Medicine Meets Virtual Reality 2000 Conference.
- North, M. M., & North, S. M. (1994). Virtual environments and psychological disorders. *Electronic Journal of Virtual Culture*, 2, 37–42(ep.).
- North, M. M., North, S. M., & Coble, J. R. (1995). Effectiveness of virtual environment desensitization in the treatment of agoraphobia. *International Journal of Virtual Reality*, 1, 25–34.
- North, M. M., North, S. M., & Coble, J. R. (1996). *Virtual reality therapy, an innovative paradigm*. CO: IPI Press.
- North, M. M., North, S. M., & Coble, J. R. (1997a). Virtual environment psychotherapy: A case study of fear of flying disorder. *PRESENCE, Teleoperators and Virtual Environments*, 6.
- North, M. M., North, S. M., & Coble, J. R. (1997). Virtual Reality Therapy Combating Fear of Public Speaking. Medicine Meets Virtual Reality.
- Riva, G. (1997). The virtual environment for body image modification (VEBIM): Development and preliminary evaluation. *PRESENCE, Teleoperators and Virtual Environments*, 6.

- Riva, G. (1997). *Virtual reality in neuro-psycho-physiology*. IOS Press.
- Rothbaum, B., Hodges, L., Kooper, R., Opdykes, D., Williford, J., & North, M. (1995). Effectiveness of computer-generated (virtual reality) graded exposure in the treatment of acrophobia. *American Journal of Psychiatry*, *152*, 626–628.
- Schare, M. L., Scardapane, J. R., Berger, A. L., Rose, N., & Berger, S. (1999). A virtual reality based anxiety induction procedure with driving phobic patients. Presented at Association for Advancement of Behavior Therapy, November 1999, Toronto.
- Stanney, K. (1995). Realizing the full potential of virtual reality: Human factors issues that could stand in the way. *IEEE Proceedings of Virtual Reality Annual International Symposium*, '95. Research Triangle Park, North Carolina, pp. 28–34.
- Strickland, D. (1996). A virtual reality application with autistic children. *PRESENCE, Teleoperators and Virtual Environments*, *5*, 319–329.
- Wiederhold, B. K., Gevirtz, R., & Wiederhold, M. D. (1998). Fear of flying: A case report using virtual reality therapy with physiological monitoring. *CyberPsychology & Behavior*, *2*.

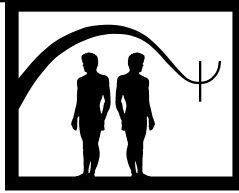

Vocational Rehabilitation

Ruth Crowther

University of Manchester

- I. Employment and Mental Health
 - II. The Role of Vocational Rehabilitation
 - III. Types of Vocational Rehabilitation
 - IV. Vocational Rehabilitation and Psychopathology
 - V. Vocational Rehabilitation and Self-Esteem
 - VI. Vocational Rehabilitation and Social Relationships
 - VII. Integration of Vocational Rehabilitation Efforts in Psychotherapy
- Further Reading

temporary jobs owned by a Clubhouse with the aim of helping them develop the skills and confidence required to cope with competitive employment.

vocational rehabilitation A range of interventions that aim to improve the quality of life and functional capacity of people who are subject to social exclusion by virtue of their disabilities, by providing them with the skills and attributes necessary for them to return to open paid employment.

GLOSSARY

akathisia A state of motor restlessness ranging from a feeling of inner disquiet to an inability to sit or lie quietly.

clubhouse A building run by clients and staff along egalitarian lines, where clients meet for social activity, mutual support and graded work experience.

expressed emotion Refers to a family environment characterized by hostility, criticism, or emotional overinvolvement.

individual placement and support model A type of supported employment approach.

prevocational training A form of vocational rehabilitation that advocates a period of preparation before placing clients into open paid employment.

rehabilitation Restoration of an optimal state of health and functioning by medical, psychological, social, and peer group support.

supported employment A form of vocational rehabilitation that emphasizes placing clients directly into open paid employment without any extended period of preparation.

transitional employment A form of vocational rehabilitation that involves the placement of clients in a series of paid but

The aim of vocational rehabilitation is to improve the quality of life and functional capacity of people who are subject to social exclusion by virtue of their disabilities. The main outcome is to reintegrate individuals back into open paid employment integrated into a community's economy. This article will present a psychosocial approach to this form of rehabilitation including the significance of work for people with mental health problems, the types of approaches offered, as well as the impact vocational rehabilitation has on psychopathology, self-esteem, and social relationships.

I. EMPLOYMENT AND MENTAL HEALTH

Work is central to human existence. It enables an individual to possess a valued social position and identity that has a significant influence on self-concept and relationships with others. As an important aspect of life

in today's society, work has a substantial effect on our fundamental aspects of personality and is a major contributing factor to our levels of self-esteem. In addition, work provides an opportunity for increasing social contact and improving skills while also providing income and financial security. Conversely, unemployment can produce high levels of stress, anxiety, and depression; low levels of self-worth; and decrease opportunities for self-development, autonomy, and social contact. The shift from being employed to unemployed is significantly associated with not only an increased risk of depression, alcohol dependence, anxiety states, and psychosomatic reactions, but also stigma, aimlessness, and poverty, which combine to trigger or amplify mental health problems. It appears that unemployment is associated with the conditions that substantially interfere with recovery from major psychopathology. This cycle of psychopathology, unemployment, and further distress, leading to further psychopathology, leading to further difficulty in adaptation and rehabilitation, is the vicious circle that spirals downwards in the lives of those with severe mental illness.

Unemployment is a major problem for all people regardless of their mental health status. However, for those people predisposed to mental health problems it makes sense that the effects of long-term unemployment could have a massive impact on their capacity to lead a happy fulfilled life. People who suffer from severe mental illness experience high levels of unemployment with rates estimated at 75 to 85%. Not only do these rates reflect the disability caused by severe mental illness, but also the discrimination experienced by this client group and the low priority given to employment by psychiatric services. Despite these high rates, surveys have consistently shown that psychiatric patients are strongly dissatisfied about not working and express a desire for competitive integrated employment.

II. THE ROLE OF VOCATIONAL REHABILITATION

Improving the course and management of severe mental illness involves not only the management of symptoms but also the social reintegration (or integration) of the psychiatric patient. Despite the recent advances in psychopharmacology for people with severe mental illness, medication is still unable to address the social impairment and skills deficits experienced by these groups that are a major contributing factor to high vulnerability for relapse. A comprehensive care package, therefore, would not only involve medication treatment and a psy-

chotherapy approach, but also interventions that provide patients with the social and occupational skills necessary for them to function at their optimum capacity in the community. The provision of these skills requires a comprehensive infrastructure of community services, in particular housing and employment, and a means for ensuring continuity of care.

In response to this increasing awareness of skills deficit for psychiatric patients, vocational rehabilitation has assumed increasing importance in the treatment package for rehabilitating people with severe mental illness. In the mid-19th century, the moral treatment of insanity regarded work as an effective therapeutic task that distracted patients from their psychotic preoccupations. This school of thought has evolved over the last half century, which has been witness to the development of a range of approaches to vocational rehabilitation for psychiatric patients.

The emphasis within vocational rehabilitation programs is, in the first instance, to provide patients with a structured day, and provide skills training that will ultimately enable them to secure open paid employment at a level that they will be able to manage. It is important to note that all psychiatric patients will require differing levels of input and the rehabilitation they receive must be highly individualized to their needs and capacity to work. For some patients this may take as little as a few months, in others as many as a few years. The type of rehabilitation a patient receives is dependent on the level of their "work-readiness," and is usually provided in the form of one of the two ideologies described later.

III. TYPES OF VOCATIONAL REHABILITATION

Prevocational training (PVT) and supported employment (SE) are the two main ideologies that have developed to help people with severe mental illness return to work.

Prevocational training otherwise known as the "trained and placed model," assumes that people require a period of preparation before entering into competitive employment—that is, a job paid at the market rate, and for which anyone can apply. This includes sheltered workshops, transitional employment, work crews, skills training, and other preparatory activities.

Supported employment, otherwise known as the "placed and trained model," places people directly into competitive employment without an extended period of preparation, and provides time unlimited, on-the-job support from trained job coaches or specialists. Much

work has been done in this area that has led to the development of a carefully specified variant of supported employment known as the individual placement and support (IPS) model. The IPS model is distinguished by six key principles. According to Becker in 1994, these are (1) the goal is competitive employment in work settings integrated into a community's economy, (2) clients are expected to obtain jobs directly, rather than after a lengthy period of preemployment training, (3) rehabilitation is an integral component of treatment of mental health rather than a separate service, (4) services are based on client's preferences and choices, (5) assessment is continuous and based on real work experiences, and (6) follow-up support is continued indefinitely.

In addition to these approaches, cross-fertilization between the two ideologies has led to the development of a number of hybrid models (or stepwise-eclectic models), that offer either a combination of, or all of, the services offered by both PVT and SE.

Although much research has been done on the effectiveness of prevocational models in terms of returning people to the workplace, up until the past 10 years limited evaluations have been done on supported employment programs. However, the past decade has been witness to a growth in supported employment programs and along with it has come a number of reviews of their effectiveness. These reviews have shown that SE appears to be more effective than PVT in terms of helping people with SMI obtain competitive employment.

An underlying assumption that has been related to work since the early asylum system is that "work is therapy." Work of the right type has been assumed to benefit patients in other nonvocational domains such as better controlling of psychiatric symptoms, increased levels of self-esteem and self-worth, and improved capacity for social relationships, all of which contribute to an overall improved quality of life. The relationship between vocational rehabilitation and each of these domains is outlined later.

IV. VOCATIONAL REHABILITATION AND PSYCHOPATHOLOGY

The pioneers of the early asylum movement hypothesized a direct relationship between employment and symptom alleviation. In modern times, however, the conceptual models within which psychiatry operates have not tended to include constructive activity as anything more than a mediating factor, intervening between sociodemographic or psychopharmacological variables and outcome in terms of symptom relief. With the treatment

of severe mental illness increasingly moving into the community, this attitude is beginning to change and the measurement of symptoms is often included among outcome measures as an indication of social adaptation and community living skills. Increasingly, these measures are being incorporated into evaluations of vocational rehabilitation services by measuring outcomes in terms of improvements to a person's psychopathology in addition to whether or not they have obtained employment.

Given that long-term mental health problems are commonly linked with chronic unemployment, it is not surprising that an improvement in socioeconomic status in the psychiatric patient improves psychopathology and prognosis. There are two likely explanations for this. First, the direct financial benefits of moving from an impoverished lifestyle will produce both mental and physical health gains, and second, the problem of chronic patienthood relates to social marginalization. The emphasis on employment or work, in "normalization" or "social valorization" rehabilitation theory, reflects a strategy to reverse this marginalization.

An additional latent clinical benefit of some work schemes is that they provide structured opportunities for supervision and treatment compliance. Support is often provided in the workplace for those who need it and in addition to an awareness of whether a person has taken medication or not, often an individual will not want to jeopardize their job by failing to take their medication and increasing the likelihood of relapse. A negative aspect of medication is that for many people the sedation effects and akathisia caused by medication make work tasks difficult. Therefore, until the medication regimen is stable, work would not be considered a feasible option.

Not only does employment appear to have a positive effect on psychopathology, but symptom alleviation could also be seen as a consequence of improvement in other facets of an individual's life, which again, are influenced by vocational rehabilitation. This type of rehabilitation is thought to have a significant impact on the level of self-esteem, which in turn can promote improvements in mental state.

V. VOCATIONAL REHABILITATION AND SELF-ESTEEM

Self-esteem is the evaluation people make and maintain about themselves and has been defined as evaluation of one's own worth, value, or importance. It is essential to our ability to function in a healthy way. Without the foundation of a solid sense of self-worth,

we are unable to take the risks and make the decisions necessary to lead a fulfilling, productive life. A low self-esteem has a negative effect on our relationships, careers, family bonds, and, most important, our internal sense of well-being. A high self-esteem, on the other hand, brings the high level of confidence, problem-solving abilities, and assertiveness needed to achieve what Maslow referred to as "self-actualization"—a continuous desire to fulfil potentials, to be all that you can be. Obviously this refers to everyone regardless of their mental health status; however, for psychiatric patients, this is a state that is particularly difficult to achieve. People who have positive self-esteem have healthier, stronger relationships with those with negative self-esteem. A strong sense of self-worth actually creates a type of self-fulfilling prophecy. The more people like themselves, the more they begin to act in likable ways, the more they believe they are able to achieve something, the more likely it is that they will.

The concept of self-esteem has been widely used as an outcome variable in studies of rehabilitation. This is based on the assumption that a higher level of functioning is coexistent with a higher level of self-esteem and feeling of self-worth. The sources of self-esteem are regarded as personality related and as a function of intrapersonal evaluation, individual roles, role accumulation, or early childhood experience. Self-esteem has two essential elements, social status and affirmative experience. Social status refers to an individual's position in society relative to others, and is most often measured in terms of household income, educational attainment, and occupation. As employment is a major source of social status, it may, therefore, be argued that employment in a respected occupation is a means of restoring the self-esteem of people with mental health problems that cannot be obtained in any other way. Affirmative experiences are experiences in which individuals receive positive reinforcement from others about their abilities and behavior. Affirmative experiences can usually be obtained through a variety of social encounters; however, people with mental health problems may have limited opportunities for social interaction. Hence, work in a nonstigmatized setting may enhance the self-esteem of people with mental health problems.

Goodman and colleagues in 1994 found that in psychiatric patients, low levels of self-esteem were found to be associated with higher levels of psychiatric disturbance and higher levels of external locus of control among African-American women. The potential of employment to influence self-esteem is shown by the Rosenfield model. Rosenfield's 1992 study of a Club-

house took "mastery" as a pivotal concept, defined as "a personal resource that can moderate or help in coping with the effects of stress. . . . A low sense of mastery affects subjective quality of life because it results in feelings of hopelessness and passivity." Rosenfield points out that many psychotherapists have suggested increasing a sense of mastery as the first task in psychotherapy for people with chronic mental health problems. Leading on from this she set out to explore associations among vocational rehabilitation, mastery, and quality of life. She concluded that economic resources and empowerment increased a sense of mastery and hence a better quality of life. Controlling for perceptions of mastery, she also found that having a greater time structure as imposed by work, increased people's quality of life.

Studies comparing people with mental health problems who were either in competitive employment or unemployed, found that those in competitive employment had significantly higher self-esteem than those unemployed. In addition, studies have also shown that patients working in sheltered workshops had a high level of self-esteem associated with the opinion that their job held a "valued social position."

Given the obvious importance self-esteem has on both people's capacity to lead a fulfilling life, and the type of employment they consider themselves suitable for, and able to do, rehabilitation in conjunction with psychotherapeutic interventions need to implement techniques that focus specifically on increasing levels of self-esteem.

VI. VOCATIONAL REHABILITATION AND SOCIAL RELATIONSHIPS

Our levels of self-esteem also have a significant impact on our ability to maintain social relationships. This can be seen as a self-perpetuating circumstance in that a low level of self-esteem severely disables a person's ability to interact and build social relationships. Conversely, interaction and social relationships can help build a person's feeling of self-esteem and self-worth and make them feel wanted. Social support or interaction can be seen as part of our basic need for belongingness and love and is defined as the degree to which a person's basic social needs are gratified through interaction with others.

Psychiatric patients commonly suffer deterioration of social relationships, particularly in the case of schizophrenia. Evidence for the importance of social support

in schizophrenia is growing with research showing that psychiatric service users have smaller social circles than people without mental health problems. In addition, patients with schizophrenia also perceive themselves to have fewer people offering instrumental support, and fewer social companions than those suffering with depression.

Although an understimulating social environment has been shown to be associated with clinical poverty syndrome, or institutionalization, conversely, an overstimulating one can precipitate psychotic episodes. Given that patients with schizophrenia tend to react adversely to overstimulation it is unsurprising that they withdraw from social interaction and are reluctant to enter a work environment. The emphasis here is on both the level of stimulation and the level of communication required to operate within the workplace. Obviously both of these factors need to be at a level that is suitable for each individual, while acknowledging that thresholds will be different for each person.

It is important to note here that the quality of the relationships within work is of importance. Relationships are bidirectional in that they can be seen as reciprocal or dependent. Although psychiatric patients may consider themselves dependent on a relationship in terms of receiving support, they must possess a sufficient level of social skills to maintain that relationship. Therefore, diminished social interaction may be due to the breakdown of social skills, which then places the person at a disadvantage in terms of disabling his or her capacity for beneficial social interaction.

People with mental health problems who are entering a work environment are exposing themselves to an entirely new source of social supports. These supports can be seen as “natural” (e.g., from colleagues) or “constructed” (e.g., from supervisors or job coaches). These relationships can be then further built on in order to provide both emotional and instrumental support, in some cases becoming friendships that extend beyond the workplace. The Clubhouse movement advocates this ethos in its work intervention known as transitional employment. For psychiatric patients, constructed networks derived from therapeutic settings may serve as a substitute for poor social networks outside work.

Another important aspect of employment that may facilitate improvement is removal of psychiatric patients from the home environment where their social contacts may have a high level of expressed emotion (EE). Research in EE has clearly demonstrated that medication and removal from relatives who have high EE can protect the psychiatric patient from relapse. It

therefore follows that a structured work environment to where the patient can “escape” on a regular, structured basis may serve as a protective factor. It is of obvious importance that the work setting does not replicate high levels of EE. This can be prevented by education of supervisory staff and colleagues about the concept and manifestations of EE.

VII. INTEGRATION OF VOCATIONAL REHABILITATION EFFORTS IN PSYCHOTHERAPY

Given the psychosocial aspects of vocational rehabilitation, there is a common link between this type of intervention and that of psychotherapy. Both interventions share the goal of increasing the functional capacity of the individual. The difference is that within psychotherapy, the improvement of psychopathology, self-esteem, and the capacity for social relationships are specific aims, whereas in vocational rehabilitation, they can be seen as by-products of improving an individual's capacity to work.

In terms of provision of these interventions it would be desirable to offer them within a framework where all aspects of the patient's care are provided collaboratively and communication between the services is common. Both interventions require the input of specialized individuals and it is unlikely that an individual or particular caregiver will be expert in both enough to integrate them into his or her practice. Therefore, it is often the case that both interventions will be carried out by separately trained practitioners who may not share the same views of the nature of psychopathology. They may have differing subtle and not so subtle goals and ideas about what is practical for an individual to achieve, and consequently the opportunity for conflict between the two may arise. Consequently if they are not organized out of the same agency providing care and leadership in treatment planning, they must commit themselves to a regular form of communication in which they share their ideas and assessments of individuals. Regular discussions need to take place concerning what the individual wants to achieve and whether it is feasible, what difficulties may be encountered, and perhaps most important any difficulties that may arise in their relationship with one another as they collaborate in the care of the individual. It is important to acknowledge here the existence of one such mechanism that aims to achieve treatment integration. This mechanism is known as case management, which involves a team of professionals

with a limited number of cases for each intervention, thus reducing the workload and enabling more time and commitment for patients' care. The emphasis within the team is on collaborative working, with regular meetings for discussion about patients.

Only by collaborative working between all services involved in a person's care will we be able to bring the management and rehabilitation of psychiatric patients together in an organized cohesive manner. This will enable us to ultimately provide a seamless service working closely together with the common goal of improving the overall functioning and capacity of the psychiatric patient, thus facilitating (re)integration back into the community.

Acknowledgments

The author would like to acknowledge the funding support from the National Health Service Research and Development North West.

See Also the Following Articles

Job Club Method ■ Schizophrenia and Other Disorders

Further Reading

- Becker, D. R., & Drake, R. E. (1994). Individual placement and support: A community mental health center approach to vocational rehabilitation. *Community Mental Health Journal*, 30, 193–206.
- Bell, M. D., Lysaker, P. H., & Milstein, R. M. (1996). Clinical benefits of paid work activity in schizophrenia. *Schizophrenia Bulletin*, 22, 51–67.
- Bond, G. R., Drake, R. E., Becker, D. R., & Mueser, K. T. (1999). Effectiveness of psychiatric rehabilitation approaches for employment of people with severe mental illness. *Journal of Disability Policy Studies*, 10, 18–52.
- Crowther, R. E., Marshall, M., Bond, G. R., & Huxley, P. (2001). Helping people with severe mental illness to obtain work: A systematic review. *British Medical Journal*, January 2001, 204–208.
- Lehman, A. F. (1995). Vocational rehabilitation in schizophrenia. *Schizophrenia Bulletin*, 21, 645–656.
- Rosenfield, S., & Neese-Todd, S. (1993). Elements of psychosocial Clubhouse program associated with a satisfying quality of life. *Hospital and Community Psychiatry*, 44, 76–79.
- Torrey, W. C., Mueser, K. T., McHugo, G. H., & Drake, R. E. (2000). Self-esteem as an outcome measure in studies of vocational rehabilitation for adults with severe mental illness. *Psychiatric Services*, 51, 229–233.



Women's Issues

Malkah T. Notman and Carol C. Nadelson

Harvard Medical School

- I. Introduction
 - II. Values and Treatment
 - III. Gender Influences and Differences in Early Development
 - IV. Body Image and Reproduction
 - V. The Role of Reproductive Life Experiences
 - VI. Gender and Choice of Therapist
 - VII. The Therapeutic Process
 - VIII. Gender Choice in Couples and Family Therapy
 - IX. Group Therapy
 - X. Sexual Abuse
 - XI. Alcohol and Substance Abuse
 - XII. Conclusion
- Further Reading

GLOSSARY

gender identity The perception of oneself as being either male or female, and the acquisition of social roles culturally appropriate for that person that are gender linked.

gender role A cultural construct referring to the expectations, attitudes, and behaviors that are considered to be appropriate for a particular gender in a particular culture.

sexual orientation The sexual preference of a person based on gender, i.e. homosexual, heterosexual, bisexual.

I. INTRODUCTION

Gender is an important variable in psychotherapy. Gender can influence a patient's choice of therapist, the

"fit" between therapist and patient, and the sequence and content of the clinical material presented. It also affects the diagnosis, length of treatment, and sometimes outcome. Gender differences in experiences affect the perception and interpretation of patient material. Biologic aspects of gender must be considered from a perspective that reflects emerging data that unify brain and mind, biological, and psychosocial factors.

Evidence of gender differences in the nervous system beginning in fetal life suggests that, from birth, boys and girls may not perceive and experience the world in the same way. Gender differences in neural maturity and organization influence behavior and reactions in infants that can also affect caretakers' response, further reinforcing differences. These differences in reactions can alter the growth and development of neuronal pathways. Experience modifies the structure and function of neurons and neuronal networks, and can modify gene expression. Brain structure, metabolism, and function are also affected by psychotherapy. These findings reinforce our understanding of the plasticity of the brain and how it is affected by behavior and experience. The implications of these data underscore that the distinction between biological and psychosocial is both artificial and misleading.

In this article we focus on the relationship between gender and psychotherapy, considering psychosocial and biological variables. We will examine biological influences, developmental and life experiences, gender differences in personality styles, and the effects of stereotypes and values.

II. VALUES AND TREATMENT

Personal and social values affect standards of normality and influence the perception, diagnosis, and treatment of mental disorders and emotional problems. Although there have been changes in concepts of normality, mental illness, and the range of behaviors and attitudes that are thought to characterize each gender, evidence suggests that there continue to be differences in what is considered normal for men and women, even by therapists. Broverman and colleagues in their classic 1970s study found that when male and female psychotherapists were asked to describe a mentally healthy person, psychological health was more closely associated with descriptions of "healthy, mature, socially competent" men than with concepts of maturity or mental health of women. Although a 1990 report by Kaplan and co-workers noted that attitudes toward gender roles have changed to some extent, and that male and female psychiatrists' beliefs regarding gender-appropriate behavior had become more similar and less stereotyped, ratings derived from the Bem scale indicated that female and male psychiatrists were still more likely to choose stereotypical traits to define mental health.

Although concepts of normal masculine and feminine behavior and attitudes have shifted, these changes are not necessarily integrated into a cohesive view of normality for either men or women. Attitudinal changes may be consciously adopted by those treating a patient, but unconscious views about what is "normal" may be unchanged and can affect therapy.

Values are communicated to patients in both overt and subtle ways in the process of evaluation and referral as well as during treatment. In psychotherapy, therapists communicate values by their selection of material to respond to, by the timing of their interpretations, and by their affective reaction to the content of what is said by the patient. This subtle communication conveys the therapist's judgment. For example, the therapist may emphasize or ignore the patient's references to menstruation, to taking drugs, or to engaging in risky sexual behavior and women patients may be more reluctant to discuss these with male therapists. By responding, the therapist expresses a judgment of what is important and to whom, and consequently may misinterpret the importance of these issues for the patient.

Gender also affects treatment priorities and approaches. It has been suggested, for example, that concern about some more characteristically male behaviors, such as violence related to alcohol abuse, may lead to the development of treatment methods that are more suitable for men. These methods may also be used for

women, although there is evidence that they are less effective for them. Likewise, more attention may be paid to treating the adolescent schizophrenic or substance-abusing man, because of the threat of violence, than to treating the seriously handicapped but less threatening women with posttraumatic stress disorder (PTSD) or depression.

III. GENDER INFLUENCES AND DIFFERENCES IN EARLY DEVELOPMENT

Early influences and endowments, both biological and psychosocial, are important in the shaping of personality. In childhood, the presence or absence of continued stable care, styles of child rearing, the responsiveness and nurturance of people in the environment, physical health and illness, loss, and trauma, as well as biological endowment, are all determinants of the ultimate configuration of personality.

Complex integrative functioning, such as conceptualization and learning of language and social skills, derives from both biological and psychosocial influences. These may differ between males and females. The effects of particular cultural practices, including gender differences in child rearing, and ideas about gender-appropriate roles are also manifested very early in life and affect development. Parental behavior affects male and female roles and is a powerful developmental force.

Ideas about the determinants of gender identity have changed from the early views that the major determinants of gender development were anatomical, to a view that development and gender concerns represent a complex interplay of anatomy, genetic endowment, and environment including developmental experiences and cultural context. These include the structure of the family, the presence and roles of other siblings, the mother's other pregnancies, and many aspects of the child's relationship with extended family and others.

There seems to be a connection between early trauma and the development of personality disorders, especially borderline personality disorder, which is more commonly diagnosed in women than in men. There is evidence that developmental disruptions occur when an individual is traumatized early in life.

Gender role is a cultural construct referring to the expectations, attitudes, and behaviors that are considered to be appropriate for each gender in a particular culture. There are enormous differences in the roles and expectations of men and women in different soci-

eties. Some societies dictate more rigid and fixed roles than others. Not all value the same traits or see certain traits as gender specific in the same ways. For example, physical strength is often considered a male characteristic, but despite their smaller size and lesser physical strength women in some cultures are assigned the heavy work. The role most consistently assumed by women across cultures is early child rearing.

During early development, in all cultures, the mother remains the primary caregiver of young children. The earliest attachment is more likely to be made with her. She becomes the primary identification figure in early childhood, for both boys and girls. Therefore, for girls, the first identification is with the parent of the same sex. For boys, the first identification is with the parent of the opposite sex. As girls grow up, this same-sex identification does not have to change in order for feminine gender identity to consolidate. Thus, girls learn about being women in identifying with their mothers. Boys, on the other hand, must shift their primary identification away from their mothers in order to develop a male gender identification. Thus, they move away from their early attachment.

For girls, the continuity of attachment to their mothers, and the fear of loss of love by manifesting aggression that is disapproved of, may make it more difficult to establish autonomy and independence. Aggression, competitiveness, and anger may be difficult to manage because these affects can threaten loss of relationships. It can be difficult for women to express themselves freely, especially when they experience anger and aggression, and, at the same time to preserve relationships. This may be seen later in life in a woman's conflict about aggression, manifested in her difficulty in being appropriately assertive and in her inhibited risk-taking or autonomous behavior. Cultural values such as independence, initiative, and competitiveness have been considered positive characteristics for males, but not for females.

Because of the primacy of relational ties, women also may be more vulnerable to loss throughout their lives. One of the syndromes that has been seen as related to the conflict about autonomy and independence and the sense of vulnerability to loss is agoraphobia, which is more commonly diagnosed in women than in men. Although this syndrome has multiple determinants, it may represent anxiety about moving out into the world and feeling alone. Depression is also more frequently diagnosed in women than in men. The reasons for this are complex and unclear, but multidetermined, including conflicts about aggression and mastery, social deprecation of feminine roles, identification with depressed mothers, early loss, and biological factors.

In contrast, disturbances involving violent, aggressive behavior, and problems with impulsiveness are more often diagnosed in men. Conflicts around intimacy and socialization toward aggression and action are consistent with this picture in men. These findings raise questions about the factors affecting the process of diagnosis itself, particularly with Axis II disorders. Because these disorders more generally reflect clusters of observed personality characteristics rather than specific symptoms, incidence figures may reflect biases and sex-role stereotypes.

At times, women may also fail to act in their own best interests because of their desire to preserve relationships, even if these are abusive. This can result in behavior that may continue to put them at risk for victimization. The threat of loss then, may motivate behavior that can be interpreted as masochistic. For women, the conflict experienced about aggression can result in turning aggression inward, with excessive self-criticism and diminished self-esteem. Culturally supported passivity with consequent feelings of helplessness can be risk factors for depression. Problems in the development of self-esteem, for girls, appear to be intensified in adolescence. Gilligan found that there are gender differences in self-concept and identity in adolescence. Males generally define themselves in terms of individual achievement and work, and females more often in relational terms. Gender differences in depression, except in bipolar illness, appear to have their onset in puberty, a time when girls begin to assume adult feminine identities and roles.

IV. BODY IMAGE AND REPRODUCTION

With the beginning of puberty, girls and boys experience their reproductive identities in different ways. For girls, menarche signals a capacity for pregnancy. This change also brings a potential vulnerability for girls that is not in boys' experience. It is both a positive experience and a source of risk and anxiety. Girls develop new organs, breasts, transforming their bodies. This has no parallel in boys. For a girl, menarche is an organizer of sexual identity. It is also an undeniable physical experience, and it can be a source of pleasure and conflict about growing up and about femininity. Adolescent girls in Western cultures are bombarded with media images of women who are loved because of their physical appearance. Self-esteem and self-confidence rest heavily on physical attributes and body image especially during adolescence, for both sexes.

Conflicts around self-image and body image become more prominent during adolescence and can be expressed differently for boys and girls. Discomfort with body image and fear and ambivalence about mastery, independence, separation from family, and adulthood including sexuality, are difficult issues that are thought to contribute to the dramatic incidence of eating disorders in adolescent girls. They may literally attempt to starve themselves back into childhood and diminish female body characteristics (e.g., curves and breasts).

V. THE ROLE OF REPRODUCTIVE LIFE EXPERIENCES

Women's life cycles are closely connected to their reproductive potential. The acknowledgment of a woman's reproductive capacity is an important component of her sense of identity and femininity, regardless of whether or not she actually bears children. The knowledge that there is a finite time period for reproduction also influences her concept of time. She must make different decisions about career and family than men do. This difference can affect her emotional state, her decision to seek therapy, and the issues that will be raised in the course of therapy. With delays in the time of childbearing for contemporary women, many come to treatment as they approach 40 or in their early 40s to deal with issues around childbearing. They have not confronted their biological clocks and must deal with the issues of reproduction before it is too late.

Reproductive events, decisions, and choices may have different significance for men and women, thus affecting the process of therapy. Because reproductive issues are more likely to be addressed for female patients, male patients may find that their reproductively related concerns are not dealt with. Therapists often share the patient's reluctance to explore these issues. This avoidance may result from the conscious or unconscious conviction that exploration of a man's infertility or sexual dysfunction would be too great a threat to his view of his "masculinity."

Pregnancy as a life event marks a transition to motherhood and raises many issues for a woman, including her relationship and identification with her mother. Although pregnancy is usually experienced positively it also increases a woman's vulnerability to specific psychiatric disorders, particularly postpartum depression.

Infertility is also a different experience for men and women, and there are different issues to consider in treatment. Historically, and in some cultures today, women have been seen as the sole responsible partner when there

is infertility. A woman's pregnancy has been viewed as a confirmation of a man's masculinity and potency. Infertility can be a threatening and distressing problem for both men and woman, but in different ways, depending on how important it is to each partner and what the etiology is. Social norms have supported men's resistance to be involved in infertility workups and treatment.

Menopause is a unique marker of the life cycle for women. Stereotyped expectations about women's life cycle and the attribution of midlife symptoms to menopause have resulted in the confusion of the experiences of this time of life, including concerns about the physical and emotional aspects of aging, family changes, shifts in goals, and retirement, with the effects of the physiological event of cessation of menses. Menopause has been linked with depression and loss, but there is no evidence supporting that this is an inevitable connection. Those women who become depressed in midlife are generally those who have had depressions at other times in their lives. The peak incidence of depression in women, in fact, is in early adulthood. Responses to menopause are also strongly influenced by cultural expectations, and in many cultures, women regard the cessation of menses and childbearing with relief and sometimes with greater enjoyment of sexuality.

VI. GENDER AND CHOICE OF THERAPIST

Patients give many reasons for their choice of a therapist. These reasons have often been based on stereotyped views such as "men tend to perpetuate patriarchal values," or "women are more nurturant."

The search for a role model is often a determinant of the choice of a therapist. Women frequently feel that a woman therapist will be more responsive to their wishes for achievement, success, and self-actualization or that because she has faced similar conflicts she could empathize with them more easily. Although this idea may facilitate the development of an alliance, it does not by itself resolve the patient's difficulties.

Women may also request to see a woman because they seek permission to succeed in certain goals, particularly those involving career. Permission, explicit or implicit, can result in improvement and can enable the patient to compete and succeed, even if the issues are not taken up specifically and explicitly. Identification with a therapist is also important. Although the reasons for the choice may be based on stereotypes, without regard for the characteristics of the specific therapist, the patient's feel-

ing of greater comfort or empathy can facilitate the initial development of a positive therapeutic alliance.

A patient's gender-based choice can also derive from idealized fantasies about the characteristics and capacities of the clinician and what he or she can do for the patient. For example, if the clinician is a prominent person in the community, expectation based on this status can affect the therapeutic relationship. If the patient makes a choice because of particular political views, sexual orientation, or the cultural heritage of the therapist, treatment may begin with positive feelings, only to have these reversed if, in the course of treatment, the patient is disappointed. The recognition that the therapist is not omnipotent repeats past life experience. If there is a negative outcome it may be blamed on the therapist's gender. If the therapist is a woman who is not the fantasized omnipotent mother who can transform the patient, devalued ideas about women can be confirmed.

Choosing a therapist of a particular gender with the expectation that this will resolve the patient's problems can also be a resistance to therapy. A woman may want to see a woman for treatment because she feels unlovable and unattractive to men and can, in this way, avoid the experience of confronting her feelings or initially because she wants support, and later devalues the therapist or find herself in an angry competitive interaction, which can be a repetition of her relationship with her mother. She may be unaware of the origins of her feelings or the reasons for her choice of a therapist. Although there are conscious reasons for choices, unconscious factors or needs such as fear, anger, or a search for mothering may be important and should be considered in the initial encounter with a patient. For a woman, the choice to be treated by a woman can also represent a wish to restore the relationship with her mother or to have a better mother. A desire to see a male therapist can be based on the desire to avoid this maternal kind of relationship or the anxiety that these feelings arouse, or may reflect anxiety about the intense attachment that may be evoked by a woman.

Many support the view that women should be treated by women in order to avoid being misunderstood or treated from a male-oriented perspective. This oversimplifies the effects of gender and minimizes the necessary working through of ambivalence and conflict in the therapeutic relationship.

Concerns about sexualization and sexual relationships in treatment have become important factors in requests based on gender. For those patients who have actually been abused in previous treatment, trust can be severely damaged. It may be particularly difficult for such patients to see anyone who serves as a reminder of

that previous experience. Women therapists are often asked to see women patients who have had sexual involvements with male therapists. Although it does occur, women are less likely to become sexually involved with their patients, either male or female, than are men.

Sexual orientation has also become a consideration for many gay individuals who request therapy with gay therapists. They feel that a gay therapist will better understand and empathize with them and will be less likely to judge their sexual object choice as pathological. Although there has been controversy about the appropriateness of disclosure of the therapist's sexual orientation, some therapists believe that this disclosure can be beneficial in therapy.

Stereotypes and expectations about women affect male patients as well. A man may seek treatment from a woman therapist in order to avoid a competitive or authoritarian relationship with a man, to avoid homosexual feelings, or because he has had poor relationships with women in the past and wants to work these out with a woman. His expectations may be that a woman will provide the cure for his problems with intimacy.

VII. THE THERAPEUTIC PROCESS

Understanding the concept of transference can clarify aspects of the therapeutic relationship that may otherwise be difficult to comprehend. The attitudes and feelings brought to a relationship from past experiences with important figures such as parents are components of future interpersonal interactions. The need to please or to gain love by acquiescence or seductive behavior can be brought into the therapist-patient relationship as if it were a response of the patient to the therapist as a real person in the present. The therapist can be seen as rejecting, authoritarian, giving, preferring other patients, and so on.

The classical conceptualization of transference assumed that both maternal and paternal transference could be developed toward both male and female therapists. Thus, the therapist's gender was not a particularly salient consideration. Freud came to believe that transference responses to a male analyst differed from those to a female analyst. Subsequently, however, Horney emphasized the importance of the competitive transference with the same-sex analyst, and Greenacre stated that strong gender preferences should be respected, but also carefully analyzed because prior wishes, expectations, and fantasies could affect not only the choice but also the course of the psychoanalytic process.

Gender can affect the initial relationship and the early evolving transference, as well as the sequence in which therapeutic issues emerge, and the pace at which therapy progresses. For example, working with a woman therapist can evoke maternal transference material earlier in therapy. Transference expectations may cause some patients to fail to reveal details of sexual abuse or other sexual experiences to a male or female therapist depending on the patient's view of how the therapist might hear or react to this information. This lack of disclosure may also be related to the patient's stereotypical ideas as well as the particular characteristics of both patient and therapist.

Assessment of the kinds of transference engendered may be complicated by the countertransference of the person doing the assessing. Although an erotic transference may occur in a man's transference to a woman therapist, it is more common for women patients to develop an erotic transference to either male or female therapists. This can create problems, particularly for the inexperienced therapist. The idea that a real romantic or sexual relationship can be therapeutic to a patient can be difficult to reject if the patient passionately pursues this or demands it, particularly if she is suicidal and it may be rationalized as life-saving. Sexual relationships with patients are ethical violations, boundary violations, and leave the therapist open to legal action as well as therapeutic failures. When these become an issue in therapy, a consultation and supervision is very important.

Transference can take many forms, including cross-gender manifestations. It is possible for a woman patient to develop a paternal transference to a woman therapist. It may be difficult for the therapist to imagine himself or herself as the cross-gender person or for a man to imagine himself as a mother or a woman as a father.

Current views of transference emphasize that the therapist or analyst plays a role in the creation of the transference, even if this is not consciously recognized. Thus, recognition of the effect of the gender of both participants is important.

Change or reassignment of a therapist on the basis of gender has been widely discussed and is often recommended. Some have suggested that a change of therapist might mobilize a stalemated situation. Transfers on the basis of the therapist's gender have also been made when there is a therapeutic impasse or failure.

Unless there has been a sexual interaction, however, it is rare that gender itself is the significant variable in the majority of cases that are not successful. A transfer based on gender may be a way of avoiding responsibility for failure or dealing with the embarrassment of a negative outcome. Person suggested that women thera-

pists are often referred particularly difficult patients after these patients have failed a first therapeutic effort. Because gender affects trust and compliance in psychotherapy, change in the therapist based on gender might be helpful in some situations.

VIII. GENDER CHOICE IN COUPLES AND FAMILY THERAPY

As with all forms of therapy, gender is a consideration in the choice of a therapist for couples or families. In general, as with individual therapy, issues related to gender choice should be clarified and addressed. A couple with marital difficulties may request a female therapist because it is the wife who has made the call and it is her preference, perhaps because she feels intimidated by men or because she fears that she could be left out of the male dyad if the therapist were male. On the other hand, a husband may choose a woman or comply with his wife's choice of a female therapist because he is more comfortable and less threatened by women, because he does not take the therapy seriously, or because he has negative feelings about women. The choice of a male therapist for some couples may re-create, in the transference, a paternal or authoritarian relationship or even the fantasy of possible sexual abuse. This can be a special problem if abuse has actually occurred.

During the course of therapy, attention must be paid to bias regardless of whether the therapist is male or female. Transference issues in couples and family therapy are multiple and more complex because more people are directly involved in the therapy. For example, each partner and the couple as a unit will have different transference reactions to the therapist and to each other. If there are additional family members involved they too will add to the transference complexity.

Changes in family patterns have presented an increasing array of challenging issues for therapy. For example, the stress and demands of dual-career or commuting families, especially those with two achievement-oriented partners, can create enormous tension. This may be a greater source of conflict if the wife is earning more money, or if there is a job offer to either partner in another city. Because the husband's work has traditionally been the motivating factor in a relocation, a wife's job offer can create tensions, especially involving competition. A wife who achieves success later in life can be on a different timetable than her husband, who may wish to retire earlier.

Feminist critiques of family therapy express concern about the structural-hierarchical dominant role of

males in the family, mother blaming, assumptions about sharing power and responsibility embedded in systemic concepts, and assumptions about therapist neutrality. Family therapy has also been criticized for biased treatment of men, for example, for reinforcing the socialized limitations of male roles.

IX. GROUP THERAPY

As with couples and family therapy, there are gender issues in group therapy. When group therapy is sought or recommended, the gender of the group therapist is not frequently considered, although the gender composition of the group is often thought to be important. There are data suggesting that group behavior between group members and with the leader is affected by gender.

Women often seek women's groups because in groups of men or even in mixed groups they feel powerless, intimidated, and uncomfortable about speaking up. One need only look at classrooms, professional meetings, and business groups to recognize that women speak less often than men, and when they do speak, their comments are more often ignored or attributed to men. Women report the same experiences, regardless of professional status or income. They may feel supported and less anxious in same-sex groups, although mixed groups may be helpful in confronting these issues.

Most often single-sex groups have been used for support and consciousness-raising. Both male and female self-help groups often form around a specific focus (e.g., substance abuse, divorce, family violence) and use problem-solving approaches.

Therapy groups with both male and female leaders permit men and women to deal with transference issues, both as peers and as leaders. It is important, however, that the leaders' relationship with each other, just as with male and female therapists in family therapy, be a facilitating rather than inhibitory factor. Mistrust, competition, and anger that are not addressed in either leader or group members can be unproductive and inhibitory to group process.

X. SEXUAL ABUSE

When there is a history of early trauma, especially sexual abuse, which is more common in women, the impact of the trauma and the betrayal by parental figures or those in authority can result in psychopathology that can emerge later. It can be understood as an etiological factor in the increased likelihood that sur-

vivors of childhood abuse will be victimized as adults. Studies also report profoundly self-destructive behaviors emerging after victimization. Somatic symptoms can also develop later. The aftermath of abuse, particularly after repeated abuse, is often a residual sense of helplessness and loss of autonomy. This may intensify conflicts about dependency and stimulate self-criticism, shame, and guilt in many areas of life. Difficulty handling anger and aggression, and persistent feelings of vulnerability are also common repercussions.

For those who have been abused, the ability to form a trusting therapeutic alliance may be difficult. This is an example of a situation in which patients may not seek or continue therapy if they are not comfortable with the therapist, and in this way gender may be a variable.

Some of the responses and behaviors of those who have been victimized evoke profound countertransference reactions in those treating them. It may be difficult to work with battered and abused women, who often evoke frustration and anger because of their tendency to displace anger, their passivity and failure to follow through on suggestions, and the frequency with which they return to the abusive situation. Some therapists overidentify with these patients and may also project their own feelings, fantasies, or experiences onto their patients. These may include judgment about the appropriateness of the patient's response. Rescue fantasies may occur in both male and female therapists when they treat abuse victims and can lead to therapeutic problems such as boundary violations. The therapist may attempt to become the loving, nonabusive parent that he or she thinks the patient should have had instead of the real, abusive parent. These countertransference problems can compromise the therapeutic relationship.

XI. ALCOHOL AND SUBSTANCE ABUSE

There is less known about the epidemiology and treatment of alcoholism and substance abuse in women than in men. Pharmacological treatments have often paid little attention to the different presentations, physiology, and needs of men and women. For example, women's smaller body size, higher body fat content, and lower alcohol dehydrogenase levels contribute to higher blood alcohol concentrations in women with the same alcohol intake, and to the greater effect of smaller amounts of alcohol in women. Likewise, there are psychological and sociocultural factors affecting the behavior of those with alcohol and substance abuse. Currently, treatment approaches are similar for men and women, and do not ac-

count for gender differences. For example, treatment programs attempt to dissociate abusers from their alcohol- or drug-using peers, placing women drug and alcohol abusers at a disadvantage because they are more likely to live with partners who are also abusers and who discourage or prevent them from seeking help with threats or actual physical and/or sexual abuse.

Women respond better to relational involvement in treatment programs. They are more likely to attend and participate in women's groups. Because women's substance abuse often is less visible than it is for men, their abuse is often not recognized by family and friends so they are not encouraged to seek treatment.

XII. CONCLUSION

It is apparent that gender is an important treatment variable and that attention to the particular needs and experiences of women, together with better understanding of the complex interaction of gender and other variables, will shed light on the therapeutic process and contribute to greater therapeutic effectiveness. We have seen that gender can influence the patient's choice of therapist, the "fit" between therapist and patient, the sequence and content of the clinical material presented, the diagnosis, length of treatment, and the outcome of the treatment. Stereotyped views, expectations, and unconscious transference and countertransference fantasies about gender differences and what they will mean in the therapeutic process often persist and are influential, regardless of whether they have demonstrable validity. As more attention has been paid to the real attributes of the therapist, age, race, culture, gender, life experiences, and other variables have been understood to play an important role in the therapeutic process.

See Also the Following Articles

Couples Therapy ■ Cultural Issues ■ Eating Disorders ■ Family Therapy ■ Feminist Psychotherapy ■ Multicultural Therapy ■ Race and Human Diversity ■ Transcultural Psychotherapy ■ Sex Therapy

Further Reading

Adler, D. A., Drake, R. E., & Teague, G. B. (1990). Clinicians' practices in personality assessment: Does gender influence

- the use of DSM-III Axis II? *Comprehensive Psychiatry*, 31, 125–133.
- Chodorow, N. (1978). *The reproduction of mothering: Psychoanalysis and the sociology of gender*. Berkeley, CA: University of California Press.
- Clarkin, J. F., & Kernberg, O. F. (1993). Development factors in borderline personality disorder and borderline personality organization. In J. Paris (Ed.), *Borderline personality disorder: Etiology and treatment* (pp. 161–184). Washington, DC: American Psychiatric Press.
- Comtois, K. A., & Ries, R. K. (1995). Sex differences in dually diagnosed severely mentally ill clients in dual diagnosis outpatients treatment. *American Journal on Addictions*, 4, 245–253.
- Gabbard, G. O., & Wilkinson, S. M. (2000). *Management of countertransference with borderline patients*. Washington, DC: American Psychiatric Press.
- Gilligan, C., Rogers, A. G., & Tolman, D. L. (1991). *Women, girls and psychotherapy: Reframing resistance*. New York: Harrington Park Press.
- Greenacre, P. (1959). Certain technical problems in the transference relationship. *Journal of the American Psychoanalytical Association*, 7, 484–502.
- Gunderson, J. G., & Sabo, A. N. (1993). The phenomenological and conceptual interface between borderline personality disorder and PTSD. *American Journal of Psychiatry*, 150, 19–27.
- Johnson, J. G., Cohen, P., Brown, J., Smailes, E. M., & Berstein, D. P. (1999). Childhood maltreatment increases risk for personality disorders during early adulthood. *Archives of General Psychiatry*, 56, 600–606.
- Kandel, E. R. (1999). Biology and the future of psychoanalysis: A new intellectual framework for psychiatry revisited. *American Journal of Psychiatry*, 156, 505–524.
- Kauffman, E., Dore, M. M., & Nelson-Zlupko, L. (1995). The role of women's therapy groups in the treatment of chemical dependence. *American Journal of Orthopsychiatry*, 65, 355–363.
- Merkatz, R. B., Temple, R., Sobel, S., Feiden, K., Kessler, D. A., and the Working Group on Women in Clinical Trials. (1993). Women in clinical trials of new drugs. *New England Journal of Medicine*, 329, 292–296.
- Notman, M. T., Klein, R., Jordan, J. V., et al. (1991). Women's unique developmental issues across the life cycle. In A. Tasman, S. M. Goldfinger (Eds.), *American Psychiatric Press Review of Psychiatry* (Vol. 10, pp. 556–577). Washington, DC: American Psychiatric Press.
- Schwartz, J. M., Stoessel, P. W., Baxter, L. R., Martin, K. M., & Phelps, M. E. (1996). Systematic changes in cerebral glucose metabolic rate after successful behavior modification treatment of obsessive-compulsive disorder. *Archives of General Psychiatry* 53, 109–113.
- Weissman, M. M. (1991). Gender differences in the rates of mental disorder. In *Assessing future research needs: Mental and addictive disorder in woman*. Washington, DC: Institute of Medicine.

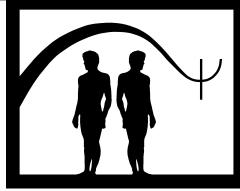

Working Alliance

Georgiana Shick Tryon

City University of New York Graduate School and University Center

- I. Overview of the Working Alliance
 - II. Theoretical Bases of the Working Alliance
 - III. Empirical Studies
 - IV. Summary
- Further Reading

I. OVERVIEW OF THE WORKING ALLIANCE

For years, researchers conducted numerous studies to determine whether or not various psychotherapies were effective in relieving clients' problems, and if they were, which types of therapy were most effective. Large-scale reviews of these studies in 1994 by Michael Lambert and Allen Bergin, in 1986 by William Shapiro and colleagues, in 1980 by Mary Smith and colleagues, and in 1997 by Bruce Wampold and colleagues established that psychotherapy worked and that there was little difference in the effectiveness of different forms of psychotherapy. Since different types of therapy are virtually equally effective, some researchers have focused on the characteristics that all therapies have in common that contribute to client improvement. These characteristics are known as common factors, because they are procedures or processes that occur in all types of therapy regardless of the theoretical orientation of the therapist.

The working alliance refers to the collaborative relationship between therapist and client where the two establish a bond and agree on the goals of therapy and tasks to be undertaken to achieve them. It is a common factor that impacts outcome across a variety of therapies. Some theorists and researchers even believe that the working alliance is more important to outcome than the type of therapy that the therapist uses. In 1988, in an article on the integration of all forms of

GLOSSARY

- common factors* Procedures and processes that occur in all types of therapies regardless of the theoretical orientation of the therapist.
- effect size* The statistical degree to which differences or relationships between groups exist.
- meta-analysis* A statistical analysis that combines the results of several empirical studies.
- working alliance* Client–therapist bond and agreement on the goals of therapy and tasks to be undertaken to achieve them.
- Working Alliance Inventory (WAI)* A scale that enables assessment of the common alliance factors of client–therapist bond and agreement on goals and tasks of therapy. Ratings may be done by clients, therapists, and outside observers.

The working alliance is a collaborative relationship between client and therapist that is common to all types of therapies and enables therapeutic success. This article presents an overview of the theoretical foundations of the alliance and a review of research on the quality of the alliance and its relationship to therapeutic outcome.

therapy, Barry Wolfe and Marvin Goldfried called the working alliance the “quintessential integrative variable.”

II. THEORETICAL BASES OF THE WORKING ALLIANCE

The concept of working alliance originated in psychoanalytic psychotherapy that is designed to make unconscious conflicts and feelings conscious. The analytic patient relates to the analyst in a distorted manner that mirrors these unconscious conflicts. In 1912, however, Sigmund Freud also posited a positive relationship between the analyst and patient that was based in the reality of their work together. This relationship later became known as the working alliance.

To humanistic therapists who believe that people are capable of helping themselves if they are provided with a facilitating relationship, the working alliance is both necessary and sufficient for client improvement. According to Carl Rogers in 1957, the therapist was responsible for creating this facilitating relationship by demonstrating empathy, genuineness, congruence, and unconditional positive regard toward the client. Within this accepting environment, the client was then able to achieve self-acceptance and self-actualization. This relationship would then generalize to other relationships outside of therapy. Thus, for Rogers, the working relationship was directly responsible for client improvement.

Behavioral and cognitive-behavioral therapy, which are based on learning principles, did not originally address the client–therapist relationship. In 1977, however, the Association for Advancement of Behavior Therapy (AABT) published ethical principles for behavior therapists. These principles emphasized client agreement with the goals and methods of treatments that are important components of the working alliance. Thus, most behaviorists and cognitive behaviorists stress the importance of the working alliance.

The working alliance is just one term for the collaborative relationship between client and therapist. Different theorists highlight different aspects of the alliance, and as a result, it is sometimes referred to as the helping alliance or therapeutic alliance. In 1979, Bordin put all the elements of the working alliance together into one conceptualization that applied to all types of theories and therapies. He defined working alliance as a bond between client and therapist and an agreement on the goals of therapy and the tasks necessary to achieve those goals.

III. EMPIRICAL STUDIES

Interest in the working alliance as a common factor in all types of therapies has spawned considerable research. This research is primarily, but not exclusively, concentrated in three areas: assessment of the alliance, the relationship of the alliance to outcome, and changes in the alliance across time.

A. Alliance Assessment

Because different researchers emphasize different aspects of the working alliance, they have developed scales to measure the alliance that reflect their theoretical interests. For instance, in the 1980s, Lester Luborsky and his colleagues at the University of Pennsylvania developed what are now known as the Penn Scales to assess client, therapist, and observer perspectives of the helping alliance. Also in the 1980s, Charles Marmar and Elsa Marziali and their colleagues developed the Therapeutic Alliance Rating Scale (TARS), and in 1989, Marmar and colleagues revised the TARS and named the new scale the California Psychotherapy Alliance Scales (CALPAS). In 1983, D. E. Hartley and Hans Strupp developed the Vanderbilt Therapeutic Alliance Scale (VTAS), and in 1989, Stephen Saunders and his colleagues developed the Therapeutic Bond Scales (TBS).

Each of these scales was based on the different theoretical conceptualizations of the working alliance, but most also incorporated Bordin’s integrative formulations. One scale, however, was developed to specifically assess Bordin’s conceptualizations. It is the Working Alliance Inventory (WAI) and was created in 1986 by Adam Horvath and Leslie Greenberg. It allows an overall alliance score and its three scales separately assess the therapeutic bond, agreement on goals, and agreement on tasks—the three dimensions of the working alliance identified by Bordin. The original WAI is 36 items long, with 12 items in each scale. In 1990, Terence Tracey and Anna Kokotovic developed a short form of the WAI that has 12 items.

Because they were designed to assess the same thing, the various working alliance instruments have been found by researchers, such as Victoria Tichenor and Clara Hill in 1989, to be highly positively correlated. In 2000 in a statistical analysis that combined the results of 79 empirical studies, using meta-analytic strategies. Daniel Martin and his colleagues found that each of these scales is associated with good reliability. With the exception of the TARS, each of the scales also related positively and significantly to therapy outcome. Thus,

researchers investigating the working alliance could use any of these scales, with the exception of the TARS, in their inquiries with confidence. Martin and colleagues suggest, however, that the WAI is an appropriate choice for most investigations because of its applicability to all theoretical perspectives.

B. Relationship of Working Alliance to Therapeutic Outcome

The numerous studies relating the working alliance to various types of outcome (i.e., ratings of patient improvement, type of termination) are summarized by two meta-analyses. The first was a meta-analysis of 24 studies done in 1991 by Adam Horvath and Dianne Symonds. They found that the working alliance was moderately positively related to therapy outcome. The effect size, or the statistical degree to which working alliance and therapy outcome were related, was .26. Their findings applied regardless of the length of the treatment, the number of clients in each sample, and whether or not the study was published.

The recent meta-analysis in 2000 by Daniel Martin, John Garske, and Katherine Davis also found a moderate positive relationship between working alliance ratings and treatment outcomes. The effect size was .22. This meta-analysis corrected for some factors that might reduce effect size in the studies reviewed, but it did not correct for other factors (such as test reliability and validity). As a result, the effect size is an underestimate. This means that the impact of the working alliance is greater than the meta-analysis reported.

This relationship between alliance and outcome was obtained regardless of who did the alliance ratings (therapist, client, or observer), who rated the outcome (therapist, client, or observer), what outcome measure was used, the time in therapy that the alliance was assessed (earlier or later in treatment), the publication status of the research (21 studies of the 79 studies in the analysis were unpublished, 58 were published), or the type of therapy provided. Thus, Martin and colleagues' meta-analysis provided support for the inference that the working alliance is a common factor associated with outcome for all types of therapies.

C. Changes in the Working Alliance across Time

In their 1985 article on the relationship in psychotherapy, Charles Gelso and Jean Carter emphasized the importance of establishing a positive working alliance early

in treatment so that the alliance would sustain the relationships through the difficult periods in treatment. They believed that the alliance becomes disrupted in the middle phase of therapy when most intense work on behavior and attitude change is undertaken. The alliance was then assumed to recover to more positive levels later in therapy.

The 1991 meta-analysis by Horvath and Symonds provided some support for this perspective. They found a larger effect size between working alliance and outcome in studies where the assessment of the working alliance was done early in treatment session than for studies that assessed alliance in the middle phases of treatment.

The 2000 meta-analysis by Martin and colleagues did not support the formulation that successful treatment is associated with a better working alliance at the beginning and end than in the middle of treatment. The relationship between working alliance and outcome was not influenced by the time in treatment when the alliance was assessed, and, as stated earlier, the alliance–outcome relationship is also not influenced by type of therapy used. The findings of Martin and colleagues' meta-analysis support the perspective advanced by Carl Rogers that the working alliance is itself therapeutic. Thus, if a good working alliance is established, client, therapist, and external observers will perceive the client's problems as improved.

IV. SUMMARY

When clients come to therapy, they expect to find therapists with whom they can develop a close relationship. They expect that their therapists will want the same outcomes for them that they want for themselves, and they expect that therapists will suggest ways to attain these goals that they will find acceptable. These are the elements of the working alliance endorsed by most theorists and researchers—client and therapist bond and agreement on the tasks and goals of therapy. The strength of the working alliance may be assessed by giving clients and therapists any of several instruments, but the Working Alliance Inventory is recommended because it was specifically designed to assess client–therapist bond, agreement on tasks, and agreement on goals as well as the overall alliance.

Research results confirm that the working alliance is a common factor in all types of successful therapies. If the working alliance between client and therapist is positive, the outcome of therapy will be positive. If the

alliance is negative, the client will not improve and may even leave therapy before it is finished. Moreover, it could be said that the working alliance is itself a therapy. If they are part of a good working alliance, clients will improve regardless of what type of therapy is being conducted or when in therapy the alliance is assessed. These research results indicate that specific training in the establishment of positive working alliances should be done in all graduate programs regardless of the theoretical emphasis of the program.

See Also the Following Articles

Bioethics ■ Confidentiality ■ Engagement ■ Informed Consent ■ Integrative Approaches to Psychotherapy ■ Rational Emotive Behavior Therapy ■ Resistance ■ Termination ■ Working Through

Further Reading

- Constantino, M. J., Castonguay, L. J., & Schut, A. J. (2002). The Working Alliance: A Flagship for the “Scientist-Practitioner” Model in Psychotherapy. In G. S. Tryon (Ed.), *Counseling based on process research: Applying what we know*. Boston, MA: Allyn & Bacon.
- Greenberg, L. S., & Pinsof, W. M. (Eds.). (1986). *The psychotherapy process: A research handbook*. New York: Guilford.
- Martin, D. J., Garske, J. P., & Davis, M. K. (2000). Relation of the therapeutic alliance with outcome and other variables: A meta-analytic review. *Journal of Consulting and Clinical Psychology, 68*, 438–450.
- Tracey, T. J. G. (2002). Stages of counseling and therapy: An examination of complementarity and the working alliance. In G. S. Tryon (Ed.), *Counseling based on process research: Applying what we know*. Boston, MA: Allyn & Bacon.

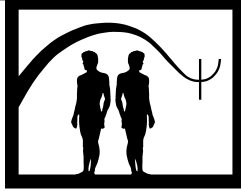

Working Through

Mark J. Sedler

State University of New York, Stony Brook

- I. Definition
 - II. Freud's Theory
 - III. Perspectives on Working Through
 - IV. Summary
- Further Reading

GLOSSARY

- insight* Understanding acquired in therapy that connects general themes with particular actions and emotions.
- resistance* Term that refers to a variety of intrapsychic forces that impede the progress of therapy.
- working through* A psychoanalytic concept that describes the effort by patient and therapist of overcoming resistance and effecting change.

I. DEFINITION

The psychotherapeutic concept of “working through” originated as a psychoanalytic construct that accounted for the failure of correct interpretive work to immediately result in symptom resolution and character change. It simultaneously invokes the fact that therapy takes time and that patience and persistence on the part of the therapist must be matched by active perseverance and effort on the part of the patient. If therapy is to produce genuine changes in patterns of thinking, feeling, and behavior then a process of transformation must take place, a process that achieves both self-understanding and that neutralizes the countervailing forces of inertia and

defense. Although working through has at times seemed almost an afterthought for theorists, an epiphenomenon of the analytic work, others have viewed it as the quintessential activity that defines successful psychotherapy. Working through names the struggle to crystallize the insights gleaned from meticulous self-examination, to connect these insights not only to their putative origins, but to trace their consequences throughout one’s subjective and interpersonal experience in an effort to establish a healthier, less fettered, character. This takes time and is often an elusive and arduous goal to reach. The tendency to reenact long-established patterns is not easily undone. In other words, therapy takes work and commitment if it is to result in something more profound than glib self-awareness, which is to say substantive change.

II. FREUD’S THEORY

Freud first makes reference to the notion of “working through” in his paper on technique “Remembering, Repeating, and Working Through” written in 1914. Troubled by the mounting recognition that often a patient’s resistance persists in spite of the initial disclosures of a correct interpretation, Freud observed that the beginning analyst has

merely forgotten that giving the resistance a name could not result in its immediate cessation. One must allow the patient time to become more conversant with

this resistance with which he has now become acquainted, to work through it, to overcome it, by continuing in defiance of it, the analytic work according to the fundamental rule of analysis.

What the beginning analyst had forgotten was not always apparent even to Freud. In the early days of psychoanalysis, the work of therapy was admittedly “laborious and time-consuming for the physician” but the effort expended was directed toward bringing the pathogenic ideas to consciousness. The resistance of the patient was primarily a matter of repression; once the ideas were successfully retrieved and exposed to the light of conscious awareness symptom resolution followed in short order. Typically, this revelation was accompanied by an “abreaction” of affect associated with the offending idea. Where this failed, the affect was found to have been embedded in a series of affiliated memories and associations and only by a comprehensive “working over” of the pathogenic material could the symptoms be disposed of once and for all. This earlier term, “working over,” was a prototype for the subsequent concept of working through and signified early on the fact that analytic progress is not always straightforward, even when it seems to be going well.

Clearly, resistance plays a key role in the analytic view of therapy and it is the antinomy of working through. In Freud’s formulation working through engages the resistance once the patient has become acquainted with it. By its very nature resistance is an unconscious adversary that operates by subterfuge and stealth. It is protean in its manifestations and may appear as a failure to produce meaningful disclosures, as faulty remembering, by tenacious distortions and misconstructions, or through the distractions of a robust transference. This latter resistance was paradigmatic for Freud who was preoccupied with the dynamics of the transference throughout his papers on technique (1910–1919). Originally derived from techniques that employed suggestion, the psychoanalytic method first recognized in the transference a means of securing the cooperation of the patient and thus of facilitating the analytic work. Although there is no doubt that some degree of positive transference is indispensable to the progress of therapy, Freud learned from experience that transference is the “strongest weapon of the resistance.” As a result of this discovery, the analysis of the transference proved to be a critical step in acquainting the patient with the fact of his resistance. Freud observed:

Only when the resistance is at its height can the analyst, working in common with his patient, discover the

repressed instinctual impulses which are feeding the resistance; and it is this kind of experience which convinces the patient of the existence and power of such impulses.

In this way the patient becomes aware of the resistances and their associated impulses. Becoming conversant with these manifestations constitutes the first phase of working through proper. This phase is time-consuming because recognizing resistances requires deep understanding and an appreciation for the common themes that run through what may appear on the surface to be totally unrelated attitudes and behaviors. It is this exercise that ultimately establishes insight.

Although the resistance exhibited in the transference may have been uppermost in Freud’s thinking at the time he first wrote of working through, his subsequent deliberations on resistance called attention to the threat posed by the tendency to repeat. Freud had written variously of the “pertinacity of early impressions,” of “psychical inertia,” “fixation,” and the “adhesiveness of the libido.” All of these terms referred, in one way or another, to an obstinacy or lack of mobility on the part of the libido, its reluctance to give up its objects or to change its course. Writing of the general *modus operandi* of analytic treatment in the Introductory Lectures, Freud (1917) remarked:

The more closely events in the treatment coincide with this ideal description, the greater will be the success. . . . It finds its limits in the lack of mobility of the libido, which may refuse to leave its objects. . . .

Freud traced this obstinacy on the part of neurotic fixations to the “resistance from the id” and its manifestation he termed the “compulsion to repeat.” Even after the ego resistance has been identified and the pathogenic material rendered visible, the tendency to repeat remains. Thus, Freud observed in his *Inhibitions, Symptoms and Anxiety* in 1926:

For we find that even after the ego has decided to relinquish its resistances, it still has difficulty in undoing the repressions; and we have called the period of strenuous effort which follows after its praiseworthy decision, the phase of “working-through.” The dynamic factor which makes a working-through of this kind necessary and comprehensive is not far to seek. It must be that after the ego-resistance has been removed the power of the compulsion to repeat—the attraction exerted by the unconscious prototypes upon the repressed instinctual process—has still to be overcome. There is nothing to be said against describing this factor as the *resistance of the unconscious*.

In other words, what Freud discovered was that even after the patient has gained an awareness of his resistances and the pathogenic impulses underlying them, the perennial therapeutic imperative—"let go and move on"—is far easier said than accomplished. The resistance from the unconscious manifested by the repetition-compulsion remains to be dealt with. Overcoming this deeply mired complex of resistances represents an aspect of working through that differs from that involved in the acquisition of insight. Faced with the inherently conservative nature of the drive derivatives motivating neurotic life, the ego engaged in working through must wrest itself free from these bonds in order to foster meaningful change. The contest would appear not to be a matter of insight or of understanding, but of brute force. Knowing that one is, by nature, subject to the law of gravity does not help one to escape its influence. Only by overcoming this force can one move out of its orbit.

It is not surprising, then, that Freud in 1940 concluded the chapter on technique in his posthumously published *Outline of PsychoAnalysis* by remarking that:

We shall not be disappointed, but, on the contrary, we shall find it entirely intelligible, if we reach the conclusion that the final outcome of the struggle we have engaged in depends on *quantitative relations*—on the quota of energy we are able to mobilize in the patient to our advantage as compared with the sum of energy of the powers working against us.

This conclusion suggests that working through is nothing less than a heroic process, one that calls for overcoming, defiance, and perseverance. Indeed, the decision to continue the analytic work over and against all such forces to the contrary Freud deemed "praiseworthy." And, not inconsequentially so, for Freud conceded from the outset that working through names that "part of the work which effects the greatest changes in the patient and which distinguishes analytic treatment from any kind of treatment by suggestion."

III. PERSPECTIVES ON WORKING THROUGH

Given the obvious importance of working through to the outcome of psychotherapy it remains a curiosity that Freud devoted so little actual discussion to the problem. One explanation may be that working through is as pervasive in actual practice as it is intangible and that Freud could only invoke it as the ineffa-

ble ingredient that distinguished analysis terminable from analysis interminable. Any attempt to define it further immediately devolves into a discussion of technique, or of metapsychology.

Of course, subsequent theorists have intermittently elaborated on the concept and have generated a series of sometimes divergent positions. Not surprisingly, these elaborations typically reflect the differing approaches to technique or theory espoused by their authors. Classically, Otto Fenichel in 1945 viewed working through from the analyst's point of view, that is, as a problem in technique.

Systematic and consistent interpretive work, both within and without the framework of the transference, can be described as educating the patient to produce continually less distorted derivatives until his fundamental instinctual conflicts are recognizable. Of course, this is not a single operation resulting in a single act of abreaction; it is, rather, a chronic process of working through, which shows the patient again and again the same conflicts and his usual way of reacting to them but from new angles and in new connections.

Others such as W. Stewart in 1963 and M. Sedler in 1983 emphasized the patient's contribution to the process. P. Greenacre in 1956 conceived of working through as a "working out" of residual infantile traumas and memories that could not be adequately reconstructed or resolved solely by an analysis of current defenses. In 1991 L. Aron proposed the term "working toward" in an effort to "capture the sense of the work of both patient and analyst as co-participants in the analytic process. Patient and analyst not only work toward a new and corrective relationship, but work toward making the nuances of that relationship explicit..." Transcending such positions, Charles Brenner presented a view of working through that underscored its ubiquity in the analytic process. He argued simply that "working through is not a regrettable delay in the process of analytic cure. It is analysis. ... The analysis of psychic conflict in all of its aspects is what should properly be called working through."

Generally, there is agreement that working through is a concept made necessary in order to explain, "Why does psychoanalysis take so long?" Posing just this question, Charles Brenner in 1987 helped us perhaps to understand Freud's reticence on the subject by answering candidly, "we do not know." Brenner observed:

that such analysis takes time, all analysts know. Why it takes as much time as it does is a question which remains

as yet unanswerable. However, we also know that when analytic work proceeds favorably—when working through is successful—it results in psychic changes which are of inestimable value to the patient and which no other form of psychotherapy can achieve.

III. SUMMARY

Many of the basic truths about character pathology, neurotic symptoms, and the possibilities for meaningful change discovered in the era of psychoanalysis have been obscured by the subsequent proliferation of derivative psychotherapies. Nevertheless, the promises and predictable results of “brief therapy” cannot negate the fundamental lessons about mental life learned from our experience of psychoanalysis. Serious conflicts rooted in the soil of constitutional factors and infantile residues are not easily brought to light, and are even less easily resolved. The method of psychoanalysis is a notoriously protracted one and its results are uncertain. For these reasons its popularity and its credibility have suffered. Nevertheless, the challenges defined by working through show why it must be so: Failures, uncertainty, struggle, and hope are facts of the human condition. Technical innovations in psychotherapy are not likely to

fundamentally alter this reality. Insofar as the original meaning of “working through” has been assimilated by this psychotherapeutic pluralism, there may be a general understanding that successful therapy requires both time and hard work. At the same time, this assimilated meaning most likely designates the process only in its most generic sense, that is, as the struggle to replace one set of personal characteristics with another. In any context this is not an easy business.

See Also the Following Articles

Engagement ■ Outcome Measures ■ Relapse Prevention
 ■ Resistance ■ Termination

Further Reading

- Brenner, C. (1987). Working through: 1914–1984. *Psychoanalytic Quarterly*, *LVI*, 88.
- Cooper, A. (1989). Working through. *Contemporary Psychoanalysis*, *25*, 34.
- Freud, S. (1914). Remembering, repeating, and working through. *Standard Edition*, *12*, 145, London; Hogarth, 1959.
- Sedler, M. (1983). Freud's concept of working through. *Psychoanalytic Quarterly*, *LII*, 73.