



**BRITISH SCHOOL OF ARCHAEOLOGY
IN EGYPT**

AND EGYPTIAN RESEARCH ACCOUNT
FOURTEENTH YEAR, 1908

MEMPHIS I.

BY

W. M. FLINDERS PETRIE

WITH A CHAPTER BY

J. H. WALKER

LONDON

SCHOOL OF ARCHAEOLOGY IN EGYPT
UNIVERSITY COLLEGE, GOWER STREET, W.C.

AND

BERNARD QUARITCH
11, GRAFTON STREET, NEW BOND STREET, W.

1909

N

51-

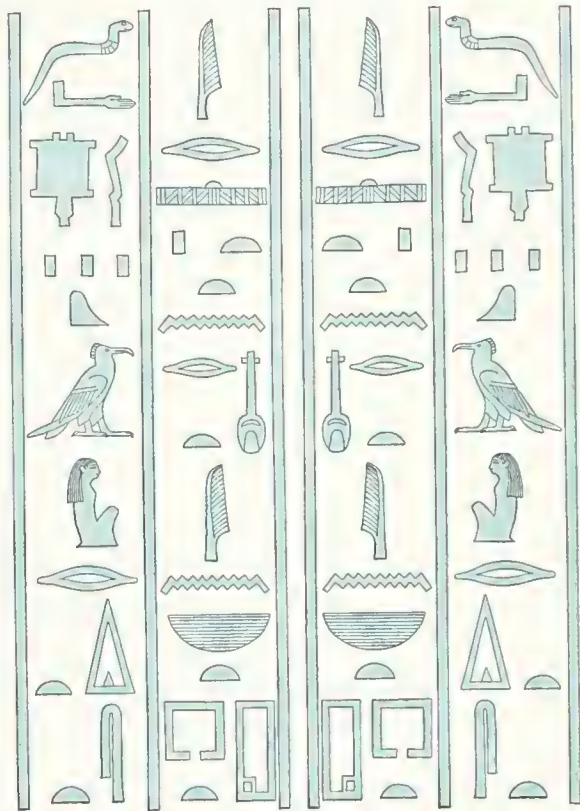

BRITISH SCHOOL OF ARCHAEOLOGY IN EGYPT
AND EGYPTIAN RESEARCH ACCOUNT
FOURTEENTH YEAR, 1908

MEMPHIS I

BY

W. M. FLINDERS PETRIE

HON. D.C.L., LL.D., LITT.D., PH.D.

F.R.S., F.B.A., HON. F.S.A. (SCOT.)

MEMBER OF THE ROYAL IRISH ACADEMY

MEMBER OF THE IMPERIAL GERMAN ARCHAEOLOGICAL INSTITUTE

CORRESPONDING MEMBER OF THE SOCIETY OF ANTHROPOLOGY, BERLIN

MEMBER OF THE ROMAN SOCIETY OF ANTHROPOLOGY

MEMBER OF THE SOCIETY OF NORTHERN ANTIQUARIES

MEMBER OF THE AMERICAN PHILOSOPHICAL SOCIETY

EDWARDS PROFESSOR OF EGYPTOLOGY, UNIVERSITY OF LONDON

WITH A CHAPTER BY

DR. J. H. WALKER

LONDON

SCHOOL OF ARCHAEOLOGY IN EGYPT
UNIVERSITY COLLEGE, GOWER STREET, W.C.

AND

BERNARD QUARITCH

11, GRAFTON STREET, NEW BOND STREET, W.

1909

DT 57. B8

no. 15 c. 2

PRINTED BY
HAZELL, WATSON AND VINEY, LD.,
LONDON AND AYLESBURY

25 Feb 1911

BRITISH SCHOOL OF ARCHAEOLOGY IN EGYPT, AND EGYPTIAN RESEARCH ACCOUNT

Patron:

THE EARL OF CROMER, G.C.B., G.C.M.G., K.C.S.I., Etc., Etc.

GENERAL COMMITTEE (**Executive Members*)

LORD AVEBURY	*Prof. ERNEST GARDNER	Sir C. SCOTT MONCRIEFF
WALTER BAILY	Prof. PERCY GARDNER	ROBERT MOND
HENRY BALFOUR	Rt. Hon. Sir G. T. GOLDIE	Prof. MONTAGUE
FREIHERR VON BISSING	Prof. GOWLAND	WALTER MORRISON
Dr. T. G. BONNEY	Mrs. J. R. GREEN	Prof. P. E. NEWBERRY
Rt. Hon. JAMES BRYCE	Dr. A. C. HADDON	Dr. PAGE MAY
Prof. J. B. BURY	JESSE HAWORTH	F. W. PERCIVAL
*SOMERS CLARKE	Dr. A. C. HEADLAM	Dr. PINCHES
EDWARD CLODD	*Sir ROBERT HENSLEY (<i>Chairman</i>)	Dr. G. W. PROTHERO
W. E. CRUM	D. G. HOGARTH	Dr. G. REISNER
Prof. BOYD DAWKINS	Sir H. H. HOWORTH	Sir W. RICHMOND
Prof. S. DILL	Baron A. VON HÜGEL	Prof. F. W. RIDGEWAY
*Miss ECKENSTEIN	Prof. MACALISTER	Mrs. STRONG
Dr. GREGORY FOSTER	Dr. R. W. MACAN	Mrs. TIRARD
Dr. J. G. FRAZER	Prof. MAHAFFY	E. TOWRY WHYTE
ALAN GARDINER	*J. G. MILNE	

Treasurer—(In course of election)*

Honorary Director—Prof. FLINDERS PETRIE

*Honorary Secretaries—Mrs. HILDA PETRIE and *Dr. J. H. WALKER.*

The need of providing for the training of students is even greater in Egypt than it is in Greece and Italy; and the relation of England to Egypt at present makes it the more suitable that support should be given to a British School in that land. This body is the only such agency, and is also the basis of the excavations of Prof. Flinders Petrie, who has had many students associated with his work in past years. The great enterprise of the excavation of the temples and city of Memphis, which has now been undertaken, promises the most valuable results. But it will necessarily be far more costly than any other work in Egypt, and it cannot be suitably carried out without increasing the present income of the School. Active support is required to ensure the continuance of such work, which depends entirely on personal contributions, and each subscriber receives the annual volume. The antiquities not retained by the Egyptian Government are presented to Public Museums, after the Annual Exhibition, during July, at University College. The accounts are audited by a Chartered Accountant, and published in the Annual Report. Treasurer: c/o H. PRICE, Child's Bank, 1, Fleet Street, E.C.

ADDRESS THE HON. SECRETARY,

BRITISH SCHOOL IN EGYPT, UNIVERSITY COLLEGE,

GOWER STREET, LONDON, W.C.

CONTENTS

INTRODUCTION

CHAPTER IV

SECT.	PAGE
1. Circumstances of the work	1

CHAPTER I

THE RECORDED TEMPLES OF MEMPHIS.

2. Size of the city	1
3. Its history	2
4. The temple of Ptah. Pl. I	2
5. The temple of Apis	3
6. Temples of Hathor, Neit, etc.	3
7. The temple of Proteus and the foreigners	3
8. Temples of Osiris, Khnum, etc.	4
9. Other foreign settlements	4
10. Outline of excavations	4

CHAPTER II

THE WEST HALL OF PTAH.

11. State of the site. Pl. II	5
12. The skew front	5
13. The colossi	5
14. The passages and walls	6

CHAPTER III

THE MONUMENTS. XVIIITH DYNASTY AND EARLIER.

15. Gateway of Ranuser, etc. Pl. III	6
16. Lintel of Tetu	6
17. Lotus capitals	6
18. Altar and endowment stele. Pls. IV, V, VI	6
19. Small tablets. Pls. VII, VIII, IX	7
20. Ear tablets. Pls. X, XI, XII, XIII	7
21. Other tablets. Pls. XIV, XV, XVI, XVII	8
22. Altar and statuettes. Pls. XVIII, XIX	8

THE MONUMENTS. XIXTH DYNASTY.

SECT.	PAGE
23. Foundation deposit. Pl. XIX	8
24. False doors. Pl. XX	8
25. Views of West Hall. Pl. XXI	9
26. Detail of West Hall. Pl. XXII	9
27. Colossi. Pl. XXIII	10
28. Reliefs. Pl. XXIV	10
29. Columns. Pl. XXV	10
30. Inscriptions. Pl. XXVI	10
31. Plans. Pl. XXVII	10

CHAPTER V

THE TEMPLE OF MERENPTAH.

32. Condition of remains	11
33. The court. Pl. XXVII	11
34. The town around	11
35. The small objects. Pl. XXVIII	12

CHAPTER VI

THE LATER ANTIQUITIES.

36. Small objects. Pls. XXVIII, XXIX	12
37. Great gate of camp	12
38. Building of Siamen, etc.	12
39. Breccia statue. Pls. XXXI, XXXII	13
40. Stele and stone-working. Pl. XXXIII	13
41. Scarabs. Pl. XXXIV	13
42. Late sculpture. Pl. XLV	14
43. Blue-glazed pottery. Pls. XLVI—L	14
44. Objects from Athribis. Pls. LI, LII	15
45. Inscriptions from Rifeh, etc. Pls. LIII, LIV	15

CHAPTER VII

THE TERRA-COTTA HEADS.

SECT.	PAGE
46. Date of the heads	15
47. Egyptians. Pl. XXXV	16
48. Persians and Syrian. Pl. XXXVI	16
49. Babylonians, etc. Pls. XXXVII, XXXVIII	16
50. Indians. Pl. XXXIX	17
51. Scythians. Pl. XL	17
52. Greeks, etc. Pls. XLI—XLIV	17

INDEX 23

CHAPTER VIII

THE INSCRIPTIONS.

By DR. J. H. WALKER.

SECT.	PAGE
53. Endowment stele. Pl. V	18
54. XVIIIth dynasty stele. Pl. VI	18
55. Ptah steles. Pls. VIII—XVII	19
56. Altar of Amenhotep. Pl. XVIII	20
57. Inscriptions of Ramessu II. Pl. XXVI	20
58. Breccia statue. Pl. XXXII	20
59. Coptic inscriptions. Pls. LII—LIV	21

INDEX 23

LIST OF PLATES

WITH PAGE REFERENCES TO THE DESCRIPTIONS

	PAGE		PAGE
I. Sketch plan of Memphis	1-4	XXIX. Jamb of Merenptah, etc.	11, 12
II. Plans of West Hall	5, 6	XXX. Small plans	12
III. Sculptures. Vth—VIth dynasties	6	XXXI. Siamen lintel, Hap-amu	12, 13
IV. Granite altar of Uah-ka. XIIth dynasty?	6	XXXII. Inscription of Hap-amu	13, 20
V. Endowment stele. XIIth dynasty 6, 7, 17, 18		XXXIII. Stele and trial-pieces, etc.	13
VI. Quartzite stele. XVIIIth dynasty 7, 18		XXXIV. Scarabs	13
VII. Tablets of Tahutmes I and IV	7, 19	TERRA-COTTA HEADS	
VIII. " " " IV	7, 18, 19	XXXV. Egyptian	16
IX. Ear tablets. XVIIIth dynasty 7, 19		XXXVI. Persian	16
X. Tablets with one and two ears	7, 19	XXXVII. Babylonian	16
XI. " " two to five ears	7, 19	XXXVIII. Unknown foreigners	16
XII. " " four to ten ears	7, 19	XXXIX. Indian	17
XIII. " " many ears	7, 19	XL. Scythian	17
XIV. " of Ptah	8, 19	XLI. Italian and Greek	17
XV. " " Ptah and gods	8, 19	XLII. Classical Greek	17
XVI. " " Amen and private	8, 20	XLIII. " "	17
XVII. Tablet of Huy	8, 20	XLIV. Rude figures	17
XVIII. Altar of Amenhotep	8, 20	XLV. Head of Physkon, stone-working, etc.	14
XIX. Foundation deposits, and Ray	8	XLVI. Pottery about 300 B.C.	14
XX. Tahutmes IV pots, false doors, etc.	8	XLVII. " " " and lamps	14
XXI. Temple of Ptah, views	9	XLVIII. Pottery found with lamps	14
XXII. " parts of West Hall	9	XLIX. Glazed pottery and kiln	14, 15
XXIII. " statues and bases	9	L. Forms of glazed pottery	15
XXIV. " head of Ptah, etc.	10	LI. Athribis, small objects	15
XXV. Pieces of columns	10	LII. " Coptic pottery	15, 21
XXVI. Pieces of sculpture	10, 20	LIII. Coptic inscriptions	15, 21
XXVII. Plans of Merenptah temple, etc.	10	LIV. " "	15, 21
XXVIII. Small objects, Merenptah temple, etc. 11, 12			

MEMPHIS I

INTRODUCTION

I. THE work at Memphis stands on a footing different from any previous excavations of mine. A season is only time enough to sample various parts of such a site, and no subject there can be worked out in less than two or three years. To clear the temple sites alone would take probably twenty years, as it is only possible to work for a few weeks after the water has subsided. But the rapidly increasing difficulties, owing to the constant and unchecked appropriation of the site by the peasantry, make it all the more urgent to take the place in hand as soon as we can. I long hesitated about this excavation. Two years ago Prof. Maspero suggested it to me, and the next year Sir William Garstin urged the desirability of it. At last the position of the British School of Archaeology seemed so solid that we ventured to attack so large a work. But it will need a considerable budget, owing to the cost of labour on such a scale, and the difficulties of private ownership.

As we hope to be for many years on the site during the spring months (minor excavations elsewhere will occupy the winters), it was needful to build quarters raised well above the damp soil. Mr. Ward and Herr Schuler accordingly went there on Jan. 3 to begin building, and I followed on Jan. 26; before the middle of February our quarters were finished amid the rain, mud, and fogs which abound at that time of year. Our excavations started at the end of January, and went on till the first week in May. Mr. Ward took charge of the Merenptah temple, and other work to the south. Mr. Mackay attended to the Ptah temple and the great fort. Herr Schuler did some surveying. Mr. Wainwright drew many of the plates here published, and Mr. Gregg planned the small temple. Altogether about three months of full work was spent on the place, and a fair beginning of this great undertaking was well started. I have to thank Miss Herford for inking in several plates of pencil drawings.

CHAPTER I

THE RECORDED TEMPLES OF MEMPHIS.

2. IN beginning to examine so great a city as Memphis, it is needful to glean all the information we can from ancient authorities for our guidance. References in the inscriptions, and the account by Herodotos, are nearly all that remain to help us. Diodoros mainly copied from Herodotos, and only yields a few further points; and Strabo is unfortunately very brief about Memphis.

The whole size of the city is stated to have been 150 stadia in circumference (Diod. i, iv); if Greek stadia, this equals $17\frac{1}{4}$ miles. But as the delta is described as being 750 stadia at the side, and 1300 along the sea (lengths of about 120 and 210 miles), this would imply the use of a stadium of just

500 cubits of 20.6 inches. If this Egyptian measure was used, the 150 would equal $24\frac{1}{2}$ miles. The plain was about 4 miles wide, so the two ends of the city would be 8 miles, leaving either 9 or 16 miles for the sides, according to the stadium used, making it $4\frac{1}{2}$ or 8 miles long. The latter is apparently correct; the length of the cemeteries along the desert suggests about 8 miles for the city, from Dahshur to the north of Abusir. The south side was probably at a fortress, now Kafr el Qala', opposite Dahshur; and the north side would then be at the group of villages by El Manawat. This would be the size of northern London from Bow to Chelsea, and from the Thames up to Hampstead. Probably a large part of this area consisted of gardens and fields belonging to the various villages, which were agglomerated to form the capital, like the component villages and towns of London.



3. The history of this capital of Egypt extends from the first king to the last Roman emperor. Menes founded Memphis; and the Roman governor, John Makaukas, signed the capitulation to the Arabs in its palace. From the beginning to the end of Egyptian history, Memphis was the great centre of civilisation, government and trade. For a few centuries Thebes shared its importance, and it was eclipsed at the last by Alexandria, but those cities are only episodes in the six thousand years of national life.

In such a centre it was natural that the gods of many different cities should have a home, and the temples of nineteen gods are mentioned in various sources. The oldest object of worship was probably the bull Apis, a part of the veneration of animals which preceded the higher theistic ideas. The temple of Apis was therefore the primitive settlement of the place. But it was eclipsed by the great establishment of Ptah, which occupied as large a space as the enclosure of the temple of Amen at Karnak.

4. The position of the temple of Ptah is certain, as his statues have been found in the West Hall (Pl. I), and the boundaries of his temenos have been traced on all sides during the past winter. In referring to the sketch map here provided, it should be stated that it is mainly copied from the map of Lepsius (*Denkmäler*, i, 9) as that shews the mounds when more complete than at present; but the temenos of Ptah is inserted from recent measurements plotted on to the government survey of the fields. When more is known, an exact survey of the whole site will be prepared, but it is useless to make that until the ancient constructions are discovered.

Several different parts of the temple of Ptah are mentioned by Herodotos. The first building of the temple is attributed to Menes (H. ii, 99). Next Asychis "built the eastern propylaia to the temple of Ptah, which is far the most beautiful and the largest: for all the propylaia have sculptured figures, and other styles of buildings, but this by far the most" (H. ii, 136). This king succeeded Menkaura of the IVth, and preceded Nitaqert of the VIth dynasty; he is probably Aseskaf of the IVth dynasty. The fine reliefs of the IVth dynasty are what would be appreciated by a Greek of the age of Pheidias; and this description shews that such sculpture was still existing down to the Persian age, and therefore may yet be found. The eastern front would naturally be built first as being the usual entrance to a temple

from the river. This may have been the forecourt added on to the first building of Menes.

Next we read that Moiris (Amenemhat III) built the propylaia on the north (H. ii, 101). This was probably where XII is marked on the map (Pl. I), as large blocks of red granite are lying about there, and an entrance more to the east would only open on to the lake.

In the XIXth dynasty we read of a statue of Sety I (Breasted, *Records*, iii, 260). Sesostris (Ramessu II) is said to have brought great stones to the temple (H. ii, 108), and to have built a forecourt on the north, and a temple in the midst of the temenos (B. *Rec.* iii). In front of the temple he placed two statues of thirty cubits of himself and his wife, and others of his four sons, each of twenty cubits (H. ii, 110). One of these is doubtless the well-known colossus, the place of which is marked on the map. So the main entrance during the Persian age must have been that to the south.

Ramessu III built a new temple in the court, of granite below and limestone above, and its doorways of granite. He made a monolith shrine of granite containing the triad of Ptah, Sekhmet and Nefertum; and he made a new image, and new sacred bark for the processions. Also he rebuilt the ruined temples (Harris Pap.). Rhampsinitos built the propylaia facing west, the "West Hall" of the map, and set two statues before it twenty-five cubits high (H. ii, 121). The base of one of these statues is visible now.

Psametek I built the propylaia facing the south (H. ii, 153). This is probably where XXVI is marked on the plan, as colossi are known to be buried there, and it would be probable that the work of the XXVIth dynasty would stand in advance of that of the XIXth. Aahmes placed a colossus in front of the temple, which Herodotos saw lying face up; it was seventy-five feet long. Upon the same base stood two colossi each twenty feet high (H. ii, 176). These we should expect to have been south of the XXVI propylaia.

Lastly we find that Ptolemy IV built the propylaia of red granite at the eastern entrance, the dedication of which we partly recovered.

Thus we have seen that though Herodotos divided his statements into their historical positions, yet he has preserved his notes of a circuit round all the gates of the temenos of Ptah; though he did not—and probably could not—describe anything that was inside the sacred enclosure. Incidentally Strabo

mentions a great hypostyle hall at Memphis (XVII, i, 21). We learn that the sanctuary of Ptah was included in the White Wall (B.D.G. 725), shewing that probably the fortification included the temples of Apis, Ptah, and the camp. And the temple of Ptah is stated to have been south of the sacred lake (B. *Rec.* iii, 223), which was named Ater (B.D.G. 85). This authorises our placing the sacred lake in the low ground between the Ptah temenos and the camp. Such a position is the more likely, as the sacred lake was the brickpit, whence all the enormous quantity of bricks were dug, for the thick walls, and for the great artificial hill of the fort. So it would naturally be between the two main sites of building, while it thus added a water defence on this side of the camp.

5. The position of the temple of Apis is the next point of importance. Could that be recovered, we might trace a pre-Menite occupation of the site. We read that Psametek when he built his southern propylaia "made an *aulē* (or open court) for Apis, in which he is fed whenever he appears, built opposite to the propylaia, surrounded with a peristyle and full of figures. In place of pillars are colossi of twelve cubits in the court" (H. ii, 153). This distinctly places the temple of Apis opposite to the propylaia of Psametek, and therefore farther south. Strabo states that the temple of Apis was near the temple of Ptah; in front of the sanctuary of Apis was a court where he was exhibited, and in the court another sanctuary for the dam of Apis (S. xvii, i, 31). To the south is marked on the map the presumed site. This ground is abnormally low, like that of the Ptah temenos, shewing that it was a sacred site not occupied by successive houses; and it has the same system of modern fields shewing that the central part was all taken under cultivation at one time, and not gradually encroached upon, as it was round the edges. I have not succeeded in finding the river approach to it along the eastern side. Perhaps the building of Siamen may lead us to some connection. Pa-hennu is the name of the Serapeum of Memphis (B.D.G. 1257). The temple of Apis was much favoured by Ptolemy V (Rosetta inscription, l. 33).

6. The Hathor temple lay to the south, in the time of Ramessu III, and the bark of Ptah went to it by water (Harris Pap.). It was at Nehat, called from the sacred sycamore of the goddess (Pap. Sall. 4, verso p. 1; B.D.G. 1222), and it is named by Strabo (xvii, i, 31).

The temple of Neit seems to have been to the

north of the camp; for as Ptah is said to be south of the fortress, so Neit is said to be north of the fortress. The sign usually translated wall, is clearly shaped as a fortress-plan in the best examples, as on Pl. XXXII. The ground to the north of the camp (see map) was a mass of mounds and ruins in the time of Lepsius; but, like so much of the site, it has been appropriated by the cultivators and is now all covered with crops.

The temple of Amen is mentioned (B. *Rec.* iii, 530); and the only indication of its position is our finding in the south-west corner of the Ptah temenos a fragment of colossal upright feathers, like those worn by Amen. This suggests that his colossus was not far off.

Imhotep was worshipped in a temple, apparently at the Asklepion of Greek times, near Abusir (B.D.G. 1098).

Isis had a spacious temple built by Aahmes (H. ii, 176); and Diodoros—who is a poor authority—states that it was in the grove of Ptah (D. i, 2). Whether that means in the temenos of Ptah is doubtful.

7. The temenos of King Proteus, in the Tyrian camp or foreign quarter, is described by Herodotos as "mightily beautiful and well furnished, lying to the south of the temple of Ptah. Round about the temenos dwell the Phoenician Tyrians, and the whole place is called the Tyrian camp. In this temenos of Proteus is a temple called after the foreign Aphrodite" (H. ii. 112). He then unhappily spends four pages about Helen and the Trojan war, where a few lines more of topography would have been priceless to us. We have already seen that the propylaia of Psametek, and the court of Apis, are said to be south of the temple of Ptah; we cannot then look due south for the temple of Proteus. But south of the entrance to the Ptah temenos, at the Kom el Qala' is a region strewn with early Greek pottery of the VIIth century onward, and bounded by a great wall to the south. Here is the locality, then, best agreeing with the description of the foreign camp. In this ground a great lintel was found two years ago, during the clearances by the *sebakh* diggers and covered over after Mr. Quibell had photographed it. Here we dug down, and saw a great gateway in position, sculptured by Merenptah. Clearing inwards to the north of it, we opened the larger part of a forecourt, 120 feet long by about 100 feet wide; with a doorway of Merenptah at the north end, evidently leading further to a temple (see chap. v).

Proteus came between Ramessu II and III, though his exact identification may not be clear; and he lived a little before the Trojan war, which we know was correlated with the reign of Tausert. The date of Merenptah agrees well with the period indicated by Herodotos. The foreign Aphrodite whose temple was here would be the Egyptian Hathor; and in the court of Merenptah we found the only known Memphite tablets of Hathor (Pl. XXVIII). Thus by the general position in the city, by the early Greek pottery, by the date of the temple, by the Hathor tablets, and by many pieces of prehistoric foreign pottery found here, it seems clear that we have the temple of Proteus before us. It will be excavated next season.

8. Osiris-Sokar had a temple here, in a place named Aper (Mariette, *Abydos*, i, 46), otherwise named Bahti or Fat (Mar. *Ab.* i, 48a); also in *Ankh-tau*, a quarter of Memphis, where the *nebes* and *sont* trees grew (De Rougé, *Edfou*, exliii). How far these names refer to one temple is not known. Sokar is probably a very early god, and we should look for his shrine near the Apis region.

Khnum was worshipped in a temple near Memphis at Uafet (B.D.G. 146), and his sacred ram at Hatut (B.D.G. 175). The latter might be the name of the shrine only, in the place named Uafet.

Bast had a temple at Pa-penat (*Mon. Div.* 34d); and Sekhmet was at Fuat (B.G.D. 240), though probably also worshipped with Ptah in his temple.

Tahuti had a temple built by Ramessu II. (Br. *Rec.* iii, 224). The Aten was adored here (Rougé, *Inscr.* 54), and blocks of the work of Akhenaten were found by Sir Chas. Nicholson and others. The temple of the Kabiri was entered by Cambyses, who burnt their images; who the Kabiri were we cannot say, but they are described as being sons of Ptah, and like him (H. iii, 37). Apparently there was a shrine of Anubis, as we read of "the road of Anpu" (B.D.G. 1108). The principal long road remaining, is that paved with red granite through Kom en Nawy, leading to the limestone temple (see building east of sacred lake, Pl. XXVII); possibly this might be the temple of Anubis. There is also an allusion to Sebek, as the "Wall of Sebek" is named in the Harris papyrus.

We have now some clue to the number of temples that remain to be found in this great capital. There were doubtless many other chapels and dependencies which have escaped record.

9. Not only was there a foreign settlement at the

Kom el Qala', but farther north there seems to have been another. Prof. Sayce informed me of an inscription naming a settlement of the Hittites, described as north of the temple of Ptah, south of the temple of Tahutmes I and IV, and on the west of the mound which lay east of those temples. As the direct north of the Ptah temenos seems to have been occupied by the lake, we look north of the approach, to the Kom en Nawy. There is a quantity of granite building of late date, re-using red granite blocks of Amenemhat II and Aahmes-Si-Neit, at about T on the Kom. If this were the site of the temple of Tahutmes, then the Kom would be east of the temple, and the Hittite region might be about H, south of the temple, west of the Kom, and north of the Ptah temenos, as described. Such seems the most likely site to agree with all these data. It is stated to be 154 *set* in area. The *set* is supposed by Lepsius to be either 40 cubits or 100 cubits in the side (Brugsch, *Aegyptologie*, 373). If of the lesser size, the 154 *set* would be about two-thirds the area of Kom en Nawy, a very possible size for a foreign settlement.

Another foreign settlement is supposed to be indicated by the name Pa-ta-yaht, the land of Yah, or the Jews' quarter, of Roman age (B.D.G. 138). It is to be expected that the foreign quarters should be along the east side, nearest to the river, as commerce was their purpose.

10. The other parts of the site shewn in the map (Pl. I) are not connected with any description that we can trace. Our exploratory work was at various points. Those already named, or described farther on, are as follows:—the Great Gate and eastern line of the camp; at T, where some blocks were found under the palms; around all sides of the Ptah temenos; at the eastern entrance of Ptolemy IV; at the Temple of Merenptah; along the east side of the Apis site; on the west side, finding the Siamen building; south of Kom Helul for the pottery kilns; and at the West Hall and the pond. Other work not here described was a trial on the fort. The structure of that mound was settled to have been like that of the forts of Naukratis, Defenneh, and Pithom—a cellular platform to support buildings above it. A portion of a court on the top contained a fragment of an immense column of white limestone, with the cartouche of Apries, shewing that one of the palaces was of the XXVIth dynasty. The mound has been added to largely on the north face by extra walling. We tried to reach a corner deposit at the N.W., but were stopped by water. Some

clearing was done in the camp, but fruitlessly. Thus we have tested many parts of the site in the first season, besides thoroughly clearing part of the West Hall and Merenptah temple. We see how great an amount there is to be done, even without displacing any of the cultivation, or removing any of the palms which cover so much of the government land. If any efficient control of the site were allowed, much more might be done by stopping the planting of more palms which is constantly going on. Probably little of the ground will be unoccupied in the future, and we only regret that so much of it has been appropriated in the last few generations. To recover what we yet can trace is the first duty of archaeology in Egypt.

CHAPTER II

THE WEST HALL OF PTAH.

11. AT various times in the last fifty years excavations have been made by the Egyptian government on the region where buildings remain above the cultivation, at the western entrance to the temenos. The two great statues of Ptah were found here, as well as other remains. But the extent of the official work did not reach the floor of the Ramesside building in many parts, nor extend below that structure in any part; and the only plan did not take account of the curious skew of the pylon front, nor of the many peculiar adjustments resulting from that, which are shewn on the plan, Pl. II.

In our work about forty or fifty feet was cleared in front of the pylon, as far as the palms allowed; thus the bases of the colossi were cleared, and the remains of the statues. The body of the south half of the pylon was cleared over, down to unmoved stonework. The hall was cleared over all the southern half, and part of the northern. The northern half of the pylon and hall were not much worked, as it was more destroyed, and previous excavation had gone lower there, so there was not as much to discover, until we may go below the Ramesside level. In this plan continuous outlines show existing parts, and broken outlines indicate probable restorations.

The columns in the hall shew an unusual arrangement. We know of an axial avenue of large columns amid a field of lesser ones at Karnak. But here there is a colonnade of lesser columns around three sides and a field of sixteen large columns in the middle. Doubtless, as at Karnak, the larger columns were

taller, and carried a raised roof with a clerestory around it.

12. The reason for the skew front will be seen in the map, Pl. I, where the west side of the temenos is not at right angles to the south side, or to the axis east to west. Hence any hall that was square must be farther from the skew front at the north than at the south; and this difference is mainly put into the pylon, though a little appears as a skew in the hall itself.

The arrangement of the front is a curious study of accommodation. The temenos wall butts against a stone wall of the same width, at the south end; this stone wall is then part of the temenos wall. The side passage is sharply inclined to this, but its doorway is square with the front. The passage is really rather too much skewed, slightly more than the side of the hall. The letting down of the thickness of the wall by steps should be noticed; this is done so as to get the pylon thinner at the south end, as it had to be thicker at the north end. The axial passage is parallel to the hall; but its door was skew, parallel to the pylon face. The dwarf walls in front of the entrance are parallel to the sight line into the hall.

Now when the colossi had to be adapted to this rivalry of angles a stranger scheme appeared. On either hand of the southern side entrance stood a granite colossus. Their pedestals are between the direction of the sight line through the entrance, and that of the front of the pylon. At the main entrance the pedestal is frankly square with the hall and the main sight line, and ignores the pylon front. But the greatest pedestal in the middle of the face was so wide that both sides could not be viewed at once, and so each side was parallel to its adjacent pedestal, thus concealing boldly the confusion of angles. The northern half of the pylon face has almost disappeared, and only one of the colossal pedestals remains. That one is curiously irregular in the wrong direction. The small block on the north of it is a smaller supplementary seated figure of Ramessu II.

13. The actual remains of the colossi are described in the account of Pl. XXIII. Here we may say that the two at the south side entrance were red granite standing figures, about 22 feet high. The greatest base bore an alabaster figure, probably seated, about 38 feet high. The figure next to the main entrance was of limestone, and by a piece of the breast it was 35 feet high. The scale of these pieces agrees with the sizes of the pedestals, and they were each found lying opposite to their respective pedestals.

14. The side passage on the south is remarkable for the excentric position of the columns, two being to one side and two to the other side. What place other columns bore cannot be traced. In the main hall, the single outlines are the bases of columns; an inner circle shews the lower drum of a column to be in place (see Pl. XXV, base); a broken outline shews the position inferred from others. In the northern side passage only two square blocks of foundations of columns are left.

The wide block of stonework at the north end of the pylon is evidently the stone buttment for the continuation of the temenos wall, now totally removed, the line of it passing over a pond and open fields. To the east of the hall are scattered blocks which I have not succeeded yet in combining into any plan. The group of blocks plotted on the plan close together on the south-east is a foundation, mainly made of granite casing of a pyramid. It seems to shew that some heavy mass stood there. The general aspect of the site, and the details of the structure, will be seen in the account of Pls. XXI to XXIII.

CHAPTER III

THE MONUMENTS. XVIIITH DYNASTY AND EARLIER.

15. THE earliest monuments found were blocks of stone that had been re-used by later kings of the XIXth dynasty. Ramessu II had brought much wrought stone from the pyramids and tombs of Abusir and Saqqara. The basement of the walls of the West Hall was built of pyramid casing-stones of red granite, having an angle of $53^{\circ} 20'$ (see base of Pl. XXI). Other such stones were inverted to form foundations for columns; and limestone casing-stones, of angles from $56^{\circ} 40'$ to $57^{\circ} 30'$, and one of $62^{\circ} 40'$, were used in the core masonry of the pylon. Tombs were also robbed, and pieces of tomb sculpture were used in foundations, such as the block on Pl. III; this is of the Vth dynasty, by the name Ra-shepses; he was divine scribe of the record office, an unusual title. The figure has originally carried a bird in the hand, but that has been cut away to make room for the title. This block is now in the Brussels Museum.

While clearing the West Hall, we came on a large block of granite, of about seven tons, which appeared to have been re-used. On looking beneath it, I found

the inscription of Ranuser, Pl. III, shewing it to have been a door jamb. A similar block near it I also searched, and found the fellow inscription of the other jamb. Then looking at a re-used lintel, which had long been visible to all, I saw a faint inscription of Ranuser, shewing that it had been dedicated in the Sun-temple at Abusir. The breadths of the blocks agreed, and the whole doorway was before us. It was removed, at the cost of the British School, to the Cairo Museum. As I was not able to get a photograph before I left, owing to difficulty of lighting, a plan of the under side of the lintel and a copy of the inscription are added in the middle of Pl. III. The lintel is 24 inches high, 48 deep back, and 107 inches long; the jambs are 28 by 48 inches in plan, and imperfect at the ends, but 108 and 114 long.

16. Amid the ruin of the north half of the West Hall lies a large block of limestone, from the lintel of a doorway. The inscription of King Teta is shewn on Pl. III, with his *ka* name *Sehotep-tau* at the side. The breadth of the whole lintel has been 104 inches, and it is 49.7 deep back, and 38 inches high. The doorway was about 41 wide. This is probably a door-lintel from Teta's pyramid-temple at Saqqara.

17. In the foundations, on the western side of the front court of the temple of Merenptah, were found parts of lotus capitals, the most complete of which is shewn on Pl. III, with a fragment at the side of it bearing finely worked buds. Another piece occurs accidentally in Pl. XXV. These capitals had been split in two to use in building. The form is far better than that of the XIIth dynasty, and is but very little inferior to the beautiful capital of the Vth dynasty from Abusir, now in the Cairo Museum. This is probably therefore of the Vth or VIth dynasty; it is now at Manchester.

18. Amid the ruins of the West Hall were three blocks with very delicate hieroglyphs, perfectly cut in red granite, Pl. IV. These were parts of a granite table of offerings for a Ha-prince, Uah-ka; it was dedicated to Osiris of Ankh-tau and Ptah. The same name and titles (*ha*, and chief of prophets) occur on a Stockholm stele (15) with the name of Amenemhat III. But the engraving of this block is so very fine that it seems to belong to the beginning of the XIIth dynasty.

In front of the west pylon lay a block of granite much defaced (Pl. V). It bears part of a long and finely engraved inscription, which was partly copied with difficulty owing to the battered condition. In the 8th column a long passage has been intentionally

erased. It names a vizier (*mer nut that*) Ameny, endowments of offerings to Amenemhat I, and the pyramid-temple (*khnum-asut*) of Senusert I.

A portion of a stele of quartzite sandstone, Pl. VI, lies in front of the pylon. The king's name is lost, but from the work it seems to be of about the period of Amenhotep III.

19. Beneath the foundation bed of sand of Ramessu II, in the West Hall were found many tablets and fragments, which had been thrown away from a temple of the XVIIIth dynasty. About 40 perfect tablets and 150 fragments have been so far recovered. But only a small area of the ground has yet been cleared so deep. If a large number of objects are broken in two, and a chance group of the whole is examined, the number of pieces that can be joined is to the total of the group, as the group total is to the original total number. So as not a tenth of the pieces yet found will fit together, probably not a tenth of the whole number has yet been found. The earliest is a large tablet (Pl. VII, 46) of Tahutmes I offering to Ptah and Sekhmet. (For the reading Sekhmet see Pl. XV, No. 36). At the base, adoring Ptah, is the offerer, the guardian of the gate, Bak-ne-ra. The space after Bak-ne is only half a sign high, and Ra is the only name likely to fit that; Tum and Sebek, though low signs, would be improbable. We shall now refer to the tablets in their numbered order.

Pl. VIII. Nos. 1 and 2 and 3, probably of Tahutmes IV, like No. 4. The hawk giving the deadly power of the uraeus to the king is unusual. The ears are considered below. No. 3 is dedicated by the overseer of the serfs Rames and his sister Uaat. No. 4 is dedicated by Rames, perhaps the same man. The use of the crown instead of the bee in the royal titles is rare.

20. Pl. X. The subject of the figures of ears on tablets is partly explained by the instances found this season. Previously sculptures or models of ears were thought to be *ex voto* offerings for recovery of complaints. Spiegelberg published (*Rec. Trav.*, 1904, p. 56) an example with a prayer to Ptah to hear. Now we have several such, Nos. 10, 15, 22, 25, 30; and with the ears on each side of the head of Ptah, 14. Whether these phrases are requests to Ptah to hear prayer, or titles, as "Ptah hearer of prayer," is not certain. We see, however, that the *neha* "prayer," or *spert* "petition," is always in the singular, so it does not refer to many different prayers, but only to one, and so probably it is specific and not

general and titular. Again, the word prayer or petition is always followed by "made by so-and-so"; and though this might refer to the tablet and not to the prayer, yet it is only twice found on other tablets (33, 42) apart from the word prayer, and hence it probably refers to the specific prayer. We must translate, then, "Ptah listen to the prayer made by so-and-so."

The exact meaning of the ears has been looked at in different ways. One view is that they are ears of the god, to receive the prayer; the other view is that ears are put on to encourage hearing by sympathetic magic. Now it is difficult to see the use of a tablet with only an ear, and no figure or inscription (as 5, 6, 7, 8), for promoting a petition not recorded; but if regarded as the ear of the god, and prayed into, it might be thought to retain the prayer for the attention of the god. The objection that a god would not have so many ears (there are 376 on No. 49, Pl. IX) is met by an account of a god with 77 ears and 77 eyes. It seems more likely, then, that these were the models of the god's ears made to receive and preserve the prayers breathed into them.

Some of these tablets were found in the southwest corner of the building site which is cut away by the pond; such are Nos. 6, 7, 10, and 38. No. 11 has the two ears placed on stands as sacred objects, and presided over by the winged disc.

Pl. XI. No. 15 has a "*suten da hotep* to Ptah that he may listen to the prayer made by . . ." No. 19 is offered by the "Inspector of the flesh offerings of Amen, Piy." No. 20 is by a scribe and his sister Thent-ant.

Pl. XII. No. 21 is by the door-keeper Huy, and the deputy Aay. No. 25 shews that such tablets were made ready for purchase, with the name left blank, as it has not been filled in here.

Pl. XIII, 30 is interesting for naming the *ka* of Ptah as adored, reminding us of the name of Memphis, "the dwelling of the *ka* of Ptah." It proves that gods had *kas* which were worshipped. This is dedicated by the scribe of Ra, Mahuati.

Among ear tablets should be noted No. 48, Pl. IX, which had over 110 ears, and bears an "adoration to the *ka* of Ptah, lord of truth." No. 49, below it, has had about 376 ears, and is most delicately engraved. The inscription (see Pl. XIII) accounts for the beautiful work, by stating that it is for the chief artist Ptahmes. A rare title of Ptah is *mes uba*, probably to be rendered "producing Art."

21. Pl. XIV. Passing to the tablets without ears, there is 31 naming the scribe of Memphis (?) Mer-ra. No. 33 has the figure of the god in relief, and is peculiar for the disc with one wing and the *uzat* eye placed at the top. 35 is also in relief, but the figure of the offerer has been erased.

Pl. XV. No. 36 gives the reading Sekhmct for the consort of Ptah; it is dedicated by Rames. 37 is later than the others, being of Merenptah, and it was not found under the foundation like the rest. It has the figure of Asthairt or Astarte, with a Hathor head-dress, and holding a shield and spear, like the fighting goddesses of Syria. 38 shews the Theban triad of Amen, Mut, and Khonsu, facing Ptah; 39 is the rudest of all the tablets. 40 is dedicated to Ptah and Amen by Qen and Merenptah.

Pl. XVI. No. 41 has no inscription; a lady adores Min. No. 42 is the most beautifully worked tablet, shewing the ram of Amen, adored by the lady Nehati. 43 is a private tablet shewing four women, Aahmes, Nana-uab(?), Menat, and another. An Aahmes appears also on the next tablet.

Pl. XVII. This is the only family stele of the whole group; though the inscriptions are rough, we can see the names Huy, Kharu, Usert, Meryt, and Roma, but the other names are doubtful.

The imperfect tablets have been left at Memphis, awaiting the discovery of more pieces in future. Rough copies of the names and titles are given at the base of Pl. XV; they are distinguished by letters to prevent confusion with any future publication of them. We should notice the adoration of the *ka* of Amen (C), the stele to Hapy (G) which is the only notice of Apis, the miner or quarryman (L), and the name Sipairi (O), which must be early in the XVIIIth dynasty.

The present places of these tablets are as follows:—Bristol 16, 43; Brussels 4, 21, 25, 39; Copenhagen 18, 26, 32, 41; Dublin 12, 29; Edinburgh 17, 36, 45, 46; London, British Museum, 5, 14, 30, South Kensington 1, 47, University College 9, 24, 35, 37, 38; Manchester 6, 10, 27, 28, 42, 49; Munich 2, 3, 44; New York 13, 19, 22, 33, 40; Philadelphia 11, 23, 31, 34; Rochdale 15.

22. An unusual form of altar of offerings, found with the tablets, is shewn at the foot of Pl. IX, and its inscription on Pl. XVIII. It seems to represent four long rolls of bread laid on the slab. The dedication to Ptah and Sekhmet is by the Hereditary Prince, royal sealbearer, lordly companion, true royal scribe,

over the house of the elders in Memphis, Amenhotep. It is now in the Metropolitan Museum, New York.

Among the sculptures beneath the Ramesside foundation were also portions of some statuettes. Most were decayed, being of soft limestone, but one figure of hard limestone is in good preservation, see Pl. XIX. It is of the true royal scribe, keeper of the palace, keeper of the granaries, Ray. From the dress it is probably of the time of Amenhotep III: it is now at Dublin.

At the west side of the pond (see map, Pl. I) a patch of foundation deposit was discovered (Pl. XIX), shewing that Tahutmes IV had built over the ground now dug away. This deposit contained a large green glazed tablet, incised after baking, two alabaster hemi-discs, and a pointed piece, all with the king's names. A plain square of alabaster and bronze models of knives, axe, chisels, and crowbar, were in the group, along with many small model vases and cups of pottery, Pl. XX, 1–20. Now at Manchester.

CHAPTER IV

THE MONUMENTS. XIXTH DYNASTY.

23. OVER the region now occupied by the pond near the West Hall, there has been a building of Ramessu II, now entirely destroyed. Only the west side of its foundation is left, and in the sand bed of it a foundation deposit was found, shewn on Pl. XIX. The large block of alabaster has the cartouches of Ramessu II on both of the faces, and the inscription of "the high priest of Ptah, the royal son, Kha-em-uas" on both of the edges. The lesser tablet of green glazed pottery has similar names on the faces and edges; and the black granite tablet has the names of Ramessu on one face, and that of Khaemuas on the other face. These are some of the finest deposit blocks that are known; they rest now at Manchester. For the columns and inscription, 21, see the account of Pl. XXII.

24. In the West Hall two fragments of red granite are remarkable. They are parts of false doors, which have been about 108 and 148 inches wide, and probably about half as much again in height. On Pl. XX, 22 is one piece shewing parts of the square panel, of the architrave, and the drum with the cartouche Ramessu Mery Amen. As this piece is 22 inches wide we can roughly estimate the whole. The lower piece, no. 22, has the three vertical bands

of inscription and the torus roll and outer edge. In the middle is at least 32 inches width of the sunk door, which was possibly wider, but the increased thickness of the side has most likely determined the fracture. The parallel to such false doors in a temple is seen in the seven chapels of Abydos, which end each of them in a false door. There is no room for such chapels in the hall, so it seems that we must suppose the false doors were the foci of the worship of the king in the hall. The painted pottery no. 23 will be noticed with the objects of Merenptah.

25. On Pl. XXI are the views of the West Hall, the plan of which is given in Pl. II. The first is a distant view from near the colossus, looking across the water, which covers the temple site of Ptah till February. The village in the distance is Mitrahineh. This curious name appears to mean the village of a hundred mortgages. The West Hall is just behind the nearest palm stem. The village is seen again in the view of the pond which is taken from just in front of the pylon. This pond is due to former excavations for the early statues of the pyramid age. The boys are carrying the earth out from our excavations. The third view is from above the pylon, with the pond to the left. Just to the right of the middle tree is the line of columns in the hall; and to the left of it is the inner face of the pylon, the body of which lies to the left. The next view shews the clearing of one quarter of the pond. We divided it by banks into halves and quarters, and then pumped out the water to eight feet under the ordinary low level, by the pump seen in the middle. A chain of boys handed up the mud in buckets and tins, as it was dug loose, and poured it out at a distance. The water ran in fast, as the work went through the sand bed of foundations, which are probably those of the temple of the pyramid age. The pumping was continued by alternate pairs of men changing every quarter of an hour, four thus working by day and four by night. The pump was of a rubber-diaphragm type taking a four-inch hose: and the water was run off along a graded channel to a pond at the farther end of the village.

The outer sides of the West Hall were of basalt, resting on a basis of granite casing-stones taken from a pyramid, shewn in the last view. The whole length was occupied with figures of cities bearing offering-trays. In the view of the whole wall the distant palm trees are as far as the Ptolemaic entrance, which is in the gap above the end of the wall. From those

trees the temple buildings extended up to the hall in the foreground.

26. Pl. XXII shews the details of the West Hall. The axial entrance-passage has the basement of basalt remaining, bearing an added inscription of Merenptah, and another of Ramessu III below that. In the middle line of the plate is one of the dwarf-walls of granite that run out on either side of the entrance before the pylon. The end of the entrance-passage is seen above on the left. The row of granite columns is down the northern side of the hall, looking across the temple site, as at the foot of the previous plate. Among the loose blocks is a palm capital probably of the XIIth dynasty; the lower part has been built into a wall, and the abacus cut away into a drum of a Ramesside engaged column. There are many pieces of engaged columns of hard pale drab limestone, the longest of which (70 × 175 inches) is shewn in the last view, Pl. XXII. They were built with the bed of the rock vertical, and usually in two halves. They have all been re-used for architraves, or roofing, or core blocks in the pylon, in the West Hall. The pieces of inscriptions upon them, and the sections of the blocks, are given on Pl. XX. These were clearly of Ramessu II, and name the god Ptah Tanen. They seem therefore to have been part of some building here made by Ramessu, who afterwards pulled it down and re-used the material in the West Hall. Such engaged columns are unknown elsewhere. The columns were of varying sizes. The diameters cannot be exactly fixed where only half of the column breadth was in one block; but the sections given have the apparent diameter in inches put beside each of them. There seem to have been three sizes, the smallest 26·5 to 30·3 inches, another 40 inches, and the largest 55·6 inches wide. The smallest were more fully detached, the larger ones were only half columns projecting from a wall. The letters A to N at the side of the sections refer to the inscriptions which belong to each block.

Pl. XXIII. The lion's paw is on the side of a spout, fallen from the roof of the West Hall. The block is upside down in the ruin, hence the lighting is reversed here. The channel of the spout is seen on the end. This is of basalt, as also are pieces of a very large inscription on Pl. XXIV, lower half; and it seems that the walls—which were probably of limestone—had a band of black basalt along the base and the top.

27. The colossi in front of the pylon are noticed in the description of the plan, Pl. II. In Pl. XXIII

are shewn the side view and front view of the base of a red granite colossus, on which is lying a leg broken from it. The foot is 18·1 inches wide, 40·7 long, and 75 to top of the knee-cap. This implies a height of about 22 feet with the crown.

The piece of an alabaster colossus is so much weathered at the back that it is difficult to recognise the form. As here placed in the plate, the back is to the left, the slope across from left to right is the shoulder, and in the shadow above that may be seen the neck and beard. The neck is 44 inches wide, the arm 33 thick, the trunk 79 across at the smallest part. These and other dimensions imply a height of about 44 feet if standing, or 38 feet if seated.

At the bottom is a view of the base of one of the colossi which stood in advance of the pylon entrance, as described by Herodotus. This base is built of blocks of basalt; and the names of captive countries on the side are shewn in the next photograph, with traces of the Nile figures above them. It is difficult to photograph, as trees shade it from most of the sunshine. The face of the basalt fell away soon after being uncovered, but the names were transcribed as soon as exposed; reading from the right they are Asy, Naharin, Kheta, . . . , Mad, Qedesh, Tasha . . . , Khilbu, and Mashuash.

28. Pl. XXIV. The upper block is a relief carved in red granite representing the upper part of the shrine of Ptah. The head of the god is admirably wrought; before it is the top of his sceptre. The door of the shrine is represented as open, and bearing the names of the king. Below that in the plate is the inscription on a block of basalt cornice. The whole block is 38 inches high, with bordering bands sunk 5·0 to 5·8 from base, and 4·0 to 7·3 from the top edge.

29. Pl. XXV. The clustered column with the figure and name of Khaemuas was found re-used in the masonry of the temple of Merenptah. It is evidently of the same class as the clustered column with rope-pattern binding in the next photograph. The inscription is transcribed on Pl. XXVI. The date of these clustered columns is not certain: the rope binding is unknown before, and the scene of Khaemuas has, by some, been supposed to have been altered from some earlier subject.

The small columns of Ramessu II and III were found in the S.W. corner of the temenos. That of Ramessu II was standing in place on one of the bases of the colonnade, the plan of which is in

Pl. XXX. The chapel of Shabaka in the same region is planned in Pl. XXVII.

The lower drum of a granite column is one of the largest columns of the West Hall. It is 86 inches across. The figuring of Set in place of Uazit for the northern divinity is very unusual, and the figure has of course been erased in later times. The treatment of the Nile plants is better than on most Ramesside work.

30. Pl. XXVI. The first inscription is on a door jamb, which had been brought down from the cemetery as building material. It has a *suten da hotep* to some gods and to the royal *ka* of Ramessu II; this address to the royal *ka* is like that found under Akhenaten (Davies, *Tell el Amarna* II, ix). The name of the person is lost, but she was a princess, *erpat*, and a praiser of the king, *hesy*. It is now in Munich.

The fragment of an inscription, 2, is from a quartzite stele, which had been reworked by Ramessu II, and lies on the north of the entrance to the West Hall. 3, 4 and 5 are fragments of limestone sculpture, from earlier works re-used: 3 is now at Brussels, 4 at Rochdale, 5 at New York. Probably 5 is part of a scene of the funeral sacrifice of a bull by the sons of the deceased. 6 is the inscription on a column in the previous plate. 7 shews the cartouches of Set-nekht, as engraved on the front of the pylon of the West Hall.

31. Pl. XXVII. A small building in the south-west corner of the great temenos, was dated by the *ka* name of Shabaka on a block of stone. The hieroglyphs were finely executed in low relief. The plan could not be followed farther than here shewn, owing to the palm trees. Probably the space marked as earth had been occupied with a cross wall, which had been entirely removed for the stone. The photograph of the ruin is shewn at the base of Pl. XXV.

The building east of the Sacred Lake was uncovered by the *sebakhin* diggers in recent years; and, though they were not allowed to take the stone-work, they dug away the brick walls almost entirely, so that they are here restored (solid black) by inference. There is a long paving of blocks of red granite, leading away from the east gate, through the town ruins, shewing that this was an important building. Not a single hieroglyph or graffito is to be found on any of the masonry. The measurements of this plan were taken by Mr. Ivo Gregg.

CHAPTER V

THE TEMPLE OF MERENPTAH.

32. IN the first chapter we have already considered the identification of the temple of Merenptah with the temple of Proteus in the foreign quarter. We now notice the actual remains.

The position of the temple in relation to the surrounding buildings is shewn in Pl. XXVII. Of the actual temple two points are fixed; the first is the great outer gateway of Merenptah, the lintel of which was found two years before, standing in place; the second is the inner doorway to the temple, of which we found two foundation stones and one jamb.

The outer gate of the forecourt was roofed by a lintel of about 16 feet long. The sculptured scenes upon it, of Merenptah before Ptah, occupied 185 inches in length and 42 inches in height. This lintel has been completely copied, and will appear in a future volume. Its thickness is formed of two or three slabs of stone one behind the other, like the architraves of the Parthenon. They are cracked through, and the whole was anciently in danger of falling. The Egyptians therefore closed this gate, and shored it up by walls of brick, buttressing it in front (see plan). Behind it, and all over the court, chambers were built which completely filled up the area. A few of the more distinct of these were measured, and are entered on the plan in the "Outer Court of Merenptah"; but it must be remembered that they have no connection with the temple, and are entirely later.

33. All over the middle of the outer court there was a thick layer of earth with remains from workshops, below the houses, belonging to a time when rubbish was thrown into the court, but before it was appropriated to civil use. These remains are glazed beads and waste beads, and great numbers of little pellets of burnt clay about a quarter of an inch across. These pellets may have been used to separate objects in the kiln. On the western side of the court were many unfinished scarabs in steatite, roughly blocked out (XXVIII, 14), and unfinished calcite beads (XXVIII, 13).

The ground of the court was open, and originally contained no buildings. Some little washing troughs were found sunk in the ground, perhaps shewing that ablutions were performed in the court. The re-used lotus capitals (Pl. III) and column of Khaemuas (Pl. XXV) were found in the ground at the southwest of the court. The western side of the court

seems to have been a line of brick wall, which we traced along most of the length of it.

At the back of the court was a doorway, doubtless that of the temple, and the wall east of that seems to belong to the temple by its direction. Two great blocks of red granite with the name of Merenptah formed the foundations; and the western door jamb stood in place about seven feet high. This, being of limestone, we sawed into three pieces, and it is now in the British Museum. On Pl. XXIX is the photograph of this jamb.

34. The relation of this temple to the rest of the town we may note, before passing to the small objects. Over the temple building, north of the outer court, two large blocks of brickwork have been superposed. These will have to be entirely removed in 1909, in order to reach the temple, whose position is now exactly known. The general direction of the streets and houses is parallel to the temple. But all of these houses are later than the temple, probably built during a few centuries before the Ptolemies. They doubtless stand on the lower parts of earlier houses. The street lines, where they could be traced, are here marked by rows of dots, approximately the distance apart of ordinary footsteps, so as to give a sense of scale in looking at the plan. The longest wall, running out to the east edge of the plate, has been buttressed and thickened along the north side, and a sloping way to the top on that side seems to be of original design. It was therefore intended for defence against the south, and thus was the enclosing wall of the Tyrian camp named by Herodotos. But it was not an early feature, as it lies over the house ruins of the same ground level as the rest of the plan. Probably it is early Ptolemaic, a defensive work for the Greek garrison stationed in the foreign quarter. It is exactly in line with the south wall of the temenos of Ptah; and it probably ran on continuous from that (see Pl. I, where it is marked "Late Wall"). But it cannot now be traced up to the temenos, as all the intervening ground is cut away lower than the base of this wall.

35. The small objects from the courtyard of Merenptah are shewn in Pl. XXVIII, figs. 1 to 22; the Cypriote pottery is in Pl. XXIX, the rough painted figures of pottery are at the top left hand in Pl. XLIV, and a piece of painted dish at the bottom of Pl. XX. This dish is of rough pottery with a pale drab facing; the pattern is of black, with broad red filling, which is shaded here in

vertical lines (B.M.). On Pl. XXVIII some pieces are probably foreign, such as the "island figure" of alabaster, 3; the amulet, 9; and the steatite and onyx discs, 11, 12. Others are hardly of Egyptian manufacture, as the Taurt head, 4, and the calcite beads, 13, and scarab blocks, 14. No. 5 is a very unusual figure of Bast playing a lute. The strainers 6 and 23 are apparently intended to hang on to a spout, probably for straining wine (B.M.). The cones of blue pottery, 15, 16, appear to copy cone shells; they have no hole for hanging, and are solid, for what purpose we cannot say. Their colour and texture are remarkably like some of the glazed pottery of the 1st dynasty. Many sickle flints, 17-20, were found among the houses filling the court, shewing that such sickles were still in use during the later dynasties. The two tablets of Hathor, 21, 22, are the only such found at Memphis, and are probably connected with the shrine of Aphrodite = Hathor, named by Herodotus as being here. No. 21 shews Hathor standing before the Hathor cow; the ears above are for "Hathor lady of Nehat," the sacred sycomore of Memphis. No. 22 has the cow amid the marshes, named "Hathor lady of Hotep-hem," a place in the Heliopolite nome. Below is the dedication "made by the nurse of the royal son, the lady of the house, Ta-nenuny." Both of these tablets are in Manchester; but all the objects and pottery with foreign connection are in the British Museum, Greek department, where all foreign pieces from this temple will be placed in future. Besides the objects figured there were five pieces of alabaster inlaying, one piece of glazed tile of Sety II, and one piece of tile with large hieroglyphs, *mes*, doubtless from a cartouche. These scraps thrown out into the courtyard suggest that there was both alabaster inlaying and coloured tile work in the temple. Many moulds for glazed amulets were found amid the potters' waste in the courtyard; 8 of Ptah, 4 of Isis, 15 of Sekhmet, 8 of her aegis, 2 of Bes, 4 of busts, 14 of eyes, 8 of scarabs, about 50 for disc beads, 1 each of the cowry, lotus cup, lotus seed, spiral, etc. The scarabs found in the court are in Pl. XXXIV, and are noticed further on.

CHAPTER VI

THE LATER ANTIQUITIES.

36. In Pl. XXVIII, 23-30, are some of the small objects found in various parts. The bronze lion (?),

24, is a handle from a vase. The bolt 25 probably belonged to a door of a model shrine. The measures, 26, 27, are perhaps for medicines, being too small for any ordinary goods. The disc and horns, 28, is doubtless from a figure of Isis. The chisel, 30, was found in the sand bed of the West Hall, lost there by some mason of Ramessu II.

Pl. XXIX. Beside the objects described above, there is a Roman lamp and holder, of bronze. This form of holder was to hang up the lamp, by loops which carried the trunnions on the side of the lamp. The hook at the top of the handle served to hang it, or sling it from the finger. The arch below is ornamented with foliage scroll (Brit. Mus.).

37. Pl. XXX. The plan of the great gate shews that it is close to the north-east corner of the camp, as on Pl. I. We searched along the whole eastern side of the camp, expecting to find a gate near the middle of it; but every part was proved to be continuous until we reached this corner. Here the foundation of the gateway remained, with sufficient traces of the wall along the south side, and enough on the north to shew the width. The gate was single, the side recess for it being equal to the width of the entrance. The recess is 164 wide and 9 to 10 inches deep; the entrance is 144 wide, or 164 into the recesses, if the two walls were alike. The depth of the foundation is five courses thick, amounting to just ten feet of solid white limestone. Beneath the upper course there runs a drain, 15 to 16 inches wide.

38. The building of Siamen is at the south-west corner of the map, Pl. I. It was of mud brick, with stone lintels and jambs, and contained stone columns. The finest work of the lintels is shewn on the next plate; but all the lintels will be published next year, when it is hoped that the whole building will have been excavated. Hitherto the only sculptures of this king were on a few blocks of granite at Tanis, and not a single piece existed in any museum; to obtain six lintels and many door jambs was therefore a valuable result. These lintels are now in Cairo (Pl. XXXI), Copenhagen, British Museum, Manchester, Philadelphia and Pittsburg.

The building in the south-west of the Ptah temenos was apparently a late and irregular work. The bases of the colonnade are of varying sizes; upon one stood a column of Ramessu II, but it may not have been originally placed there. North of that was a chamber built of re-used blocks of sculptured stone. To the east lie three blocks of alabaster; the

northern has cartouches of Ramessu II with . . . *si ankh* at the side. The southern block has the cartouches of Sheshenq I in the middle; at one side is a figure of the high priest of Memphis, and *anmut ef* priest, named Ankh-ef-ne-amen(?) who is offering to Osir-hapi, with also the name of his heir, *erpa em ab ne ur kherp uba*, Set-nen-ncfer-tum. The figure opposite to this is probably that of the son. The block seems to have been brought from the Apis temple. It will be published next year. Other large blocks of foundation also belong to some building which has now been entirely destroyed. These blocks are higher up than the colonnade, and therefore belong to a late date.

Pl. XXXI. The lintel of Siamen has been noticed above. It is of far better work than has generally been credited to the XXIst dynasty, almost equalling the style of Sety I; and it shews how well the Memphite school was maintained. The high official behind the king is Ankh-ef-ne-mut, son of the prince Auy. The slab here shewn is half of the lintel, which has a similar scene on the other half, with cartouches of the king between the scenes. Below is a block with an Agathodaimon in relief, and diagonal holes at the corners to pin it back into a wall. It seems to have been a house charm or amulet.

39. The breccia statue is of fine work, Pl. XXXI; it now measures 29½ inches, so the whole figure must have been 38 inches high, or rather over half life size. It is carefully finished, but conventional in the anatomy. The inscriptions on the belt and back are given in the next plate, XXXII. The belt has the dedication to Ptah and to Sokar, for the Hereditary prince, the royal brother of the king's father, general, elder of the elders, vizier, Hap-amu. The middle of the back inscription is entirely worn away by rubbing. It is here divided across the middle, in order to keep it on a sufficiently large scale in the plate. In the third column is a trace of a cartouche which can hardly be any other than that of Nekht-hor-heb. This explains how Hap-amu was royal brother of the king's father, and not brother of a king: Nekht-hor-heb was the first of his dynasty, and his father was not a king. The uncle therefore could only claim royal relationship through his nephew. And this high position explains his having the greatest administrative titles. The style of work would agree well with this date of the XXXth dynasty. The figure is now in New York, Metropolitan Museum. On this plate are also two pieces of inscriptions that

were re-used in the temple. They name Osiris lord of Rustau, and are probably from tombs.

40. Pl. XXXIII. First is a curious stele, bought at Memphis. The figure of the offerer and the inscription seem as if cut on a reworked surface, while only Osiris and Isis belong to the original stele. The deceased was devoted to Hathor of Tep-ahu (Aphroditopolis), "over the speaking of words, Shaneba, son of Khred-ne-mut and Sha-ne-ba . . . Hor, his mother Tahayba." The title *her zed medu*, "over the speaking of words," seems new to us; it may mean the arranger of the official speeches of the gods.

The trial pieces are all in quartzite, and shew various grades of work from simple outline to the finest elaboration. The best four are in South Kensington Museum; the piece with *si ra* is at Brussels, along with a trial piece of a *kheper* beetle in limestone.

The shrine or hutch seems as if for keeping a small animal. There is a little air hole at the back, and it had a sliding door in front. The edge of the hole is gnawed, which suggests that a shrew mouse was kept in it. It was bought at Memphis; now in University College, London.

The head of Hathor is now at Munich, and the piece of a house model at University College.

41. Pl. XXXIV. The scarabs were found partly scattered in the general excavations, but rather more than half came from the Merenptah temple court, which was filled up with later houses. A very few are as old as the XIIth dynasty; probably 1, 2, 6 and 7 may be thus dated. Of the Hyksos age there may be 8, 9 and 10. The XVIIIth dynasty produced 3, 4, 5, 12, 16 (Amenhotep III), 17, 20, 21, and perhaps 82; but the rest with Men-kheper-ra are probably of a later date. It is difficult to decide how many may belong to the XIXth dynasty; but probably 23, 26, 27, 28 can be safely put there. No. 29 is of red jasper, and probably the name is intended for Ramessu VI. After this we can only date 63 of Siamen, XXIst dynasty; 103, which is Greek work in dark green jasper of the XXVIth dynasty; and 104, probably of the same age. The rest are difficult to discriminate in age; some may be rough work of an earlier date, as 33, 58, 71, or be later imitations, as 69, 70, 72, 75. The majority are made of the usual schist; but one-third of those from the Merenptah temple, and one in seven of the rest, are of pottery or soft paste. The proportion is, however, the same in all, if we omit the rings, which

are always of pottery. It is obvious from these examples that Memphis is the source of a large part of the scarabs sold in Cairo. I have to thank Miss Herford for inking in these drawings. The Plates XXXV to XLIV are noted in the next chapter.

42. Pl. XLV. The green glazed altar of offerings is a very unusual object, probably of early Ptolemaic age. It has a band of palmetto pattern around the edge, and is in perfect condition. It was found in the earth at the south gateway of the pylon before the West Hall; it is now in the British Museum.

The limestone head was found at Athribis on the site of a temple built by Ptolemy Physkon; as it is that of a king, by the uraeus (broken off) and the character of it, it is doubtless from a statue of Physkon. The Ptolemaic portraits are rare in statuary, and this is apparently the only such in limestone that has survived. This is now at Manchester.

The trial pieces were also from Athribis, and are now at Munich. The pieces of the red granite architrave of the pylon of Ptolemy IV are on a much smaller scale than the other objects here. They will be published more fully when it is seen if other pieces can be recovered. The restoration is that suggested by Prof. Sayce. The name of a queen Arsinoe can only belong to one of the queens of Ptolemy II or to the queen of Ptolemy IV; and of these two kings the title Theos can only belong to Ptolemy IV. The third line has been added at a date after the erection, as it is but slightly and roughly cut, while the first two lines are deep and clear. These pieces are from the architrave of the entrance added to the east side of the temenos of Ptah, where the road from Bedrasheyn now enters the mounds. Two granite capitals were also found, of different types.

The piece of a Greek funeral stele is in white marble; it is now at New York. The examples of alabaster vase-working shew on what a great scale it was practised at Memphis, as thousands of drill cores are found. At the back are seen three vases broken in course of making; at the right is a vase roughed out ready to be drilled, and in front are five cores from tube drills. Some examples have been sent to most museums connected with the work.

43. Pl. XLVI. A large quantity of pottery was found in one group, while clearing to the east of the temple of Merenptah. The forms are all given in this plate; and the two Greek vases, 5, 6, give a date of about 300 B.C. So this may be taken as the beginning of a *corpus* of early Ptolemaic

pottery, the first large series thus dated. With this pottery was the mask of a satyr on Pl. XLIX, and the glazed pottery figures, Pl. XLVII. These are the only figures well dated to a late period, and give a definite standard for comparison. The piece at the lower left hand of the group is of black Greek pottery.

Pl. XLVII also contains a group of lamps, probably belonging to about 200 A.D. The designs may well be copies of moulds of the time of Hadrian, while the pottery on Pl. XLVIII found with them is rather earlier than the pottery of the IIIrd century at Ehnasya. The handles belong to the lamps with which they are placed, and there is one odd one in the middle of each group. Other lamps found with these are of the following types, published in *Roman Ehnasya*:—A 40; B 30, 85, 93; E 55, 97; F 37; J 92; P 86. These are all debased types; and we now learn that such were contemporary with the fairly made triangular handles, and are as early as 200 A.D. Such a date quite accords with the dates of the rough lamps found at Ehnasya.

Pl. XLIX. The statuette of Nefertum is curious, as shewing that it was thought worth while to mend such a figure, if broken in modelling. The crown has been broken off, and rejoined before the glazing. The mask we have already named as being found with the lamps. The rest of the plate shews the kiln and pieces of blue glazed pottery found in it. The drawings of the forms are on the next plate. The group of pottery kilns and waste lies to the south end of Memphis, beyond the Kom Hellul. We opened one kiln which had been abandoned, and then been used later as a rubbish hole for wasters from other kilns. I carefully verified, by working for some time myself, that the wasters had been moved out from the kiln where they were baked. The view of the kiln is given in the plate. It was a pit about six feet square and eight feet deep; no hole was traced in the lower part, but more than halfway up there was an arched opening to the west, about two feet wide. This could not be for out-draught as it faces the usual wind; and therefore it seems that the air was admitted to the upper part of the kiln. The supports for the glazed pottery were cylinder jars 10 inches wide and $7\frac{1}{2}$ inches high. The body was of coarse brown and yellow pottery, fusing to a dirty yellow-green. The jars are shewn by their fusion, and by attached objects, to have been stood mouth upwards in the furnace. Such jars were placed mouth downwards in the time of the XVIIIth

dynasty (*Tell el Amarna* p. 26, Pl. XIII, 62). The dishes were stacked face down, one over the other, supported apart by four cones of pottery between each. Such cones were about half an inch high in Ptolemaic times, but varied up to an inch high in Roman use.

Pl. L shews the forms of the dishes and jars found among these wasters. The best set went to Cairo and the South Kensington Museum, and other examples to most of the other museums concerned.

44. Pl. LI shews the small objects obtained at Athribis, which were not drawn in Egypt in time for the volume on that site. The material is stated at the base of the plate. The date is probably from the IVth to the VIIIth century. Fig. 2 is a lid, perhaps for a chalice. 3 is a separate figure of an eagle made to stand alone, and not part of a larger object. 4 and 16 seem as if they were ceremonial crosses to be held by the loop and used in giving a blessing. 10 is probably a leather-worker's knife. 12 is a spur, perhaps late. 14 is a fish-harpoon. 15 is a pair of tweezers, with a pick point hinged between them, so that it could be pushed aside when requisite: such girdle pendants were probably for extracting thorns from the feet. 18 is a curious chain made of long strips of bark, coiled round and covered with a vegetable paste; it could have no strength, and must have been only ornamental. The dolls 21, 23, are at Brussels. The glass bottles 24, 25, 26 I had long supposed to be modern flower button-hole tubes, when seen in dealers' hands; but finding three such here at Athribis, a most out-of-the-way place, seems to prove their Roman age. The pieces of a large glazed jar, with yellow designs, 29, are here restored as far as possible. It is of course Cufic.

Pl. LII. Many pieces of painted pottery were found at Athribis; and it seemed desired by different authorities that they should be published for reference. They have all been traced by Miss Murray. They are mostly in the British Museum, Graeco-Roman Department, and some at South Kensington.

Above these is an inscription from a wooden lintel found at Rifeh, apparently belonging to the scribe Phibamon.

45. Pl. LIII. The inscription 1 is a dedication by "Alexander the Rhetor to the most prolific Nile." It is on the edge of a slab of marble, bought at Memphis. It was doubtless the base of a group of sculpture; and—as Dr. Cecil Smith remarked—it probably gives the correct name of the group of the Nile with children around, Nilos Gonimōtatos. 4

is a roughly cut block found at Memphis, with the dedication "In the name of the Father and of the Son and of the Holy Ghost." Nos. 1, 5 and 6 are in the British Museum, Graeco-Roman Department. Nos. 8, 9 and 10 are tracings from ink writing on plastered walls, not removed. The inscriptions 7 and 14 are at Brussels, 13 at Dublin, 11 and 16 at New York. No. 14 has not been engraved in the lower part, the outlined letters being left only in red paint.

We may add here the destination of some other things. In *Athribis*, Pl. XXIX, the scene of Auletes and his *ka* is now at Edinburgh. In Pl. XIX the nome figures are at Brussels, Munich and Bristol.

In *Gizeh and Rifeh*, Pl. XXXVII B, some of the chair legs are at South Kensington, Nos. 11, 13, 16 at University College, 9 at Brussels, 10 at New York, 14 at Rochdale, 15 at Munich. In Pl. XXXVIII, 1 is at South Kensington, 8 at University College, 9 at Brussels, 10 at Cairo, 6 at Philadelphia, 11 at Munich, 12 at Oxford. The parchment and papyrus documents, and fragments, are all at the Bodleian Library, Oxford. In Pl. XXXIX, 1 is at Cairo, 2 at University College, 3 at New York. In Pl. XL, 1 is at New York, 2 and 3 at Brussels, 4 at University College, London.

CHAPTER VII

THE TERRA-COTTA HEADS.

46. THE finding of the foreign quarter of Memphis was one of the main objects of the opening campaign there. But the discovery of the portraits of the foreigners was not even thought of; and only gradually was it realised that we had before us the figures of more than a dozen different races, see Pls. XXXV to XLIV.

The date of these models is indicated by the Persian figures (16, 18), probably made during the Persian occupation, 525 to 405 B.C., and the archaic Greek (56) which is of the VIth century B.C. These, like most of the other heads, are modelled in solid clay. Only about half a dozen Greek figures, and the Indian woman (36), are moulded and made hollow, and these may well be about 200 B.C. A very rough variety of the Scythian horseman (46), moulded but solid, was found with the pottery group of about 300 B.C. We may then probably date the great majority, which are solid modelled figures, to about 500 to 300 B.C.; and the few moulded hollow figures from 300 to 200 B.C. The taste for representing

foreigners is well known throughout Egyptian history, and some of the best and most characteristic work was spent on foreign figures. This was not a subject for the Greek, he despised the barbarian too much; but there is a Greek ability about many of these in the technical detail. It seems probable that they are the work of mixed Graeco-Egyptian artists. They are almost all found in the foreign quarter.

47. The figures on Pl. XXXV are all probably Egyptians, with some southern mixture. Of these, 5 to 13 are the regular Egyptian figures of a woman on a couch, sometimes with a child. Such were made as early as the XVIIIth dynasty, and on to Greek times; and they hardly belong to the general class of these ethnic types. The large earring of No. 1 is certainly Egyptian. No. 2 is like the sturdy well-fed women of Middle Egypt; the swathing up of the hair when at work is seen in the tomb of Khnum-hotep at Beni-hasan. 3 and 4 are of the southern type with prognathous face, and close curly hair. 14 is Egyptian by the hair dressing, and the face is of the higher-class type. 15 would be probably Egyptian by the hair; but the type is not familiar. It is remarkable that all the Egyptian figures are women; whereas out of 44 others there are only 3 foreign women and 3 Greek women. This points to the immigrants being mainly men; and perhaps the Egyptian women were those living in the foreign quarter.

48. Pl. XXXVI. The great mover in promoting this foreign mixture was the Persian empire. By that magnificent creation the world-peace was established from the Indus to the Balkans, roads were made, trade was encouraged, and masses of men were moved from land to land in the army, so that Scythian and Indian fought side by side in Greece. The possibilities of peaceful commercial settlement had never been so extensive before. In 16 we see the Persian Great King, with his bushy hair, close-fitting tiara, and disc on the front; each of these distinctions may be seen on figures of the Persian kings. The high-bred Aryan type is well shewn in this head.

No. 18 is the cavalry officer, with the face swathed to keep off heat and dust, like the horseman on the Sidon sarcophagus (17). On the head is the lion's scalp, probably a regimental badge. Herodotus mentions of the Persian cavalry "that on their heads some of them wore brazen and wrought steel ornaments" (vii, 84). The face is delicate, and almost effeminate, in the slight brow and refined eyes.

No. 20 is the most vigorously modelled head of all. It is carefully finished, the detail of the ears being precise. The flesh parts are coloured red, and the hair black. The type is that of the Semite, as shewn in the chief of the Amu at Benihasan (19), but sturdier and fatter owing to a settled life. It probably represents the Syrian or Jewish trader.

49. Pl. XXXVII. No. 22 is of the old Sumerian or Akkadian type, as shewn by the limestone head from Babylonia (21). And 24 is another Sumerian type, as shewn by a limestone head from Tell Loh (23). These limestone heads have been recognised as Sumerian by Dr. Meyer (*Berl. Akad. Abhandlungen*, 1906, III); and the resemblance of the pottery heads from Memphis is so close that they must be accepted as the same race. This has surprised Assyriologists, as the racial type was supposed to have died out with the Turanian language, before 2000 B.C. (*Zeit. Assyr.* xxii, 199). Yet Dr. Pinches has remarked that this type is seen in the Nestorian Christians from Babylonia, who are likely to have had less Arab mixture than the Muhamedans. It need not be supposed that the old Sumerian stock was unmixed; but rather that the type belongs to the land and the climate, and has subdued and unified all the mixture that was put into it. Likewise in Egypt, within a thousand years of a mixture, the old type of skull has entirely regained its dominance.

No. 26 is a peculiar type, from the high flat forehead, and the short, prominent, sub-aquiline nose. It may perhaps be compared with the type of Khammurabi (25), which has the same form of forehead and lips, and only a slightly thicker nose. It may be regarded as a Semitic Babylonian, unless some closer resemblance may be found in the Persian empire.

Pl. XXXVIII. Here are grouped together the various types for which no satisfactory connection has yet been observed. Perhaps coinage would be the fullest source for comparisons. Nos. 27 and 28 seem to be artificially flattened heads.

50. Pl. XXXIX. The figures of Indians are of different races. 35 is a Tibetan type, which is also found in Orissa. There is an ape on each side of the head. 36 is an Aryan Punjabi type; the attitude with the hip raised high on one side, the arms bent, and the loose lock of hair, are all Indian; but the band round the breast, the amulet hung round the neck, and the artificial navel line, are all strange and lack a comparison. 37 and 39 are seated cross-legged with drapery round the waist; 38 and 40 have the

knees raised, and a scarf over the left shoulder. These attitudes are familiar in Indian art.

Now there has been a strong feeling that as dated material has not been obtained in India before Asoka, therefore Indian civilisation was not of much importance in earlier days. But that is merely a result of the early prevalence of wood-work, owing to which stone monuments were not yet erected. The magnificent stone pillars and carvings of Asoka prove that a long growth of art and skill had preceded them; and the account of the country at the time of Alexander shews that a high civilisation existed then. As early as Darius, about 500 B.C., the India subject to the Persians was the most populous province of that empire, and yielded 360 talents of gold yearly. The Indians fought in Greece with Xerxes 480 B.C., and when Mardonius picked the flower of the army to stay in Greece, he took the Persian Immortals, Medes, Sacae, Bactrians, and Indians. The contact of India with Europe dates then to the early years of the Persian empire.

Settlements of Indians appear at Nippur in Babylonia, as early as 425 B.C., and in the Aswan papyri in Egypt.

In view of these connections there seems no difficulty in accepting the Indian colony in Memphis as being due to the Persian intercourse from 525 to 405 B.C. And the introduction of asceticism, already in a communal form by 340 B.C., points also to the growth of Indian ideas. To date these solid modelled figures, 35, 37-40, to the Vth century B.C., and the hollow moulded figure, 36, to the IIIrd century B.C., in accord with the general dating of the other figures, seems therefore the most reasonable result. The importance of such tangible remains of India, as bearing on the Indian colony, and the spread of Indian ideas in the West, will be obvious to all students.

51. Pl. XL. The other extreme of the Persian empire is seen in the figures of Scythians. The tall pointed hood, the bushy beard, and the riding on horseback, all shew that we have here the Sacae cavalry of the Persian army. For comparison see the head of a Scythian, 41, from the silver vase found at Koul-oba in the Crimea. These figures are all moulded, but solid, and therefore intermediate between the modelled solid figures and the moulded hollow figures. The roughest of them, 46, was found with the pottery in Pl. XLVI, and is dated therefore to about 300 B.C. It seems not improbable that these Scythians belong to the second Persian occupation, 342 to 332 B.C.

52. Pl. XLI. These heads seem to be more western in type. 47 is like the Roman figures, with the toga worn over the head, as in sacrificing, and as the *Fratres Arvales*. 48 recalls some of the wizen faces of the Roman republican busts. 50 should be compared with a glazed head found at Naukratis (*Nauk.* ii, xvii, 11), and the coins of Ptolemaic queens; it is perhaps a Macedonian.

Pl. XLII. Here are distinctively Greek figures. 55 may be Attys; 56 is of the archaic Greek type of face and hair, but not made by a Greek of that age; it is rather the Egyptian version of an early Greek. The graceful little figure, 57, is of a usual type; the instrument played upon is the Syrian *kinyra*. The other figures are also well known. 57 to 60 are all modelled hollow.

Pl. XLIII. These are later Greek works, some apparently grotesque, as 64, 66, 67, 69. Such are often found in Ptolemaic sites. All of the foregoing heads are kept at University College, London, for study with others that may be found.

Pl. XLIV. The group at the top left is of painted pottery, with black, red and yellow colours. These come from the Merenptah temple, and seem to be Mediterranean work of pre-classic time. They are now in the British Museum, Graeco-Roman Department.

The group of heads at the top right shew the rougher examples, most of which can hardly be identified as distinct types. Two of them are also published enlarged, 52, 53.

The horses and seated figures of the "snow-man style" at the bottom left hand, are a class well known at various other sites (Tell el Yehudiyeh, *Hyksos and Israelite Cities* XIX D; Naukratis, etc.) Their origin is yet unknown.

The rising handles of craters with Bacchic heads are usual elsewhere (*Naukratis* i, 42; *Hyksos Cities* XIX D). The types here with the thunderbolt, rosette, and lion's head are peculiar.

Plates XLV to LIV are already described in the previous chapter.



CHAPTER VIII

THE INSCRIPTIONS.

By Dr. J. H. WALKER.

53. Pl. V. This inscription is unfortunately in too fragmentary a condition to allow of any running translation. It contains a list of endowments, which

are given to perpetuate the service of mortuary offerings for the deceased, or else a list of gifts bestowed upon the noble by the King. Several good examples of these endowments exist, the earliest occurring in the biography of Methen, who died in the reign of Seneferu. He states that he received as a reward 200 arouras of land from the King, and a mortuary offering of 100 loaves every day, from the mother of the King's children. A large house was also presented to him with a garden, containing trees of various kinds, and a lake.

The inscription here contains a list, very similar to that of Methen. Methen begins his list by saying that he had 12 domains provided for him. Here in line 2 the number of domains mentioned is 13. These domains, situated in different nomes, were farms from which the stock of food, vegetables, wines, etc., required for the mortuary offerings were procured. The next sign is obscure, followed by the number 12, and then 5 arouras of land are mentioned, with their trees and a lake (?). The aroura of land was a measure very nearly equal to $\frac{7}{8}$ ths of an acre. In line 3 occur the determinatives of provisions, a loaf of bread, a cake and a jar of wine or beer followed by "pleasant provisions for the altar table of Anubis upon-his-hill, in the city of the pyramid of Senusert I, called 'the protection of the places.'" It is interesting to find the name of the pyramid of Senusert I,  for now the names of the pyramids of the first four kings of the XIIth dynasty are known. That of Amenemhat I is *Ka nefer*, of Senusert I *Khenem asut*, of Amenemhat II *Kherp*, and of Senusert II *Hotep*. In line 4 *biat* cakes are mentioned, a special kind of cake used in offerings, and 100,000 of *ash* grain, from the table of provisions, and *bed* grains of incense for burning in censers. In line 5, 40 birds of one kind are mentioned, and 50 of another kind, together with 1000 cakes and loaves and 100 *des* jars of beer, and 50 portions of divine provisions (?) "for the King of Upper and Lower Egypt Amenemhat I." In line 6, Sebek lord of . . . is named, and in line 7 "a great quantity of *aa* birds and 30 other birds." In lines 8 and 9 the scribe has probably misread the title of Ptah, and for  *Tenen*, which is a title of

Ptah, used in later times, has written  . In line 9, *nefert* with a four-sided determinative is a new word; it may mean that the preceding objects have 4 good square supports at their corners, or that they

consist of truly squared workmanship "for service in the ritual of the temple of Ptah . . . lord of the two lands." In line 10 is the name, with titles, of the owner of the stele, "the superintendent of the city, the Vezier and Chief Judge Ameny," followed by the cartouche with part of the King's name, Amenemhat.

54. Pl. VI. "(1) . . . (2) . . . his temple at Luqsor, with his divine cycle following him. When day dawned, and the 2nd day appeared (probably

 to be supplied, as in Pap. D'Orbiney, II,

lines 5-6) . . . (3) Thou art my son, my heir who comest forth from my body, as I exist, so thou existed, in the face of every land (?) . . . (4) doubling their means of subsistence. They recognise thee as my son, who comest forth from my body. They are collected together for the purpose of giving to thee . . . (5) He proceeded to the Royal house and placed him at the head of it, over the great house of his noble, eldest daughter H . . . (6) Amen. Lo, behold Amen comes, with his son in front of him, to the Palace, for the purpose of establishing the crowns upon his head, and of making long his span of life . . . (7) He does that which satisfies thee. He has turned his back upon evil, and has driven out deceit from the land. His laws are firm in presenting offerings each . . . (8) Crowned with the *nemes* crown, he has watched over the whole circumference of all lands in one place. The great name of this good god was fixed, his titles were given to him like . . . (9) He has made as his monument for his father Ptah South-of-his-wall, namely the making for him of a stele, carved out of hard quartzite stone, in front of this sanctuary . . . (10) Their . . . of real cedar for making glorious the house of birth, in order that a processional path may be prepared (?) for his father Ptah. He built for him a new temple . . . (11) . . . all their excellent . . . its columns of real cedar, worked with precious stones from Syria, and their capitals of electrum. There was made for it a spacious hall, a tabernacle (?) (12) and a middle chamber (? ). He desired that he should be more magnificent than any future king . . ."

55. Pl. VIII, 3. The King is smiting a foreign enemy before Ptah. In the square there must have been the King's two cartouches. Above the place where one should be, is "The good god, lord of the two lands." Above the other, "Son of the sun, lord of the two lands." Below the square, "Endowed with

life like Ra." Behind the King, "Every protective amulet of life, like Ra." Beneath is the figure of a man, and his sister kneeling, "Giving adoration to Ptah-Sokar for his *Ka*. Made by the superintendent of the serfs Ra-mes." "His sister, the lady of the house, Uia."

4. A similar scene with "Ptah, [lord of] heaven, lord of earth." "The Horus—mighty bull, son of Tum. The King of Upper and Lower Egypt, lord of the two lands. Men-Kheperu-Ra, the beloved of Amen King of the Gods." "The Horus, mighty bull, uniter of the diadems, son of the sun, lord of the diadems, Thothmes [beloved of] Ptah lord of truth, King of the two lands." Beneath is the name Ra-mes with indistinct titles.

Pl. X, 10. "O Ptah, listen to the prayer, made by Amen-mes." . . . 12. "Made by Tha . . ." probably the man's name is constructed in the same manner as that of Tha-hap-amu in Pl. XXXII. On the right is "Ptah South-of-his-wall, lord of Memphis (*ankh-tau*)." . . .

Pl. XI, 15. "Ptah, lord of truth, beautiful of face, creator of [art]." Probably  is to be supplied.

Below is the common formula to "Ptah, the hearer of petitions, made by . . ." The name of Ptah, in the centre, is written from left to right, whilst the inscription reads from right to left. 18. Three ears occupy the upper line, whilst two ears are represented in the lower line. In the narrow space left, the name of Ptah is written, with its component letters one below the other. 20. A man named Ra-mes, whose titles may be supplied as "scribe of the house of . . . of the two lands," is offering to Ptah and Sekhmet. Down the right side of tablet, ". . . every day, a span of life, without diminution . . . his sister, beloved of him, the lady of the house Tent-an." The woman is kneeling before the offering tables, "giving adoration to Ptah and Sekhmet, their rulers . . . that she may grant life, prosperity and health, to the *Ka* of the lady of the house Tent-an." Behind the goddess Sekhmet there was probably "[Sekhmet] beloved of [Ptah] to the *Ka* of the scribe of the house of . . . [Ra-mes]."

Pl. XII, 21. "Ptah lord of truth," and name of the man on the left, "overseer of the stone-workers (?) Iay." The man on the right is "the doorkeeper of the hall . . . Huy." 23. The common formula to "Ptah lord of all people, twice beautiful is the *Ka* . . ." 25. "Ptah [lord of] truth South-of-his-wall, the glorious god, listen to the petitions made by." The

space following is left blank, evidently for the purpose of allowing the purchaser of the tablet to fill in his name. Many ushabti figures are found, with a space left blank for the name of the owner to be filled in.

Pl. XIII, 30. "Adoration to the *Ka* of Ptah, lord of truth, the great one of might, the hearer of petitions" "made by the scribe Mahui."

Inscription on 49, Pl. IX. "May the King give an offering table to Ptah, lord of truth, beautiful of face, the creator of art, the great one of might, upon the great throne, in order that he may grant . . . within his city, to the *Ka* of . . . giving . . . to Ptah South-of-his-wall, that he may grant pleasantness of life within his house to the *Ka* of the superintendent of . . . Ptah-mes."

Pl. XIV, 31. A man offering to Ptah. In front of Ptah are his usual titles, and below, the common formula with Ptah, ". . . A good span of life, and a following . . . for the scribe of . . . beloved of his city, Ra deceased."

Pl. XV, 36. Ptah, lord of truth, in his shrine, and behind the shrine stands Sekhmet, beloved of Ptah. Here the name Sekhmet is correctly spelt (*cf.* Erman, *Ä.Z.*, 1891, p. 38). A man named Ra-mes, and his wife "the lady of the house," are kneeling before a table of offerings. 37. Merenptah offering to Ptah in his shrine. In the centre at the top of the tablet is the winged disc "the good god of Edfu, lord of heaven." On the left is the cartouche of Merenptah, "lord of the two lands, Ba-en-Ra, beloved of Amen." Behind Ptah stands the goddess Astarte, "lady of heaven, mistress of all the gods." 38. Four gods are named, "Amen-Ra lord of the thrones of the two lands" and "Khonsu" behind him, with "Ptah lord of truth" and "Sekhmet beloved of Ptah." 40, A. "The scribe, Ari-nefer." B. "The lady of the house, Henut." The praiser (?) of Horus, Iay." C. "Giving adoration to thy *Ka*, Amen-Ra . . . 'mery." D. "The officer Neh-neh (?)." E. "The officer of the making of offerings to the gods Na . . ." F. "The goldsmith (?)." G. "Giving adoration to Hapy-ankh . . . to Ptah, that he may grant a happy life, in conjunction with health of body, full of joy every day for the *Ka* of the scribe Ria." H. "His sister Huy." J, K, L. "Made by the singer of Amen . . . the lady of the house, Hery, . . . the lady of the house, Hert, daughter of Sekhemy." "Made by the necropolis-workman (?) Am-user and his son Neb-her." M. "Horus of the North." N. "[Guardian] of the gate, Kha." O. "Made by the . . . of Ptah, and his son Sa-pa-ir." P.

“. . . the lady of the house, the singer of Amen, Kiy.” Q. “The officer . . .” R. “Thothmes.”

Pl. XVI, 41. A woman offering before Min. There are two trees behind the god. Min is frequently figured with a peculiar shrine and trees behind him; for a very clear representation of this shrine, see *Athribis*, Pls. XX and XXIII. 42. Amen-Ra in the form of a ram with a fan behind him. Beneath is a woman kneeling, before an offering table “made by the lady of the house, Nehi, deceased.” 43. In the middle is the sign representing the orbit of the sun, and on each side the two *usat* eyes, which frequently represent the sun and the moon. On the left occurs the name Ahmes, the name of one of the seated men; and on the right apparently is the name of the other man, but the strange arrangement of signs does not look like a man’s name. In the centre the signs appear to be arranged in a punning order, below the sign of the sun’s orbit. The middle space is left blank, above it the alphabetical signs *nr* occur, and below it the same signs reversed, *rn*. The woman seated before a table with food is “his daughter Meni.” The woman standing is named “Muy.” 44. “Ahmes” is seated on the left, whilst a man named “Renanen,” in front of him, holds a dish with burning incense in one hand, and a vase with water flowing out in the other hand.

Pl. XVII, 45. Names and titles of Amen-Ra and Mut, and of Ptah and Sekhmet. Three men, the first of whom is named Huy with indistinct titles; the titles and name of the second are indistinct; the third is the scribe Khar, or “the Syrian.” The woman is named Usert. Beneath is a man with a censer named “the guardian, Rat,” with his sister, the lady of the house, Naynaka.” The other man is named “the overseer of the offerings, Ary,” with “his sister Meryt” and “his son Rama.”

56. Pl. XVIII. Altar of Amenhetep. “The hereditary prince, beloved of the god, the royal scribe . . .” (1) “May the King give an offering table to Sekhmet, the great one, beloved of Ptah, lady of heaven and mistress of all the gods, in order that she may grant (2) a good funeral after old age, and a burial in the cemetery on the west of Memphis to the *Ka* of (3) the hereditary prince, beloved of the god, the royal scribe . . . in Memphis, Amenhetep deceased. (4) May the King give an offering table to Ptah, lord of truth, the King of the gods, beautiful of face, the one who is on the great [throne], in

order that he may grant (5) a happy lifetime in beholding his glories every day, without ceasing (6) for the *Ka* of the hereditary prince, the treasurer of the King of the North, the confidential friend, (7) the royal scribe, his truly loved one, the great superintendent of the house in Memphis, Amenhetep, deceased.”

57. Pl. XXVI. 1. Inscription with cartouches of Ramses II. “. . . the Royal *Ka*, lord of the two lands, User-maat-Ra, Setep-en-Ra, endowed with life. May they grant a spending of years with pleasure of heart to the *Ka* of the hereditary prince . . . the Royal *Ka*, lord of diadems, Ra-messu-mery-Amen, like Ra. May they grant the receiving of cakes, which come forth from the presence, to the *Ka* of . . .” 2. “. . . I have pacified the two lands, consisting of people and all . . . Thy name of Smiter of the Asiatics.” 6. “All its circumference in the embrace of his two arms, as well as all life, stability and power of Anmutf, who adorns Ptah and does the things which please him in the great place . . .” 7. The two cartouches of Set-nekht. “User-khau-Ra, mery Amen, setep-en-Ra,” and “Set-nekht, mery Ra, merer Amen.”

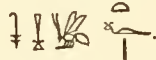
58. Pl. XXXII. A new title for a nobleman is used in this inscription . It is evidently formed on the plan of the title, which nobles frequently gave themselves in their biographical inscriptions, “the eyes of the King of Upper Egypt, and the ears of the King of Lower Egypt.” Although a noble might be “the King’s brother,” as the first part of the title might read, it is impossible that he could style himself “the father of the King of the North,” as the second part might read. I therefore suggest, as the translation, “he whose brother is the King of Upper Egypt, and whose father is the King of Lower Egypt.”

In the middle of the belt, “The worthy one before Sokaris.”

On left of middle, “The hereditary prince, the general of the army, the great one of the great ones, Tha-hap-amu, deceased.”

On right of middle, “The hereditary prince, he whose brother is the King of Upper Egypt, and whose father is the King of Lower Egypt, Tha-hap-amu, deceased.”

On the back, these same titles repeated, with the name, followed by “(1) May the King give an offering table to Ptah South-of-his-wall, lord of Memphis (*ankh tau*), and to Sokaris-Osiris, the great

god, lord of the tomb. Funeral offerings to . . . (2) He increased exceedingly the beautiful wall, it was raised . . . the shrines of the gods. Offerings were placed upon their altars, according to their desires . . . (3) his *Ka* for ever. He whose brother is the King of Upper Egypt, and whose father is the King of Lower Egypt, Tha-hap-amu. . . making a monument in the temple of Ptah, the chapel of Horus (?). May his Kingdom be like Ra in heaven, first amongst the living *Kas*."

59. Coptic and Greek. Pl. LII. In the middle of the inscription the Coptic cross is written. The translation is probably "The *sakho* Phaebammon." For several instances of the word *sakho*, which is also spelt *sakha*, see *P.S.B.A.*, 1899, p. 249. The meaning is "the learned man, or teacher." Dr. von Lemm connects the word with ⲬⲁⲢ, and this may account for the spelling in this inscription. Two examples of the word occur, in Crum, *Coptic Ostraca*, Nos. 36 and 133, and others in his Catalogue of the British Museum Coptic Manuscripts.

Pl. LIII. Greek inscriptions.

1. "To the most prolific Nile. The Rhetor Alexander."

4. "In the name of the Father, and of the Son, and of the Holy Ghost."

5. "of the skilled workmen."

Coptic inscriptions.

7. "Our brother (?) . . . The Father, and the Son, and the Holy Ghost. Our Father Adam, and all the righteous children. Our Lady Mother Mary, our mother Eve. The patriarchal fathers, and the prophets and the martyrs. The apostolic fathers. The twenty-four elders. Our father Apa Apollo. Our father Apa Peter. Our father Apa John. The saint Apa Pgol (?) the saint Apa . . . and all the holy ones. [Remember] the soul of the deacon [Apol]lo, who has died in peace. Amen."

In connection with the 24 elders, an interesting list of names occurs, in the deserted Monastery of Amba Samaan, see *Recueil de Travaux*, xv, p. 179. Christ is seated on a throne with four long-winged figures standing by His side, and 24 figures seated, forming a frieze below. The names of these figures are formed, each of a letter of the Coptic alphabet, with the termination "ael" added on to it, thus ending like the names of the archangels Michael, Raphael, etc. There is a part of a similar, though not identical, list of alphabetical names given to them in Crum, *British Museum Catalogue of Coptic MSS.*, p. 418, No. 1007.

9. "The Saint Theodorus . . ."

10. "I Apollo (?)."

11. "Isaac . . ."

Pl. LIV. Tombstones.

12. "The good God. Remember Apa Abraham, the man of Panaho. He died on the 4th day of Athyr, in peace. Amen."

Panaho, in Lower Egypt, was near Terenuthis, on the Canopic branch of the Nile.

13.—"The good God. Apa Thomas, Apa Peter, Apa Joseph, Apa Anoub, Apa Pamoun, all the holy ones. Remember Apa Victor, the man of Touhonesouo (?). He died on the 4th day of Phamenoth, in peace. Amen. Apa Victor, the man of Hage. Amen. The 13th Indiction, the 15th year."

Touhonesouo seems to be the name of the town where the deceased Victor lived, unless *nesouo* is an epithet of Touho, which was a town in middle Egypt, called by the Arabs Taha, and by the Greeks Theodosiopolis. Hage, where Victor, who put up this stone in memory of his namesake, lived, is mentioned in Zoega, p. 366. It was a mountain near Apollinopolis Parva in Upper Egypt.

14. "The Father, and the Son, and the Holy Ghost. Our father Apa Apollo. Our father Apa . . . Our father Apa John. The Saint Apa Pgol—all the holy ones. Remember the soul of Pasanshenoute, the man of Tahnou . . . (?). He died on the . . . day of . . ."

15. (1) " . . . the Holy Ghost. (2) . . . father Micha . . . (3) our Mother (4) 24 . . . (5) (6) . . . the Holy [Ghost ?] (7) (8) our father (9)"

16. "Jesus Christ. Our father Apa Apollo. Apa Peter. Apa John. Remember my brother, the God-loving John, the man of (?) . . ."

Sir Herbert Thompson has made a most interesting suggestion to me, concerning the first line of tombstone No. 7 on Pl. LIII. He proposes ⲬⲞⲚ for ⲬⲞⲚ at the end of the line, and suggests the reading ⲚⲞⲬⲞⲚ ⲓⲗⲧⲣⲓⲈ ⲚⲈⲪⲬⲞⲚ "the monk Hatre, his brother." Several such additions are known, at the bottom of a tombstone, where the man who erected the stone to the memory of the deceased records this fact. No other case seems to be known of its occurrence at the top as here. ⲚⲞⲬⲞⲚ and ⲚⲁⲬⲞⲚ are both commonly used, with the meaning of "brother" in the sense of "monk," without any possessive value for ⲚⲈⲚ or Ⲛⲁ. The most striking proof of this is in the formula ⲁⲚⲞⲬ ⲚⲁⲬⲞⲚ, "I, the monk," with the name following.

INDEX

- Aahmes II, king, 2, 3, 4
 Aahmes, private, 8, 20
 Aay, 7
 Agathodaimon on block, 13
 Akkadian heads, 16
 Alabaster colossus, 5, 10
 inlaying, 12
 Alexander the Rhetor, 15, 21
 Altar of offerings, glazed, 14
 Amen, ram of, 8
 temple, 3
 Amenemhat I, 7, 18
 II, 4
 III, 2
 Amenhotep, 8, 20
 Amen-mes, 19
 Ameny, 7, 18
 Am-user, 19
 Ancient authorities, 1
 Ankh-ef-ne-amen, 13
 Ankh-ef-ne-mut, 13
 Ankh-taui, 4, 6
 Anubis shrine, 4
 Apa Abraham, 21
 Anoub, 21
 Apollo, 20, 21
 John, 20, 21
 Joseph, 21
 Pamoun, 21
 Peter, 20, 21
 Pgol, 20, 21
 Thomas, 21
 Victor, 21
 Aper, temple of Osiris Sokar, 4
 Aphrodite, foreign, 3, 4
 Apis bull, 2, 8
 temple of, 3
 position of temple, 3
 Apries, 4
 Ari-nefer, 19
 Arsinoe, 14
 Ary, 20
 Aryan Punjabi head, 16
 Aseskaf, 2
 Asklepion, 3
 Astarte on tablet, 8, 19
 Asychis built propylaia, 2
 Aten adored, 4
 Ater, name of Sacred Lake, 3
 Athribis, antiquities from, 14, 15
 Attys, 17
 Auy, 13
 Bacchic handles, 17
 Badge of cavalry officers, 16
 Bahti, 4
 Bak-ne-ra, 7
 Basalt outside of hall, 9
 Bast playing lute, 12
 temple, 4
 Blue glazed pottery, 14
 Bolt of bronze, 12
 Bottles of glass, small, 15
 Breccia statue, 13
 Brick pit, position of, 3
 Brother of the king, 20
 Buttrressing of cracked gateway, 11
 Calcite beads, 12
 Cambyses, 4
 Captive countries, 10
 Centre of civilisation at Memphis, 2
 Ceremonial crosses, 15
 Chain of bark, 15
 Chisel, 12
 Colossi, 5, 9
 Colossus, 2
 Columns, arrangement of, 5

- Columns, clustered, 10
 engaged, 9
 sizes, 9
 Cones of blue pottery, 12
 of rough pottery, 15
 Coptic pottery, 15
 Coronation stele, 18
 Crosses, ceremonial, 15
 Cufic glazed pottery, 15
 Cypriote pottery, 11
- Diodoros, 1
 Drill cores, 14
- Eagle of bronze, 15
 Ears on tablets, 7, 8
 Eastern propylaea, 2
 Egyptian figures all women, 16
 Egyptians, heads of, 16
 Endowment stele, 7, 17, 18
 Exploratory work, 4
- False doors of granite, 8
 Fat, 4
 Fish-harpoon, 15
 Foreign Aphrodite, 3, 4
 Foreigners, portrait heads of, 15
 Fortress plan hieroglyph, 3
 Foundation deposits, 8
 Fuat, 4
 Funeral sacrifice, 10
- Gate of camp, 12
 Gateway of Merenptah, 3
 Glazed tile of Sety II, 12
 Gods of Memphis, 2
 Goniṃōtatos, epithet of Nile, 15
 Granite colossi, 5, 10
 Greek archaic head, 17
 heads, 17
 pottery, early, 3
 Gregg, Mr., 1, 10
- Hage, 21
 Handles of craters, 17
 Hapamu or Thahapamu, 13, 21
- Hathor Aphrodite, 3, 4, 12
 of Hotep-hem, 12
 of Nehat, 12
 of Tepahu, 13
 tablets of, 4, 12
 temple, 3
- Hatre, 21
 Hatut, 4
 Henut, 19
her zed medu, 13
 Herford, Miss C., 1, 14
 Herodotos, 1, 2, 12
 Hert, 19
 Hery, 19
 History of Memphis, 2
 Hittites, 4
 Hotep-hem, 12
 House charm, 13
 model, 13
 Hutch for mouse, 13
 Huy, 7, 8, 19
 Hypostyle hall, 3
- Iay, 19
 Imhotep temple, 3
 Indian civilisation, early, 17
 colony in Memphis, 17
 contact with Europe, 17
 heads, 16
 Inscriptions translated, 17
 Isaac, 21
 Isis temple, 3
 Island figure, 12
- Jewish trader, head of, 16
 Jews' quarter, 4
- Ka* of gods, 7
 of kings adored, 10
 Kabiri temple, 4
 Kafr el Qala', 1
 Karnak, temple of, 2
 Khaemuas, 8, 10, 11
 Kharu, 8, 20
 Khnum temple, 4
 Khred-ne-mut, 13
 Kiln for pottery, 14
 Kinyra played on, 17

- Kiy, 20
 Kom el Qala', 3
 Hellul, 14

 Lamp and holder, 12
 Lamps of 200 A.D., 14
 Leather-worker's knife, 15
 Limestone casing-stones, 6
 colossus, 5
 Lion of bronze, 12
 Lion's paw spout, 9
 scalp a badge, 16
 London compared in size, 1
 Lotus capitals, 6, 11

 Macedonian head, 17
 Mackay, Mr., 1
 Mahuati, 7; or Mahui, 19
 Makaukas, John, 2
 Mask of pottery, 14
 Measures, 12
 Menat, 8; or Meni, 20
 Menes founded Memphis, 2
 Merenptah, gateway of, 3, 11
 inscription of, 9
 tablet of, 8, 19
 Mer-ra, 8
 Meryt, 8, 20
 Methen, 18
 Mitrahineh, 9
 Moiris built propylaia, 2
 Moulds for amulets, 12
 Museums receiving objects, 8, 12, 15
 Muy, 20

 Nana-uab, 8
 Naynaka, 20
 Neb-her, 19
 Nefertum statuette, 14
 Nehat, 12
 Nehati, 8
 Nehi, 20
 Nehneh, 19
 Neit temple, 3
 Nekht-hor-heb, 13
 Nile, most prolific, 15, 21
 Northern propylaia, 2
 Nurse of royal son, 12

 Offering of bread rolls, 8
 Offerings, table of, 6
 Onyx disc, 12
 Osiris-Sokar temple, 4

 Pa-hennu, the Serapeum, 3
 Palm capital, 9
 Panaho, 21
 Pa-penat, temple at, 4
 Pasanshenoute, 21
 Pa-ta-yaht, 4
 Pellets of burnt clay, 11
 Persian cavalry officer, 16
 empire, greatness of, 16
 Great King, head of, 16
 Phibamon, 15, 21
 Phoenician Tyrians, 3
 Physkon, 14
 Piy, 7
 Pond, clearance of, 9
 Pottery figures painted, 11, 17
 of 300 B.C., 14, 15
 Primitive settlement, 2
 Proteus, temenos of, 3, 11
 Psametek I, 2, 3
 Ptah, temenos of, 2
 temple of, 2
 Ptah Tanen, 9, 18
 Ptahmes, 7, 19
 Ptolemy IV, 2, 14
 V, 3
 IX, 14
 Pumping water, 9
 Pyramids, casing from, 6, 9

 Qen, 8
 Quartzite, 13

 Ram of Amen, 8, 20
 Rames, 7, 18, 19
 Ramessu II, 2, 4, 6, 8, 10, 12, 20
 III, 2, 9, 10
 Ranuser, 6
 Ra-shepses, 6
 Rat, 20
 Ray, statue of, 8
 Renanen, 20
 Rhampsinitos, 2

- Rolls of bread offered, 8
 Roma, 8, 20
 Roman heads, 17
 Rope binding on columns, 10
 Rubbish thrown in court, 11
- Sacae figures, 17
 Sacred Lake, 3
Sakho, a teacher, 21
 Scarabs found, 13
 unfinished, 11
 Schuler, Herr, 1
 Scythian figures, 17
 Sebek, 4
 Sekhemy, 19
 Sekhmet, reading of name, 8
 temple, 4
 Semitic head, 16
 Senusert I, pyramid of, 7, 18
 Sesostris, 2
 Set figured, 10
 Set-nekht, 10, 20
 Set-nen-nefer-tum, 13
 Sety I, statue, 2
 II, tile, 12
 Shabaka chapel, 10
 Sha-ne-ba, 13
 Siamen, building of, 12, 13
 Sickle flints, 12
 Sipairi, 8, 19
 Size of Memphis, 1
 Skew front of hall, 5
 South propylaia, 2
 Spur, 15
 Stadium in Egypt, 1
 Statues, colossal, 2
 Steatite discs and scarabs, 12
 Stilts for kilns, 15
 Strabo, 2, 3
 Strainers, 12
 Street lines, 11
 Sumerian heads, 16
 Sun-temple at Abusir, 6
- Supports in kilns, 14
 Syrian head, 16
- Tablets of XVIIIth dynasty, 7
 with ears, 7, 8
- Taha, 21
 Tahayba, 13
 Tahuti temple, 4
 Tahutmes I, 7
 IV, 7
 Ta-nenuny, 12
 Tent-an, 19
 Terra-cotta heads, 15
 Teta, lintel of, 6
 Tha-hap-amu, 20
 Thent-ant, 7
 Theodoros, 21
 Tibetan head, 16
 Touho, 21
 Trial pieces, 13, 14
 Trinity, dedication, 15, 21
 Tweezers, 15
- Uaat, 7
 Uafet, 4
 Uah-ka, Prince, 6
 Uia, 19
 Usert, 8, 20
- Vase working, 14
 Views of West Hall, 9
- Wainwright, Mr., 1
 Walker, Dr. J. H., 17
 Wall enclosing camp, 11
 hieroglyph, a fortress, 3
 Ward, Mr., 1
 Washing troughs, 11
 Waste beads, 11
 Wasters from kilns, 14
 West Hall, 5
 propylaia, 2
 White Wall fortress, 3

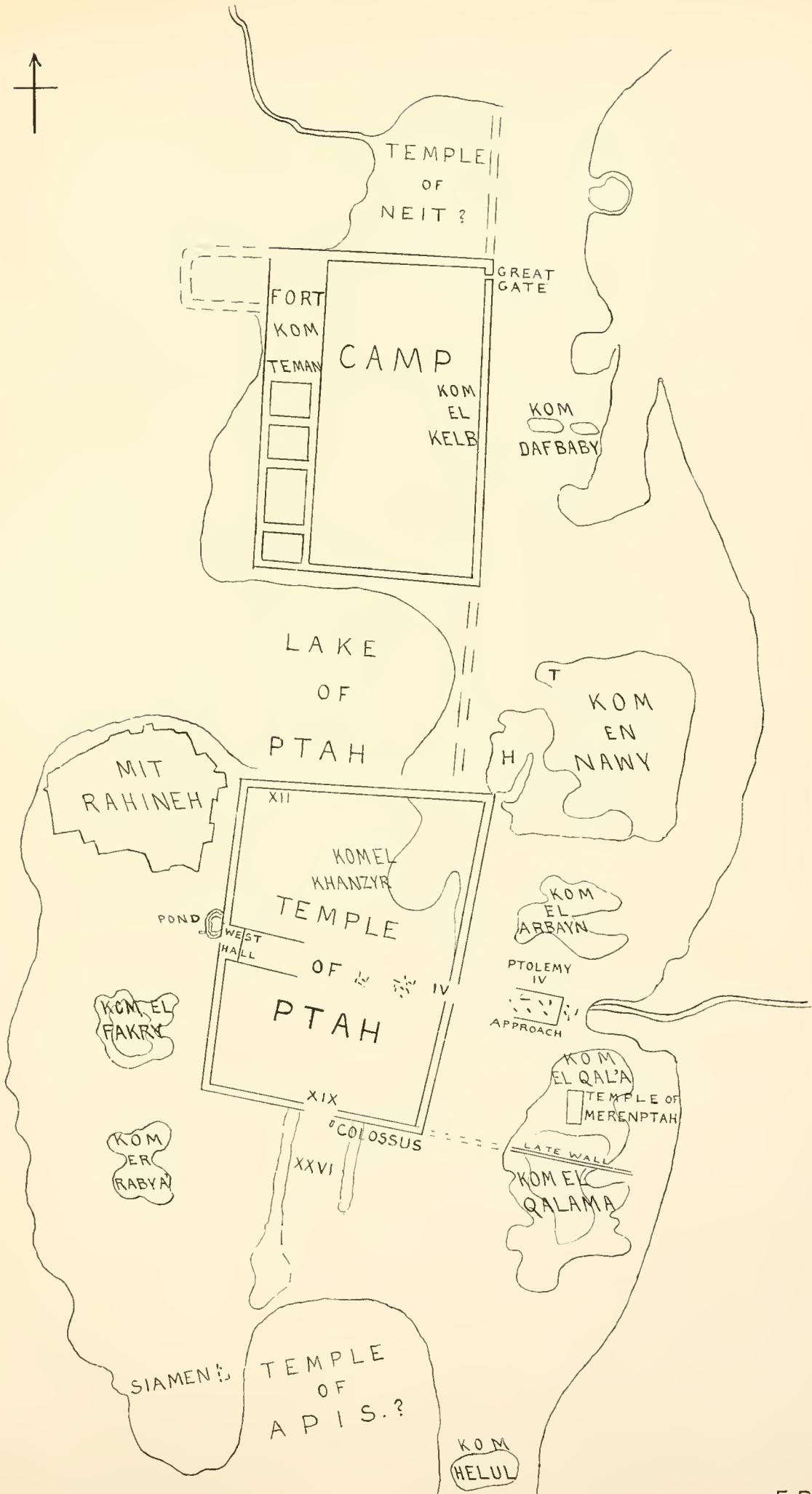

NEW YORK CITY
WASHINGTON SQUARE
LIBRARY

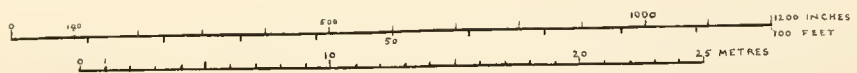
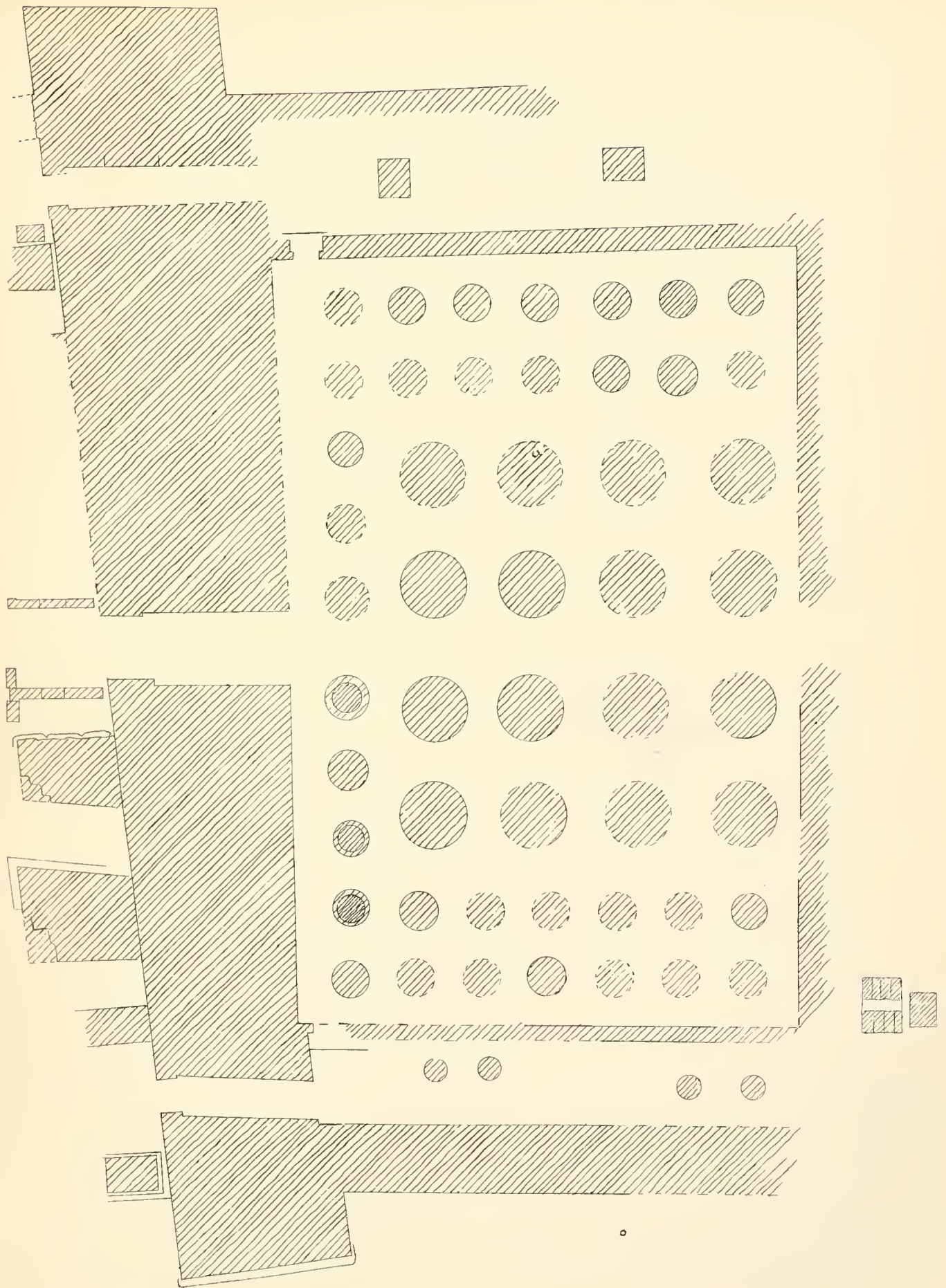



SLAB FROM A TOMB. REUSED IN TEMPLE OF PTAH.



CAPITAL, REUSED BY MERENPTAH.



GRANITE JAMB OF RANUSER.

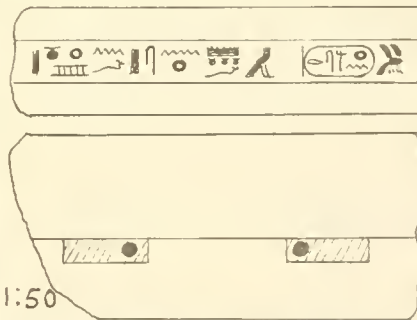

LINTEL OF RANUSER.

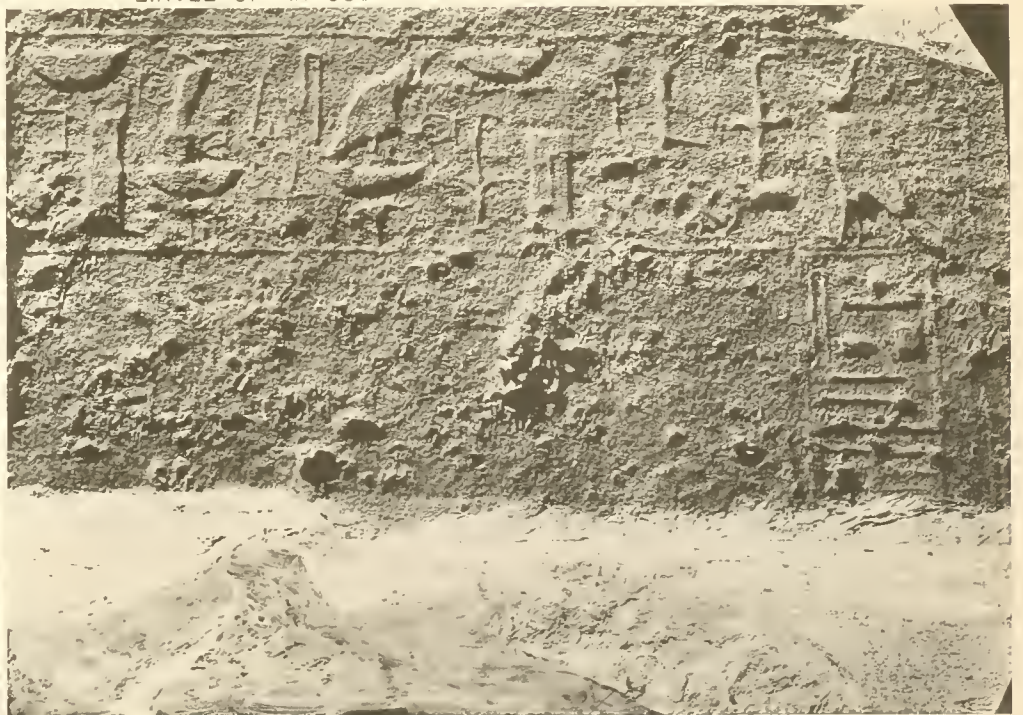

LINTEL OF TETA. REUSED IN TEMPLE OF PTAH.

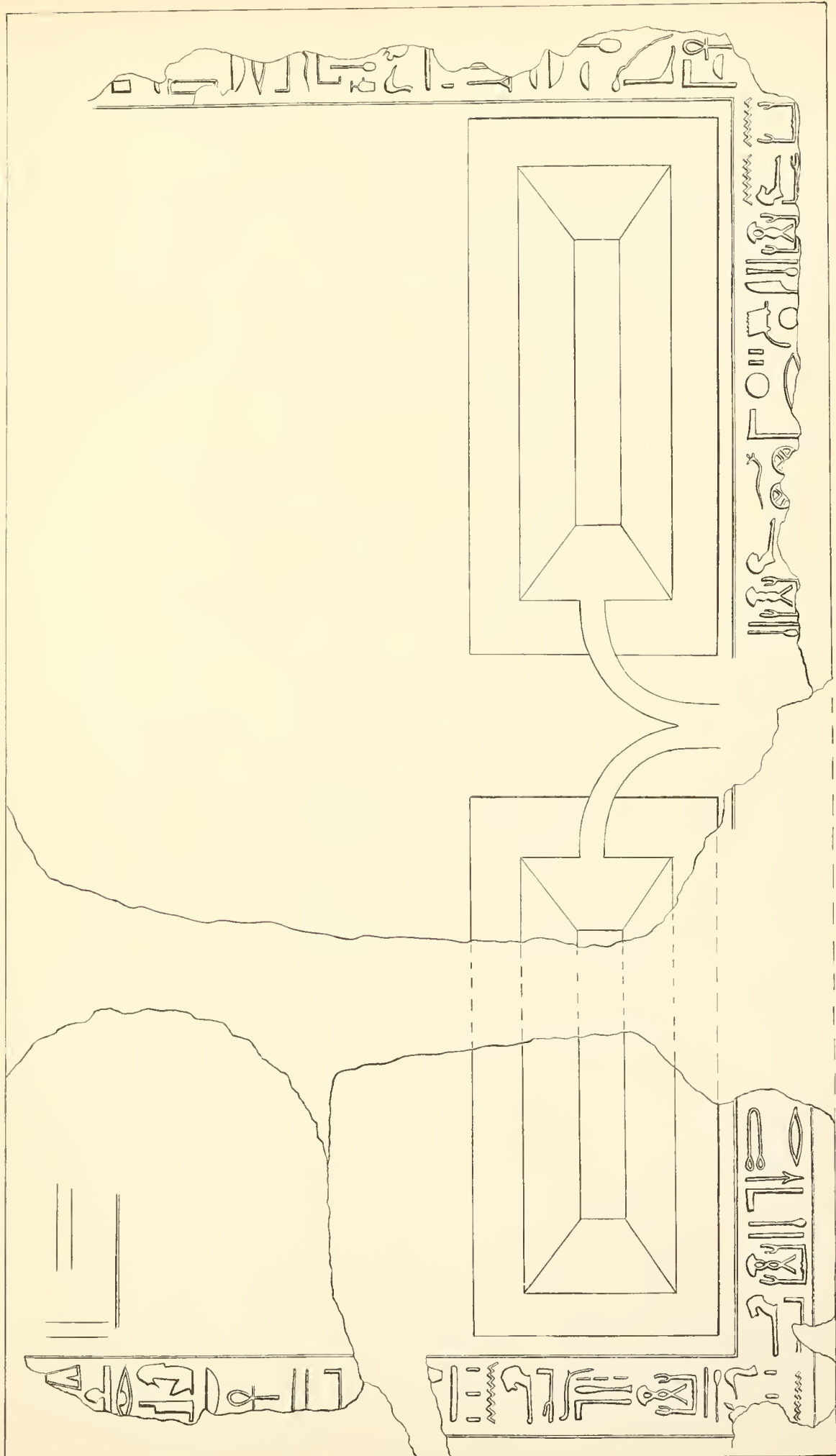

NEW JERSEY
MIDLAND STATE COLLEGE
LIBRARY

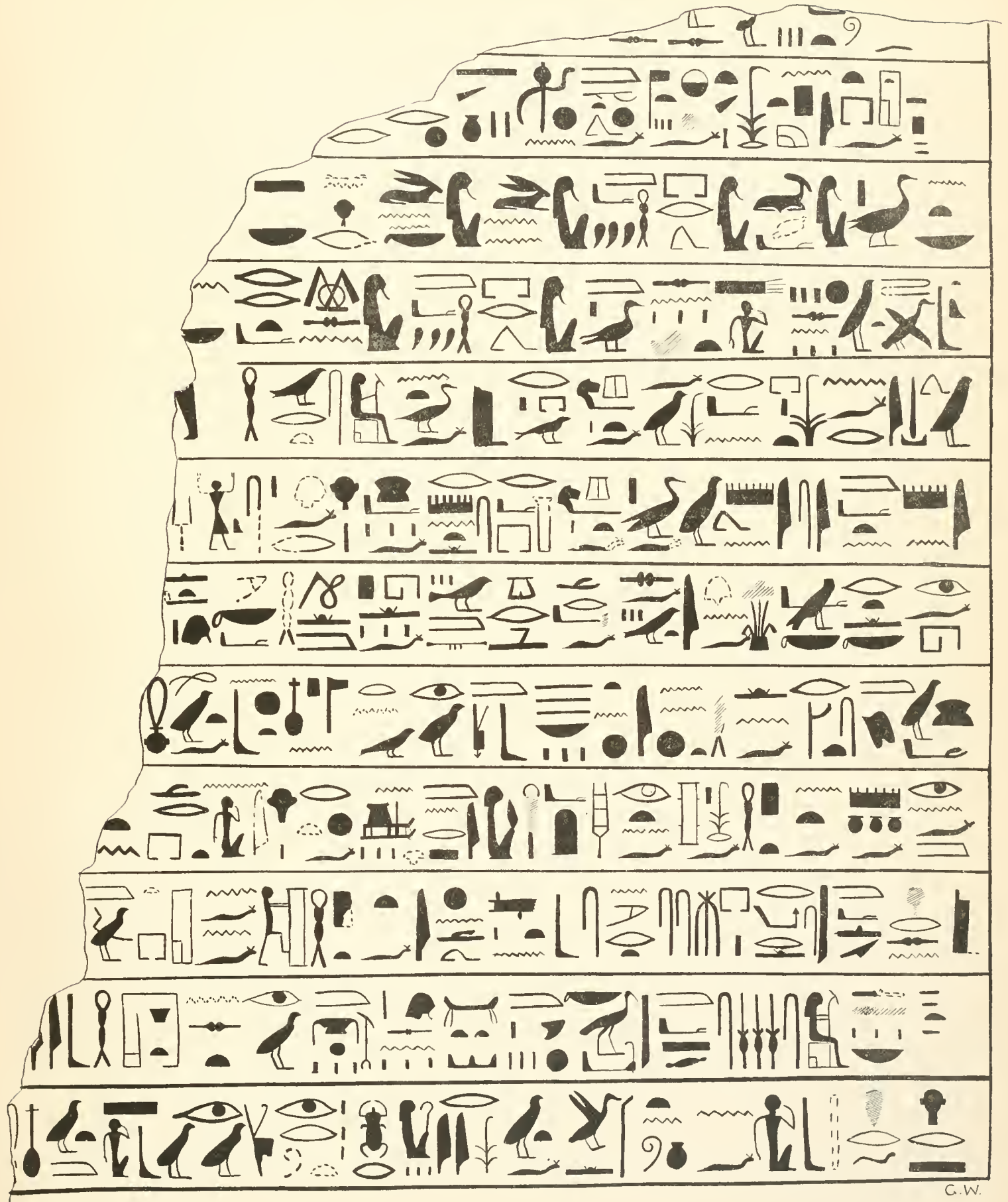



46



47





1

PL VII

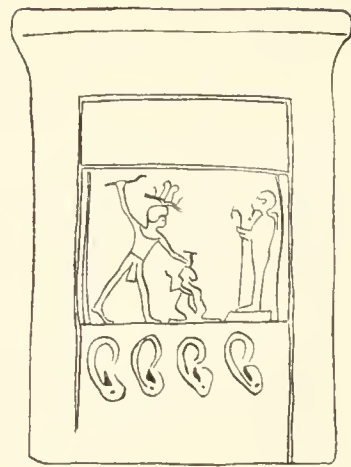

2

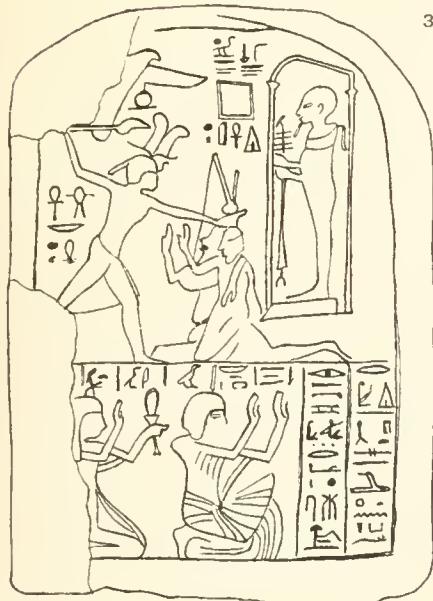

3

PL IX

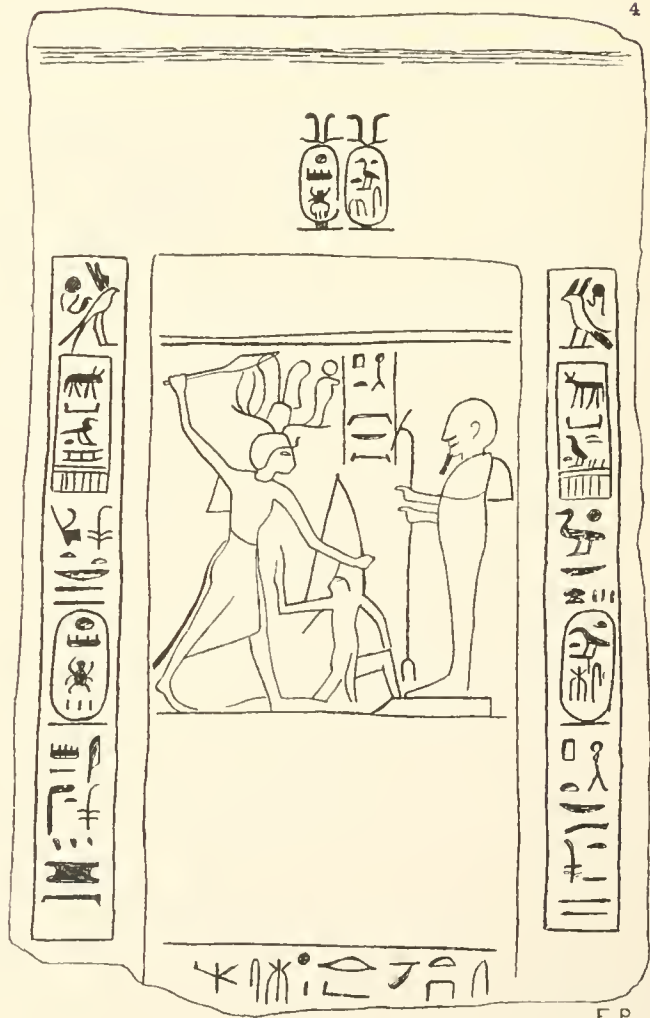

4

PL VII

F.P.

NEW YORK UNIVERSITY
WASHINGTON SQUARE COLLEGE
LIBRARY

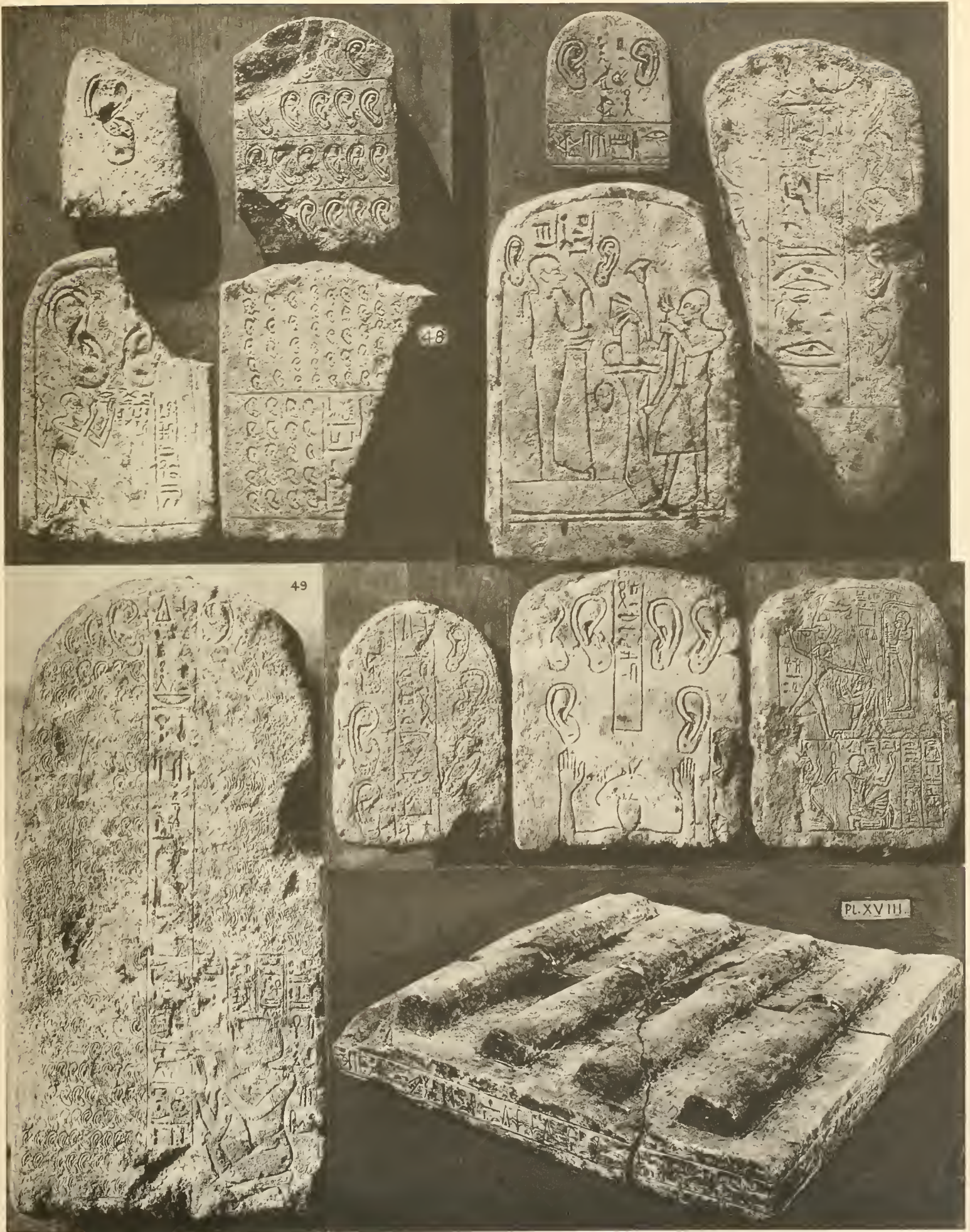

SEE PL. XIII.

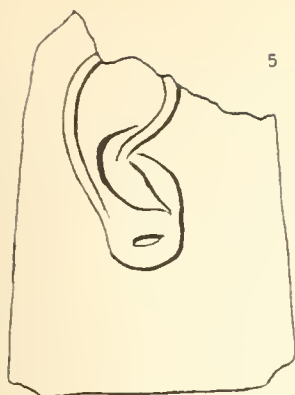

PL. IX

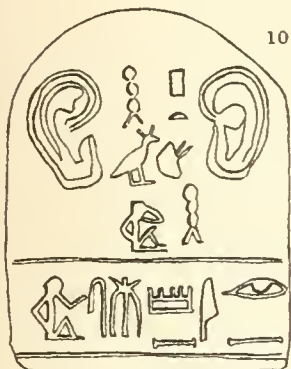
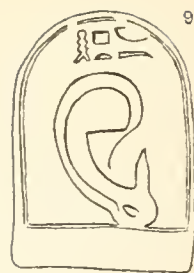
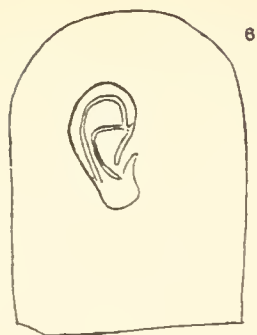

PL. IX

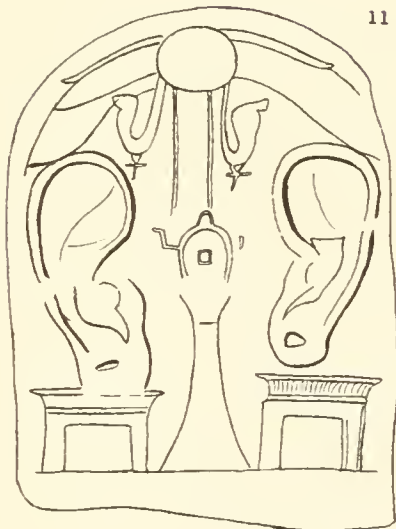

PL. IX

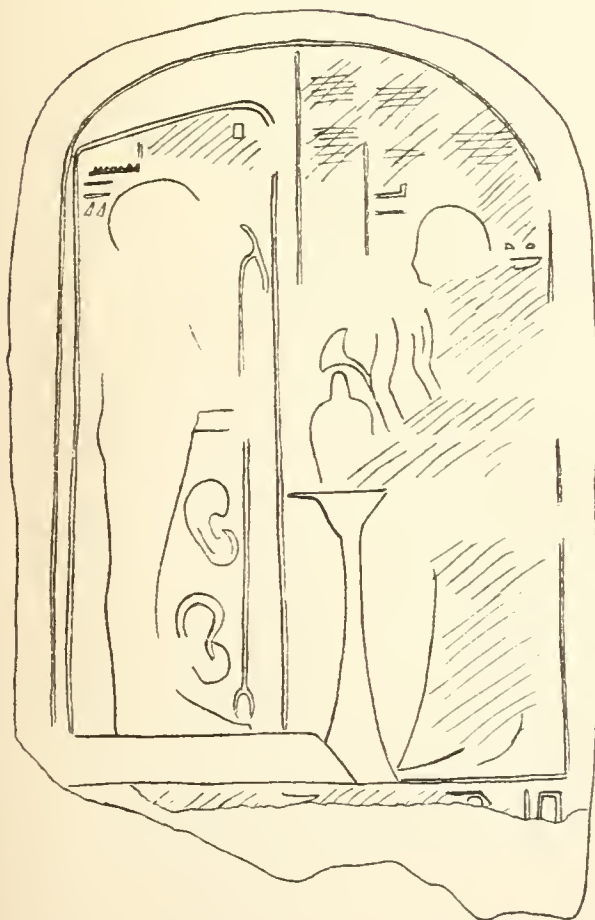

13



14

PL. IX

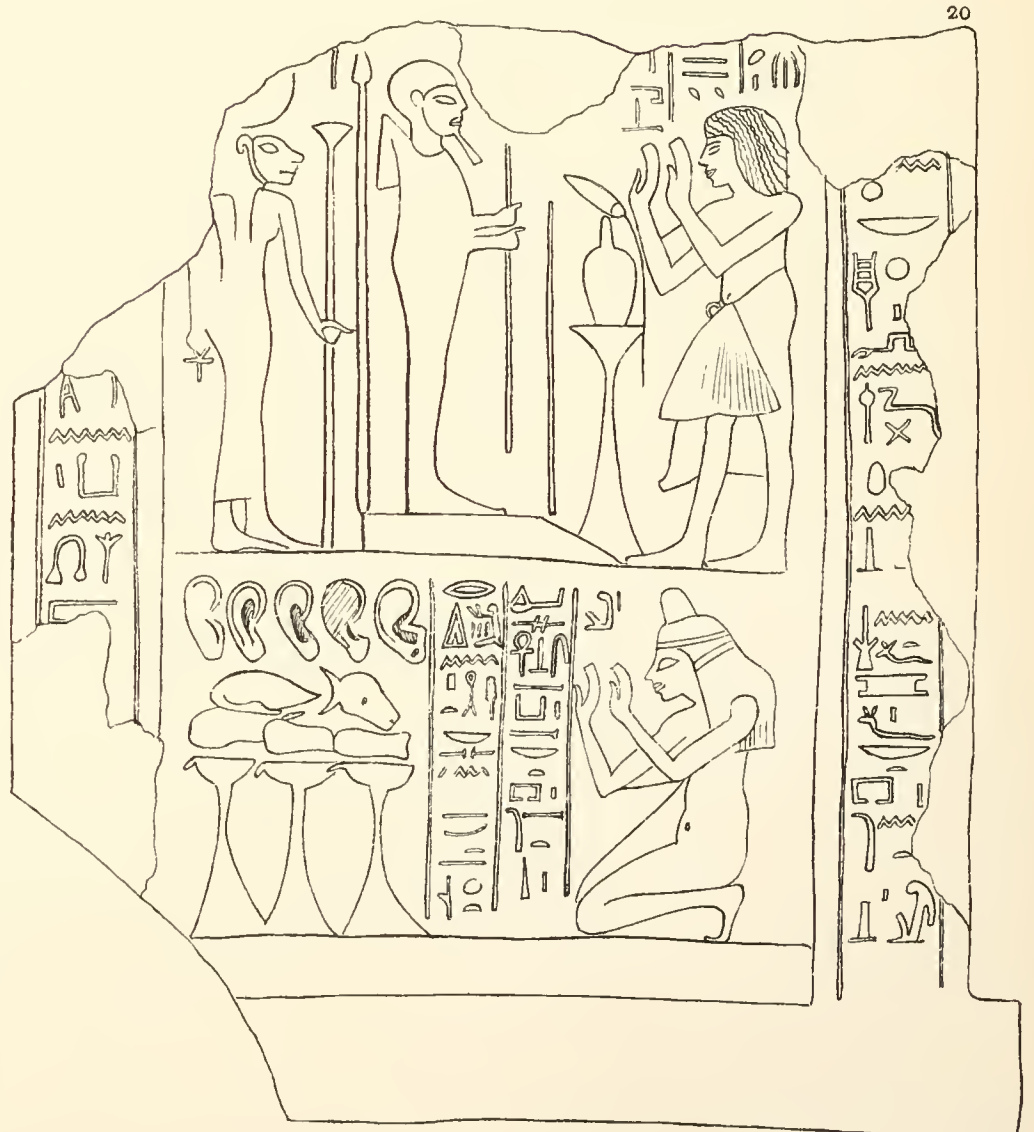
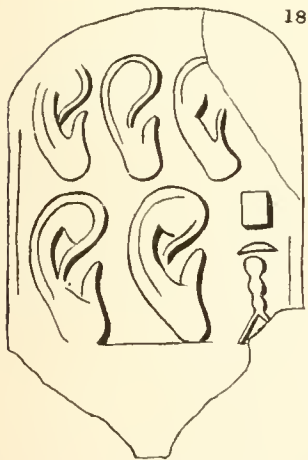
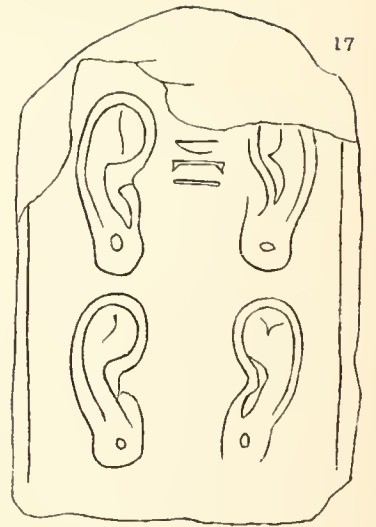
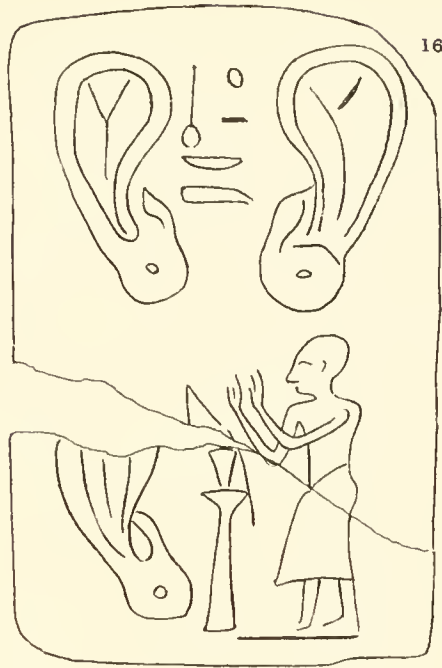
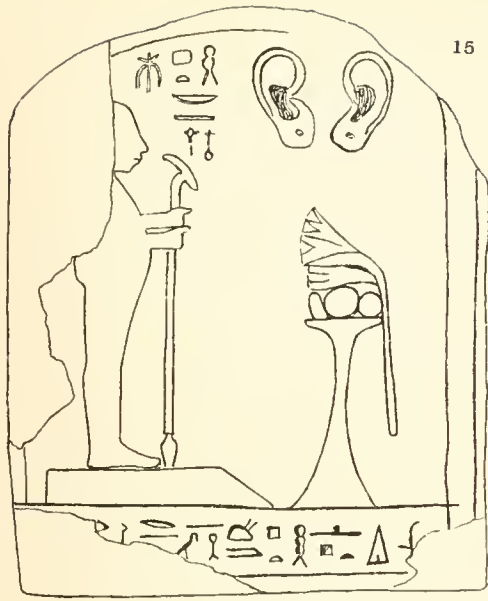

NEW YORK UNIVERSITY
WASHINGTON SCIENCE CENTER
• LIBRARY •

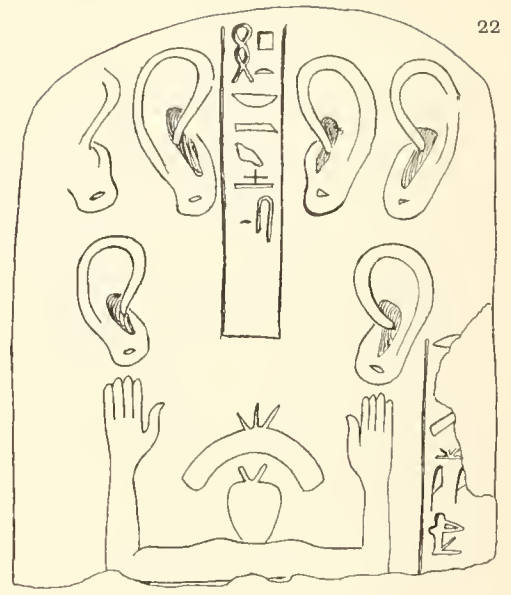
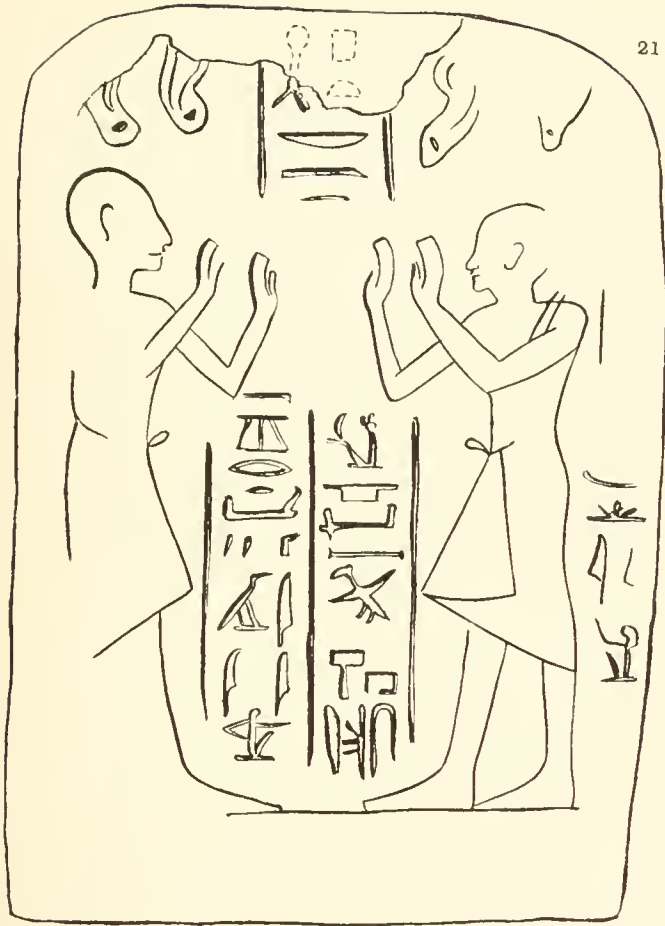

PL. IX



PL. IX

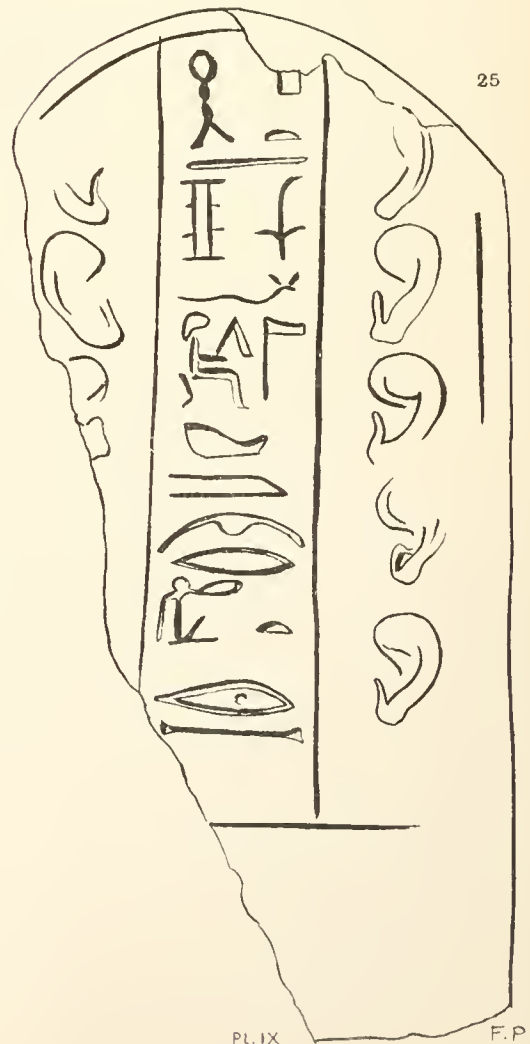
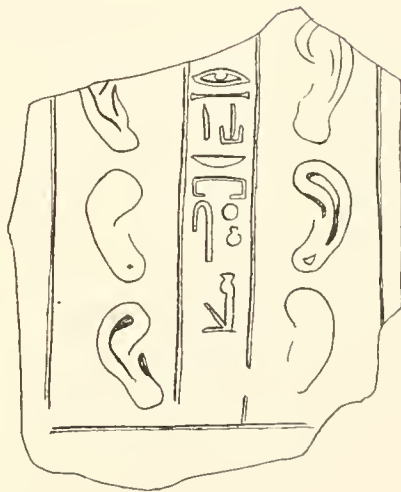

PL. IX

F.P.

THE UNIVERSITY OF CHICAGO
LIBRARY
540 EAST 57TH STREET
CHICAGO, ILL. 60637

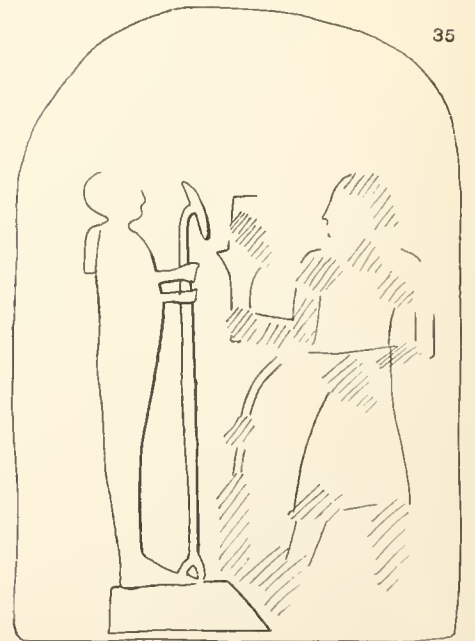
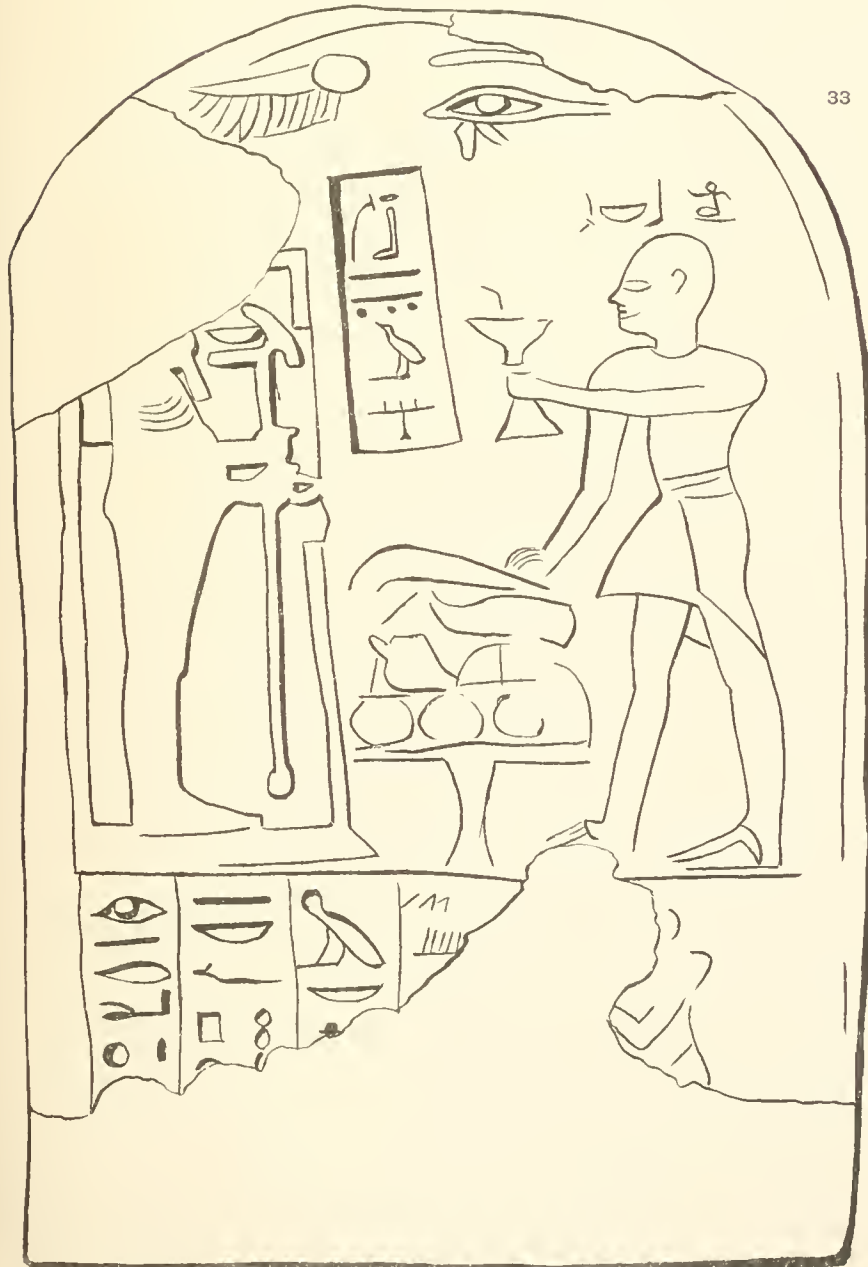

NEW YORK UNIVERSITY
WASHINGTON SQUARE COLLEGE
• LIBRARY •

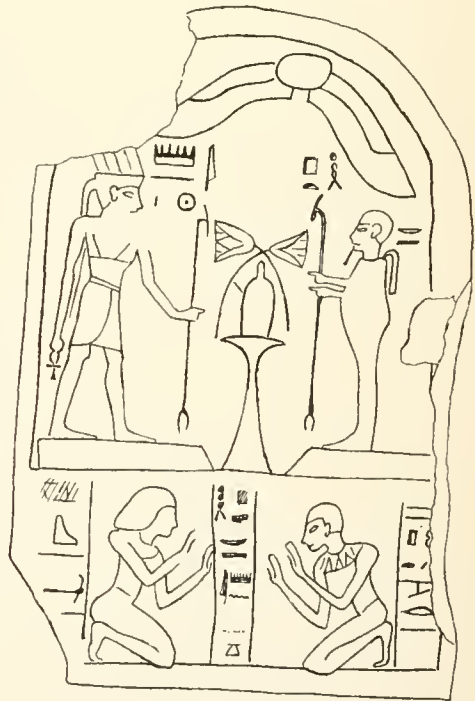
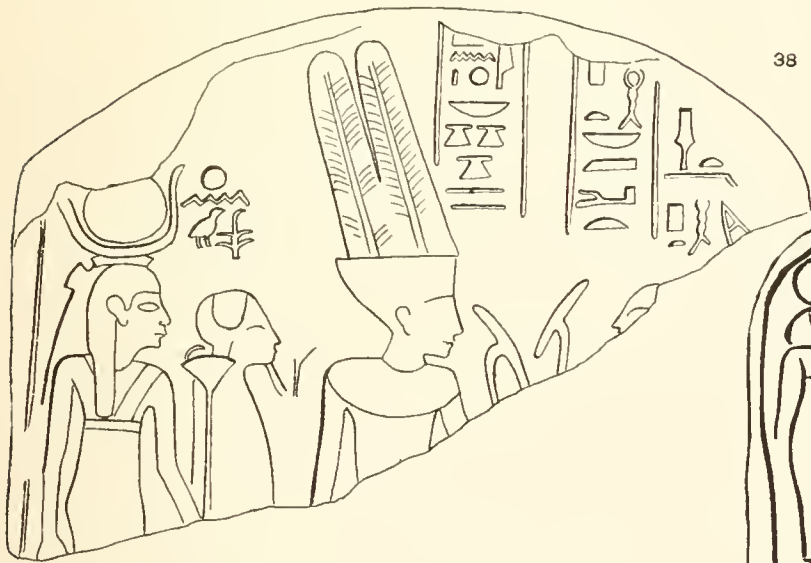
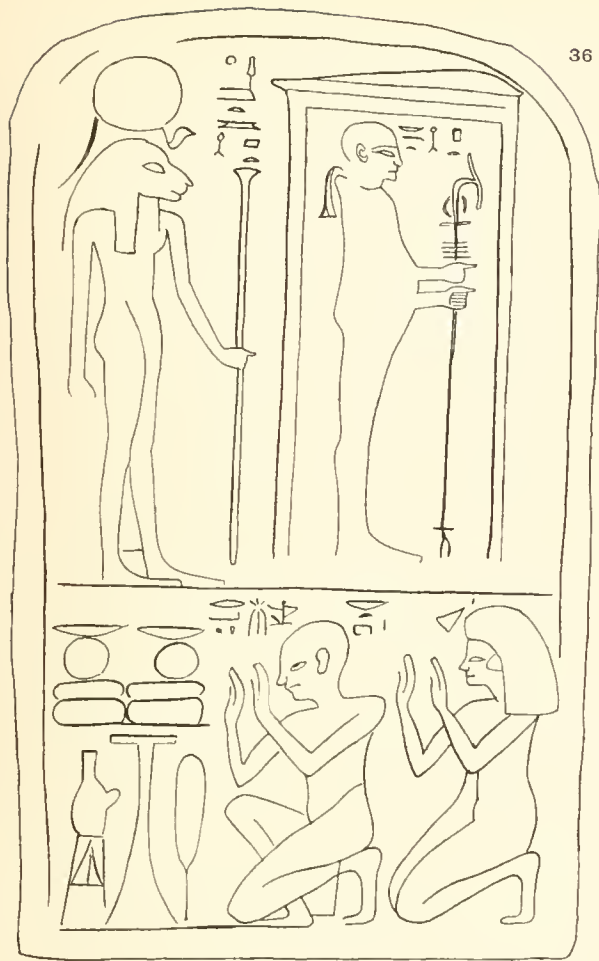

1.
 2.
 3.
 4.
 5.
 6.
 7.
 8.
 9.
 10.
 11.
 12.
 13.
 14.
 15.
 16.
 17.
 18.
 19.
 20.
 21.
 22.
 23.
 24.
 25.
 26.
 27.
 28.
 29.
 30.
 31.
 32.
 33.
 34.
 35.
 36.
 37.
 38.
 39.
 40.
 41.
 42.
 43.
 44.
 45.
 46.
 47.
 48.
 49.
 50.
 51.
 52.
 53.
 54.
 55.
 56.
 57.
 58.
 59.
 60.
 61.
 62.
 63.
 64.
 65.
 66.
 67.
 68.
 69.
 70.
 71.
 72.
 73.
 74.
 75.
 76.
 77.
 78.
 79.
 80.
 81.
 82.
 83.
 84.
 85.
 86.
 87.
 88.
 89.
 90.
 91.
 92.
 93.
 94.
 95.
 96.
 97.
 98.
 99.
 100.



41

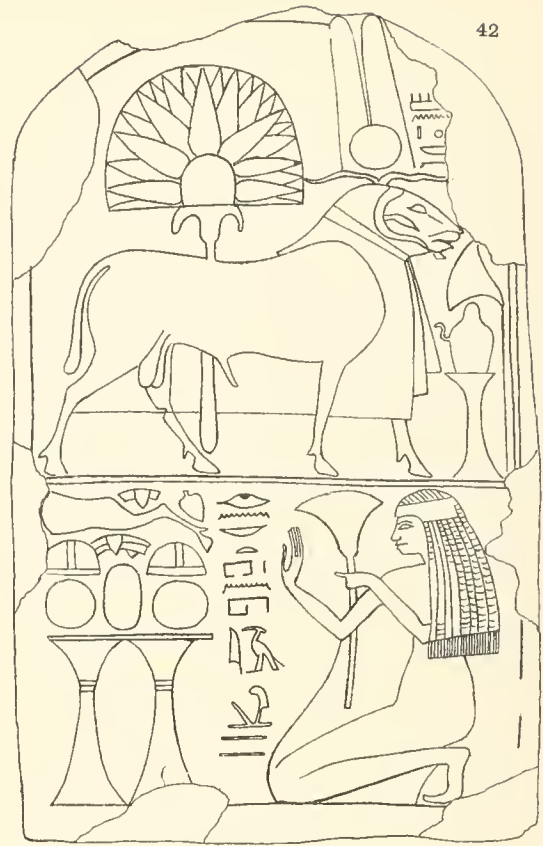

42

PL VII.

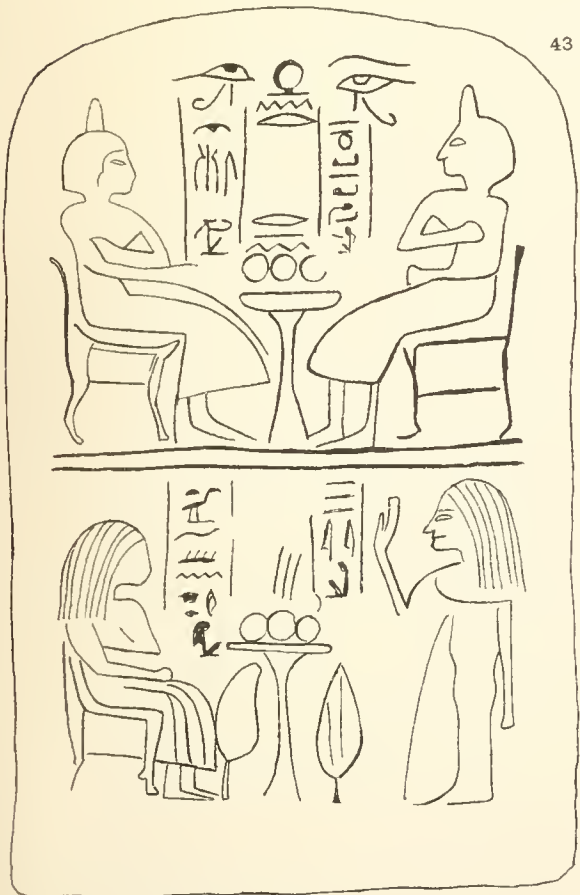

43



44

NEW YORK UNIVERSITY
WASHINGTON SQUARE COLLEGE
• LIBRARY •

45

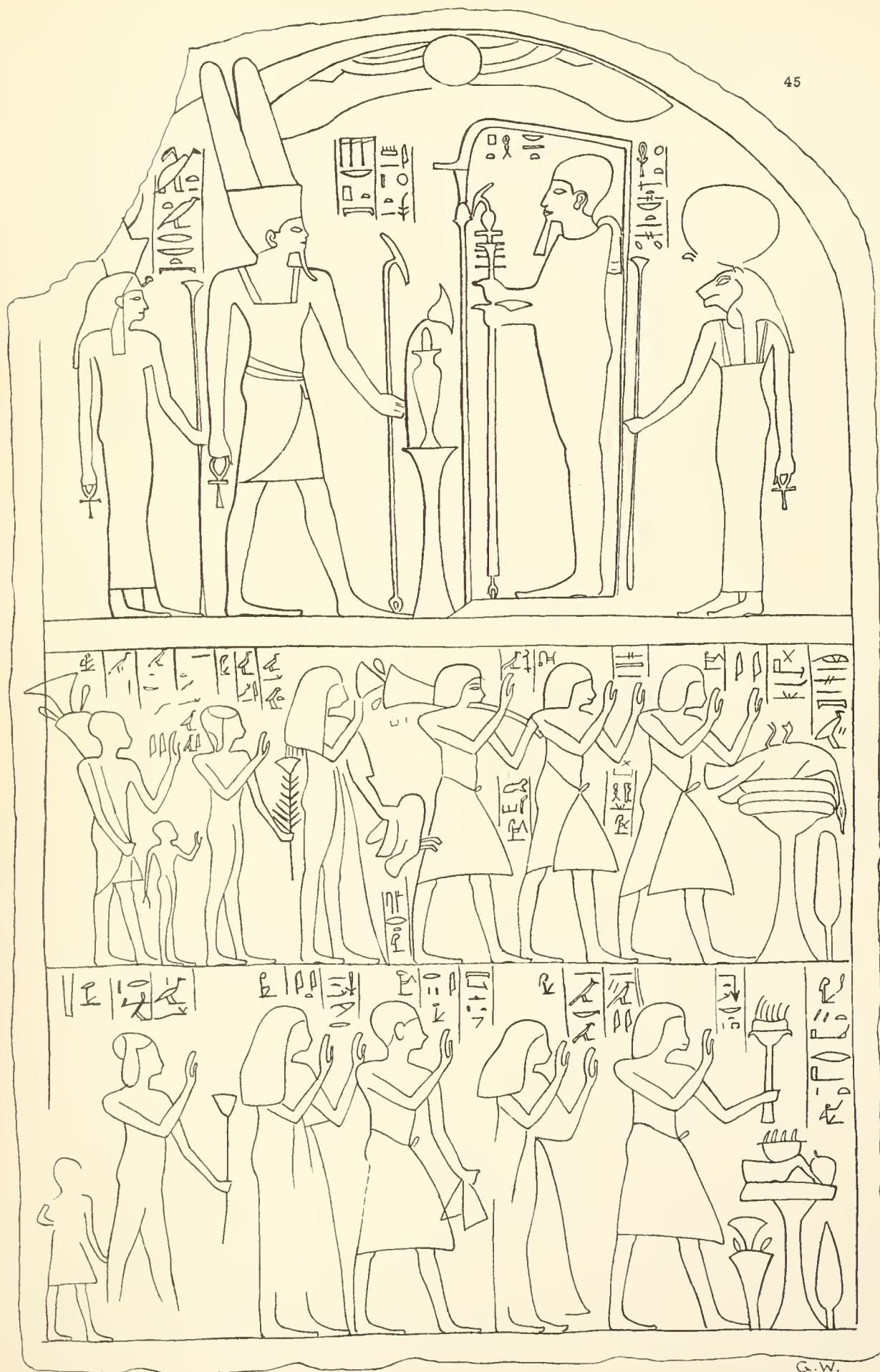

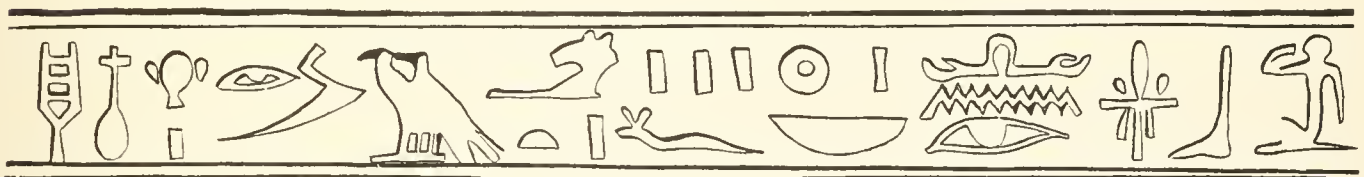
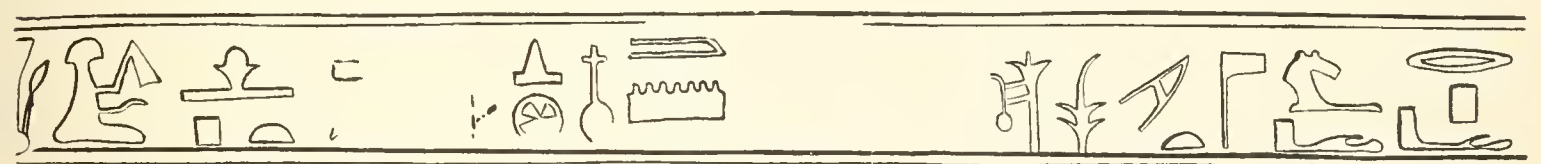



DEPOSIT OF TAHUTMES IV.



STATUE OF RAY.



1:2.

DEPOSIT OF RAMESSU II. AND KHAEMUAS.

NEW YORK UNIVERSITY
WASHINGTON SQUARE
• LIBRARY •

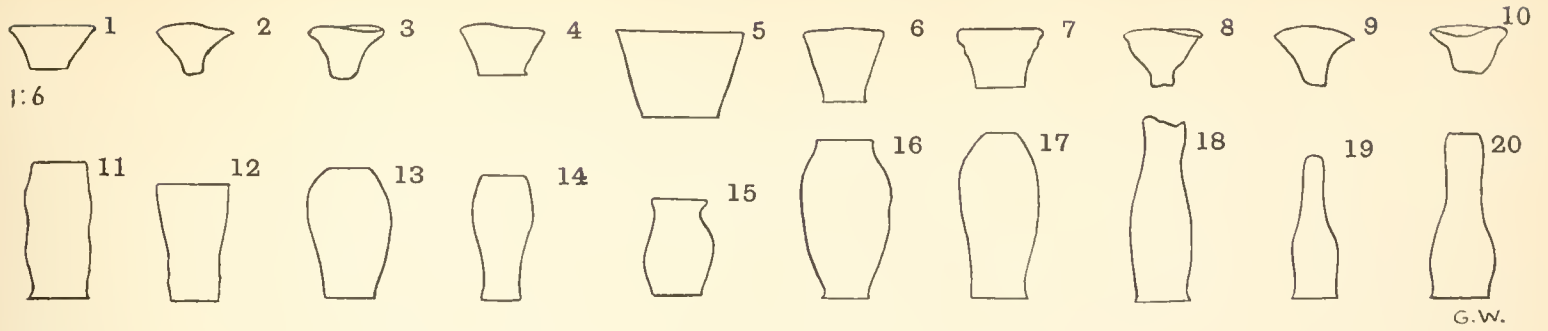

G.W.

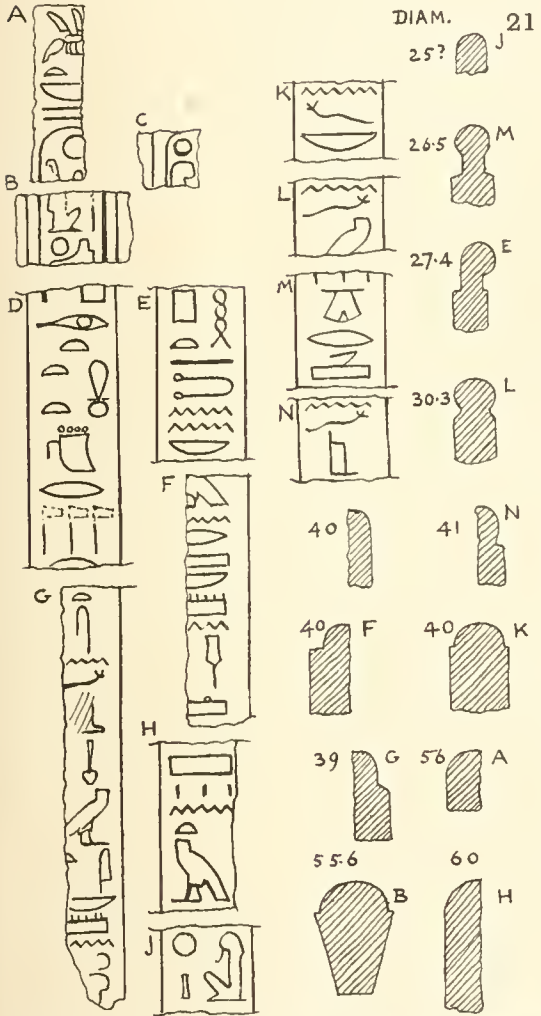

INSCRIPTIONS ON ENGAGED COLUMNS.

2:3

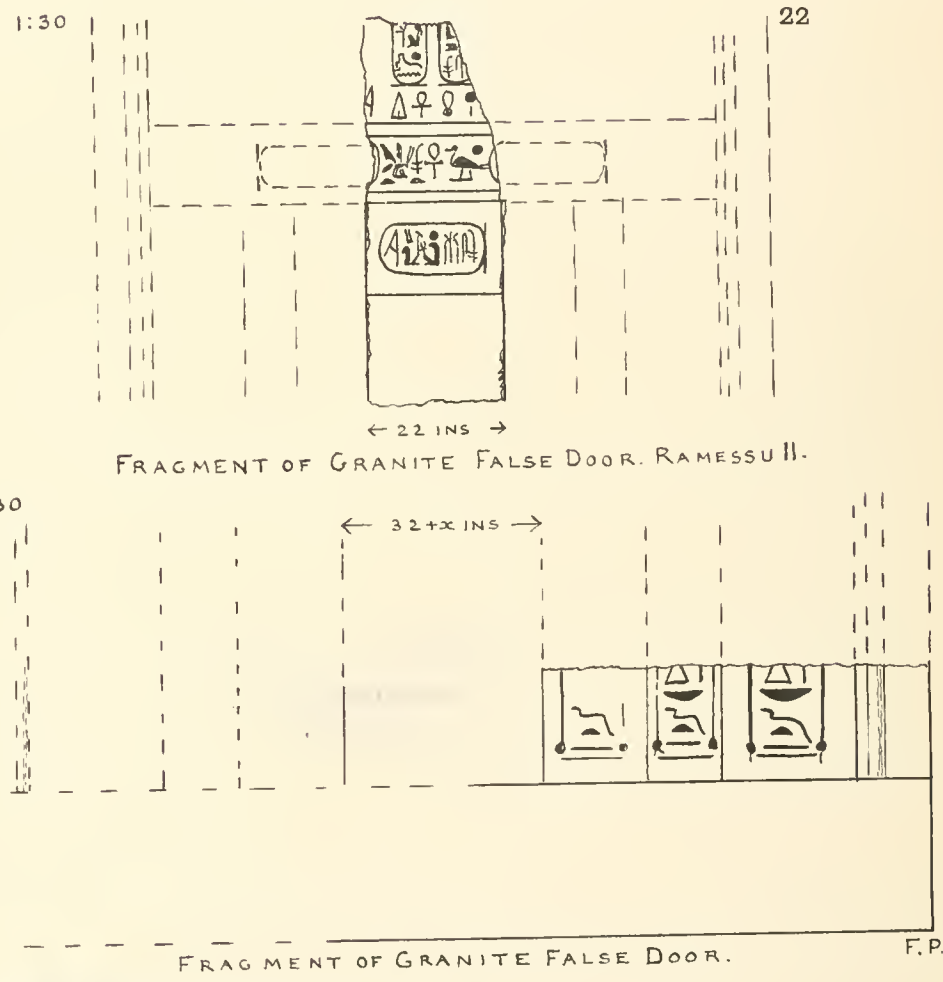

FRAGMENT OF GRANITE FALSE DOOR. RAMESSU II.

FRAGMENT OF GRANITE FALSE DOOR.

F.P.

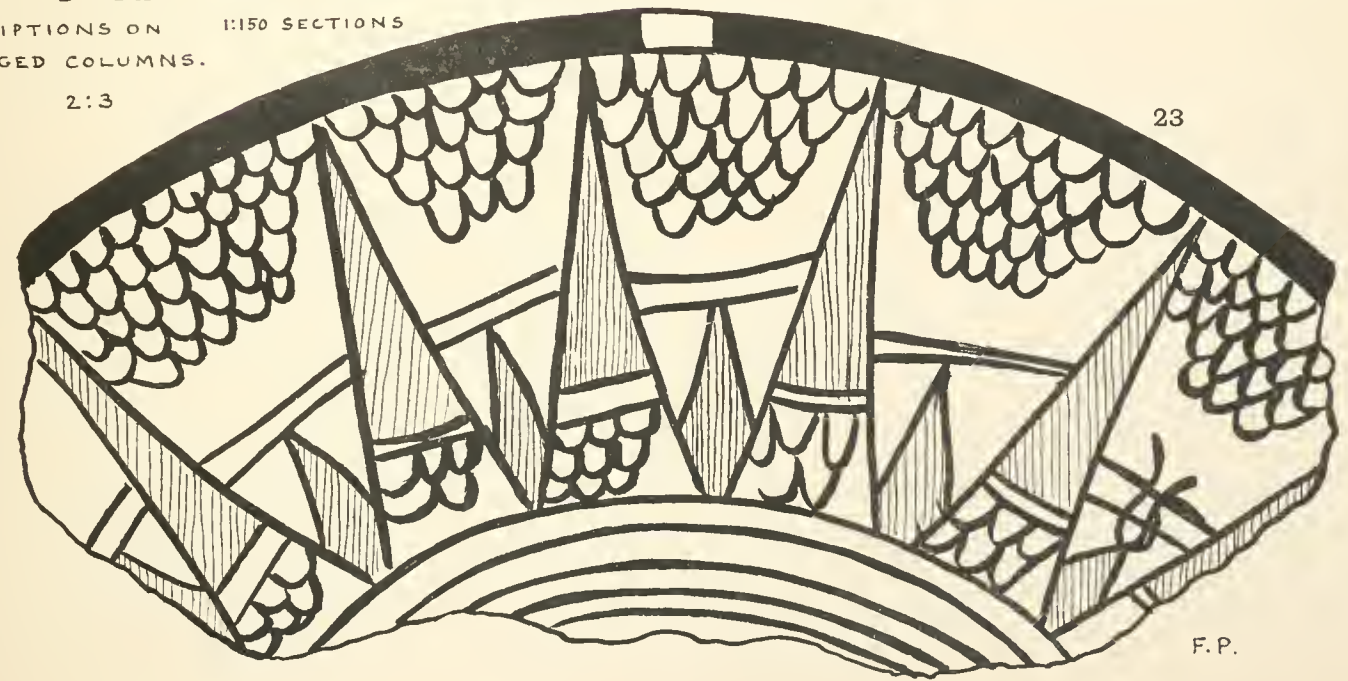

F.P.



VIEW ACROSS TEMENOS OF PTAH IN WINTER.



POND ON SITE OF EARLY TEMPLE OF PTAH.



ACROSS WEST COURT LOOKING NORTH.



PUMPING OUT THE POND.



SOUTH OUTSIDE OF WEST COURT, BASALT FOOT.



NORTH OUTSIDE OF WEST COURT, BASALT FOOT, AND VIEW LOOKING EAST.





MAIN DOOR WAY.



ADDED INSCRIPTION OF MERENPTAH.



GRANITE DWARF WALL OF ENTRANCE.



GRANITE COLUMNS IN WEST HALL.



PALM CAPITAL CONVERTED INTO ENGAGED COLUMN.



ENGAGED COLUMN OF LIMESTONE.

NEW YORK
WASHINGTON
LIBRARY



LIONS PAW FROM SPOUT. BASALT.



SIDE OF RED GRANITE COLOSSUS.

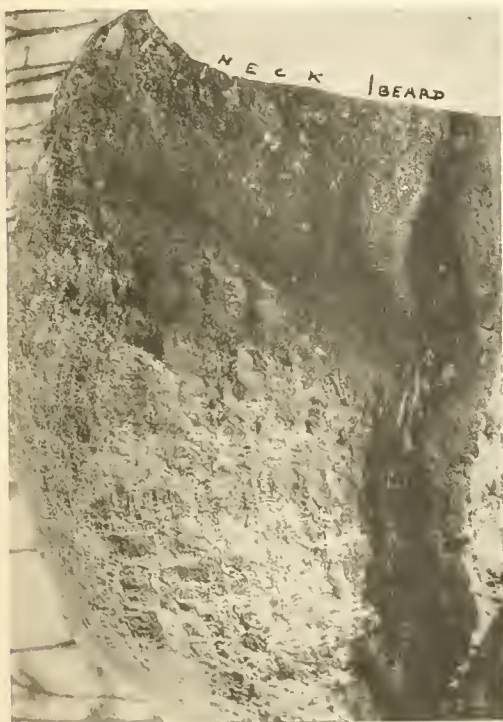

PART OF ALABASTER COLOSSUS.



DOORWAY AND FRONT OF GRANITE COLOSSUS.



BASE OF FORE-STANDING COLOSSUS.



SIDE OF BASE OF COLOSSUS.

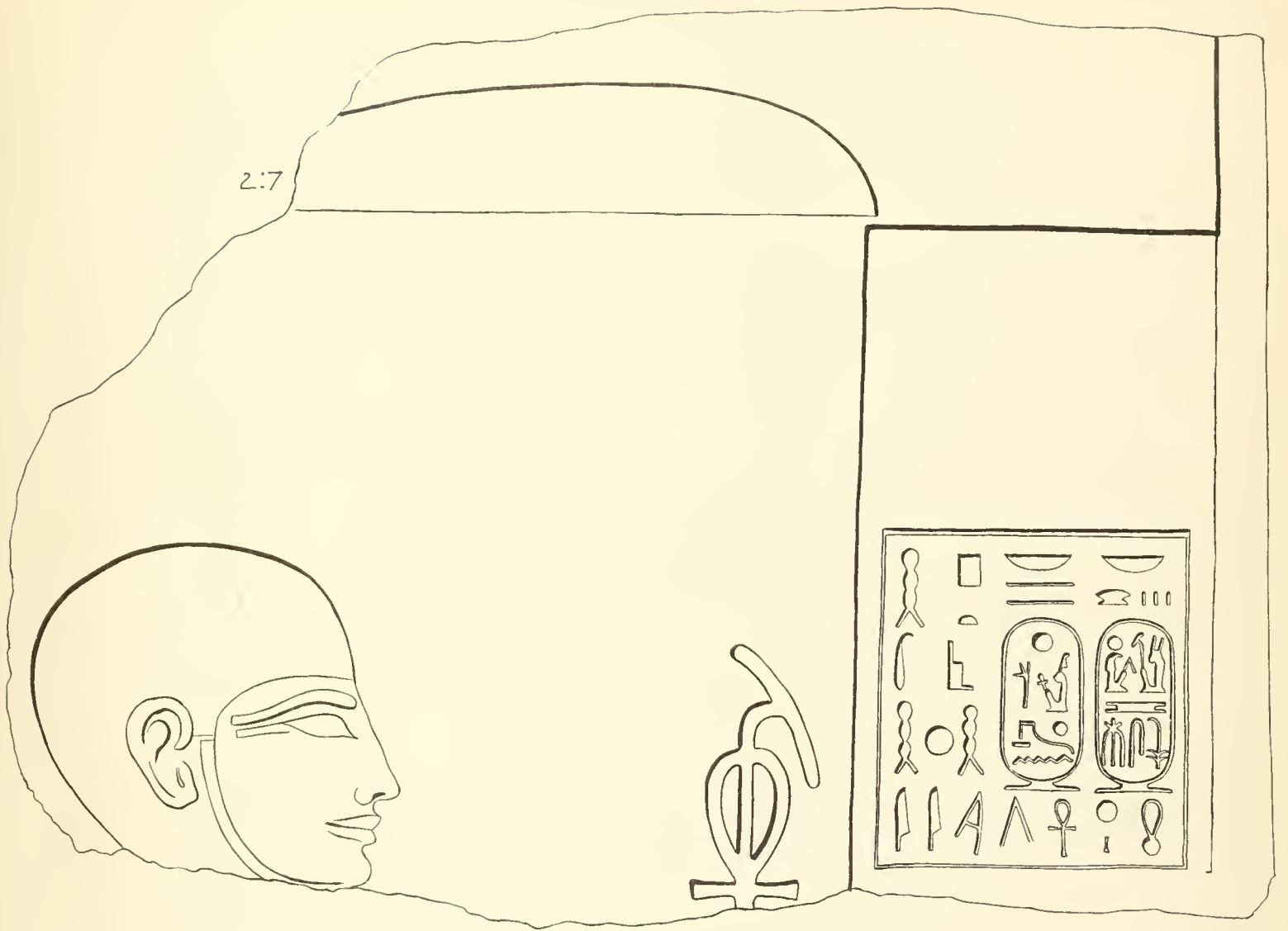

1:6

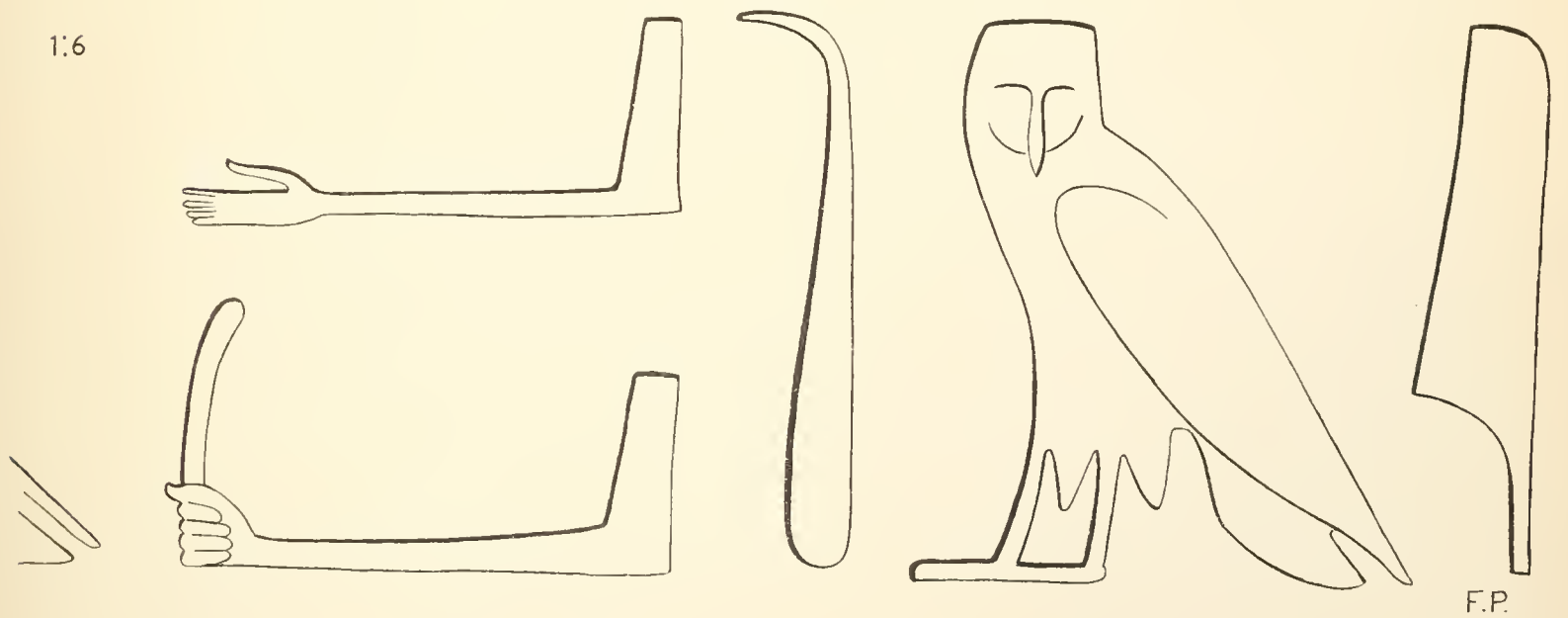



COLUMN OF KHAEMUAS.



INSCRIBED COLUMN.



COLUMNS OF RAMESSU II AND III.



CAPITALS AND WALLS OF SHABAKA.



GRANITE COLUMN, WEST HALL, RAMESSU II.

NEW YORK UNIVERSITY
WASHINGTON SQUARE
• LIBRARY •

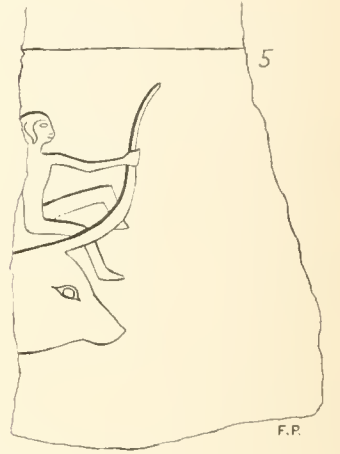
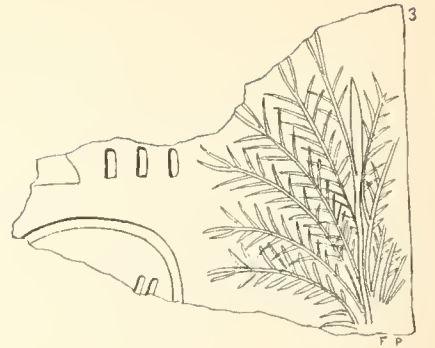
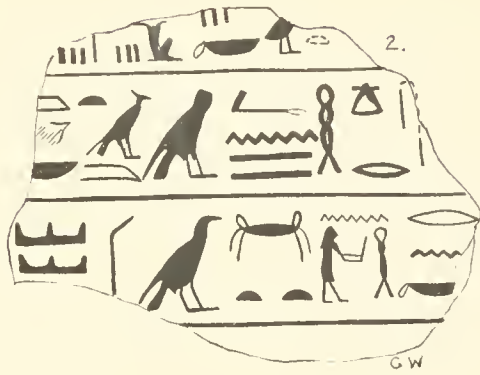
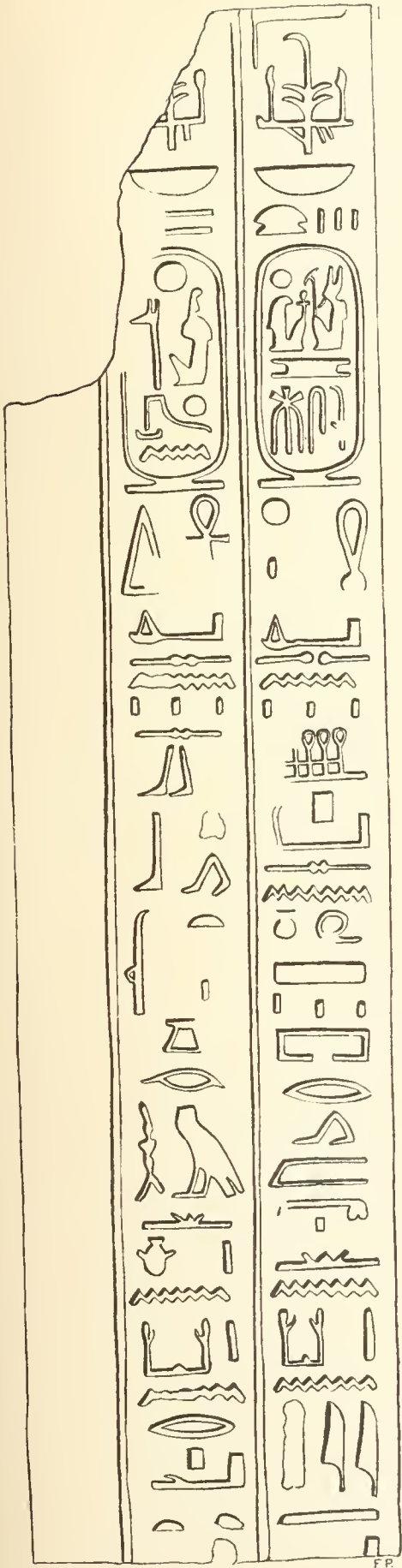

SEE COLUMN ON PL. XXV.

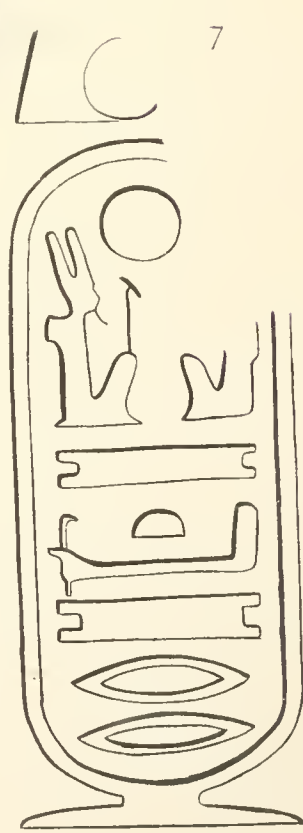
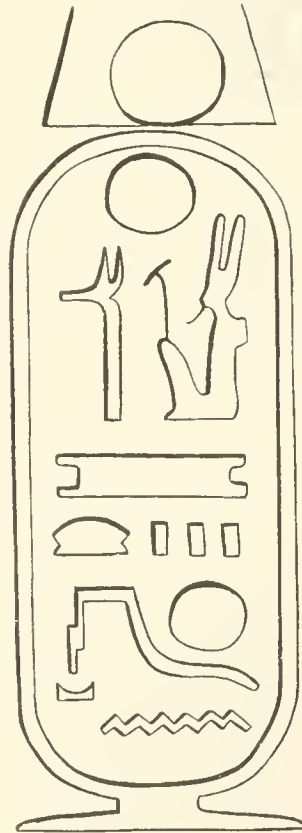

G.W.

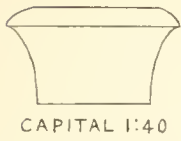

CAPITAL 1:40

BUILDING OF SHABAKA IN S.W. OF PTAH TEMENOS 1:200

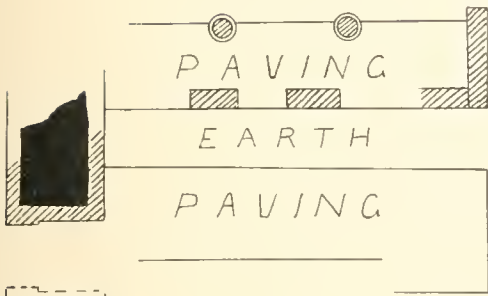

F.P.

BUILDING EAST OF SACRED LAKE. 1:200

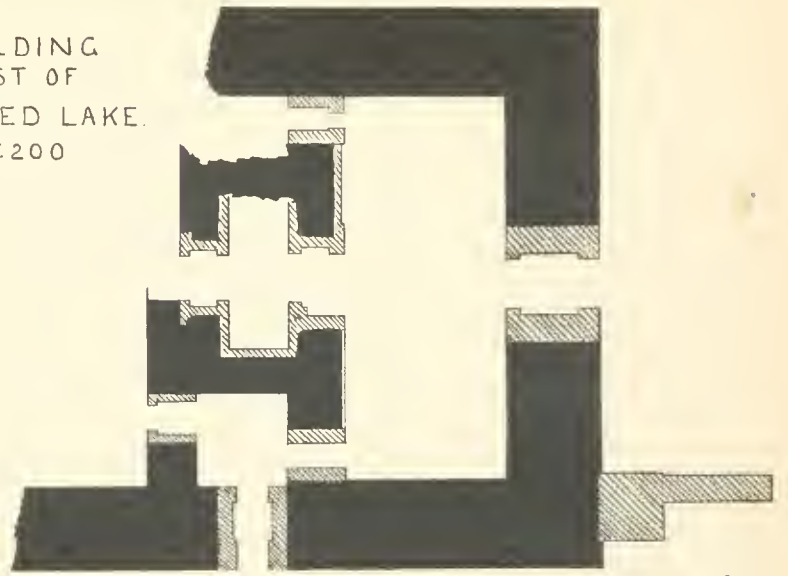

I.G.

1:800



A.S.
F.P.

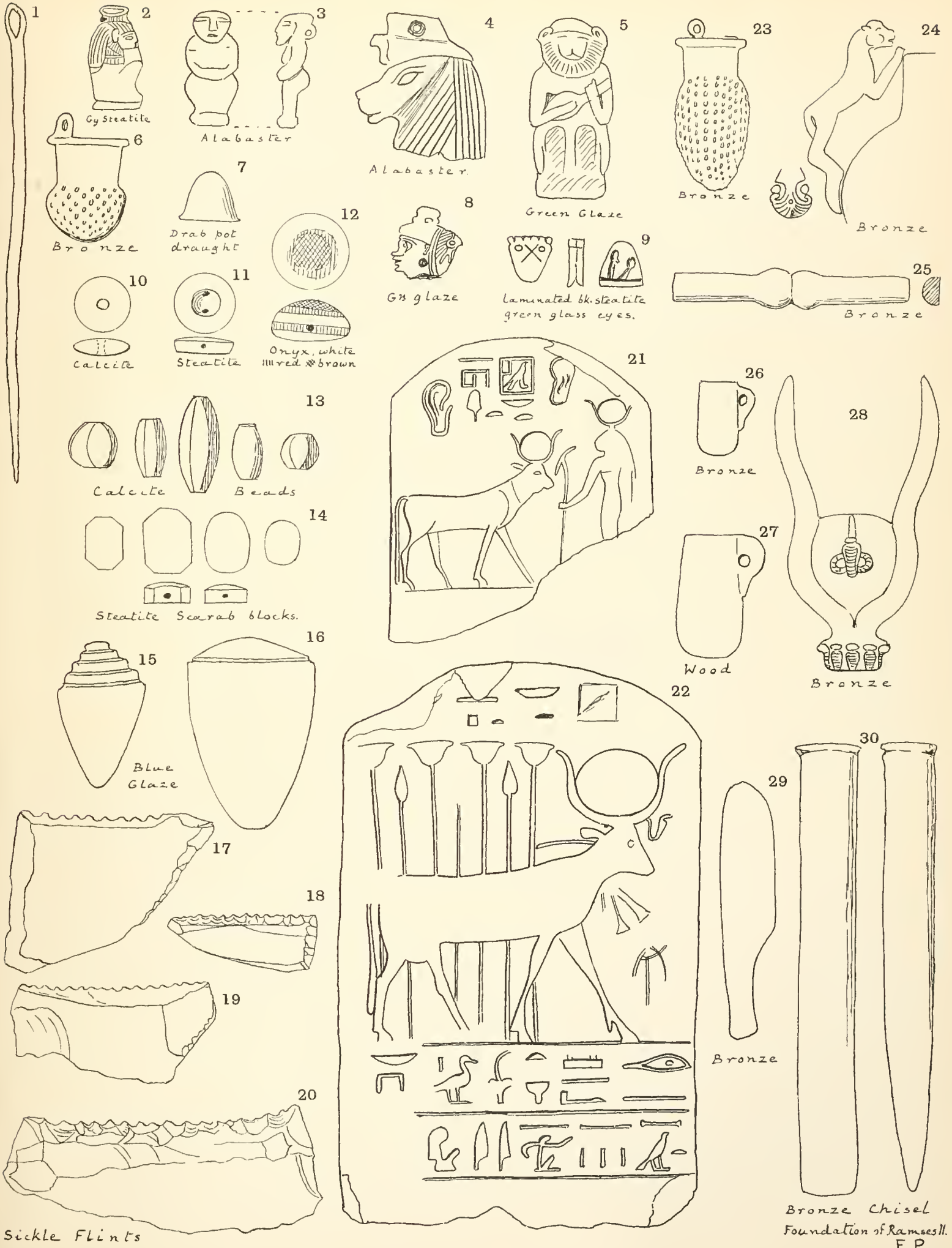

NEW YORK UNIVERSITY
WASHINGTON, D. C. 20004
• 212/246-2000 •

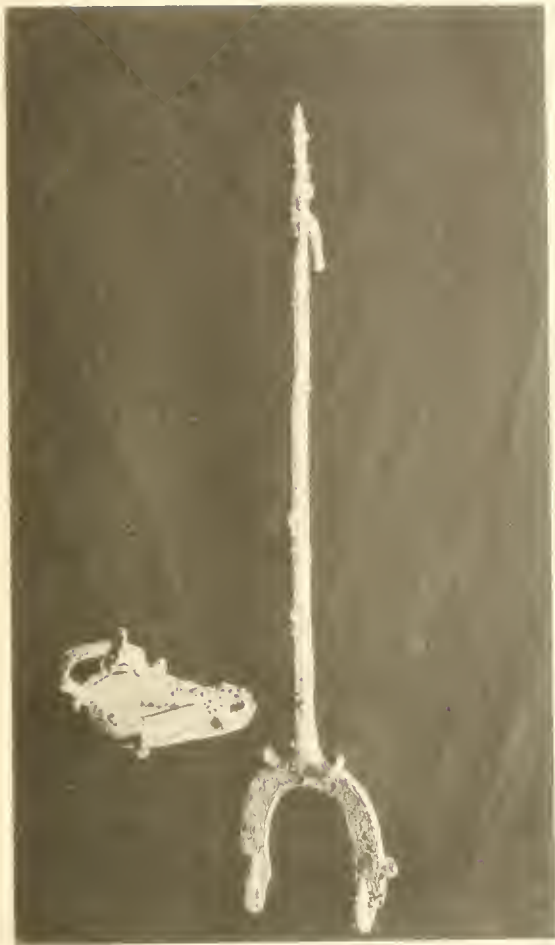

ROMAN BRONZE LAMP, AND LONG HOLDER.



CYPRIOTE POTTERY. TEMPLE OF MERENPTAH.



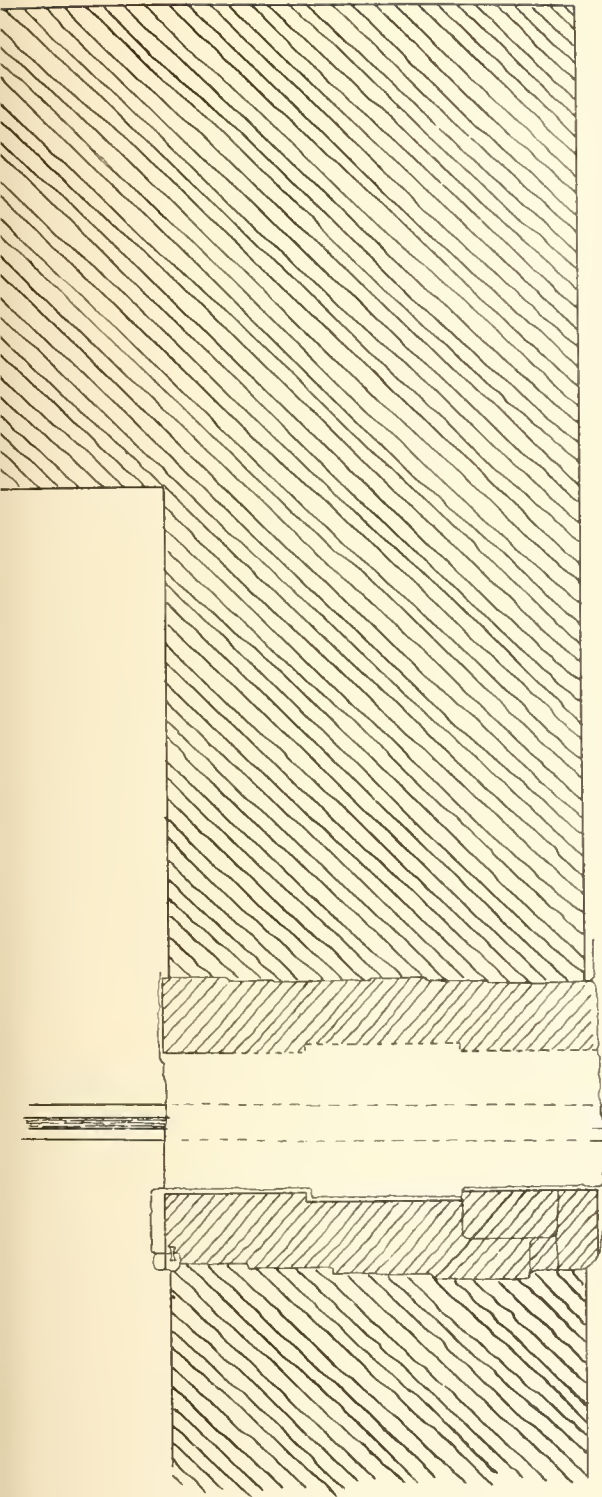

GREAT GATE OF THE CAMP

/// LIMESTONE
\\ \\ BRICKWALL
1:200.

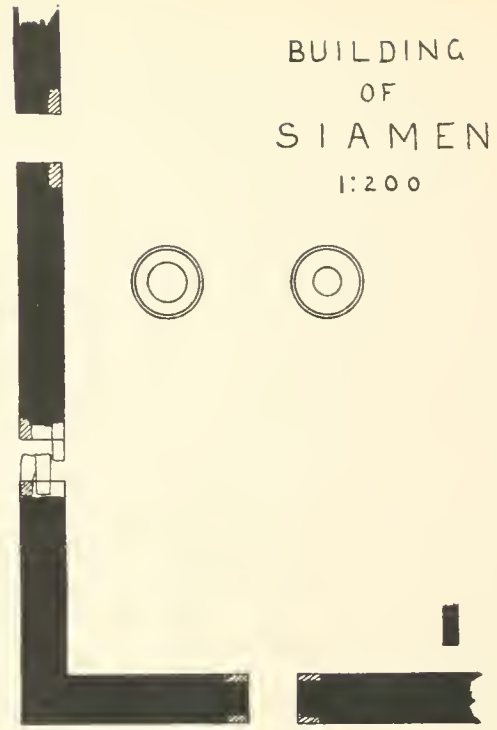

BUILDING OF SIAMEN
1:200

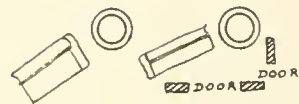

CHAMBER OF REUSED STONE

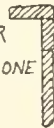

BLOCK OF RAMESSU II
ALABASTER FOUNDATION
BLOCK OF SHESHENQ I

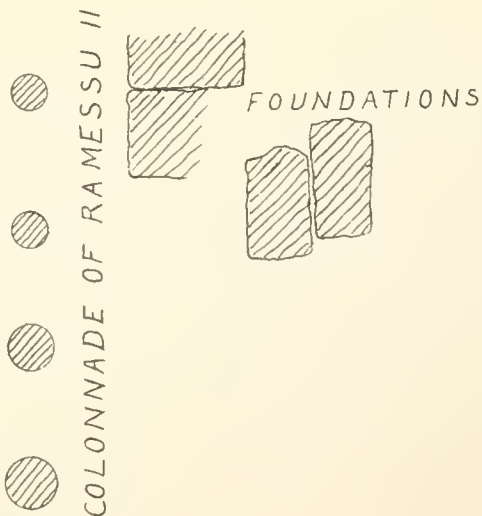

COLONNADE OF RAMESSU II

FOUNDATIONS

BUILDING IN S-W. OF PTAH TEMENOS.
1:200



BRECCIA STATUE OF HAP-AMU
UNCLE OF NEKHT-HOR-HEB.



LINTEL OF SIAMEN AND ANKH-EF-NE-MUT.



AGATHO-DAIMON HOUSE AMULET.



WORKMEN'S HUTS.

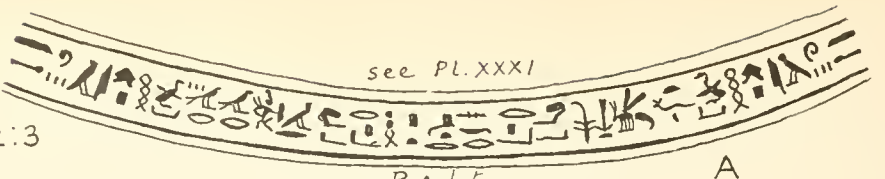

2:3

Belt

A

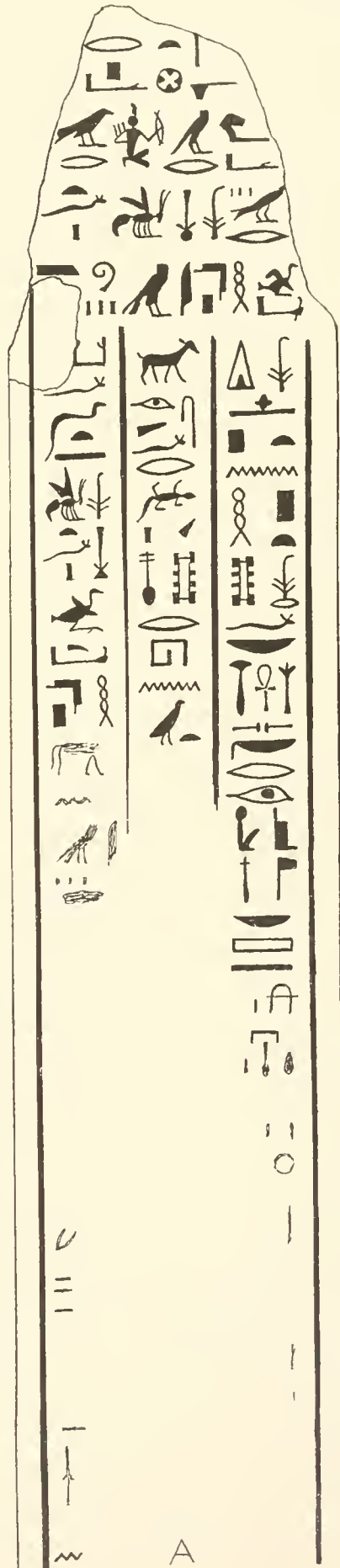

A

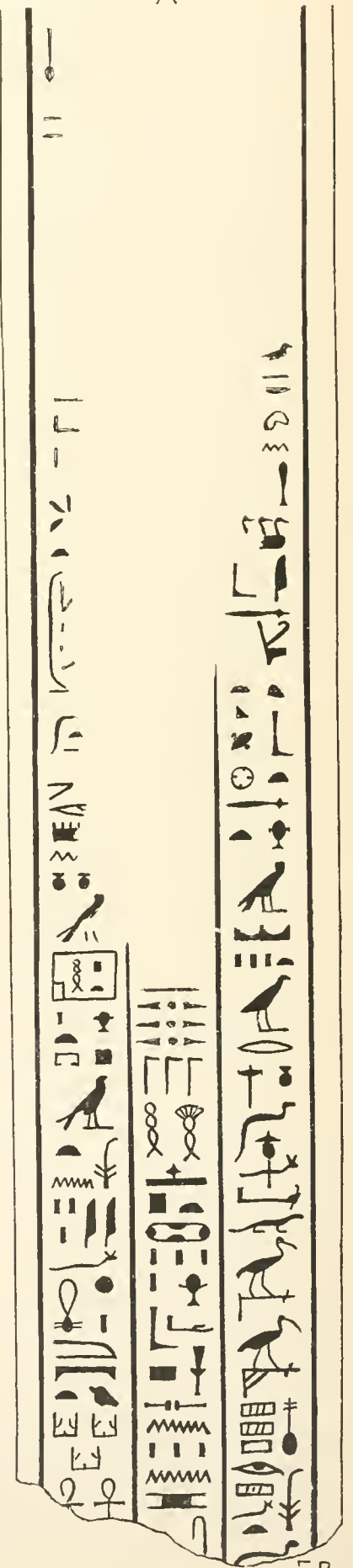

F.P.

1:3

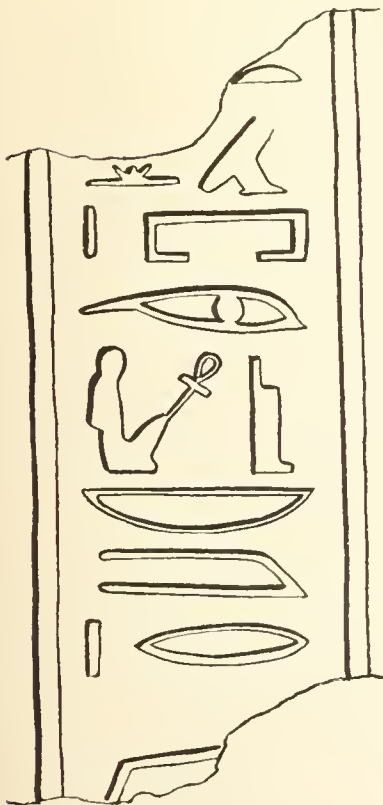
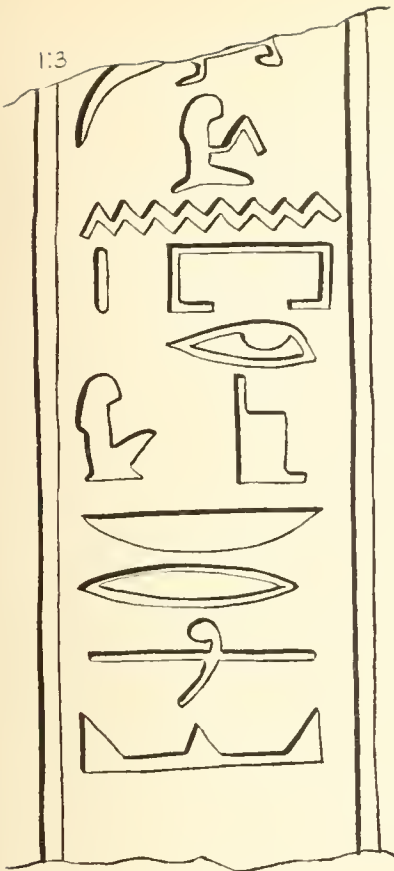

NEW YORK UNIVERSITY
WASHINGTON SQUARE COLLEGE
• LIBRARY •



STELE XXIII DYNASTY.

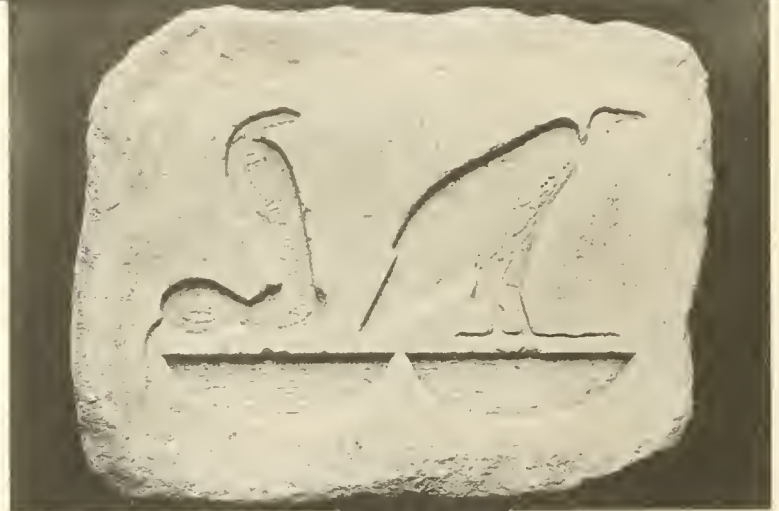

QUARTZITE TRIAL PIECES.

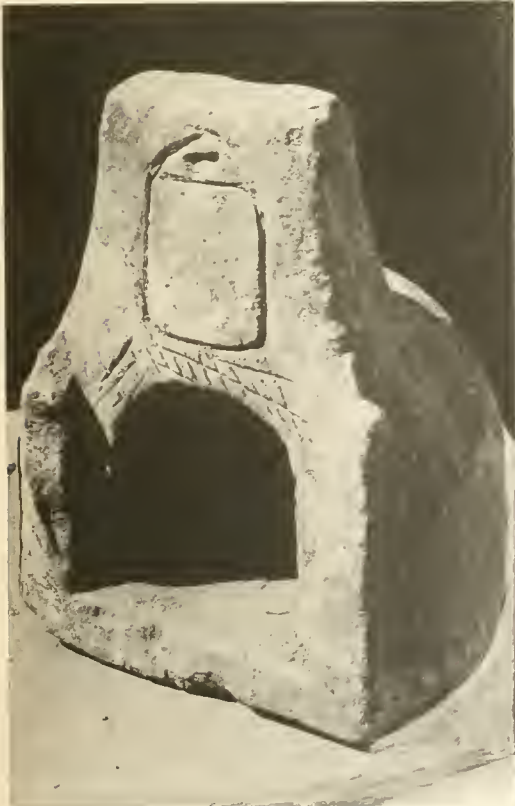

SHRINE FOR SHREWMOUSE?



LIMESTONE HEAD OF HATHOR.



PART OF MODEL OF HOUSE.

GENERAL.

MERENPTAH TEMPLE.

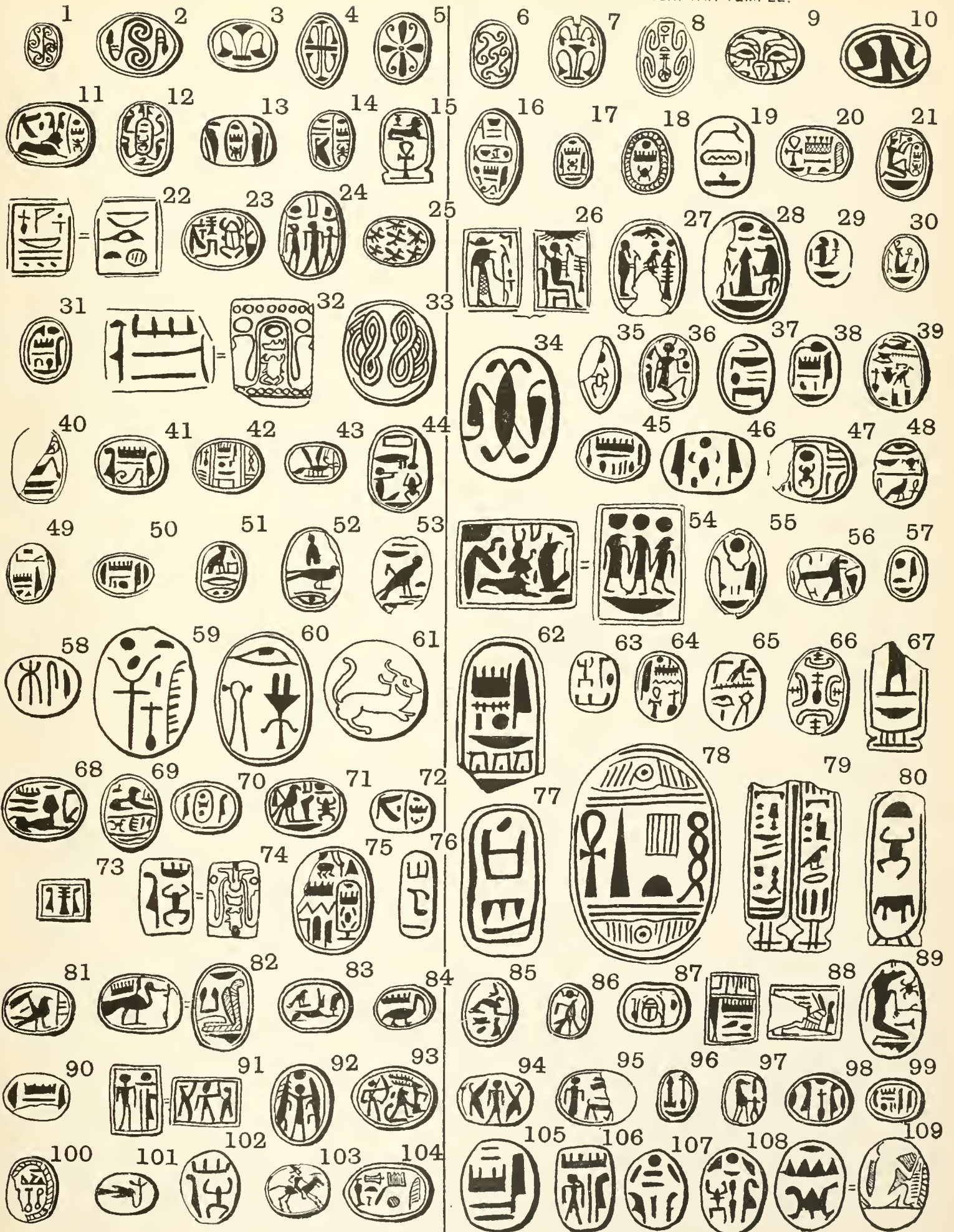





16

PERSIAN GREAT KING



17

FROM SIDON SARCOPHAGUS



18

PERSIAN CAVALRY OFFICER.



19

AMU FROM BENIHASAN TOMB.



20

SEMITIC SYRIAN

NEW YORK UNIVERSITY
WASHINGTON SQUARE
• LIBRARY •



21

SUMERIAN HEAD
FROM BABYLONIA.



22

SUMERIAN



23

SUMERIAN HEAD
FROM TELL LOH.



24

SUMERIAN.



25

BABYLONIAN SEMITE.
KHAMMURABI.



26

BABYLONIAN. P

27

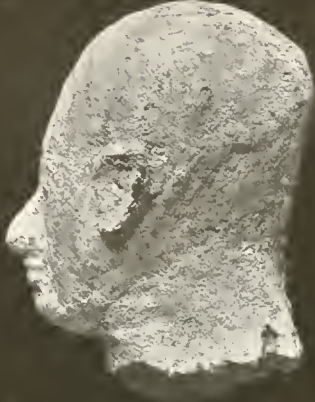

28

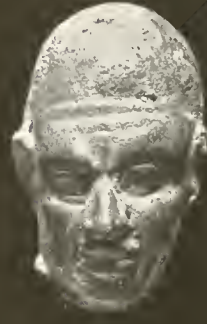

29



30



31



32



33

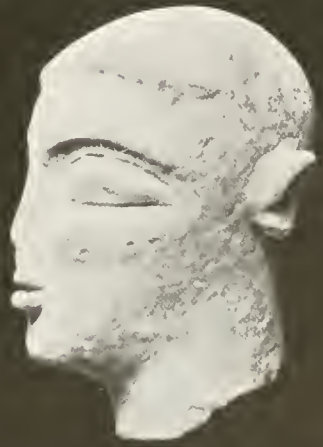
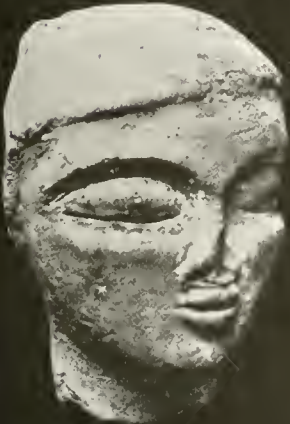

34



35



36



1 : 3



37

38

40

39





41

SCYTHIAN
KOUL-OBA VASE.

42



43



44



45



46



NEW YORK
WASHINGTON
LIBRARY

55



56



57



58



59



60



NEW YORK UNIVERSITY
WASHINGTON SCIENCE CENTER
• LIBRARY •



61



63

64



62



65



66



67



68



69





GREEN GLAZED ALTAR OF OFFERINGS.



LIMESTONE HEAD PTOLEMY IX ATHRIBIS.



TRIAL PIECES ATHRIBIS.

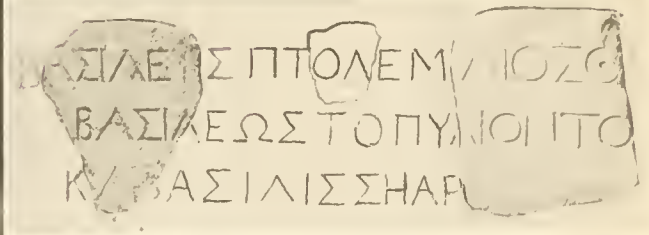

PARTS OF ARCHITRAVE OF PYLON.



GREEK STELE.



ALABASTER VASES BRCKEN IN WORKING, AND DRILL CORES.

NEW YORK UNIVERSITY
WASHINGTON SQUARE
• LIBRARY

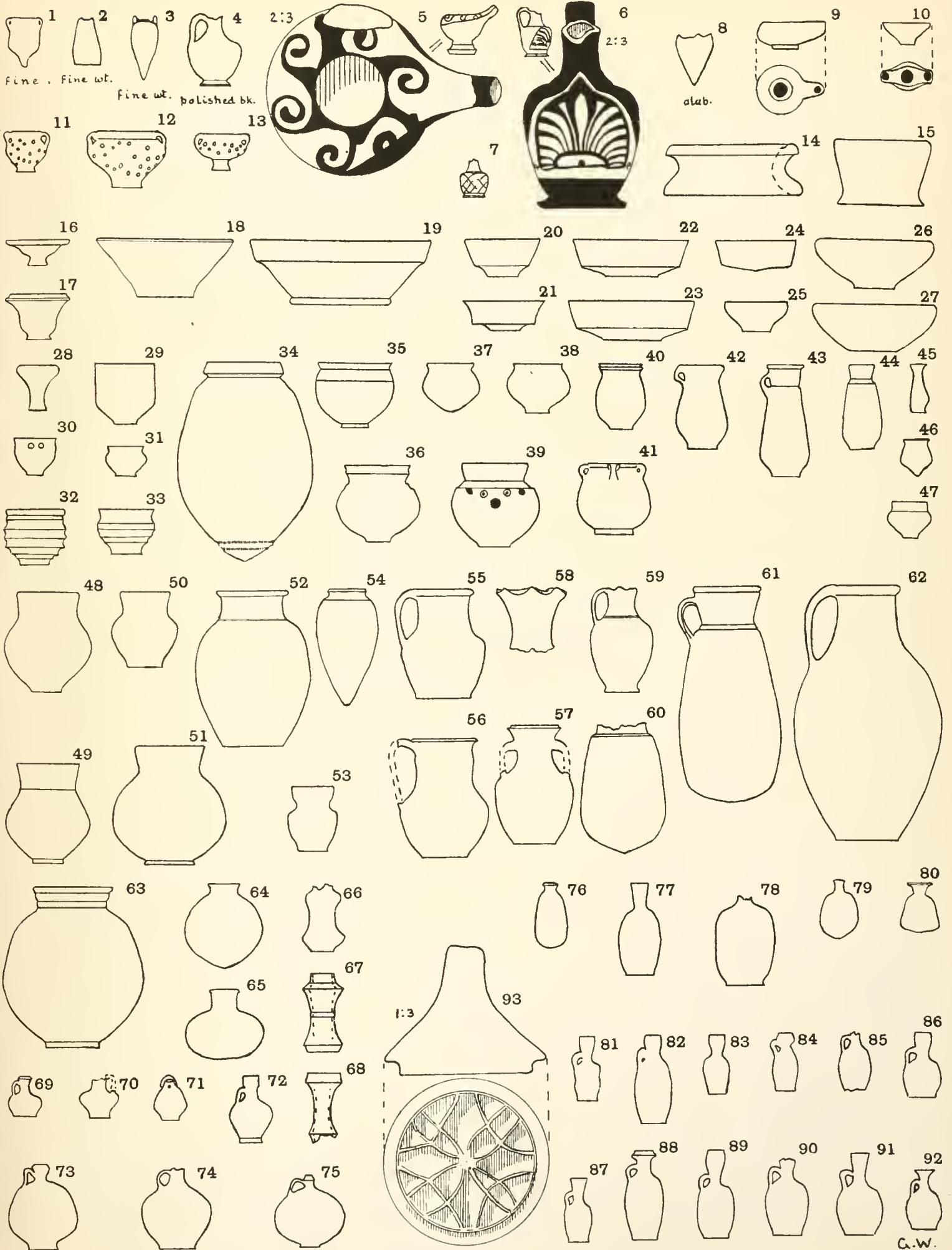



2:3

GROUP OF GLAZED POTTERY, FOUND WITH POTTERY, PL. XLVI, ABOUT 300 B.C.



GROUP OF LAMPS, SIX WITH ORIGINAL HANDLES, FOUND WITH POTTERY, PL. XLVIII, ABOUT 200 A.D.

NEW YORK UNIVERSITY
WASHINGTON SQUARE COLLEGE
• LIBRARY •



1

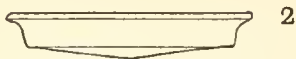

2

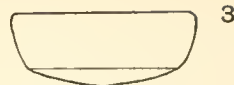

3

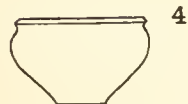

4



5

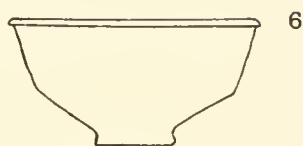

6



7

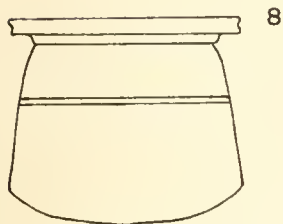

8

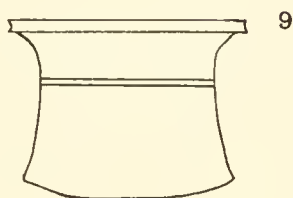

9

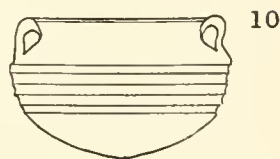

10

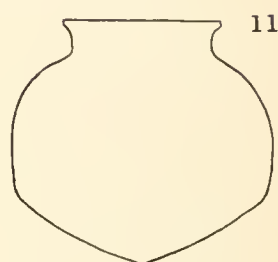

11

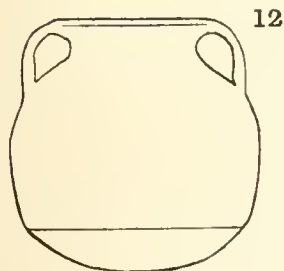

12

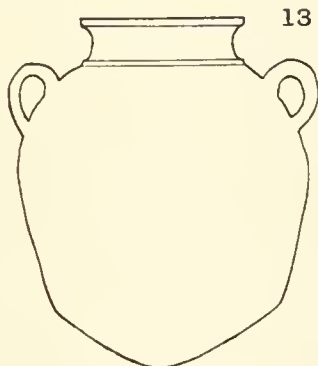

13



14

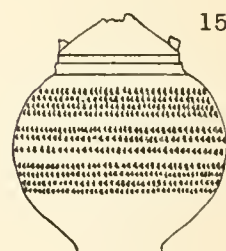

15



16

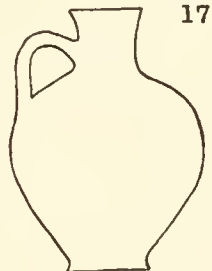

17

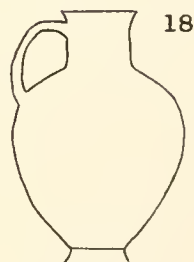

18



19

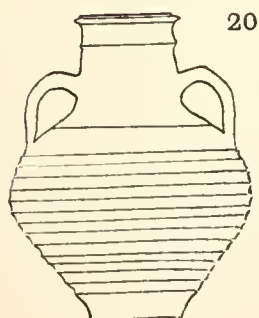

20



21

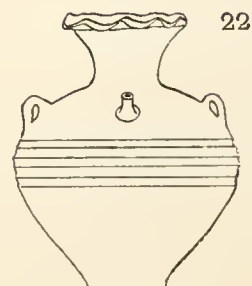

22

NEW YORK UNIVERSITY
WASHINGTON SQUARE COLLEGE
• LIBRARY •



INSIDE OF KILN, WITH WASTERS. ROMAN.



SPHINX, PART OF VASE, BOWLS AND DISHES FROM KILN. ROMAN.

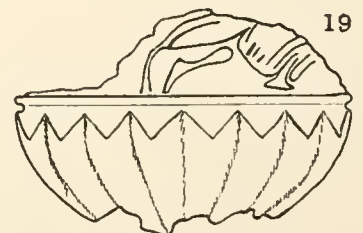
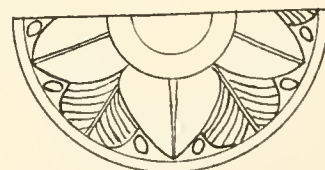
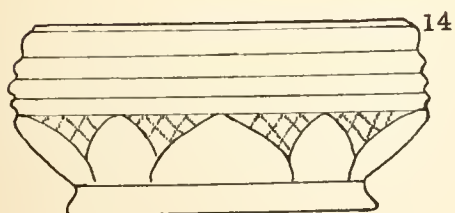
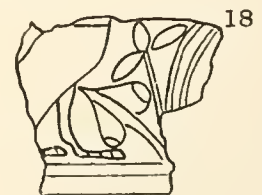
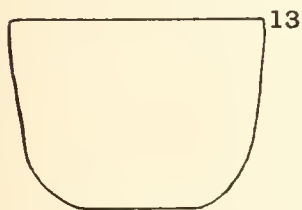
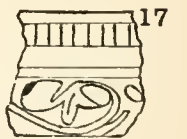
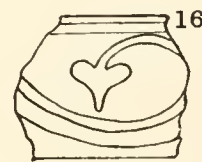
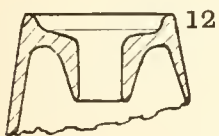
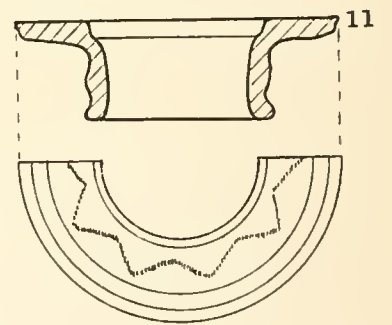
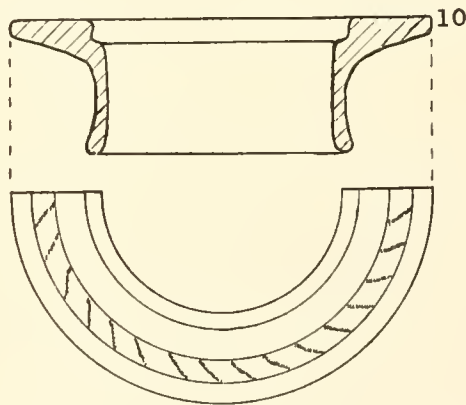
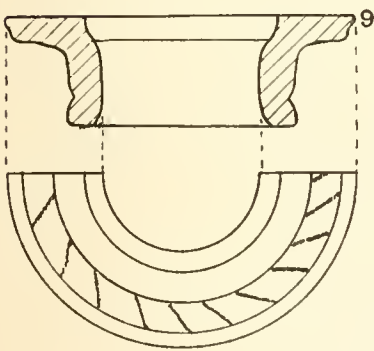
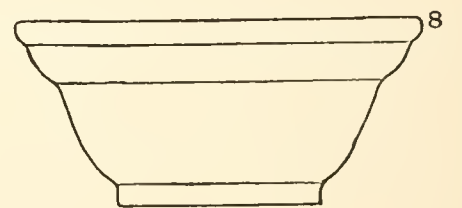
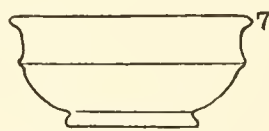
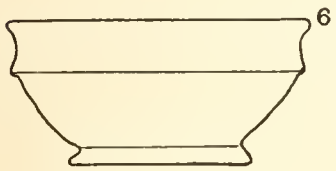
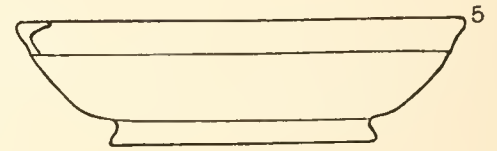
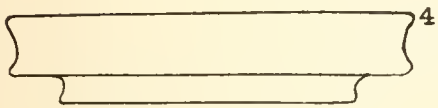
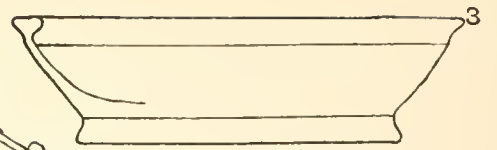
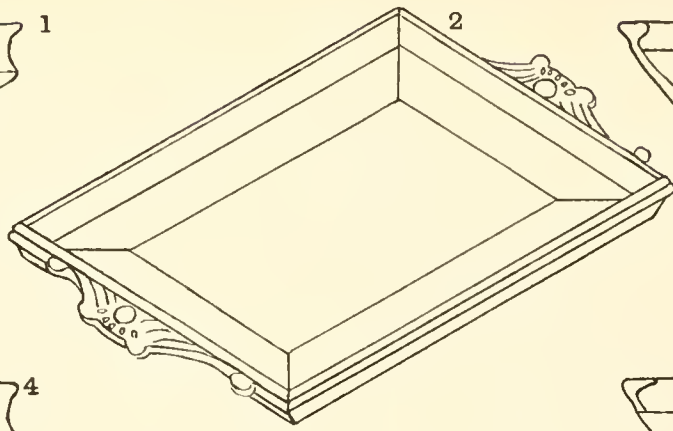
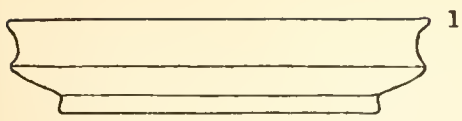

NEW YORK UNIVERSITY
WASHINGTON SQUARE COLLEGE
• LIBRARY •



1-7 BRONZE ; 8-17 IRON ; 18 BARK ; 19-20 WOOD ; 21-23 BONE ; 24-28 GLASS ; 29-30 POTTERY.

NEW YORK UNIVERSITY
WASHINGTON SQUARE COLLEGE
LIBRARY • •

ΝΙΛΩΙΓΟΝΙΜΩΤΑΙ ΟΙ ΑΛΕΞΑΝΔΡΟΥ ΡΗΤΩΝ
Memphis F.P.



Athribis



MAM

ΔΕΠΤΟ
ΥΡΓΩΝ
Memphis F.P.

ΤΕ ΝΟΝΟΜΑΤΙΤΧ
ΠΡΕΚΤΟΥΥΥΚΕΤΧΑΤΙΧ
ΠΚ

Memphis

F.P.

ΠΑΧΙΑΤΗΣ
ΓΣΙΔΙΣΤΟΠ
Memphis F.P.

Memphis

ΠΝΣΟΝ Ζ
ΠΙΩΤΜΗ
ΠΝΑΕ ΤΟΥ
ΑΔΑΜ ΜΗΝΕ
ΟΥΝΔΚΕΟΣ ΤΗΧΟΘΣΕΜΑ
ΑΥΜΑΡΙΑ ΤΗΜΑ
ΗΝΕΝ ΙΟΤΕ ΠΑΔΡΙΑΡΧΗΣ
ΜΝΕ ΠΡΟΦΗΤΗΣ ΜΝΕ ΜΑ
ΡΤΗΡΟΣ ΝΕΝ ΙΟΤΕ ΝΑΠ
ΟΣΤΟΛΟΣ ΠΧΟΥ ΤΑΒΤΕ
ΗΣ ΒΗ ΤΕΡΟΣ ΠΝΙΩΤ
ΠΑΔΑ ΠΟΛΛΩ ΠΗΙΩΤΑ
ΠΑΠΕ ΤΡΕ
ΩΣ ΑΝ ΗΗΣ
ΩΛ ΟΑΓΙΟΣ ΑΠΑ
ΝΕΤΟ ΑΒ ΤΗΡΟΥ
ΝΤΕ ΨΗΧΗ ΜΜΑΙΑ
ΛΩ ΝΤΑΒΕΜ ΤΟΝ ΕΜΟ
ΖΗΝΟΥ ΙΡΗΝΗ Ζ ΑΜΗΝ

Balyzeh

F.P.

ΠΑΠΖΕ
ΚΩΣΜΧ

Balyzeh

E.M.

ΦΟΔΓΙΟΣ
ΘΕΟΔΩΡ
ΠΑΕΥΧΗΤΟΒ

Balyzeh

E.M.

ΑΝΟΙΚΑΝΤΩΝ

Balyzeh

E.M.

ΙΣΘΚΠΝ

Balyzeh

F.P.

12
 ΠΝΟΥ ΤΕ ΠΑ
 ΓΑΘΟΣ ΔΡΙΤΤ
 ΜΕΕΥΝ ΔΤΑ
 ΔΒΡΔΖ ΔΜ ΠΡΜ
 ΠΑΝ ΔΖ Ο ΔΥ
 Μ Τ Ο Ν Μ Μ ΟΥ
 Ν Σ Ο Υ Τ Ο Ο Υ
 Ν Ζ Δ Θ Ω Ρ Ζ Ν
 Ο Υ Ε Ι Ρ Η Η Ζ Δ
 Μ Η Η

Balyzeh

FP

13
 Ϡ ΠΝΟΥ ΤΕ ΠΑ ΓΑΘΟΣ
 ΑΠΑΘΩ Μ Δ Σ Α Π Α Π Ε
 Τ Ρ Ε Α Π Α Ι Ω Σ Η Ϡ Α Π Α
 Α Ν Ο Υ Π Α Π Α Π Α Μ Ο Υ
 Η Ν Ε Τ Ο Υ Δ Α Β Τ Η Ρ Ο Υ
 Δ Ρ Ι Π Μ Ε Ε Υ Ε Μ Π Π Α
 Π Α Β Ι Κ Τ Ω Ρ Π Ρ Μ Τ Ο Υ
 Ζ Ω Η Σ Ο Υ Ο Δ Υ Μ Τ Ο Ν
 Μ Μ Ο Υ Η Σ Ο Υ Β Τ Ο Ο Υ
 Μ Π Α Ρ Μ Ζ Ο Τ Π Ζ Ν Ο Υ
 Ε Ι Ρ Η Η Ζ Δ Μ Η Η Π Π
 Α Π Α Β Ι Κ Τ Ω Ρ Π Ρ Μ Η
 Ζ Δ Β Ε Ζ Δ Μ Η Η Γ Ι Ν Δ Ι Κ Η Θ

Canadleh

EM

14
 † Π Ι Ψ Τ Μ Η Π Ψ Η
 Ρ Ε Μ Η Π Ε Π Ν Ε Υ
 Μ Δ Ε Τ Ο Υ Δ Α Β Π
 Ε Η Ψ Τ Α Π Α Π
 Ο Λ Λ Ω Ρ
 Τ Α Π Α
 Τ Ε Ν Ι Ψ
 Ζ Δ Η Η Η Σ Φ Α Γ Η
 Σ Α Π Α Π Ω Ψ Η
 Ε Τ Ο Υ Δ Α Β Τ Η Ρ Ο Υ
 Δ Ρ Ι Π Μ Ε Ε Υ Ε Τ Ε Π Ψ Η
 Χ Η Η Π Δ Β Α Ω Ψ Ε Ν Ο Υ Τ
 Ε Π Ρ Ε Μ Τ Α Ζ Α Ο Υ
 Δ Ρ Ι Π Μ Τ Ο Ν Μ Ο Β
 Ο Υ

Balyzeh

FP

15
 Π Ε Π Ν Δ Ε Τ
 Ψ Τ Η Ι Χ Δ
 Δ Τ Ε Ν Μ Δ Χ
 Υ Τ Δ Υ Τ Ε Χ
 Τ Ο Σ Ν Δ Ρ Ε
 Δ Ε Τ Ο Υ Δ Β
 Π Μ Δ Ρ Γ
 Π Ε Ν Ι
 Δ Λ

Balyzeh

FP

16
 † Ι Σ Χ Σ
 Π Ε Ν Ι Ψ Τ Α Π
 Α Α Π Ο Λ Ω
 Α Π Α Π Ε Τ Ρ Ε
 Α Π Α Ι Ω Ζ Α Ι Ν
 Ϡ Ρ Ι Π Π Ι Ε Ε
 Π Α Λ Ο Ν Φ Ι
 Θ Ε Ο Σ Ι Ω Ζ
 Ν Η Ψ Τ Ρ Ε Ψ Ω

Balyzeh

FP

WORKS BY W. M. FLINDERS PETRIE.

- THE PYRAMIDS AND TEMPLES OF GIZEH. (Out of print.)
- TANIS I. 19 pl., 25s. *Quaritch.*
- TANIS II. Nebesheh and Defenneh. 64 pl., 25s. *Quaritch.*
- NAUKRATIS I. 45 pl., 25s. *Quaritch.*
- HIEROGLYPHIC PAPYRUS FROM TANIS. (Out of print.)
- A SEASON IN EGYPT, 1887. 32 pl. (Out of print.)
- RACIAL PORTRAITS. 190 photographs from Egyptian Monuments, 63s. *Murray, 37, Dartmouth Park Hill, N.W.*
- HISTORICAL SCARABS. (Out of print.)
- HAWARA, BIAHMU, AND ARSINOE. (Out of print.)
- KAHUN, GUROB, AND HAWARA. (Out of print.)*
- ILLAHUN, KAHUN, AND GUROB. 33 pl., 16s. (Out of print.)*
- TELL EL HESY (LACHISH). 10 pl., 10s. 6d. *Alexander Watt.*
- MEDUM. 36 pl. (Out of print.)
- TEN YEARS' DIGGING IN EGYPT, 1881-1891. 6s. *R.T.S.*
- TELL EL AMARNA. (Out of print.)*
- KOPTOS. 28 pl., 10s. *Quaritch.*
- A STUDENT'S HISTORY OF EGYPT. Part I., down to the XVIth Dynasty. 5th ed. 1903. Part II., XVIIth and XVIIIth Dynasties. Part III., XIXth to XXXth Dynasties. 6s. each. *Methuen.*
- TRANSLATIONS OF EGYPTIAN TALES. With illustrations by Tristram Ellis. 2 vols., 3s. 6d. *Methuen.*
- DECORATIVE ART IN EGYPT. 3s. 6d. *Methuen.*
- NAQADA AND BALLAS. 86 pl., 25s. *Quaritch.*
- SIX TEMPLES AT THEBES. 26 pl., 10s. *Quaritch.*
- DESHASHEH. 37 pl., 25s. *Quaritch.*
- RELIGION AND CONSCIENCE IN EGYPT. 2s. 6d. *Methuen.*
- SYRIA AND EGYPT. 2s. 6d. *Methuen.*
- DENDEREH. 38 pl., 25s.; 40 additional plates, 10s. *Quaritch.*
- ROYAL TOMBS OF FIRST DYNASTY. 68 pl., 25s. *Quaritch.*
- DIOSPOLIS PARVA. 48 pl. (Out of print.)
- ROYAL TOMBS OF EARLIEST DYNASTIES. 63 pl., 25s.; 35 additional plates, 10s. *Quaritch.*
- ABYDOS. Part I. 81 pl., 25s. *Quaritch.*
- ABYDOS. Part II. 64 pl., 25s. *Quaritch.*
- METHODS AND AIMS IN ARCHAEOLOGY. 66 blocks, 6s. *Macmillan.*
- EHNASYA. 25s. *Quaritch.*
- ROMAN EHNASYA. 10s. *Quaritch.*
- RESEARCHES IN SINAI. 186 illustrations and 4 plans, 21s. *John Murray.*
- HYKSOS AND ISRAELITE CITIES. 40 pl., 25s.; with 48 extra plates, 45s. *Quaritch.*
- RELIGION OF ANCIENT EGYPT. 1s. *Constable.*
- GIZEH AND RIFEH. 40 pl., 25s.; with 69 extra plates, 50s. *Quaritch.*
- ATHRIBIS. 43 pl., 25s. *Quaritch.*
- PERSONAL RELIGION IN EGYPT BEFORE CHRISTIANITY. 2s. 6d.; in leather, 3s. 6d. *Harper.*
- MEMPHIS. Part I. 54 pl., 25s. *Quaritch.*
- QURNEH. 56 pl. (*In preparation.*)
- MEMPHIS. Part II. (*In preparation.*)

Of works marked * a few copies can be had on application to the Author, University College, London.

PUBLICATIONS

OF THE

EGYPTIAN RESEARCH ACCOUNT

- I. BALLAS, 1895; by J. E. QUIBELL. (Out of print; obtainable in joint volume NAQADA AND BALLAS, by W. M. F. PETRIE.)
 - II. THE RAMESSEUM, 1896; by J. E. QUIBELL. (Out of print.)
 - III. EL KAB, 1897; by J. E. QUIBELL.
 - IV. HIERAKONPOLIS I, 1898; text by W. M. F. P. 43 plates. 20s. *net*.
 - V. HIERAKONPOLIS II, 1899; by F. W. GREEN and J. E. QUIBELL. 39 plates (4 coloured and 20 photographic). 35s. *net*.
 - VI. EL ARABAH, 1900; by J. GARSTANG. 40 plates. 16s. *net*. (Out of print.)
 - VII. MAHASNA, 1901; by J. GARSTANG and KURT SETHE. 43 plates. 20s. *net*. (Out of print.)
 - VIII. TEMPLE OF THE KINGS, 1902; by A. ST. G. CAULFIELD. 24 plates. 16s. *net*. (Out of print.)
 - IX. THE OSIREION, 1903; by MARGARET A. MURRAY. 37 plates. 21s. *net*. (Out of print.)
 - X. SAQQARA MASTABAS I, 1904; by M. A. MURRAY; AND GUROB, by L. LOAT. 64 plates. 30s. *net*.
 - XI. SAQQARA MASTABAS II, 1905; by HILDA PETRIE. (*In preparation.*)
 - XII. HYKSOS AND ISRAELITE CITIES, 1906; by W. M. FLINDERS PETRIE and J. GARROW DUNCAN. 40 plates. 25s. *net*. In double volume with 94 plates. 45s. *net*. (This latter out of print.)
 - XIII. GIZEH AND RIFEH, 1907; by W. M. FLINDERS PETRIE. 40 plates. 25s. *net*. In double volume with 109 plates. 50s. *net*.
 - XIV. ATHRIBIS, 1908; by W. M. FLINDERS PETRIE, J. H. WALKER and E. B. KNOBEL. 43 plates. 25s. *net*.
 - XV. MEMPHIS I., 1908; by W. M. FLINDERS PETRIE and J. H. WALKER. 54 plates. 25s. *net*.
 - XVI. QURNEH, 1909; by W. M. FLINDERS PETRIE. 56 plates. (*In preparation.*)
 - XVII. MEMPHIS II, 1909. (*In preparation.*)
-

Subscriptions of One Guinea for the Annual Single Volumes, or Two Guineas for the Double Volumes, are received by the Hon. Secretary, at the Edwards Library, University College, Gower Street, London, W.C., where also copies of the above works can be obtained.