

UNIVERSITY OF TORONTO

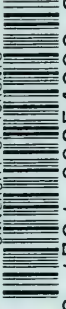

3 1761 00254393 2



Digitized for Microsoft Corporation
by the Internet Archive in 2008.
From University of Toronto.

May be used for non-commercial, personal, research,
or educational purposes, or any fair use.
May not be indexed in a commercial service.



VIEW OF THE COLORED INTERIOR OF THE TEMPLE
WEST THEBES (MEMNONIUM).

History of Egypt

Chaldea, Syria, Babylonia, and Assyria

By G. MASPERO, Honorable Doctor of Civil Laws,
and Fellow of Queen's College, Oxford; Member of
the Institute and Professor at the College of France

Edited by A. H. SAYCE, Professor of Assyriology, Oxford

Translated by M. L. McCLURF, Member of
the Committee of the Egypt Exploration Fund



VOL. II

*Containing over Twelve Hundred
Colored Plates and Illustrations*

THE GROLIER SOCIETY
PUBLISHERS △ △ △ LONDON

DS
63
1873
2
1

607514
13.5.55

Printed by
WILLIAM CLOWES AND SONS, LIMITED
LONDON

CONTENTS

CHAPTER I.

THE POLITICAL CONSTITUTION OF EGYPT

| | PAGE |
|--|------|
| The King, the Queen, and the Royal Princes — Administration under the Pharaohs — Feudalism and the Egyptian Priesthood, the Military — The Citizens and Country People | 3 |

CHAPTER II.

THE MEMPHITE EMPIRE

| | |
|---|-----|
| The Royal Pyramid Builders : Kheops, Khephren, Mykerinos — Memphite Literature and Art — Extension of Egypt toward the South, and the Conquest of Nubia by the Pharaohs | 151 |
|---|-----|

CHAPTER III.

THE FIRST THEBAN EMPIRE

| | |
|---|-----|
| The Two Heracleopolitan Dynasties and the Twelfth Dynasty — The Conquest of Æthiopia, and the making of Greater Egypt by the Theban Kings | 295 |
|---|-----|

LIST OF ILLUSTRATIONS



| | PAGE |
|--|---------------------|
| View of the colored interior of the Temple at West Thebes (Memnonium) | 3 |
| | <i>Frontispiece</i> |
| The Sphinx and the Pyramids of Gîzeh, seen at sunset | 3 |
| The Mastaba of Khomtini in the Necropolis of Gîzeh | 4 |
| The Great Sphinx of Gîzeh partially uncovered, and the Pyramid of Khephren | 6 |
| Tetiniônkhû, sitting before the funeral repast | 8 |
| The façade and the stele of the tomb of Phtahshopsisu at Saqqâra | 9 |
| Stele in the form of a door, and the statue of the tomb of Mirrûka | 11 |
| A representation of the domains of the Lord Ti, bringing to him their offerings in procession | 14 |
| The representation of the Lord Ti assisting at the preliminaries of the sacrifice and offerings | 15 |
| The birth of a king and his double | 21 |
| The adult king advancing, followed by his double | 24 |
| The goddess adopts the king by suckling him | 28 |
| Different postures for approaching the king | 30 |
| Pharaoh in his harem | 37 |
| Pharaoh gives solemn audience to one of his ministers | 39 |
| The queen shakes the sistrum while the king offers the sacrifice | 42 |
| Island and Temple of Philæ | 44 |
| Men and women singers, flute-players, harpists, and dancers from the tomb of Ti | 51 |
| The dwarf Khnûmhotpû, superintendent of the royal linen | 52 |
| The packing of the linen and its removal to the white storehouse | 59 |
| Measuring the wheat and depositing it in the granaries | 61 |
| The staff of a government officer in the time of the Memphite dynasties | 65 |
| The crier announces the arrival of five registrars of the Temple of King Ûsirnîrî, of the Fifth Dynasty | 67 |
| The funeral stele of the tomb of Amten, the "Grand Huntsman" | 69 |
| Statue of Amten found in his tomb | 72 |
| Hunting with the boomerang and fishing with the double harpoon in a marsh or pool | 77 |

| | PAGE |
|--|------|
| Prince Api, borne in a palanquin, inspects his funerary domain | 78 |
| A dwarf playing with Cynocephali and a tame Ibis | 79 |
| In a Nile boat | 80 |
| War-dance performed by Egyptian soldiers before a battle | 95 |
| Two blacksmiths working the bellows | 98 |
| Stone-cutters finishing the dressing of limestone blocks | 99 |
| A workshop of shoemakers manufacturing sandals | 101 |
| The baker making his bread and placing it in the oven | 102 |
| The house of a great Egyptian lord | 103 |
| Stele of Sîtû, representing the front of a house | 105 |
| A street in the higher quarter of modern Siût | 106 |
| A hall with columns in one of the Twelfth Dynasty houses at Gurob | 107 |
| Mural paintings in the ruins of an ancient house at Kahun | 110 |
| Woman grinding grain | 111 |
| Two women weaving linen at a horizontal loom | 114 |
| One of the forms of Egyptian scales | 118 |
| Scenes in a bazaar | 119 |
| Part of the modern village of Karnak, to the west of the Temple of Apît | 123 |
| The levying of the tax : The taxpayer in the scribe's office | 128 |
| Levying the tax : The taxpayer in the hands of the exactors | 130 |
| Lévying the tax : The bastinado | 131 |
| The colossal statue of Prince Thothotpû being dragged by the Corvée | 133 |
| Colored sculptures in the gallery of the Palace at Thebes | 136 |
| Two fellahîn work the shadouf in a garden | 142 |
| The cutting and carrying of the harvest | 143 |
| The Pyramid of Snofrûi at Médûm | 151 |
| A barbarian Monîti from Sinai | 156 |
| Two refuge towers of the Hirû-Shâîtû, in the Wady Biar | 157 |
| View of the oasis of Wady Feîrân in the Peninsula of Sinai | 159 |
| The high castle of the miners — Hâît-Qaît — at the confluence of Wady Genneh and Wady Maghara | 164 |
| The court and the two stelæ of the chapel adjoining the Pyramid of Médûm | 171 |
| Nofrit, lady of Médûm | 173 |
| Alabaster statue of Kheops | 175 |
| The triumphal bas-reliefs of Kheops on the Rocks of Wady Maghara | 176 |
| Khûit, the Great Pyramid of Gîzeh, the Sphinx, and the Temple of the Sphinx | 179 |
| The ascending passage of the Great Pyramid | 183 |
| Alabaster statue of Khephren | 188 |
| The Pyramid of Khephren, seen from the south-east | 189 |

LIST OF ILLUSTRATIONS

ix

| | PAGE |
|--|------|
| Diorite statue of Mankaûri | 192 |
| The granite sarcophagus of Mykerinos | 196 |
| Diorite statue of Khephren, Gîzeh museum | 198 |
| Statue in rose-colored granite of the Pharaoh Ânû, in the Gîzeh museum | 216 |
| Triumphal bas-relief of Pharaoh Sahûrû, on the rocks of Wady Magharah | 217 |
| Passenger vessel under sail | 219 |
| Head of an inhabitant of Pûanît | 225 |
| A sculptor's studio, and Egyptian painters at work | 237 |
| Avenue of Sphinxes — Karnak | 235 |
| Cellarer coating a jar with pitch | 238 |
| Baker kneading his dough | 239 |
| The Sheikh-el-Beled in the Gîzeh museum | 241 |
| The kneeling scribe in the Gîzeh museum | 242 |
| The sitting scribe in the Gîzeh museum | 243 |
| Nofir, the director of granaries | 247 |
| Stele of the daughter of Kheops | 251 |
| The Pharaoh Menkaûhorû | 253 |
| The Mastabat-el-Faraun, looking toward the west façade | 255 |
| The island of Elephantinê seen from the ruins of Syene | 266 |
| Small Wady, five hours beyond Ed-Doueîg, on the road to the Red Sea | 269 |
| The rocks of the island of Sehêl, with some of the votive inscriptions | 271 |
| The mountain of Aswan and the tombs of the princes of Elephantinê | 275 |
| Hirkhûf receiving posthumous homage at the door of his tomb from his son | 278 |
| Head of the mummy of Metesouphis I. | 282 |
| The sepulchral chamber in the Pyramid of Ûnas, and his sarcophagus | 284 |
| The entrance to the Pyramid of Ûnas at Saqqâra | 287 |
| The hills of Thebes, as seen from the southern end of Luxor | 295 |
| Part of the walls of El-Kab on the northern side | 300 |
| The second fortress of Abydos — the Shûnet-ez-Zebîb — as seen from the east | 302 |
| Attack upon an Egyptian fortress by troops of various arms | 304 |
| Temple of Tentyra — Denderah | 306 |
| The heavy infantry of the Princes of Siût, armed with lance and buckler | 311 |
| The brick pyramid of Antûfâa, at Thebes | 314 |
| The Pharaoh Monthotpû receiving the homage of his successor — Antûf — in the Shat Er-Rigâleh | 318 |
| An Asiatic chief is presented to Khnûmhotpû by Nofirhotpû, and by Khîti, the superintendent of the huntsmen | 325 |
| Some of the band of Asiatics, with their beasts, brought from Khnûmhotpû | 326 |
| The women passing by in procession, in charge of a warrior and of a man playing upon the lyre | 327 |
| The ruins of the Temple of Hâthor at Sarbût-el-Khâdim | 335 |
| One of the façades of the fortress of Kubbân | 344 |

| | PAGE |
|--|------|
| The Second Cataract at Low Nile, seen from Abusîr | 347 |
| The triumphal stele of Ûsirtasen I. | 349 |
| The channel of the Nile between the two fortresses of Semneh and Kummeh | 353 |
| Kûshite prisoners brought to Egypt | 355 |
| The statue of Nofrit | 372 |
| One of the Tanis sphinxes in the Gizeh museum | 376 |
| The obelisk of Ûsirtasen I., still standing in the plain of Heliopolis | 381 |
| Ûsirtasen I. of Abydos | 384 |
| A part of the ancient sacred lake of Osiris near the Temple of Abydos | 385 |
| The site of the ancient Heracleopolis | 386 |
| Sobkû, the god of the Fayûm, under the form of a sacred crocodile | 387 |
| The ruined pedestal of one of the colossi of Biahmû | 389 |
| A view in the Fayûm in the neighborhood of the village of Fidemîn | 390 |
| The court of the small temple to the north of the Birket-Kerun | 391 |
| The shores of the Birket-Kerun near the embouchure of the Wady Nazleh | 392 |
| The two pyramids of the Twelfth Dynasty at Lisht | 393 |
| The Pyramid of Illahun, at the entrance of the Fayûm | 396 |
| The mountain of Siût with the tombs of the princes | 399 |
| The modern cemetery of Zawyet El-Meiyetîn | 405 |
| The tombs of princes of the Gazelle-Nome at Beni-Hasan | 408 |
| The colossal statue of King Sovkhotpû in the Louvre | 411 |
| Statue of Harsuf in the Vienna museum | 414 |
| Statue of Sovkhotpû III. | 415 |
| One of the overturned and broken statues of Mirmâshaû at Tanis | 417 |



THE POLITICAL CONSTITUTION OF EGYPT

THE KING, QUEEN, AND ROYAL PRINCES—PHARAONIC ADMINISTRATION—
FEUDALISM AND THE EGYPTIAN PRIESTHOOD, THE MILITARY—THE
CITIZENS AND THE COUNTRY-PEOPLE.

The cemeteries of Gîzeh and Saqqâra : the Great Sphinx ; the mastabas, their chapel and its decoration, the statues of the double, the sepulchral vault—Importance of the wall paintings and texts of the mastabas in determining the history of the Memphite dynasties.

The king and the royal family—Double nature and titles of the sovereign : his Horus-names, and the progressive formation of the Pharaonic Protocol—Royal etiquette an actual divine worship ; the insignia and prophetic statues of Pharaoh, Pharaoh the mediator between the gods and his subjects—Pharaoh in family life ; his amusements, his occupations, his cares—His harem : the women, the queen, her origin, her duties to the king—His children : their position in the State ; rivalry among them during the old age and at the death of their father ; succession to the throne, consequent revolutions.

The royal city : the palace and its occupants—The royal household and its officers : Pharaoh's jesters, dwarfs, and magicians—The royal domain and the slaves, the treasury and the establishments which provided for its service : the buildings and places for the receipt of taxes—The scribe, his education, his chances of promotion : the career of Amen, his successive offices, the value of his personal property at his death.

Egyptian feudalism : the status of the lords, their rights, their amusements, their obligations to the sovereign—The influence of the gods : gifts to the temples, and possessions in mortmain ; the priesthood, its hierarchy, and the method of recruiting its ranks—The military : foreign mercenaries ; native militia, their privileges, their training.

The people of the towns—The slaves, men without a master—Workmen and artisans ; corporations : misery of handicraftsmen—Aspect of the towns : houses, furniture, women in family life—Festivals ; periodic markets, bazaars : commerce by barter, the weighing of precious metals.

The country people—The villages ; serfs, free peasantry—Rural domains ; the survey, taxes ; the bastinado, the corvée—Administration of justice, the relations between peasants and their lords ; misery of the peasantry ; their resignation and natural cheerfulness ; their improvidence ; their indifference to political revolutions.

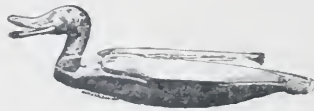



THE SPHINX AND THE PYRAMIDS OF GÍZEH, SEEN AT SUNSET.¹

CHAPTER I

THE POLITICAL CONSTITUTION OF EGYPT

The king, the queen, and the royal princes—Administration under the Pharaohs—Feudalism and the Egyptian priesthood, the military—The citizens and country people.

BETWEEN the Fayûm and the apex of the Delta, the Lybian range expands and forms a vast and slightly undulating table-land, which runs parallel to the Nile for nearly thirty leagues. The Great Sphinx Harmakhis has mounted guard over its northern extremity ever since the time of the Followers of Horus. Hewn out of the solid rock at the extreme margin of the mountain-plateau, he seems to raise his head in order that he may be the first to behold across the valley the



¹ Drawn by Boudier, from *La Description de l'Égypte*, A., vol. v. pl. 7. The vignette, which is also by Boudier, represents a man bewailing the

rising of his father the Sun. Only the general outline of the lion can now be traced in his weather-worn body. The lower portion of the head-dress has fallen, so that the neck appears too slender to support the weight of the head. The cannon-shot of the fanatical Mamelukes has injured both the nose and beard, and the red colouring which gave animation to his features has now almost entirely disappeared. But in spite of this, even in its decay, it still bears a commanding expression of strength and dignity. The eyes look into the far-off dis-



THE MASTABA OF KHMONTINI IN THE NECROPOLIS OF GIZEH.¹

tance with an intensity of deep thought, the lips still smile, the whole face is pervaded with calmness and power. The art that could conceive and hew this gigantic statue out of the mountain-side, was an art in its maturity, master of itself and sure of its effects. How many centuries were

dead, in the attitude adopted at funerals by professional mourners of both sexes; the right fist resting on the ground, while the left hand scatters on the hair the dust which he has just gathered up. The statue is in the Gizeh Museum.

¹ Drawn by Faucher-Gudin, from a sketch by Lepsius. The corner-stone at the top of the mastaba, at the extreme left of the hieroglyphic frieze, had been loosened and thrown to the ground by some explorer; the artist has restored it to its original position.

needed to bring it to this degree of development and perfection! In later times, a chapel of alabaster and rose granite was erected alongside the god; temples were built here and there in the more accessible places, and round these were grouped the tombs of the whole country. The bodies of the common people, usually naked and uncoffined, were thrust under the sand, at a depth of barely three feet from the surface. Those of a better class rested in mean rectangular chambers, hastily built of yellow bricks, and roofed with pointed vaulting. No ornaments or treasures gladdened the deceased in his miserable resting-place; a few vessels, however, of coarse pottery contained the provisions left to nourish him during the period of his second existence.

Some of the wealthy class had their tombs cut out of the mountain-side; but the majority preferred an isolated tomb, a "mastaba,"¹ comprising a chapel above ground, a shaft, and some subterranean vaults. From a distance these chapels have the appearance of truncated pyramids, varying in size according to the fortune or taste of the owner; there are some which measure 30 to 40 ft. in

¹ "The Arabic word 'mastaba,' plur. 'masatib,' denotes the stone bench or platform seen in the streets of Egyptian towns in front of each shop. A carpet is spread on the 'mastaba,' and the customer sits upon it to transact his business, usually side by side with the seller. In the necropolis of Saqqâra, there is a temple of gigantic proportions in the shape of a 'mastaba.' The inhabitants of the neighbourhood call it 'Mastabat-el-Farâoun,' the seat of Pharaoh, in the belief that anciently one of the Pharaohs sat there to dispense justice. The Memphite tombs of the Ancient Empire, which thickly cover the Saqqâra plateau, are more or less miniature copies of the 'Mastabat-el-Farâoun.' Hence the name of mastabas, which has always been given to this kind of tomb, in the necropolis of Saqqâra."

height, with a façade 160 ft. long, and a depth from back to front of some 80 ft., while others attain only a height of some 10 ft. upon a base of 16 ft. square.¹ The walls slope uniformly towards one another, and usually have a smooth surface; sometimes, however, their courses are set back



THE GREAT SPHINX OF GÍZEH PARTIALLY UNCOVERED, AND THE PYRAMID OF KHEPHREN.²

one above the other almost like steps. The brick mastabas were carefully cemented externally, and the layers bound

¹ The mastaba of Sabû is 175 ft. 9 in. long, by about 87 ft. 9 in. deep, but two of its sides have lost their facing; that of Rânimâit measures 171 ft. 3 in. by 84 ft. 6 in. on the south front, and 100 ft. on the north front. On the other hand, the mastaba of Papû is only 19 ft. 4 in. by 29 ft. long, and that of Khâbiûptah 42 ft. 4 in. by 21 ft. 8 in.

² Drawn by Boudier, from a photograph by Émil Brugsch-Bey, taken in the course of the excavations begun in 1886, with the funds furnished by a public subscription opened by the *Journal des Débats*.

together internally by fine sand poured into the interstices. Stone mastabas, on the contrary, present a regularity in the decoration of their facings alone; in nine cases out of ten the core is built of rough stone blocks, rudely cut into squares, cemented with gravel and dried mud, or thrown together pell-mell without mortar of any kind. The whole building should have been orientated according to rule, the four sides to the four cardinal points, the greatest axis directed north and south; but the masons seldom troubled themselves to find the true north, and the orientation is usually incorrect.¹ The doors face east, sometimes north or south, but never west. One of these is but the semblance of a door, a high narrow niche, contrived so as to face east, and decorated with grooves framing a carefully walled-up entrance; this was for the use of the dead, and it was believed that the ghost entered or left it at will. The door for the use of the living, sometimes preceded by a portico, was almost always characterized by great simplicity. Over it is a cylindrical tympanum, or a smooth flagstone, bearing sometimes merely the name of the dead person, sometimes his titles and descent, sometimes a prayer for his welfare, and an enumeration of the days during which he was entitled to receive the worship due to ancestors. They invoked on his behalf, and almost always precisely in the same words, the "Great God," the Osiris of Mendes, or else Anubis, dwelling in the Divine Palace, that burial might be granted to him in Amentît, the land of the West,

¹ Thus the axis of the tomb of Pirsênû is 17° east of the magnetic north. In some cases the divergence is only 1° or 2°, more often it is 6°, 7°, 8°, or 9°, as can be easily ascertained by consulting the work of Mariette.

the very great and very good, to him the vassal of the Great God; that he might walk in the ways in which it is good to walk, he the vassal of the Great God; that he might have offerings of bread, cakes, and drink, at the New Year's Feast, at the feast of Thot, on the first day of the year, on the feast of Ūgait, at the great fire festival, at the pro-



TETINIÔNKHÛ, SITTING BEFORE THE FUNERAL REPAST.¹

cession of the god Mîntû, at the feast of offerings, at the monthly and half-monthly festivals, and every day.

The chapel is usually small, and is almost lost in the great extent of the building.² It generally consists merely

¹ Drawn by Boudier, from a photograph of the original monument which is preserved in the Liverpool Museum; cf. GATTY, *Catalogue of the Mayer Collection*; I. Egyptian Antiquities, No. 294, p. 45.

² Thus the chapel of the mastaba of Sabû is only 14 ft. 4 in. long, by

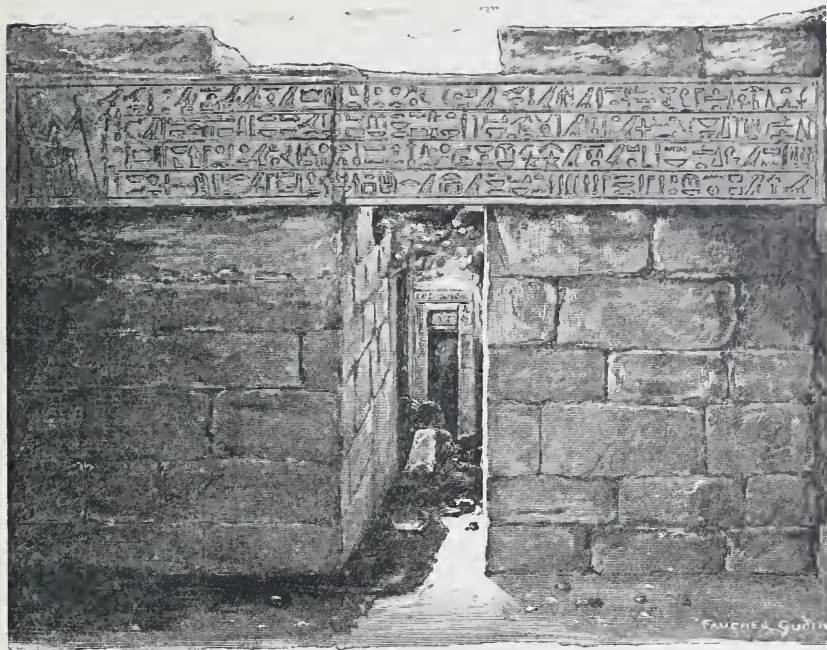

THE FAÇADE AND THE STELE OF THE TOMB OF PHTAHSHOPSISU AT SAQQÂRA.¹

of an oblong chamber, approached by a rather short passage.² At the far end, and set back into the western wall, is a about 3 ft. 3 in. deep, and that of the tomb of Phtahshopsisû, 10 ft. 4 in. by 3 ft. 7 in.

¹ Drawn by Faucher-Gudin, from a photograph by DÛMICHEN.

² The mastaba of Tinti has four chambers, as has also that of Assi-ônkhû ; but these are exceptions, as may be ascertained by consulting the work of Mariette. Most of those which contain several rooms are ancient one-roomed mastabas, which have been subsequently altered or enlarged ; this is the case with the mastabas of Shopsi and of Ankhafûtka. A few, however, were constructed from the outset with all their apartments—that of Râonkhûmai, with six chambers and several niches ; that of Khâbiûptah, with three chambers, niches, and doorway ornamented with two pillars ; that of Ti, with two chambers, a court surrounded with pillars, a doorway, and long inscribed passages ; and that of Phtahhotpû, with seven chambers, besides niches.

huge quadrangular stele, at the foot of which is seen the table of offerings, made of alabaster, granite or limestone placed flat upon the ground, and sometimes two little obelisks or two altars, hollowed at the top to receive the gifts mentioned in the inscription on the exterior of the tomb. The general appearance is that of a rather low, narrow doorway, too small to be a practicable entrance. The recess thus formed is almost always left empty; sometimes, however, the piety of relatives placed within it a statue of the deceased. Standing there, with shoulders thrown back, head erect, and smiling face, the statue seems to step forth to lead the double from its dark lodging where it lies embalmed, to those glowing plains where he dwelt in freedom during his earthly life: another moment, crossing the threshold, he must descend the few steps leading into the public hall. On festivals and days of offering, when the priest and family presented the banquet with the customary rites, this great painted figure, in the act of advancing, and seen by the light of flickering torches or smoking lamps, might well appear endued with life. It was as if the dead ancestor himself stepped out of the wall and mysteriously stood before his descendants to claim their homage. The inscription on the lintel repeats once more the name and rank of the dead. Faithful portraits of him and of other members of his family figure in the bas-reliefs on the door-posts. The little scene at the far end represents him seated tranquilly at table, with the details of the feast carefully recorded at his side, from the first moment when water is brought to him for ablution, to that when, all culinary skill being exhausted, he has



STELE IN THE FORM OF A DOOR, AND THE STATUE OF THE TOMB OF MIRRÛKA.

Drawn by Boudier, from a photograph of the tomb of Mirrûka, taken by M. de Morgan.

but to return to his dwelling, in a state of beatified satisfaction. The stele represented to the visitor the door leading to the private apartments of the deceased; the fact of its being walled up for ever showing that no living mortal might cross its threshold. The inscription which covered its surface was not a mere epitaph informing future generations who it was that reposed beneath. It perpetuated the name and genealogy of the deceased, and gave him a civil status, without which he could not have preserved his personality in the world beyond; the nameless dead, like a living man without a name, was reckoned as non-existing. Nor was this the only use of the stele; the pictures and prayers inscribed upon it acted as so many talismans for ensuring the continuous existence of the ancestor, whose memory they recalled. They compelled the god therein invoked, whether Osiris or the jackal Anubis, to act as mediator between the living and the departed; they granted to the god the enjoyment of sacrifices and those good things abundantly offered to the deities, and by which they live, on condition that a share of them might first be set aside for the deceased. By the divine favour, the soul or rather the doubles of the bread, meat, and beverages passed into the other world, and there refreshed the human double. It was not, however, necessary that the offering should have a material existence, in order to be effective; the first comer who should repeat aloud the name and the formulas inscribed upon the stone, secured for the unknown occupant, by this means alone, the immediate possession of all the things which he enumerated.

The stele constitutes the essential part of the chapel and tomb. In many cases it was the only inscribed portion, it alone being necessary to ensure the identity and continuous existence of the dead man; often, however, the sides of the chamber and passage were not left bare. When time or the wealth of the owner permitted, they

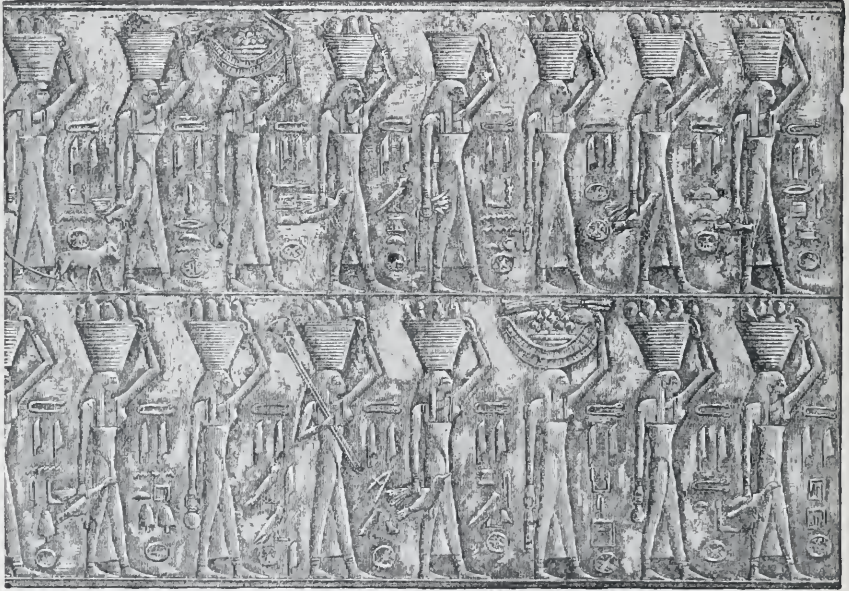

A REPRESENTATION OF THE DOMAINS OF THE LORD TI, BRINGING TO HIM THEIR OFFERINGS IN PROCESSION.¹

were covered with scenes and writing, expressing at greater length the ideas summarized by the figures and inscriptions of the stele. Neither pictorial effect nor the caprice of the

¹ Drawn by Faucher-Gudin, from a "squeeze" taken from the tomb of Ti. The domains are represented as women. The name is written before each figure, with the designation of the landowner—"the nebbek [locust tree?] of Ti," "the two sycamores of Ti," "the wine of Ti;" cf. p. 126 of this volume.

moment was permitted to guide the artist in the choice of his subjects; all that he drew, pictures or words, had a magical purpose. Every individual who built for himself

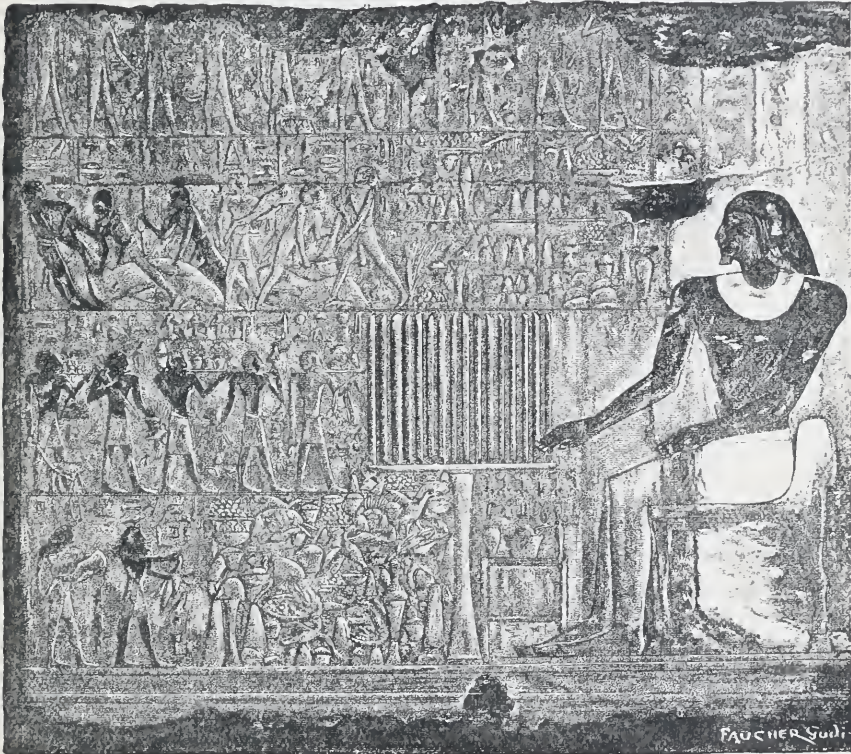

THE REPRESENTATION OF THE LORD TI ASSISTING AT THE PRELIMINARIES OF THE SACRIFICE AND OFFERINGS.¹

an "eternal house," either attached to it a staff of priests of the double, of inspectors, scribes, and slaves, or else made an agreement with the priests of a neighbouring temple to serve the chapel in perpetuity. Lands taken

¹ Drawn by Faucher-Gudin, from a photograph by DÜMICHEN, *Resultate*, vol. i. pl. 13.

from his patrimony, which thus became the "Domains of the Eternal House," rewarded them for their trouble, and supplied them with meats, vegetables, fruits, liquors, linen and vessels for sacrifice. In theory, these "liturgies" were perpetuated from year to year, until the end of time; but in practice, after three or four generations, the older ancestors were forsaken for those who had died more recently. Notwithstanding the imprecations and threats of the donor against the priests who should neglect their duty, or against those who should usurp the funeral endowments, sooner or later there came a time when, forsaken by all, the double was in danger of perishing for want of sustenance. In order to ensure that the promised gifts, offered in substance on the day of burial, should be maintained throughout the centuries, the relatives not only depicted them upon the chapel walls, but represented in addition the lands which produced them, and the labour which contributed to their production. On one side we see ploughing, sowing, reaping, the carrying of the corn, the storing of the grain, the fattening of the poultry, and the driving of the cattle. A little further on, workmen of all descriptions are engaged in their several trades: shoemakers ply the awl, glassmakers blow through their tubes, metal founders watch over their smelting-pots, carpenters hew down trees and build a ship; groups of women weave or spin under the eye of a frowning taskmaster, who seems impatient of their chatter. Did the double in his hunger desire meat? He might choose from the pictures on the wall the animal that pleased him best, whether kid, ox, or gazelle; he might follow the course of its life, from its

birth in the meadows to the slaughter-house and the kitchen, and might satisfy his hunger with its flesh. The double saw himself represented in the paintings as hunting, and to the hunt he went; he was painted eating and drinking with his wife, and he ate and drank with her; the pictured ploughing, harvesting, and gathering into barns, thus became to him actual realities. In fine, this painted world of men and things represented upon the wall was quickened by the same life which animated the double, upon whom it all depended: the *picture* of a meal or of a slave was perhaps that which best suited the *shade* of guest or of master.

Even to-day, when we enter one of these decorated chapels, the idea of death scarcely presents itself: we have rather the impression of being in some old-world house, to which the master may at any moment return. We see him portrayed everywhere upon the walls, followed by his servants, and surrounded by everything which made his earthly life enjoyable. One or two statues of him stand at the end of the room, in constant readiness to undergo the "Opening of the Mouth" and to receive offerings. Should these be accidentally removed, others, secreted in a little chamber hidden in the thickness of the masonry, are there to replace them. These inner chambers have rarely any external outlet, though occasionally they are connected with the chapel by a small opening, so narrow that it will hardly admit of a hand being passed through it. Those who came to repeat prayers and burn incense at this aperture were received by the dead in person. The statues were not mere images, devoid of consciousness. Just as

the double of a god could be linked to an idol in the temple sanctuary in order to transform it into a prophetic being, capable of speech and movement, so when the double of a man was attached to the effigy of his earthly body, whether in stone, metal, or wood, a real living person was created and was introduced into the tomb. So strong was this conviction that the belief has lived on through two changes of religion until the present day. The double still haunts the statues with which he was associated in the past. As in former times, he yet strikes with madness or death any who dare to disturb his repose; and one can only be protected from him by breaking, at the moment of discovery, the perfect statues which the vault contains. The double is weakened or killed by the mutilation of these his sustainers.¹ The statues furnish in their modelling a more correct idea of the deceased than his mummy, disfigured as it was by the work of the embalmers; they were also less easily destroyed, and any number could be made at will. Hence arose the really incredible number of statues sometimes hidden away in the same tomb. These sustainers or imperishable bodies of the double were multiplied so as to insure for him a practical immortality;

¹ The legends still current about the pyramids of Gizeh furnish some good examples of this kind of superstition. "The guardian of the Eastern pyramid was an idol . . . who had both eyes open, and was seated on a throne, having a sort of halberd near it, on which, if any one fixed his eye, he heard a fearful noise, which struck terror to his heart, and caused the death of the hearer. There was a spirit appointed to wait on each guardian, who departed not from before him." The keeping of the other two pyramids was in like manner entrusted to a statue, assisted by a spirit. I have collected a certain number of tales resembling that of Mourtadi in the *Études de Mythologie et d'Archéologie Égyptiennes*, vol. i. p. 77, et seq.

and the care with which they were shut into a secure hiding-place, increased their chances of preservation. All the same, no precaution was neglected that could save a mummy from destruction. The shaft leading to it descended to a mean depth of forty to fifty feet, but sometimes it reached, and even exceeded, a hundred feet. Running horizontally from it is a passage so low as to prevent a man standing upright in it, which leads to the sepulchral chamber properly so called, hewn out of the solid rock and devoid of all ornament; the sarcophagus, whether of fine limestone, rose-granite, or black basalt, does not always bear the name and titles of the deceased. The servants who deposited the body in it placed beside it on the dusty floor the quarters of the ox, previously slaughtered in the chapel, as well as phials of perfume, and large vases of red pottery containing muddy water; after which they walled up the entrance to the passage and filled the shaft with chips of stone intermingled with earth and gravel. The whole, being well watered, soon hardened into a compact mass, which protected the vault and its master from desecration.

During the course of centuries, the ever-increasing number of tombs at length formed an almost uninterrupted chain of burying-places on the table-land. At Gîzeh they follow a symmetrical plan, and line the sides of regular roads; at Saqqâra they are scattered about on the surface of the ground, in some places sparsely, in others huddled confusedly together. Everywhere the tombs are rich in inscriptions, statues, and painted or sculptured scenes, each revealing some characteristic custom, or some detail

of contemporary civilization. From the womb, as it were, of these cemeteries, the Egypt of the Memphite dynasties gradually takes new life, and reappears in the full daylight of history. Nobles and fellahs, soldiers and priests, scribes and craftsmen,—the whole nation lives anew before us; each with his manners, his dress, his daily round of occupation and pleasures. It is a perfect picture, and although in places the drawing is defaced and the colour dimmed, yet these may be restored with no great difficulty, and with almost absolute certainty. The king stands out boldly in the foreground, and his tall figure towers over all else. He so completely transcends his surroundings, that at first sight one may well ask if he does not represent a god rather than a man; and, as a matter of fact, he is a god to his subjects. They call him “the good god,” “the great god,” and connect him with Râ through the intervening kings, the successors of the gods who ruled the two worlds. His father before him was “Son of Râ,” as was also his grandfather, and his great-grandfather, and so through all his ancestors, until from “son of Râ” to “son of Râ” they at last reached Râ himself. Sometimes an adventurer of unknown antecedents is abruptly inserted in the series, and we might imagine that he would interrupt the succession of the solar line; but on closer examination we always find that either the intruder is connected with the god by a genealogy hitherto unsuspected, or that he is even more closely related to him than his predecessors, inasmuch as Râ, having secretly descended upon the earth, had begotten him by a mortal mother in order to rejuvenate the

race.¹ If things came to the worst, a marriage with some princess would soon legitimise, if not the usurper himself, at least his descendants, and thus firmly re-establish the succession. The Pharaohs, therefore, are blood-relations of the Sun-god, some through their father, others through their mother, directly begotten by the God, and their souls as well as their bodies have a supernatural origin; each soul being a double detached from Horus, the successor of Osiris, and the first to reign alone over Egypt. This divine double is infused into the royal infant at birth, in the same manner

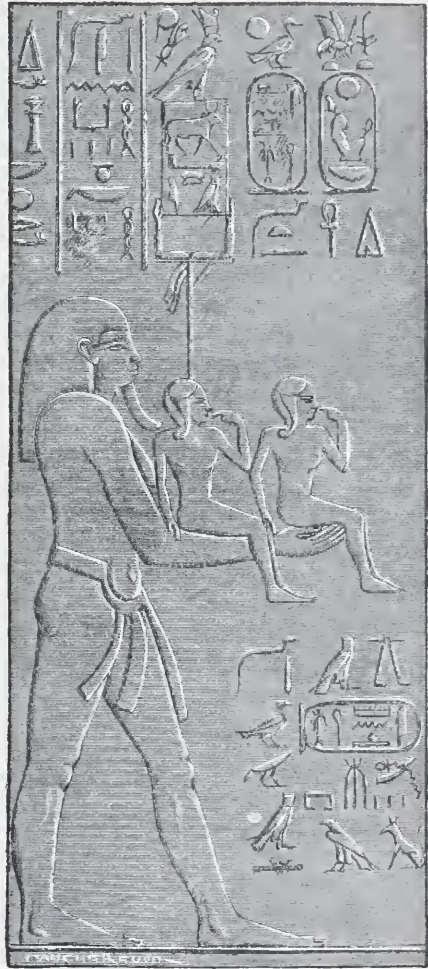









THE BIRTH OF A KING AND HIS DOUBLE.²

¹ A legend, preserved for us in the *Westcar Papyrus* (ERMAN'S edition, pl. ix. ll. 5-11, pl. x. l. 5, et seq.), maintains that the first three kings of the Vth dynasty, Ūsirkaf, Sahûri, and Kakiû, were children born to Râ, lord of Sakhîbû, by Rûditdidit, wife of a priest attached to the temple of that town.

² Drawn by Faucher-Gudin, from a photograph by Gayet. The king is Amenôthes III., whose conception and birth are represented in the temple of Luxor, with the same wealth of details that we should have expected, had he been a son of the god Amon and the goddess Mît.

as the ordinary double is incarnate in common mortals. It always remained concealed, and seemed to lie dormant in those princes whom destiny did not call upon to reign, but it awoke to full self-consciousness in those who ascended the throne at the moment of their accession. From that time to the hour of their death, and beyond it, all that they possessed of ordinary humanity was completely effaced; they were from henceforth only "the sons of Râ," the Horus, dwelling upon earth, who, during his sojourn here below, renews the blessings of Horus, son of Isis. Their complex nature was revealed at the outset in the form and arrangement of their names. Among the Egyptians the choice of a name was not a matter of indifference; not only did men and beasts, but even inanimate objects, require one or more names, and it may be said that no person or thing in the world could attain to complete existence until the name had been conferred. The most ancient names were often only a short word, which denoted some moral or physical quality, as Titi the Runner, Mini the Lasting, Qonqeni the Crusher, Sondi the Formidable, Uznasit the Flowery-tongued. They consisted also of short sentences, by which the royal child confessed his faith in the power of the gods, and his participation in the acts of the Sun's life—"Khâfrî," his rising is Râ; "Menkaûhorû," the doubles of Horus last for ever; "Ûsirkerî," the double of Râ is omnipotent. Sometimes the sentence is shortened, and the name of the god is understood: as for instance, "Ûsirkaî," HIS double is omnipotent; "Snofrûi," HE has made me good; "Khûfûi," HE has protected me, are put for the names "Ûsirkerî," "Ptahsnofrûi,"

“Khnûmkhûfûi,” with the suppression of Râ, Phtah, and Khnûmû. The name having once, as it were, taken possession of a man on his entrance into life, never leaves him either in this world or the next; the prince who had been called Ūnas or Assi at the moment of his birth, retained this name even after death, so long as his mummy existed, and his double was not annihilated.

When the Egyptians wished to denote that a person or thing was in a certain place, they inserted their names within the picture of the place in question. Thus the name of Teti is written inside a picture of Teti’s castle, the result being the compound hieroglyph . Again, when the son of a king became king in his turn, they enclose his ordinary name in the long flat-bottomed frame  which we call a cartouche; the elliptical part  of which is a kind of plan of the world, a representation of those regions passed over by Râ in his journey, and over which Pharaoh, because he is a son of Râ, exercises his rule. When the names of Teti or Snofrûi, following the group , “son of the Sun,” are placed in a cartouche, , , they are preceded by the words  which respectively express sovereignty over the two halves of Egypt, the South and the North, the whole expression describing exactly the visible person of Pharaoh during his abode among mortals. But this first name chosen for the child did not include the whole man; it left without appropriate designation the double of Horus, which was revealed in the prince at the moment of accession. The double therefore received a special title, which is always constructed on a uniform plan: first the picture  of the

hawk-god, who desired to leave to his descendants a portion of his soul, then a simple or compound epithet,



THE ADULT KING ADVANCING, FOLLOWED BY HIS DOUBLE.¹

¹ Drawn by Faucher-Gudin, from an illustration in ARUNDALE-BONOMI-BIRCH'S *Gallery of Antiquities from the British Museum*, pl. 31. The king thus represented is Thutmosis II. of the XVIIIth dynasty; the spear, surmounted by a man's head, which the double holds in his hand, probably recalls the human victims formerly sacrificed at the burial of a chief.

specifying that virtue of Horus which the Pharaoh wished particularly to possess—"Horû nîb-mâît," Horus master of Truth; "Horû miri-toûi," Horus friend of both lands; "Horû nîbkhâû," Horus master of the risings; "Horu mazîti," Horus who crushes his enemies. The variable part of these terms is usually written in an oblong rectangle, terminated at the lower end by a number of lines portraying in a summary way the façade of a monument, in the centre of which a bolted door may sometimes be distinguished: this is the representation of the chapel where the double will one day rest, and the closed door is the portal of the tomb.¹ The stereotyped part of the names and titles, which is represented by the figure of the god, is placed outside the rectangle, sometimes by the side of it, sometimes upon its top: the hawk is, in fact, free by nature, and could nowhere remain imprisoned against his will.





This artless preamble was not enough to satisfy the love of precision which is the essential characteristic of the Egyptians. When they wished to represent the double in his sepulchral chamber, they left out of consideration the period in his existence during which he had presided over the earthly destinies of the sovereign, in order to render them similar to those of Horus, from whom the double proceeded. They, therefore, withdrew

¹ This is what is usually known as the "Banner Name;" indeed, it was for some time believed that this sign represented a piece of stuff, ornamented at the bottom by embroidery or fringe, and bearing on the upper part the title of a king. Wilkinson thought that this "square title," as he called it, represented a house. The real meaning of the expression was determined by Professor Flinders Petrie and by myself.

him from the tomb which should have been his lot, and there was substituted for the ordinary sparrow-hawk one of those groups which symbolize sovereignty over the two countries of the Nile—the coiled uræus of the North,







THE KA, OR
"DOUBLE" NAME.¹

and the vulture of the South, ; there was then finally added a second sparrow-hawk, the golden sparrow-hawk, , the triumphant sparrow-hawk which had delivered Egypt from Typhon. The soul of Snofrûi, which is called, as a surviving double, , "Horus master of Truth," is, as a living double, entitled , "the Lord of the Vulture and of the Uræus," master of Truth, and Horus triumphant. On the other hand, the royal prince, when he put on the diadem, received, from the moment of his advancement to the highest rank, such an increase of dignity, that his birth-name—even when framed in a cartouche and enhanced with brilliant epithets—was no longer able to fully represent him. This exaltation of his person was therefore marked

by a new designation. As he was the living flesh of the sun, so his surname always makes allusion to some point in his relations with his father, and proclaims the love which he felt for the latter, "Mirirî," or that the latter experienced for him, "Mirnirî," or else it indicates the

¹ The *Ka*, or double name, represented in this illustration is that of the Pharaoh Khephren, the builder of the second of the great pyramids at Gizeh; it reads "Horu usir-Hâiti," Horus powerful of heart.

stability of the doubles of Râ, "Tatkerî," their goodness, "Nofirkerî," or some other of their sovereign virtues. Several Pharaohs of the IVth dynasty had already dignified themselves by these surnames; those of the VIth were the first to incorporate them regularly into the royal preamble. There was some hesitation at first as to the position the surname ought to occupy, and it was sometimes placed after the birth-name, as in , "Papi Nofirkerî," sometimes before it, as in , "Nofirkerî Papi." It was finally decided to place it at the beginning, preceded by the group  "King of Upper and Lower Egypt," which expresses in its fullest extent the power granted by the gods to the Pharaoh alone; the other, or birth-name, came after it, accompanied by the words  "Son of the Sun." There were inscribed, either before or above these two solar names—which are exclusively applied to the visible and living body of the master—the two names of the sparrow-hawk, which belonged especially to the soul; first, that of the double in the tomb, and then that of the double while still incarnate. Four terms seemed thus necessary to the Egyptians in order to define accurately the Pharaoh, both in time and in eternity.

Long centuries were needed before this subtle analysis of the royal person, and the learned graduation of the formulas which corresponded to it, could transform the Nome chief, become by conquest suzerain over all other chiefs and king of all Egypt, into a living god here below, the all-powerful son and successor of the gods; but the

divine concept of royalty, once implanted in the mind, quickly produced its inevitable consequences. From the moment that the Pharaoh became god upon earth, the



THE GODDESS ADOPTS THE KING BY SUCKLING HIM.²

gods of heaven, his fathers or his brothers, and the goddesses recognized him as their son, and, according to the ceremonial imposed by custom in such cases, consecrated his adoption by offering him the breast to suck, as they would have done to their own child. Ordinary mortals spoke of him only in symbolic words, designating him by some periphrasis: Pharaoh, "Pirûi-Âûi," the Double Palace, "Prûiti," the Sublime Porte, His Majesty,¹ the Sun of the two lands, Horus master of the palace, or, less ceremoniously, by the indeterminate pronoun "One." The greater number of these terms is always accompanied by a wish addressed to the sovereign for his "life," "health," and "strength," the initial signs of

¹ The title "Houûf" is translated by the same authors, sometimes as "His Majesty," sometimes as "His Holiness." The reasons for translating it "His Majesty," as was originally proposed by Champollion, and afterwards generally adopted, have been given last of all by E. de Rougé.

² Drawn by Boudier, from a photograph by Insinger. The original is in the great speos of Silsilis. The king here represented is Harmhabit of the XVIIIth dynasty; cf. CHAMPOLLION, *Monuments de l'Égypte et de la Nubie*, pl. cix., No. 3; ROSELLINI, *Monumenti Storici*, pl. xlv. 5; LEPSIUS, *Denkm.*, iii. 121 b.

which are written after all his titles. He accepts all this graciously, and even on his own initiative, swears by his own life, or by the favour of Râ, but he forbids his subjects to imitate him: for them it is a sin, punishable in this world and in the next, to adjure the person of the sovereign, except in the case in which a magistrate requires from them a judicial oath. He is approached, moreover, as a god is approached, with downcast eyes, and head or back bent; they “sniff the earth” before him, they veil their faces with both hands to shut out the splendour of his appearance; they chant a devout form of adoration before submitting to him a petition. No one is free from this obligation: his ministers themselves, and the great ones of his kingdom, cannot deliberate with him on matters of state, without inaugurating the proceeding by a sort of solemn service in his honour, and reciting to him at length a eulogy of his divinity. They did not, indeed, openly exalt him above the other gods, but these were rather too numerous to share heaven among them, whilst he alone rules over the “Entire



THE CUCUPHA-HEADED
SCEPTRE.¹

¹ Drawn by Faucher-Gudin, from the engraving in PRISSE D'AVENNES, *Recherches sur les légendes royales et l'époque du règne de Schai ou Scherai*, in the *Revue Archéologique*, 1st series, vol. ii. p. 467. The original is now preserved in the Bibliothèque Nationale, to which it was presented by Prisse d'Avannes. It is of glazed earthenware, of very delicate and careful workmanship.

Circuit of the Sun," and the whole earth, its mountains and plains, are in subjection under his sandalled feet. People, no doubt, might be met with who did not obey him, but these were rebels, adherents of Sit, "Children



DIFFERENT POSTURES FOR APPROACHING THE KING.¹

of Ruin," who, sooner or later, would be overtaken by punishment. While hoping that his fictitious claim to universal dominion would be realized, the king adopted, in addition to the simple costume of the old chiefs, the

¹ Drawn by Faucher-Gudin, from a photograph by Insinger. The picture represents Khâmhait presenting the superintendents of storehouses to Tûtânkhamon, of the XVIIIth dynasty.

long or short petticoat, the jackal's tail, the turned-up sandals, and the insignia of the supreme gods,—the ankh, the crook, the flail, and the sceptre tipped with the head of a jerboa or a hare, which we misname the cucupha-headed sceptre.¹ He put on the many-coloured diadems of the gods, the head-dresses covered with feathers, the white and the red crowns either separately or combined so as to form the pshent. The viper or uræus, in metal or gilded wood, which rose from his forehead, was imbued with a mysterious life, which made it a means of executing his vengeance and accomplishing his secret purposes. It was supposed to vomit flames and to destroy those who should dare to attack its master in battle. The supernatural virtues which it communicated to the crown, made it an enchanted thing which no one could resist. Lastly, Pharaoh had his temples where his enthroned statue, animated by one of his doubles, received worship, prophesied, and fulfilled all the functions of a Divine Being, both during his life, and after he had rejoined in the tomb his ancestors the gods, who existed before him and who now reposed impassively within the depths of their pyramids.²

¹ This identification, suggested by Champollion, is, from force of custom, still adhered to, in nearly all works on Egyptology. But we know from ancient evidence that the cucupha was a bird, perhaps a hoopoe; the sceptre of the gods, moreover, is really surmounted by the head of a quadruped having a pointed snout and long retreating ears, and belonging to the greyhound, jackal, or jerboa species.

² This method of distinguishing deceased kings is met with as far back as the "Song of the Harpist," which the Egyptians of the Ramesside period attributed to the founder of the XIth dynasty. The first known instance of a temple raised by an Egyptian king to his double is that of Amenôthes III.

Man, as far as his body was concerned, and god in virtue of his soul and its attributes, the Pharaoh, in right of this double nature, acted as a constant mediator between heaven and earth. He alone was fit to transmit the prayers of men to his fathers and his brethren the gods. Just as the head of a family was in his household the priest *par excellence* of the gods of that family,—just as the chief of a nome was in his nome the priest *par excellence* in regard to the gods of the nome,—so was Pharaoh the priest *par excellence* of the gods of all Egypt, who were his special deities. He accompanied their images in solemn processions; he poured out before them the wine and mystic milk, recited the formulas in their hearing, seized the bull who was the victim with a lasso and slaughtered it according to the rite consecrated by ancient tradition. Private individuals had recourse to his intercession, when they asked some favour from on high; as, however, it was impossible for every sacrifice to pass actually through his hands, the celebrating priest proclaimed at the beginning of each ceremony that it was the king who made the offering—*Sútni ði hotpú*—he and none other, to Osiris, Phtah, and Râ-Harmakhis, so that they might grant to the faithful who implored them the

at Soleb, in Nubia, but I do not agree with Prof. Ed. Meyer, or with Prof. Erman, who imagine that this was the first instance of the practice, and that it had been introduced into Nubia before its adoption on Egyptian soil. Under the Ancient Empire we meet with more than one functionary who styles himself, in some cases during his master's lifetime, in others shortly after his death, "Prophet of Horus who lives in the palace," or "Prophet of Kheops," "Prophet of Sondi," "Prophet of Kheops, of Mykerinos, of Úsirkaf," or of other sovereigns.

object of their desires, and, the declaration being accepted in lieu of the act, the king was thus regarded as really officiating on every occasion for his subjects. He thus maintained daily intercourse with the gods, and they, on their part, did not neglect any occasion of communicating with him. They appeared to him in dreams to foretell his future, to command him to restore a monument which was threatened with ruin, to advise him to set out to war, to forbid him risking his life in the thick of the fight.¹ Communication by prophetic dreams was not, however, the method usually selected by the gods: they employed as interpreters of their wishes the priests and the statues in the temples. The king entered the chapel where the statue was kept, and performed in its presence the invocatory rites, and questioned it upon the subject which occupied his mind. The priest replied under direct inspiration from on high, and the dialogue thus entered upon might last a long time. Interminable discourses, whose records cover the walls of the Theban temples, inform us what the Pharaoh said on such occasions, and in what emphatic tones the gods replied. Sometimes the animated statues raised their voices in the darkness of the sanctuary and themselves announced their will; more frequently they were content to indicate it by a

¹ Among other examples, the texts mention the dream in which Thûtmosis IV., while still a royal prince, received from Phrà-Harmakhis orders to unearth the Great Sphinx, the dream in which Phtah forbids Minephtah to take part in the battle against the peoples of the sea, that by which Tonúatamon, King of Napata, is persuaded to undertake the conquest of Egypt. Herodotus had already made us familiar with the dreams of Sabaco and of the high priest Sethos.

gesture. When they were consulted on some particular subject and returned no sign, it was their way of signifying their disapprobation. If, on the other hand, they significantly bowed their head, once or twice, the subject was an acceptable one, and they approved it. No state affair was settled without asking their advice, and without their giving it in one way or another.

The monuments, which throw full light on the supernatural character of the Pharaohs in general, tell us but little of the individual disposition of any king in particular, or of their everyday life. When by chance we come into closer intimacy for a moment with the sovereign, he is revealed to us as being less divine and majestic than we might have been led to believe, had we judged him only by his impassive expression and by the pomp with which he was surrounded in public. Not that he ever quite laid aside his grandeur; even in his home life, in his chamber or his garden, during those hours when he felt himself withdrawn from public gaze, those highest in rank might never forget when they approached him that he was a god. He showed himself to be a kind father, a good-natured husband,¹ ready to dally with his wives and caress them on the cheek as they offered him a flower, or moved a piece upon the draught-board. He took an interest in those who waited on him, allowed them certain breaches of etiquette when he

¹ As a literary example of what the conduct of a king was like in his family circle, we may quote the description of King Minibphtah, in the story of Satni-Khâmois. The pictures of the tombs at Tel-el-Amarna show us the intimate terms on which King Khûniaton lived with his wife and daughters, both big and little.

was pleased with them, and was indulgent to their little failings. If they had just returned from foreign lands, a little countrified after a lengthy exile from the court, he would break out into pleasantries over their embarrassment and their unfashionable costume,—kingly pleasantries which excited the forced mirth of the bystanders, but which soon fell flat and had no meaning for those outside the palace. The Pharaoh was fond of laughing and drinking; indeed, if we may believe evil tongues, he took so much at times as to incapacitate him for business. The chase was not always a pleasure to him, hunting in the desert, at least, where the lions evinced a provoking tendency to show as little respect for the divinity of the prince as for his mortal subjects; but, like the chiefs of old, he felt it a duty to his people to destroy wild beasts, and he ended by counting the slain in hundreds, however short his reign might be.¹ A considerable part of his time was taken up in war—in the east, against the Libyans in the regions of the Oasis; in the Nile Valley to the south of Aswân against the Nubians; on the Isthmus of Suez and in the Sinaitic Peninsula against the Bedouin; frequently also in a civil war against some ambitious noble or some turbulent member of his own family. He travelled frequently from south to north, and from north to south, leaving in every possible place marked traces of his visits—on the rocks of Elephantinê and of the first cataract, on those of Silsilis or of El-Kab, and he appeared to his vassals as Tûmû himself arisen among them

¹ Amenôthes III. had killed as many as a hundred and two lions during the first ten years of his reign.

to repress injustice and disorder. He restored or enlarged the monuments, regulated equitably the assessment of taxes and charges, settled or dismissed the lawsuits between one town and another concerning the appropriation of the water, or the possession of certain territories, distributed fiefs which had fallen vacant, among his faithful servants, and granted pensions to be paid out of the royal revenues.¹ At length he re-entered Memphis, or one of his usual residences, where fresh labours awaited him. He gave audience daily to all, whether high or low, who were, or believed that they were, wronged by some official, and who came to appeal to the justice of the master against the injustice of his servant. If he quitted the palace when the cause had been heard, to take boat or to go to the temple, he was not left undisturbed, but petitions and supplications assailed him by the way. In addition to this, there were the daily sacrifices, the despatch of current affairs, the ceremonies which demanded the presence of the Pharaoh, and the reception of nobles or foreign envoys. One would think that in the midst of so many occupations he would never feel time hang heavy on his hands. He was, however, a prey to that profound *ennui* which most Oriental monarchs feel so keenly, and which neither the cares nor the pleasures of ordinary life could dispel. Like the Sultans of the "Arabian Nights," the Pharaohs were

¹ These details are not found on the historical monuments, but are furnished to us by the description given in "The Book of Knowledge of what there is in the other world" of the course of the sun across the domain of the hours of night; the god is there described as a Pharaoh passing through his kingdom, and all that he does for his vassals, the dead, is identical with what Pharaoh was accustomed to do for his subjects, the living.

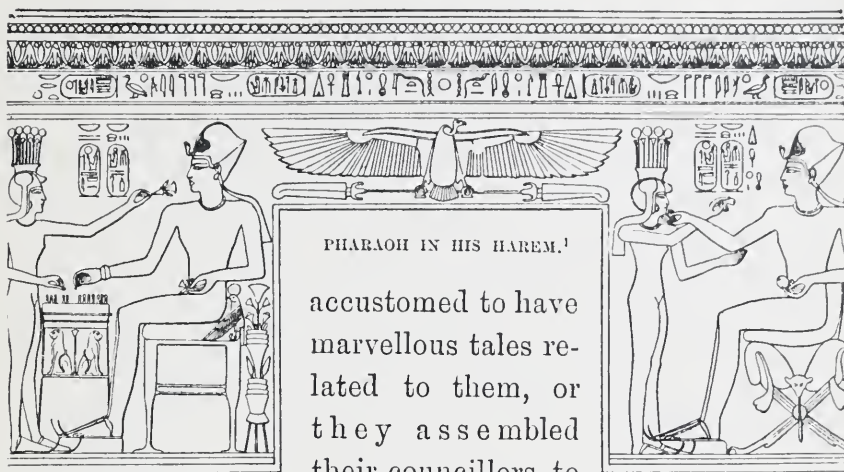

ask them to suggest some fresh amusement: a happy thought would sometimes strike one of them, as in the case of him who aroused the interest of Snofruï by recommending him to have his boat manned by young girls barely clad in large-meshed network. All his pastimes were not so playful. The Egyptians by nature were not cruel, and we have very few records either in history or tradition of bloodthirsty Pharaohs; but the life of an ordinary individual was of so little value in their eyes, that they never hesitated to sacrifice it, even for a caprice. A sorcerer had no sooner boasted before Kheops of being able to raise the dead, than the king proposed that he should try the experiment on a prisoner whose head was to be forthwith cut off. The anger of Pharaoh was quickly excited, and once aroused, became an all-consuming fire; the Egyptians were wont to say, in describing its intensity, "His Majesty became as furious as a

¹ Drawn by Faucher-Gudin.

panther." The wild beast often revealed itself in the half-civilized man.

The royal family was very numerous. The women were principally chosen from the relatives of court officials of high rank, or from the daughters of the great feudal lords; there were, however, many strangers among them, daughters or sisters of petty Libyan, Nubian, or Asiatic kings; they were brought into Pharaoh's house as hostages for the submission of their respective peoples. They did not all enjoy the same treatment or consideration, and their original position decided their status in the harem, unless the amorous caprice of their master should otherwise decide. Most of them remained merely concubines for life, others were raised to the rank of "royal spouses," and at least one received the title and privileges of "great spouse," or queen. This was rarely accorded to a stranger, but almost always to a princess born in the purple, a daughter of Râ, if possible a sister of the Pharaoh, and who, inheriting in the same degree and in equal proportion the flesh and blood of the Sun-god, had, more than others, the right to share the bed and throne of her brother.¹ She had her own house, and a train of servants and followers as large as those of the king; while the women of inferior rank were more or less shut up in the parts of the palace assigned to them, she came and went at pleasure, and appeared in public with or without her husband. The preamble of official documents in which she is mentioned, solemnly recognizes her as the living follower of Horus, the

¹ It would seem that Queen Mirisônkhû, wife of Khephren, was the daughter of Kheops, and consequently her husband's sister.

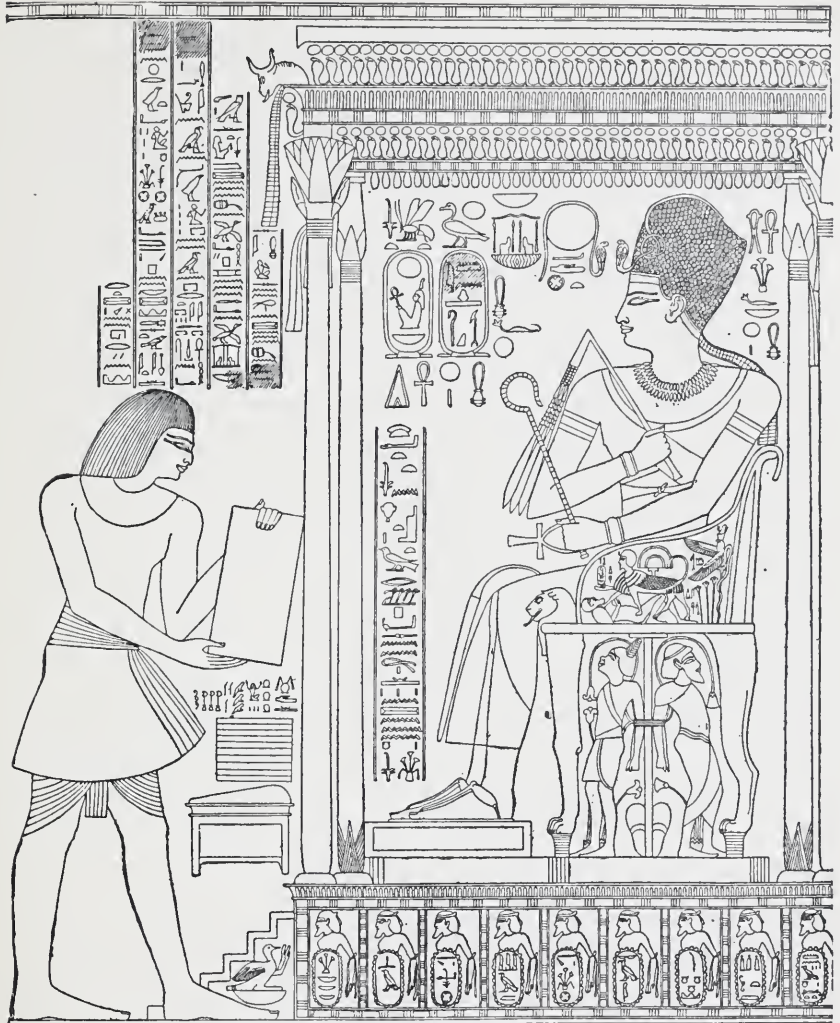

PHARAOH GIVES SOLEMN AUDIENCE TO ONE OF HIS MINISTERS.¹

associate of the Lord of the Vulture and the Uræus, the very gentle, the very praiseworthy, she who sees her Horus,

¹ Drawn by Faucher-Gudin, after LEPSIUS. The king is Amenôthes III. (XVIIIth dynasty).

or Horus and Sît, face to face. Her union with the god-king rendered her a goddess, and entailed upon her the fulfilment of all the duties which a goddess owed to a god. They were varied and important. The woman, indeed, was supposed to combine in herself more completely than a man the qualities necessary for the exercise of magic, whether legitimate or otherwise: she saw and heard that which the eyes and ears of man could not perceive; her voice, being more flexible and piercing, was heard at greater distances; she was by nature mistress of the art of summoning or banishing invisible beings. While Pharaoh was engaged in sacrificing, the queen, by her incantations, protected him from malignant deities, whose interest it was to divert the attention of the celebrant from holy things: she put them to flight by the sound of prayer and sistrum, she poured libations and offered perfumes and flowers. In processions she walked behind her husband, gave audience with him, governed for him while he was engaged in foreign wars, or during his progresses through his kingdom: such was the work of Isis while her brother Osiris was conquering the world. Widowhood did not always entirely disqualify her. If she belonged to the solar race, and the new sovereign was a minor, she acted as regent by hereditary right, and retained the authority for some years longer.¹ It occasionally happened that she had no posterity, or that the child of another woman inherited the crown.

¹ The best-known of these queen regencies is that which occurred during the minority of Thâtmosis III., about the middle of the XVIIIth dynasty. Queen Tâû also appears to have acted as regent for her son Ramses II. during his first Syrian campaigns.

In that case there was no law or custom to prevent a young and beautiful widow from wedding the son, and thus regaining her rank as Queen by a marriage with the successor of her deceased husband. It was in this manner that, during the earlier part of the IVth dynasty, the Princess Mirtitfeſi ingratiated herself ſucceſſively in the favour of Snofrûi and Kheops.¹ Such a caſe did not often ariſe, and a queen who had once quitted the throne had but little chance of again aſcending it. Her titles, her duties, her ſupremacy over the reſt of the family, paſſed to a younger rival: formerly ſhe had been the active companion of the king, ſhe now became only the nominal ſpouſe of the god,² and her office came to an end when the god, of whom ſhe had been the goddeſs, quitting his body, departed heavenward to rejoin his father the Sun on the far-diſtant horizon.

Children ſwarmed in the palace, as in the houſes of private individuals: in ſpite of the number who died in infancy, they were reckoned by tens, ſometimes by the hundred, and more than one Pharaoh muſt have been puzzled to remember exactly the number and names of his offspring.³

¹ M. de Rougé was the firſt to bring this fact to light in his *Recherches ſur les monuments qu'on peut attribuer aux ſix premières dynaſties de Manéthon*, pp. 36-38. Mirtitfeſi alſo lived in the harem of Khephren, but the title which connects her with this king—*Amakhit*, the vaſſal—proves that ſhe was then merely a nominal wife; ſhe was probably by that time, as M. de Rougé ſays, of too advanced an age to remain the favourite of a third Pharaoh.

² The title of “divine ſpouſe” is not, ſo far as we know at preſent, met with prior to the XVIIIth dynasty. It was given to the wife of a living monarch, and was retained by her after his death; the divinity to whom it referred was no other than the king himſelf.

³ This was probably ſo in the caſe of the Pharaoh Ramſes II., more than

The origin and rank of their mothers greatly influenced the condition of the children. No doubt the divine blood which they took from a common father raised them all above the vulgar herd but those connected with the solar



THE QUEEN SHAKES THE SISTRUM WHILE THE KING OFFERS THE SACRIFICE.¹

line on the maternal side occupied a decidedly much higher position than the rest: as long as one of these was living,

one hundred and fifty of whose children, boys and girls, are known to us, and who certainly had others besides of whom we know nothing.

¹ Drawn by Faucher-Gudin, from a bas-relief in the temple of Ibsambûl: Nofritari shakes behind Ramses II. two sistra, on which are representations of the head of Hâthor.

none of his less nobly-born brothers might aspire to the crown.¹ Those princesses who did not attain to the rank of queen by marriage, were given in early youth to some well-to-do relative, or to some courtier of high descent whom Pharaoh wished to honour; they filled the office of priestesses to the goddesses Nît or Hâthor, and bore in their households titles which they transmitted to their children, with such rights to the crown as belonged to them. The most favoured of the princes married an heiress rich in fiefs, settled on her domain, and founded a race of feudal lords. Most of the royal sons remained at court, at first in their father's service and subsequently in that of their brothers' or nephews': the most difficult and best remunerated functions of the administration were assigned to them, the superintendence of public works, the important offices of the priesthood, the command of the army. It could have been no easy matter to manage without friction this multitude of relations and connections, past and present queens, sisters, concubines, uncles, brothers, cousins, nephews, sons and grandsons of kings who crowded the harem and the palace. The women contended among themselves for the affection of the master, on behalf of themselves or their children. The children were jealous of one another, and had often no bond of union except a common hatred for the son whom the chances of birth had destined to be their ruler. As long as he was full of vigour

¹ Proof of this fact is furnished us, in so far as the XVIIIth dynasty is concerned, by the history of the immediate successors of Thûtmosis I., the Pharaohs Thûtmosis II., Thûtmosis III., Queen Hâtshopsitû, Queen Mûtnofrit, and Isis, concubine of Thûtmosis II. and mother of Thûtmosis III.

and energy, Pharaoh maintained order in his family ; but when his advancing years and failing strength betokened an approaching change in the succession, competition showed itself more openly, and intrigue thickened around him or around his nearest heirs. Sometimes, indeed, he took precautions to prevent an outbreak and its disastrous consequences, by solemnly associating with himself in the royal power the son he had chosen to succeed him : Egypt in this case had to obey two masters, the younger of whom attended to the more active duties of royalty, such as progresses through the country, the conducting of military expeditions, the hunting of wild beasts, and the administration of justice ; while the other preferred to confine himself to the *rôle* of adviser or benevolent counsellor. Even this precaution, however, was insufficient to prevent disasters. The women of the seraglio, encouraged from without by their relations or friends, plotted secretly for the removal of the irksome sovereign.¹ Those princes who had been deprived by their father's decision of any legitimate hope of reigning, concealed their discontent to no purpose ; they were arrested on the first suspicion of disloyalty, and were massacred wholesale ; their only chance of escaping summary execution was either by rebellion² or by taking refuge

¹ The passage of the Ûni inscription, in which mention is made of a lawsuit carried on against Queen Amîtsi, probably refers to some harem conspiracy. The celebrated lawsuit, some details of which are preserved for us in a papyrus of Turin, gives us some information in regard to a conspiracy which was hatched in the harem against Ramses II.

² A passage in the "Instructions of Amenemhât" describes in somewhat obscure terms an attack on the palace by conspirators, and the wars which followed their undertaking.

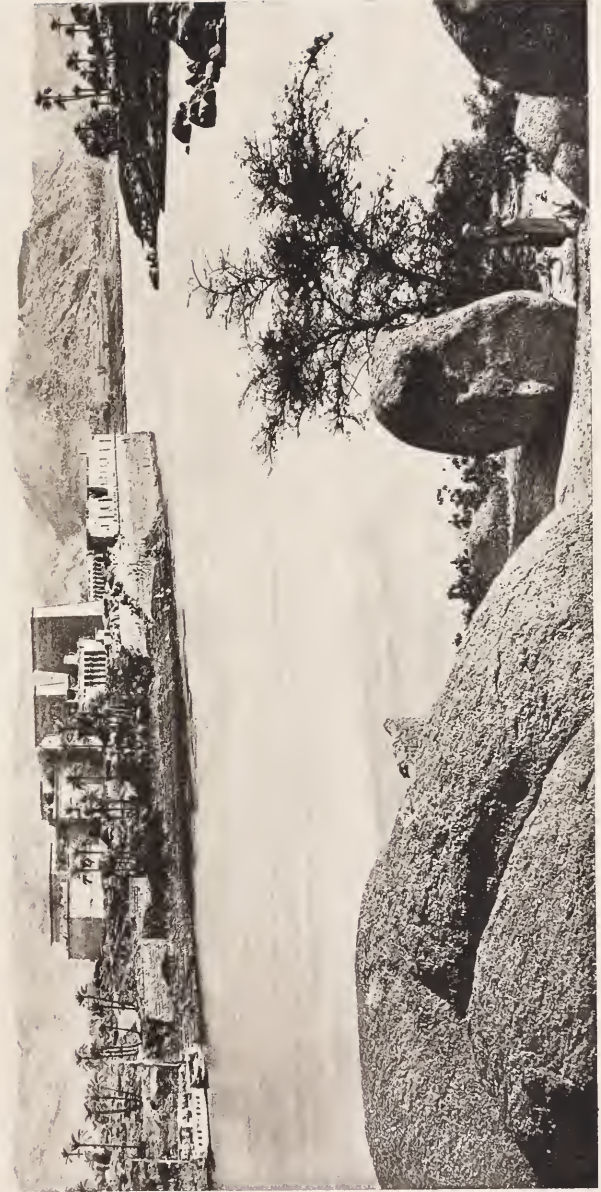

with some independent tribe of Libya or of the desert of Sinai. Did we but know the details of the internal history of Egypt, it would appear to us as stormy and as bloody as that of other Oriental empires: intrigues of the harem, conspiracies in the palace, murders of heirs-apparent, divisions and rebellions in the royal family, were the almost inevitable accompaniment of every accession to the Egyptian throne.

The earliest dynasties had their origin in the "White Wall," but the Pharaohs hardly ever made this town their residence, and it would be incorrect to say that they considered it as their capital; each king chose for himself in the Memphite or Letopolite nome, between the entrance to the Fayûm and the apex of the Delta, a special residence, where he dwelt with his court, and from whence he governed Egypt. Such a multitude as formed his court needed not an ordinary palace, but an entire city. A brick wall, surmounted by battlements, formed a square or rectangular enclosure around it, and was of sufficient thickness and height not only to defy a popular insurrection or the surprises of marauding Bedouin, but to resist for a long time a regular siege. At the extreme end of one of its façades, was a single tall and narrow opening, closed by a wooden door supported on bronze hinges, and surmounted with a row of pointed metal ornaments; this opened into a long narrow passage between the external wall and a partition wall of equal strength; at the end of the passage in the angle was a second door, sometimes leading into a second passage, but more often opening into a large courtyard, where the dwelling-houses were somewhat crowded

together: assailants ran the risk of being annihilated in the passage before reaching the centre of the place.¹ The royal residence could be immediately distinguished by the projecting balconies on its façade, from which, as from a tribune, Pharaoh could watch the evolutions of his guard, the stately approach of foreign envoys, Egyptian nobles seeking audience, or such officials as he desired to reward for their services. They advanced from the far end of the court, stopped before the balcony, and after prostrating themselves stood up, bowed their heads, wrung and twisted their hands, now quickly, now slowly, in a rhythmical manner, and rendered worship to their master, chanting his praises, before receiving the necklaces and jewels of gold which he presented to them by his chamberlains, or which he himself deigned to fling to them.² It is difficult for us to catch a glimpse of the detail of the internal arrangements: we find, however, mention made of large halls "resembling the hall of Atûmû in the heavens," whither the king repaired to deal with state affairs in council, to dispense justice and sometimes also to preside at state banquets. Long rows of tall columns, carved out of

¹ No plan or exact drawing of any of the palaces of the Ancient Empire has come down to us, but, as Erman has very justly pointed out, the signs found in contemporary inscriptions give us a good general idea of them. The doors which lead from one of the hours of the night to another, in the "Book of the Other World," show us the double passage leading to the courtyard. The hieroglyph  gives us the name Ūôsknîr (literally, *the broad* [place]) of the courtyard on to which the passage opened, at the end of which the palace and royal judgment-seat (or, in the other world, the tribunal of Osiris, the *court* of the double truth) were situated.

² The ceremonial of these receptions is not represented on any monuments with which we are at present acquainted, prior to the XVIIIth dynasty.

rare woods and painted with bright colours, supported the roofs of these chambers, which were entered by doors inlaid with gold and silver, and incrustated with malachite or lapis-lazuli.¹ The private apartments, the "âkhonûiti," were entirely separate, but they communicated with the queen's dwelling and with the harem of the wives of inferior rank. The "royal children" occupied a quarter to themselves, under the care of their tutors; they had their own houses and a train of servants proportionate to their rank, age, and the fortune of their mother's family. The nobles who had appointments at court and the royal domestics lived in the palace itself, but the offices of the different functionaries, the storehouses for their provisions, the dwellings of their *employés*, formed distinct quarters outside the palace, grouped around narrow courts, and communicating with each other by a labyrinth of lanes or covered passages. The entire building was constructed of wood or bricks, less frequently of roughly dressed stone, badly built, and wanting in solidity. The ancient Pharaohs were no more inclined than the Sultans of later days to occupy palaces in

¹ This is the description of the palace of Amon built by Ramses III. Ramses II. was seated in one of these halls, on a throne of gold, when he deliberated with his councillors in regard to the construction of a cistern in the desert for the miners who were going to the gold-mines of Akiti. The room in which the king stopped, after leaving his apartments, for the purpose of putting on his ceremonial dress and receiving the homage of his ministers, appears to me to have been called during the Ancient Empire "Pi-dait"—"The House of Adoration," the house in which the king was worshipped, as in temples of the Ptolemaic epoch, was that in which the statue of the god, on leaving the sanctuary, was dressed and worshipped by the faithful. Sinûhit, under the XIIth dynasty, was granted an audience in the "Hall of Electrum."

which their predecessors had lived and died. Each king desired to possess a habitation after his own heart, one which would not be haunted by the memory, or perchance the double, of another sovereign. These royal mansions, hastily erected, hastily filled with occupants, were vacated and fell into ruin with no less rapidity: they grew old with their master, or even more rapidly than he, and his disappearance almost always entailed their ruin. In the neighbourhood of Memphis many of these palaces might be seen, which their short-lived masters had built for eternity, an eternity which did not last longer than the lives of their builders.¹

Nothing could present a greater variety than the population of these ephemeral cities in the climax of their splendour. We have first the people who immediately surrounded the Pharaoh,² the retainers of the palace and of the harem, whose highly complex degrees of rank are revealed to us on the monuments.³ His

¹ The song of the harp-player on the tomb of King Antûf contains an allusion to these ruined palaces: "The gods [kings] who were of yore, and who repose in their tombs, mummies and *manes*, all buried alike in their pyramids, when castles are built they no longer have a place in them; see, thus it is done with them! I have heard the poems in praise of Imhotpû and of Hardidif which are sung in the songs, and yet, see, where are their places to-day? their walls are destroyed, their places no more, as though they have never existed!"

² They are designated by the general terms of Shonitiû, the "people of the circle," and Qoubitiû, the "people of the corner." These words are found in religious inscriptions referring to the staff of the temples, and denote the attendants or court of each god; they are used to distinguish the notables of a town or borough, the sheikhs, who enjoyed the right to superintend local administration and dispense justice.

³ The Egyptian scribes had endeavoured to draw up an hierarchical list of

person was, as it were, minutely subdivided into departments, each requiring its attendants and their appointed chiefs. His toilet alone gave employment to a score of different trades. There were royal barbers, who had the privilege of shaving his head and chin; hairdressers who made, curled, and put on his black or blue wigs and adjusted the diadems to them; there were manicurists who pared and polished his nails, perfumers who prepared the scented oils and pomades for the anointing of his body, the kohl for blackening his eyelids, the *rouge* for spreading on his lips and cheeks. His wardrobe required a whole troop of shoemakers, belt-makers, and tailors, some of whom had the care of stuffs in the piece, others presided over the body-linen, while others took charge of his garments, comprising long or short, transparent or thick petticoats, fitting tightly to the hips or cut with ample fulness, draped mantles and flowing pelisses. Side by side with these officials, the laundresses plied their trade, which was an important one among a people devoted to white, and in whose estimation want of cleanliness in dress entailed religious impurity. Like the fellahîn of the present time, they took their linen

these offices. At present we possess the remains of two lists of this description. One of these, preserved in the "Hood Papyrus" in the British Museum, has been published and translated by MASPERO, in *Études Égyptiennes*, vol. ii. pp. 1-66; another and more complete copy, discovered in 1890, is in the possession of M. Golénischeff. The other list, also in the British Museum, was published by Prof. Petrie in a memoir of *The Egypt Exploration Fund*; in this latter the names and titles are intermingled with various other matter. To these two works may be added the lists of professions and trades to be found *passim* on the monuments, and which have been commented on by BRUGSCH.

daily to wash in the river; they rinsed, starched, smoothed, and pleated it without intermission to supply the incessant demands of Pharaoh and his family.¹ The task of those set over the jewels was no easy one, when we consider the enormous variety of necklaces, bracelets, rings, earrings, and sceptres of rich workmanship which ceremonial costume required for particular times and occasions. The guardianship of the crowns almost approached to the dignity of the priesthood; for was not the uræus, which ornamented each one, a living goddess? The queen required numerous waiting-women, and the same ample number of attendants were to be encountered in the establishments of the other ladies of the harem. Troops of musicians, singers, dancers, and *almehs* whiled away the tedious hours, supplemented by buffoons and dwarfs. The great Egyptian lords evinced a curious liking for these unfortunate beings, and amused themselves by getting together the ugliest and most deformed creatures. They are often represented on the tombs beside their masters in company with his pet dog, or a gazelle, or with a monkey which they sometimes hold in leash, or sometimes are engaged in teasing. Sometimes the Pharaoh bestowed his friendship on his dwarfs, and confided to them occupations in his household. One of them, Khnûmhotpû, died superintendent of the royal linen. The staff of servants required for supplying the table exceeded all the others in number. It

¹ The "royal laundrymen" and their chiefs are mentioned in the *Conte des deux frères* under the XIXth dynasty, as well as their laundries on the banks of the Nile.

could scarcely be otherwise if we consider that the master had to provide food, not only for his regular servants,¹

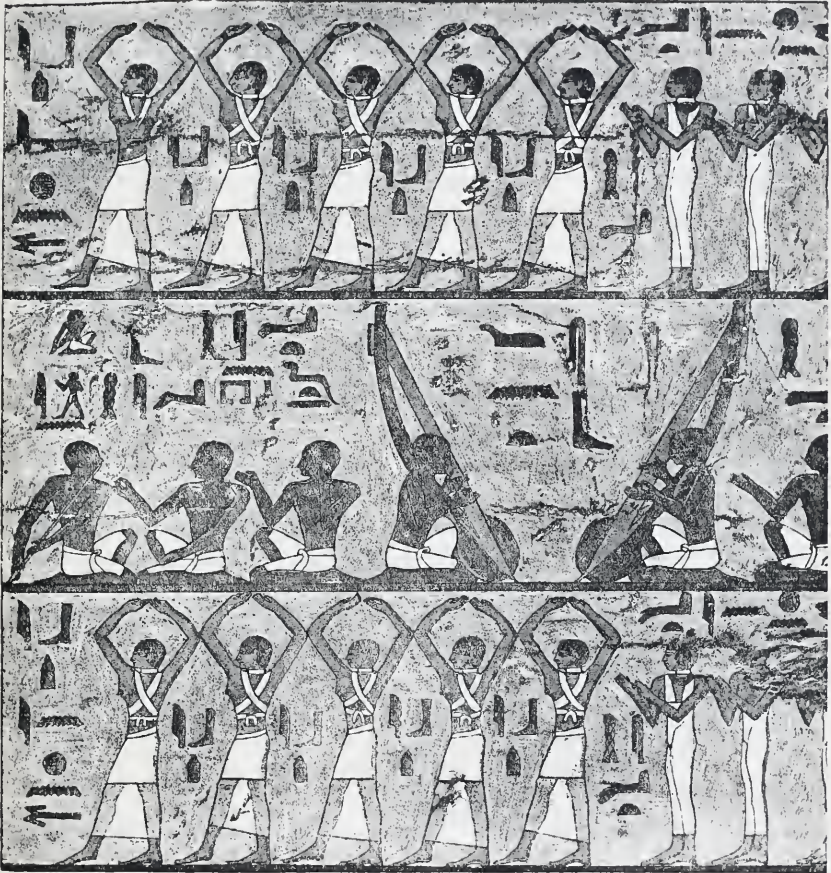

MEN AND WOMEN SINGERS, FLUTE-PLAYERS, HARPISTS, AND DANCERS, FROM THE TOMB OF TI.²

but for all those of his *employés* and subjects whose business

¹ Even after death they remained inscribed on the registers of the palace, and had rations served out to them every day as funerary offerings.

² Drawn by Faucher-Gudin, from a squeeze taken at Saqqâra in 1878 by Mariette.

brought them to the royal residence: even those poor wretches who came to complain to him of some more or less imaginary grievance were fed at his expense while awaiting his judicial verdict. Head-cooks, butlers, pantlers, pastrycooks, fishmongers, game or fruit dealers

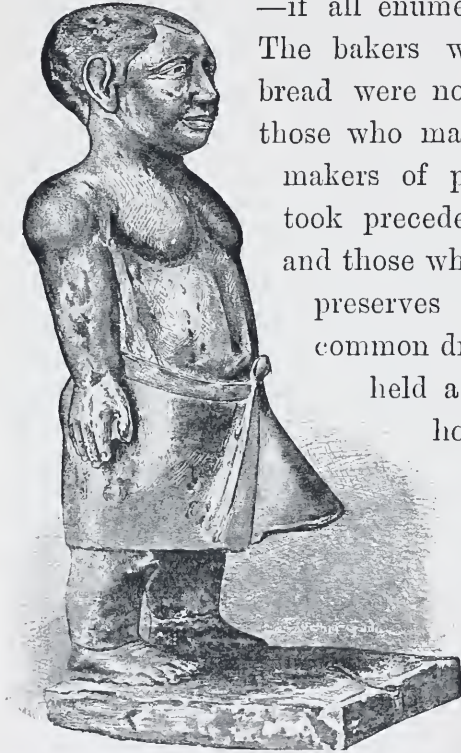

THE DWARF KHINŪMHOTPŪ, SUPERINTENDENT OF THE ROYAL LINES.¹

—if all enumerated, would be endless. The bakers who baked the ordinary bread were not to be confounded with those who manufactured biscuits. The makers of pancakes and dough-nuts took precedence of the cake-bakers, and those who concocted delicate fruit preserves ranked higher than the common dryer of dates. If one had

held a post in the royal household, however low the occupation, it was something to be proud of all one's life, and after death to boast of in one's epitaph.

The chiefs to whom this army of servants rendered obedience at times rose from the ranks; on some occasion their

master had noticed them in the crowd, and had transferred them, some by a single promotion, others by slow degrees,

¹ Drawn by Faucher-Gudin, from a photograph by Émil Brugsch-Bey; the original is at Gizeh.

to the highest offices of the state. Many among them, however, belonged to old families, and held positions in the palace which their fathers and grandfathers had occupied before them, some were members of the provincial nobility, distant descendants of former royal princes and princesses, more or less nearly related to the reigning sovereign.¹ They had been sought out to be the companions of his education and of his pastimes, while he was still living an obscure life in the "House of the Children;" he had grown up with them and had kept them about his person as his "sole friends" and counsellors. He lavished titles and offices upon them by the dozen, according to the confidence he felt in their capacity or to the amount of faithfulness with which he credited them. A few of the most favoured were called "Masters of the Secret of the Royal House;" they knew all the innermost recesses of the palace, all the passwords needed in going from one part of it to another, the place where the royal treasures were kept, and the modes of access to it. Several of them were "Masters of the Secret of all the Royal Words," and had authority over the high courtiers of the palace, which gave them the

¹ It was the former who, I believe, formed the class of *rokhu sūton* so often mentioned on the monuments. This title is generally supposed to have been a mark of relationship with the royal family. M. de Rougé proved long ago that this was not so, and that functionaries might bear this title even though they were not blood relations of the Pharaohs. It seems to me to have been used to indicate a class of courtiers whom the king condescended to "know" (*rokhā*) directly, without the intermediary of a chamberlain, the "persons known by the king;" the others were only his "friends" (*samirū*).

power of banishing whom they pleased from the person of the sovereign. Upon others devolved the task of arranging his amusements; they rejoiced the heart of his Majesty by pleasant songs, while the chiefs of the sailors and soldiers kept watch over his safety. To these active services were attached honorary privileges which were highly esteemed, such as the right to retain their sandals in the palace, while the general crowd of courtiers could only enter unshod; that of kissing the knees and not the feet of the "good god," and that of wearing the panther's skin. Among those who enjoyed these distinctions were the physicians of the king, chaplains, and men of the roll—"khri-habi." The latter did not confine themselves to the task of guiding Pharaoh through the intricacies of ritual, nor to that of prompting him with the necessary formulæ needed to make the sacrifice efficacious; they were styled "Masters of the Secrets of Heaven," those who see what is in the firmament, on the earth and in Hades, those who know all the charms of the soothsayers, prophets, or magicians. The laws relating to the government of the seasons and the stars presented no mysteries to them, neither were they ignorant of the months, days, or hours propitious to the undertakings of everyday life or the starting out on an expedition, nor of those times during which any action was dangerous. They drew their inspirations from the books of magic written by Thot, which taught them the art of interpreting dreams or of curing the sick, or of invoking and obliging the gods to assist them, and of arresting or hastening the progress of the sun on the celestial ocean. Some

are mentioned as being able to divide the waters at their will, and to cause them to return to their natural place, merely by means of a short formula. An image of a man or animal made by them out of enchanted wax, was imbued with life at their command, and became an irresistible instrument of their wrath. Popular stories reveal them to us at work. "Is it true," said Kheops to one of them, "that thou canst replace a head which has been cut off?" On his admitting that he could do so, Pharaoh immediately desired to test his power. "Bring me a prisoner from prison and let him be slain." The magician, at this proposal, exclaimed: "Nay, nay, not a man, sire my master; do not command that this sin should be committed; a fine animal will suffice!" A goose was brought, "its head was cut off and the body was placed on the right side, and the head of the goose on the left side of the hall: he recited what he recited from his book of magic, the goose began to hop forward, the head moved on to it, and, when both were united, the goose began to cackle. A pelican was produced, and underwent the same process. His Majesty then caused a bull to be brought forward, and its head was smitten to the ground: the magician recited what he recited from his book of magic, the bull at once arose, and he replaced on it what had fallen to the earth." The great lords themselves deigned to become initiated into the occult sciences, and were invested with these formidable powers. A prince who practised magic would enjoy amongst us nowadays but small esteem: in Egypt sorcery was not considered incompatible with royalty,

and the magicians of Pharaoh often took Pharaoh himself as their pupil.¹

Such were the king's household, the people about his person, and those attached to the service of his family. His capital sheltered a still greater number of officials and functionaries who were charged with the administration of his fortune—that is to say, what he possessed in Egypt.² In theory it was always supposed that the whole of the soil belonged to him, but that he and his predecessors had diverted and parcelled off such an amount of it for the benefit of their favourites, or for the hereditary lords, that only half of the actual territory remained under his immediate control. He governed most of the nomes of the Delta in person:³ beyond the Fayûm, he merely retained isolated lands, enclosed in the middle of feudal principalities

¹ We know the reputation, extending even to the classical writers of antiquity, of the Pharaohs Nechepso and Nectanebo for their skill in magic. Arab writers have, moreover, collected a number of traditions concerning the marvels which the sorcerers of Egypt were in the habit of performing; as an instance, I may quote the description given by Makrizî of one of their meetings, which is probably taken from some earlier writer.

² They were frequently distinguished from their provincial or manorial colleagues by the addition of the word *khonû* to their titles, a term which indicates, in a general manner, the royal residence. They formed what we should nowadays call the departmental staff of the public officers, and might be deputed to act, at least temporarily, in the provinces, or in the service of one of the feudal princes, without thereby losing their status as functionaries of the *khonû* or central administration.

³ This seems, at any rate, an obvious inference from the almost total absence of feudal titles on the most ancient monuments of the Delta. Erman, who was struck by this fact, attributed it to a different degree of civilization in the two halves of Egypt; I attribute it to a difference in government. Feudal titles naturally predominate in the South, royal administrative titles in the North.

and often at considerable distance from each other. The extent of the royal domain varied with different dynasties, and even from reign to reign: if it sometimes decreased, owing to too frequently repeated concessions,¹ its losses were generally amply compensated by the confiscation of certain fiefs, or by their lapsing to the crown. The domain was always of sufficient extent to oblige the Pharaoh to confide the larger portion of it to officials of various kinds, and to farm merely a small remainder of the "royal slaves:" in the latter case, he reserved for himself all the profits, but at the expense of all the annoyance and all the outlay; in the former case, he obtained without any risk the annual dues, the amount of which was fixed on the spot, according to the resources of the nome. In order to understand the manner in which the government of Egypt was conducted, we should never forget that the world was still ignorant of the use of money, and that gold, silver, and copper, however abundant we may suppose them to have been, were mere articles of exchange, like the most common products of Egyptian soil. Pharaoh was not then, as the State is with us, a treasurer who calculates the total of his receipts and expenses in ready money, banks his revenue in specie occupying but little space, and settles his accounts from the same source. His fiscal receipts were in kind, and it was in kind that he remunerated his servants for

¹ We find, at different periods, persons who call themselves masters of *new* domains or strongholds—Pahûrnofir, under the IIIrd dynasty; several princes of Hermopolis, under the VIth and VIIth; Khnûmhotpû at the beginning of the XIIth. In connection with the last named, we shall have occasion, later on, to show in what manner and with what rapidity one of these great *new* fiefs was formed.

their labour: cattle, cereals, fermented drinks, oils, stuffs, common or precious metals,—“all that the heavens give, all that the earth produces, all that the Nile brings from its mysterious sources,”¹—constituted the coinage in which his subjects paid him their contributions, and which he passed on to his vassals by way of salary. One room, a few feet square, and, if need be, one safe, would easily contain the entire revenue of one of our modern empires: the largest of our emporiums would not always have sufficed to hold the mass of incongruous objects which represented the returns of a single Egyptian province. As the products in which the tax was paid took various forms, it was necessary to have an infinite variety of special agents and suitable places to receive it; herdsmen and sheds for the oxen, measurers and granaries for the grain, butlers and cellarers for the wine, beer, and oils. The product of the tax, while awaiting redistribution, could only be kept from deteriorating in value by incessant labour, in which a score of different classes of clerks and workmen in the service of the treasury all took part, according to their trades. If the tax were received in oxen, it was led to pasturage, or at times, when a murrain threatened to destroy it, to the slaughter-house and the currier; if it were in corn, it was bolted, ground to flour, and made into bread and pastry; if it were in stuffs, it was washed, ironed,

¹ This was the most usual formula for the offering on the funerary stelæ, and sums up more completely than any other the nature of the tax paid to the gods by the living, and consequently the nature of that paid to the king; here, as elsewhere, the domain of the gods is modelled on that of the Pharaohs.

and folded, to be retailed as garments or in the piece. The royal treasury partook of the character of the farm, the warehouse, and the manufactory.

Each of the departments which helped to swell its contents, occupied within the palace enclosure a building, or group of buildings, which was called its "house," or, as we should say, its storehouse. There was the "White Storehouse," where the stuffs and jewels were kept, and at times the wine; the "Storehouse of the Oxen," the "Gold

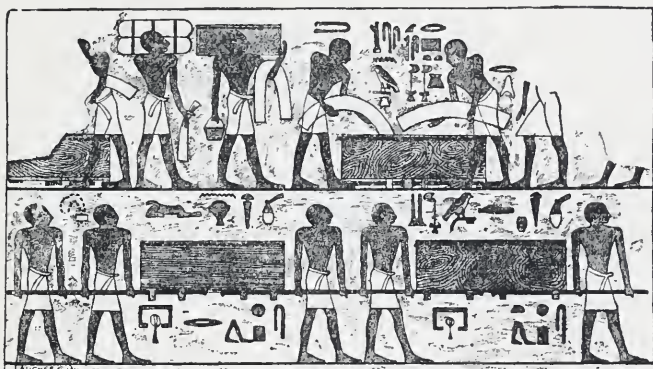

THE PACKING OF THE LINEN AND ITS REMOVAL TO THE WHITE STOREHOUSE.

Storehouse," the "Storehouse for Preserved Fruits," the "Storehouse for Grain," the Storehouse for Liquors," and ten other storehouses of the application of which we are not always sure. In the "Storehouse of Weapons" (or Armoury) were ranged thousands of clubs, maces, pikes, daggers, bows, and bundles of arrows, which Pharaoh distributed to his recruits whenever a war forced him to call out his army, and which were again warehoused after the

¹ Drawn by Faucher-Gudin, from a chromolithograph in LEPSIUS, *Denkm.*, ii. 96.

campaign. The "storehouses" were further subdivided into rooms or store-chambers,¹ each reserved for its own category of objects. It would be difficult to enumerate the number of store-chambers in the outbuildings of the "Storehouse of Provisions"—store-chambers for butcher's meat, for fruits, for beer, bread, and wine, in which were deposited as much of each article of food as would be required by the court for some days, or at most for a few weeks. They were brought there from the larger storehouses, the wines from vaults, the oxen from their stalls, the corn from the granaries. The latter were vast brick-built receptacles, ten or more in a row, circular in shape and surmounted by cupolas, but having no communication with each other. They had only two openings, one at the top for pouring in the grain, another on the ground level for drawing it out; a notice posted up outside, often on the shutter which closed the chamber, indicated the character and quantity of the cereals within. For the security and management of these, there were employed troops of porters, store-keepers, accountants, "primates" who superintended the works, record-keepers, and directors. Great nobles coveted the administration of the "storehouses," and even the sons of kings did not think it derogatory to their dignity to be

¹ *Âîr, Âî.* Lefébure has collected a number of passages in which these storehouses are mentioned, in his notes *Sur différents mots et noms Égyptiens*. In many of the cases which he quotes, and in which he recognizes an office of the State, I believe reference to be made to a trade: many of the *ÂRÎ Âîr-ÂFÛ*, "people of the store-chambers for meat," were probably butchers; many of the *ÂRÎ Âîr-ÎÎQÎÛ*, "people of the store-chamber for beer," were probably keepers of drink-shops, trading on their own account in the town of Abydos, and not *employés* attached to the exchequer of Pharaoh or of the ruler of Thisis.

entitled "Directors of the Granaries," or "Directors of the Armoury." There was no law against pluralists, and more than one of them boasts on his tomb of having held simultaneously five or six offices. These storehouses participated like all the other dependencies of the crown, in that duality which characterized the person of the Pharaoh. They would be called in common parlance, the Storehouse or the Double White Storehouse, the Storehouse or the Double Gold Storehouse, the Double Warehouse,



MEASURING THE WHEAT AND DEPOSITING IT IN THE GRANARIES.¹

the Double Granary. The large towns, as well as the capital, possessed their double storehouses and their store-chambers, into which were gathered the products of the neighbourhood, but where a complete staff of *employés* was not always required: in such towns we meet with "localities" in which the commodities were housed

¹ Drawn by Faucher-Gudin, from a scene on the tomb of Amoni at Beni-Hasan. On the right, near the door, is a heap of grain, from which the measurer fills his measure in order to empty it into the sack which one of the porters holds open. In the centre is a train of slaves ascending the stairs which lead to the loft above the granaries; one of them empties his sack into a hole above the granary in the presence of the overseer. The inscriptions in ink on the outer wall of the receptacles, which have already been filled, indicate the number of measures which each one of them contains.

merely temporarily. The least perishable part of the provincial dues was forwarded by boat to the royal residence,¹ and swelled the central treasury. The remainder was used on the spot for paying workman's wages, and for the needs of the Administration. We see from the inscriptions, that the staffs of officials who administered affairs in the provinces was similar to that in the royal city. Starting from the top, and going down to the bottom of the scale, each functionary supervised those beneath him, while, as a body, they were all responsible for their depôt. Any irregularity in the entries entailed the bastinado; peculators were punished by imprisonment, mutilation, or death, according to the gravity of the offence. Those whom illness or old age rendered unfit for work, were pensioned for the remainder of their life.

The writer, or, as we call him, the scribe, was the mainspring of all this machinery. We come across him in all grades of the staff: an insignificant registrar of oxen, a clerk of the Double White Storehouse, ragged, humble, and badly paid, was a scribe just as much as the noble, the priest, or the king's son. Thus the title of scribe was of no value in itself, and did not designate, as one might naturally think, a savant educated in a school of high culture, or a man of the world, versed in the sciences and the literature of his time; every one

¹ The boats employed for this purpose formed a flotilla, and their commanders constituted a regularly organized transport corps, who are frequently to be found represented on the monuments of the New Empire, carrying tribute to the residence of the king or of the prince, whose retainers they were. An excellent example may be seen on the tomb of Pihiri, at El-Kab.

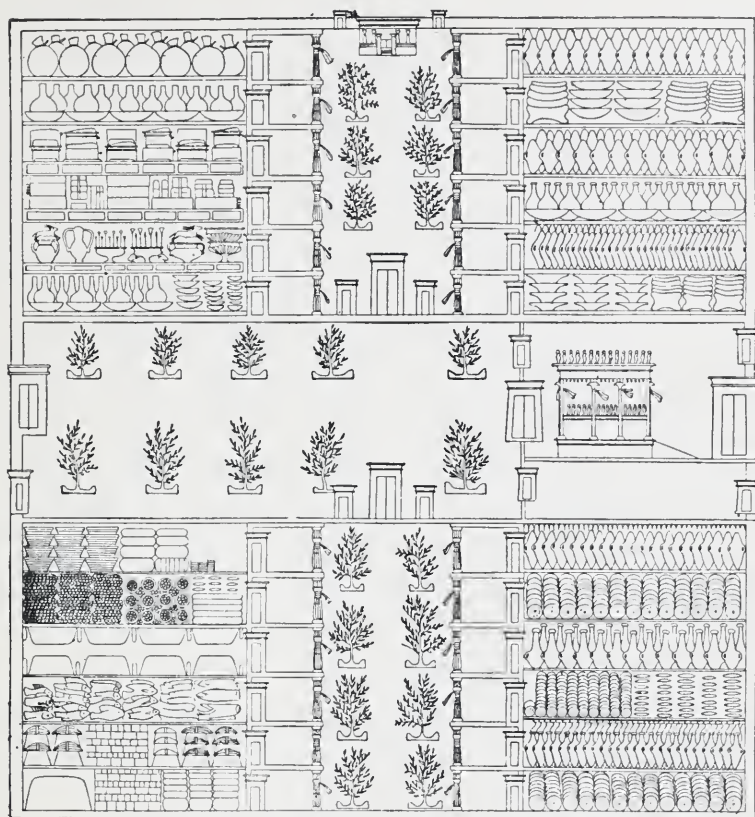
PLAN OF A PRINCELY STOREHOUSE FOR PROVISIONS.¹

was a scribe who knew how to read, write, and cipher, was fairly proficient in wording the administrative

¹ Drawn by Faucher-Gudin, from LEPSIUS, *Denkm.*, iii. 95. The illustration is taken from one of the tombs at Tel el-Amarna. The storehouse consists of four blocks, isolated by two avenues planted with trees, which intersect each other in the form of a cross. Behind the entrance gate, in a small courtyard, is a kiosque, in which the master sat for the purpose of receiving the stores or of superintending their distribution; two of the arms of the cross are lined by porticoes, under which are the entrances to the "chambers" (*dil*) for the stores, which are filled with jars of wine, linen-chests, dried fish, and other articles.

formulas, and could easily apply the elementary rules of book-keeping. There was no public school in which the scribe could be prepared for his future career; but as soon as a child had acquired the first rudiments of letters with some old pedagogue, his father took him with him to his office, or entrusted him to some friend who agreed to undertake his education. The apprentice observed what went on around him, imitated the mode of procedure of the *employés*, copied in his spare time old papers, letters, bills, flowerily-worded petitions, reports, complimentary addresses to his superiors or to the Pharaoh, all of which his patron examined and corrected, noting on the margin letters or words imperfectly written, improving the style, and recasting or completing the incorrect expressions.¹ As soon as he could put together a certain number of sentences or figures without a mistake, he was allowed to draw up bills, or to have the sole superintendence of some department of the treasury, his work being gradually increased in amount and difficulty; when he was considered to be sufficiently *au courant* with the ordinary business, his education was declared to be finished, and a situation

¹ We still possess school exercises of the XIXth and XXth dynasties, e.g. the *Papyrus Anastasi n° IV.*, and the *Anastasi Papyrus n° V.*, in which we find a whole string of pieces of every possible style and description—business letters, requests for leave of absence, complimentary verses addressed to a superior, all probably a collection of exercises compiled by some professor, and copied by his pupils in order to complete their education as scribes; the master's corrections are made at the top and bottom of the pages in a bold and skilful hand, very different from that of the pupil, though the writing of the latter is generally more legible to our modern eyes (*Select Papyri*, vol. i. pls. lxxxiii.–cxxi.).

was found for him either in the place where he had begun his probation, or in some neighbouring office.¹ Thus equipped, the young man ended usually by succeeding his father or his patron: in most of the government

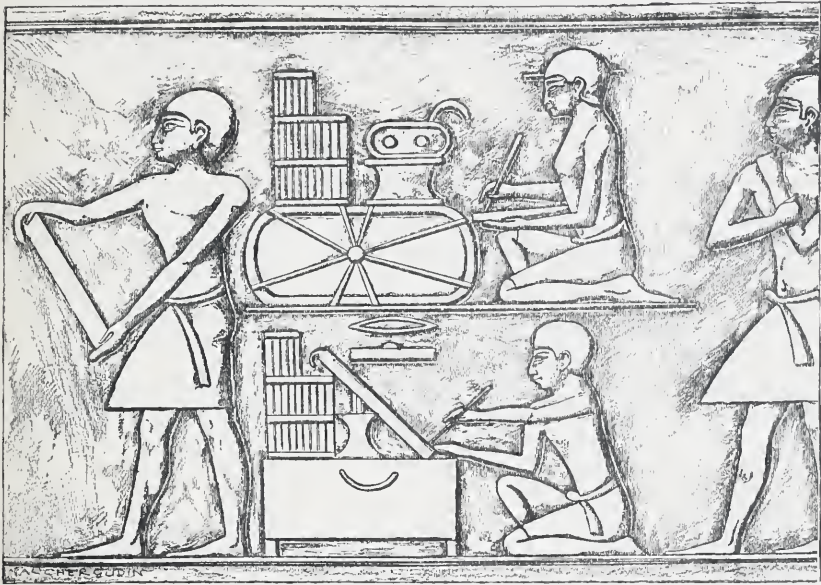

THE STAFF OF A GOVERNMENT OFFICER IN THE TIME OF THE MEMPHITE DYNASTIES.²

¹ Evidence of this state of things seems to be furnished by all the biographies of scribes with which we are acquainted, *e.g.* that of Amten; it is, moreover, what took place regularly throughout the whole of Egypt, down to the latest times, and what probably still occurs in those parts of the country where European ideas have not yet made any deep impression.

² Drawn by Faucher-Gudin, from a wall-painting on the tomb of Khûnas. Two scribes are writing on tablets. Before the scribe in the upper part of the picture we see a palette, with two saucers, on a vessel which serves as an ink-bottle, and a packet of tablets tied together, the whole supported by a bundle of archives. The scribe in the lower part rests his tablet against an ink-bottle, a box for archives being placed before him. Behind them a *nakht-khrôû* announces the delivery of a tablet covered with figures which the third scribe is presenting to the master.

administrations, we find whole dynasties of scribes on a small scale, whose members inherited the same post for several centuries. The position was an insignificant one, and the salary poor, but the means of existence were assured, the occupant was exempted from forced labour and from military service, and he exercised a certain authority in the narrow world in which he lived; it sufficed to make him think himself happy, and in fact to be so. "One has only to be a scribe," said the wise man, "for the scribe takes the lead of all." Sometimes, however, one of these contented officials, more intelligent or ambitious than his fellows, succeeded in rising above the common mediocrity: his fine handwriting, the happy choice of his sentences, his activity, his obliging manner, his honesty—perhaps also his discreet dishonesty—attracted the attention of his superiors and were the cause of his promotion. The son of a peasant or of some poor wretch, who had begun life by keeping a register of the bread and vegetables in some provincial government office, had been often known to crown his long and successful career by exercising a kind of vice-regency over the half of Egypt. His granaries overflowed with corn, his storehouses were always full of gold, fine stuffs, and precious vases, his stalls "multiplied the backs" of his oxen; the sons of his early patrons, having now become in turn his *protégés*, did not venture to approach him except with bowed head and bended knee.

No doubt the Amten whose tomb was removed to Berlin by Lepsius, and put together piece by piece in

the museum, was a *parvenu* of this kind. He was born rather more than four thousand years before our era, under one of the last kings of the IIIrd dynasty, and he lived until the reign of the first king of the IVth dynasty, Snofrûti. He probably came from the Nome of the Bull, if not from Xoïs itself, in the heart of the Delta. His father, the scribe Anûpûmonkhû, held, in addition to his office, several landed estates, producing



THE CRER ANNOUNCES THE ARRIVAL OF FIVE REGISTRARS OF THE TEMPLE OF KING ÛSIRNIRÏ, OF THE Vth DYNASTY.¹

large returns; but his mother, Nibsonit, who appears to have been merely a concubine, had no personal fortune, and would have been unable even to give her child an education. Anûpûmonkhû made himself entirely responsible for the necessary expenses, "giving him all the necessities of life, at a time when he had not as yet either corn, barley, income, house, men or women servants, or troops of asses, pigs, or oxen." As soon as

¹ Drawn by Faucher-Gudin, from a picture in the tomb of Shopsisûri. Four registrars of the funerary temple of ÛsirnirÏ advance in a crawling posture towards the master, the fifth has just risen and holds himself in a stooping attitude, while an usher introduces him and transmits to him an order to send in his accounts.

he was in a condition to provide for himself, his father obtained for him, in his native Nome, the post of chief scribe attached to one of the "localities" which belonged to the Administration of Provisions. On behalf of the Pharaoh, the young man received, registered, and distributed the meat, cakes, fruits, and fresh vegetables which constituted the taxes, all on his own responsibility, except that he had to give an account of them to the "Director of the Storehouse" who was nearest to him. We are not told how long he remained in this occupation; we see merely that he was raised successively to posts of an analogous kind, but of increasing importance. The provincial offices comprised a small staff of *employés*, consisting always of the same officials:—a chief, whose ordinary function was "Director of the Storehouse;" a few scribes to keep the accounts, one or two of whom added to his ordinary calling that of keeper of the archives; paid ushers to introduce clients, and, if need be, to bastinado them summarily at the order of the "director;" lastly, the "strong of voice," the criers, who superintended the incomings and outgoings, and proclaimed the account of them to the scribes to be noted down forthwith. A vigilant and honest crier was a man of great value. He obliged the taxpayer not only to deliver the exact number of measures prescribed as his quota, but also compelled him to deliver good measure in each case; a dishonest crier, on the contrary, could easily favour cheating, provided that he shared in the spoil. Amten was at once "crier" and "taxer of the colonists" to the civil administrator of the Xoïte nome: he announced the

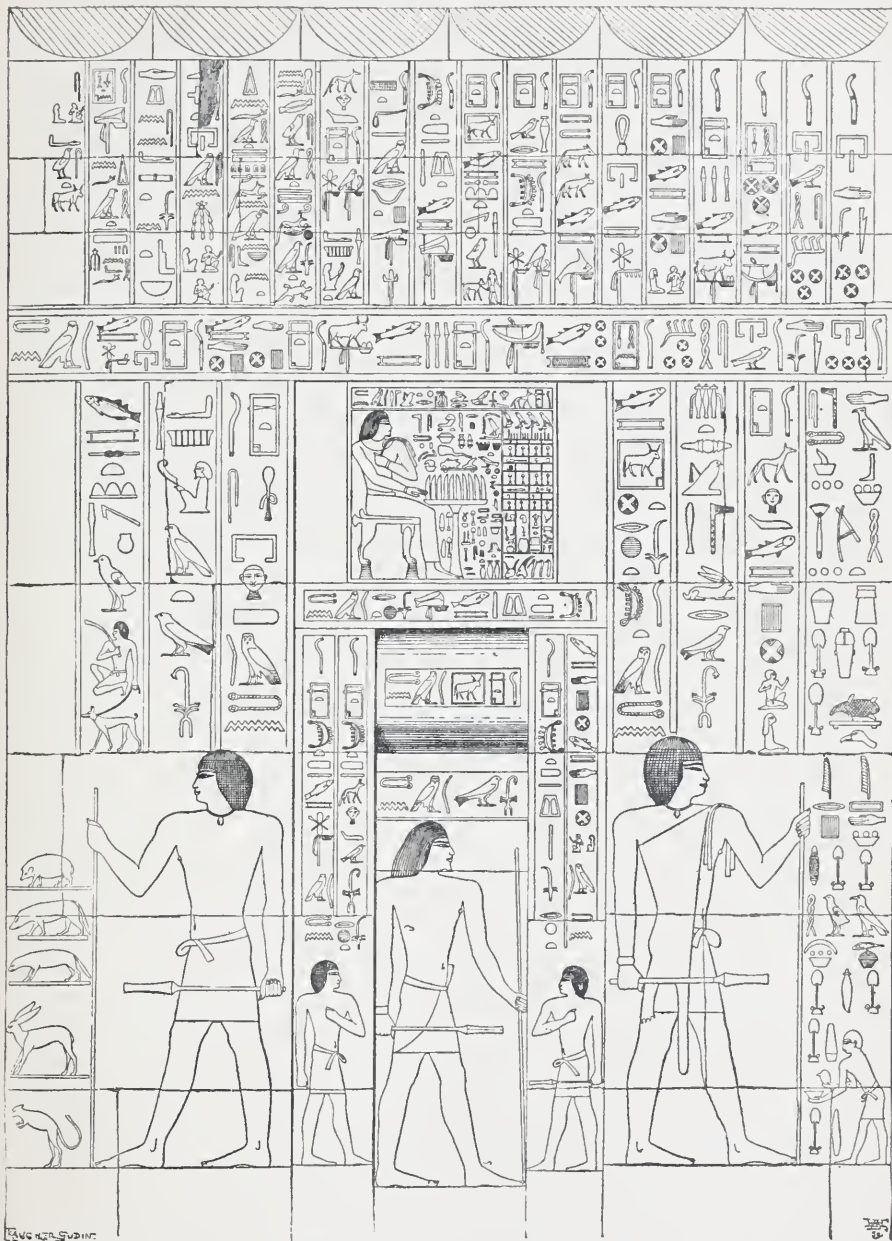

THE FUNERAL STELE OF THE TOMB OF AMTEN, THE "GRAND HUNTSMAN."

names of the peasants and the payments they made, then estimated the amount of the local tax which each, according to his income, had to pay. He distinguished himself so pre-eminently in these delicate duties, that the civil administrator of Xoïs made him one of his subordinates. He became "Chief of the Ushers," afterwards "Master Crier," then "Director of all the King's flax" in the Xoïte nome—an office which entailed on him the supervision of the culture, cutting, and general preparation of flax for the manufacture which was carried on in Pharaoh's own domain. It was one of the highest offices in the Provincial Administration, and Amten must have congratulated himself on his appointment.

From that moment his career became a great one, and he advanced quickly. Up to that time he had been confined in offices; he now left them to perform more active service. The Pharaohs, extremely jealous of their own authority, usually avoided placing at the head of the nomes in their domain, a single ruler, who would have appeared too much like a prince; they preferred having in each centre of civil administration, governors of the town or province, as well as military commanders who were jealous of one another, supervised one another, counterbalanced one another, and did not remain long enough in office to become dangerous. Amten held all these posts successively in most of the nomes situated in the centre or to the west of the Delta. His first appointment was to the government of the village of Pidosû, an unimportant post in itself, but one which entitled him to a staff of office, and in consequence procured for him one

of the greatest indulgences of vanity that an Egyptian could enjoy. The staff was, in fact, a symbol of command which only the nobles, and the officials associated with the nobility, could carry without transgressing custom; the assumption of it, as that of the sword with us, showed

every one that the bearer was a member of a privileged class. Amen was no sooner ennobled, than his functions began to extend; villages were rapidly added to villages, then towns to towns, including such an important one as Bûto, and

finally the nomes of the Harpoon, of the Bull, of the Silurus, the western half of the Saïte nome, the nome of the Haunch, and a part of the Fayûm came within his jurisdiction. The western half of the Saïte nome, where he long resided, corresponded with what



STATUE OF AMEN, FOUND IN HIS TOMB.¹

was called later the Libyan nome. It reached nearly from the apex of the Delta to the sea, and was bounded on one side by the Canopic branch of the Nile, on the

¹ Drawn by Faucher-Gudin, from LEPSIUS, *Denkm.*, ii. 120 a ; the original is in the Berlin Museum.

other by the Libyan range; a part of the desert as well as the Oases fell under its rule. It included among its population, as did many of the provinces of Upper Egypt, regiments composed of nomad hunters, who were compelled to pay their tribute in living or dead game. Amten was metamorphosed into Chief Huntsman, scoured the mountains with his men, and thereupon became one of the most important personages in the defence of the country. The Pharaohs had built fortified stations, and had from time to time constructed walls at certain points where the roads entered the valley—at Syene, at Coptos, and at the entrance to the Wady Tûmilât. Amten having been proclaimed “Primate of the Western Gate,” that is, governor of the Libyan marches, undertook to protect the frontier against the wandering Bedouin from the other side of Lake Mareotis. His duties as Chief Huntsman had been the best preparation he could have had for this arduous task. They had forced him to make incessant expeditions among the mountains, to explore the gorges and ravines, to be acquainted with the routes marked out by wells which the marauders were obliged to follow in their incursions, and the pathways and passes by which they could descend into the plain of the Delta; in running the game to earth, he had gained all the knowledge needful for repulsing the enemy. Such a combination of capabilities made Amten the most important noble in this part of Egypt. When old age at last prevented him from leading an active life, he accepted, by way of a pension, the governorship of the nome of the Haunch: with civil authority, military command, local priestly

functions, and honorary distinctions, he lacked only one thing to make him the equal of the nobles of ancient family, and that was permission to bequeath without restriction his towns and offices to his children.

His private fortune was not as great as we might be led to think. He inherited from his father only one estate, but had acquired twelve others in the nomes of the Delta whither his successive appointments had led him—namely, in the Saïte, Xoïte, and Letopolite nomes. He received subsequently, as a reward for his services, two hundred portions of cultivated land, with numerous peasants, both male and female, and an income of one hundred loaves daily, a first charge upon the funeral provision of Queen Hâpûnimâit. He took advantage of this windfall to endow his family suitably. His only son was already provided for, thanks to the munificence of Pharaoh; he had begun his administrative career by holding the same post of scribe, in addition to the office of provision registrar, which his father had held, and over and above these he received by royal grant, four portions of cornland with their population and stock. Amten gave twelve portions to his other children and fifty to his mother Nibsonit, by means of which she lived comfortably in her old age, and left an annuity for maintaining worship at her tomb. He built upon the remainder of the land a magnificent villa, of which he has considerably left us the description. The boundary wall formed a square of 350 feet on each face, and consequently contained a superficies of 122,500 square feet. The well-built dwelling-house, completely furnished with all the necessities of life, was surrounded by

ornamental and fruit-bearing trees,—the common palm, the nebbek, fig trees, and acacias; several ponds, neatly bordered with greenery, afforded a habitat for aquatic

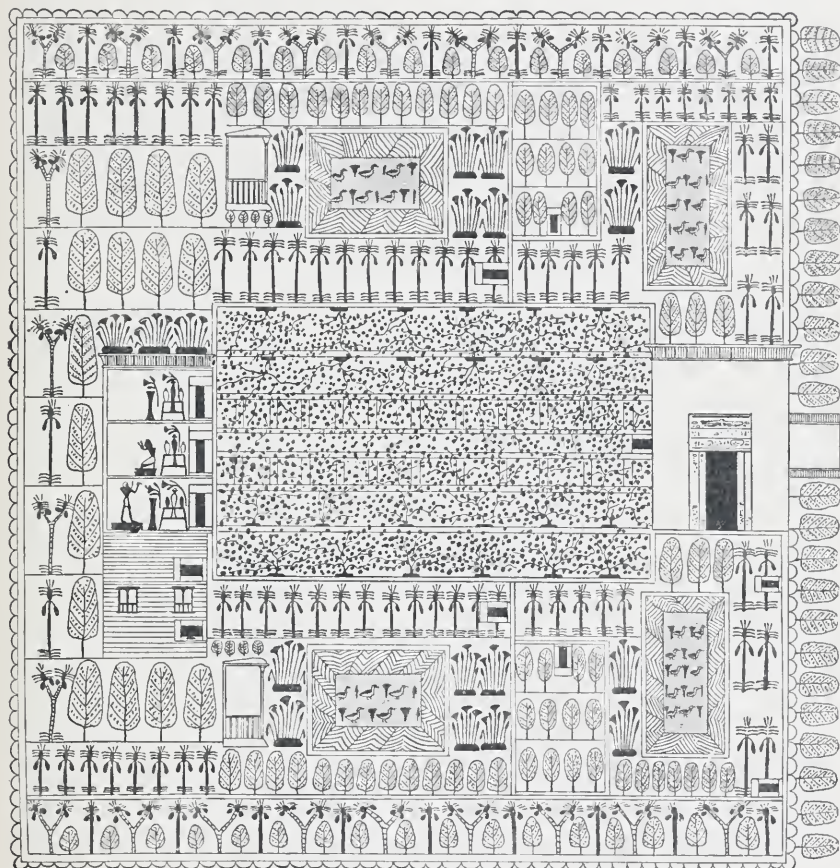

PLAN OF THE VILLA OF A GREAT EGYPTIAN NOBLE.¹

birds; trellised vines, according to custom, ran in front of the house, and two plots of ground, planted with vines in

¹ This plan is taken from a Theban tomb of the XVIIIth dynasty; but it corresponds exactly with the description which Amten has left us of his villa.

full bearing, amply supplied the owner with wine every year. It was there, doubtless, that Amten ended his days in peace and quietude of mind. The tableland whereon the Sphinx has watched for so many centuries was then crowned by no pyramids, but mastabas of fine white stone rose here and there from out of the sand: that in which the mummy of Amten was to be enclosed was situated not far from the modern village of Abûsir, on the confines of the nome of the Haunch, and almost in sight of the mansion in which his declining years were spent.¹

The number of persons of obscure origin, who in this manner had risen in a few years to the highest honours, and died governors of provinces or ministers of Pharaoh, must have been considerable. Their descendants followed in their fathers' footsteps, until the day came when royal favour or an advantageous marriage secured them the possession of an hereditary fief, and transformed the son or grandson of a prosperous scribe into a feudal lord. It was from people of this class, and from the children of the Pharaoh, that the nobility was mostly recruited. In the Delta, where the authority of the Pharaoh was almost everywhere directly felt, the power of the nobility was weakened and much curtailed; in Middle Egypt it gained ground, and became stronger and stronger in proportion

¹ The site of Amten's manorial mansion is nowhere mentioned in the inscriptions; but the custom of the Egyptians to construct their tombs as near as possible to the places where they resided, leads me to consider it as almost certain that we ought to look for its site in the Memphite plain, in the vicinity of the town of Abûsir, but in a northern direction, so as to keep within the territory of the Letopolite nome, where Amten governed in the name of the king.

as one advanced southward. The nobles held the principalities of the Gazelle, of the Hare, of the Serpent Mountain, of Akhmîm, of Thinis, of Qasr-es-Sayad, of El-Kab, of Aswân, and doubtless others of which we shall



HUNTING WITH THE BOOMERANG AND FISHING WITH THE DOUBLE HARPOON IN A MARSH OR POOL.¹

some day discover the monuments. They accepted without difficulty the fiction according to which Pharaoh claimed to be absolute master of the soil, and ceded to

¹ Drawn by Faucher-Gudin, from a photograph by Gayet.

his subjects only the usufruct of their fiefs; but apart from the admission of the principle, each lord proclaimed himself sovereign in his own domain, and exercised in it, on a small scale, complete royal authority. Everything within the limits of this petty state belonged to him—woods,

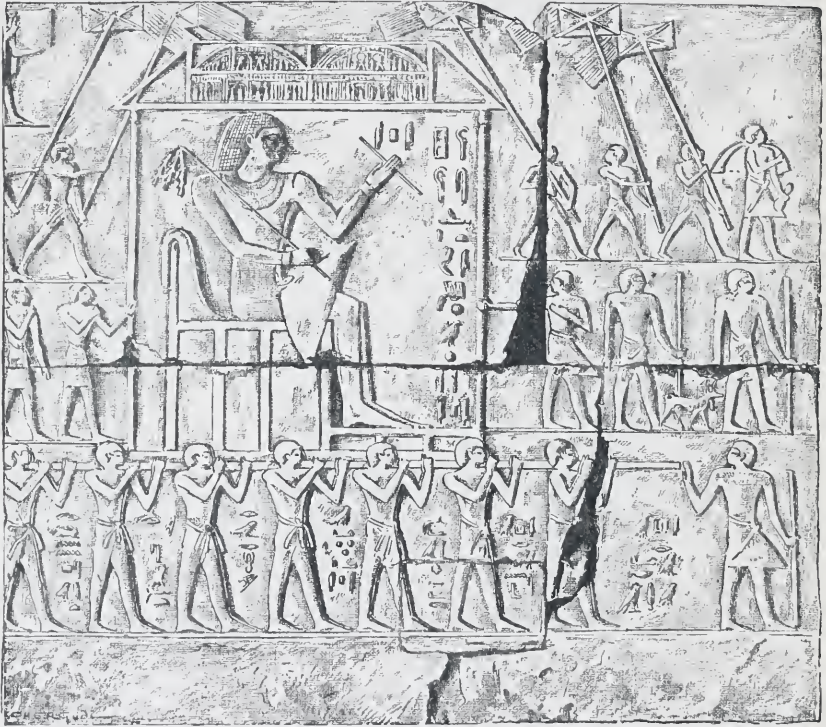

PRINCE API, BORNE IN A PALANQUIN, INSPECTS HIS FUNERARY DOMAIN.¹

canals, fields, even the desert-sand:¹ after the example of the Pharaoh, he farmed a part himself, and let out the

¹ Drawn by Faucher-Gudin, from a photograph by Émil Brugsch-Bey. The tomb of Api was discovered at Saqqâra in 1884. It had been pulled down in ancient times, and a new tomb built on its ruins, about the time of the XIIth dynasty; all that remains of it is now in the museum at Gîzeh.

remainder, either in farms or as fiefs, to those of his followers who had gained his confidence or his friendship. After the example of Pharaoh, also, he was a priest, and exercised priestly functions in relation to all the gods—that is, not of all Egypt, but of all the deities of the nome. He was an administrator of civil and criminal law, received the complaints of his vassals and serfs at the gate of his palace, and against his decisions there was no appeal. He kept up a flotilla, and raised on his estate a small army, of which he was commander-in-chief by hereditary right. He



A DWARF PLAYING WITH CYNOCOPHALI AND A TAME IBIS.¹

inhabited a fortified mansion, situated sometimes within the capital of the principality itself, sometimes in its neighbourhood, and in which the arrangements of the royal city were reproduced on a smaller scale. Side by side with the reception halls was the harem, where the legitimate wife, often a princess of solar rank, played the *rôle* of queen, surrounded by concubines, dancers, and slaves. The offices of the various departments were crowded into the enclosure, with their directors, governors, scribes of all

¹ Drawn by Faucher-Gudin, from a chromolithograph in FLINDERS PETRIE'S *Mémoires*, pl. xxiv.

ranks, custodians, and workmen, who bore the same titles as the corresponding *employés* in the departments of the State: their White Storehouse, their Gold Storehouse, their Granary, were at times called the Double White Storehouse, the Double Gold Storehouse, the Double Granary, as were those of the Pharaoh. Amusements at the court of the vassal did not differ from those at that of the sovereign: hunting in the desert and the marshes, fishing,

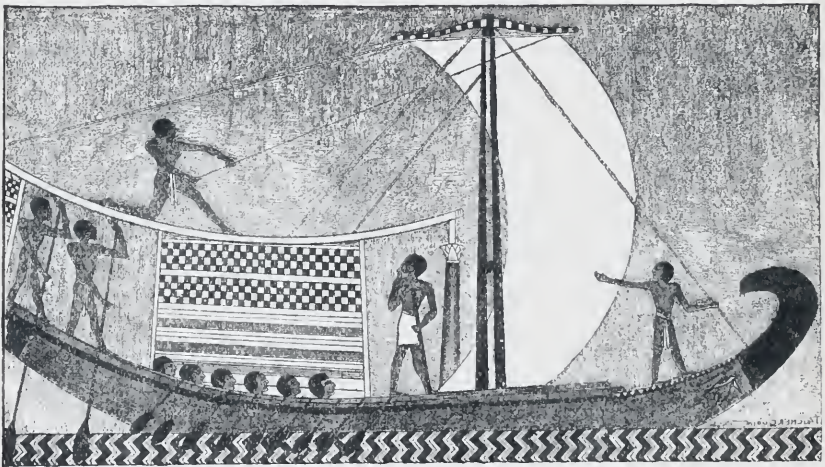

IN A NILE BOAT.

inspection of agricultural works, military exercises, games, songs, dancing, doubtless the recital of long stories, and exhibitions of magic, even down to the contortions of the court buffoon and the grimaces of the dwarfs. It amused the prince to see one of these wretched favourites leading to him by the paw a cynocephalus larger than himself, while a mischievous monkey slyly pulled a tame and stately ibis by the tail. From time to time the great lord proceeded to inspect his domain: on these

occasions he travelled in a kind of sedan chair, supported by two mules yoked together; or he was borne in a palanquin by some thirty men, while fanned by large flabella; or possibly he went up the Nile and the canals in his beautiful painted barge. The life of the Egyptian lords may be aptly described as in every respect an exact reproduction of the life of the Pharaoh on a smaller scale.

Inheritance in a direct or indirect line was the rule, but in every case of transmission the new lord had to receive the investiture of the sovereign either by letter or in person. The duties enforced by the feudal state do not appear to have been onerous. In the first place, there was the regular payment of a tribute, proportionate to the extent and resources of the fief. In the next place, there was military service: the vassal agreed to supply, when called upon, a fixed number of armed men, whom he himself commanded, unless he could offer a reasonable excuse such as illness or senile incapacity.¹ Attendance at court was not obligatory: we notice, however, many nobles about the person of Pharaoh, and there are numerous examples of princes, with whose lives we are familiar, filling offices which appear to have demanded at least a temporary residence in the palace, as, for instance, the charge of the royal wardrobe. When the king travelled, the great vassals

¹ Prince Amoni, of the Gazelle nome, led a body of four hundred men and another body of six hundred, levied in his principality, into Ethiopia under these conditions; the first that he served in the royal army, was as a substitute for his father, who had grown too old. Similarly, under the XVIIIth dynasty, Âhmosis of El-Kab commanded the war-ship, the *Calf*, in place of his father. The Ûni inscription furnishes us with an instance of a general levy of the feudal contingents in the time of the VIth dynasty (l. 14, et seq.).

were compelled to entertain him and his suite, and to escort him to the frontier of their domain. On the occasion of such visits, the king would often take away with him one of their sons to be brought up with his own children: an act which they on their part considered a great honour, while the king on his had a guarantee of their fidelity in the person of these hostages. Such of these young people as returned to their fathers' roof when their education was finished, were usually most loyal to the reigning dynasty. They often brought back with them some maiden born in the purple, who consented to share their little provincial sovereignty, while in exchange one or more of their sisters entered the harem of the Pharaoh. Marriages made and marred in their turn the fortunes of the great feudal houses. Whether she were a princess or not, each woman received as her dowry a portion of territory, and enlarged by that amount her husband's little state; but the property she brought might, in a few years, be taken by her daughters as portions and enrich other houses. The fief seldom could bear up against such dismemberment; it fell away piecemeal, and by the third or fourth generation had disappeared. Sometimes, however, it gained more than it lost in this matrimonial game, and extended its borders till they encroached on neighbouring nomes or else completely absorbed them. There were always in the course of each reign several great principalities formed, or in the process of formation, whose chiefs might be said to hold in their hands the destinies of the country. Pharaoh himself was obliged to treat them with deference, and he purchased their allegiance by renewed and ever-increasing concessions.

Their ambition was never satisfied ; when they were loaded with favours, and did not venture to ask for more for themselves, they impudently demanded them for such of their children as they thought were poorly provided for. Their eldest son “knew not the high favours which came from the king. Other princes were his privy counsellors, his chosen friends, or foremost among his friends !” he had no share in all this. Pharaoh took good care not to reject a petition presented so humbly : he proceeded to lavish appointments, titles, and estates on the son in question ; if necessity required it, he would even seek out a wife for him, who might give him, together with her hand, a property equal to that of his father. The majority of these great vassals secretly aspired to the crown : they frequently had reason to believe that they had some right to it, either through their mother or one of their ancestors. Had they combined against the reigning house, they could easily have gained the upper hand, but their mutual jealousies prevented this, and the overthrow of a dynasty to which they owed so much would, for the most part, have profited them but little : as soon as one of them revolted, the remainder took arms in Pharaoh’s defence, led his armies and fought his battles. If at times their ambition and greed harassed their suzerain, at least their power was at his service, and their self-interested allegiance was often the means of delaying the downfall of his house.

Two things were specially needful both for them and for Pharaoh in order to maintain or increase their authority—the protection of the gods, and a military organization which enabled them to mobilize the whole of their forces at

the first signal. The celestial world was the faithful image of our own ; it had its empires and its feudal organization, the arrangement of which corresponded to that of the terrestrial world. The gods who inhabited it were dependent upon the gifts of mortals, and the resources of each individual deity, and consequently his power, depended on the wealth and number of his worshippers ; anything influencing one had an immediate effect on the other. The gods dispensed happiness, health, and vigour ;¹ to those who made them large offerings and instituted pious foundations, they lent their own weapons, and inspired them with needful strength to overcome their enemies. They even came down to assist in battle, and every great encounter of armies involved an invisible struggle among the immortals. The gods of the side which was victorious shared with it in the triumph, and received a tithe of the spoil as the price of their help ; the gods of the vanquished were so much the poorer, their priests and their statues were reduced to slavery, and the destruction of their people entailed their own downfall. It was, therefore, to the special interest of every one in Egypt, from the Pharaoh to the humblest of his vassals, to maintain the good will and power of the gods, so that their protection might be effectively ensured in the hour of danger. Pains were taken to embellish their temples with obelisks, colossi, altars, and bas-reliefs ; new buildings were added to the old ; the parts threatened with

¹ I may here remind my readers of the numberless bas-reliefs and stela on which the king is represented as making an offering to a god, who replies in some such formula as the following : "I give thee health and strength ;" or, "I give thee joy and life for millions of years."

ruin were restored or entirely rebuilt; daily gifts were brought of every kind—animals which were sacrificed on the spot, bread, flowers, fruit, drinks, as well as perfumes, stuffs, vases, jewels, bricks or bars of gold, silver, lapis-lazuli, which were all heaped up in the treasury within the recesses of the crypts.¹ If a dignitary of high rank wished to perpetuate the remembrance of his honours or his services, and at the same time to procure for his double the benefit of endless prayers and sacrifices, he placed “by special permission”² a statue of himself on a votive stele in the part of the temple reserved for this purpose,—in a courtyard, chamber, encircling passage, as at Karnak,³ or on the staircase of Osiris as in that leading up to the terrace in the sanctuary of Abydos; he then sealed a formal agreement with the priests, by which the latter engaged to perform a service in his name, in front of this commemorative

¹ See the “Poem of Pentaûrit” for the grounds on which Ramses II. bases his imperative appeal to Amon for help: “Have I not made thee numerous offerings? I have filled thy temple with my prisoners. I have built thee an everlasting temple, and have not spared my wealth in endowing it for thee; I lay the whole world under contribution in order to stock thy domain. . . . I have built thee whole pylons in stone, and have myself reared the flagstaffs which adorn them; I have brought thee obelisks from Elephantinê.”

² The majority of the votive statues were lodged in a temple “by special favour of a king”—EM HOSÛTÛ NTÛ KHÛR SÛTON—as a recompense for services rendered. Some only of the stelæ bear an inscription to the above effect, no authorization from the king was required for the consecration of a stele in a temple.

³ It was in the encircling passage of the limestone temple built by the kings of the XIIth dynasty, and now completely destroyed, that all the Karnak votive statues were discovered. Some of them still rest on the stone ledge on which they were placed by the priests of the god at the moment of consecration.

monument, a stated number of times in the year, on the days fixed by universal observance or by local custom. For this purpose he assigned to them annuities in kind, charges on his patrimonial estates, or in some cases, if he were a great lord, on the revenues of his fief,—such as a fixed quantity of loaves and drinks for each of the celebrants, a fourth part of the sacrificial victim, a garment, frequently also lands with their cattle, serfs, existing buildings, farming implements and produce, along with the conditions of service with which the lands were burdened. These gifts to the god—“notir hotpûû”—were, it appears, effected by agreements analogous to those dealing with property in mortmain in modern Egypt; in each nome they constituted, in addition to the original temporalities of the temple, a considerable domain, constantly enlarged by fresh endowments. The gods had no daughters for whom to provide, nor sons among whom to divide their inheritance; all that fell to them remained theirs for ever, and in the contracts were inserted imprecations threatening with terrible ills, in this world and the next, those who should abstract the smallest portion from them. Such menaces did not always prevent the king or the lords from laying hands on the temple revenues: had this not been the case, Egypt would soon have become a sacerdotal country from one end to the other. Even when reduced by periodic usurpations, the domain of the gods formed, at all periods, about one-third of the whole country.¹

¹ The tradition handed down by Diodorus tells us that the goddess Isis assigned a third of the country to the priests; the whole of Egypt is said to have been divided into three equal parts, the first of which belonged to the

Its administration was not vested in a single body of Priests, representing the whole of Egypt and recruited or ruled everywhere in the same fashion. There were as many bodies of priests as there were temples, and every temple preserved its independent constitution with which the clergy of the neighbouring temples had nothing to do: the only master they acknowledged was the lord of the territory on which the temple was built, either Pharaoh or one of his nobles. The tradition which made Pharaoh the head of the different worships in Egypt prevailed everywhere, but Pharaoh soared too far above this world to confine himself to the functions of any one particular order of priests:¹ he officiated before all the gods without being specially the minister of any, and only exerted his supremacy in order to make appointments to important sacerdotal posts in his domain.²

priests, the second to the kings, and the third to the warrior class. When we read, in the great Harris Papyrus, the list of the property possessed by the temple of the Theban Amon alone, all over Egypt, under Ramses III., we can readily believe that the tradition of the Greek epoch in no way exaggerated matters.

¹ The only exception to this rule was in the case of the Theban kings of the XXIst dynasty, and even here the exception is more apparent than real. As a matter of fact, these kings, Hrihor and Pinozmû, began by being high priests of Amon before ascending the throne; they were pontiffs who became Pharaohs, not Pharaohs who created themselves pontiffs. Possibly we ought to place Smonkharî of the XIVth dynasty in the same category, if, as Brugsch assures us, his name, Mîr-mâshâû, is identical with the title of the high priest of Osiris at Mendes, thus proving that he was pontiff of Osiris in that town before he became king.

² Among other instances, we have that of the king of the XXIst Tanite dynasty, who appointed Mankhopirri, high priest of the Theban Amon, and that of the last king of the same dynasty, Psûsennes II., who conferred the

He reserved the high priesthood of the Memphite Phtah and that of Râ of Heliopolis either for the princes of his own family or more often for his most faithful servants; they were the docile instruments of his will, through whom he exerted the influence of the gods, and disposed of their property without having the trouble of administrating it. The feudal lords, less removed from mortal affairs than the Pharaoh, did not disdain to combine the priesthood of the temples dependent on them with the general supervision of the different worships practised on their lands. The princes of the Gazelle nome, for instance, bore the title of "Directors of the Prophets of all the Gods," but were, correctly speaking, prophets of Horus, of Khnûmû master of Haoîrit, and of Pakhît mistress of the Speos-Artemidos. The religious suzerainty of such princes was the complement of their civil and military power, and their ordinary income was augmented by some portion at least of the revenues which the lands in mortmain furnished annually. The subordinate sacerdotal functions were filled by professional priests whose status varied according to the gods they served and the provinces in which they were located. Although between the mere priest and the chief prophet there were a number of grades to which the majority never attained, still the temples attracted many people from divers sources, who, once established

same office on prince Aûpâti, son of Sheshonqâ. The king's right of nomination harmonized very well with the hereditary transmission of the priestly office through members of the same family, as we shall have occasion to show later on,

in this calling of life, not only never left it, but never rested until they had introduced into it the members of their families. The offices they filled were not necessarily hereditary, but the children, born and bred in the shelter of the sanctuary, almost always succeeded to the positions of their fathers, and certain families thus continuing in the same occupation for generations, at last came to be established as a sort of sacerdotal nobility.¹ The sacrifices supplied them with daily meat and drink; the temple buildings provided them with their lodging, and its revenues furnished them with a salary proportionate to their position. They were exempted from the ordinary taxes, from military service, and from forced labour; it is not surprising, therefore, that those who were not actually members of the priestly families strove to have at least a share in their advantages. The servitors, the workmen and the *employés* who congregated about them and constituted the temple corporation, the scribes attached to the administration of the domains, and to the receipt of offerings, shared *de facto* if not *de jure* in the immunity of the priesthood; as a body they formed a separate religious society, side by side, but distinct from, the civil population, and freed from most of the burdens which weighed so heavily on the latter.

The soldiers were far from possessing the wealth and

¹ We possess the coffins of the priests of the Theban Montû for nearly thirty generations, viz. from the XXVth dynasty to the time of the Ptolemies. The inscriptions give us their genealogies, as well as their intermarriages, and show us that they belonged almost exclusively to two or three important families who intermarried with one another or took their wives from the families of the priests of Amon,

influence of the clergy. Military service in Egypt was not universally compulsory, but rather the profession and privilege of a special class of whose origin but little is known. Perhaps originally it comprised only the descendants of the conquering race, but in historic times it was not exclusively confined to the latter, and recruits were raised everywhere among the fellahs,¹ the Bedouin of the neighbourhood, the negroes,² the Nubians,³ and even from among the prisoners of war, or adventurers from beyond the sea.⁴ This motley collection of foreign mercenaries composed ordinarily the body-guard of the king or of his barons, the permanent nucleus round which in times of war the levies of native recruits were rallied. Every Egyptian soldier received from the chief to whom he was attached, a holding of land for the maintenance of himself and his family. In the fifth

¹ This is shown, *inter alia*, by the real or supposititious letters in which the master-scribe endeavours to deter his pupil from adopting a military career, recommending that of a scribe in preference.

² Ūni, under Papi I., recruited his army from among the inhabitants of the whole of Egypt, from Elephantinê to Letopolis at the mouth of the Delta, and as far as the Mediterranean, from among the Bedouin of Libya and of the Isthmus, and even from the six negro races of Nubia (*Inscription d'Ouni*, ll. 14-19).

³ The Nubian tribe of the Mázaiû, afterwards known as the Libyan tribe of the Mâshaûasha, furnished troops to the Egyptian kings and princes for centuries; indeed, the Mázaiû formed such an integral part of the Egyptian armies that their name came to be used in Coptic as a synonym for soldier, under the form "matoï."

⁴ Later on we shall come across the Shardana of the Royal Guard under Ramses II. (E. DE ROUGÉ, *Extrait d'un mémoire sur les attaques*, p. 5); later still, the Ionians, Carians, and Greek mercenaries will be found to play a decisive part in the history of the Saïte dynasties.

century B.C. twelve *aruræ* of arable land was estimated as ample pay for each man,¹ and tradition attributes to the fabulous Sesostris the law which fixed the pay at this rate. The soldiers were not taxed, and were exempt from forced labour during the time that they were away from home on active service; with this exception they were liable to the same charges as the rest of the population. Many among them possessed no other income, and lived the precarious life of the fellah,—tilling, reaping, drawing water, and pasturing their cattle,—in the interval between two musters. Others possessed of private fortunes let their holdings out at a moderate rental, which formed an addition to their patrimonial income.² Lest they should forget the conditions upon which they possessed this military holding, and should regard themselves as absolute masters of it, they were seldom left long in possession of the same place:

¹ HERODOTUS, ii. 168. The *arura* being equal to 27·82 ares [an are = 100 square metres], the military fief contained $27·82 \times 12 = 333·84$ ares. [The “*arura*,” according to F. L. GRIFFITH, was a square of 100 Egyptian cubits, making about $\frac{2}{3}$ of an acre, or 2600 square metres.—TRS.] The *chifliks* created by Mohammed-Ali, with a view to bringing the abandoned districts into cultivation, allotted to each labourer who offered to reclaim it, a plot of land varying from one to three feddans, *i.e.* from 4200·83 square metres to 12602·49 square metres, according to the nature of the soil and the necessities of each family. The military fiefs of ancient Egypt were, therefore, nearly three times as great in extent as these *abadiyehs*, which were considered, in modern Egypt, sufficient to supply the wants of a whole family of peasants; they must, therefore, have secured not merely a bare subsistence, but ample provision for their proprietors.

² Diodorus Siculus says in so many words (i. 74) that “the farmers spent their life in cultivating lands which had been let to them at a moderate rent by the king, by the priests, and by the warriors.”

Herodotus asserts that their allotments were taken away yearly and replaced by others of equal extent. It is difficult to say if this law of perpetual change was always in force; at any rate, it did not prevent the soldiers from forming themselves in time into a kind of aristocracy, which even kings and barons of highest rank could not ignore. They were enrolled in special registers, with the indication of the holding which was temporarily assigned to them. A military scribe kept this register in every royal nome or principality. He

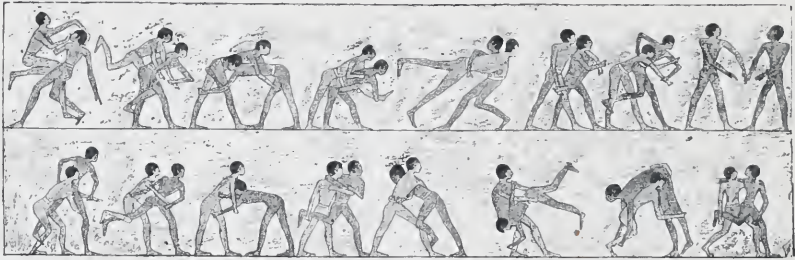

SOME OF THE MILITARY ATHLETIC EXERCISES.¹

superintended the redistribution of the lands, the registration of privileges, and in addition to his administrative functions, he had in time of war the command of the troops furnished by his own district; in which case he was assisted by a "lieutenant," who as opportunity offered acted as his substitute in the office or on the battle-field. Military service was not hereditary, but its advantages, however trifling they may appear to us, seemed in the eyes of the fellahs so great, that for the most part those who were engaged in it had their

¹ Drawn by Faucher-Gudin, from a scene in the tomb of Amoni-Amenemhât at Beni-Hasan.

children also enrolled. While still young the latter were taken to the barracks, where they were taught not only the use of the bow, the battle-axe, the mace, the lance, and the shield, but were all instructed in such exercises as rendered the body supple, and prepared them for manœuvring, regimental marching, running, jumping, and wrestling either with closed or open hand. They prepared themselves for battle by a regular waltz, pirouetting, leaping, and brandishing their bows and quivers in the air. Their training being finished, they were incorporated into local companies, and invested with their privileges. When they were required for service, part or the whole of the class was mustered; arms kept in the arsenal were distributed among them, and they were conveyed in boats to the scene of action. The Egyptians were not martial by temperament; they became soldiers rather from interest than inclination.

The power of Pharaoh and his barons rested entirely upon these two classes, the priests and the soldiers; the remainder, the commonalty and the peasantry, were, in their hands, merely an inert mass, to be taxed and subjected to forced labour at will. The slaves were probably regarded as of little importance; the bulk of the people consisted of free families who were at liberty to dispose of themselves and their goods. Every fellah and townsman in the service of the king, or of one of his great nobles, could leave his work and his village when he pleased, could pass from the domain in which he was born into a different one, and could traverse the country from one end to the other, as the Egyptians of to-day still do.

His absence entailed neither loss of goods, nor persecution of the relatives he left behind, and he himself had punishment to fear only when he left the Nile Valley without permission, to reside for some time in a foreign land.¹ But although this independence and liberty were in accordance with the laws and customs of the land, yet they gave rise to inconveniences from which it was difficult to escape in practical life. Every Egyptian, the King excepted, was obliged, in order to get on in life, to depend on one more powerful than himself, whom he called his master. The feudal lord was proud to recognize Pharaoh as his master, and he himself was master of the soldiers and priests in his own petty state.² From the top to the bottom of the social scale every free man acknowledged a master, who secured

¹ The treaty between Ramses and the Prince of Khiti contains a formal extradition clause in reference to Egyptians or Hittites, who had quitted their native country, of course without the permission of their sovereign. The two contracting parties expressly stipulate that persons extradited on one side or the other shall not be punished for having emigrated, that their property is not to be confiscated, nor are their families to be held responsible for their flight. From this clause it follows that in ordinary times unauthorized emigration brought upon the culprit corporal punishment and the confiscation of his goods, as well as various penalties on his family. The way in which Sinûhit makes excuses for his flight, the fact of his asking pardon before returning to Egypt, the very terms of the letter in which the king recalls him and assures him of impunity, show us that the laws against emigration were in full force under the XIIth dynasty.

² The expressions which bear witness to this fact are very numerous: MIRI NĪBŪF = "He who loves his master;" AQŪ HĀĪTI NI NĪBŪF = "He who enters into the heart of his master," etc. They recur so frequently in the texts in the case of persons of all ranks, that it was thought no importance ought to be attached to them. But the constant repetition of the word NĪB, "master," shows that we must alter this view, and give these phrases their full meaning.

to him justice and protection in exchange for his obedience and fealty. The moment an Egyptian tried to withdraw himself from this subjection, the peace of his life was at an end; he became a man without a master, and therefore without a recognized protector.¹ Any one might stop him on the way, steal his cattle, merchandise, or property on the most trivial pretext, and if he attempted to protest, might beat him with almost certain impunity. The only resource of the victim was to



WAR-DANCE PERFORMED BY EGYPTIAN SOLDIERS BEFORE A BATTLE.²

sit at the gate of the palace, waiting to appeal for justice till the lord or the king should appear. If by chance, after many rebuffs, his humble petition were granted, it was only the beginning of fresh troubles. Even if the justice of the cause were indisputable, the fact that he was a man without

¹ The expression, "a man without a master," occurs several times in the *Berlin Papyrus*, No. ii. For instance, the peasant who is the hero of the story, says of the lord Mirûitensi, that he is "the rudder of heaven, the guide of the earth, the balance which carries the offerings, the buttress of tottering walls, the support of that which falls, *the great master who takes whoever is without a master* to lavish on him the goods of his house, a jug of beer and three loaves" each day.

² Drawn by Faucher-Gudin, from the tomb of Khiti at Beni-Hasan. These are soldiers of the nome of Gazelle.

home or master inspired his judges with an obstinate mistrust, and delayed the satisfaction of his claims. In vain he followed his judges with his complaints and flatteries, chanting their virtues in every key: "Thou art the father of the unfortunate, the husband of the widow, the brother of the orphan, the clothing of the motherless: enable me to proclaim thy name as a law throughout the land. Good lord, guide without caprice, great without littleness, thou who destroyest falsehood and causest truth to be, come at the words of my mouth; I speak, listen and do justice. O generous one, generous of the generous, destroy the cause of my trouble; here I am, uplift me; judge me, for behold me a suppliant before thee." If he were an eloquent speaker and the judge were inclined to listen, he was willingly heard, but his cause made no progress, and delays, counted on by his adversary, effected his ruin. The religious law, no doubt, prescribed equitable treatment for all devotees of Osiris, and condemned the slightest departure from justice as one of the gravest sins, even in the case of a great noble, or in that of the king himself; but how could impartiality be shown when the one was the recognized protector, the "master" of the culprit, while the plaintiff was a vagabond, attached to no one, "a man without a master"!

The population of the towns included many privileged persons other than the soldiers, priests, or those engaged in the service of the temples. Those employed in royal or feudal administration, from the "superintendent of the storehouse" to the humblest scribe, though perhaps not entirely exempt from forced labour, had but a small part of

it to bear.¹ These *employés* constituted a middle class of several grades, and enjoyed a fixed income and regular employment: they were fairly well educated, very self-satisfied, and always ready to declare loudly their superiority over any who were obliged to gain their living by manual labour. Each class of workmen recognized one or more chiefs,—the shoemakers, their master-shoemakers, the masons, their master-masons, the blacksmiths, their master-blacksmiths,—who looked after their interests and represented them before the local authorities.² It was said among the Greeks, that even robbers were united in a corporation like the others, and maintained an accredited superior as their representative with the police, to discuss the somewhat delicate questions which the practice of their trade gave occasion to. When the members of the association had stolen any object of value, it was to this superior that the person robbed resorted, in order to regain possession of it: it was he who fixed the amount required for its redemption, and returned it without fail, upon the payment of this sum. Most of the workmen who formed a

¹ This is a fair inference from the indirect testimony of the Letters: the writer, in enumerating the liabilities of the various professions, implies by contrast that the scribe (*i.e.* the *employé* in general) is not subject to them, or is subject to a less onerous share of them than others. The beginning and end of the instructions of Khiti would in themselves be sufficient to show us the advantages which the middle classes under the XIIth dynasty believed they could derive from adopting the profession of scribe.

² The stelæ of Abydos are very useful to those who desire to study the populations of a small town. They give us the names of the head-men of trades of all kinds; the head-mason Didiû, the master-mason Aa, the master-shoemaker Kahikhonti, the head-smiths Ûsirtasen-Ûati, Hotpû, Hotpûrekhsû.

state corporation, lodged, or at least all of them had their stalls, in the same quarter or street, under the direction of their chief. Besides the poll and the house tax, they were subject to a special toll, a trade licence which they paid in products of their commerce or industry.¹ Their lot was a hard one, if we are to believe the description which ancient writers have handed down to us: "I have never seen a



TWO BLACKSMITHS WORKING THE BELLOWS.²

blacksmith on an embassy—nor a smelter sent on a mission—but what I have seen is the metal worker at his toil,—at the mouth of the furnace of his forge,—his fingers as

¹ The registers (for the most part unpublished), which are contained in European museums show us that fishermen paid in fish, gardeners in flowers and vegetables, etc., the taxes or tribute which they owed to their lords. In the great inscription of Abydos the weavers attached to the temple of Seti I. are stated to have paid their tribute in stuffs.

² Drawn by Faucher-Gudin, from ROSELLINI, *Monumenti Civili*, pl. 2 a.

rugged as the crocodile,—and stinking more than fish-spawn.—The artisan of any kind who handles the chisel,—does not employ so much movement as he who handles the hoe;¹—but for him his fields are the timber, his business is the metal,—and at night when the other is free,—he, he

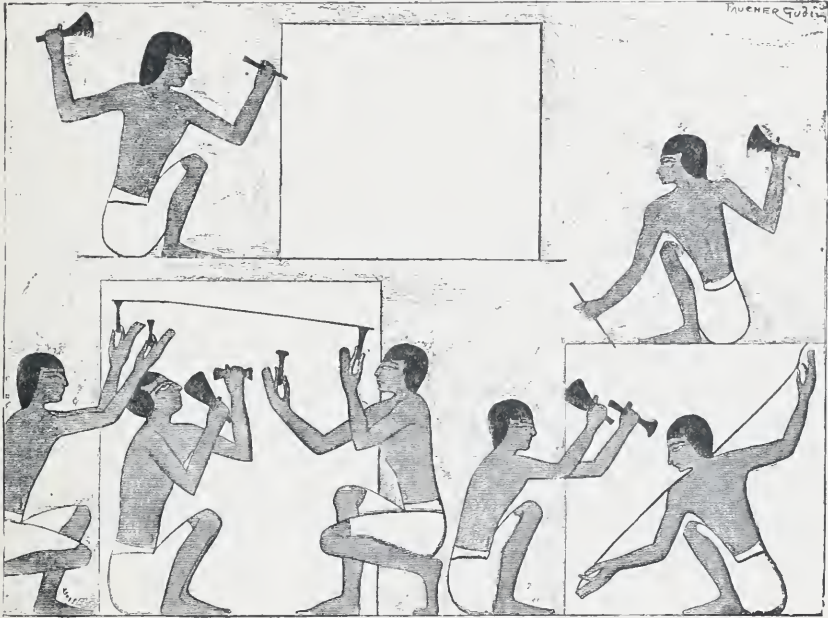

STONE-CUTTERS FINISHING THE DRESSING OF LIMESTONE BLOCKS.²

works with his hands over and above what he has already done,—for at night, he works at home by the lamp.—The stone-cutter who seeks his living by working in all kinds of durable stone,—when at last he has earned something—and

¹ The literal translation would be, “The artisan of all kinds who handles the chisel is more motionless than he who handles the hoe.” Both here, and in several other passages of this little satiric poem, I have been obliged to paraphrase the text in order to render it intelligible to the modern reader.

² Drawn by Faucher-Gudin, from ROSELLINI, *Moumenti civili*, pl. xlvi. 2.

his two arms are worn out, he stops;—but if at sunrise he remain sitting,—his legs are tied to his back.¹—The barber who shaves until the evening,—when he falls to and eats, it is without sitting down²—while running from street to street to seek custom;—if he is constant [at work] his two arms fill his belly—as the bee eats in proportion to its toil.—Shall I tell thee of the mason—how he endures misery?—Exposed to all the winds—while he builds without any garment but a belt—and while the bunch of lotus-flowers [which is fixed] on the [completed] houses—is still far out of his reach,³—his two arms are worn out with work; his provisions are placed higgledy piggedly amongst his refuse,—he consumes himself, for he has no other bread than his fingers—and he becomes wearied all at once.—He is much and dreadfully exhausted—for there is [always] a block [to be dragged] in this or that building,—a block of ten cubits by six,—there is [always] a block [to be dragged] in this or that month [as far as the] scaffolding poles [to which is fixed] the bunch of lotus-flowers on the [completed] houses.—When the work is quite finished,—if

¹ This is an allusion to the cruel manner in which the Egyptians were accustomed to bind their prisoners, as it were in a bundle, with the legs bent backward along the back and attached to the arms. The working-day commenced then, as now, at sunrise, and lasted till sunset, with a short interval of one or two hours at midday for the workmen's dinner and siesta.

² Literally, "He places himself on his elbow." The metaphor seems to me to be taken from the practice of the trade itself: the barber keeps his elbow raised when shaving and lowers it when he is eating.

³ This passage is conjecturally translated. I suppose the Egyptian masons had a custom analogous to that of our own, and attached a bunch of lotus to the highest part of a building they had just finished: nothing, however, has come to light to confirm this conjecture.

he has bread, he returns home,—and his children have been beaten unmercifully [during his absence].—The weaver within doors is worse off there than a woman ;—squatting, his knees against his chest,—he does not breathe.—If during the day he slackens weaving,—he is bound fast as the lotuses of the lake ;—and it is by giving bread to the doorkeeper, that the latter permits him to see the light.—The dyer, his fingers reeking—and their smell is that of fish-spawn ;—his two eyes are oppressed with fatigue,—his



A WORKSHOP OF SHOEMAKERS MANUFACTURING SANDALS.¹

hand does not stop,—and, as he spends his time in cutting out rags—he has a hatred of garments.—The shoemaker is very unfortunate ;—he moans ceaselessly,—his health is the health of the spawning fish,—and he gnaws the leather.—The baker makes dough,—subjects the loaves to the fire ;—while his head is inside the oven,—his son holds him by the

¹ Drawn by Faucher-Gudin, from CHAMPOLLION'S *Monuments de l'Égypte et de la Nubie*. This picture belongs to the XVIIIth dynasty ; but the sandals figured in it are, however, quite like those to be seen on more ancient monuments.

legs ;—if he slips from the hands of his son,—he falls there into the flames.” These are the miseries inherent to the trades themselves: the levying of the tax added to the catalogue a long sequel of vexations and annoyances, which were renewed several times in the year at regular intervals. Even at the present day, the fellah does not pay his contributions except under protest and by compulsion,

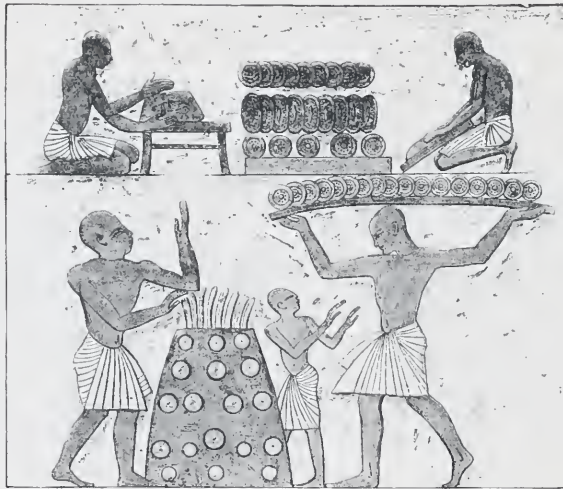

THE BAKER MAKING HIS BREAD AND PLACING IT IN THE OVEN.¹

but the determination not to meet obligations except beneath the stick, was proverbial from ancient times: whoever paid his dues before he had received a merciless beating would be overwhelmed with reproaches by his family, and jeered at without pity by his neighbours. The time when the tax fell due, came upon the nomes as a terrible crisis which affected the whole population. For

¹ Drawn by Faucher-Gudin, from the painted picture in one of the small antechambers of the tomb of Ramses III., at Bab-el-Molûk.

several days there was nothing to be heard but protestations, threats, beating, cries of pain from the tax-payers, and piercing lamentations from women and children. The performance over, calm was re-established, and the good people, binding up their wounds, resumed their round of daily life until the next tax-gathering.

The towns of this period presented nearly the same



THE HOUSE OF A GREAT EGYPTIAN LORD.¹

confined and mysterious appearance as those of the present day.² They were grouped around one or more temples,

¹ Drawn by Faucher-Gudin, from a water-colour by BOUSSAC, *Le Tombeau d'Anna* in the *Mémoires de la Mission Française*. The house was situated at Thebes, and belonged to the XVIIIth dynasty. The remains of the houses brought to light by Mariette at Abydos belong to the same type, and date back to the XIIth dynasty. By means of these, Mariette was enabled to reconstruct an ancient Egyptian house at the Paris Exhibition of 1877. The picture of the tomb of Anna reproduces in most respects, we may therefore assume, the appearance of a nobleman's dwelling at all periods. At the side of the main building we see two corn granaries with conical roofs, and a great storehouse for provisions.

² I have had occasion to make "soundings" or excavations at various points in very ancient towns and villages, at Thebes, Abydos and Mataniyeh, and I give here a *résumé* of my observations. Professor Petrie has brought to light and regularly explored several cities of the XIIth and XVIIIth dynasties, situated at the entrance to the Fayûm. I have borrowed many points in my description from the various works which he has published on

each of which was surrounded by its own brick enclosing wall, with its enormous gateways: the gods dwelt there in real castles, or, if this word appears too ambitious, redouts, in which the population could take refuge in cases of sudden attack, and where they could be in safety. The towns, which had all been built at one period by some king or prince, were on a tolerably regular ground

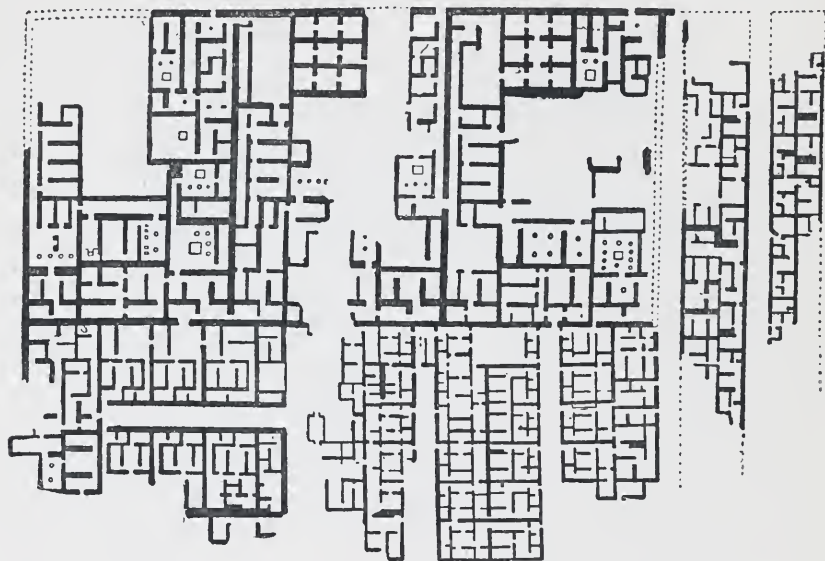

PLAN OF A PART OF THE ANCIENT TOWN OF KAHUN.¹

plan; the streets were paved and fairly wide; they crossed each other at right angles, and were bordered with buildings on the same line of frontage. The cities of ancient origin, which had increased with the chance

the subject, *Kahun, Gurob and Hawara*, 1890; and *Illahun, Kahun and Gurob*, 1891.

¹ From a plan made and published by Professor FLINDERS PETRIE, *Illahun, Kahun and Gurob*, pl. xiv.

growth of centuries, presented a totally different aspect. A network of lanes and blind alleys, narrow, dark, damp, and badly built, spread itself out between the houses, apparently at random: here and there was an arm of a canal, all but dried up, or a muddy pool where the cattle came to drink, and from which the women fetched

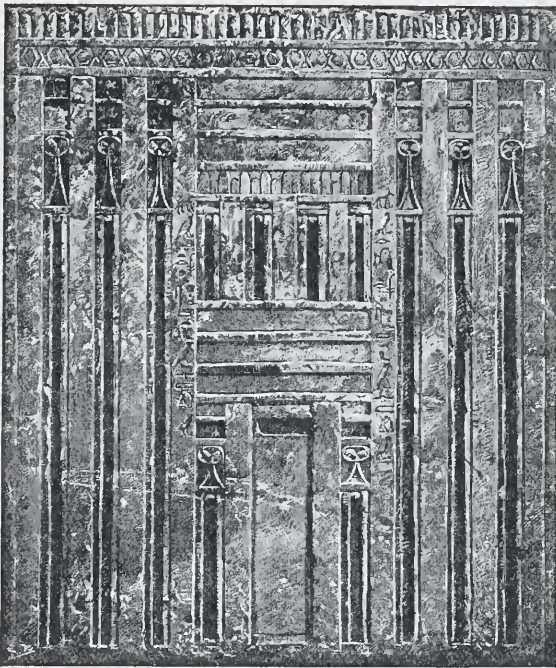

STELE OF SÎTÛ, REPRESENTING THE FRONT OF A HOUSE.¹

the water for their households; then followed an open space of irregular shape, shaded by acacias or sycamores, where the country-folk of the suburbs held their market on certain days, twice or thrice a month; then came

¹ Drawn by Boudier, from a photograph by Émil Brugsch-Bey. The monument is the stele of Sîtû (IVth dynasty), in the Gîzeh Museum.

waste ground covered with filth and refuse, over which the dogs of the neighbourhood fought with hawks and vultures. The residence of the prince or royal governor, and the houses of rich private persons, covered a considerable area, and generally presented to the street a long extent of bare walls, crenellated like those of a fortress: the only ornament admitted on them consisted of angular

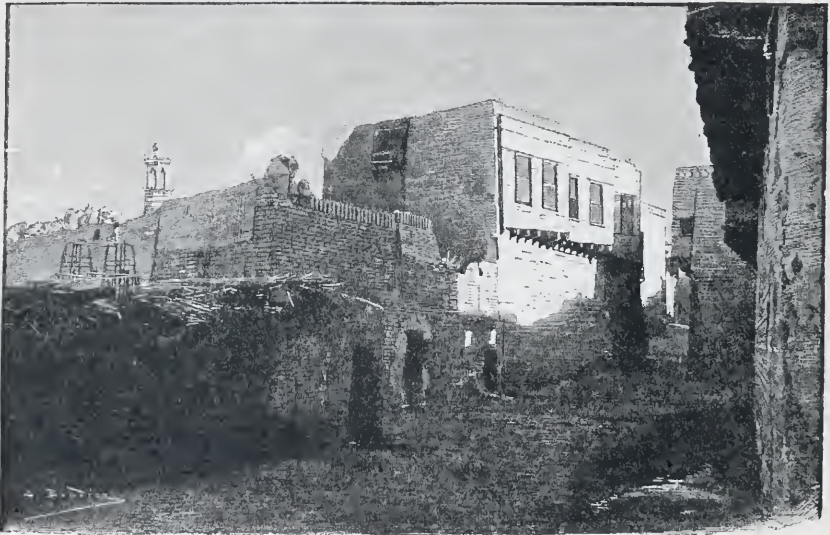

A STREET IN THE HIGHER QUARTER OF MODERN SIÛT.¹

grooves, each surmounted by two open lotus flowers having their stems intertwined. Within these walls domestic life was entirely secluded, and as it were confined to its own resources; the pleasure of watching passers-by was sacrificed to the advantage of not being seen from outside. The entrance alone denoted at times

¹ Drawn by Boudier, from a photograph, taken in 1884, by Émil Brugsch-Bey.

the importance of the great man who concealed himself within the enclosure. Two or three steps led up to the door, which sometimes had a columned portico, ornamented with statues, lending an air of importance to the building. The houses of the citizens were small, and built of brick; they contained, however, some half-dozen rooms, either vaulted, or having flat roofs, and communicating with each other usually by arched doorways.

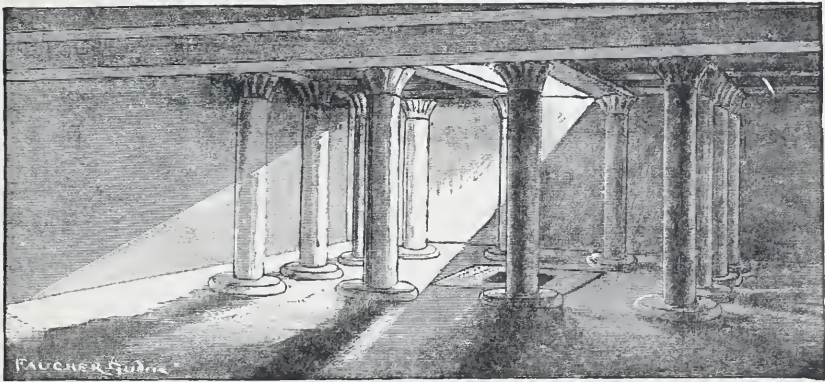

A HALL WITH COLUMNS IN ONE OF THE XIIth DYNASTY HOUSES AT GUROB.¹

A few houses boasted of two or three stories; all possessed a terrace, on which the Egyptians of old, like those of to-day, passed most of their time, attending to household cares or gossiping with their neighbours over the party wall or across the street. The hearth was hollowed out in the ground, usually against a wall, and the smoke escaped through a hole in the ceiling: they made their fires of sticks, wood charcoal, and the dung of oxen and asses. In the houses of the rich we meet with state

¹ Drawn by Faucher-Gudin, from a sketch by Professor PETRIE, *Illahun, Kahun and Gurob*, pl. xvi. 3.

apartments, lighted in the centre by a square opening, and supported by rows of wooden columns; the shafts, which were octagonal, measured ten inches in diameter, and were fixed into flat circular stone bases.

The family crowded themselves together into two or three rooms in winter, and slept on the roof in the open air in summer, in spite of risk from affections of the stomach and eyes; the remainder of the dwelling was used for stables or warehouses. The store-chambers were often built in pairs; they were of brick, carefully limewashed internally, and usually assumed the form of an elongated cone, in imitation of the Government storehouses. For the valuables

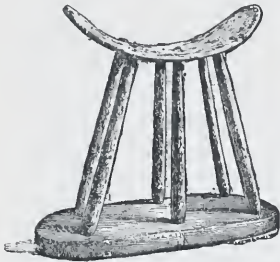
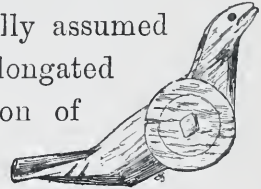
WOODEN HEAD-REST.¹PIGEON ON WHEELS.²

which constituted the wealth of each household—wedges of gold or silver, precious stones, ornaments for men or women—there were places of concealment, in which the possessors attempted to hide them from robbers or from the tax-collectors. But the latter, accustomed to the craft of the citizens, evinced a peculiar aptitude for ferreting out the hoard: they tapped the walls, lifted and pierced the roofs, dug down into the soil below the foundations, and

¹ Drawn by Faucher-Gudin, from a head-rest in my possession obtained at Gebelên (XIth dynasty): the foot of the head-rest is usually solid, and cut out of a single piece of wood.

² Drawn by Faucher-Gudin, from a sketch by PETRIE, *Hawara, Biahmu, and Arsinoe*, pl. xiii. 21. The original, of rough wood, is now in the Ashmolean Museum at Oxford.

often brought to light, not only the treasure of the owner, but all the surroundings of the grave and human corruption. It was actually the custom, among the lower and middle classes, to bury in the middle of the house children who had died at the breast. The little body was placed in

an old tool or linen box, without any attempt at embalming, and its favourite playthings and amulets were buried with it: two or three infants are often found occupying the same coffin.

The playthings were of an artless but very varied character; dolls of limestone, enamelled pottery or wood, with movable arms and wigs of artificial hair; pigs, crocodiles, ducks, and pigeons on wheels,

pottery boats, miniature sets of household furniture, skin balls filled with hay, marbles, and stone bowls. However

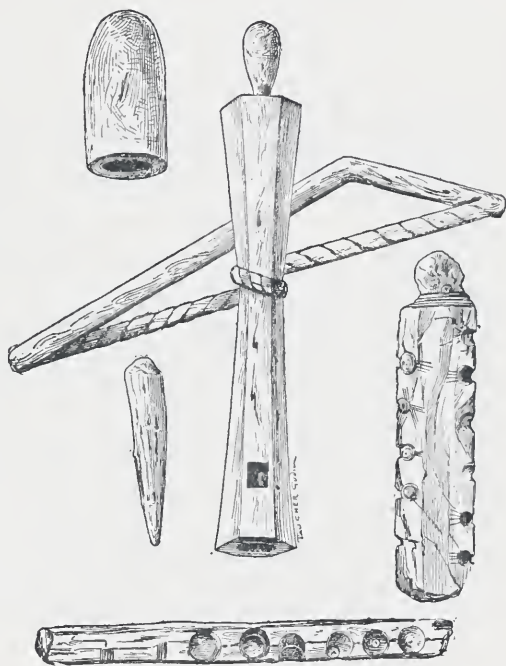

APPARATUS FOR STRIKING A LIGHT.¹

¹ Drawn by Faucher-Gudin, from a sketch published in FL. PETRIE, *Illahun, Kahun and Gurob*, pl. vii. The bow is represented in the centre; on the left, at the top, is the nut; below it the fire-stick, which was attached to the end of the stock; at the bottom and right, two pieces of wood with round carbonized holes, which took fire from the friction of the rapidly rotating stick.

strange it may appear, we have to fancy the small boys of ancient Egypt as playing at bowls like ours, or impudently whipping their tops along the streets without respect for the legs of the passers-by.

Some care was employed upon the decoration of the chambers. The rough-casting of mud often preserves its original grey colour; sometimes, however, it was



MURAL PAINTINGS IN THE RUINS OF AN ANCIENT HOUSE AT KAHUN.¹

limewashed, and coloured red or yellow, or decorated with pictures of jars, provisions, and the interiors as well as the exteriors of houses. The bed was not on legs, but consisted of a low framework, like the “angarebs” of the modern Nubians, or of mats which were folded up in the daytime, but upon which they lay in their

¹ Drawn by Faucher-Gudin, from the facsimile in PETRIE'S *Illahun, Kahun and Gurob*, pl. xvi. 6.

clothes during the night, the head being supported by a head-rest of pottery, limestone, or wood: the remaining articles of furniture consisted of one or two roughly hewn seats of stone, a few lion-legged chairs or stools, boxes and trunks of varying sizes for linen and implements, kohl, or perfume, pots of ababaster or porcelain, and lastly, the fire-stick with the bow by which it was set in



WOMAN GRINDING GRAIN.¹

motion, and some roughly made pots and pans of clay or bronze. Men rarely entered their houses except to eat and sleep; their employments or handicrafts were such as to require them for the most part to work out-of-doors. The middle-class families owned, almost always, one or two slaves—either purchased or born in the house—who

¹ Drawn by Boudier, from a photograph by Béchard (cf. MARIETTE, *Album photographique du Musée de Boulaq*, pl. 20; MASPERO, *Guide du Visiteur*, p. 220, Nos. 1012, 1013).

did all the hard work: they looked after the cattle, watched over the children, acted as cooks, and fetched water from the nearest pool or well. Among the poor the drudgery of the household fell entirely upon the woman. She spun, wove, cut out and mended garments, fetched fresh water and provisions, cooked the dinner, and made the daily bread. She spread some handfuls of grain upon an oblong slab of stone, slightly hollowed on its upper surface, and proceeded to crush them with a smaller stone like a painter's muller, which she moistened from time to time. For an hour and more she laboured with her arms, shoulders, loins, in fact, all her body; but an indifferent result followed from the great exertion. The flour, made to undergo several grindings in this rustic mortar, was coarse, uneven, mixed with bran, or whole grains, which had escaped the pestle, and contaminated with dust and abraded particles of the stone. She kneaded it with a little water, blended with it, as a sort of yeast, a piece of stale dough of the day before, and made from the mass round cakes, about half an inch thick and some four inches in diameter, which she placed upon a flat flint, covering them with hot ashes. The bread, imperfectly raised, often badly cooked, borrowed, from the organic fuel under which it was buried, a special odour, and a taste to which strangers did not readily accustom themselves. The impurities which it contained were sufficient in the long run to ruin the strongest teeth; eating it was an action of grinding rather than chewing, and old men were not unfrequently met with whose teeth had been gradually

worn away to the level of the gums, like those of an aged ass or ox.¹

Movement and animation were not lacking at certain hours of the day, particularly during the morning, in the markets and in the neighbourhood of the temples and government buildings: there was but little traffic anywhere else; the streets were silent, and the town dull and sleepy. It woke up completely only three or four times a year, at seasons of solemn assemblies "of heaven and earth:" the houses were then opened and their inhabitants streamed forth, the lively crowd thronging the squares and crossways. To begin with, there was New Year's Day, quickly followed by the Festival of the Dead, the "Ûagaît." On the night of the 17th of Thot, the priests kindled before the statues in the sanctuaries and sepulchral chapels, the fire for the use of the gods and doubles during the twelve ensuing months. Almost at the same moment the whole country was lit up from one end to the other: there was scarcely a family, however poor, who did not place in front of their door a new lamp in which burned an oil saturated with salt, and who did not spend the whole night in feasting and gossiping.² The festivals of the living gods

¹ The description of the woman grinding grain and kneading dough is founded on statues in the Gîzeh Museum. All the European museums possess numerous specimens of the bread in question, and the effect which it produces in the long run on the teeth of those who habitually used it as an article of diet, has been observed in mummies of the most important personages.

² The night of the 17th Thot—which, according to our computation, would be the night of the 16th to the 17th—was, as may be seen from the Great Inscription of Siût, appointed for the ceremony of "lighting the fire" before the statues of the dead and of the gods. As at the "Feast of Lamps"

attracted considerable crowds, who came not only from the nearest nomes, but also from great distances in caravans and in boats laden with merchandise, for religious senti-

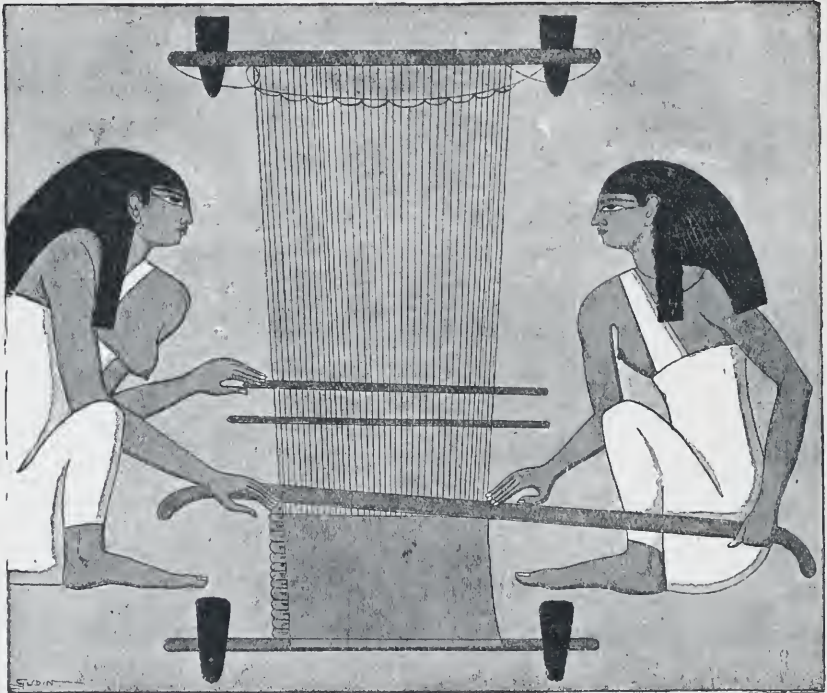

TWO WOMEN WEAVING LINEN AT A HORIZONTAL LOOM.¹

ment did not exclude commercial interests, and the pilgrimage ended in a fair. For several days the people occupied

mentioned by Herodotus, the religious ceremony was accompanied by a general illumination which lasted all the night; the object of this, probably, was to facilitate the visit which the souls of the dead were supposed to pay at this time to the family residence.

¹ Drawn by Faucher-Gudin, from a picture on the tomb of Khnûm-hotpû at Beni-Hasan. This is the loom which was reconstructed in 1889 for the Paris Exhibition, and which is now to be seen in the galleries of the Trocadero.

themselves solely in prayers, sacrifices, and processions, in which the faithful, clad in white, with palms in their hands, chanted hymns as they escorted the priests on their way. "The gods of heaven exclaim 'Ah! ah!' in satisfaction, the inhabitants of the earth are full of gladness, the Hâthors beat their tabors, the great ladies wave their mystic whips, all those who are gathered together in the town are drunk with wine and crowned with flowers; the tradespeople of the place walk joyously about, their heads scented with perfumed oils, all the children rejoice in honour of the goddess, from the rising to the setting of the sun."¹ The nights were as noisy as the days: for a few hours, they made up energetically for long months of torpor and monotonous existence. The god having re-entered the temple and the pilgrims taken their departure, the regular routine was resumed and dragged on its tedious course, interrupted only by the weekly market. At an early hour on that day, the peasant folk came in from the surrounding country in an interminable stream, and installed themselves in some open space, reserved from time immemorial for their use. The sheep, geese, goats, and large-horned cattle were grouped in the centre, awaiting purchasers. Market-gardeners, fishermen, fowlers and gazelle-hunters, potters, and small tradesmen, squatted on the roadsides or against the houses, and offered their wares for the inspection of their customers, heaped up in reed baskets, or piled on

¹ The people of Dendera crudely enough called this the "Feast of Drunkenness." From what we know of the earlier epochs, we are justified in making this description a general one, and in applying it, as I have done here, to the festivals of other towns besides Dendera.

low round tables: vegetables and fruits, loaves or cakes baked during the night, meat either raw or cooked in various ways, stuffs, perfumes, ornaments, — all the necessities and luxuries of daily life. It was a good opportunity for the workpeople, as well as for the townsfolk, to lay in a store of provisions at a cheaper rate than from the ordinary shops; and they took advantage of it, each according to his means.

Business was mostly carried on by barter. The purchasers brought with them some product of their toil—a new tool, a pair of shoes, a reed mat, pots of unguents or cordials; often, too, rows of cowries and a small box full of rings, each weighing a “tabnû,” made of copper, silver, or even gold, all destined to be bartered for such things as they needed. When it came to be a question of some large animal or of objects of considerable value, the discussions which arose were keen and stormy: it was necessary to be agreed not only as to the amount, but as to the nature of the payment to be made, and to draw up a sort of invoice, or in fact an inventory, in which beds, sticks, honey, oil, pick-axes, and garments, all figure as equivalents for a bull or a she-ass. Smaller retail bargains did not demand so many or such complicated calculations. Two townsfolk stop for a moment in front of a fellah who offers onions and corn in a basket for sale. The first appears to possess no other circulating medium than two necklaces made of glass beads or many-coloured enamelled terra-cotta; the other flourishes about a circular fan with a wooden handle, and one of those triangular contrivances used by cooks for blowing up the fire. “Here is a fine necklace which will

suit you," cries the former, "it is just what you are wanting;" while the other breaks in with: "Here is a fan and a ventilator." The fellah, however, does not let himself be disconcerted by this double attack, and proceeding methodically, he takes one of the necklaces to examine it at his leisure: "Give it to me to look at, that I may fix the price." The one asks too much, the other offers too little; after many concessions, they at last come to an agreement, and settle on the number of onions or the quantity of grain which corresponds exactly with the value of the necklace or the fan. A little further on, a customer wishes to get some perfumes in exchange for a pair of sandals, and conscientiously praises his wares: "Here," says he, "is a strong pair of shoes." But the merchant has no wish to be shod just then, and demands a row of cowries for his little pots: "You have merely to take a few drops of this to see how delicious it is," he urges in a persuasive tone. A seated customer has two jars thrust under his nose by a woman—they probably contain some kind of unguent: "Here is something which smells good enough to tempt you." Behind this group two men are discussing the relative merits of a bracelet and a bundle of fish-hooks; a woman, with a small box in her hand, is having an argument with a merchant selling necklaces; another woman seeks to obtain a reduction in the price of a fish which is being scraped in front of her. Exchanging commodities for metal necessitated two or three operations not required in ordinary barter. The rings or thin bent strips of metal which formed the "tabnû" and its multiples,¹ did not

¹ The rings of gold in the Museum at Leyden, which were used as a basis

always contain the regulation amount of gold or silver, and were often of light weight. They had to be weighed at

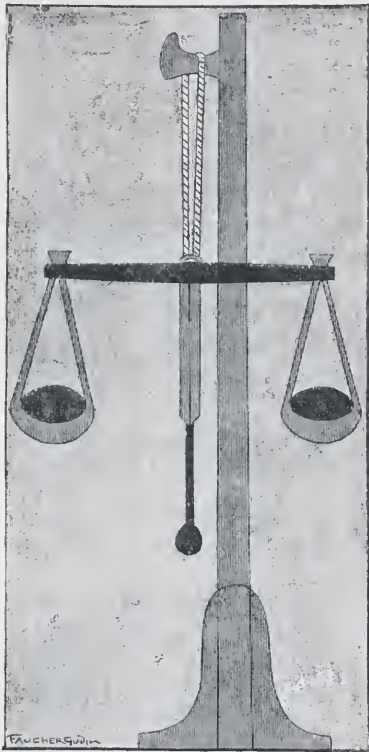

ONE OF THE FORMS OF EGYPTIAN SCALES.²

every fresh transaction in order to estimate their true value, and the interested parties never missed this excellent opportunity for a heated discussion: after having declared for a quarter of an hour that the scales were out of order, that the weighing had been carelessly performed, and that it should be done over again, they at last came to terms, exhausted with wrangling, and then went their way fairly satisfied with one another.¹ It sometimes happened that a clever and unscrupulous dealer would alloy the rings, and mix with the

precious metal as much of a

of exchange, are made on the Chaldæo-Babylonian pattern, and belong to the Asiatic system. We must, perhaps, agree with Fr. Lenormant, in his conclusion that the only kind of national metal of exchange in use in Egypt was a copper wire or plate bent thus $\infty \infty$, this being the sign invariably used in the hieroglyphics in writing the word *tabni*.

¹ The weighing of rings is often represented on the monuments from the XVIIIth dynasty onwards. I am not acquainted with any instance of this on the bas-reliefs of the Ancient Empire. The giving of false weight is alluded to in the paragraph in the "Negative Confession," in which the dead man declares that he has not interfered with the beam of the scales (cf. vol. i. p. 271).

² Drawn by Faucher-Gudin, after a sketch by ROSELLINI, *Monumenti*

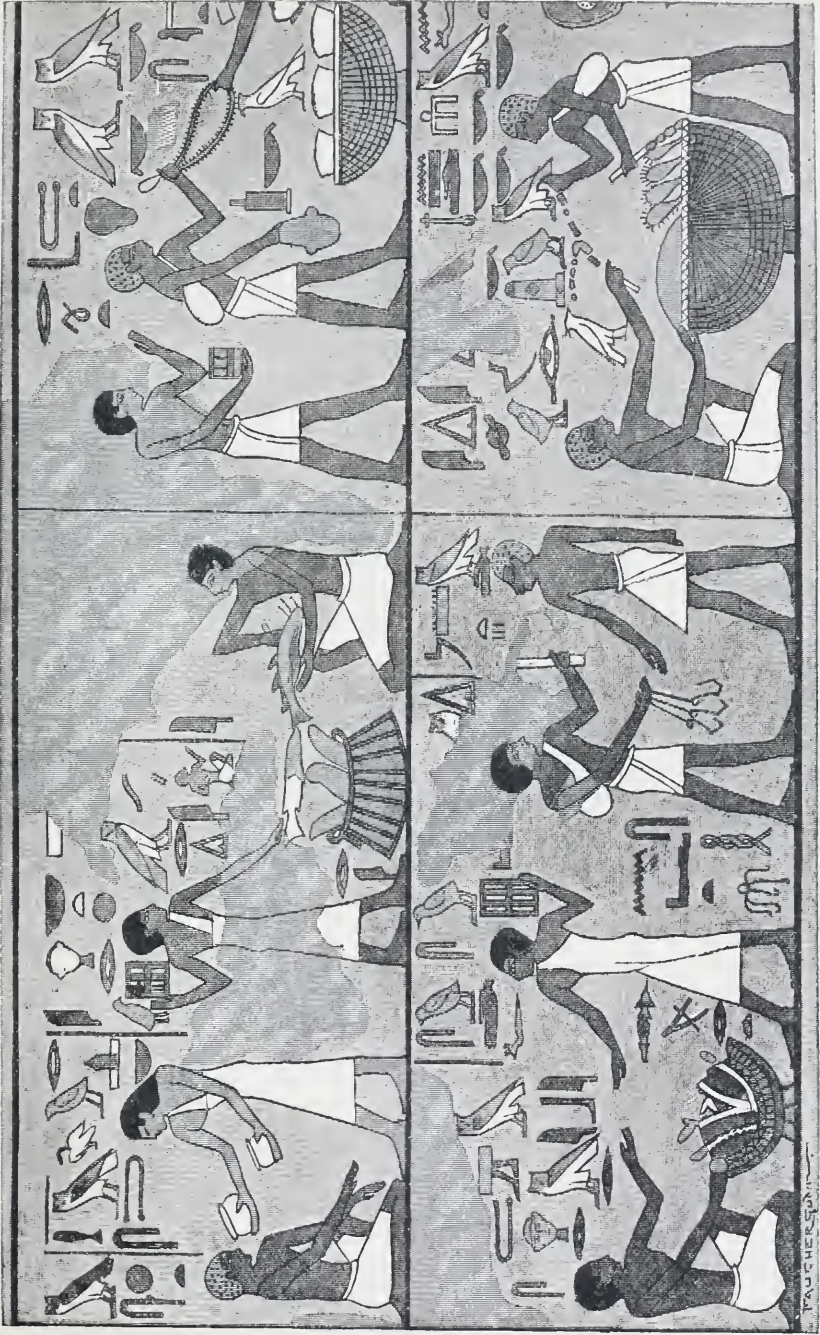

SCENES IN A BAZAAR.
Drawn by Faucher-Gudin, from a chromolithograph by Lerstus. *Denkm.*, ii, 96.

baser sort as would be possible without danger of detection. The honest merchant who thought he was receiving in payment for some article, say eight tabnû of fine gold, and who had handed to him eight tabnû of some alloy resembling gold, but containing one-third of silver, lost in a single transaction, without suspecting it, almost one-third of his goods. The fear of such counterfeits was instrumental in restraining the use of tabnû for a long time among the people, and restricted the buying and selling in the markets to exchange in natural products or manufactured objects.

The present rural population of Egypt scarcely ever live in isolated and scattered farms; they are almost all concentrated in hamlets and villages of considerable extent, divided into quarters often at some distance from each other. The same state of things existed in ancient times, and those who would realize what a village in the past was like, have only to visit any one of the modern market towns scattered at intervals along the valley of the Nile:—half a dozen fairly built houses, inhabited by the principal people of the place; groups of brick or clay cottages thatched with durra stalks, so low that a man standing upright almost touches the roof with his head; courtyards filled with tall circular mud-built sheds, in which the corn and durra for the household is carefully stored, and wherever we turn, pigeons, ducks, geese, and animals all

civili, pl. lii. 1. As to the construction of the Egyptian scales, and the working of their various parts, see FLINDERS PETRIE'S remarks in *A Season in Egypt*, p. 42, and the drawings which he has brought together on pl. xx. of the same work.

living higgledly-piggledly with the family. The majority of the peasantry were of the lower class, but they were not everywhere subjected to the same degree of servitude. The slaves, properly so called, came from other countries; they had been bought from foreign merchants, or they had been seized in a raid and had lost their liberty by the fortune of war.¹ Their master removed them from place to place, sold them, used them as he pleased, pursued them if they succeeded in escaping, and had the right of recapturing them as soon as he received information of their whereabouts. They worked for him under his overseer's orders, receiving no regular wages, and with no hope of recovering their liberty.² Many chose concubines from their own class, or intermarried with the natives and had families: at the end of two or three generations their descendants became assimilated with the indigenous race, and were neither more nor less than actual serfs attached to

¹ The first allusion to prisoners of war brought back to Egypt, is found in the biography of Ūni. The method in which they were distributed among the officers and soldiers is indicated in several inscriptions of the New Empire, in that of Âhmosis Pannekhabit, in that of Âhmosis si-Abina, where one of the inscriptions contains a list of slaves, some of whom are foreigners), in that of Amenembabi. We may form some idea of the number of slaves in Egypt from the fact that in thirty years Ramses III. presented 113,433 of them to the temples alone. The "Directors of the Royal Slaves," at all periods, occupied an important position at the court of the Pharaohs.

² A scene reproduced by Lepsius shows us, about the time of the VIth dynasty, the harvest gathered by the "royal slaves" in concert with the tenants of the dead man. One of the petty princes defeated by the Ethiopian Piônki Miamûn proclaims himself to be "one of the *royal slaves* who pay tribute in kind to the royal treasury." Amten repeatedly mentions slaves of this kind, "sûtiû."

the soil, who were made over or exchanged with it.¹ The landed proprietors, lords, kings, or gods, accommodated this population either in the outbuildings belonging to



PART OF THE MODERN VILLAGE OF KARNAK, TO THE WEST OF THE TEMPLE OF APÏT.²

their residences, or in villages built for the purpose, where everything belonged to them, both houses and people.

¹ This is the status of serfs, or *mirîtiû*, as shown in the texts of every period. They are mentioned along with the fields or cattle attached to a temple or belonging to a noble. Ramses II. granted to the temple of Abydos "an appanage in cultivated lands, in serfs (*mirîtiû*), in cattle." The scribe Anna sees in his tomb "stalls of bulls, of oxen, of calves, of milch cows, as well as serfs, in the mortmain of Amon." Ptolemy I. returned to the temple at Bûto "the domains, the boroughs, the serfs, the tillage, the water supply, the cattle, the geese, the flocks, all the things" which Xerxes had taken away from Kabbisha. The expression passed into the language, as a word used to express the condition of a subject race: "I cause," said Thûtmosis III., "Egypt to be a sovereign (*hirî*) to whom all the earth is a slave" (*mirîtiû*).

² Drawn by Boudier, from a photograph by Beato, taken in 1886.

The condition of the free agricultural labourer was in many respects analogous to that of the modern fellah. Some of them possessed no other property than a mud cabin, just large enough for a man and his wife, and hired themselves out by the day or the year as farm servants. Others were emboldened to lease land from the lord or from a soldier in the neighbourhood. The most fortunate acquired some domain of which they were supposed to receive only the product, the freehold of the property remaining primarily in the hands of the Pharaoh, and secondarily in that of lay or religious feudatories who held it of the sovereign: they could, moreover, bequeath, give, or sell these lands and buy fresh ones without any opposition. They paid, besides the capitation tax, a ground rent proportionate to the extent of their property, and to the kind of land of which it consisted.¹ It was not without reason that all the ancients attributed the invention of geometry to the Egyptians. The perpetual encroachments of the Nile and the displacements it occasioned, the facility with which it effaced the boundaries of the fields, and in one summer modified the whole face of a nome, had forced them from early times to measure with the greatest exactitude the ground to which they owed their sustenance. The territory belonging to each town and nome was subjected to repeated surveys made and co-ordinated by the Royal Administration, thus enabling Pharaoh to know

¹ The capitation tax, the ground rent, and the house duty of the time of the Ptolemies, already existed under the rule of the native Pharaohs. Brugsch has shown that these taxes are mentioned in an inscription of the time of Amenôthes III.

the exact area of his estates. The unit of measurement was the arura; that is to say, a square of a hundred cubits, comprising in round numbers twenty-eight ares.* A considerable staff of scribes and surveyors was continually occupied in verifying the old measurements or in making fresh ones, and in recording in the State registers any changes which might have taken place.¹ Each estate had its boundaries marked out by a line of stelæ which frequently bore the name of the tenant at the time, and the date when the landmarks were last fixed.³ Once set up, the stele received a name which gave it, as it were, a living and independent



A BOUNDARY STELE.²

[* One "are" equals 100 square metres.—Tr.]

¹ We learn from the expressions employed in the great inscription of Beni-Hasan (ll. 13—58, 131—148) that the cadastral survey had existed from the very earliest times; there are references in it to previous surveys. We find a surveying scene on the tomb of Zosirkerisonbû at Thebes, under the XVIIIth dynasty. Two persons are measuring a field of wheat by means of a cord; a third notes down the result of their work.

² Drawn by Faucher-Gudin, from a photograph given by MARIETTE, *Monuments divers*, pl. 47 a. The stele marked the boundary of the estate given to a priest of the Theban Amon by Pharaoh Thûtmosis IV. of the XVIIIth dynasty. The original is now in the Museum at Gizeh.

³ The great inscription of Beni-Hasan tells us of the stelæ which bounded the principality of the Gazelle on the North and South, and of those in the plain which marked the northern boundary of the nome of the

personality. It sometimes recorded the nature of the soil, its situation, or some characteristic which made it remarkable—the “Lake of the South,” the “Eastern Meadow,” the “Green Island,” the “Fisher’s Pool,” the “Willow Plot,” the “Vineyard,” the “Vine Arbour,” the “Sycamore;” sometimes also it bore the name of the first master or the Pharaoh under whom it had been erected—the “Nurse-Phtahhotpû,” the “Verdure-Kheops,” the “Meadow-Didifri,” the “Abundance-Sahûri,” “Khafri-Great-among-the Doubles.” Once given, the name clung to it for centuries, and neither sales, nor redistributions, nor revolutions, nor changes of dynasty, could cause it to be forgotten. The officers of the survey inscribed it in their books, together with the name of the proprietor, those of the owners of adjoining lands, and the area and nature of the ground. They noted down, to within a few cubits, the extent of the sand, marshland, pools, canals, groups of palms, gardens or orchards, vineyards and corn-fields,¹ which it contained. The cornland in its turn was divided into several classes, according to whether it was regularly inundated, or situated above the highest rise of the water, and consequently dependent on a more or less

Jackal; we also possess three other stelæ which were used by Amenôthes IV. to indicate the extreme limits of his new city of Khûtniaton. In addition to the above stele, we also know of two others belonging to the XIIth dynasty which marked the boundaries of a private estate, and which are reproduced, one on plate 106, the other in the text of *Monuments divers*, p. 30; also the stele of Bûhani under Thûtmosis IV.

¹ See in the great inscription of Beni-Hasan the passage in which are enumerated at full length, in a legal document, the constituent parts of the principality of the Gazelle, “its watercourses, its fields, its trees, its sands, from the river to the mountain of the West” (ll. 46-53).

costly system of artificial irrigation. All this was so much information of which the scribes took advantage in regulating the assessment of the land-tax.

Everything tends to make us believe that this tax represented one-tenth of the gross produce, but the amount of the latter varied. It depended on the annual rise of the Nile, and it followed the course of it with almost mathematical exactitude: if there were too much or too little water, it was immediately lessened, and might even be reduced to nothing in extreme cases. The king in his capital and the great lords in their fiefs had set up nilometers, by means of which, in the critical weeks, the height of the rising or subsiding flood was taken daily. Messengers carried the news of it over the country: the people, kept regularly informed of what was happening, soon knew what kind of season to expect, and they could calculate to within very little what they would have to pay. In theory, the collecting of the tax was based on the actual amount of land covered by the water, and the produce of it was constantly varying. In practice it was regulated by taking the average of preceding years, and deducting from that a fixed sum, which was never departed from except in extraordinary circumstances.¹ The year

¹ We know that this was so, in so far as the Roman period is concerned, from a passage in the edict of Tiberius Alexander. The practice was such a natural one, that I have no hesitation in tracing it back to the time of the Ancient Empire; repeatedly condemned as a piece of bad administration, it reappeared continually. At Beni-Hasan, the nomarch Amoni boasts that, "when there had been abundant Niles, and the owners of wheat and barley crops had thriven, he had not increased the rate of the land-tax," which seems to indicate that, so far as he was concerned, he had fixed the tax

would have to be a very bad one before the authorities would lower the ordinary rate: the State in ancient times was not more willing to deduct anything from its revenue than the modern State would be.¹ The payment of taxes was exacted in wheat, durra, beans, and field produce, which were stored in the granaries of the nome. It would seem that the previous deduction of one-tenth of the gross amount of the harvest could not be a heavy burden, and that the wretched fellah ought to have been in a position



THE LEVYING OF THE TAX: THE TAXPAYER IN THE SCRIBE'S OFFICE.²

to pay his dues without difficulty. It was not so, however, and the same writers who have given us such a lamentable picture of the condition of the workmen in the towns, have painted for us in even darker colours the miseries which

on land at a permanent figure, based on the average of good and bad harvests.

¹ The two decrees of Rosetta and of Canopus, however, mention reductions granted by the Ptolemies after an insufficient rise of the Nile.

² Drawn by Faucher-Gudin, from a picture at Beni-Hasan. This picture and those which follow it represent a census in the principality of the Gazelle under the XIIth dynasty as well as the collection of a tax.

overwhelmed the country people. "Dost thou not recall the picture of the farmer, when the tenth of his grain is levied? Worms have destroyed half of the wheat, and the hippopotami have eaten the rest; there are swarms of rats in the fields, the grasshoppers alight there, the cattle devour, the little birds pilfer, and if the farmer lose sight for an instant of what remains upon the ground, it is carried off by robbers; ¹ the thongs, moreover, which bind the iron and the hoe are worn out, and the team has died at the plough. It is then that the scribe steps out of the boat at the landing-place to levy the tithe, and there come the keepers of the doors of the granary with cudgels and the negroes with ribs of palm-leaves, who come crying: 'Come now, corn!' There is none, and they throw the cultivator full length upon the ground; bound, dragged to the canal, they fling him in head first; ² his wife is bound with him, his children are put into chains; the neighbours, in the mean time, leave him and fly to save their grain." One might be tempted to declare that the picture is too dark a one to be true, did one not know from other sources of the brutal ways of filling the treasury which Egypt has retained

¹ This last danger survives even to the present day. During part of the year the fellahin spend the night in their fields; if they did not see to it, their neighbours would not hesitate to come and cut their wheat before the harvest, or root up their vegetables while still immature.

² The same kind of torture is mentioned in the decree of Harmhabi, in which the lawless soldiery are represented as "running from house to house, dealing blows right and left with their sticks, ducking the fellahin head downwards in the water, and not leaving one of them with a whole skin." This treatment was still resorted to in Egypt not long ago, in order to extract money from those taxpayers whom beatings had failed to bring to reason.

even to the present day. In the same way as in the town, the stick facilitated the operations of the tax-collector in the country: it quickly opened the granaries of the rich, it revealed resources to the poor of which he had been ignorant, and it only failed in the case of those who had really nothing to give. Those who were insolvent were not let off even when they had been more than half killed: they and their families were sent to prison, and they had



LEVYING THE TAX: THE TAXPAYER IN THE HANDS OF THE EXACTORS.¹

to work out in forced labour the amount which they had failed to pay in current merchandise.² The collection of the taxes was usually terminated by a rapid revision of the survey. The scribe once more recorded the dimensions and character of the domain lands in order to determine afresh the amount of the tax which should be imposed

¹ Drawn by Faucher-Gudin, from a picture on the tomb of Khiti at Beni-Hasan (cf. CHAMPOLLION, *Monuments de l'Égypte*, pl. cccxc. 4; ROSELLINI, *Monumenti civili*, pl. cxxiv. B).

² This is evident from a passage in the *Sallier Papyrus n° I*, quoted above, in which we see the taxpayer in fetters, dragged out to clean the canals, his whole family, wife and children, accompanying him in bonds.

upon them. It often happened, indeed, that, owing to some freak of the Nile, a tract of ground which had been fertile enough the preceding year would be buried under a gravel bed, or transformed into a marsh. The owners who thus suffered were allowed an equivalent deduction; as for the farmers, no deductions of the burden were permitted in their case, but a tract equalling in value that of the part they had lost was granted to them out of the



LEVYING THE TAX: THE BASTINADO.¹

royal or seignorial domain, and their property was thus made up to its original worth.

What the collection of the taxes had begun was almost always brought to a climax by the *corvées*. However numerous the royal and seignorial slaves might have been, they were insufficient for the cultivation of all the lands of the domains, and a part of Egypt must always have lain fallow, had not the number of workers been augmented by the addition of those who were in the position of freemen.

¹ Drawn by Faucher-Gudin, from a picture on the tomb of Khiti at Beni-Hasan.

This excess of cultivable land was subdivided into portions of equal dimensions, which were distributed among the inhabitants of neighbouring villages by the officers of a "regent" nominated for that purpose. Those dispensed from agricultural service were—the destitute, soldiers on service and their families, certain *employés* of the public works, and servitors of the temple;¹ all other country-folk without exception had to submit to it, and one or more portions were allotted to each, according to his capabilities.² Orders issued at fixed periods called them together, themselves, their servants and their beasts of burden, to dig, sow, keep watch in the fields while the harvest was proceeding, to cut and carry the crops, the whole work being done at their own expense and to the detriment of their own interests.³ As a sort of indemnity, a few allotments were left uncultivated for their benefit; to these they sent their flocks after the

¹ That the scribes, *i.e.* the employés of the royal or princely government, were exempt from enforced labour, is manifest from the contrast drawn by the letter-writers of the Sallier and Anastasi Papyri between themselves and the peasants, or persons belonging to other professions who were liable to it. The circular of Dorion defines the classes of soldiers who were either temporarily or permanently exempt under the Greek kings.

² Several fragments of the Turin papyri contain memoranda of enforced labour performed on behalf of the temples, and of lists of persons liable to be called on for such labour.

³ All these details are set forth in the Ptolemaic period, in the letter to Dorion which refers to a royal edict. As Signor Lumbroso has well remarked, the Ptolemies merely copied exactly the misdeeds of the old native governments. Indeed, we come across frequent allusions to the enforced labour of men and beasts in inscriptions of the Middle Empire at Beni-Hasan or at Siût; many of the pictures on the Memphite tombs show bands of such labourers at work in the fields of the great landowners or of the king.

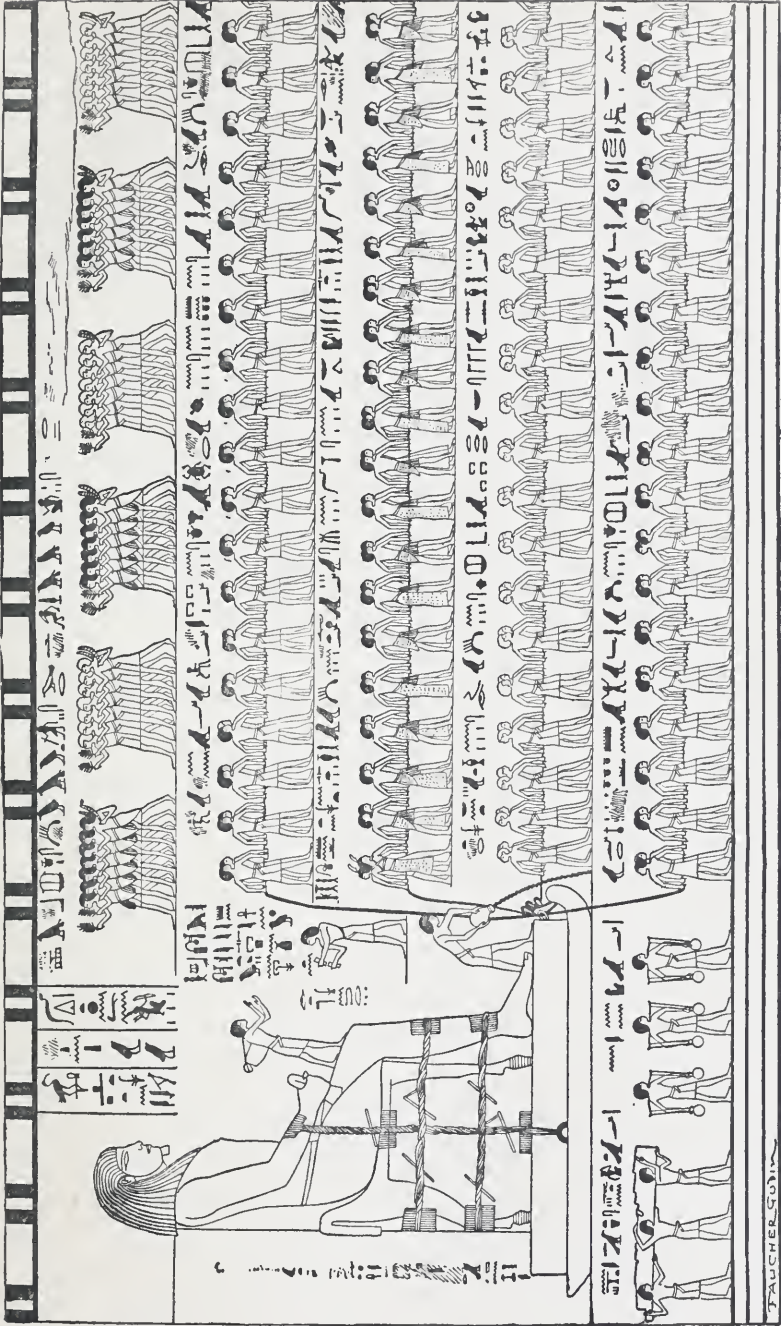

THE COLOSSAL STATUE OF PRINCESS THOTHOTPÛ BEING DRAGGED BY THE CORYCÆ.

Drawn by Faucher-Gudin, from Wilkinson, *A Popular Account of the Manners and Customs of the Ancient Egyptians*, vol. ii., frontispiece.

subsidence of the inundation, for the pasturage on them was so rich that the sheep were doubly productive in wool and offspring. This was a mere apology for a wage: the forced labour for the irrigation brought them no compensation. The dykes which separate the basins, and the network of canals for distributing the water and irrigating the land, demand continual attention: every year some need strengthening, others re-excavating or cleaning out. The men employed in this work pass whole days standing in the water, scraping up the mud with both hands in order to fill the baskets of platted leaves, which boys and girls lift on to their heads and carry to the top of the bank: the semi-liquid contents ooze through the basket, trickle over their faces and soon coat their bodies with a black shining mess, disgusting even to look at. Sheikhs preside over the work, and urge it on with abuse and blows. When the gangs of workmen had toiled all day, with only an interval of two hours about noon for a siesta and a meagre pittance of food, the poor wretches slept on the spot, in the open air, huddled one against another and but ill protected by their rags from the chilly nights. The task was so hard a one, that malefactors, bankrupts, and prisoners of war were condemned to it; it wore out so many hands that the free peasantry were scarcely ever exempt. Having returned to their homes, they were not called until the next year to any established or periodic *corvée*, but many an irregular one came and surprised them in the midst of their work, and forced them to abandon all else to attend to the affairs of king or lord. Was a new chamber to be added to some neighbouring temple, were materials wanted

to strengthen or rebuild some piece of wall which had been undermined by the inundation, orders were issued to the engineers to go and fetch a stated quantity of limestone or sandstone, and the peasants were commanded to assemble at the nearest quarry to cut the blocks from it, and if needful to ship and convey them to their destination. Or perhaps the sovereign had caused a gigantic statue of himself to be carved, and a few hundred men were requisitioned to haul it to the place where he wished it to be set up. The undertaking ended in a gala, and doubtless in a distribution of food and drink: the unfortunate creatures who had been got together to execute the work could not always have felt fitly compensated for the precious time they had lost, by one day of drunkenness and rejoicing.

We may ask if all these *corvées* were equally legal? Even if some of them were illegal, the peasant on whom they fell could not have found the means to escape from them, nor could he have demanded legal reparation for the injury which they caused him. Justice, in Egypt and in the whole Oriental world, necessarily emanates from political authority, and is only one branch of the administration amongst others, in the hands of the lord and his representatives. Professional magistrates were unknown—men brought up to the study of law, whose duty it was to ensure the observance of it, apart from any other calling—but the same men who commanded armies, offered sacrifices, and assessed or received taxes, investigated the disputes of ordinary citizens, or settled the differences which arose between them and the representatives of the

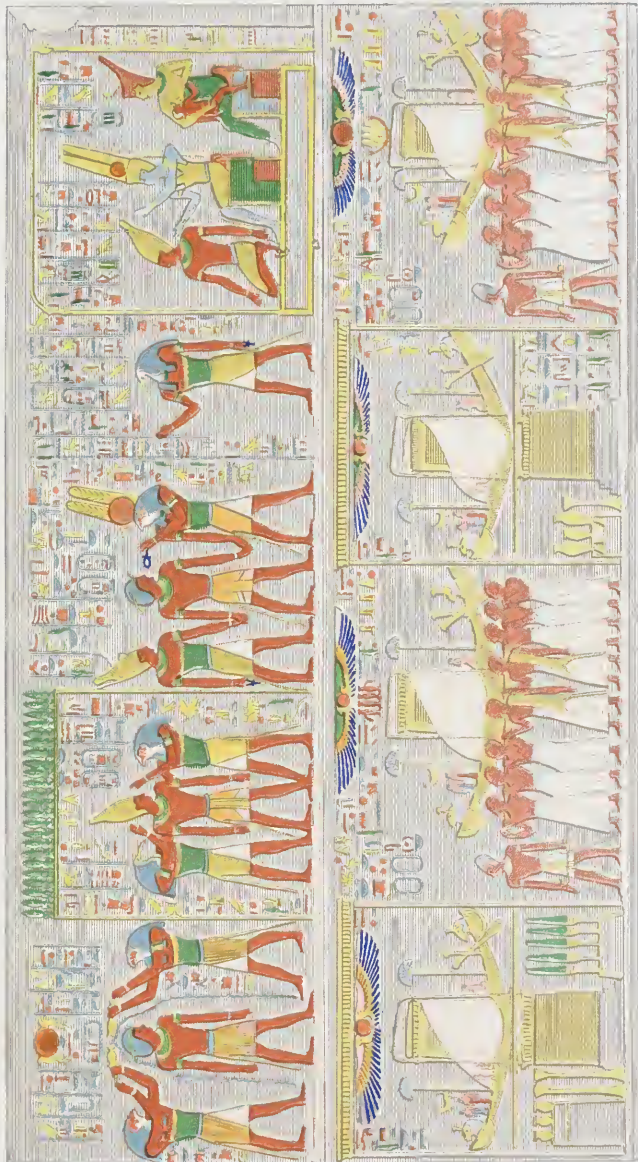

COLORED SCULPTURES IN THE GALLERY OF THE PALACE
AT THEBES.

lords or of the Pharaoh. In every town and village, those who held by birth or favour the position of governor were ex-officio invested with the right of administering justice. For a certain number of days in the month, they sat at the gate of the town or of the building which served as their residence, and all those in the town or neighbourhood possessed of any title, position, or property, the superior priesthood of the temples, scribes who had advanced or grown old in office, those in command of the militia or the police, the heads of divisions or corporations, the "qonbîtiû," the "people of the angle," might if they thought fit take their place beside them, and help them to decide ordinary lawsuits. The police were mostly recruited from foreigners and negroes, or Bedouin belonging to the Nubian tribe of the Mâzaiû. The litigants appeared at the tribunal, and waited under the superintendence of the police until their turn came to speak: the majority of the questions were decided in a few minutes by a judgment by which there was no appeal; only the more serious cases necessitated a cross-examination and prolonged discussion. All else was carried on before this patriarchal jury as in our own courts of justice, except that the inevitable stick too often elucidated the truth and cut short discussions: the depositions of the witnesses, the speeches on both sides, the examination of the documents, could not proceed without the frequent taking of oaths "by the life of the king" or "by the favour of the gods," in which the truth often suffered severely. Penalties were varied somewhat—the bastinado, imprisonment, additional days of work for the corvée, and, for grave

offences, forced labour in the Ethiopian mines, the loss of nose and ears, and finally, death by strangulation, by beheading,¹ by empalement, and at the stake. Criminals of high rank obtained permission to carry out on themselves the sentence passed upon them, and thus avoided by suicide the shame of public execution. Before tribunals thus constituted, the fellah who came to appeal against the exactions of which he was the victim had little chance of obtaining a hearing: had not the scribe who had overtaxed him, or who had imposed a fresh corvée upon him, the right to appear among the Judges to whom he addressed himself? Nothing, indeed, prevented him from appealing from the latter to his feudal lord, and from him to Pharaoh, but such an appeal would be for him a mere delusion. When he had left his village and presented his petition, he had many delays to encounter before a solution could be arrived at; and if the adverse party were at all in favour at court, or could command any influence, the sovereign decision would confirm, even if it did not aggravate, the sentence of the previous judges. In the mean while the peasants' land remained uncultivated, his wife and children bewailed their wretchedness, and the last resources of the family were consumed in proceedings and delays: it would have been better for him at the outset to have made up his mind to submit with-

¹ The only known instance of an execution by hanging is that of Pharaoh's chief baker, in Gen. xl. 19, 22, xli. 13; but in a tomb at Thebes we see two human victims executed by strangulation. The Egyptian hell contains men who have been decapitated, and the block on which the damned were beheaded is frequently mentioned in the texts.

out resistance to a fate from which he could not escape.

In spite of taxes, requisitions, and forced labour, the fellahîn came off fairly well, when the chief to whom they belonged proved a kind master, and did not add the exactions of his own personal caprice to those of the State. The inscriptions which princes caused to be devoted to their own glorification, are so many enthusiastic panegyrics dealing only with their uprightness and kindness towards the poor and lowly. Every one of them represents himself as faultless: "the staff of support to the aged, the foster father of the children, the counsellor of the unfortunate, the refuge in which those who suffer from the cold in Thebes may warm themselves, the bread of the afflicted which never failed in the city of the South." Their solicitude embraced everybody and everything: "I have caused no child of tender age to mourn; I have despoiled no widow; I have driven away no tiller of the soil; I have taken no workmen away from their foreman for the public works; none have been unfortunate about me, nor starving in my time. When years of scarcity arose, as I had cultivated all the lands of the nome of the Gazelle to its northern and southern boundaries, causing its inhabitants to live, and creating provisions, none who were hungry were found there, for I gave to the widow as well as to the woman who had a husband, and I made no distinction between high and low in all that I gave. If, on the contrary, there were high Niles, the possessors of lands became rich in all things, for I did not raise the rate of the tax upon the fields." The canals engrossed all the prince's

attention; he cleaned them out, enlarged them, and dug fresh ones, which were the means of bringing fertility and plenty into the most remote corners of his property. His serfs had a constant supply of clean water at their door, and were no longer content with such food as durra; they ate wheaten bread daily. His vigilance and severity were such that the brigands dared no longer appear within reach of his arm, and his soldiers kept strict discipline: "When night fell, whoever slept by the roadside blessed me, and was [in safety] as a man in his own house; the fear of my police protected him, the cattle remained in the fields as in the stable; the thief was as the abomination of the god, and he no more fell upon the vassal, so that the latter no more complained, but paid exactly the dues of his domain, for love" of the master who had procured for him this freedom from care. This theme might be pursued at length, for the composers of epitaphs varied it with remarkable cleverness and versatility of imagination. The very zeal which they display in describing the lord's virtues betrays how precarious was the condition of his subjects. There was nothing to hinder the unjust prince or the prevaricating officer from ruining and ill-treating as he chose the people who were under his authority. He had only to give an order, and the *corvée* fell upon the proprietors of a village, carried off their slaves and obliged them to leave their lands uncultivated; should they declare that they were incapable of paying the contributions laid on them, the prison opened for them and their families. If a dyke were cut, or the course of a channel altered, the nome was deprived of water: prompt and inevitable ruin came upon

the unfortunate inhabitants, and their property, confiscated by the treasury in payment of the tax, passed for a small consideration into the hands of the scribe or of the dishonest administrator. Two or three years of neglect were almost enough to destroy a system of irrigation: the canals became filled with mud, the banks crumbled, the inundation either failed to reach the ground, or spread over it too quickly and lay upon it too long. Famine soon followed with its attendant sicknesses: men and animals died by the hundred, and it was the work of nearly a whole generation to restore prosperity to the district.

The lot of the fellah of old was, as we have seen, as hard as that of the fellah of to-day. He himself felt the bitterness of it, and complained at times, or rather the scribes complained for him, when with selfish complacency they contrasted their calling with his. He had to toil the whole year round,—digging, sowing, working the shadouf from morning to night for weeks, hastening at the first requisition to the *corvée*, paying a heavy and cruel tax,—all without even the certainty of enjoying what remained to him in peace, or of seeing his wife and children profit by it. So great, however, was the elasticity of his temperament that his misery was not sufficient to depress him: those monuments upon which his life is portrayed in all its minutiae, represent him as animated with inexhaustible cheerfulness. The summer months ended, the ground again becomes visible, the river retires into its bed, the time of sowing is at hand: the peasant takes his team and his implements with him and goes off to the fields. In many places, the soil, softened by the water, offers no resistance,

and the hoe easily turns it up; elsewhere it is hard, and only yields to the plough. While one of the farm-servants, almost bent double, leans his whole weight on the handles to force the ploughshare deep into the soil, his comrade drives the oxen and encourages them by his songs: these are only two or three short sentences, set to an unvarying chant, and with the time beaten on the back of the nearest animal. Now and again he turns round towards his comrade and encourages him: "Lean hard!"—"Hold fast!"



TWO FELLAHÏN WORK THE SHADOUF IN A GARDEN.¹

The sower follows behind and throws handfuls of grain into the furrow: a flock of sheep or goats brings up the rear, and as they walk, they tread the seed into the ground. The herdsmen crack their whips and sing some country song at the top of their voices,—based on the complaint of some fellah seized by the *corvée* to clean out a canal. "The digger is in the water with the fish,—he talks to the *silurus*, and exchanges greetings with the *oxyrrhynchus*:—West! your digger is a digger from the West!"² All this

¹ Drawn by Faucher-Gudin, from a photograph.

² The *silurus* is the electrical fish of the Nile. The text ironically hints that the digger, up to his waist in water, engaged in dredging the dykes or

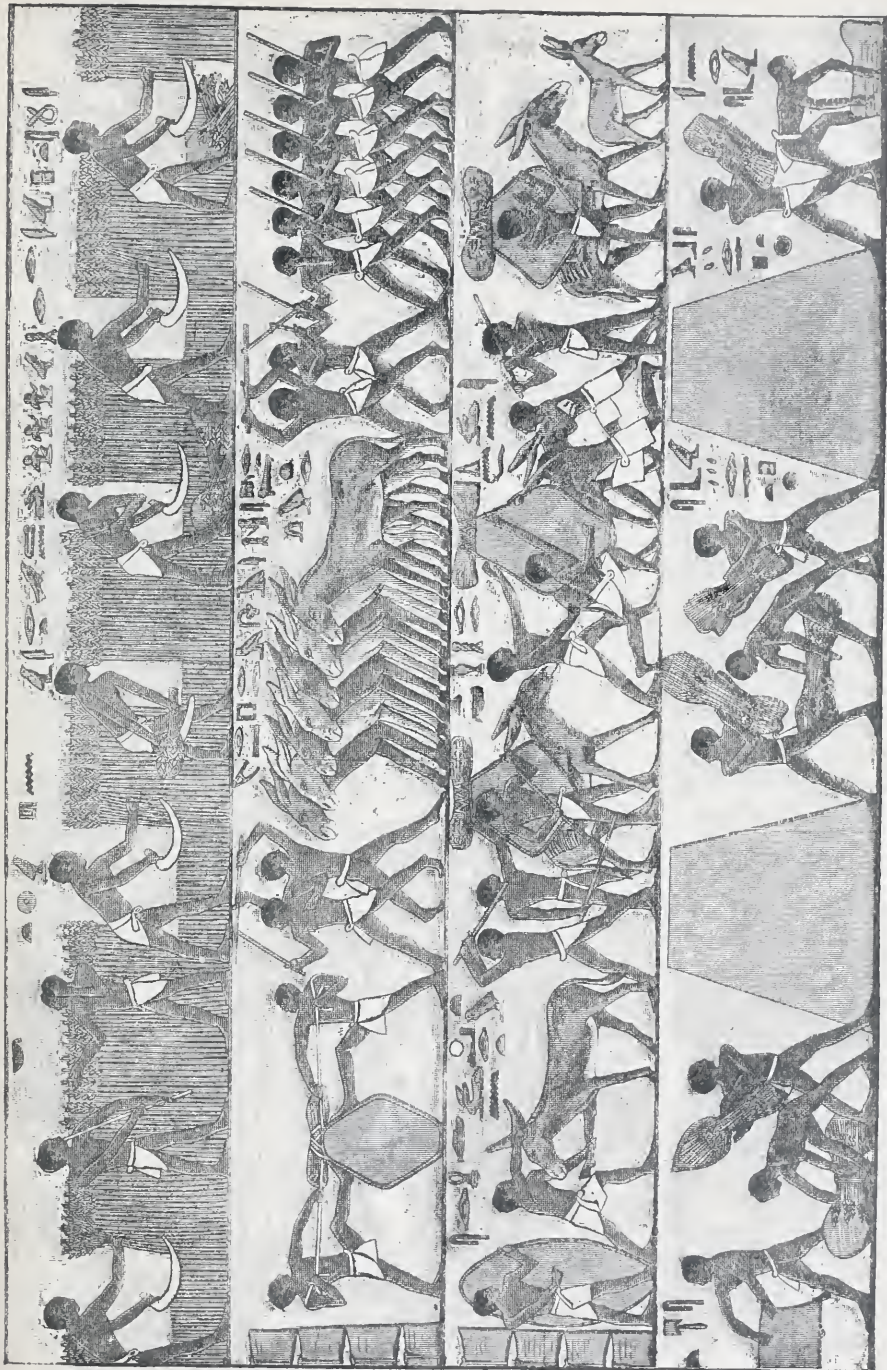

THE CUTTING AND CARRYING OF THE HARVEST.

Drawn by Faucher-Gudin, from a photograph by DÜMCHEN, *Resultate*, vol. i. pl. x.

takes place under the vigilant eye of the master: as soon as his attention is relaxed, the work slackens, quarrels arise, and the spirit of idleness and theft gains the ascendancy. Two men have unharnessed their team. One of them quickly milks one of the cows, the other holds the animal and impatiently awaits his turn: "Be quick, while the farmer is not there." They run the risk of a beating for a potful of milk. The weeks pass, the corn has ripened, the harvest begins. The fellahin, armed with a short sickle, cut or rather saw the stalks, a handful at a time. As they advance in line, a flute-player plays them captivating tunes, a man joins in with his voice marking the rhythm by clapping his hands, the foreman throwing in now and then a few words of exhortation: "What lad among you, when the season is over, can say: 'It is I who say it, to thee and to my comrades, you are all of you but idlers!'—Who among you can say: 'An active lad for the job am I!'" A servant moves among the gang with a tall jar of beer, offering it to those who wish for it. "Is it not good!" says he; and the one who drinks answers politely: "'Tis true, the master's beer is better than a cake of durra!" The sheaves once bound, are carried to the singing of fresh songs addressed to the donkeys who bear them: "Those who quit the ranks will be tied, those who roll on the ground will be beaten,—Geeho! then." And thus

repairing a bank swept away by an inundation, is liable at any moment to salute, *i.e.* to meet with a silurus or an oxyrrhynchus ready to attack him; he is doomed to death, and this fact the couplet expresses by the words, "West! your digger is a digger from the West." The West was the region of the tombs; and the digger, owing to the dangers of his calling, was on his way thither.

threatened, the ass trots forward. Even when a tragic element enters the scene, and the bastinado is represented, the sculptor, catching the bantering spirit of the people among whom he lives, manages to insinuate a vein of comedy. A peasant, summarily condemned for some misdeed, lies flat upon the ground with bared back: two friends take hold of his arms, and two others his legs, to keep him in the proper position. His wife or his son intercedes for him to the man with the stick: "For mercy's sake strike on the ground!" And as a fact, the bastinado was commonly rather a mere form of chastisement than an actual punishment: the blows, dealt with apparent ferocity, missed their aim and fell upon the earth; the culprit howled loudly, but was let off with only a few bruises.

An Arab writer of the Middle Ages remarks, not without irony, that the Egyptians were perhaps the only people in the world who never kept any stores of provisions by them, but each one went daily to the market to buy the pittance for his family. The improvidence which he laments over in his contemporaries had been handed down from their most remote ancestors. Workmen, *fellahîn*, *employés*, small townfolk, all lived from hand to mouth in the Egypt of the Pharaohs. Pay-days were almost everywhere days of rejoicing and extra eating: no one spared either the grain, oil, or beer of the treasury, and copious feasting continued unsparingly, as long as anything was left of their wages. As their resources were almost always exhausted before the day of distribution once more came round, beggary succeeded to fulness of living, and a part of the population was literally starving for several days. This almost constant

alternation of abundance and dearth had a reactionary influence on daily work: there were scarcely any seignorial workshops or undertakings which did not come to a standstill every month on account of the exhaustion of the workmen, and help had to be provided for the starving in order to avoid popular seditions. Their improvidence, like their cheerfulness, was perhaps an innate trait in the national character: it was certainly fostered and developed by the system of government adopted by Egypt from the earliest times. What incentive was there for a man of the people



A FLOCK OF GOATS AND THE SONG OF A GOATHERD.¹

to calculate his resources and to lay up for the future, when he knew that his wife, his children, his cattle, his goods, all that belonged to him, and himself to boot, might be carried off at any moment, without his having the right or the power to resent it? He was born, he lived, and he died in the possession of a master. The lands or houses which his father had left him, were his merely on sufferance, and he enjoyed them only by permission of his lord. Those which he acquired by his own labour went to swell his master's domain. If he married and had sons, they were

¹ Drawn by Faucher-Gudin, from a photograph by Émil Brugsch-Bey. The picture is taken from the tomb of Ti.

but servants for the master from the moment they were brought into the world. Whatever he might enjoy to-day, would his master allow him possession of it to-morrow? Even life in the world beyond did not offer him much more security or liberty: he only entered it in his master's service and to do his bidding; he existed in it on tolerance, as he had lived upon this earth, and he found there no rest or freedom unless he provided himself abundantly with "respondents" and charmed statuettes. He therefore concentrated his mind and energies on the present moment, to make the most of it as of almost the only thing which belonged to him: he left to his master the task of anticipating and providing for the future. In truth, his masters were often changed; now the lord of one town, now that of another; now a Pharaoh of the Memphite or Theban dynasties, now a stranger installed by chance upon the throne of Horus. The condition of the people never changed; the burden which crushed them was never lightened, and whatever hand happened to hold the stick, it never fell the less heavily upon their backs.

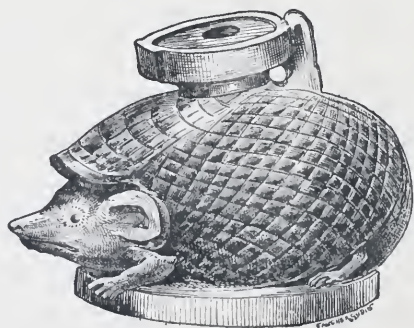



THE MEMPHITE EMPIRE

THE ROYAL PYRAMID BUILDERS: KHEOPS, KHEPHREN, MYKERINOS—MEMPHITE LITERATURE AND ART—EXTENSION OF EGYPT TOWARDS THE SOUTH, AND THE CONQUEST OF NUBIA BY THE PHARAOKS.

Snofrúi—The desert which separates Africa from Asia: its physical configuration, its inhabitants, their incursions into Egypt, and their relations with the Egyptians—The peninsula of Sinai: the turquoise and copper mines, the mining works of the Pharaohs—The two tombs of Snofrúi: the pyramid and the mastabas of Médúm, the statues of Rahotpú and his wife Nofrít.

Kheops, Khephren, and Mykerinos—The Great Pyramid: its construction and internal arrangements—The pyramids of Khephren and Mykerinos; the rifling of them—Legend about the royal pyramid builders: the impiety of Kheops and Khephren, the piety of Mykerinos; the brick pyramid of Asychis—The materials employed in building, and the quarries of Turah; the plans, the worship of the royal “double;” the Arab legends about the guardian geni of the pyramids.

The kings of the fifth dynasty: Ûsirkaf, Sahûri, Kakiû, and the romance about their advent—The relations of the Delta to the peoples of the North: the shipping and maritime commerce of the Egyptians—Nubia and its tribes: the Ûâiâiû and the Mazaiû, Pûanit, the dwarfs and the Danga—Egyptian literature: the Proverbs of Phtahhotpû—The arts: architecture, statuary and its chief examples, bas-reliefs, painting, industrial art.

The development of Egyptian feudalism, and the advent of the sixth dynasty: Ati, Imhotpû, Teti—Papi I. and his minister Ûni: the affair of Queen Amitsi; the wars against the Hirû-Shâitû and the country of Tiba—Metesûphis I. and the second Papi: progress of the Egyptian power in Nubia—the lords of Elephantinê; Hirkhûf, Papinakhiti: the way for conquest prepared by their explorations, the occupation of the Oases—The pyramids of Saqqâra: Metesûphis the Second—Nitokris and the legend concerning her—Preponderance of the feudal lords, and fall of the Memphite dynasty.





THE PYRAMID OF SNOFRÛI AT MÉDÛM.¹

CHAPTER II

THE MEMPHITE EMPIRE

The royal pyramid builders: Kheops, Khephren, Mykerinos—Memphite literature and art—Extension of Egypt towards the South, and the conquest of Nubia by the Pharaohs.



AT that time “the Majesty of King Hûni died, and the Majesty of King Snofrûi arose to be a sovereign benefactor over this whole earth.” All that we know of him is contained in one sentence: he fought against the nomads of Sinai, constructed fortresses to protect the eastern frontier of the Delta, and made for himself a tomb in the form of a pyramid.

¹ Drawn by Boudier, from the chromolithograph in LEPSIUS, *Denkm.*, i.

The almost uninhabited country which connects Africa with Asia is flanked towards the south by two chains of hills which unite at right angles, and together form the so-called Gebel et-Tih. This country is a table-land, gently inclined from south to north, bare, sombre, covered with flint-shingle, and siliceous rocks, and breaking out at frequent intervals into long low chalky hills, seamed with wadys, the largest of which—that of El-Arish—having drained all the others into itself, opens into the Mediterranean halfway between Pelusium and Gaza. Torrents of rain are not infrequent in winter and spring, but the small quantity of water which they furnish is quickly evaporated, and barely keeps alive the meagre vegetation in the bottom of the valleys. Sometimes, after months of absolute drought, a tempest breaks over the more elevated parts of the desert.¹ The wind rises suddenly in squall-like blasts; thick clouds, borne one knows not whence, are riven by lightning to the incessant accompaniment of thunder; it would seem as if the heavens had broken up and were crashing

pl. 45. The vignette represents Râhotpû, a dignitary of Mèdûm, of whom mention is made further on; the drawing is made by Boudier, from a photograph by Émil Brugsch-Bey.

¹ In chap. viii. of the *Account of the Survey*, pp. 226–228, Mr. Holland describes a sudden rainstorm or “seil” on December 3, 1867, which drowned thirty persons, destroyed droves of camels and asses, flocks of sheep and goats, and swept away, in the Wady Feirân, a thousand palm trees and a grove of tamarisks, two miles in length. Towards 4.30 in the afternoon, a few drops of rain began to fall, but the storm did not break till 5 p.m. At 5.15 it was at its height, and it was not over till 9.30. The torrent, which at 8 p.m. was 10 feet deep, and was about 1000 feet in width, was, at 6 a.m. the next day, reduced to a small streamlet.

down upon the mountains. In a few moments streams of muddy water rushing down the ravines, through the gulleys and along the slightest depressions, hurry to the low grounds, and meeting there in a foaming concourse, follow the fall of the land; a few minutes later, and the space between one hillside and the other is occupied by a deep river, flowing with terrible velocity and irresistible force. At the end of eight or ten hours the air becomes clear, the wind falls, the rain ceases; the hastily formed river dwindles, and for lack of supply is exhausted; the inundation comes to an end almost as quickly as it began. In a short time nothing remains of it but some shallow pools scattered in the hollows, or here and there small streamlets which rapidly dry up. The flood, however, accelerated by its acquired velocity, continues to descend towards the sea. The devastated flanks of the hills, their torn and corroded bases, the accumulated masses of shingle left by the eddies, the long lines of rocks and sand, mark its route and bear evidence everywhere of its power. The inhabitants, taught by experience, avoid a sojourn in places where tempests have once occurred. It is in vain that the sky is serene above them and the sun shines overhead; they always fear that at the moment in which danger seems least likely to threaten them, the torrent, taking its origin some twenty leagues off, may be on its headlong way to surprise them. And, indeed, it comes so suddenly and so violently that nothing in its course can escape it: men and beasts, before there is time to fly, often even before they are

aware of its approach, are swept away and pitilessly destroyed. The Egyptians applied to the entire country the characteristic epithet of To-Shûit, the land of Empti-

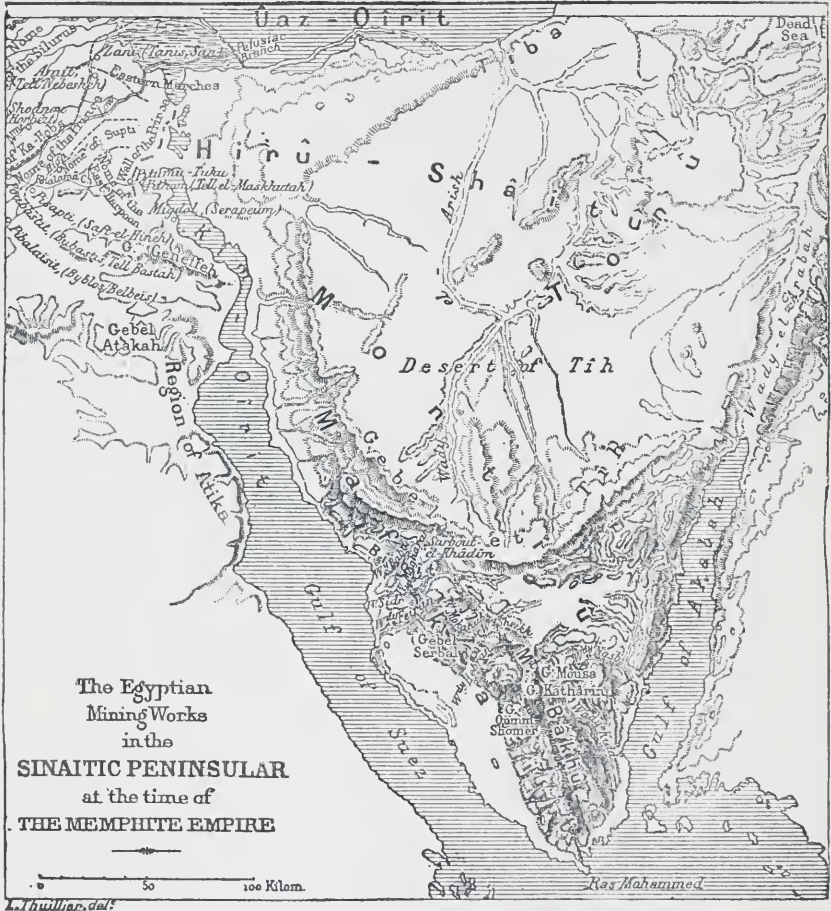

ness, the land of Aridity. They divided it into various districts—the upper and lower Tonû, Aia, Kadûma. They called its inhabitants Hirû-Shâtû, the lords of the Sands; Nomiû-Shâtû, the rovers of the Sands; and

they associated them with the Amû—that is to say, with a race which we recognize as Semitic. The type of these barbarians, indeed, reminds one of the Semitic massive head, aquiline nose, retreating forehead, long beard, thick and not infrequently crisp hair. They went barefoot, and the monuments represent them as girt with a short kilt, though they also wore the *abayah*. Their arms were those commonly used by the Egyptians—the bow, lance, club, knife, battle-axe, and shield. They possessed great flocks of goats or sheep, but the horse and camel were unknown to them, as well as to their African neighbours. They lived chiefly upon the milk of their flocks, and the fruit of the date-palm. A section of them tilled the soil: settled around springs or wells, they managed by industrious labour to cultivate moderately sized but fertile fields, flourishing orchards, groups of palms, fig and olive trees, and vines. In spite of all this their resources were insufficient, and their position would have been precarious if they had not been able to supplement their stock of provisions from Egypt or Southern Syria. They bartered at the frontier markets their honey, wool, gums, manna, and small quantities of charcoal, for the products of local manufacture, but especially for wheat, or the cereals of which they stood in need. The sight of the riches gathered together in the eastern plain, from Tanis to Bubastis, excited their pillaging instincts, and awoke in them an irrepressible covetousness. The Egyptian annals make mention of their incursions at the very commencement of history, and they maintained that

even the gods had to take steps to protect themselves from them. The Gulf of Suez and the mountainous



A BARBARIAN MONÏTI FROM SINAI.¹

rampart of Gebel Geneffeh in the south, and the marshes of Pelusium on the north, protected almost completely the eastern boundary of the Delta; but the Wady Tumulât laid open the heart of the country to the invaders. The Pharaohs of the divine dynasties in the first place, and then those of the human dynasties, had fortified this natural opening, some say by a con-

tinuous wall, others by a line of military posts, flanked on the one side by the waters of the gulf.² Snofruî

¹ Drawn by Faucher-Gudin, from a photograph by Petrie. The original is of the time of Nectanebo, and is at Karnak; I have chosen it for reproduction in preference to the heads of the time of the Ancient Empire, which are more injured, and of which this is only the traditional copy.

² The existence of the wall, or of the line of military posts, is of very ancient date, for the name Kim-Oîrit is already followed by the hieroglyph of the wall, or by that of a fortified enclosure in the texts of the Pyramids.

restored or constructed several castles in this district, which perpetuated his name for a long time after his death. These had the square or rectangular form of the towers, whose ruins are still to be seen on the banks of the Nile. Standing night and day upon the battlements, the sentinels kept a strict look-out over the desert, ready to give alarm at the slightest suspicious



TWO REFUGE TOWERS OF THE HIRÛ-SHÂÎTÛ, IN THE WADY BÎAR.¹

movement. The marauders took advantage of any inequality in the ground to approach unperceived, and they were often successful in getting through the lines ;

The expression Kîm-Oîrît, "the very black," is applied to the northern part of the Red Sea, in contradistinction to Ûaz-Oîrît, Ûazit-Oîrît, "the very green," the Mediterranean ; a town, probably built at a short distance from the village of Maghfâr, had taken its name from the gulf on which it was situated, and was also called Kîm-Oîrît.

¹ Drawn by Faucher-Gudin, from the vignette by E. H. PALMER, *The Desert of the Exodus*, p. 317.

they scattered themselves over the country, surprised a village or two, bore off such women and children as they could lay their hands on, took possession of herds of animals, and, without carrying their depredations further, hastened to regain their solitudes before information of their exploits could have reached the garrison. If their expeditions became numerous, the general of the Eastern Marches, or the Pharaoh himself, at the head of a small army, started on a campaign of reprisals against them. The marauders did not wait to be attacked, but betook themselves to refuges constructed by them beforehand at certain points in their territory. They erected here and there, on the crest of some steep hill, or at the confluence of several wadys, stone towers put together without mortar, and rounded at the top like so many beehives, in unequal groups of three, ten, or thirty; here they massed themselves as well as they could, and defended the position with the greatest obstinacy, in the hope that their assailants, from the lack of water and provisions, would soon be forced to retreat.¹ Elsewhere they possessed fortified "duars," where not only their families but also their herds could find a refuge—circular or oval enclosures, surrounded by low walls of massive rough stones crowned by a

¹ The members of the English Commission do not hesitate to attribute the construction of these towers to the remotest antiquity; the Bedouin call them "namûs," plur. "nawamîs," mosquito-houses, and they say that the children of Israel built them as a shelter during the night from mosquitos at the time of the Exodus. The resemblance of these buildings to the "Talayôt" of the Balearic Isles, and to the Scotch beehive-shaped houses, has struck all travellers.

thick rampart made of branches of acacia interlaced with thorny bushes, the tents or huts being ranged behind, while in the centre was an empty space for the cattle. These primitive fortresses were strong enough to overawe nomads; regular troops made short work of them. The Egyptians took them by assault, overturned them, cut down the fruit trees, burned the crops,



VIEW OF THE OASIS OF WADY FEIRÂN IN THE PENINSULA OF SINAI.¹

and retreated in security, after having destroyed everything in their march. Each of their campaigns, which hardly lasted more than a few days, secured the tranquillity of the frontier for some years.²

To the south of Gebel et-Tih, and cut off from it almost

¹ Drawn by Boudier, from the water-colour drawing published by LEPSIUS, *Denkm.*, i. 7, No. 2.

² The inscription of Ūni (ll. 22-32) furnishes us with the invariable type of the Egyptian campaigns against the Hirû-Shâitû: the bas-reliefs of Karnak might serve to illustrate it, as they represent the great raid led by Seti I. into the territory of the Shaûsûs and their allies, between the frontier of Egypt and the town of Hebron.

completely by a moat of wadys, a triangular group of mountains known as Sinai thrusts a wedge-shaped spur into the Red Sea, forcing back its waters to the right and left into two narrow gulfs, that of Akabah and that of Suez. Gebel Katherin stands up from the centre and overlooks the whole peninsula. A sinuous chain detaches itself from it and ends at Gebel Serbâl, at some distance to the north-west; another trends to the south, and after attaining in Gebel Umm-Shomer an elevation equal to that of Gebel Katherin, gradually diminishes in height, and plunges into the sea at Ras-Mohammed. A complicated system of gorges and valleys—Wady Nasb, Wady Kidd, Wady Hebrân, Wady Baba—furrows the country and holds it as in a network of unequal meshes. Wady Feîrân contains the most fertile oasis in the peninsula. A never-failing stream waters it for about two or three miles of its length; quite a little forest of palms enlivens both banks—somewhat meagre and thin, it is true, but intermingled with acacias, tamarisks, nabecas, carob trees, and willows. Birds sing amid their branches, sheep wander in the pastures, while the huts of the inhabitants peep out at intervals from among the trees. Valleys and plains, even in some places the slopes of the hills, are sparsely covered with those delicate aromatic herbs which affect a stony soil. Their life is a perpetual struggle against the sun: scorched, dried up, to all appearance dead, and so friable that they crumble to pieces in the fingers when one attempts to gather them, the spring rains annually infuse into them new life, and bestow upon them, almost before one's eyes, a green and perfumed youth of some days' duration. The summits of the hills remain

always naked, and no vegetation softens the ruggedness of their outlines, or the glare of their colouring. The core of the peninsula is hewn, as it were, out of a block of granite, in which white, rose-colour, brown, or black predominate, according to the quantities of felspar, quartz, or oxides of iron which the rocks contain. Towards the north, the masses of sandstone which join on to Gebel et-Tîh assume all possible shades of red and grey, from a delicate lilac neutral tint to dark purple. The tones of colour, although placed crudely side by side, present nothing jarring nor offensive to the eye; the sun floods all, and blends them in his light. The Sinaitic peninsula is at intervals swept, like the desert to the east of Egypt, by terrible tempests, which denude its mountains and transform its wadys into so many ephemeral torrents. The Monîtû who frequented this region from the dawn of history did not differ much from the "Lords of the Sands;" they were of the same type, had the same costume, the same arms, the same nomadic instincts, and in districts where the soil permitted it, made similar brief efforts to cultivate it. They worshipped a god and a goddess whom the Egyptians identified with Horus and Hâthor; one of these appeared to represent the light, perhaps the sun, the other the heavens. They had discovered at an early period in the sides of the hills rich metalliferous veins, and strata, bearing precious stones; from these they learned to extract iron, oxides of copper and manganese, and turquoises, which they exported to the Delta. The fame of their riches, carried to the banks of the Nile, excited the cupidity of the Pharaohs; expeditions started from different points of the valley, swept down upon

the peninsula, and established themselves by main force in the midst of the districts where the mines lay. These were situated to the north-west, in the region of sandstone, between the western branch of Gebel et-Tih and the Gulf of Suez. They were collectively called Mafkaît, the country of turquoises, a fact which accounts for the application of the local epithet, lady of Mafkaît, to Hâthor. The earliest district explored, that which the Egyptians first attacked, was separated from the coast by a narrow plain and a single range of hills: the produce of the mines could be thence transported to the sea in a few hours without difficulty. Pharaoh's labourers called this region the district of Baît, the mine *par excellence*, or of Bebit, the country of grottoes, from the numerous tunnels which their predecessors had made there: the name Wady Maghara, Valley of the Cavern, by which the site is now designated, is simply an Arabic translation of the old Egyptian word.

The Monîtû did not accept this usurpation of their rights without a struggle, and the Egyptians who came to work among them had either to purchase their forbearance by a tribute, or to hold themselves always in readiness to repulse the assaults of the Monîtû by force of arms. Zosiri had already taken steps to ensure the safety of the turquoise-seekers at their work; Snofrûi was not, therefore, the first Pharaoh who passed that way, but none of his predecessors had left so many traces of his presence as he did in this out-of-the-way corner of the empire. There may still be seen, on the north-west slope of the Wady Maghara, the bas-relief which one of his lieutenants engraved there in memory of a victory gained over the

Monîtû. A Bedouin sheikh fallen on his knees prays for mercy with suppliant gesture, but Pharaoh has already seized him by his long hair, and brandishes above his head a white stone mace to fell him with a single blow. The workmen, partly recruited from the country itself, partly despatched from the banks of the Nile, dwelt in an entrenched camp upon an isolated peak at the confluence of Wady Genneh and Wady Maghara. A zig-zag pathway on its smoothest slope ends, about seventeen feet below the summit, at the extremity of a small and slightly inclined table-land, upon which are found the ruins of a large village; this is the High Castle—Hâit-Qait of the ancient inscriptions. Two hundred habitations can still be made out here, some round, some rectangular, constructed of sandstone blocks without mortar, and not larger than the huts of the fellahîn : in former times a flat roof of wicker-work and puddled clay extended over each. The entrance was not so much a door as a narrow opening, through

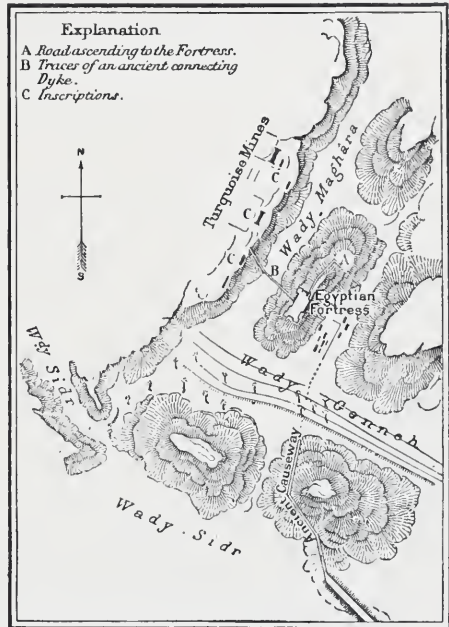

THE MINING WORKS OF WADY MAGHARA.¹

¹ Plan made by Thuillier, from the sketch by BRUGSCH, *Wanderung nach den Türkis Minen*, p. 70.

which a fat man would find it difficult to pass ; the interior consisted of a single chamber, except in the case of the chief of the works, whose dwelling contained two. A rough stone bench from two to two and a half feet high surrounds the plateau on which the village stands ; a *cheval de frise* made of thorny brushwood probably completed the defence, as in the *duars* of the desert. The position was very strong and easily defended. Watchmen scattered



THE HIGH CASTLE OF THE MINERS—HÂT-QÂT—AT THE CONFLUENCE OF WADY GENNEH AND WADY MAGHARA.¹

over the neighbouring summits kept an outlook over the distant plain and the defiles of the mountains. Whenever the cries of these sentinels announced the approach of the foe, the workmen immediately deserted the mine and took refuge in their citadel, which a handful of resolute men

¹ Drawn by Boudier, from the photograph published in the Ordnance Survey of the Peninsula of Sinai, Photographs, vol. ii. pls. 59, 60.

could successfully hold, as long as hunger and thirst did not enter into the question. As the ordinary springs and wells would not have been sufficient to supply the needs of the colony, they had transformed the bottom of the valley into an artificial lake. A dam thrown across it prevented the escape of the waters, which filled the reservoir more or less completely according to the season. It never became empty, and several species of shellfish flourished in it—among others, a kind of large mussel which the inhabitants generally used as food, which with dates, milk, oil, coarse bread, a few vegetables, and from time to time a fowl or a joint of meat, made up their scanty fare. Other things were of the same primitive character. The tools found in the village are all of flint : knives, scrapers, saws, hammers, and heads of lances and arrows. A few vases brought from Egypt are distinguished by the fineness of the material and the purity of the design ; but the pottery in common use was made on the spot from coarse clay without care, and regardless of beauty. As for jewellery, the villagers had beads of glass or blue enamel, and necklaces of strung cowrie-shells. In the mines, as in their own houses, the workmen employed stone tools only, with handles of wood, or of plaited willow twigs, but their chisels or hammers were more than sufficient to cut the yellow sandstone, coarse-grained and very friable as it was, in the midst of which they worked.¹ The tunnels running straight into the

¹ E. H. Palmer, however, from his observations, is of opinion that the work in the tunnels of the mines was executed entirely by means of bronze chisels and tools ; the flint implements serving only to incise the scenes which cover the surfaces of the rocks.

mountain were low and wide, and were supported at intervals by pillars of sandstone left *in situ*. These tunnels led into chambers of various sizes, whence they followed the lead of the veins of precious mineral. The turquoise sparkled on every side—on the ceiling and on the walls—and the miners, profiting by the slightest fissures, cut round it, and then with forcible blows detached the blocks, and reduced them to small fragments, which they crushed, and carefully sifted so as not to lose a particle of the gem. The oxides of copper and of manganese which they met with here and elsewhere in moderate quantities, were used in the manufacture of those beautiful blue enamels of various shades which the Egyptians esteemed so highly. The few hundreds of men of which the permanent population was composed, provided for the daily exigencies of industry and commerce. Royal inspectors arrived from time to time to examine into their condition, to rekindle their zeal, and to collect the product of their toil. When Pharaoh had need of a greater quantity than usual of minerals or turquoises, he sent thither one of his officers, with a select body of carriers, mining experts, and stone-dressers. Sometimes as many as two or three thousand men poured suddenly into the peninsula, and remained there one or two months; the work went briskly forward, and advantage was taken of the occasion to extract and transport to Egypt beautiful blocks of diorite, serpentine or granite, to be afterwards manufactured there into sarcophagi or statues. Engraved stelæ, to be seen on the sides of the mountains, recorded the names of the principal chiefs, the different bodies of handicraftsmen who had

participated in the campaign, the name of the sovereign who had ordered it and often the year of his reign.

It was not one tomb only which Snofrûi had caused to be built, but two. He called them "Khâ," the Rising, the place where the dead Pharaoh, identified with the sun, is raised above the world for ever. One of these was probably situated near Dahshûr; the other, the "Khâ rîsi," the Southern Rising, appears to be identical with the monument of Mêdûm. The pyramid, like

the mastaba,¹ represents a tumulus with four sides, in which the earthwork is replaced by a structure of stone or brick.

It indicates the place in which lies a prince, chief, or person of rank in his tribe or province. It was

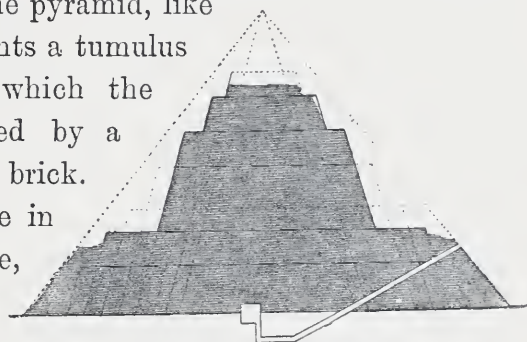

THE PYRAMID OF MÊDÛM.²

built on a base of varying area, and was raised to a greater or less elevation according to the fortune of the deceased or of his family.³ The fashion of burying in a pyramid was not adopted in the environs of Memphis

¹ No satisfactory etymon for the word *pyramid*, has as yet been proposed: the least far-fetched is that put forward by Cantor-Eisenlohr, according to which *pyramid* is the Greek form, *πυραμῖς*, of the compound term "piri-mûsi," which in Egyptian mathematical phraseology designates the *salient angle*, the ridge or height of the pyramid.

² Drawn by Faucher-Gudin, from the plans of FLINDERS PETRIE, *Medum*, pl. ii.

³ The brick pyramids of Abydos were all built for private persons. The word "mirit," which designates a pyramid in the texts, is elsewhere applied to the tombs of nobles and commoners as well as to those of kings.

until tolerably late times, and the Pharaohs of the primitive dynasties were interred, as their subjects were, in sepulchral chambers of mastabas. Zosiri was the only exception, if the step-pyramid of Saqqâra, as is probable, served for his tomb.¹ The motive which determined Snofrûi's choice of Mêdûm as a site, is unknown to us: perhaps he dwelt in that city of Heracleopolis, which in course of time frequently became the favourite residence of the kings: perhaps he improvised for himself a city in the plain between El-Wastah and Kafr el-Ayat. His pyramid, at the present time, is composed of three large unequal cubes with slightly inclined sides, arranged in steps one above the other. Some centuries ago five could be still determined, and in ancient times, before ruin had set in, as many as seven. Each block marked a progressive increase of the total mass, and had its external face polished—a fact which we can still determine by examining the slabs one behind another; a facing of large blocks, of which many of the courses still exist towards the base, covered the whole, at one angle from the apex to the foot, and brought it into conformity

¹ It is difficult to admit that a pyramid of considerable dimensions could have disappeared without leaving any traces behind, especially when we see the enormous masses of masonry which still mark the sites of those which have been most injured; besides, the inscriptions connect none of the predecessors of Snofrûi with a pyramid, unless it be Zosiri. The step-pyramid of Saqqâra, which is attributed to the latter, belongs to the same type as that of Mêdûm; so does also the pyramid of Rîgah, whose occupant is unknown. If we admit that this last-mentioned pyramid served as a tomb to some intermediate Pharaoh between Zosiri and Snofrûi—for instance, Hûni—the use of pyramids would be merely exceptional for sovereigns anterior to the IVth dynasty.

with the type of the classic pyramid. The passage had its orifice in the middle of the north face about sixty feet above the ground: it is five feet high, and dips at a tolerably steep angle through the solid masonry. At a depth of a hundred and ninety-seven feet it becomes level, without increasing in aperture, runs for forty feet on this plane, traversing two low and narrow chambers, then making a sharp turn it ascends perpendicularly until it reaches the floor of the vault. The latter is hewn out of the mountain rock, and is small, rough, and devoid of ornament: the ceiling appears to be in three heavy horizontal courses of masonry, which project one beyond the other corbel-wise, and give the impression of a sort of acutely pointed arch. Snofrûi slept there for ages; then robbers found a way to him, despoiled and broke up his mummy, scattered the fragments of his coffin upon the ground, and carried off the stone sarcophagus. The apparatus of beams and cords of which they made use for the descent, hung in their place above the mouth of the shaft until ten years ago. The rifling of the tomb took place at a remote date, for from the XXth dynasty onwards the curious were accustomed to penetrate into the passage: two scribes have scrawled their names in ink on the back of the framework in which the stone cover was originally inserted. The sepulchral chapel was built a little in front of the east face; it consisted of two small-sized rooms with bare surfaces, a court whose walls abutted on the pyramid, and in the court, facing the door, a massive table of offerings flanked by two large stelæ without inscriptions, as if the death of the king had put a stop to the decoration before the period determined on by the

architects. It was still accessible to any one during the XVIIIth dynasty, and people came there to render homage to the memory of Snofrûi or his wife Mirisônkhû. Visitors recorded in ink on the walls their enthusiastic, but stereotyped impressions: they compared the "Castle of Snofrûi" with the firmament, "when the sun arises in it; the heaven rains incense there and pours out perfumes on the roof." Ramses II., who had little respect for the works of his predecessors, demolished a part of the pyramid in order to procure cheaply the materials necessary for the buildings which he restored to Heracleopolis. His workmen threw down the waste stone and mortar beneath the place where they were working, without troubling themselves as to what might be beneath; the court became choked up, the sand borne by the wind gradually invaded the chambers, the chapel disappeared, and remained buried for more than three thousand years.

The officers of Snofrûi, his servants, and the people of his city wished, according to custom, to rest beside him, and thus to form a court for him in the other world as they had done in this. The menials were buried in roughly made trenches, frequently in the ground merely, without coffins or sarcophagi. The body was not laid out its whole length on its back in the attitude of repose: it more frequently rested on its left side, the head to the north, the face to the east, the legs bent, the right arm brought up against the breast, the left following the outline of the chest and legs.¹ The people who were interred in a posture

¹ W. FL. PETRIE, *Medum*, pp. 21, 22. Many of these mummies were mutilated, some lacking a leg, others an arm or a hand; these were probably

so different from that with which we are familiar in the case of ordinary mummies, belonged to a foreign race, who had retained in the treatment of their dead the customs of

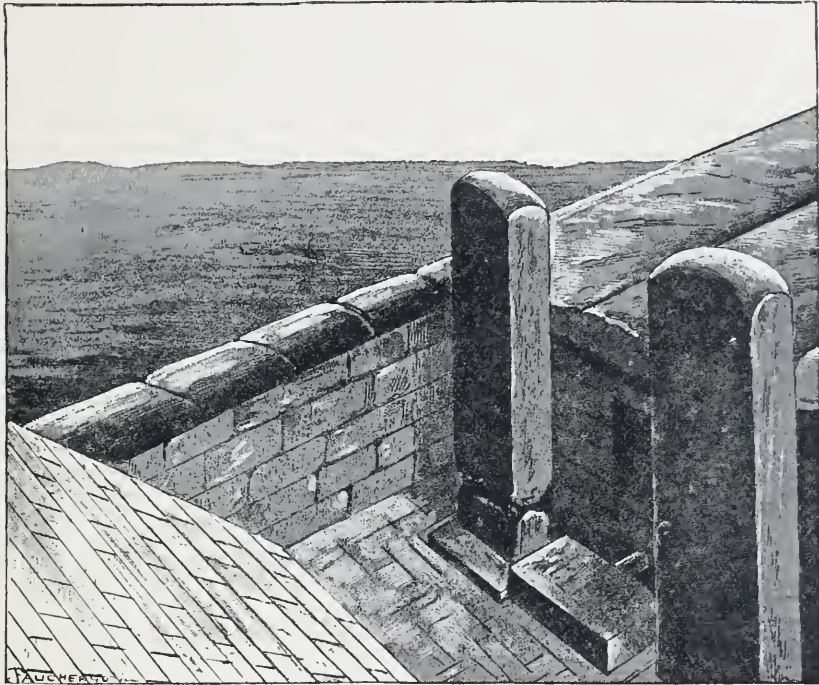

THE COURT AND THE TWO STELE OF THE CHAPEL ADJOINING THE PYRAMID OF MÊDÛM.¹

their native country. The Pharaohs often peopled their royal cities with prisoners of war, captured on the field of

workmen who had fallen victims to an accident during the building of the pyramid. In the majority of cases the detached limb had been carefully placed with the body, doubtless in order that the double might find it in the other world, and complete himself when he pleased for the exigencies of his new existence.

¹ Drawn by Faucher-Gudin, from a sketch by FL. PETRIE, *Ten Years' Digging in Egypt*, p. 141.

battle, or picked up in an expedition through an enemy's country. Snofrûi peopled his city with men from the Libyan tribes living on the borders of the Western desert or Monitû captives.¹ The body having been placed in the grave, the relatives who had taken part in the mourning heaped together in a neighbouring hole the funerary furniture, flint implements, copper needles, miniature pots and pans made of rough and badly burned clay, bread, dates, and eatables in dishes wrapped up in linen. The nobles ranged their mastabas in a single line to the north of the pyramid; these form fine-looking masses of considerable size, but they are for the most part unfinished and empty. Snofrûi having disappeared from the scene, Kheops who succeeded him forsook the place, and his courtiers, abandoning their unfinished tombs, went off to construct for themselves others around that of the new king. We rarely find at Médûm finished and occupied sepulchres, except that of individuals who had died before or shortly after Snofrûi. The mummy of Rânofir, found in one of them, shows how far the Egyptians had carried the art of embalming at this period. His body, though much shrunken, is well preserved: it had been clothed in some fine stuff, then covered over with a layer of resin, which a clever sculptor had modelled in such a manner as to present an image resembling the deceased; it was then rolled in three or four folds of thin and almost transparent gauze.

¹ PETRIE thinks that the people who were interred in a contracted position belonged to the aboriginal race of the valley, reduced to a condition of servitude by a race who had come from Asia, and who had established the kingdom of Egypt. The latter were represented by the mummies disposed at full length (*Medum*, p. 21).

Of these tombs the most important belonged to the Prince Nofirmât and his wife Atiti : it is decorated with bas-reliefs of a peculiar composition ; the figures have been cut in outline in the limestone, and the hollows thus made are filled in with a mosaic of tinted pastes which show the moulding and colour of the parts.

Everywhere else the ordinary methods of sculpture have been employed, the bas-reliefs being enhanced by brilliant colouring in a simple and delicate manner. The figures of men and animals are portrayed with a vivacity of manner which is astonishing ; and the other objects, even the hieroglyphs, are rendered with an accuracy which does not neglect the smallest detail. The statues of Râhotpû and of the lady Nofrît, discovered in a half-ruined mastaba, have fortunately reached us without having suffered the least damage, almost without losing anything of their original freshness ; they are to be seen in the Gîzeh Museum just as they



NOFRÎT, LADY OF MÊDÛM.¹

were when they left the hands of the workman. Râhotpû was the son of a king, perhaps of Snofrûi : but in spite of his high origin, I find something humble and retiring in his physiognomy. Nofrît, on the contrary, has an imposing appearance : an indescribable air of resolution and command

¹ Drawn by Boudier, from a photograph taken by Émil Brugsch-Bey.

invests her whole person, and the sculptor has cleverly given expression to it. She is represented in a robe with a pointed opening in the front: the shoulders, the bosom, the waist, and hips, are shown under the material of the dress with a purity and delicate grace which one does not always find in more modern works of art. The wig, secured on the forehead by a richly embroidered band, frames with its somewhat heavy masses the firm and rather plump face: the eyes are living, the nostrils breathe, the mouth smiles and is about to speak. The art of Egypt has at times been as fully inspired; it has never been more so than on the day in which it produced the statue of Nofrît.

The worship of Snofrûi was perpetuated from century to century. After the fall of the Memphite empire it passed through periods of intermittence, during which it ceased to be observed, or was observed only in an irregular way; it reappeared under the Ptolemies for the last time before becoming extinct for ever. Snofrûi was probably, therefore, one of the most popular kings of the good old times; but his fame, however great it may have been among the Egyptians, has been eclipsed in our eyes by that of the Pharaohs who immediately followed him—Kheops, Khephren, and Mykerinos. Not that we are really better acquainted with their history. All we know of them is made up of two or three series of facts, always the same, which the contemporaneous monuments teach us concerning these rulers. Khnûmû-Khûfûi,¹ abbreviated into

¹ The existence of the two cartouches Khûfûi and Khnûmû-Khûfûi on the same monuments has caused much embarrassment to Egyptologists: the majority have been inclined to see here two different kings, the second of

Khûfûi, the Kheops¹ of the Greeks, was probably the son of Snofrûi.² He reigned twenty-three years, and successfully defended the mines of the Sinaitic peninsula against the Bedouin; he may still be seen on the face of the rocks in the Wady Maghara sacrificing his

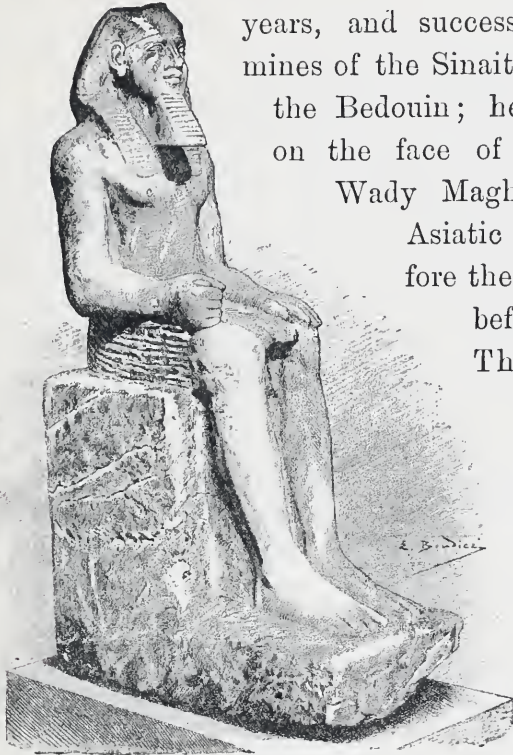

ALABASTER STATUE OF KHEOPS.³

Asiatic prisoners, now before the jackal Anubis, now before the ibis-headed Thot. The gods reaped advantage from his activity and riches; he restored the temple of Hâthor at Dendera, embellished that of Bubastis, built a stone sanctuary to the

whom, according to M. Robiou, would have been the person who bore the pre-nomen of Dadûfri. Khnûmû-Khûfûi signifies "the god Khnûmû protects me."

¹ Kheops is the usual form, borrowed from the account of Herodotus; Diodorus writes Khembes or Khemmes, Eratosthenes Saôphis, and Manetho Souphis.

² The story in the Westcar papyrus speaks of Snofrûi as father of Khûfûi; but this is a title of honour, and proves nothing. The few records which we have of this period give one, however, the impression that Kheops was the son of Snofrûi, and, in spite of the hesitation of de Rougé, this affiliation is adopted by the majority of modern historians.

³ Drawn by Boudier, from a photograph by Émil Brugsch-Bey. The

Isis of the Sphinx, and consecrated there gold, silver, bronze, and wooden statues of Horus, Nephthys, Selkît,



THE TRIUMPHAL BAS-RELIEFS OF KHEOPS ON THE ROCKS OF WADY MAGHARA.¹

Phtah, Sokhît, Osiris, Thot, and Hâpis. Scores of other Pharaohs had done as much or more, on whom no one

statue bears no cartouche, and considerations purely artistic cause me to attribute it to Kheops : it may equally well represent Dadûfrî, the successor of Kheops, or Shopsiskaf, who followed Mykerinos.

¹ Drawn by Faucher-Gudin, from a photograph published in the *Ordnance Survey, Photographs*, vol. iii. pl. 5. On the left stands the Pharaoh, and knocks down a Moniti before the Ibis-headed Thot ; upon the right the picture is destroyed, and we see the royal titles only, without figures.

bestowed a thought a century after their death, and Kheops would have succumbed to the same indifference had he not forcibly attracted the continuous attention of posterity by

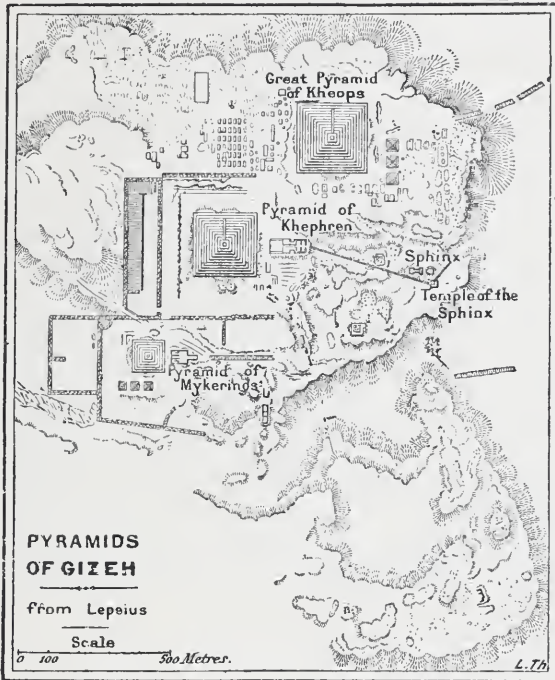

the immensity of his tomb.¹ The Egyptians of the Theban period were compelled to form their opinions of the

¹ All the details relating to the Isis of the Sphinx are furnished by a stele of the daughter of Kheops, discovered in the little temple of the XXIst dynasty, situated to the west of the Great Pyramid, and preserved in the Gizeh Museum. It was not a work entirely of the XXIst dynasty, as Mr. Petrie asserts, but the inscription, barely readable, engraved on the face of the plinth, indicates that it was remade by a king of the Saïte period, perhaps by Sabaco, in order to replace an ancient stele of the same import which had fallen into decay.

Pharaohs of the Memphite dynasties in the same way as we do, less by the positive evidence of their acts than by the size and number of their monuments: they measured the magnificence of Kheops by the dimensions of his pyramid, and all nations having followed this example, Kheops has continued to be one of the three or four names of former times which sound familiar to our ears. The hills of Gîzeh in his time terminated in a bare wind-swept table-land. A few solitary mastabas were scattered here and there on its surface, similar to those whose ruins still crown the hill of Dahshûr.¹ The Sphinx, buried even in ancient times to its shoulders, raised its head half-way down the eastern slope, at its southern angle;² beside him³ the temple of Osiris, lord of the Necropolis, was fast disappearing under the sand; and still further back old abandoned tombs honey-combed the rock.⁴ Kheops chose

¹ No one has noticed, I believe, that several of the mastabas constructed under Kheops, around the pyramid, contain in the masonry fragments of stone belonging to some more ancient structures. Those which I saw bore carvings of the same style as those on the beautiful mastabas of Dahshûr.

² The stele of the Sphinx bears, on line 13, the cartouche of Khephren in the middle of a blank. We have here, I believe, an indication of the clearing of the Sphinx effected under this prince, consequently an almost certain proof that the Sphinx was already buried in sand in the time of Kheops and his predecessors.

³ Mariette identifies the temple which he discovered to the south of the Sphinx with that of Osiris, lord of the Necropolis, which is mentioned in the inscription of the daughter of Kheops. This temple is so placed that it must have been sanded up at the same time as the Sphinx; I believe, therefore, that the restoration effected by Kheops, according to the inscription, was merely a clearing away of the sand from the Sphinx analogous to that accomplished by Khephren.

⁴ These sepulchral chambers are not decorated in the majority of instances. The careful scrutiny to which I subjected them in 1885-86

a site for his Pyramid on the northern edge of the plateau, whence a view of the city of the White Wall, and at the same time of the holy city of Heliopolis, could be obtained. A small mound which commanded this prospect was



KHÛT, THE GREAT PYRAMID OF GÎZEH, THE SPHINX, AND THE TEMPLE OF THE SPHINX.¹

roughly squared, and incorporated into the masonry ; the rest of the site was levelled to receive the first course of stones.

causes me to believe that many of them must be almost contemporaneous with the Sphinx ; that is to say, that they had been hollowed out and occupied a considerable time before the period of the IVth dynasty.

¹ Drawn by Boudier, from a photograph by Émil Brugsch-Bey. The temple of the Sphinx is in the foreground, covered with sand up to the top of the walls. The second of the little pyramids below the large one is that whose construction is attributed to Honitsonû, the daughter of Kheops, and with regard to which the dragomans of the Saïte period told such strange stories to Herodotus.

The pyramid when completed had a height of 476 feet on a base 764 feet square; but the decaying influence of time has reduced these dimensions to 450 and 730 feet respectively. It possessed, up to the Arab conquest, its polished facing, coloured by age, and so subtilly jointed that one would have said that it was a single slab from top to bottom.¹ The work of facing the pyramid began at the top; that of the point was first placed in position, then the courses were successively covered until the bottom was reached.²

In the interior every device had been employed to conceal the exact position of the sarcophagus, and to discourage the excavators whom chance or persistent search might have put upon the right track. Their first difficulty would be to discover the entrance under the limestone casing. It lay hidden almost in the middle of the northern face, on the level of the eighteenth course, at about forty-five feet above the ground. A movable flagstone, working on a stone pivot, disguised it so effectively that

¹ The blocks which still exist are of white limestone. Letronne, after having asserted in his youth (*Recherches sur Dicuil*, p. 107), on the authority of a fragment attributed to Philo of Byzantium, that the facing was formed of polychromatic zones of granite, of green breccia and other different kinds of stone, renounced this view owing to the evidence of Vyse. Perrot and Chipiez have revived it, with some hesitation.

² HERODOTUS, ii. 125, the word "point" should not be taken literally. The Great Pyramid terminated, like its neighbour, in a platform, of which each side measured nine English feet (six cubits, according to Diodorus Siculus, i. 63), and which has become larger in the process of time, especially since the destruction of the facing. The summit viewed from below must have appeared as a sharp point. "Having regard to the size of the monument, a platform of three metres square would have been a more pointed extremity than that which terminates the obelisks" (LETRONNE).

no one except the priests and custodians could have distinguished this stone from its neighbours. When it was tilted up, a yawning passage was revealed,¹ three and a half feet in height, with a breadth of four feet. The passage is an inclined plane, extending partly through the masonry and partly through the solid rock for a distance of 318 feet; it passes through an

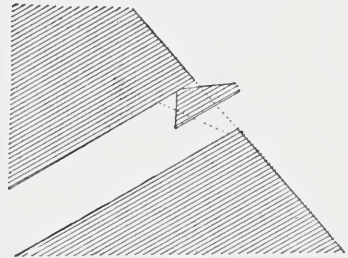

THE MOVABLE FLAGSTONE AT THE ENTRANCE TO THE GREAT PYRAMID.²

¹ Strabo expressly states that in his time the subterranean parts of the Great Pyramid were accessible: "It has on its side, at a moderate elevation, a stone which can be moved, λίθον ἐξαιρέσιμον. When it has been lifted up, a tortuous passage is seen which leads to the tomb." The meaning of Strabo's statement had not been mastered

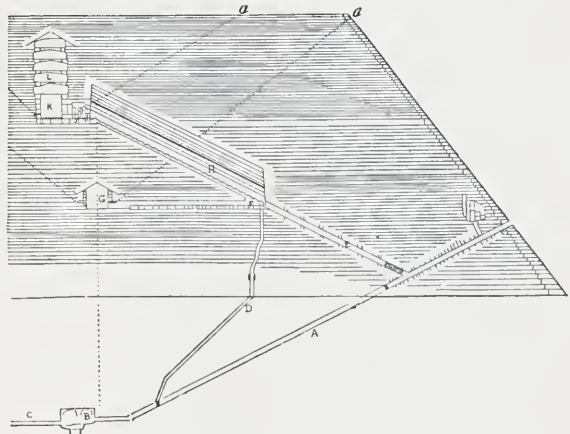

THE INTERIOR OF THE GREAT PYRAMID.³

until Mr. Petrie showed, what we may still see, at the entrance of one of the pyramids of Dahshûr, arrangements which bore witness to the existence of a movable stone mounted on a pivot to serve as a door. It was a method of closing of the same kind as that described by Strabo, perhaps after he had seen it himself, or had heard of it from the guides, and like that which Mr. Petrie had reinstated, with much probability, at the entrance of the Great Pyramid.

² Drawn by Faucher-Gudin, from PETRIE'S *The Pyramids and Temples of Gizeh*, pl. xi.

³ Drawn by Faucher-Gudin, from pl. ix., PETRIE, *The Pyramids and*

unfinished chamber and ends in a *cul-de-sac* 59 feet further on. The blocks are so nicely adjusted, and the surface so finely polished, that the joints can be determined only with difficulty. The corridor which leads to the sepulchral chamber meets the roof at an angle of 120° to the descending passage, and at a distance of 62 feet from the entrance. It ascends for 108 feet to a wide landing-place, where it divides into two branches. One of these penetrates straight towards the centre, and terminates in a granite chamber with a high-pitched roof. This is called, but without reason, the "Chamber of the Queen." The other passage continues to ascend, but its form and appearance are altered. It now becomes a gallery 148 feet long and some 28 feet high, constructed of beautiful Mokattam stone. The lower courses are placed perpendicularly one on the top of the other; each of the upper courses projects above the one beneath, and the last two, which support the ceiling, are only about 1 foot 8 inches distant from each other. The small horizontal passage which separates

Temples of Gizeh. A is the descending passage, B the unfinished chamber, and C the horizontal passage pierced in the rock. D is the narrow passage which provides a communication between chamber B and the landing where the roads divide, and with the passage FG leading to the "Chamber of the Queen." E is the ascending passage, H the high gallery, I and J the chamber of barriers, K the sepulchral vault, L indicates the chambers for relieving the stress; finally, *a, a* are vents which served for the aëration of the chambers during construction, and through which libations were introduced on certain feast-days in honour of Kheops. The draughtsman has endeavoured to render, by lines of unequal thickness, the varying height of the courses of masonry; the facing, which is now wanting, has been reinstated, and the broken line behind it indicates the visible ending of the courses which now form the northern face of the pyramid.

the upper landing from the sarcophagus chamber itself, presents features imperfectly explained. It is intersected almost in the middle by a kind of depressed hall, whose walls are channelled at equal intervals on each side by four longitudinal grooves. The first of these still supports a fine flagstone of granite which seems to hang 3 feet 7 inches above the ground, and the three others were probably intended to receive similar slabs. Four barriers in all were thus interposed between the external world and the vault.² The latter is a kind of rectangular

¹ Facsimile by Boudier of a drawing published in the *Description de l'Égypte, Ant.*, vol. v. pl. xiii. 2.

² This appears to me to follow from the analogous arrangements which I met with in the pyramid of Saqqâra. Mr. Petrie refuses to recognize here a barrier chamber (cf. the notes which he has

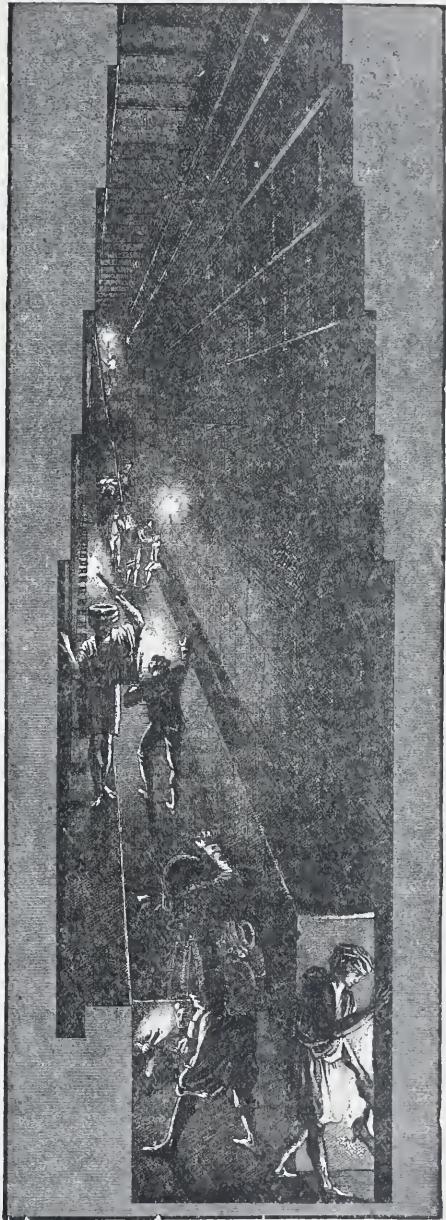

THE ASCENDING PASSAGE OF THE GREAT PYRAMID.¹

granite box, with a flat roof, 19 feet 10 inches high, 1 foot 5 inches deep, and 17 feet broad. No figures or hieroglyphs are to be seen, but merely a mutilated granite sarcophagus without a cover. Such were the precautions taken against man: the result witnessed to their efficacy, for the pyramid preserved its contents intact for more than four thousand years.¹ But a more serious danger threatened them in the great weight of the materials above. In order to prevent the vault from being crushed under the burden of the hundred metres of limestone which surmounted it, they arranged above it five low chambers placed exactly one above the other in order to relieve the superincumbent stress. The highest of these was protected by a pointed roof consisting of enormous blocks made to lean against each other at the

appended to the English translation of my *Archéologie égyptienne*, p. 327, note 27,) but he confesses that the arrangement of the grooves and of the flagstone is still an enigma to him. Perhaps only one of the four intended barriers was inserted in its place—that which still remains.

¹ Professor Petrie thinks that the pyramids of Gizeh were rifled, and the mummies which they contained destroyed during the long civil wars which raged in the interval between the VIth and XIIth dynasties. If this be true, it will be necessary to admit that the kings of one of the subsequent dynasties must have restored what had been damaged, for the workmen of the Caliph Al-Mamoun brought from the sepulchral chamber of the "Horizon" "a stone trough, in which lay a stone statue in human form, enclosing a man who had on his breast a golden pectoral, adorned with precious stones, and a sword of inestimable value, and on his head a carbuncle of the size of an egg, brilliant as the sun, having characters which no man can read." All the Arab authors, whose accounts have been collected by Jomard, relate in general the same story; one can easily recognize from this description the sarcophagus still in its place, a stone case in human shape, and the mummy of Kheops loaded with jewels and arms, like the body of Queen Âhhotpâ I.

top: this ingenious device served to transfer the perpendicular thrust almost entirely to the lateral faces of the blocks. Although an earthquake has to some extent dislocated the mass of masonry, not one of the stones which encase the chamber of the king has been crushed, not one has yielded by a hair's-breadth, since the day when the workmen fixed it in its place.

The Great Pyramid was called Khût, the "Horizon" in which Khûfû had to be swallowed up, as his father the Sun was engulfed every evening in the horizon of the west. It contained only the chambers of the deceased, without a word of inscription, and we should not know to whom it belonged, if the masons, during its construction, had not daubed here and there in red paint among their private marks the name of the king, and the dates of his reign.¹ Worship was rendered to this Pharaoh in a temple constructed a little in front of the eastern side of the pyramid, but of which nothing remains but a mass of ruins. Pharaoh had no need to wait until he was mummified before he became a god; religious rites in his honour were established on his accession; and many of the individuals who made up his court attached themselves to his double long before his double had become disembodied. They served him faithfully during their life, to repose finally in his shadow in the little pyramids and mastabas which clustered around him. Of Dadûfri, his immediate successor, we can probably

¹ The workmen often drew on the stones the cartouches of the Pharaoh under whose reign they had been taken from the quarry, with the exact date of their extraction; the inscribed blocks of the pyramid of Kheops bear, among others, a date of the year XVI.

say that he reigned eight years;¹ but Khephren, the next son who succeeded to the throne,² erected temples and a gigantic pyramid, like his father. He placed it some 394 feet to the south-west of that of Kheops; and called it *Ûîrû*, the Great. It is, however, smaller than its neighbour, and attains a height of only 443 feet, but at a distance the difference in height disappears, and many travellers have thus been led to attribute the same elevation to the two. The facing, of which about one-fourth exists from the summit downwards, is of nummulite limestone, compact, hard, and more homogeneous than that of the courses, with rusty patches here and there due to masses of a reddish lichen, but grey elsewhere, and with a low polish which, at a distance, reflects the sun's rays. Thick walls of unwrought stone enclose the monument on three sides, and there may be seen behind the west front, in an oblong enclosure, a row of stone sheds hastily constructed of limestone and Nile

¹ According to the arrangement proposed by E. de Rougé for the fragments of the Turin Canon. E. de Rougé reads the name *Râ-tot-ef*, and proposes to identify it with the *Ratoïses* of the lists of Manetho, which the copyists had erroneously put out of its proper place. This identification has been generally accepted. Analogy compels us to read *Dadûfri*, like *Khâfri*, *Menkauri*, in which case the hypothesis of de Rougé falls to the ground. The worship of *Dadûfri* was renewed towards the Saïte period, together with that of *Kheops* and *Khephren*, according to some tradition which connected his reign with that of these two kings. On the general scheme of the Manethonian history of these times, see MASPERO, *Notes sur quelques points de Grammaire et d'Histoire dans le Recueil de Travaux*, vol. xvii. pp. 122-138.

² The Westcar Papyrus considers *Khâfri* to be the son of *Khûfû*; this falls in with information given us, in this respect, by Diodorus Siculus. The form which this historian assigns—I do not know on what authority—to the name of the king, *Khabyries*, is nearer the original than the *Khephren* of Herodotus.

mud. Here the labourers employed on the works came every evening to huddle together, and the refuse of their occupation still encumbers the ruins of their dwellings, potsherds, chips of various kinds of hard stone which they had been cutting, granite, alabaster, diorite, fragments of statues broken in the process of sculpture, and blocks of

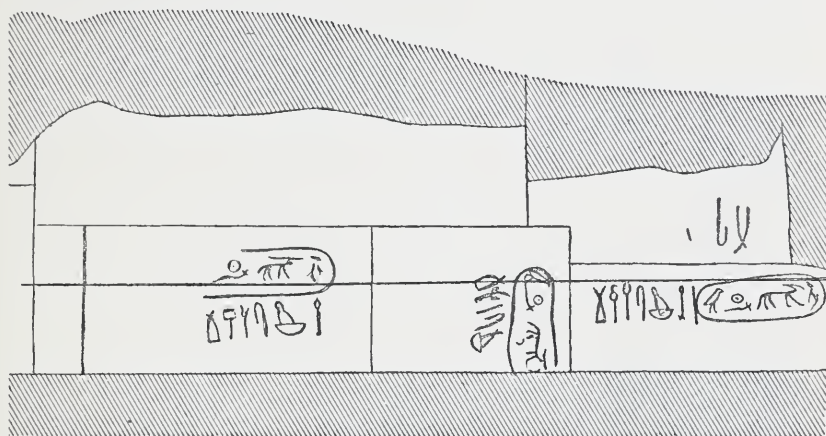

THE NAME OF KHEOPS DRAWN IN RED ON SEVERAL BLOCKS OF THE GREAT PYRAMID.¹

smooth granite ready for use. The chapel commands a view of the eastern face of the pyramid, and communicated by a paved causeway with the temple of the Sphinx, to which it must have borne a striking resemblance.² The

¹ Facsimile by Faucher-Gudin of the sketch in LEPSIUS, *Denkm.*, ii., 1 c.

² The connection of the temple of the Sphinx with that of the second pyramid was discovered in December, 1880, during the last diggings of Mariette. I ought to say that the whole of that part of the building into which the passage leads shows traces of having been hastily executed, and at a time long after the construction of the rest of the edifice; it is possible that the present condition of the place does not date back further than the time of the Antonines, when the Sphinx was cleared for the last time in ancient days.

plan of it can be still clearly traced on the ground, and the rubbish cannot be disturbed without bringing to light portions of statues, vases, and tables of offerings, some of them covered with hieroglyphs, like the mace-head of white

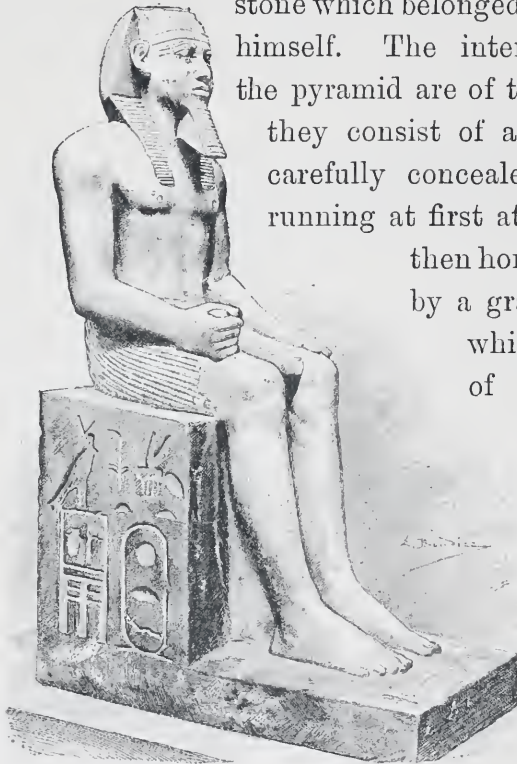

ALABASTER STATUE OF KHEPHREN.¹

stone which belonged in its day to Khephren himself. The internal arrangements of the pyramid are of the simplest character ; they consist of a granite-built passage carefully concealed in the north face, running at first at an angle of 25°, and then horizontally, until stopped

by a granite barrier at a point which indicates a change of direction ; a second

passage, which begins on the outside,

at a distance of some yards in advance of the base

of the pyramid, and proceeds, after

passing through an unfinished chamber,

to rejoin the first ;

finally, a chamber hollowed in the rock, but surmounted by a pointed roof of fine limestone slabs. The sarcophagus was of granite, and, like that of Kheops, bore

¹ Drawn by Boudier, from a photograph by Émil Brugsch-Bey. See on p. 199 the carefully executed drawing of the best preserved among the diorite statues which the Gizeh Museum now possesses of this Pharaoh.

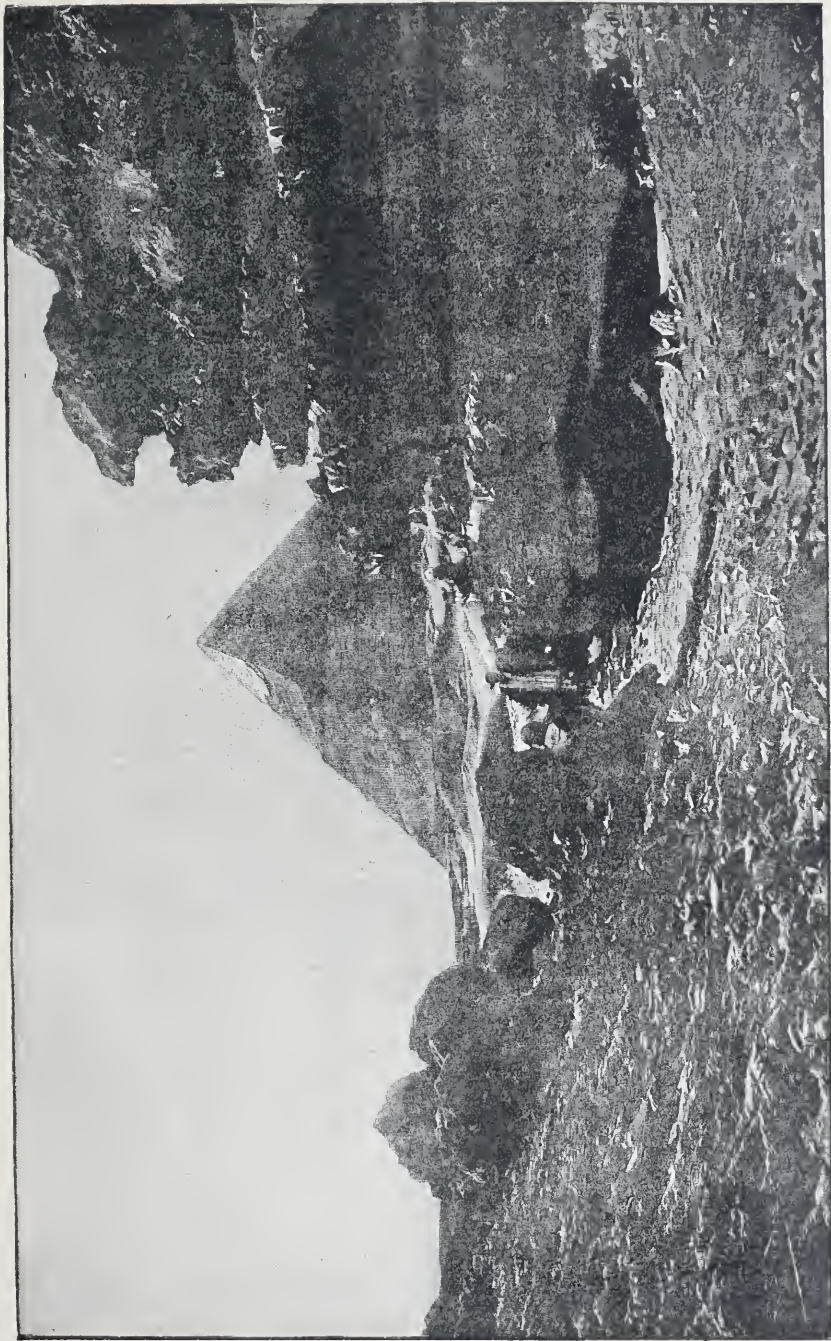

THE PYRAMID OF KHEPHREN, SEEN FROM THE SOUTH-EAST,
DRAWN BY BONDIER, FROM A PHOTOGRAPH BY BEATO.

neither the name of a king nor the representation of a god. The cover was fitted so firmly to the trough that the Arabs could not succeed in detaching it when they rifled the tomb in the year 1200 of our era; they were, therefore, compelled to break through one of the sides with a hammer before they could reach the coffin and take from it the mummy of the Pharaoh.¹

Of Khephren's sons, Menkaûrî (Mykerinos), who was his successor, could scarcely dream of excelling his father and grandfather;² his pyramid, the *Supreme* — Hirû³ — barely attained an elevation of 216 feet, and was exceeded in height by those which were built at a later date.⁴ Up to one-fourth of its height it was faced with syenite, and the remainder, up to the summit, with limestone.⁵ For lack of time, doubtless, the dressing of the

¹ The second pyramid was opened to Europeans in 1816 by Belzoni. The exact date of the entrance of the Arabs is given us by an inscription, written in ink, on one of the walls of the sarcophagus chamber: "Mohammed Ahmed Effendi, the quarryman, opened it; Othman Effendi was present, as well as the King Ali Mohammed, at the beginning and at the closing." The King Ali Mohammed was the son and successor of Saladin.

² Classical tradition makes Mykerinos the son of Kheops. Egyptian tradition regards him as the son of Khephren, and with this agrees a passage in the Westcar Papyrus, in which a magician prophesies that after Kheops his son (Khâfri) will yet reign, then the son of the latter (Menkaûrî), then a prince of another family.

³ An inscription, unfortunately much mutilated, from the tomb of Tabhûni, gives an account of the construction of the pyramid, and of the transport of the sarcophagus.

⁴ Professor Petrie reckons the exact height of the pyramid at 2564 ± 15 or 2580 ± 2 inches; that is to say, 214 or 215 feet in round numbers.

⁵ According to Herodotus, the casing of granite extended to half the height. Diodorus states that it did not go beyond the fifteenth course. Professor Petrie discovered that there were actually sixteen lower courses in red granite.

granite was not completed, but the limestone received all the polish it was capable of taking. The enclosing wall

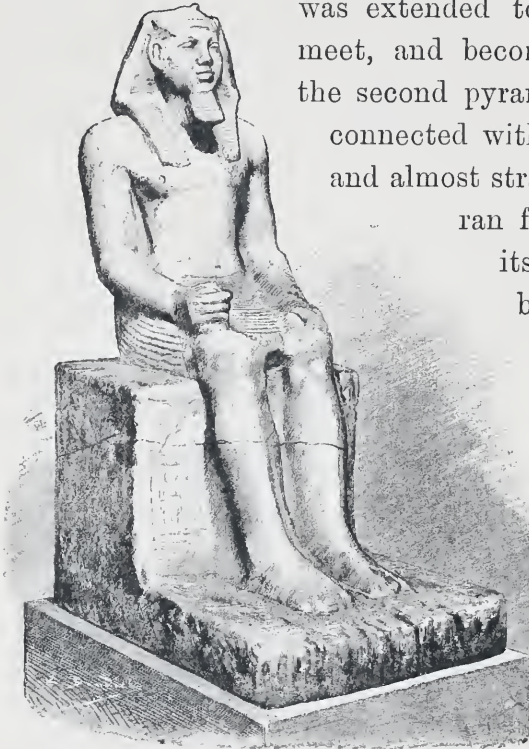

DIORITE STATUE OF MENKAÛRÎ.²

was extended to the north so as to meet, and become one with, that of the second pyramid. The temple was connected with the plain by a long and almost straight causeway, which ran for the greater part of its course¹ upon an embankment raised above the neighbouring ground. This temple was in fair condition in the early years of the eighteenth century,³ and so much of it as has escaped the ravages of the

¹ This causeway should not be confounded, as is frequently done, with that which may be seen at some distance to the east in the plain: the latter led to limestone quarries in the mountain to the south of the plateau on which the pyramids stand. These quarries were worked in very ancient times.

² Drawn by Boudier, from a photograph, by Émil Brugsch-Bey, of a statue preserved in the Museum of Gizeh.

³ Benoit de Maillet visited this temple between 1692 and 1708. "It is almost square in form. There are to be found inside four pillars which doubtless supported a vaulted roof covering the altar of the idol, and one moved around these pillars as in an ambulatory. These stones were cased with granitic marble. I found some pieces still unbroken which had been

Mameluks, bears witness to the scrupulous care and refined art employed in its construction. Coming from the plain, we first meet with an immense halting-place measuring 100 feet by 46 feet, and afterwards enter a large court with an egress on each side: beyond this we can distinguish the ground-plan only of five chambers, the central one, which is in continuation with the hall, terminating at a distance of some 42 feet from the pyramid, exactly opposite the middle point of the eastern face. The whole mass of the building covers a rectangular area 184 feet long by a little over 177 feet broad. Its walls, like those of the temple of the Sphinx, contained a core of limestone 7 feet 10 inches thick, of which the blocks have been so ingeniously put together as to suggest the idea that the whole is cut out of the rock. This core was covered with a casing of granite and alabaster, of which the remains preserve no trace of hieroglyphs or of wall scenes: the founder had caused his name to be inscribed on the statues, which received, on his behalf, the offerings, and also on the northern face of the pyramid, where it was still shown to the curious towards the first century of our era. The arrangement of the interior of the pyramid is somewhat complicated, and bears witness to changes brought unexpectedly about in the course of construction. The original central mass probably did not exceed 180 feet in breadth at the base, with a vertical height of 154 feet. It contained a sloping passage cut into the hill itself, and an oblong low-roofed

attached to the stones with mastic. I believe that the exterior as well as the interior of the temple was cased with this marble" (LE MASCRIFER, *Description de l'Égypte*, 1735, pp. 223, 224).

cell devoid of ornament. The main bulk of the work had been already completed, and the casing not yet begun,



THE COFFIN OF
MYKERINOS.³

when it was decided to alter the proportions of the whole. Mykerinos was not, it appears, the eldest son and appointed heir of Khephren; while still a mere prince he was preparing for himself a pyramid similar to those which lie near the "Horizon," when the deaths of his father and brother called him to the throne. What was sufficient for him as a child, was no longer suitable for him as a Pharaoh; the mass of the structure was increased to its present dimensions, and a new inclined passage was effected in it, at the end of which a hall panelled with granite gave access to a kind of ante-chamber.¹ The latter communicated by a horizontal corridor with the first vault, which was deepened for the occasion; the old entrance, now no longer of use, was roughly filled up.² Mykerinos did not find

¹ Vyse discovered here fragments of a granite sarcophagus, perhaps that of the queen; the legends which Herodotus (ii. 134, 135), and several Greek authors after him, tell concerning this, show clearly that an ancient tradition assumed the existence of a female mummy in the third pyramid alongside of that of the founder Mykerinos.

² Vyse has noticed, in regard to the details of the structure, that the passage now filled up is the only one driven from the outside to the interior; all the others were made from the inside to the outside, and consequently at a period when this passage, being the only means of penetrating into the interior of the monument, had not yet received its present dimensions.

³ Drawn by Faucher-Gudin. The coffin is in the British Museum. The

his last resting-place in this upper level of the interior of the pyramid: a narrow passage, hidden behind the slabbing of the second chamber, descended into a secret crypt, lined with granite and covered with a barrel-vaulted roof. The sarcophagus was a single block of blue-black basalt, polished, and carved into the form of a house, with a façade having three doors and three openings in the form of windows, the whole framed in a rounded moulding and surmounted by a projecting cornice such as we are accustomed to see on the temples.¹ The mummy-case of cedar-wood had a man's head, and was shaped to the form of the human body; it was neither painted nor gilt, but an inscription in two columns, cut on its front, contained the name of the Pharaoh, and a prayer on his behalf: "Osiris, King of the two Egypts, Menkaûrî, living eternally, given birth to by heaven, conceived by Nûit, flesh of Sibû, thy mother Nûit has spread herself out over thee in her name of 'Mystery of the Heavens,' and she has granted that thou shouldest be a god, and that thou shouldest repulse thine enemies, O King of the two Egypts, Menkaûrî, living eternally." The Arabs opened the mummy to see if it contained any precious jewels, but found within it only some leaves of

drawing of it was published by Vyse, by Birch-Lenormant, and by Lepsius. Herr Sethe has recently revived an ancient hypothesis, according to which it had been reworked in the Saïte period, and he has added to archæological considerations, up to that time alone brought to bear upon the question, new philological facts.

¹ It was lost off the coast of Spain in the vessel which was bringing it to England. We have only the drawing remaining which was made at the time of its discovery, and published by Vyse. M. Borchardt has attempted to show that it was reworked under the XXVIth Saïte dynasty as well as the wooden coffin of the king.

gold, probably a mask or a pectoral covered with hieroglyphs. When Vyse reopened the vault in 1837, the bones lay scattered about in confusion on the dusty floor, mingled with bundles of dirty rags and wrappings of yellowish woollen cloth.

The worship of the three great pyramid-building kings continued in Memphis down to the time of the Greeks and Romans. Their statues, in granite, limestone, and

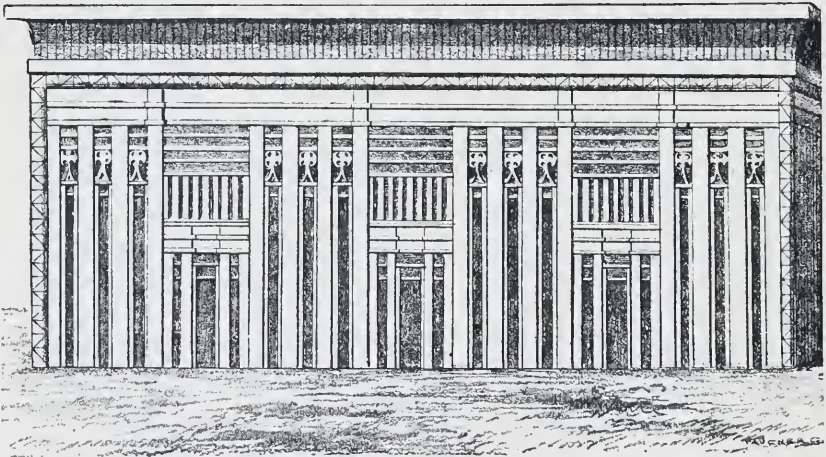

THE GRANITE SARCOPHAGUS OF MYKERINOS.¹

alabaster, were preserved also in the buildings annexed to the temple of Phtah, where visitors could contemplate these Pharaohs as they were when alive. Those of Khephren show us the king at different ages, when young, mature, or already in his decadence. They are in most cases cut out of a breccia of green diorite, with long irregular yellowish veins, and of such hardness that it is difficult to determine

¹ Drawn by Faucher-Gudin, from a chromolithograph in PRISSE D'AVENNES, *Histoire de l'Art Égyptien*.

the tool with which they were worked. The Pharaoh sits squarely on his royal throne, his hands on his lap, his body firm and upright, and his head thrown back with a look of self-satisfaction. A sparrow-hawk perched on the back of his seat covers his head with its wings—an image of the god Horus protecting his son. The modelling of the torso and legs of the largest of these statues, the dignity of its pose, and the animation of its expression, make of it a unique work of art which may be compared with the most perfect products of antiquity. Even if the cartouches which tell us the name of the king had been hammered away and the insignia of his rank destroyed, we should still be able to determine the Pharaoh by his bearing: his whole appearance indicates a man accustomed from his infancy to feel himself invested with limitless authority. Mykerinos stands out less impassive and haughty: he does not appear so far removed from humanity as his predecessor, and the expression of his countenance agrees, somewhat singularly, with the account of his piety and good nature preserved by the legends. The Egyptians of the Theban dynasties, when comparing the two great pyramids with the third, imagined that the disproportion in their size corresponded with a difference of character between their royal occupants. Accustomed as they were from infancy to gigantic structures, they did not experience before “the Horizon” and “the Great” the feeling of wonder and awe which impresses the beholder of to-day. They were not the less apt on this account to estimate the amount of labour and effort required to complete them from top to bottom. This labour seemed to them to surpass the

most excessive *corvée* which a just ruler had a right to impose upon his subjects, and the reputation of Kheops and Khephren suffered much in consequence. They were

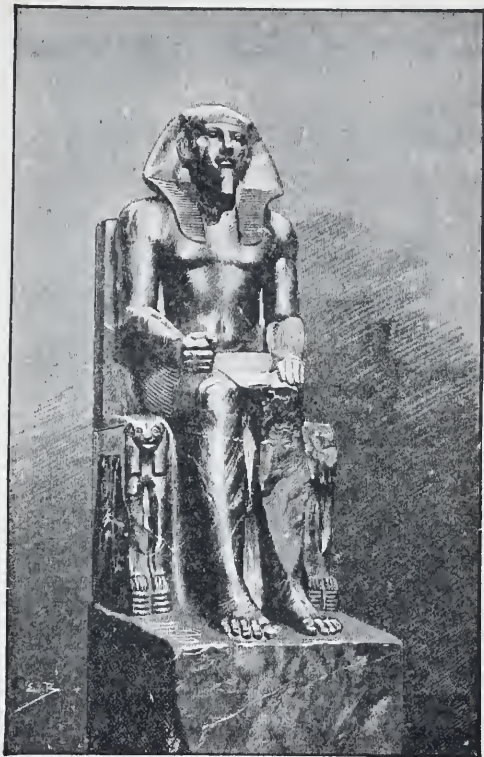

DIORITE STATUE OF KHEPHREN, GÍZEH MUSEUM.¹

accused of sacrilege, of cruelty, and profligacy. It was urged against them that they had arrested the whole life of their people for more than a century for the erection of their tombs. "Kheops began by closing the temples and by prohibiting the offering of sacrifices: he then compelled all the Egyptians to work for him. To some he assigned the task of dragging the blocks from the quarries of the Arabian chain to the Nile: once shipped, the duty was incumbent

on others of transporting them as far as the Libyan chain. A hundred thousand men worked at a time, and were relieved every three months.² The period of the

¹ Drawn by Boudier, from a photograph by Émil Brugsch-Bey. It is one of the most complete statues found by Mariette in the temple of the Sphinx.

² Professor Petric thinks that this detail rests upon an authentic

people's suffering was divided as follows: ten years in making the causeway along which the blocks were dragged—a work, in my opinion, very little less onerous than that of erecting the pyramid, for its length was five *stadia*, its breadth ten *orgyie*, its greatest height eight, and it was made of cut stone and covered with figures.¹ Ten years, therefore, were consumed in constructing this causeway and the subterranean chambers hollowed out in the hill. . . . As for the pyramid itself, twenty years were employed in the making of it. . . . There are recorded on it, in Egyptian characters, the value of the sums paid in turnips, onions, and garlic, for the labourers attached to the works; if I remember aright, the interpreter who deciphered the inscription told me that the total amounted to sixteen hundred talents of silver. If this were the case, how much must have been expended for iron to make tools, and for provisions and clothing for the workmen?"² The whole

tradition. The inundation, he says, lasts three months, during which the mass of the people have nothing to do; it was during these three months that Kheops raised the 100,000 men to work at the transport of the stone. The explanation is very ingenious, but it is not supported by the text: Herodotus does not relate that 100,000 men were called by the *corvée* for three months every year; but from three months to three months, possibly four times a year, bodies of 100,000 men relieved each other at the work. The figures which he quotes are well-known legendary numbers, and we must leave the responsibility for them to the popular imagination (WIEDEMANN, *Herodots Zweites Buch*, p. 465).

¹ Diodorus Siculus declares that there were no causeways to be seen in his time. The remains of one of them appear to have been discovered and restored by Vyse.

² HERODOTUS, ii. 124, 125. The inscriptions which were read upon the pyramids were the graffiti of visitors, some of them carefully executed. The figures which were shown to Herodotus represented, according to the dragoon, the value of the sums expended for vegetables for the workmen; we

resources of the royal treasure were not sufficient for such necessities: a tradition represents Kheops as at the end of his means, and as selling his daughter to any one that offered, in order to procure money.¹ Another legend, less disrespectful to the royal dignity and to paternal authority, assures us that he repented in his old age, and that he wrote a sacred book much esteemed by the devout.² Khephren had imitated, and thus shared with, him, the hatred of posterity. The Egyptians avoided naming these wretches: their work was attributed to a shepherd called Philitis, who in ancient times pastured his flocks in the mountain; and even those who did not refuse to them the glory of having built the most enormous sepulchres in the world, related that they had not the satisfaction of reposing in them after their death. The people, exasperated at the tyranny to which they had been subject, swore that they would tear the bodies of these Pharaohs

ought, probably, to regard them as the *thousands* which, in many of the votive temples, served to mark the quantities of different things presented to the god, that they might be transmitted to the deceased.

¹ HERODOTUS, ii. 126. She had profited by what she received to build a pyramid for herself in the neighbourhood of the great one—the middle one of the three small pyramids: it would appear in fact, that this pyramid contained the mummy of a daughter of Kheops, Honitsonû.

² MANETHO, UNGER'S edition, p. 91. The ascription of a book to Kheops, or rather the account of the discovery of a "sacred book" under Kheops, is quite in conformity with Egyptian ideas. The British Museum possesses two books, which were thus discovered under this king; the one, a medical treatise, in a temple at Coptos; the other comes from Tanis. Among the works on alchemy published by M. Berthelot, there are two small treatises ascribed to Sophé, possibly Souphis or Kheops: they are of the same kind as the book mentioned by Manetho, and which Syncellus says was bought in Egypt.

from their tombs, and scatter their fragments to the winds : they had to be buried in crypts so securely placed that no one has succeeded in finding them.

Like the two older pyramids, “the Supreme” had its anecdotal history, in which the Egyptians gave free rein to their imagination. We know that its plan had been rearranged in the course of building, that it contained two sepulchral chambers, two sarcophagi, and two mummies : these modifications, it was said, belonged to two distinct reigns ; for Mykerinos had left his tomb unfinished, and a woman had finished it at a later date—according to some, Nitokris, the last queen of the VIth dynasty ; according to others, Rhodopis, the Ionian who was the mistress of Psammetichus I. or of Amasis.¹ The beauty and richness of the granite casing dazzled all eyes, and induced many visitors to prefer the least of the pyramids to its two imposing sisters ; its comparatively small size is excused on the ground that its founder had returned to that moderation and piety which ought to characterize a good king. “The actions of his father were not pleasing to him ; he reopened the temples and sent the people, reduced to

¹ Zoega had already recognized that the Rhodopis of the Greeks was no other than the Nitokris of Manetho, and his opinion was adopted and developed by Bunsen. The legend of Rhodopis was completed by the additional ascription to the ancient Egyptian queen of the character of a courtesan : this repugnant trait seems to have been borrowed from the same class of legends as that which concerned itself with the daughter of Kheops and her pyramid. The narrative thus developed was in a similar manner confounded with another popular story, in which occurs the episode of the slipper, so well known from the tale of Cinderella. Herodotus connects Rhodopis with his Amasis, Ælian with King Psammetichus of the XXVIth dynasty.

the extreme of misery, back to their religious observances and their occupations; finally, he administered justice more equitably than all other kings. On this head he is praised above those who have at any time reigned in Egypt: for not only did he administer good justice, but if any one complained of his decision he gratified him with some present in order to appease his wrath." There was one point, however, which excited the anxiety of many in a country where the mystic virtue of numbers was an article of faith: in order that the laws of celestial arithmetic should be observed in the construction of the pyramids, it was necessary that three of them should be of the same size. The anomaly of a third pyramid out of proportion to the two others could be explained only on the hypothesis that Mykerinos, having broken with paternal usage, had ignorantly infringed a decree of destiny—a deed for which he was mercilessly punished. He first lost his only daughter; a short time after he learned from an oracle that he had only six more years to remain upon the earth. He enclosed the corpse of his child in a hollow wooden heifer, which he sent to Sais, where it was honoured with divine worship.¹ "He then communicated his reproaches

¹ HERODOTUS, ii. 129–133. The manner in which Herodotus describes the cow which was shown to him in the temple of Sais, proves that he was dealing with Nit, in animal form, Mihî-ûirit, the great celestial heifer who had given birth to the Sun. How the people could have attached to this statue the legend of a daughter of Mykerinos is now difficult to understand. The idea of a mummy or a corpse shut up in a statue, or in a coffin, was familiar to the Egyptians: two of the queens interred at Dêir el-Bahârî, Nofritari Âlhotpû II., were found hidden in the centre of immense Osirian figures of wood, covered with stuccoed fabric. Egyptian tradition supposed that the

to the god, complaining that his father and his uncle, after having closed the temples, forgotten the gods and oppressed mankind, had enjoyed a long life, while he, devout as he was, was so soon about to perish. The oracle answered that it was for this very reason that his days were shortened, for he had not done that which he ought to have done. Egypt had to suffer for a hundred and fifty years, and the two kings his predecessors had known this, while he had not. On receiving this answer, Mykerinos, feeling himself condemned, manufactured a number of lamps, lit them every evening at dusk, began to drink and to lead a life of jollity, without ceasing for a moment night and day, wandering by the lakes and in the woods wherever he thought to find an occasion of pleasure. He had planned this in order to convince the oracle of having spoken falsely, and to live twelve years, the nights counting as so many days." Legend places after him Asychis or Sasychis, a later builder of pyramids, but of a different kind. The latter preferred brick as a building material, except in one place, where he introduced a stone bearing the following inscription: "Do not despise me on account of the stone pyramids: I surpass them as much as Zeus the other gods. Because, a pole being plunged into a lake and the clay which stuck to it being collected, the brick out of which I was constructed was moulded from it." The virtues of

bodies of the gods rested upon the earth. The cow *Mihi-ûirit* might, therefore, be bodily enclosed in a sarcophagus in the form of a heifer, just as the mummified gazelle of *Dêr el-Baharî* is enclosed in a sarcophagus of gazelle form; it is even possible that the statue shown to Herodotus really contained what was thought to be a mummy of the goddess.

Asychis and Mykerinos helped to counteract the bad impression which Kheops and Khephren had left behind them. Among the five legislators of Egypt Asychis stood out as one of the best. He regulated, to minute details, the ceremonies of worship. He invented geometry and the art of observing the heavens.¹ He put forth a law on lending, in which he authorized the borrower to pledge in forfeit the mummy of his father, while the creditor had the right of treating as his own the tomb of the debtor: so that if the debt was not met, the latter could not obtain a last resting-place for himself or his family either in his paternal or any other tomb.

History knows nothing either of this judicious sovereign or of many other Pharaohs of the same type, which the dragomans of the Greek period assiduously enforced upon the respectful attention of travellers. It merely affirms that the example given by Kheops, Khephren, and Mykerinos were by no means lost in later times. From the beginning of the IVth to the end of the XIVth dynasty—during more than fifteen hundred years—the construction of pyramids was a common State affair, provided for by the administration, secured by special services. Not only did the Pharaohs build them for themselves, but the princes and princesses belonging to the family of the Pharaohs constructed theirs, each one according to his resources;

¹ DIODORUS, i. 94. It seems probable that Diodorus had received knowledge from some Alexandrian writer, now lost, of traditions concerning the legislative acts of Shashanqu I. of the XXIInd dynasty; but the name of the king, commonly written Sesonkhis, had been corrupted by the dragoman into Sasykhis.

three of these secondary mausoleums are ranged opposite the eastern side of "the Horizon," three opposite the southern face of "the Supreme," and everywhere else—near Abousir, at Saqqâra, at Dahshûr or in the Fayûm—the majority of the royal pyramids attracted around them a more or less numerous cortège of pyramids of princely foundation often debased in shape and faulty in proportion. The materials for them were brought from the Arabian chain. A spur of the latter, projecting in a straight line towards the Nile, as far as the village of Troiû, is nothing but a mass of the finest and whitest limestone. The Egyptians had quarries here from the earliest times. By cutting off the stone in every direction, they lowered the point of this spur for a depth of some hundreds of metres. The appearance of these quarries is almost as astonishing as that of the monuments made out of their material. The extraction of the stone was carried on with a skill and regularity which denoted ages of experience. The tunnels were so made as to exhaust the finest and whitest seams without waste, and the chambers were of an enormous extent; the walls were dressed, the pillars and roofs neatly finished, the passages and doorways made of a regular width, so that the whole presented more the appearance of a subterranean temple than of a place for the extraction of building materials.¹ Hastily written graffiti, in red and

¹ The description of the quarries of Turah, as they were at the beginning of the century, was somewhat briefly given by Jomard, afterwards more completely by Perring. During the last thirty years the Cairo masons have destroyed the greater part of the ancient remains formerly existing in this district, and have completely changed the appearance of the place.

black ink, preserve the names of workmen, overseers, and engineers, who had laboured here at certain dates, calculations of pay or rations, diagrams of interesting details, as well as capitals and shafts of columns, which were shaped out on the spot to reduce their weight for transport. Here and there true official stelæ are to be found set apart in a suitable place, recording that after a long interruption such or such an illustrious sovereign had resumed the excavations, and opened fresh chambers. Alabaster was met with not far from here in the Wady Gerrauî. The Pharaohs of very early times established a regular colony here, in the very middle of the desert, to cut the material into small blocks for transport: a strongly built dam, thrown across the valley, served to store up the winter and spring rains, and formed a pond whence the workers could always supply themselves with water. Kheops and his successors drew their alabaster from Hâtnûbû, in the neighbourhood of Hermopolis, their granite from Syene, their diorite and other hard rocks, the favourite material for their sarcophagi, from the volcanic valleys which separate the Nile from the Red Sea—especially from the Wady Hammamât. As these were the only materials of which the quantity required could not be determined in advance, and which had to be brought from a distance, every king was accustomed to send the principal persons of his court to the quarries of Upper Egypt, and the rapidity with which they brought back the stone constituted a high claim on the favour of their master. If the building was to be of brick, the bricks were made on the spot, in the plain at the foot of the hills. If it was to be a limestone structure, the neighbouring parts

of the plateau furnished the rough material in abundance. For the construction of chambers and for casing walls, the rose granite of Elephantiⁿê and the limestone of Troi^u were commonly employed, but they were spared the labour of procuring these specially for the occasion. The city of the White Wall had always at hand a supply of them in its stores, and they might be drawn upon freely for public buildings, and consequently for the royal tomb. The blocks chosen from this reserve, and conveyed in boats close under the mountain-side, were drawn up slightly inclined causeways by oxen to the place selected by the architect.

The internal arrangements, the length of the passages and the height of the pyramids, varied much: the least of them had a height of some thirty-three feet merely. As it is difficult to determine the motives which influenced the Pharaohs in building them of different sizes, some writers have thought that the mass of each increased in proportion to the time bestowed upon its construction—that is to say, to the length of each reign. As soon as a prince mounted the throne, he would probably begin by roughly sketching out a pyramid sufficiently capacious to contain the essential elements of the tomb; he would then, from year to year, have added fresh layers to the original nucleus, until the day of his death put an end for ever to the growth of the monument.¹ This hypothesis is not borne out by facts:

¹ This was the theory formulated by Lepsius, after the researches made by himself, and the work done by Erbkam, and the majority of Egyptologists adopted it, and still maintain it. It was vigorously attacked by Perrot-Chipiez and by Petrie; it was afterwards revived, with amendments, by

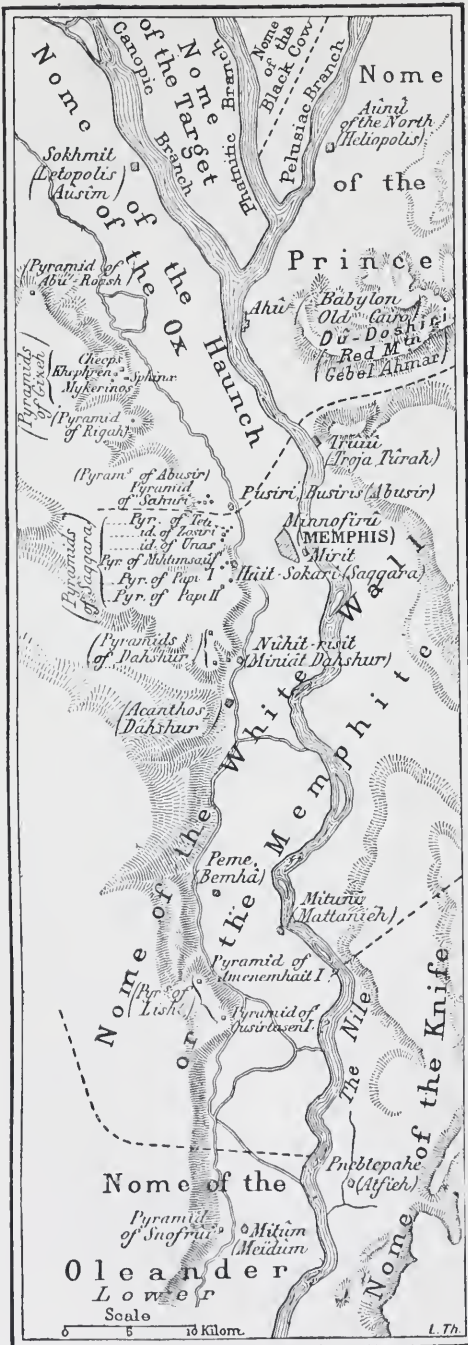

such a small pyramid as that of Saqqâra belonged to a Pharaoh who reigned thirty years, while "the Horizon" of Gîzeh is the work of Kheops, whose rule lasted only twenty-three years. The plan of each pyramid was arranged once for all by the architect, according to the instructions he had received, and the resources at his command. Once set on foot, the work was continued until its completion, without addition or diminution, unless something unforeseen occurred. The pyramids, like the

Borchardt whose conclusions have been accepted by Ed. Meyer. The examinations which I have had the opportunity of bestowing on the pyramids of Saqqâra, Abusir, Dahshûr, Rîgah, and Lisht have shown me that the theory is not applicable to any of these monuments.

THE MEMPHITE NOME AND THE POSITION OF THE PYRAMIDS OF THE ANCIENT EMPIRE.

mastabas, ought to present their faces to the four cardinal points; but owing to unskilfulness or negligence, the majority of them are not very accurately orientated, and several of them vary sensibly from the true north. The great pyramid of Saqqâra does not describe a perfect square at its base, but is an oblong rectangle, with its longest sides east and west; it is stepped—that is to say, the six sloping sided cubes of which it is composed are placed upon one another so as to form a series of treads and risers, the former being about two yards wide and the latter of unequal heights. The highest of the stone pyramids of Dahshûr makes at its lower part an angle of $54^{\circ} 41'$ with the horizon, but at half its height the angle becomes suddenly more acute and is reduced to $42^{\circ} 59'$. It reminds one of a mastaba with a sort of huge attic on the top. Each of these monuments had its enclosing wall, its chapel and its college of priests, who performed there for ages sacred rites in honour of the deceased prince, while its property in mortmain was administered by the chief of the “priests of the double.” Each one received a name, such as “the Fresh,” “the Beautiful,” “the Divine in its places,” which conferred upon it a personality and, as it were, a living soul. These pyramids formed to the west of the White Wall a long serrated line whose extremities were lost towards the south and north in the distant horizon: Pharaoh could see them from the terraces of his palace, from the gardens of his villa, and from every point in the plain in which he might reside between Heliopolis and Mèdûm—as a constant reminder of the lot which awaited him in spite of his divine origin. The people, awed and inspired by the number of

them, and by the variety of their form and appearance, were accustomed to tell stories of them to one another, in which the supernatural played a predominant part. They were able to estimate within a few ounces the heaps of gold and silver, the jewels and precious stones, which adorned the royal mummies or filled the sepulchral chambers: they were acquainted with every precaution taken by the architects to ensure the safety of all these riches from robbers, and were convinced that magic had added to such safeguards the more effective protection of talismans and genii. There was no pyramid so insignificant that it had not its mysterious protectors, associated with some amulet—in most cases with a statue, animated by the double of the founder. The Arabs of to-day are still well acquainted with these protectors, and possess a traditional respect for them. The great pyramid concealed a black and white image, seated on a throne and invested with the kingly sceptre. He who looked upon the statue “heard a terrible noise proceeding from it which almost caused his heart to stop beating, and he who had heard this noise would die.” An image of rose-coloured granite watched over the pyramid of Khephren, standing upright, a sceptre in its hand and the uræus on its brow, “which serpent threw himself upon him who approached it, coiled itself around his neck, and killed him.” A sorcerer had invested these protectors of the ancient Pharaohs with their powers, but another equally potent magician could elude their vigilance, paralyze their energies, if not for ever, at least for a sufficient length of time to ferret out the treasure and rifle the mummy. The cupidity of the fellahîn, highly inflamed

by the stories which they were accustomed to hear, gained the mastery over their terror, and emboldened them to risk their lives in these well-guarded tombs. How many pyramids had been already rifled at the beginning of the second Theban empire !

The IVth dynasty became extinct in the person of Shoptiskaf, the successor and probably the son of Mykerinos.¹ The learned of the time of Ramses II. regarded the family which replaced this dynasty as merely a secondary branch of the line of Snofrûi, raised to power by the capricious laws which settled hereditary questions.² Nothing on the contemporary monuments, it is true, gives indication of a violent change attended by civil war, or resulting from a revolution at court : the construction and decoration of the

¹ The series of kings beginning with Mykerinos was drawn up for the first time in an accurate manner by E. DE ROUGÉ, *Recherches sur les Monuments qu'on peut attribuer aux six premières dynasties*, pp. 66-84. M. de Rougé's results have been since adopted by all Egyptologists. The table of the IVth dynasty, restored as far as possible with the approximate dates, is subjoined :—

| According to the Turin Canon and the Monuments. | According to Manetho. |
|--|-------------------------|
| SNOFRÛI (4100-4076 ?) 24 | SORIS 29 |
| KHÛFÛI (4075-4052 ?) 23 | SOUPHIS I. 63 |
| DADUFÛI (4051-4043 ?) 8 | SOUPHIS II. 66 |
| KHAFRI (4042-?) ? | MENKHERES 63 |
| MENKAÛRI ? | RATOISES 25 |
| SHOPSISKAF ? | BIKHERES 22 |
| | SEBERKHERES 7 |
| | TAMPITHIS 9 |

² The fragments of the royal Turin Papyrus exhibit, in fact, no separation between the kings which Manetho attributes to the IVth dynasty and those which he ascribes to the Vth, which seems to show that the Egyptian annalist considered them all as belonging to one and the same family of Pharaohs.

tombs continued without interruption and without indication of haste, the sons-in-law of Shopsiskaf and of Mykerinos, their daughters and grandchildren, possess under the new kings, the same favour, the same property, the same privileges, which they had enjoyed previously. It was stated, however, in the time of the Ptolemies, that the Vth dynasty had no connection with the IVth; it was regarded at Memphis as an intruder, and it was asserted that it came from Elephantinê.¹ The tradition was a very old one, and its influence is betrayed in a popular story, which was current at Thebes in the first years of the New Empire. Kheops, while in search of the mysterious books of Thot in order to transcribe from them the text for his sepulchral chamber,² had asked the magician Didi to be good enough to procure them for him; but the latter refused the perilous task imposed upon him. “‘Sire, my lord, it is not I who shall bring them to thee.’ His Majesty asks: ‘Who, then, will bring them to me?’ Didi replies,

¹ Such is the tradition accepted by Manetho. Lepsius thinks that the copyists of Manetho were under some distracting influence, which made them transfer the record of the origin of the VIth dynasty to the Vth: it must have been the VIth dynasty which took its origin from Elephantinê. I think the safest plan is to respect the text of Manetho until we know more, and to admit that he knew of a tradition ascribing the origin of the Vth dynasty to Elephantinê.

² The Great Pyramid is mute, but we find in other pyramids inscriptions of some hundreds of lines. The author of the story, who knew how much certain kings of the VIth dynasty had laboured to have extracts of the sacred books engraved within their tombs, fancied, no doubt, that his Kheops had done the like, but had not succeeded in procuring the texts in question, probably on account of the impiety ascribed to him by the legends. It was one of the methods of explaining the absence of any religious or funereal inscription in the Great Pyramid.

‘It is the eldest of the three children who are in the womb of Ruditdidit who will bring them to thee.’ His Majesty says: ‘By the love of Râ! what is this that thou tellest me; and who is she, this Ruditdidit?’ Didi says to him: ‘She is the wife of a priest of Râ, lord of Sakhîbû. She carries in her womb three children of Râ, lord of Sakhîbû, and the god has promised to her that they shall fulfil this beneficent office in this whole earth,¹ and that the eldest shall be the high priest at Heliopolis.’ His Majesty, his heart was troubled at it, but Didi says to him: “What are these thoughts, sire, my lord? Is it because of these three children? Then I say to thee: Thy son, his son, then one of these.’”² The good King Kheops doubtless tried to lay his hands upon this threatening trio at the moment of their birth; but Râ had anticipated this, and saved his offspring. When the time for their birth drew near, the Majesty of Râ, lord of Sakhîbû, gave orders to Isis, Nephthys, Maskhonit, Hiquit,³ and Khnûmû: “Come, make haste and run to

¹ This kind of circumlocution is employed on several occasions in the old texts to designate royalty. It was contrary to etiquette to mention directly, in common speech, the Pharaoh, or anything belonging to his functions or his family. Cf. pp. 28, 29 of this History.

² This phrase is couched in oracular form, as befitting the reply of a magician. It appears to have been intended to reassure the king in affirming that the advent of the three sons of Râ would not be immediate: his son, then a son of this son, would succeed him before destiny would be accomplished, and one of these divine children succeed to the throne in his turn. The author of the story took no notice of Dadufrî or Shopsiskaf, of whose reigns little was known in his time.

³ Hiquit as the frog-goddess, or with a frog’s head, was one of the midwives who is present at the birth of the sun every morning. Her presence is, therefore, natural in the case of the spouse about to give birth to royal sons of the sun.

deliver Rudîtdidit of these three children which she carries in her womb to fulfil that beneficent office in this whole earth, and they will build you temples, they will furnish your altars with offerings, they will supply your tables with libations, and they will increase your mortmain possessions." The goddesses disguised themselves as dancers and itinerant musicians: Khuûmû assumed the character of servant to this band of nautch-girls and filled the bag with provisions, and they all then proceeded together to knock at the door of the house in which Rudîtdidit was awaiting her delivery. The earthly husband Raûsîr, unconscious of the honour that the gods had in store for him, introduced them to the presence of his wife, and immediately three male children were brought into the world one after the other. Isis named them, Maskhonît predicted for them their royal fortune, while Khuûmû infused into their limbs vigour and health; the eldest was called Ûsirkaf, the second Sahûrî, the third Kakiû. Raûsîr was anxious to discharge his obligation to these unknown persons, and proposed to do so in wheat, as if they were ordinary mortals: they had accepted it without compunction, and were already on their way to the firmament, when Isis recalled them to a sense of their dignity, and commanded them to store the honorarium bestowed upon them in one of the chambers of the house, where henceforth prodigies of the strangest character never ceased to manifest themselves. Every time one entered the place a murmur was heard of singing, music, and dancing, while acclamations such as those with which kings are wont to be received gave sure presage of the destiny which awaited

the newly born. The manuscript is mutilated, and we do not know how the prediction was fulfilled. If we may trust the romance, the three first princes of the Vth dynasty were brothers, and of priestly descent, but our experience of similar stories does not encourage us to take this one very seriously: did not such tales affirm that Kheops and Khephren were brothers also?

The Vth dynasty manifested itself in every respect as the sequel and complement of the IVth.¹ It reckons nine Pharaohs after the three which tradition made sons of the god Râ himself and of Ruditdidit. They reigned for a century and a half; the majority of them have left monuments, and the last four, at least, *Ûsirniri Ânû*, *Menkaûhorû*, *Dadkeri Assi*, and *Ûnas*, appear to have ruled gloriously. They all built pyramids,² they repaired temples

¹ A list is appended of the known Pharaohs of the Vth dynasty, restored as far as can be, with the closest approximate dates of their reigns:—

| From the Turin Canon and the Monuments. | From Manetho. |
|--|---------------------------------|
| <i>ÛSIRKAF</i> (3990–3962 ?) 28 | <i>OUSIRKHERES</i> 28 |
| <i>SAHÛRÎ</i> (3961–3957 ?) 4 | <i>SEPIRES</i> 13 |
| <i>KAKIÛ</i> (3956–3954 ?) 2 | |
| <i>NOFIRIRIKERÎ</i> (3953–3946 ?) 7 | |
| <i>SEN</i> (3945–3933 ?) 12 | <i>NEFERKHERES</i> 20 |
| <i>SHOPSISIKERÎ</i> (3932–3922 ?) ? | <i>SISIRES</i> 7 |
| <i>AKAÛHORÛ</i> (3921–3914 ?) 7 | <i>KHERES</i> 20 |
| | |
| <i>ÛSIRNIRÎ ÂNÛ</i> (3900–3875 ?) 25 | <i>RATHOURES</i> 44 |
| <i>MENKAÛHORÛ</i> (3874–3866 ?) 8 | <i>MENKHERES</i> 9 |
| <i>DADKERÎ ASSI</i> (3865–3837 ?) 28 | <i>TANKHERES</i> 44 |
| <i>ÛNAS</i> (3834–3804 ?) 30 | <i>OBOS</i> 33 |

² It is pretty generally admitted, but without convincing proofs, that the pyramids of *Abûsir* served as tombs for the Pharaohs in the Vth dynasty, one for *Sahûrî*, another to *Ûsirniri Ânû*, although *Wiedemann* considers that the truncated pyramid of *Dahshûr* was the tomb of this king. I am

and founded cities.¹ The Bedouin of the Sinaitic peninsula gave them much to do. Sahûrî brought these nomads to



STATUE IN ROSE-COLOURED GRANITE OF THE PHARAOH ANÛ, IN THE GÍZEH MUSEUM.²

reason, and perpetuated the memory of his victories by a stele, engraved on the face of one of the rocks in the Wady Magharah; Ânû obtained some successes over them, and Assi repulsed them in the fourth year of his reign. On the whole, they maintained Egypt in the position of prosperity and splendour to which their predecessors had raised it.

inclined to think that one of the pyramids of Saqqâra was constructed by Assi; the pyramid of Ûnas was opened

in 1881, and the results made known by MASPERO, *Études de Mythologie et d'Archéologie*, vol. i. p. 150, et seq., and *Recueil de Travaux*, vols. iv. and v. The names of the majority of the pyramids are known to us from the monuments: that of Ûsirkaf was called "Ûâbisû"; that of Sahûrî, "Khâbi"; that of Nofirivikerî, "Bi"; that of Anû, "Min-isûîtû"; that of Menkaûhorû, "Nûtirisûîtû"; that of Assi, "Nûtir"; that of Ûnas, "Nofir-isûîtû."

¹ Pa Sahûrî, near Esneh, for instance, was built by Sahûrî. The modern name of the village of Sahoura still preserves, on the same spot, without the inhabitants suspecting it, the name of the ancient Pharaoh.

² Drawn by Boudier, from a photograph by Émil Brugsch-Bey.

In one respect they even increased it. Egypt was not so far isolated from the rest of the world as to prevent her inhabitants from knowing, either by personal contact or by hearsay, at least some of the peoples dwelling outside Africa, to the north and east. They knew that beyond the "Very Green," almost at the foot of the mountains behind which the sun travelled during the night, stretched fertile islands or countries and nations without number, some

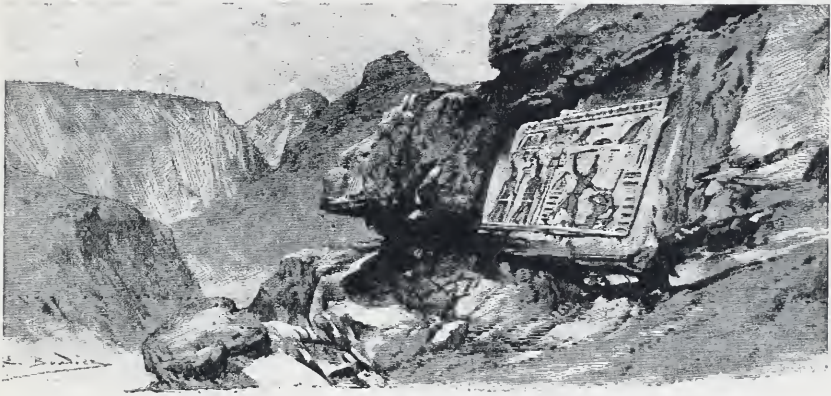

TRIUMPHAL BAS-RELIEF OF PHARAOH SAHÛRÛ, ON THE ROCKS OF WADY MAGHARAH.¹

barbarous or semi-barbarous, others as civilized as they were themselves. They cared but little by what names they were known, but called them all by a common epithet, the Peoples beyond the Seas, "Haûi-nîbû." If they travelled in person to collect the riches which were offered to them by these peoples in exchange for the products of the Nile, the Egyptians could not have been the unadventurous

¹ Drawn by Boudier, from the water-colour published in LEPSIUS, *Denkm.*, i, pl. 8, No. 2.

and home-loving people we have imagined. They willingly left their own towns in pursuit of fortune or adventure, and the sea did not inspire them with fear or religious horror. The ships which they launched upon it were built on the model of the Nile boats, and only differed from the latter in details which would now pass unnoticed. The hull, which was built on a curved keel, was narrow, had a sharp stem and stern, was decked from end to end, low forward and much raised aft, and had a long deck cabin: the steering apparatus consisted of one or two large stout oars, each supported on a forked post and managed by a steersman. It had one mast, sometimes composed of a single tree, sometimes formed of a group of smaller masts planted at a slight distance from each other, but united at the top by strong ligatures and strengthened at intervals by crosspieces which made it look like a ladder; its single sail was bent sometimes to one yard, sometimes to two; while its complement consisted of some fifty men, oarsmen, sailors, pilots, and passengers. Such were the vessels for cruising or pleasure; the merchant ships resembled them, but they were of heavier build, of greater tonnage, and had a higher freeboard. They had no hold; the merchandise had to remain piled up on deck, leaving only just enough room for the working of the vessel. They nevertheless succeeded in making lengthy voyages, and in transporting troops into the enemy's territory from the mouths of the Nile to the southern coast of Syria. Inveterate prejudice alone could prevent us from admitting that the Egyptians of the Memphite period went to the ports of Asia and to the Haûi-nîbû by sea. Some, at all events, of the wood

required for building¹ and for joiner's work of a civil or funereal character, such as pine, cypress or cedar, was

brought from the forests of Lebanon or those of Amanus.

Beads of amber are still found near Abydos in the

tombs of the oldest necropolis, and we may well

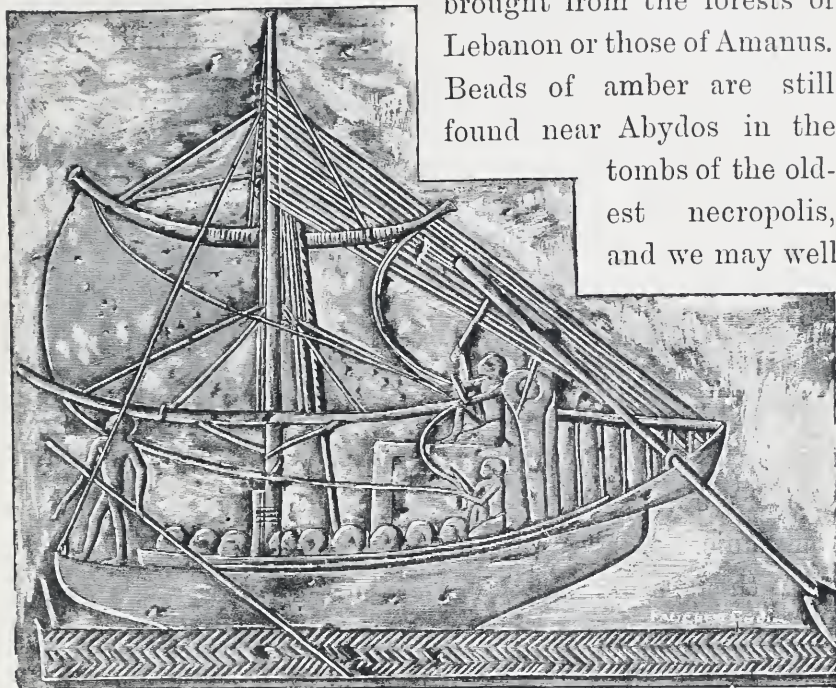

PASSENGER VESSEL UNDER SAIL.²

¹ Cedar-wood must have been continually imported into Egypt. It is mentioned in the Pyramid texts ; in the tomb of Ti, and in the other tombs of Saqqâra or Gîzeh, workmen are represented making furniture of it. Chips of wood from the coffins of the VIth dynasty, detached in ancient times and found in several mastabas at Saqqâra, have been pronounced to be, some cedar of Lebanon, others a species of pine which still grows in Cilicia and in the north of Syria.

² Drawn by Faucher-Gudin, from a photograph by Émil Brugsch-Bey ; the picture is taken from one of the walls of the tomb of Api, discovered at Saqqâra, and now preserved in the Gîzeh Museum (VIth dynasty). The man standing at the bow is the fore-pilot, whose duty it is to take soundings of the channel, and to indicate the direction of the vessel to the pilot aft, who works the rudder-oars.

ask how many hands they had passed through before reaching the banks of the Nile from the shores of the Baltic.¹ The tin used to alloy copper for making bronze,² and perhaps bronze itself, entered doubtless by the same route as the amber. The tribes of unknown race who then peopled the coasts of the Ægean Sea, were amongst the latest to receive these metals, and they transmitted them either directly to the Egyptians or Asiatic intermediaries, who carried them to the Nile Valley. Asia Minor had, moreover, its treasures of metal as well as those of wood—copper, lead, and iron, which certain tribes of miners and smiths, had worked from the earliest times. Caravans plied between Egypt and the lands of Chaldæan civilization, crossing Syria and Mesopotamia, perhaps even by the shortest desert route, as far as Ur and Babylon. The communications between nation and nation were frequent from this time forward, and very productive, but their existence and importance are matters of inference, as we have no direct evidence of them. The relations with these nations continued to be pacific, and, with the exception of Sinai, Pharaoh had no desire to leave the

¹ I have picked up in the tombs of the VIth dynasty at Kom-es-Sultan, and in the part of the necropolis of Abydos containing the tombs of the XIth and XIIth dynasties, a number of amber beads, most of which were very small. Mariette, who had found some on the same site, and who had placed them in the Boulaq Museum, mistook them for corroded yellow or brown glass beads. The electric properties which they still possess have established their identity.

² I may recall the fact that the analysis of some objects discovered at Mèdûm by Professor Petrie proved that they were made of bronze, and contained 9·1 per cent. of tin; the Egyptians, therefore, used bronze from the IVth dynasty downwards, side by side with pure copper.

Nile Valley and take long journeys to pillage or subjugate countries from whence came so much treasure. The desert and the sea which protected Egypt on the north and east from Asiatic cupidity, protected Asia with equal security from the greed of Egypt.

On the other hand, towards the south, the Nile afforded an easy means of access to those who wished to penetrate into the heart of Africa. The Egyptians had, at the outset, possessed only the northern extremity of the valley, from the sea to the narrow pass of Silsileh; they had then advanced as far as the first cataract, and Syene for some time marked the extreme limit of their empire. At what period did they cross this second frontier and resume their march southwards, as if again to seek the cradle of their race? They had approached nearer and nearer to the great bend described by the river near the present village of Korosko,¹ but the territory thus conquered had, under the Vth dynasty, not as yet either name or separate organization: it was a dependency of the fiefdom of Elephantinê, and was under the immediate authority of its princes. Those natives who dwelt on the banks of the river appear to have offered but a slight resistance to the invaders: the desert tribes proved more difficult to conquer. The Nile divided them into two distinct bodies. On the right side,

¹ This appears to follow from a passage in the inscription of Ūni. This minister was raising troops and exacting wood for building among the desert tribes whose territories adjoined at this part of the valley: the manner in which the requisitions were effected shows that it was not a question of a new exaction, but a familiar operation, and consequently that the peoples mentioned had been under regular treaty obligations to the Egyptians, at least for some time previously.

the confederation of the Ūaûaiû spread in the direction of the Red Sea, from the district around Ombos to the neighbourhood of Korosko, in the valleys now occupied by the Ababdehs: it was bounded on the south by the Mâzaiû tribes, from whom our contemporary Mâazel have probably descended. The Amamiû were settled on the left bank opposite to the Mâzaiû, and the country of Iritit lay facing the territory of the Ūaûaiû. None of these barbarous peoples were subject to Egypt, but they all acknowledged its suzerainty,—a somewhat dubious one, indeed, analogous to that exercised over their descendants by the Khedives of to-day. The desert does not furnish them with the means of subsistence: the scanty pasturages of their wadys support a few flocks of sheep and asses, and still fewer oxen, but the patches of cultivation which they attempt in the neighbourhood of springs, yield only a poor produce of vegetables or dourah. They would literally die of starvation were they not able to have access to the banks of the Nile for provisions. On the other hand, it is a great temptation to them to fall unawares on villages or isolated habitations on the outskirts of the fertile lands, and to carry off cattle, grain, and male and female slaves; they would almost always have time to reach the mountains again with their spoil and to protect themselves there from pursuit, before even the news of the attack could reach the nearest police station. Under treaties concluded with the authorities of the country, they are permitted to descend into the plain in order to exchange peaceably for corn and dourah, the acacia-wood of their forests, the charcoal that they make, gums, game, skins of animals,

and the gold and precious stones which they get from their mines: they agree in return to refrain from any act of plunder, and to constitute a desert police, provided that they receive a regular pay. The same arrangement existed

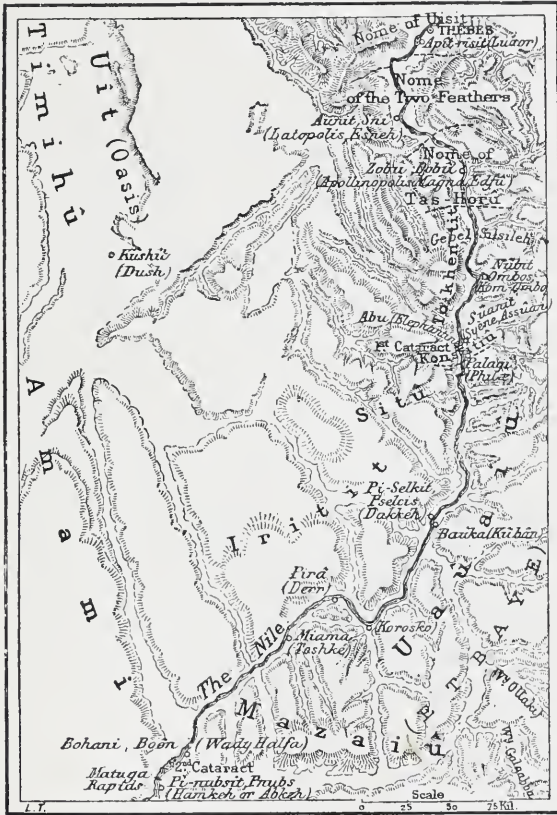

NUBIA IN THE TIME OF THE MEMPHITE EMPIRE.

in ancient times. The tribes hired themselves out to Pharaoh. They brought him beams of "sont" at the first demand, when he was in need of materials to build a fleet beyond the first cataract. They provided him with bands of men ready armed, when a campaign against the Libyans

or the Asiatic tribes forced him to seek recruits for his armies: the Mâzaiû entered the Egyptian service in such numbers, that their name served to designate the soldiery in general, just as in Cairo porters and night watchmen are all called Berberines. Among these people respect for their oath of fealty yielded sometimes to their natural disposition, and they allowed themselves to be carried away to plunder the principalities which they had agreed to defend: the colonists in Nubia were often obliged to complain of their exactions. When these exceeded all limits, and it became impossible to wink at their misdoings any longer, light-armed troops were sent against them, who quickly brought them to reason. As at Sinai, these were easy victories. They recovered in one expedition what the Ûaûaiû had stolen in ten, both in flocks and fellahîn, and the successful general perpetuated the memory of his exploits by inscribing, as he returned, the name of Pharaoh on some rock at Syene or Elephantinê: we may surmise that it was after this fashion that Ûsirkaf, Nofirikerî, and Ûnas carried on the wars in Nubia. Their armies probably never went beyond the second cataract, if they even reached so far: further south the country was only known by the accounts of the natives or by the few merchants who had made their way into it. Beyond the Mâzaiû, but still between the Nile and the Red Sea, lay the country of Pâanît, rich in ivory, ebony, gold, metals, gums, and sweet-smelling resins. When some Egyptian, bolder than his fellows, ventured to travel thither, he could choose one of several routes for approaching it by land or sea. The navigation of the Red Sea was, indeed, far more frequent

than is usually believed, and the same kind of vessels in which the Egyptians coasted along the Mediterranean, conveyed them, by following the coast of Africa, as far as the Straits of Bab-el-Mandeb. They preferred, however, to reach it by land, and they returned with caravans of heavily laden asses and slaves. All that lay beyond Pûanît



HEAD OF AN INHABITANT OF PÛANÎT.¹

was held to be a fabulous region, a kind of intermediate boundary land between the world of men and that of the gods, the "Island of the Double," "Land of the Shades," where the living came into close contact with the souls of

¹ Drawn by Faucher-Gudin, from a photograph by Professor Petrie. This head was taken from the bas-relief at Karnak, on which the Pharaoh Harmhabi of the XVIIIth dynasty recorded his victories over the peoples of the south of Egypt.

the departed. It was inhabited by the Dangas, tribes of half-savage dwarfs, whose grotesque faces and wild gestures reminded the Egyptians of the god Bisû (Bes). The chances of war or trade brought some of them from time to time to Pûanît, or among the Amamiû: the merchant who succeeded in acquiring and bringing them to Egypt had his fortune made. Pharaoh valued the Dangas highly, and was anxious to have some of them at any price among the dwarfs with whom he loved to be surrounded; none knew better than they the dance of the god—that to which Bisû unrestrainedly gave way in his merry moments. Towards the end of his reign Assi procured one which a certain Biûrdidi had purchased in Pûanît. Was this the first which had made its appearance at court, or had others preceded it in the good graces of the Pharaohs? His wildness and activity, and the extraordinary positions which he assumed, made a lively impression upon the courtiers of the time, and nearly a century later there were still reminiscences of him.

A great official born in the time of Shopsiskaf, and living on to a great age into the reign of Nofirikeri, is described on his tomb as the "Scribe of the House of Books." This simple designation, occurring incidentally among two higher titles, would have been sufficient in itself to indicate the extraordinary development which Egyptian civilization had attained at this time. The "House of Books" was doubtless, in the first place, a depository of official documents, such as the registers of the survey and taxes, the correspondence between the court and the provincial governors or feudal lords, deeds

of gift to temples or individuals, and all kinds of papers required in the administration of the State. It contained also, however, literary works, many of which even at this early date were already old, prayers drawn up during the first dynasties, devout poetry belonging to times prior to the misty personage called Mîni—hymns to the gods of light, formulæ of black magic, collections of mystical works, such as the “Book of the Dead”¹ and the “Ritual of the Tomb;” scientific treatises on medicine, geometry, mathematics, and astronomy; manuals of practical morals; and lastly, romances, or those marvellous stories which preceded the romance among Oriental peoples. All these, if we had them, would form “a library much more precious to us than that of Alexandria;” unfortunately up to the present we have been able to collect only insignificant remains of such rich stores. In the tombs have been found here and there fragments of popular songs. The pyramids have furnished almost intact a ritual of the dead which is distinguished by its verbosity, its numerous pious platitudes, and obscure allusions to things of the other world; but, among all this trash, are certain portions full of movement and savage vigour, in which poetic glow and religious emotion reveal their presence in a mass of mythological phraseology. In the Berlin Papyrus we may read the end of a philosophic dialogue between an Egyptian and his soul, in

¹ The “Book of the Dead” must have existed from prehistoric times, certain chapters excepted, whose relatively modern origin has been indicated by those who ascribe the editing of the work to the time of the first human dynasties.

which the latter applies himself to show that death has nothing terrifying to man. "I say to myself every day: As is the convalescence of a sick person, who goes to the court after his affliction, such is death. . . . I say to myself every day: As is the inhaling of the scent of a perfume, as a seat under the protection of an outstretched curtain, on that day, such is death. . . . I say to myself every day: As the inhaling of the odour of a garden of flowers, as a seat upon the mountain of the Country of Intoxication, such is death. . . . I say to myself every day: As a road which passes over the flood of inundation, as a man who goes as a soldier whom nothing resists, such is death. . . . I say to myself every day: As the clearing again of the sky, as a man who goes out to catch birds with a net, and suddenly finds himself in an unknown district, such is death." Another papyrus, presented by Prisse d'Avennes to the *Bibliothèque Nationale*, Paris, contains the only complete work of their primitive wisdom which has come down to us. It was certainly transcribed before the XVIIIth dynasty, and contains the works of two classic writers, one of whom is assumed to have lived under the IIIrd and the other under the Vth dynasty; it is not without reason, therefore, that it has been called "the oldest book in the world." The first leaves are wanting, and the portion preserved has, towards its end, the beginning of a moral treatise attributed to Qaqimnî, a contemporary of Hâni. Then followed a work now lost: one of the ancient possessors of the papyrus having effaced it with the view of substituting for it another piece, which was never transcribed.

The last fifteen pages are occupied by a kind of pamphlet, which has had a considerable reputation, under the name of the "Proverbs of Phtahhotpû."

This Phtahhotpû, a king's son, flourished under Menkaûhorû and Assi: his tomb is still to be seen in the necropolis of Saqqâra. He had sufficient reputation to permit the ascription to him, without violence to probability, of the editing of a collection of political and moral maxims which indicate a profound knowledge of the court and of men generally. It is supposed that he presented himself, in his declining years, before the Pharaoh Assi, exhibited to him the piteous state to which old age had reduced him, and asked authority to hand down for the benefit of posterity the treasures of wisdom which he had stored up in his long career. The nomarch Phtahhotpû says: "'Sire, my lord, when age is at that point, and decrepitude has arrived, debility comes and a second infancy, upon which misery falls heavily every day: the eyes become smaller, the ears narrower, strength is worn out while the heart continues to beat; the mouth is silent and speaks no more; the heart becomes darkened and no longer remembers yesterday; the bones become painful, everything which was good becomes bad, taste vanishes entirely; old age renders a man miserable in every respect, for his nostrils close up, and he breathes no longer, whether he rises up or sits down. If the humble servant who is in thy presence receives an order to enter on a discourse befitting an old man, then I will tell to thee the language of those who know the history of the past, of those who have

heard the gods; for if thou conductest thyself like them, discontent shall disappear from among men, and the two lands shall work for thee!’ The majesty of this god says: ‘Instruct me in the language of old times, for it will work a wonder for the children of the nobles; whosoever enters and understands it, his heart weighs carefully what it says, and it does not produce satiety.’” We must not expect to find in this work any great profundity of thought. Clever analyses, subtle discussions, metaphysical abstractions, were not in fashion in the time of Phtahhotpû. Actual facts were preferred to speculative fancies: man himself was the subject of observation, his passions, his habits, his temptations and his defects, not for the purpose of constructing a system therefrom, but in the hope of reforming the imperfections of his nature and of pointing out to him the road to fortune. Phtahhotpû, therefore, does not show much invention or make deductions. He writes down his reflections just as they occur to him, without formulating them or drawing any conclusion from them as a whole. Knowledge is indispensable to getting on in the world; hence he recommends knowledge. Gentleness to subordinates is politic, and shows good education; hence he praises gentleness. He mingles advice throughout on the behaviour to be observed in the various circumstances of life, on being introduced into the presence of a haughty and choleric man, on entering society, on the occasion of dining with a dignitary, on being married. “If thou art wise, thou wilt go up into thine house, and love thy wife at home; thou wilt give her abundance of food,

thou wilt clothe her back with garments; all that covers her limbs, her perfumes, is the joy of her life; as long as thou lookest to this, she is as a profitable field to her master." To analyse such a work in detail is impossible: it is still more impossible to translate the whole of it. The nature of the subject, the strangeness of certain precepts, the character of the style, all tend to disconcert the reader and to mislead him in his interpretations. From the very earliest times ethics has been considered as a healthy and praiseworthy subject in itself, but so hackneyed was it, that a change in the mode of expressing it could alone give it freshness. Phtahhotpû is a victim to the exigencies of the style he adopted. Others before him had given utterance to the truths he wished to convey: he was obliged to clothe them in a startling and interesting form to arrest the attention of his readers. In some places he has expressed his thought with such subtlety, that the meaning is lost in the jingle of the words.

The art of the Memphite dynasties has suffered as much as the literature from the hand of time, but in the case of the former the fragments are at least numerous and accessible to all. The kings of this period erected temples in their cities, and, not to speak of the chapel of the Sphinx, we find in the remains still existing of these buildings chambers of granite, alabaster and limestone, covered with religious scenes like those of more recent periods, although in some cases the walls are left bare. Their public buildings have all, or nearly all, perished; breaches have been made in them by invading armies or by civil wars, and they have been altered,

enlarged, and restored scores of times in the course of ages; but the tombs of the old kings remain, and afford proof of the skill and perseverance exhibited by the architects in devising and carrying out their plans. Many of the mastabas occurring at intervals between Gîzeh and Mèdûm have, indeed, been hastily and carelessly built, as if by those who were anxious to get them finished, or who had an eye to economy; we may observe in all of them neglect and imperfection,—all the trade-tricks which an unscrupulous jerry-builder then, as now, could be guilty of, in order to keep down the net cost and satisfy the natural parsimony of his patrons without lessening his own profits.¹ Where, however, the master-mason has not been hampered by being forced to work hastily or cheaply, he displays his conscientiousness, and the choice of materials, the regularity of the courses, and the homogeneousness of the building leave nothing to be desired; the blocks are adjusted with such precision that the joints are almost invisible, and the mortar between them has been spread with such a skilful hand that there is scarcely an appreciable difference in its uniform thickness.² The long low flat mass which the finished tomb

¹ The similarity of the materials and technicalities of construction and decoration seem to me to prove that the majority of the tombs were built by a small number of contractors or corporations, lay or ecclesiastical, both at Memphis, under the Ancient, as well as at Thebes, under the New Empire.

² Speaking of the Great Pyramid and of its casing, Professor Petrie says: "Though the stones were brought as close as $\frac{1}{500}$ inch, or, in fact, into contact, and the mean opening of the joint was but $\frac{1}{50}$ inch, yet the builders managed to fill the joint with cement, despite the great area of it, and the weight of the stone to be moved—some 16 tons. To merely place such

presented to the eye is wanting in grace, but it has the characteristics of strength and indestructibility well suited to an "eternal house." The façade, however, was not wanting in a certain graceful severity: the play of light and shade distributed over its surface by the stelæ, niches, and deep-set doorways, varied its aspect in the course of the day, without lessening the impression of its majesty and serenity which nothing could disturb. The pyramids themselves are not, as we might imagine, the coarse and ill-considered reproduction of a mathematical figure disproportionately enlarged. The architect who made an estimate for that of Kheops, must have carefully thought out the relative value of the elements contained in the problem which had to be solved—the vertical height of the summit, the length of the sides on the ground line, the angle of pitch, the inclination of the lateral faces to one another—before he discovered the exact proportions and the arrangement of lines which render his monument a true work of art, and not merely a costly and mechanical arrangement of stones.¹ The impressions which he desired to excite, have been felt by all who came

stones in exact contact at the sides would be careful work; but to do so with cement in the joint seems almost impossible."

¹ Cf. BORCHARDT'S article, *Wie wurden die Böschungen der Pyramiden bestimmt?* in which the author—an architect by profession as well as an Egyptologist—interprets the theories and problems of the *Rhind mathematical Papyrus* in a new manner, comparing the result with his own calculations, made from measurements of pyramids still standing, and in which he shows, by an examination of the diagrams discovered on the wall of a mastaba at Médûm, that the Egyptian contractors of the Memphite period were, at that early date, applying the rules and methods of procedure which we find set forth in the Papyri of Theban times.

after him when brought face to face with the pyramids. From a great distance they appear like mountain-peaks, breaking the monotony of the Libyan horizon; as we approach them they apparently decrease in size, and seem to be merely unimportant inequalities of ground on the surface of the plain. It is not till we reach their bases that we guess their enormous size. The lower courses then stretch seemingly into infinity to right and left, while the summit soars up out of our sight into the sky. "The effect is gained by majesty and simplicity of form, in the contrast and disproportion between the stature of man and the immensity of his handiwork: the eye fails to take it in; it is even difficult for the mind to grasp it. We see, we may touch hundreds of courses formed of blocks, two hundred cubic feet in size, . . . and thousands of others scarcely less in bulk, and we are at a loss to know what force has moved, transported, and raised so great a number of colossal stones, how many men were needed for the work, what amount of time was required for it, what machinery they used; and in proportion to our inability to answer these questions, we increasingly admire the power which regarded such obstacles as trifles."

We are not acquainted with the names of any of the men who conceived these prodigious works. The inscriptions mention in detail the princes, nobles, and scribes who presided over all the works undertaken by the sovereign, but they have never deigned to record the name of a single architect.¹ They were people of humble

¹ The title "mir kaûtû nibû nîti sûtou," frequently met with under the



extraction, living hard lives under fear of the stick, and their ordinary assistants, the draughtsmen, painters, and sculptors, were no better off than themselves; they were looked upon as mechanics of the same social status as the neighbouring shoemaker or carpenter. The majority of them were, in fact, clever mechanical workers of varying capability, accustomed to chisel out a bas-relief or set a statue firmly on its legs, in accordance with invariable rules which they transmitted unaltered from one generation to another: some were found among them, however, who displayed unmistakable genius in their art, and who, rising above the general mediocrity, produced masterpieces. Their equipment of tools was very simple—iron picks with wooden handles, mallets of wood, small hammers, and a bow for boring holes. The sycamore and acacia furnished them with a material of a delicate grain and soft texture, which they used to good advantage: Egyptian art has left us nothing which, in purity of line and delicacy of modelling, surpasses the panels of the tomb of Hosi, with their seated or standing male figures and their vigorously cut hieroglyphs in the same relief as the picture. Egypt possesses, however, but few trees of suitable fibre for sculptural purposes, and even those

Ancient Empire, does not designate the architects, as many Egyptologists have thought: it signifies “director of all the king’s works,” and is applicable to irrigation, dykes and canals, mines and quarries, and all branches of an engineer’s profession, as well as to those of the architect’s. The “directors of all the king’s works” were dignitaries deputed by Pharaoh to take the necessary measurements for the building of temples, for dredging canals, for quarrying stone and minerals; they were administrators, and not professionals possessing the technical knowledge of an architect or engineer.

which were fitted for this use were too small and stunted to furnish blocks of any considerable size. The sculptor, therefore, turned by preference to the soft white limestone of Turah. He quickly detached the general form of his



ONE OF THE WOODEN PANELS OF HOSI, IN THE GIZEH MUSEUM.¹

statue from the mass of stone, fixed the limits of its contour by means of dimension guides applied horizontally from top to bottom, and then cut away the angles projecting beyond the guides, and softened off the outline till he made his modelling correct. This simple and regular method of procedure was not suited to hard stone: the latter had to be first chiselled, but when by dint of patience the rough hewing had reached the desired stage, the work of completion was not entrusted to metal tools. Stone hatchets were used for smoothing off the superficial roughnesses, and it was assiduously polished to efface the various tool-marks left upon its surface.

The statues did not present that variety of gesture, expression, and attitude which we aim at to-day. They were, above all things, the accessories of a temple or tomb,

¹ Drawn by Boudier, from a photograph by Émil Brugsch-Bey. The original is now in the Gizeh Museum.

and their appearance reflects the particular ideas entertained with regard to their nature. The artists did not seek to embody in them the ideal type of male or female beauty: they were representatives made to perpetuate the existence of the model. The Egyptians wished the double to be able to adapt itself easily to its image, and in order to compass that end, it was imperative that the



A SCULPTOR'S STUDIO, AND EGYPTIAN PAINTERS AT WORK.¹

stone presentment should be at least an approximate likeness, and should reproduce the proportions and peculiarities of the living prototype for whom it was meant. The head had to be the faithful portrait of the individual: it was enough for the body to be, so to speak, an average one, showing him at his fullest development and in the complete enjoyment of his physical

¹ Drawn by Faucher-Gudin, from a chromolithograph by PRISSE D'AVENNES, *Histoire de l'Art Égyptien*. The original is in the tomb of Rakhmiri, who lived at Thebes under the XVIIIth dynasty. The methods which were used did not differ from those employed by the sculptors and painters of the Memphite period more than two thousand years previously.

powers. The men were always represented in their maturity, the women never lost the rounded breast and slight hips of their girlhood, but a dwarf always preserved

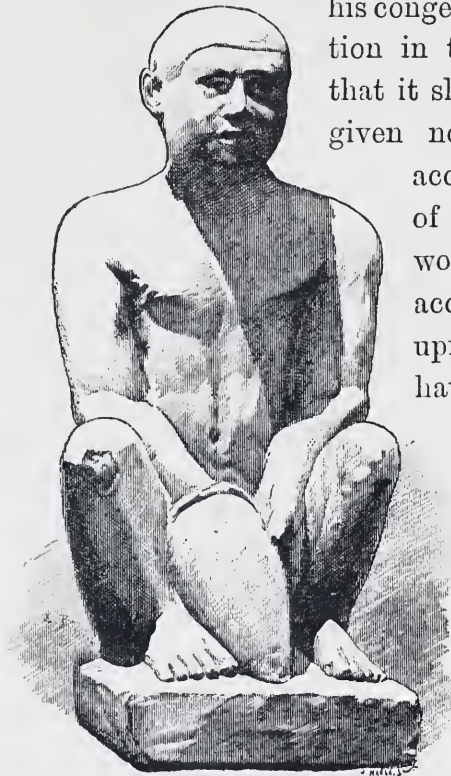

CELLARER COATING A JAR WITH PITCH.¹

his congenital ugliness, for his salvation in the other world demanded that it should be so. Had he been given normal stature, the double, accustomed to the deformity of his members in this world, would have been unable to accommodate himself to an upright carriage, and would not have been in a fit condition

to resume his course of life. The particular pose of the statue was dependent on the social position of the person. The king, the nobleman, and the master are always standing or sitting: it was in these postures they received the homage of

their vassals or relatives. The wife shares her husband's seat, stands upright beside him, or crouches at his feet as in daily life. The son, if his statue was ordered while he was a child, wears the dress of childhood; if he had arrived to manhood, he is represented in the dress and

¹ Drawn by Boudier, from a photograph by Émil Brugsch-Bey. The original is now in the Gizeh Museum.

with the attitude suited to his calling. Slaves grind the grain, cellarers coat their amphoræ with pitch, bakers knead their dough, mourners make lamentation and tear their hair. The exigencies of rank clung to the Egyptians in temple and tomb, wherever their statues were placed, and left the sculptor who represented them scarcely any liberty. He might be allowed to vary the details and arrange the accessories to his taste; he might alter nothing in the attitude or the general likeness without compromising the end and aim of his work.

The statues of the Memphite period may be counted at the present day by hundreds.

Some are in the heavy and barbaric style which has caused them to be mistaken for primæval monuments: as, for instance, the statues of Sapi and his wife, now in the Louvre, which are attributed to the beginning of the IIIrd dynasty or even earlier. Groups exactly resembling these in appearance are often found in the tombs of the Vth and VIth dynasties, which according to this reckoning would be still older

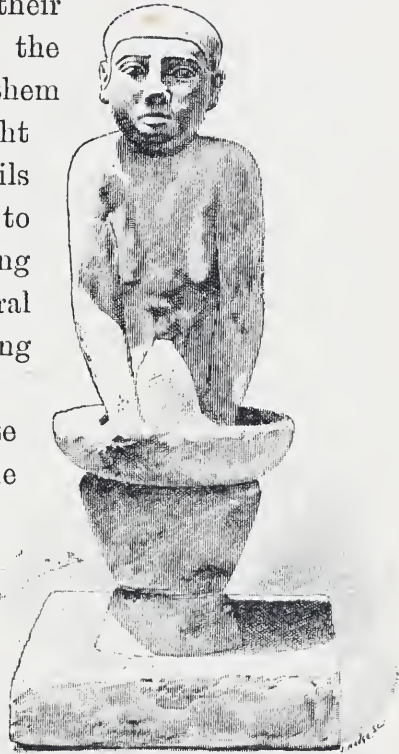

BAKER KNEADING HIS DOUGH.¹

to the beginning of the IIIrd dynasty or even earlier. Groups exactly resembling these in appearance are often found in the tombs of the Vth and VIth dynasties, which according to this reckoning would be still older

¹ Drawn by Boudier, from a photograph by Béchard. The original is now in the Gizeh Museum,

than that of Sapi: they were productions of an inferior studio, and their supposed archaism is merely the want of skill of an ignorant sculptor. The majority of the remaining statues are not characterized either by glaring faults or by striking merits: they constitute an array of honest good-natured folk, without much individuality of character and no originality. They may be easily divided into five or six groups, each having a style in common, and all apparently having been executed on the lines of a few chosen models; the sculptors who worked for the mastaba contractors were distributed among a very few studios, in which a traditional routine was observed for centuries. They did not always wait for orders, but, like our modern tombstone-makers, kept by them a tolerable assortment of half-finished statues, from which the purchaser could choose according to his taste. The hands, feet, and bust lacked only the colouring and final polish, but the head was merely rough-hewn, and there were no indications of dress; when the future occupant of the tomb or his family had made their choice, a few hours of work were sufficient to transform the rough sketch into a portrait, such as it was, of the deceased they desired to commemorate, and to arrange his garment according to the latest fashion. If, however, the relatives or the sovereign¹ declined to be satisfied with these commonplace images, and demanded a less conventional

¹ It must not be forgotten that the statues were often, like the tomb itself, given by the king to the man whose services he desired to reward. His burying-place then bore the formulary, "By the favour of the king," as I have mentioned previously.

treatment of body for the double of him whom they had lost, there were always some among the assistants to be found capable of entering into their wishes, and of seizing the lifelike expression of limbs and features. We possess at the present day, scattered about in museums, some score of statues of this period, examples of consummate art,—the Khephrens, the Kheops, the Anû, the Nofrit, the Râhotpû I have already mentioned, the “Sheikh-el-Beled” and his wife, the sitting scribe of the Louvre and that of Gîzeh, and the kneeling scribe. Kaâpirû, the “Sheikh-el-Beled,” was probably one of the directors of the *corvée* employed to build the Great Pyramid.² He seems to be coming forward to meet the beholder, with an acacia staff in his hand. Heavy, thick-set, broad and



THE SHEÏKH-EL-BELED IN THE GÎZEH MUSEUM.¹

¹ Drawn by Boudier, from a photograph by Émil Brugsch-Bey.

² It was discovered by Mariette at Saqqâra. “The head, torso, arms, and even the staff, were intact; but the pedestal and legs were hopelessly decayed, and the statue was only kept upright by the sand which surrounded it.” The staff has since been broken, and is replaced by a more recent one exactly like it. In order to set up the figure, Mariette was obliged to supply new feet, which retain the colour of the fresh wood. By

fleshy, he has the head and shoulders of a bull, and a common cast of countenance, whose vulgarity is not wanting in energy. The large, widely open eye has, by a trick of the sculptor, an almost uncanny reality about it. The socket which holds it has been hollowed out and



THE KNEELING SCRIBE IN THE GIZEH MUSEUM.¹

filled with an arrangement of black and white enamel; a rim of bronze marks the outline of the lids, while a little silver peg, inserted at the back of the pupil, reflects the light and gives the effect of the sparkle of a living glance. The statue, which is short in height, is of wood, and one would be inclined to think that the relative plasticity of the material counts for something in the boldness of the execution, were it not that though the sitting scribe of the Louvre is of limestone, the sculptor has not shown less freedom in its composition.

We recognize in this figure one of those somewhat flabby and heavy subordinate officials of whom so many examples

a curious coincidence, Kaâpirû was an exact portrait of one of the "Sheikhs el-Beled," or mayors of the village of Saqqâra : the Arab workmen, always quick to see a likeness, immediately called it the "Sheikh el-Beled," and the name has been retained ever since.

¹ Drawn by Faucher-Gudin, from a photograph by Émil Brugsch-Bey.

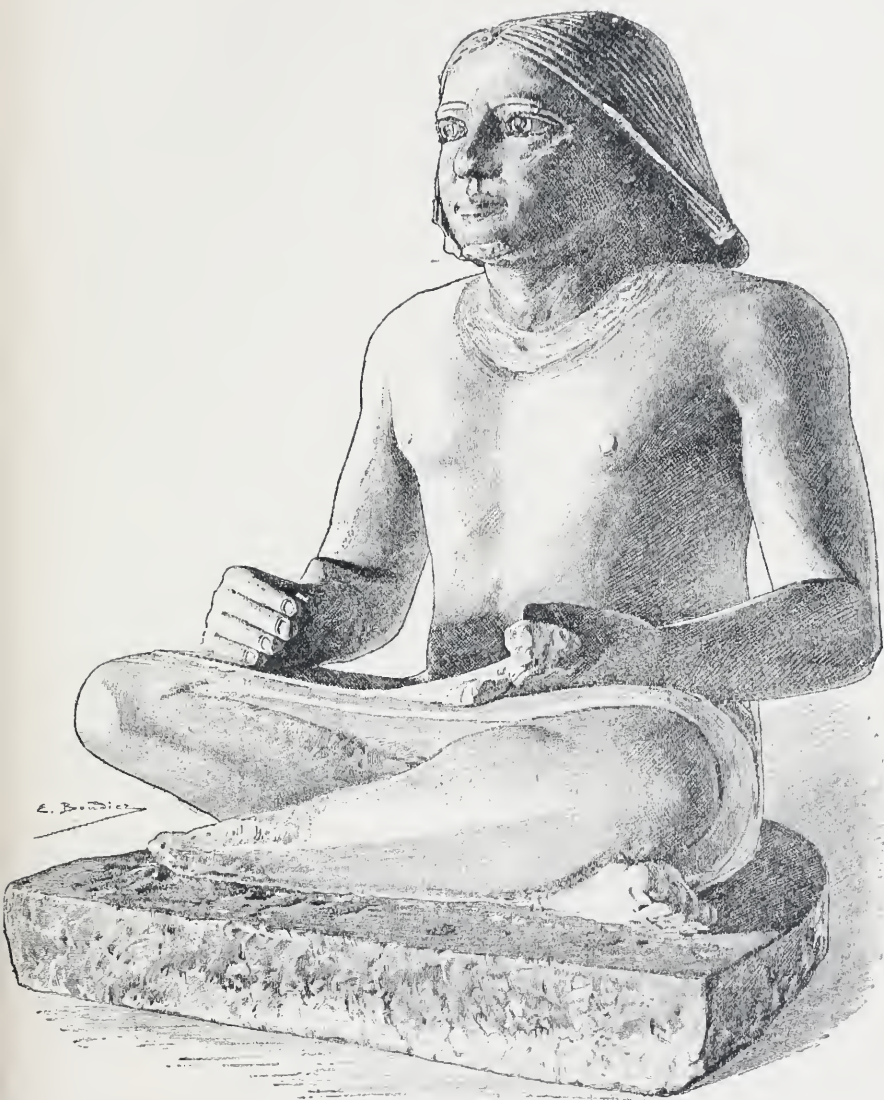

THE SITTING SCRIBE IN THE GIZEH MUSEUM.

Drawn by Boudier, from a photograph by Émil Brugsch-Bey. This scribe was discovered at Saqqâra, by M. de Morgan, in the beginning of 1893.

are to be seen in Oriental courts. He is squatting cross-legged on the pedestal, pen in hand, with the outstretched leaf of papyrus conveniently placed on the right: he waits, after an interval of six thousand years, until Pharaoh or his vizier deigns to resume the interrupted dictation. His colleague at the Gîzeh Museum awakens in us no less wonder at his vigour and self-possession; but, being younger, he exhibits a fuller and firmer figure with a smooth skin, contrasting strongly with the deeply wrinkled appearance of the other, aggravated as it is by his flabbiness. The "kneeling scribe" preserves in his pose and on his countenance that stamp of resigned indecision and monotonous gentleness which is impressed upon subordinate officials by the influence of a life spent entirely under the fear of the stick. Ranofir, on the contrary, is a noble lord looking upon his vassals passing in file before him: his mien is proud, his head disdainful, and he has that air of haughty indifference which is befitting a favourite of the Pharaoh, possessor of generously bestowed sinecures, and lord of a score of domains. The same haughtiness of attitude distinguishes the director of the granaries, Nofir. We rarely encounter a small statue so expressive of vigour and energy. Sometimes there may be found among these short-garmented people an individual wrapped and almost smothered in an immense *abayah*; or a naked man, representing a peasant on his way to market, his bag on his left shoulder, slightly bent under the weight, carrying his sandals in his other hand, lest they should be worn out too quickly in walking. Everywhere we observe the traits of character distinctive

of the individual and his position, rendered with a scrupulous fidelity: nothing is omitted, no detail of the characteristics of the model is suppressed. Idealisation we must not expect, but we have here an intelligent and sometimes too realistic fidelity. Portraits have been conceived among other peoples and in other periods in a different way: they have never been better executed.

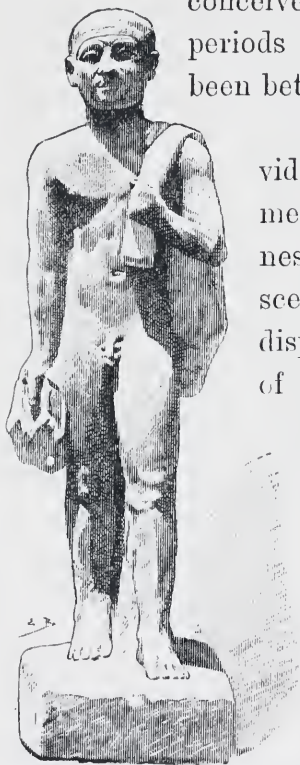

PEASANT GOING TO MARKET¹

The decoration of the sepulchres provided employment for scores of draughtsmen, sculptors, and painters, whose business it was to multiply in these tombs scenes of everyday life which were indispensable to the happiness or comfort of the double. The walls are sometimes decorated with isolated pictures only, each one of which represents a distinct operation; more frequently we find traced upon them a single subject whose episodes are superimposed one upon the other from the ground to the ceiling, and represent an Egyptian panorama from the Nile to the desert. In the lower portion, boats pass to and fro, and collide with

each other, while the boatmen come to blows with their boat-hooks within sight of hippopotami and crocodiles. In the upper portions we see a band of slaves engaged in

¹ Drawn by Boudier, from a photograph by Béchard. The original is at Gizeh.—Vth dynasty.

fowling among the thickets of the river-bank, or in the making of small boats, the manufacture of ropes, the scraping and salting of fish. Under the cornice, hunters and dogs drive the gazelle across the undulating plains of the desert. Every row represents

one of the features of the country; but the artist, instead of arranging the pictures in perspective, separated them and depicted them one above the other. The groups are repeated in one tomb after another; they are always the same, but sometimes they are reduced to two or three individuals, sometimes increased in number, spread out and crowded with figures and inscriptions. Each chief draughtsman had his book of subjects and texts, which he combined in various ways, at one time bringing them close together, at another duplicating or extending

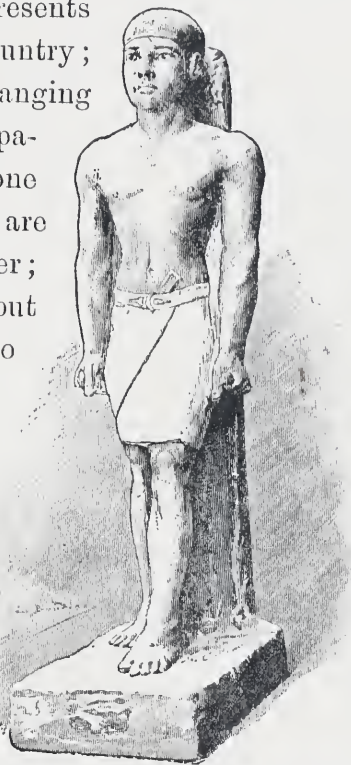

NOFIR, THE DIRECTOR OF GRANARIES.¹

them according to the means put at his disposal or the space he had to cover. The same men, the same animals, the same features of the landscape, the same accessories, appear everywhere: it is industrial and mechanical art at

¹ Drawn by Boudier, from a photograph by Émil Brugsch-Bey. The original is in the Gizeh Museum.—Vth dynasty.

its highest. The whole is, however, harmonious, agreeable to the eye, and instructive. The conventionalisms of the drawing as well as those of the composition are very different from ours. Whether it is man or beast, the subject is invariably presented in outline by the brush, or by the graving tool in sharp relief upon the background; but the animals are represented in action, with their usual gait, movement, and play of limbs distinguishing each species. The slow and measured walk of the ox, the short step, meditative ears, and ironical mouth of the ass, the calm strength of the lion at rest, the grimaces of the monkeys, the slender gracefulness of the gazelle and antelope, are invariably presented with a consummate skill in drawing and expression. The human figure is the least perfect: every one is acquainted with those strange figures, whose heads in profile, with the eye drawn in full face, are attached to a torso seen from the front and supported by limbs in profile. These are truly anatomical monsters, and yet the appearance they present to us is neither laughable nor grotesque. The defective limbs are so deftly connected with those which are normal, that the whole becomes natural: the correct and fictitious lines are so ingeniously blent together that they seem to rise necessarily from each other. The actors in these dramas are constructed in such a paradoxical fashion that they could not exist in this world of ours; they live notwithstanding, in spite of the ordinary laws of physiology, and to any one who will take the trouble to regard them without prejudice, their strangeness will add a charm which is lacking in works more conformable to nature. A layer of colour spread over the whole heightens

and completes them. This colouring is never quite true to nature nor yet entirely false. It approaches reality as far as possible, but without pretending to copy it in a servile way. The water is always a uniform blue, or broken up by black zigzag lines; the skin of the men is invariably brown, that of the women pale yellow. The shade befitting each being or object was taught in the workshops, and once the receipt for it was drawn up, it was never varied in application. The effect produced by these conventional colours, however, was neither discordant nor jarring. The most brilliant colours were placed alongside each other with extreme audacity, but with a perfect knowledge of their mutual relations and combined effect. They do not jar with, or exaggerate, or kill each other: they enhance each other's value, and by their contact give rise to half-shades which harmonize with them. The sepulchral chapels, in cases where their decoration had been completed, and where they have reached us intact, appear to us as chambers hung with beautifully luminous and interesting tapestry, in which rest ought to be pleasant during the heat of the day to the soul which dwells within them, and to the friends who come there to hold intercourse with the dead.



BAS-RELIEF ON IVORY.

The decoration of palaces and houses was not less

¹ Drawn by Boudier, from a photograph by Bouriant. The original is in private possession.

sumptuous than that of the sepulchres, but it has been so completely destroyed that we should find it difficult to form an idea of the furniture of the living if we did not see it frequently depicted in the abode of the double. The great armchairs, folding seats, footstools, and beds of carved wood, painted and inlaid, the vases of hard stone, metal, or enamelled ware, the necklaces, bracelets, and ornaments on the walls, even the common pottery of which we find the remains in the neighbourhood of the pyramids, are generally distinguished by an elegance and grace reflecting credit on the workmanship and taste of the makers.¹ The squares of ivory which they applied to their linen-chests and their jewel-cases often contained actual bas-reliefs in miniature of as bold workmanship and as skilful execution as the most beautiful pictures in the tombs: on these, moreover, were scenes of private life—dancing or processions bringing offerings and animals.² One would like to possess some of those copper and golden statues which the Pharaoh Kheops consecrated to Isis in honour of his daughter: only the

¹ The study of the alabaster and diorite vases found near the pyramids has furnished Petrie with very ingenious views on the methods among the Egyptians of working hard stone. Examples of stone toilet or sacrificial bottles are not unfrequent in our museums: I may mention those in the Louvre which bear the cartouches of Dadkeri Assi (No. 343), of Papi I., and of Papi II., the son of Papi I.; not that they are to be reckoned among the finest, but because the cartouches fix the date of their manufacture. They came from the pyramids of these sovereigns, opened by the Arabs at the beginning of this century: the vase of the VIth dynasty, which is in the Museum at Florence, was brought from Abydos.

² M. Grébaud bought at the Great Pyramids, in 1887, a series of these ivory sculptures of the Ancient Empire. They are now at the Gizeh Museum. Others belonging to the same find are dispersed among private collections: one of them is reproduced on p. 249 of this History.

representation of them upon a stele has come down to us ; and the fragments of sceptres or other objects which too rarely have reached us, have unfortunately no artistic value.



STELE OF THE DAUGHTER OF KHEOPS.¹

A taste for pretty things was common, at least among the upper classes, including not only those about the court, but

¹ Drawn by Faucher-Gudin, from a photograph by Béchard.

also those in the most distant nomes of Egypt. The provincial lords, like the courtiers of the palace, took a pride in collecting around them in the other world everything of the finest that the art of the architect, sculptor, and painter could conceive and execute. Their mansions as well as their temples have disappeared, but we find, here and there on the sides of the hills, the sepulchres which they had prepared for themselves in rivalry with those of the courtiers or the members of the reigning family. They turned the valley into a vast series of catacombs, so that wherever we look the horizon is bounded by a row of historic tombs. Thanks to their rock-cut sepulchres, we are beginning to know the Nomarchs of the Gazelle and the Hare, those of the Serpent-Mountain, of Akhmim, Thinis, Qasr-es-Sayad, and Aswân,—all the scions, in fact, of that feudal government which preceded the royal sovereignty on the banks of the Nile, and of which royalty was never able to entirely disembarass itself. The Pharaohs of the IVth dynasty had kept them in such check that we can hardly find any indications during their reigns of the existence of these great barons; the heads of the Pharaonic administration were not recruited from among the latter, but from the family and domestic circle of the sovereign. It was in the time of the kings of the Vth dynasty, it would appear, that the barons again entered into favour and gradually gained the upper hand; we find them in increasing numbers about Ânû, Menkaûhorû, and Assi. Did Ūnas, who was the last ruler of the dynasty of Elephantinê, die without issue, or were his children prevented from succeeding him by force? The Egyptian annals of the time of the Ramessides bring

the direct line of Menes to an end with this king. A new line of Memphite origin begins after him. It is almost certain that the transmission of power was not accomplished without contention, and that there were many claimants to the crown. One of the latter, Imhotpû, whose legitimacy was always disputed, has left hardly any traces of his accession to power,¹ but Ati established himself firmly on the throne for a year at least:² he pushed on actively

¹ The monuments furnish proof that their contemporaries considered these ephemeral rulers as so many illegitimate pretenders. Phtahshopsîsû and his son Sabû-Abibi, who exercised important functions at the court, mention only Ûnas and Teti III.; Ûni, who took office under Teti III., mentions after this king only Papi I. and Mihtimsaûf I. The official succession was, therefore, regulated at this epoch in the same way as we afterwards find it in the table of Saqqâra, Ûnas, Teti III., Papi I., Mihtimsaûf I., and in the Royal Canon of Turin, without the intercalation of any other king.

² Brugsch, in his *Histoire d'Égypte*, pp. 44, 45, had identified this king with the first Metesouphis of Manetho: E. de Rougé prefers to transfer him to one of the two Memphite series after the VIth dynasty, and his opinion has been adopted by Wiedemann. The position occupied by his inscription among those of Hammamât has decided me in placing him at the end of the Vth or beginning of the VIth dynasty: this E. Meyer has also done.

³ Drawn by Boudier, from a photograph by Faucher-Gudin. The original, which came from Mariette's excavations at the Serapeum, is in the Louvre.



THE PHAROAH MENKAÛHORÛ.³

the construction of his pyramid, and sent to the valley of Hammamât for the stone of his sarcophagus. We know not whether revolution or sudden death put an end to his activity: the "Mastabat-el-Faraun" of Saqqâra, in which he hoped to rest, never exceeded the height which it has at present.¹ His name was, however, inscribed in certain official lists,² and a tradition of the Greek period maintained that he had been assassinated by his guards.³ Teti III. was the actual founder of the VIth dynasty,⁴ historians

It is a work of the time of Seti I., and not a contemporary production of the time of Menkaûhorû.

¹ Ati is known only from the Hammamât, inscription dated in the first year of his reign. He was identified by Brugsch with the Othoes of Manetho, and this identification has been generally adopted. M. de Rougé is inclined to attribute to him as *prænomèn* the cartouche *Ûsirkeri*, which is given in the Table of Abydos between those of Teti III. and Papi I. Mariette prefers to recognize in *Ûrikeri* an independent Pharaoh of short reign. Several blocks of the Mastabat-el-Faraun at Saqqâra contain the cartouche of *Ûnas*, a fact which induced Mariette to regard this as the tomb of the Pharaoh. The excavations of 1881 showed that *Ûnas* was entombed elsewhere, and the indications are in favour of attributing the mastaba to Ati. We know, indeed, the pyramids of Teti III., of the two Papis, and of Metesouphis I.; Ati is the only prince of this period with whose tomb we are unacquainted. It is thus by elimination, and not by direct evidence, that the identification has been arrived at: Ati may have drawn upon the workshops of his predecessor *Ûnas*, which fact would explain the presence on these blocks of the cartouche of the latter.

² Upon that of Abydos, if we agree with E. de Rougé that the cartouche *Ûsirkeri* contains his *prænomèn*; upon that from which Manetho borrowed, if we admit his identification with Othoes.

³ Manetho (UNGER'S edition, p. 101), where the form of the name is Othoes.

⁴ He is called Teti Menephtah, with the cartouche *prænomèn* of Seti I., on a monument of the early part of the XIXth dynasty, in the Museum at Marseilles: we see him in his pyramid represented as standing. This pyramid was opened in 1881, and its chambers are covered with long funerary inscriptions.

representing him as having been the immediate successor of \hat{U} nas. He lived long enough to build at Saqqâra a pyramid whose internal chambers are covered with inscriptions,¹ and his son succeeded him without opposition. Papi I. reigned at least twenty years.² He manifested his activity in all



THE MASTABAT-EL-FARAUN, LOOKING TOWARDS THE WEST FAÇADE.³

corners of his empire, in the nomes of the Said as well as in those of the Delta, and his authority extended beyond

¹ The true pronunciation of this name would be Pipi, and of the one before it Titi. The two other Tetis are Teti I. of the 1st dynasty, and Zosir-Teti, or Teti II., of the IIIrd.

² From fragment 59 of the Royal Canon of Turin. An inscription in the quarries of Hât-nûbû bears the date of the year 24: if it has been correctly copied, the reign must have been four years at least longer than the chronologists of the time of the Ramessides thought.

³ Drawn by Faucher-Gudin, from a photograph by Béchard.

the frontiers by which the power of his immediate predecessors had been limited. He owned sufficient territory south of Elephantinê to regard Nubia as a new kingdom added to those which constituted ancient Egypt: we therefore see him entitled in his preamble "the triple Golden Horus," "the triple Conqueror-Horus," "the Delta-Horus," "the Said-Horus," "the Nubia-Horus." The tribes of the desert furnished him, as was customary, with recruits for his army, for which he had need enough, for the Bedouin of the Sinaitic Peninsula were on the move, and were even becoming dangerous. Papi, aided by \hat{U} ni, his prime minister, undertook against them a series of campaigns, in which he reduced them to a state of helplessness, and extended the sovereignty of Egypt for the time over regions hitherto unconquered.

\hat{U} ni began his career under Teti.¹ At first a simple page in the palace,² he succeeded in obtaining a post in the administration of the treasury, and afterwards that of inspector of the woods of the royal domain.³ Papi

¹ The beginning of the first line is wanting, and I have restored it from other inscriptions of the same kind: "I was born under \hat{U} nas." \hat{U} ni could not have been born before \hat{U} nas; the first office that he filled under Teti III. was while he was a child or youth, while the reign of \hat{U} nas lasted thirty years.

² Literally, "crown-bearer." This was a title applied probably to children who served the king in his private apartments, and who wore crowns of natural flowers on their heads: the crown was doubtless of the same form as those which we see upon the brows of women on several tombs of the Memphite epoch.

³ The word "Khoniti" probably indicates lands with plantations of palms or acacias, the thinly wooded forests of Egypt, and also of the vines which belonged to the personal domain of the Pharaoh.

took him into his friendship at the beginning of his reign, and conferred upon him the title of "friend," and the office of head of the cabinet, in which position he acquitted himself with credit. Alone, without other help than that of a subordinate scribe, he transacted all the business and drew up all the documents connected with the harem and the privy council. He obtained an ample reward for his services. Pharaoh granted to him, as a proof of his complete satisfaction, the furniture of a tomb in choice white limestone; one of the officials of the necropolis was sent to obtain from the quarries at Troiû the blocks required, and brought back with him a sarcophagus and its lid, a door-shaped stele with its setting and a table of offerings. He affirms with much self-satisfaction that never before had such a thing happened to any one; moreover, he adds, "my wisdom charmed his Majesty, my zeal pleased him, and his Majesty's heart was delighted with me." All this is pure hyperbole, but no one was surprised at it in Egypt; etiquette required that a faithful subject should declare the favours of his sovereign to be something new and unprecedented, even when they presented nothing extraordinary or out of the common. Gifts of sepulchral furniture were of frequent occurrence, and we know of more than one instance of them previous to the VIth dynasty—for example, the case of the physician Sokhîtniônkhû, whose tomb still exists at Saqqâra, and whom Pharaoh Sahurî rewarded by presenting him with a monumental stele in stone from Turah. Henceforth Ûni could face without apprehension the future which awaited

him in the other world; at the same time, he continued to make his way no less quickly in this, and was soon afterwards promoted to the rank of "sole friend" and superintendent of the irrigated lands of the king. The "sole friends" were closely attached to the person of their master. In all ceremonies, their appointed place was immediately behind him, a place of the highest honour and trust, for those who occupied it literally held his life in their hands. They made all the arrangements for his processions and journeys, and saw that the proper ceremonial was everywhere observed, and that no accident was allowed to interrupt the progress of his train. Lastly, they had to take care that none of the nobles ever departed from the precise position to which his birth or office entitled him. This was a task which required a great deal of tact, for questions of precedence gave rise to nearly as many heart-burnings in Egypt as in modern courts. *Ûni* acquitted himself so dexterously, that he was called upon to act in a still more delicate capacity. Queen *Amitsi* was the king's chief consort. Whether she had dabbled in some intrigue of the palace, or had been guilty of unfaithfulness in act or in intention, or had been mixed up in one of those feminine dramas which so frequently disturb the peace of harems, we do not know. At any rate, *Papi* considered it necessary to proceed against her, and appointed *Ûni* to judge the case. Aided only by his secretary, he drew up the indictment and decided the action so discreetly, that to this day we do not know of what crime *Amitsi* was accused or how the matter

ended. Ûni felt great pride at having been preferred before all others for this affair, and not without reason, "for," says he, "my duties were to superintend the royal forests, and never before me had a man in my position been initiated into the secrets of the Royal Harem; but his Majesty initiated me into them because my wisdom pleased his Majesty more than that of any other of his lieges, more than that of any other of his mamelukes, more than that of any other of his servants."

These antecedents did not seem calculated to mark out Ûni as a future minister of war; but in the East, when a man has given proofs of his ability in one branch of administration, there is a tendency to consider him equally well fitted for service in any of the others, and the fiat of a prince transforms the clever scribe of to-day into the general of to-morrow. No one is surprised, not even the person promoted; he accepts his new duties without flinching, and frequently distinguishes himself as much in their performance as though he had been bred to them from his youth up. When Papi had resolved to give a lesson to the Bedouin of Sinai, he at once thought of Ûni, his "sole friend," who had so skilfully conducted the case of Queen Amïtsi. The expedition was not one of those which could be brought to a successful issue by the troops of the frontier nomes; it required a considerable force, and the whole military organization of the country had to be brought into play. "His Majesty raised troops to the number of several myriads, in the whole of the south from Elephantinê to the nome of the Haunch, in the Delta, in the two halves of the

valley, in each fort of the forts of the desert, in the land of Iritît, among the blacks of the land of Maza, among the blacks of the land of Amamît, among the blacks of the land of Ūaûait, among the blacks of the land of Kaaû, among the blacks of To-Tamû, and his Majesty sent me at the head of this army. It is true, there were chiefs there, there were mamelukes of the king there, there were sole friends of the Great House there, there were princes and governors of castles from the south and from the north, 'gilded friends,' directors of the prophets from the south and the north, directors of districts at the head of troops from the south and the north, of castles and towns that each one ruled, and also blacks from the regions which I have mentioned, but it was I who gave them their orders—although my post was only that of superintendent of the irrigated lands of Pharaoh,—so much so that every one of them obeyed me like the others." It was not without much difficulty that he brought this motley crowd into order, equipped them, and supplied them with rations. At length he succeeded in arranging everything satisfactorily; by dint of patience and perseverance, "each one took his biscuit and sandals for the march, and each one of them took bread from the towns, and each one of them took goats from the peasants." He collected his forces on the frontier of the Delta, in the "Isle of the North," between the "Gate of Imhotpû" and the "Tell of Horû nib-mâit," and set out into the desert. He advanced, probably by Gebel Magharah and Gebel Helal, as far as Wady-el-Arish, into the rich and populous country which

lay between the southern slopes of Gebel Tih and the south of the Dead Sea:¹ once there he acted with all the rigour permitted by the articles of war, and paid back with interest the ill usage which the Bedouin had inflicted on Egypt. "This army came in peace, it completely destroyed the country of the Lords of the Sands. This army came in peace, it pulverized the country of the Lords of the Sands. This army came in peace, it demolished their 'douars.' This army came in peace, it cut down their fig trees and their vines. This army came in peace, it burnt the houses of all their people. This army came in peace, it slaughtered their troops to the numbers of many myriads. This army came in peace, it brought back great numbers of their people as living captives, for which thing his Majesty praised me more than for aught else." As a matter of fact, these poor wretches were sent off as soon as taken to the quarries or to the dockyards, thus relieving the king from the necessity of imposing compulsory labour too frequently on his Egyptian subjects. "His Majesty sent me five times to lead this army in order to penetrate into the country of the Lords

¹ The locality of the tribes against which Ūni waged war can, I think, be fixed by certain details of the campaign, especially the mention of the oval or circular enclosures—ŪANĪT—within which they entrenched themselves. These enclosures, or *douars*, correspond to the *naūami* which are mentioned by travellers in these regions, and which are singularly characteristic. The "Lords of the Sands" mentioned by Ūni occupied the *naūami* country, *i.e.* the Negeb regions situated on the edge of the desert of Tih, round about Aīn-Qadis, and beyond it as far as Akabah and the Dead Sea. Assuming this hypothesis to be correct, the route followed by Ūni must have been the same as that which was discovered and described nearly twenty years ago, by HOLLAND.

of the Sands, on each occasion of their revolt against this army, and I bore myself so well that his Majesty praised me beyond everything." The Bedouin at length submitted, but the neighbouring tribes to the north of them, who had no doubt assisted them, threatened to dispute with Egypt the possession of the territory which it had just conquered. As these tribes had a seaboard on the Mediterranean, *Ûni* decided to attack them by sea, and got together a fleet in which he embarked his army. The troops landed on the coast of the district of Tiba, to the north of the country of the Lords of the Sands, thereupon "they set out. I went, I smote all the barbarians, and I killed all those of them who resisted." On his return, *Ûni* obtained the most distinguished marks of favour that a subject could receive, the right to carry a staff and to wear his sandals in the palace in the presence of Pharaoh.

These wars had occupied the latter part of the reign; the last of them took place very shortly before the death of the sovereign. The domestic administration of Papi I. seems to have been as successful in its results, as was his activity abroad. He successfully worked the mines of Sinai, caused them to be regularly inspected, and obtained an unusual quantity of minerals from them; the expedition he sent thither, in the eighteenth year of his reign, left behind it a bas-relief in which are recorded the victories of *Ûni* over the barbarians and the grants of territory made to the goddess *Hâthor*. Work was carried on uninterruptedly at the quarries of *Hatnûbû* and *Rohanû*; building operations were carried on at Memphis, where the pyramid was in course of erection, at Abydos, whither the oracle

of Osiris was already attracting large numbers of pilgrims, at Tanis, at Bubastis, and at Heliopolis. The temple of Dendera was falling into ruins; it was restored on the lines of the original plans which were accidentally discovered, and this piety displayed towards one of the most honoured deities was rewarded, as it deserved to be, by the insertion of the title of "son of Hâthor" in the royal cartouche. The vassals rivalled their sovereign in activity, and built new towns on all sides to serve them as residences, more than one of which was named after the Pharaoh. The death of Papi I. did nothing to interrupt this movement; the elder of his two sons by his second wife, Mirirî-ônkhnas, succeeded him without opposition. Mirirî Mihtimsaûf I. (Metesouphis) was almost a child when he ascended the throne. The recently conquered Bedouin gave him no trouble; the memory of their reverses was still too recent to encourage them to take advantage of his minority and renew hostilities. Ûni, moreover, was at hand, ready to recommence his campaigns at the slightest provocation. Metesouphis had retained him in all his offices, and had even entrusted him with new duties. "Pharaoh appointed me governor-general of Upper Egypt, from Elephantinê in the south to Letopolis in the north, because my wisdom was pleasing to his Majesty, because my zeal was pleasing to his Majesty, because the heart of his Majesty was satisfied with me. . . . When I was in my place I was above all his vassals, all his mamelukes, and all his servants, for never had so great a dignity been previously conferred upon a mere subject. I fulfilled to the satisfaction of the king my office as superintendent of the South, so satisfactorily,

that it was granted to me to be second in rank to him, accomplishing all the duties of a superintendent of works, judging all the cases which the royal administration had to judge in the south of Egypt as second judge, to render judgment at all hours determined by the royal administration in this south of Egypt as second judge, transacting as a governor all the business there was to do in this south of Egypt." The honour of fetching the hard stone blocks intended for the king's pyramid fell to him by right: he proceeded to the quarries of Abhâit, opposite Sehêl, to select the granite for the royal sarcophagus and its cover, and to those of Hatnûbû for the alabaster for the table of offerings. The transport of the table was a matter of considerable difficulty, for the Nile was low, and the stone of colossal size: Ûni constructed on the spot a raft to carry it, and brought it promptly to Saqqâra in spite of the sandbanks which obstruct navigation when the river is low.¹ This was not the limit of his enterprise: the Pharaohs had not as yet a fleet in Nubia, and even if they had had, the condition of the channel was such as to prevent it from making the passage of the cataract. He demanded acacia-wood from the tribes of the desert, the peoples of Iritit and Ûaûatt, and from the Mâzaiû, laid down his ships on the stocks, built three galleys and two large lighters in a single year; during this time the river-side labourers had cleared

¹ Prof. PETRIE has tried to prove from the passage which relates to the transport, that the date of the reign of Papi I. must have been within sixty years of 3240 B.C.; this date I believe to be at least four centuries too late. It is, perhaps, to this voyage of Ûni that the inscription of the Vth year of Metesouphis I. refers, given by BLACKDEN-FRAZER in *A Collection of Hieratic Graffiti from the Alabaster Quarry of Hat-nub*, pl. xv. 2.

five channels through which the flotilla passed and made its way to Memphis with its ballast of granite. This was Ūni's last exploit; he died shortly afterwards, and was buried in the cemetery at Abydos, in the sarcophagus which had been given him by Papi I.

Was it solely to obtain materials for building the pyramid that he had re-established communication by water between Egypt and Nubia? The Egyptians were gaining ground in the south every day, and under their rule the town of Elephantin  was fast becoming a d p t for trade with the Soudan.¹ The town occupied only the smaller half of a long narrow island, which was composed of detached masses of granite, formed gradually into a compact whole by accumulations of sand, and over which the Nile, from time immemorial, had deposited a thick coating of its mud. It is now shaded by acacias, mulberry trees, date trees, and



L. Thuillier, del.²
THE ISLAND OF ELEPHANTIN .²

¹ The growing importance of Elephantin  is shown by the dimensions of the tombs which its princes had built for themselves, as well as by the number of graffiti commemorating the visits of princes and functionaries, and still remaining at the present day.

² Plan drawn up by Thuillier, from the Map of the *Commission d' gypte*.

dôm palms, growing in some places in lines along the pathways, in others distributed in groups among the fields. Half a dozen saqiyehs, ranged in a line along the river-bank, raise water day and night, with scarcely any cessation of their monotonous creaking. The inhabitants do not allow a foot of their narrow domain to lie idle; they have



THE ISLAND OF ELEPHANTINÊ SEEN
FROM THE RUINS OF SYENE.¹

cultivated wherever it is possible small plots of durra and barley, bersim and beds of vegetables. A few scattered buffaloes and cows graze in corners, while fowls and pigeons without number roam about in flocks on the look-out for what they can pick up. It is a world in miniature, tranquil and pleasant, where life is passed without effort, in a perpetually clear atmosphere and in the

¹ Drawn by Boudier, from a photograph by Beato. In the foreground are the ruins of the Roman mole built of brick, which protected the entrance to the harbour of Syene; in the distance is the Libyan range, surmounted by the ruins of several mosques and of a Coptic monastery. Cf. the woodcut on p. 275 of the present work.

shade of trees which never lose their leaf. The ancient city was crowded into the southern extremity, on a high plateau of granite beyond the reach of inundations. Its ruins, occupying a space half a mile in circumference, are heaped around a shattered temple of Khuûmû, of which the most ancient parts do not date back beyond the sixteenth century before our era. It was surrounded with walls, and a fortress of sun-dried brick perched upon a neighbouring island to the south-west, gave it complete command over the passages of the cataract. An arm of the river ninety yards wide separated it from Sûânît, whose closely built habitations were ranged along the steep bank, and formed, as it were, a suburb. Marshy pasturages occupied the modern site of Syene; beyond these were gardens, vines, furnishing wine celebrated throughout the

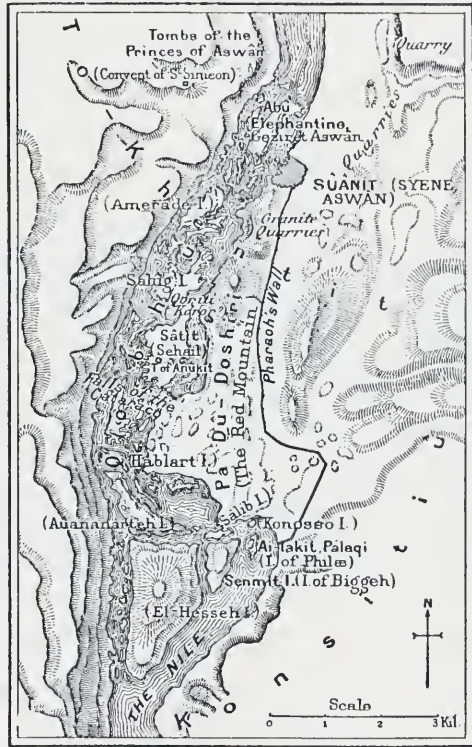

L. Thuillier, del.

THE FIRST CATARACT.¹

¹ Map by Thuillier, from *La Description de l'Égypte, Ant.*, vol. i. pl. 30, 1. I have added the ancient names in those cases where it has been possible to identify them with the modern localities.

whole of Egypt, and a forest of date palms running towards the north along the banks of the stream. The princes of the nome of Nubia encamped here, so to speak, as frontier-posts of civilization, and maintained frequent but variable relations with the people of the desert. It gave the former no trouble to throw, as occasion demanded it, bodies of troops on the right or left sides of the valley, in the direction of the Red Sea or in that of the Oasis; however little they might carry away in their raids—of oxen, slaves, wood, charcoal, gold dust, amethysts, cornelian or green felspar for the manufacture of ornaments—it was always so much to the good, and the treasury of the prince profited by it. They never went very far in their expeditions: if they desired to strike a blow at a distance, to reach, for example, those regions of Pûânît of whose riches the barbarians were wont to boast, the aridity of the district around the second cataract would arrest the advance of their foot-soldiers, while the rapids of Wady Halfa would offer an almost impassable barrier to their ships. In such distant operations they did not have recourse to arms, but disguised themselves as peaceful merchants. An easy road led almost direct from their capital to Ras Banât, which they called the “Head of Nekhabît,” on the Red Sea; arrived at the spot where in later times stood one of the numerous Berenices, and having quickly put together a boat from the wood of the neighbouring forest, they made voyages along the coast, as far as the Sinaitic peninsula and the Hirû-Shâîtû on the north, as well as to the land of Pûânît itself on the south. The small size of these improvised vessels rendered such expeditions dangerous, while it limited their gain;

they preferred, therefore, for the most part the land journey. It was fatiguing and interminable: donkeys—the only beast of burden they were acquainted with, or, at least, employed—could make but short stages, and they spent months upon months in passing through countries which



SMALL WADY, FIVE HOURS BEYOND ED-DOUEÏG, ON THE ROAD TO THE RED SEA.¹

a caravan of camels would now traverse in a few weeks.² The roads upon which they ventured were those which,

¹ Drawn by Faucher-Gudin, from a photograph by Golénischeff.

² The *History of the Peasant*, in the Berlin Papyri Nos. ii. and iv., affords us a good example of the use made of pack-asses; the hero was on his way across the desert, from the Wady Natrûn to Henasieh, with a quantity of merchandise which he intended to sell, when an unscrupulous artisan, under cover of a plausible pretext, stole his train of pack-asses and their loads. Hirkhûf brought back with him a caravan of three hundred asses from one of his journeys; cf. p. 278 of the present work.

owing to the necessity for the frequent watering of the donkeys and the impossibility of carrying with them adequate supplies of water, were marked out at frequent intervals by wells and springs, and were therefore necessarily of a tortuous and devious character. Their choice of objects for barter was determined by the smallness of their bulk and weight in comparison with their value. The Egyptians on the one side were provided with stocks of beads, ornaments, coarse cutlery, strong perfumes, and rolls of white or coloured cloth, which, after the lapse of thirty-five centuries, are objects still coveted by the peoples of Africa. The aborigines paid for these articles of small value, in gold, either in dust or in bars, in ostrich feathers, lions' and leopards' skins, elephants' tusks, cowrie shells, billets of ebony, incense, and gum arabic. Considerable value was attached to cynocephali and green monkeys, with which the kings or the nobles amused themselves, and which they were accustomed to fasten to the legs of their chairs on days of solemn reception; but the dwarf, the Danga, was the rare commodity which was always in demand, but hardly ever attainable.¹ Partly by commerce, and partly by pillage, the lords of Elefantinê became rapidly wealthy, and began to play an important part among the nobles of the Said: they were soon obliged to

¹ DÜMICHEN, *Geographische Inschriften*, vol. i. xxxi. l. 1, where the dwarfs and pigmies who came to the court of the king, in the period of the Ptolemies, to serve in his household, are mentioned. Various races of diminutive stature, which have since been driven down to the upper basin of the Congo, formerly extended further northward, and dwelt between Darfûr and the marshes of Bahr-el-Ghazâl. As to the Danga, cf. what has been said on p. 226 of the present work.



THE ROCKS OF THE ISLAND OF SEHÉL, WITH SOME OF THE VOTIVE INSCRIPTIONS.

Drawn by Boudier, from a photograph taken by Dévèria in 1864.

take serious precautions against the cupidity which their wealth excited among the tribes of Konusit. They entrenched themselves behind a wall of sun-dried brick, some seven and a half miles long, of which the ruins are still an object of wonder to the traveller. It was flanked towards the north by the ramparts of Syene, and followed pretty regularly the lower course of the valley to its abutment at the port of Mahatta opposite Philæ: guards distributed along it, kept an eye upon the mountain, and uttered a call to arms, when the enemy came within sight. Behind this bulwark the population felt quite at ease, and could work without fear at the granite quarries on behalf of the Pharaoh, or pursue in security their callings of fishermen and sailors. The inhabitants of the village of Satit and of the neighbouring islands claimed from earliest times the privilege of piloting the ships which went up and down the rapids, and of keeping clear the passages which were used for navigation. They worked under the protection of their goddesses Anûkit and Satit: travellers of position were accustomed to sacrifice in the temple of the goddesses at Sehêl, and to cut on the rock votive inscriptions in their honour, in gratitude for the prosperous voyage accorded to them. We meet their scrawls on every side, at the entrance and exit of the cataract, and on the small islands where they moored their boats at nightfall during the four or five days required for the passage; the bank of the stream between Elephantinê and Philæ is, as it were, an immense visitors' book, in which every generation of Ancient Egypt has in turn inscribed itself. The markets and streets of the twin cities must have presented at that

time the same motley blending of types and costumes which we might have found some years back in the bazaars of modern Syene. Nubians, negroes of the Soudan, perhaps people from Southern Arabia, jostled there with Libyans and Egyptians of the Delta. What the princes did to make the sojourn of strangers agreeable, what temples they consecrated to their god Khnûmû and his companions, in gratitude for the good things he had bestowed upon them, we have no means of knowing up to the present. Elephantinê and Syene have preserved for us nothing of their ancient edifices; but the tombs which they have left tell us their history. They honeycomb in long lines the sides of the steep hill which looks down upon the whole extent of the left bank of the Nile opposite the narrow channel of the port of Aswân. A rude flight of stone steps led from the bank to the level of the sepulchres. The mummy having been carried slowly on the shoulders of the bearers to the platform, was deposited for a moment at the entrance of the chapel. The decoration of the latter was rather meagre, and was distinguished neither by the delicacy of its execution nor by the variety of the subjects. More care was bestowed upon the exterior, and upon the walls on each side of the door, which could be seen from the river or from the streets of Elephantinê. An inscription borders the recess, and boasts to every visitor of the character of the occupant: the portrait of the deceased, and sometimes that of his son, stand to the right and left: the scenes devoted to the offerings come next, when an artist of sufficient skill could be found to engrave them.

The expeditions of the lords of Elephantinê, crowned as

they frequently were with success, soon attracted the attention of the Pharaohs: Metesouphis deigned to receive in person at the cataract the homage of the chiefs of Ūaûait and Iritit and of the Mâzaiû during the early days of the

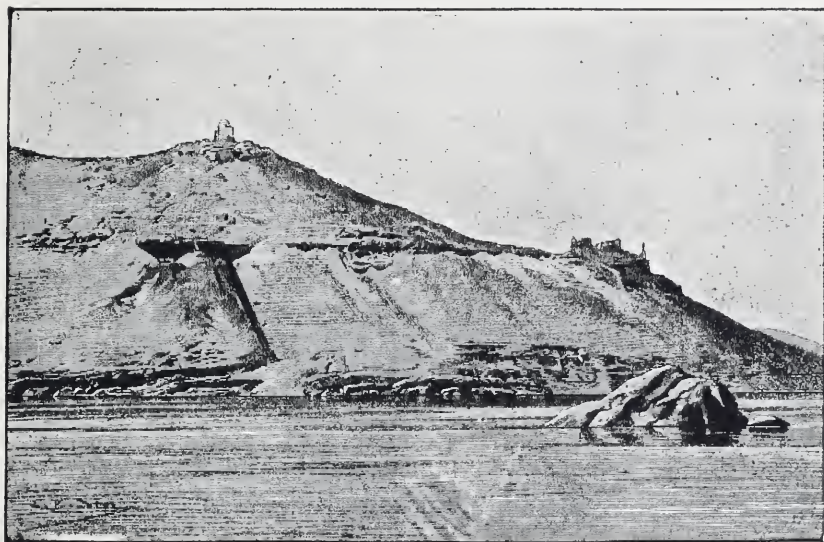

THE MOUNTAIN OF ASWAN AND THE TOMBS OF THE PRINCES OF ELEPHANTINÊ.¹

fifth year of his reign.² The most celebrated caravan guide at this time was Hirkhûf, own cousin to Mikhû, Prince of

¹ Drawn by Boudier, from a photograph by Insinger. The entrance to the tombs are halfway up; the long trench, cutting the side of the mountain obliquely, shelters the still existing steps which led to the tombs of Pharaonic times. On the sky-line may be noted the ruins of several mosques and Coptic monasteries.

² The words used in the inscription, "The king himself went and returned, ascending the mountain to see what there was on the mountain," prove that Metesouphis inspected the quarries in person. Another inscription, discovered in 1893, gives the year V. as the date of his journey to Elephantinê, and adds that he had negotiations with the heads of the four great Nubian races.

Elephantinê. He had entered upon office under the auspices of his father Iri, "the sole friend." A king whose name he does not mention, but who was perhaps Ūnas, more probably Papi I., despatched them both to the country of the Amamit. The voyage occupied seven months, and was extraordinarily successful: the sovereign, encouraged by this unexpected good fortune, resolved to send out a fresh expedition. Hirkhûf had the sole command of it; he made his way through Iritit, explored the districts of Satir and Darros, and retraced his steps after an absence of eight months. He brought back with him a quantity of valuable commodities, "the like of which no one had ever previously brought back." He was not inclined to regain his country by the ordinary route: he pushed boldly into the narrow wadys which furrow the territory of the people of Iritit, and emerged upon the region of Sitû, in the neighbourhood of the cataract, by paths in which no official traveller who had visited the Amamit had up to this time dared to travel. A third expedition which started out a few years later brought him into regions still less frequented. It set out by the Oasis route, proceeded towards the Amamit, and found the country in an uproar. The sheikhs had convoked their tribes, and were making preparations to attack the Timihû "towards the west corner of the heaven," in that region where stand the pillars which support the iron firmament at the setting sun. The Timihû were probably Berbers by race and language. Their tribes, coming from beyond the Sahara, wandered across the frightful solitudes which bound the Nile Valley on the west. The Egyptians

had constantly to keep a sharp look out for them, and to take precautions against their incursions; having for a long time acted only on the defensive, they at length took the offensive, and decided, not without religious misgivings, to pursue them to their retreats. As the inhabitants of Mendes and of Busiris had relegated the abode of their departed to the recesses of the impenetrable marshes of the Delta, so those of Siût and Thinis had at first believed that the souls of the deceased sought a home beyond the sands: the good jackal Anubis acted as their guide, through the gorge of the Cleft or through the gate of the Oven, to the green islands scattered over the desert, where the blessed dwelt in peace at a convenient distance from their native cities and their tombs. They constituted, as we know, a singular folk, those *ûiti* whose members dwelt in coffins, and who had put on the swaddling clothes of the dead; the Egyptians called the Oasis which they had colonised, the land of the shrouded, or of mummies, *ûit*, and the name continued to designate it long after the advance of geographical knowledge had removed this paradise further towards the west. The Oases fell one after the other into the hands of frontier princes—that of Bahnesa coming under the dominion of the lord of Oxyrrhynchus, that of Dakhel under the lords of Thinis. The Nubians of Amamit had relations, probably, with the Timihû, who owned the Oasis of Dush—a prolongation of that of Dakhel, on the parallel of Elephantinê. Hirkhûf accompanied the expedition to the Amamit, succeeded in establishing peace among the rival tribes, and persuaded them “to worship all the gods of Pharaoh:” he afterwards

reconciled the Iritî, Amamît, and Ūaûaît, who lived in a state of perpetual hostility to each other, explored their valleys, and collected from them such quantities of incense, ebony, ivory, and skins that three hundred asses were required for their transport. He was even fortunate

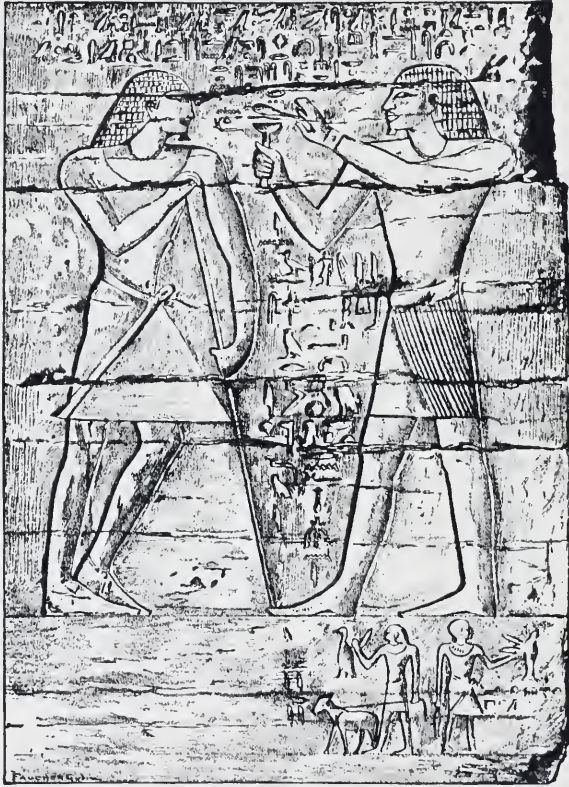

HIRKHÛF RECEIVING POSTHUMOUS HOMAGE AT THE DOOR OF HIS TOMB FROM HIS SON.¹

enough to acquire a Danga from the land of ghosts, resembling the one brought from Pûanît by Biûrdidi in the

¹ Drawn by Faucher-Gudin, from a photograph, taken in 1892, by Alexander Gayet.

reign of Assi eighty years before. Metesouphis, in the mean time, had died, and his young brother and successor, Papi II., had already been a year upon the throne. The new king, delighted to possess a dwarf who could perform "the dance of the god," addressed a rescript to Hirkhûf to express his satisfaction; at the same time he sent him a special messenger, Ūni, a distant relative to Papi I.'s minister, who was to invite him to come and give an account of his expedition. The boat in which the explorer embarked to go down to Memphis, also brought the Danga, and from that moment the latter became the most important personage of the party. For him all the royal officials, lords, and sacerdotal colleges hastened to prepare provisions and means of conveyance; his health was of greater importance than that of his protector, and he was anxiously watched lest he should escape. "When he is with thee in the boat, let there be cautious persons about him, lest he should fall into the water; when he rests during the night, let careful people sleep beside him, in case of his escaping quickly in the night-time. For my Majesty desires to see this dwarf more than all the treasures which are being imported from the land of Pûanît." Hirkhûf, on his return to Elephantinê, engraved the royal letter and the detailed account of his journeys to the lands of the south, on the façade of his tomb.

These repeated expeditions produced in course of time more important and permanent results than the capture of an accomplished dwarf, or the acquisition of a fortune by an adventurous nobleman. The nations which these merchants visited were accustomed to hear so much of

Egypt, its industries, and its military force, that they came at last to entertain an admiration and respect for her, not unmingled with fear: they learned to look upon her as a power superior to all others, and upon her king as a god whom none might resist. They adopted Egyptian worship, yielded to Egypt their homage, and sent the Egyptians presents: they were won over by civilization before being subdued by arms. We are not acquainted with the manner in which Nofirkirî-Papi II. turned these friendly dispositions to good account in extending his empire to the south. The expeditions did not all prove so successful as that of Hirkhûf, and one at least of the princes of Elephantinê, Papinakhîti, met with his death in the course of one of them. Papi II. had sent him on a mission, after several others, "to make profit out of the Ūaûaiû and the Iritât. He killed considerable numbers in this raid, and brought back great spoil, which he shared with Pharaoh; "for he was at the head of many warriors, chosen from among the bravest," which was the cause of his success in the enterprise with which his Holiness had deigned to entrust him. Once, however, the king employed him in regions which were not so familiar to him as those of Nubia, and fate was against him. He had received orders to visit the Amû, the Asiatic tribes inhabiting the Sinaitic Peninsula, and to repeat on a smaller scale in the south the expedition which Ūni had led against them in the north; he proceeded thither, and his sojourn having come to an end, he chose to return by sea. To sail towards Pûanût, to coast up as far as the "Head of Nekhabît," to land there and make straight for

Eléphantinê by the shortest route, presented no unusual difficulties, and doubtless more than one traveller or general of those times had safely accomplished it; Papinakhîti failed miserably. As he was engaged in constructing his vessel, the Hirû-Shâtû fell upon him and massacred him, as well as the detachment of troops who accompanied him: the remaining soldiers brought home his body, which was buried by the side of the other princes in the mountain opposite Syene. Papi II. had ample leisure to avenge the death of his vassal and to send fresh expeditions to Iritît, among the Amamît and even beyond, if, indeed, as the author of the chronological Canon of Turin asserts,¹ he really reigned for more than ninety years; but the monuments are almost silent with regard to him, and give us no information about his possible exploits in Nubia. An inscription of his second year proves that he continued to work the Sinaitic mines, and that he protected them from the Bedouin.

¹ The fragments of Manetho and the Canon of Eratosthenes agree in assigning to him a reign of a hundred years—a fact which seems to indicate that the missing unit in the Turin list was *nine*: Papi II. would have thus died in the hundredth year of his reign. A reign of a hundred years is impossible: Mihtimsaûf I. having reigned fourteen years, it would be necessary to assume that Papi II., son of Papi I., should have lived a hundred and fourteen years at the least, even on the supposition that he was a posthumous child. The simplest solution is to suppose (1) that Papi II. lived a hundred years, as Ramses II. did in later times, and that the years of his life were confounded with the years of his reign; or (2) that, being the brother of Mihtimsaûf I., he was considered as associated with him on the throne, and that the hundred years of his reign, including the fourteen of the latter prince, were identified with the years of his life. We may, moreover, believe that the chronologists, for lack of information on the VIth dynasty, have filled the blanks in their annals by lengthening the reign of Papi II., which in any case must have been very long.

On the other hand, the number and beauty of the tombs in which mention is made of him, bear witness to the fact that Egypt enjoyed continued prosperity. Recent discoveries have done much to surround this king and his immediate predecessors with an air of reality which is lacking in many of the later Pharaohs. Their pyramids,



HEAD OF THE MUMMY OF METESOUPHIS I.¹

whose familiar designations we have deciphered in the texts, have been uncovered at Saqqâra, and the inscriptions which they contain, reveal to us the

names of the sovereigns who reposed within. Ūnas, Teti III., Papi I., Metesouphis I., and Papi

II. now have as clearly defined a personality for us as Ramses II. or Seti I.; even the mummy of Metesouphis

has been discovered near his sarcophagus, and can be seen under glass in the Gîzeh Museum. The body is thin and slender; the head refined, and ornamented with the thick side-lock of boyhood; the features can be easily distinguished, although the lower jaw has disappeared and the pressure of the bandages has flattened

¹ Drawn by Boudier, from a photograph by Émil Brugsch-Bey. The mummy is now in the Gîzeh Museum (cf. MASPERO, *Guide au Musée de Boulaq*, pp. 347, 348, No. 5250).

the nose. All the pyramids of the dynasty are of a uniform type, the model being furnished by that of Ūnas. The entrance is in the centre of the northern façade, underneath the lowest course, and on the ground-level. An inclined passage, obstructed by enormous stones, leads to an antechamber, whose walls are partly bare, and partly covered with long columns of hieroglyphs: a level passage,

blocked towards the middle by three granite barriers, ends in a nearly square chamber; on the left are three low cells devoid of ornament, and on the right an oblong

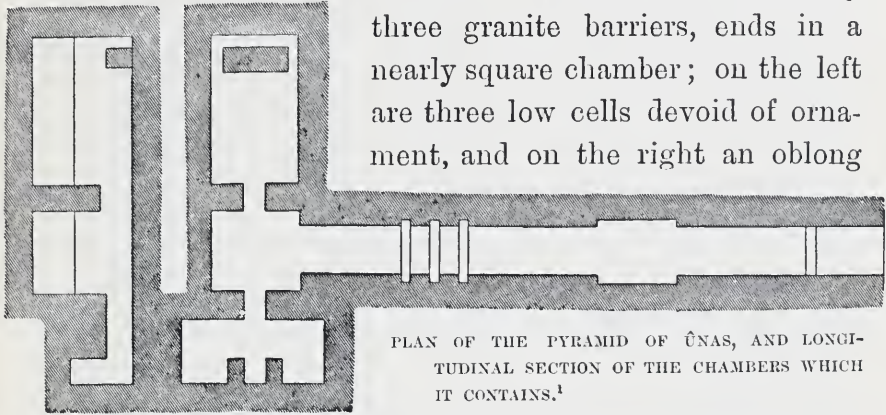

PLAN OF THE PYRAMID OF ŪNAS, AND LONGITUDINAL SECTION OF THE CHAMBERS WHICH IT CONTAINS.¹

chamber containing the sarcophagus. These two principal rooms had high-pitched roofs. They were composed of large slabs of limestone, the upper edges of which leaned one against the other, while the lower edges rested on a continuous ledge which ran round the chamber: the first row of slabs was surmounted by a second, and that again by a third, and the three together effectively protected the apartments of the dead against the thrust of the superincumbent mass, or from the attacks of robbers. The wall-surfaces close to the sarcophagus in the pyramid

¹ From drawings by MASPERO, *La Pyramide d'Ounas*, in the *Recueil de Travaux*, vol. iv. p. 177.

of Ūnas are decorated with many-coloured ornaments and sculptured and painted doors representing the front of a



THE SEPULCHRAL CHAMBER IN THE PYRAMID OF ŪNAS, AND HIS SARCOPHAGUS.¹

house: this was, in fact, the dwelling of the double, in

¹ Drawn by Boudier, from a photograph, taken in 1881, by Émil Brugsch-Bey.

which he resided with the dead body. The inscriptions, like the pictures in the tombs, were meant to furnish the sovereign with provisions, to dispel serpents and malevolent divinities, to keep his soul from death, and to lead him into the bark of the sun or into the Paradise of Osiris. They constitute a portion of a vast book, whose chapters are found scattered over the monuments of subsequent periods. They are the means of restoring to us, not only the religion but the most ancient language of Egypt: the majority of the formulas contained in them were drawn up in the time of the earliest human kings, perhaps even before Menes.

The history of the VIth dynasty loses itself in legend and fable. Two more kings are supposed to have succeeded Papi Nofirkeri, Mirniri Mihtimsaüt (Metesouphis II.) and Nitaüqrit (Nitokris). Metesouphis II. was killed, so runs the tale, in a riot, a year after his accession.¹ His sister, Nitokris, the "rosy-cheeked," to whom, as was the custom, he was married, succeeded him and avenged his death. "She built an immense subterranean hall; under pretext of inaugurating its completion, but in reality with a totally different aim, she then invited to a great feast, and received in this hall, a considerable number of Egyptians from among those whom she knew to have been instigators of the crime. During the entertainment, she diverted the

¹ MANETHO does not mention this fact, but the legend given by Herodotus says that Nitokris wished to avenge the king, her brother and predecessor, who was killed in a revolution; and it follows from the narrative of the facts that this anonymous brother was the Metesouphis of Manetho. The Turin Papyrus assigns a reign of a year and a month to Mihtimsaüf-Metesouphis II.

waters of the Nile into the hall by means of a canal which she had kept concealed. This is what is related of her. They add, that after this, the queen, of her own will, threw herself into a great chamber filled with ashes, in order to escape punishment." She completed the pyramid of Mykerinos, by adding to it that costly casing of Syenite which excited the admiration of travellers; she reposed in a sarcophagus of blue basalt, in the very centre of the monument, above the secret chamber where the pious Pharaoh had hidden his mummy.¹ The Greeks, who had heard from their dragomans the story of the "Rosy-cheeked Beauty," metamorphosed the princess into a courtesan, and for the name of Nitokris, substituted the more harmonious one of Rhodopis, which was the exact translation of the characteristic epithet of the Egyptian queen. One day while she was bathing in the river, an eagle stole one of her gilded sandals, carried it off in the direction of Memphis, and let it drop in the lap of the king, who was administering justice in the open air. The king, astonished at the singular occurrence, and at the beauty of the tiny shoe, caused a search to be made throughout the country for the woman to whom it belonged: Rhodopis thus became Queen of Egypt, and could build herself a pyramid. Even Christianity and the Arab conquest did not entirely efface the remembrance of the courtesan-princess. "It is said that the spirit of the Southern

¹ The legend which ascribes the building of the third pyramid to a woman has been preserved by Herodotus: E. de Bunsen, comparing it with the observations of Vyse, was inclined to attribute to Nitokris the enlarging of the monument, which appears to me to have been the work of Mykerinos himself.



THE ENTRANCE TO THE PYRAMID OF UNAS AT SAQQARA.
Drawn by Boudier, from a photograph by Émil Brugsch-Bey.

Pyramid never appears abroad, except in the form of a naked woman, who is very beautiful, but whose manner of acting is such, that when she desires to make people fall in love with her, and lose their wits, she smiles upon them, and immediately they draw near to her, and she attracts them towards her, and makes them infatuated with love; so that they at once lose their wits, and wander aimlessly about the country. Many have seen her moving round the pyramid about midday and towards sunset. It is Nitokris still haunting the monument of her shame and her magnificence.¹

After her, even tradition is silent, and the history of Egypt remains a mere blank for several centuries. Manetho admits the existence of two other Memphite dynasties, of which the first contains seventy kings during as many days. Akhthoës, the most cruel of tyrants, followed next, and oppressed his subjects for a long period: he was at last the victim of raving madness, and met with his death from the jaws of a crocodile. It is

¹ The lists of the VIth dynasty, with the approximate dates of the kings, are as follows:—

| ACCORDING TO THE TURIN CANON AND THE MONUMENTS. | ACCORDING TO MANETHO. |
|--|--------------------------|
| TETI III., 3808-3798? . . . ? | OTHOES 30 |
| MIRIRÎ PAPI I., 3797-3777?. 20 | PHIOS 53 |
| MIRNIRÎ I., MIHTIMSAÛF I., 3776-3762? 14 | METESOUPHIS 7 |
| NOFIRKERÎ PAPI II., 3761- 3661? 90 + ? | PHIOPS 100 |
| MIRNIRÎ II., MIHTIMSAÛF II., 3660-3659? 1 y. 1 m. | MENTESOUPHIS 1 |
| NITACÛRÎT 3658? ? | NITOKRIS. 12 |

related that he was of Heracleopolite extraction, and the two dynasties which succeeded him, the IXth and the Xth, were also Heracleopolitan. The table of Abydos is incomplete, and the Turin Papyrus, in the absence of other documents, too mutilated to furnish us with any exact information; the contemporaries of the Ptolemies were almost entirely ignorant of what took place between the end of the VIth and the beginning of the XIIth dynasty; and Egyptologists, not finding any monuments which they could attribute to this period, thereupon concluded that Egypt had passed through some formidable crisis out of which she with difficulty extricated herself.¹ The so-called Heracleopolites of Manetho were assumed to have been the chiefs of a barbaric people of Asiatic origin, those same "Lords of the Sands" so roughly handled by Ûni, but who are considered to have invaded the Delta soon after, settled themselves in Heracleopolis Parva as their capital, and from thence held sway over the whole valley. They appeared to have destroyed much and built nothing;

¹ Marsham (*Canon Chronicus*, edition of Leipzig, 1676, p. 29) had already declared in the seventeenth century that he felt no hesitation in considering the Heracleopolites as identical with the successors of Menes-Misraïm, who reigned over the Mestraea, that is, over the Delta only. The idea of an Asiatic invasion, analogous to that of the Hyksos, which was put forward by Mariette, and accepted by Fr. Lenormant, has found its chief supporters in Germany. Bunsen made of the Heracleopolitan two subordinate dynasties reigning simultaneously in Lower Egypt, and originating at Heracleopolis in the Delta: they were supposed to have been contemporaries of the last Memphite and first Theban dynasties. Lepsius accepted and recognized in the Heracleopolitans of the Delta the predecessors of the Hyksos, an idea defended by Ebers, and developed by Krall in his identification of the unknown invaders with the Hirû-Shâitû: it has been adopted by Ed. Meyer, and by Petrie.

the state of barbarism into which they sank, and to which they reduced the vanquished, explaining the absence of any monuments to mark their occupation. This hypothesis, however, is unsupported by any direct proof: even the dearth of monuments which has been cited as an argument in favour of the theory, is no longer a fact. The sequence of reigns and details of the revolutions are wanting; but many of the kings and certain facts in their history are known, and we are able to catch a glimpse of the general course of events. The VIIth and VIIIth dynasties are Memphite, and the names of the kings themselves would be evidence in favour of their genuineness, even if we had not the direct testimony of Manetho: the one recurring most frequently is that of Nofirkerî, the prenomen of Papi II., and a third Papi figures in them, who calls himself Papi-Sonbû to distinguish himself from his namesakes. The little recorded of them in Ptolemaic times, even the legend of the seventy Pharaohs reigning seventy days, betrays a troublous period and a rapid change of rulers.¹ We know as a fact that the successors of Nitokris, in the Royal Turin Papyrus, scarcely did more than appear upon the throne. Nofirkerî reigned a year, a month, and a day; Nofirûs, four years, two months, and a day; Abû, two years, one month, and a day. Each of them hoped, no doubt, to enjoy the royal power for a longer period than

¹ The explanation of Prof. Lauth, according to which Manetho is supposed to have made an independent dynasty of the five Memphite priests who filled the interregnum of seventy days during the embalming of Nitokris, is certainly very ingenious, but that is all that can be said for it. The legendary source from which Manetho took his information distinctly recorded seventy successive kings, who reigned in all seventy days, a king a day.

his predecessors, and, like the Ati of the VIth dynasty, ordered a pyramid to be designed for him without delay : not one of them had time to complete the building, nor even to carry it sufficiently far to leave any trace behind. As none of them had any tomb to hand his name down to posterity, the remembrance of them perished with their contemporaries. By dint of such frequent changes in the succession, the royal authority became enfeebled, and its weakness favoured the growing influence of the feudal families and encouraged their ambition. The descendants of those great lords, who under Papi I. and II. made such magnificent tombs for themselves, were only nominally subject to the supremacy of the reigning sovereign ; many of them were, indeed, grandchildren of princesses of the blood, and possessed, or imagined that they possessed, as good a right to the crown as the family on the throne. Memphis declined, became impoverished, and dwindled in population. Its inhabitants ceased to build those immense stone mastabas in which they had proudly displayed their wealth, and erected them merely of brick, in which the decoration was almost entirely confined to one narrow niche near the sarcophagus. Soon the mastaba itself was given up, and the necropolis of the city was reduced to the meagre proportions of a small provincial cemetery. The centre of that government, which had weighed so long and so heavily upon Egypt, was removed to the south, and fixed itself at Heracleopolis the Great.



THE FIRST THEBAN EMPIRE

THE TWO HERACLEOPOLITAN DYNASTIES AND THE TWELFTH DYNASTY—THE CONQUEST OF ÆTHIOPIA, AND THE MAKING OF GREATER EGYPT BY THE THEBAN KINGS.

The principality of Heracleopolis: Akthoës-Khiti and the Heracleopolitan dynasties—Supremacy of the great barons: the feudal fortresses, El-Kab and Abydos; ceaseless warfare, the army—Origin of the Theban principality: the principality of Siût, and the struggles of its lords against the princes of Thebes—The kings of the XIth dynasty and their buildings: the brick pyramids of Abydos and Thebes, and the rude character of early Theban art.

The XIIth dynasty: Amenemhât I., his accession, his wars; he shares his throne with his son Usirtasen I., and the practice of a co regnancy prevails among his immediate successors—The relations of Egypt with Asia: the Amû in Egypt and the Egyptians among the Bedouin; the Adventures of Sinûhît—The mining settlements in the Sinaitic peninsula: Sarbût-el-Khâdim and its chapel to Hâthor.

Egyptian policy in the Nile Valley—Nubia becomes part of Egypt: works

of the Pharaohs, the gold-mines and citadel of Kubân—Defensive measures at the second cataract: the two fortresses and the Nilometer of Sennêh—The vile Kûsh and its inhabitants: the wars against Kûsh and their consequences; the gold-mines—Expeditions to Pâanût, and navigation along the coasts of the Red Sea: the Story of the Shipwrecked Sailor.

Public works and new buildings—The restoration of the temples of the Delta: Tanis and the sphinxes of Amenemhât III., Bubastis, Heliopolis, and the temple of Úsirtasen I.—The increasing importance of Thebes and Abydos—Heracléopolis and the Fayûm: the monuments of Begig and of Biahmâ, the fields and water-system of the Fayûm; preference shown by the Pharaohs for this province—The royal pyramids of Dashûr, Lisht, Illahûn, and Hawâra.

The part played by the feudal lords under the XIIth dynasty—History of the princes of Monâût-Khâfâi: Khnûmhotpû, Khiti, Amoni-Amenemhât—The lords of Thebes, and the accession of the XIIIth dynasty: the Sovkhotpûs and the Nofirhotpûs—Completion of the conquest of Nubia; the XIVth dynasty.





THE HILLS WEST OF THEBES, AS SEEN FROM THE SOUTHERN END OF LUXOR.¹

CHAPTER III

THE FIRST THEBAN EMPIRE

The two Heracleopolitan dynasties and the XIIth dynasty—The conquest of Æthiopia, and the making of Greater Egypt by the Theban kings.



THE principality of the Oleander—Nârû—was bounded on the north by the Memphite nome; the frontier ran from the left bank of the Nile to the Libyan range, from the neighbourhood of Riqqah to that of Mèdûm. The principality comprised the territory lying between the Nile and the Bahr Yûsûf, from the above-mentioned two villages to the Harabshent Canal—a district known

¹ Drawn by Boudier, from a photograph by Golénischeff. The vignette

to Greek geographers as the island of Heracleopolis;—it moreover included the whole basin of the Fâyûm, on the west of the valley. In very early times it had been divided into three parts: the Upper Oleander—Nârû Khonîti—the Lower Oleander—Nârû Pahûi—and the lake land—To-shît; and these divisions, united usually under the supremacy of one chief, formed a kind of small state, of which Heracleopolis was always the capital. The soil was fertile, well watered, and well tilled, but the revenues from this district, confined between the two arms of the river, were small in comparison with the wealth which their ruler derived from his hands on the other side of the mountain range. The Fayûm is approached by a narrow and winding gorge, more than six miles in length—a depression of natural formation, deepened by the hand of man to allow a free passage to the waters of the Nile. The canal which conveys them leaves the Bahr Yûsûf at a point a little to the north of Heracleopolis, carries them in a swift stream through the gorge in the Libyan chain, and emerges into an immense amphitheatre, whose highest side is parallel to the Nile valley, and whose terraced slopes descend abruptly to about a hundred feet below the level of the Mediterranean. Two great arms separate themselves from this canal to the right and left—the Wady Tamieh and the Wady Nazleh; they wind at first along the foot of the hills, and then again approaching each other, empty themselves into a great crescent or horn-shaped lake, lying east and west—the Mœris of Strabo, the Birket-Kerun of

represents the bust of a statue of Amenemhât III., drawn by Faucher-Gudin, from a photograph by Golénisheff.

the Arabs. A third branch penetrates the space enclosed by the other two, passes the town of Shodû, and is then subdivided into numerous canals and ditches, whose ramifications appear on the map as a network resembling the

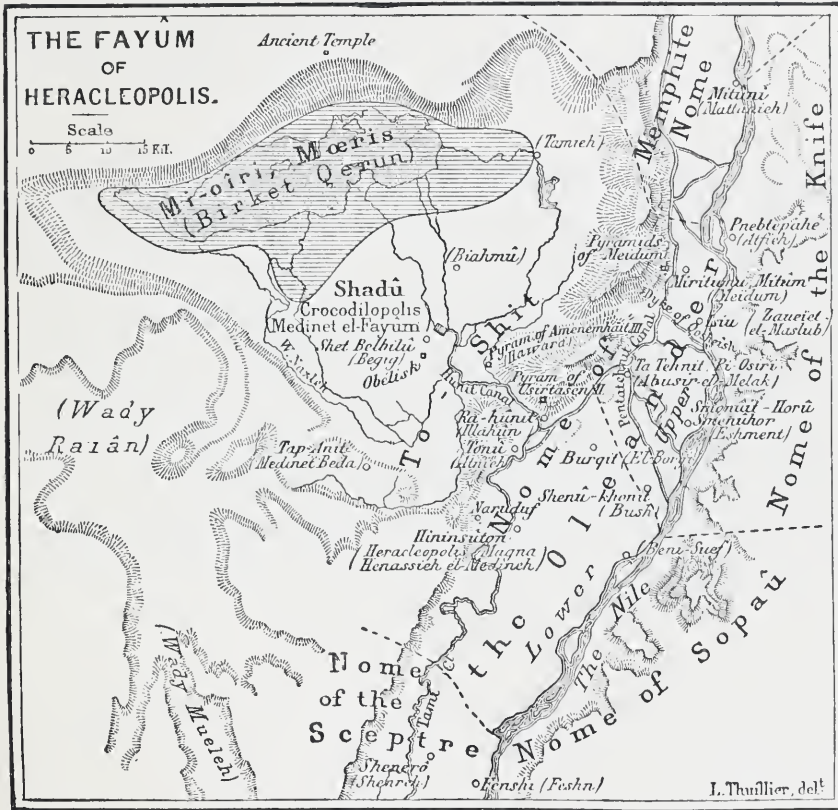

reticulations of a skeleton leaf. The lake formerly extended beyond its present limits, and submerged districts from which it has since withdrawn.¹ In years when the inundation

¹ Most of the specialists who have latterly investigated the Fayûm have greatly exaggerated the extent of the Birket-Kerûn in historic times. Prof. PETRIE states that it covered the whole of the present province throughout

was excessive, the surplus waters were discharged into the lake; when, however, there was a low Nile, the storage which had not been absorbed by the soil was poured back into the valley by the same channels, and carried down by the Bahr-Yûsûf to augment the inundation of the Western Delta. The Nile was the source of everything in this principality, and hence they were gods of the waters who

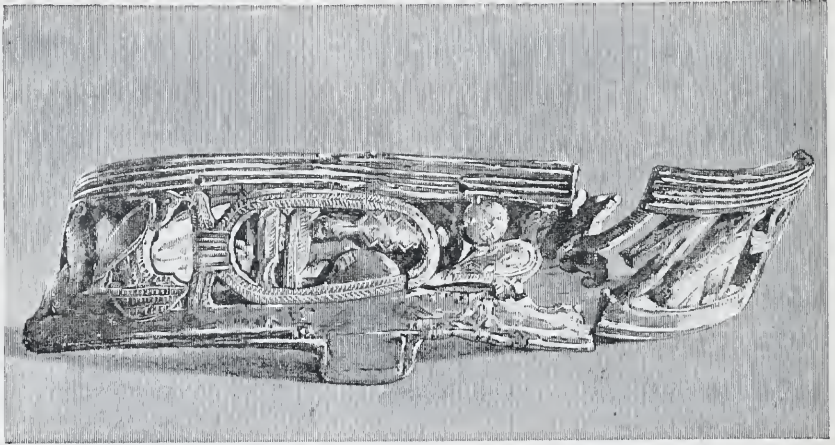

FLAT-BOTTOMED VESSEL OF BRONZE OPEN-WORK BEARING THE CARTOUCHES OF PHARAOH KHÛFI I.¹

received the homage of the three nomes. The inhabitants of Heracleopolis worshipped the ram Harshafîtû, with

the time of the Memphite kings, and that it was not until the reign of Amenemhât I. that even a very small portion was drained. Major Brown adopts this theory, and considers that it was under Amenemhât III. that the great lake of the Fayûm was transformed into a kind of artificial reservoir, which was the Meris of Herodotus. The city of Shodû, Shadû, Shadit—the capital of the Fayûm—and its god Sovkû are mentioned even in the Pyramid texts: and the eastern district of the Fayûm is named in the inscription of Amten, under the IIIrd dynasty.

¹ Drawn by Faucher-Gudin, from the original in the Louvre Museum.

whom they associated Osiris of Narûdûf as god of the dead ; the people of the Upper Oleander adored a second ram, Khnûmû of Hâsmonitû, and the whole Fayûm was devoted to the cult of Sovkû the crocodile. Attracted by the fertility of the soil, the Pharaohs of the older dynasties had from time to time taken up their residence in Heracleopolis or its neighbourhood, and one of them—Snofrûi—had built his pyramid at Mêdûm, close to the frontier of the nome. In proportion as the power of the Memphites declined, the princes of the Oleander grew more vigorous and enterprising ; and when the Memphite kings passed away, these princes succeeded their former masters and sat “ upon the throne of Horus.”

The founder of the IXth dynasty was perhaps Khiti I., Miribri, the Akhthoës of the Greeks. He ruled over all Egypt, and his name has been found on rocks at the first cataract. A story dating from the time of the Ramessides mentions his wars against the Bedouin of the regions east of the Delta ; and what Manetho relates of his death is merely a romance, in which the author, having painted him as a sacrilegious tyrant like Kheops and Khephren, states that he was dragged down under the water and there devoured by a crocodile or hippopotamus, the appointed avengers of the offended gods. His successors seem to have reigned ingloriously for more than a century. Their deeds are unknown to history, but it was under the reign of one of them—Nibkaûri—that a travelling fellah, having been robbed of his earnings by an artisan, is said to have journeyed to Heracleopolis to demand justice from the governor, or to charm him by the eloquence of his pleadings

and the variety of his metaphors. It would, of course, be idle to look for the record of any historic event in this story; the common people, moreover, do not long remember the names of unimportant princes, and the tenacity with which the Egyptians treasured the memories of several kings of the Heracleopolitan line amply proves that, whether by their good or evil qualities, they had at least



PART OF THE WALLS OF EL-KAB ON THE NORTHERN SIDE.¹

made a lasting impression upon the popular imagination. The history of this period, as far as we can discern it through the mists of the past, appears to be one confused struggle: from north to south war raged without intermission; the Pharaohs fought against their rebel vassals,

¹ Drawn by Boudier, from a photograph by Grébaut. The illustration shows a breach where the gate stood, and the curves of the brickwork courses can clearly be traced both to the right and the left of the opening.

the nobles fought among themselves, and—what scarcely amounted to warfare—there were the raids on all sides of pillaging bands, who, although too feeble to constitute any serious danger to large cities, were strong enough either in numbers or discipline to render the country districts uninhabitable, and to destroy national prosperity. The banks of the Nile already bristled with citadels, where the nomarchs lived and kept watch over the lands subject to their authority: other fortresses were established wherever any commanding site—such as a narrow part of the river, or the mouth of a defile leading into the desert—presented itself. All were constructed on the same plan, varied only by the sizes of the areas enclosed, and the different thickness of the outer walls. The outline of their ground-plan formed a parallelogram, whose enclosure wall was often divided into vertical panels easily distinguished by the different arrangements of the building material. At El-Kab and other places the courses of crude brick are slightly concave, somewhat resembling a wide inverted arch whose outer curve rests on the ground. In other places there was a regular alternation of lengths of curved courses, with those in which the courses were strictly horizontal. The object of this method of structure is still unknown, but it is thought that such building offers better resistance to shocks of earthquake. The most ancient fortress at Abydos, whose ruins now lie beneath the mound of Kom-es-Sultân, was built in this way. Tombs having encroached upon it by the time of the VIth dynasty, it was shortly afterwards replaced by another and similar fort, situate rather more than a hundred yards to the south-east; the latter is still

one of the best-preserved specimens of military architecture dating from the times immediately preceding the first Theban empire.¹ The exterior is unbroken by towers or projections of any kind, and consists of four sides, the two longer of which are parallel to each other and measure 143 yards from east to west: the two shorter sides, which are also parallel, measure 85 yards from north to south. The

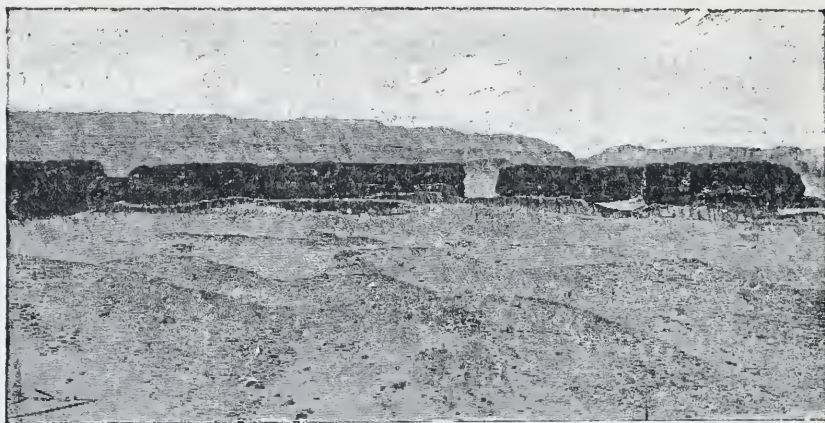

THE SECOND FORTRESS OF ABYDOS—THE SHÛNET-EZ-ZEBÎB—AS SEEN FROM THE EAST.²

outer wall is solid, built in horizontal courses, with a slight batter, and decorated by vertical grooves, which at all hours of the day diversify the surface with an incessant play of light and shade. When perfect it can hardly have

¹ My first opinion was that the second fortress had been built towards the time of the XVIIIth dynasty at the earliest, perhaps even under the XXth. Further consideration of the details of its construction and decoration now leads me to attribute it to the period between the VIth and XIIth dynasties.

² Drawn by Boudier, from a photograph by Émil Brugsch-Bey. Modern Arabs call it *Shûnet-*ez-Zebîb**, the storehouse of raisins.

been less than 40 feet in height. The walk round the ramparts was crowned by a slight, low parapet, with rounded battlements, and was reached by narrow staircases carefully constructed in the thickness of the walls. A battlemented covering wall, about five and a half yards high, encircled the building at a distance of some four feet. The fortress itself was entered by two gates, and posterns placed at various points between them provided for sorties of the garrison. The principal entrance was concealed in a thick block of building at the southern extremity of the east front. The corresponding entrance in the covering wall was a narrow opening closed by massive wooden doors; behind it was a small *place d'armes*, at the further end of which was a second gate, as narrow as the first, and leading into an oblong court hemmed in between the outer rampart and two bastions projecting at right angles from it; and lastly, there was a gate purposely placed at the furthest and least obvious corner of the court. Such a fortress was strong enough to resist any modes of attack then at the disposal of the best-equipped armies, which knew but three ways of taking a place by force, viz. scaling, sapping, and breaking open the gates. The height of the walls effectually prevented scaling. The pioneers were kept at a distance by the braye, but if a breach were made in that, the small flanking galleries fixed outside the battlements enabled the besieged to overwhelm the enemy with stones and javelins as they approached, and to make the work of sapping almost impossible. Should the first gate of the fortress yield to the assault, the attacking party would be crowded together in the courtyard as in a pit, few being able to

enter together; they would at once be constrained to attack the second gate under a shower of missiles, and did they succeed in carrying that also, it was at the cost of enormous sacrifice. The peoples of the Nile Valley knew nothing of the swing battering-ram, and no representation of the hand-worked battering-ram has ever been found in any of their wall-paintings or sculptures; they forced their way into a stronghold by breaking down its gates with their axes, or by setting fire to its doors. While the sappers were hard at work, the archers endeavoured, by the

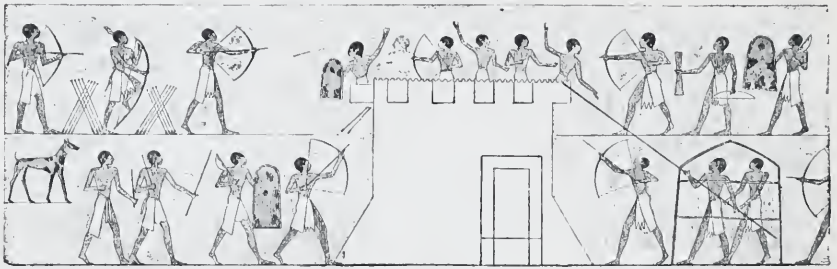

ATTACK UPON AN EGYPTIAN FORTRESS BY TROOPS OF VARIOUS ARMS.¹

accuracy of their aim, to clear the enemy from the curtain, while soldiers sheltered behind movable mantelets tried to break down the defences and dismantle the flanking galleries with huge metal-tipped lances. In dealing with a resolute garrison none of these methods proved successful; nothing but close siege, starvation, or treachery could overcome its resistance.

The equipment of Egyptian troops was lacking in

¹ Drawn by Faucher-Gudin, from a scene in the tomb of Amoni-Amenemhât at Beni-Hasan.

uniformity, and men armed with slings, or bows and arrows, lances, wooden swords, clubs, stone or metal axes, all fought side by side. The head was protected by a padded cap, and the body by shields, which were small for light infantry, but of great width for soldiers of the line. The issue of a battle depended upon a succession of single combats between foes armed with the same weapons; the lancers alone seem to have charged in line behind their huge bucklers. As a rule, the wounds were trifling, and the great skill with which the shields were used made the risk of injury to any vital part very slight. Sometimes, however, a lance might be driven home into a man's chest, or a vigorously wielded sword or club might fracture a combatant's skull and stretch him unconscious on the ground. With the exception of those thus wounded and incapacitated for flight, very few prisoners were taken, and the name given to them, "Those struck down alive" — *sokirûonkhû* — sufficiently indicates the method of their capture. The troops were recruited partly from the domains of military fiefs, partly from tribes of the desert or Nubia, and by their aid the feudal princes maintained the virtual independence which they had acquired for themselves under the last kings of the Memphite line. Here and there, at Hermopolis, Siût, and Thebes, they founded actual dynasties, closely connected with the Pharaonic dynasty, and even occasionally on an equality with it, though they assumed neither the crown nor the double cartouche. Thebes was admirably adapted for becoming the capital of an important state. It rose on the right bank of the Nile, at the northern

end of the curve made by the river towards Hermonthis, and in the midst of one of the most fertile plains of Egypt. Exactly opposite to it, the Libyan range throws out a precipitous spur broken up by ravines and arid amphitheatres, and separated from the river-bank by a mere strip of cultivated ground which could be easily defended. A troop of armed men stationed on this neck of land could command the navigable arm of the Nile, intercept trade with Nubia at their pleasure, and completely bar the valley to any army attempting to pass without having first obtained authority to do so. The advantages of this site do not seem to have been appreciated during the Memphite period, when the political life of Upper Egypt was but feeble. Elephantinê, El-Kab, and Koptos were at that period the principal cities of the country. Elephantinê particularly, owing to its trade with the Soudan, and its constant communication with the peoples bordering the Red Sea, was daily increasing in importance. Hermonthis, the Aûnû of the South, occupied much the same position, from a religious point of view, as was held in the Delta by Heliopolis, the Aûnû of the North, and its god Montû, a form of the Solar Horus, disputed the supremacy with Minû, of Koptos. Thebes long continued to be merely an insignificant village of the Ûisit nome and a dependency of Hermonthis. It was only towards the end of the VIIIth dynasty that Thebes began to realize its power, after the triumph of feudalism over the crown had culminated in the downfall of the Memphite kings. A family which, to judge from the fact that its members affected the name of Monthotpû, originally came from



Hermonthis, settled in Thebes and made that town the capital of a small principality, which rapidly enlarged its borders at the expense of the neighbouring nomes. All the towns and cities of the plain, Mâdût, Hfût, Zorît, Hermonthis, and towards the south, Aphroditopolis Parva, at the gorge of the Two Mountains (Gebelên) which formed the frontier of the fief of El-Kab, Kûsît towards the north, Denderah, and Hû, all fell into the hands of the Theban princes and enormously increased their territory. After the lapse of a very few years, their supremacy was accepted more or less willingly by the adjacent principalities of El-Kab, Elephantinê, Koptos, Qasr-es-Sayad, Thinis, and Ekhnîm. Antûf, the founder of the family, claimed no other title than that of Lord of Thebes, and still submitted to the suzerainty of the Heracleopolitan kings. His successors considered themselves strong enough to cast off this allegiance, if not to usurp all the insignia of royalty, including the uræus and the cartouche. Monthotpû I., Antûf II., and Antûf III. must have occupied a somewhat remarkable position among the great lords of the south, since their successors credited them with the possession of a unique preamble. It is true that the historians of a later date did not venture to place them on a par with the kings who were actually independent; they enclosed their names in the cartouche without giving them a prenomén; but, at the same time, they invested them with a title not met with elsewhere, that of the first Horus—*Horû tapi*. They exercised considerable power from the outset. It extended over Southern Egypt, over Nubia, and over the valleys lying

between the Nile and the Red Sea.¹ The origin of the family was somewhat obscure, but in support of their ambitious projects, they did not fail to invoke the memory of pretended alliances between their ancestors and daughters of the solar race; they boasted of their descent from the Papis, from Ūsiriniri Anû, Sahûri, and Snofrûi, and claimed that the antiquity of their titles did away with the more recent rights of their rivals.

The revolt of the Theban princes put an end to the IXth dynasty, and, although supported by the feudal powers of Central and Northern Egypt, and more especially by the lords of the Terebinth nome, who viewed the sudden prosperity of the Thebans with a very evil eye, the Xth dynasty did not succeed in bringing them back to their allegiance.² The family which held the fief of Siût when

¹ In the "Hall of Ancestors" the title of "Horus" is attributed to several Antûfs and Monthotpûs bearing the cartouche. This was probably the compiler's ingenious device for marking the subordinate position of these personages as compared with that of the Heracleopolitan Pharaohs, who alone among their contemporaries had a right to be placed on such official lists, even when those lists were compiled under the great Theban dynasties. The place in the XIth dynasty of princes bearing the title of "Horus" was first determined by E. de Rougé.

² The history of the house of Thebes was restored at the same time as that of the Heracleopolitan dynasties, by MASPERO, in the *Revue Critique*, 1889, vol. ii. p. 220. The difficulty arising from the number of the Theban kings according to Manetho, considered in connection with the forty-three years which made the total duration of the dynasty, has been solved by BARUCCHI, *Discorsi critici sopra la Cronologia Egizia*, pp. 131-134. These forty-three years represent the length of time that the Theban dynasty reigned alone, and which are ascribed to it in the Royal Canon; but the number of its kings includes, besides the recognized Pharaohs of the line, those princes who were contemporary with the Heracleopolitan rulers and are officially reckoned as forming the Xth dynasty.

the war broke out, had ruled there for three generations. Its first appearance on the scene of history coincided with the accession of Akhthoës, and its elevation was probably the reward of services rendered by its chief to the head of the

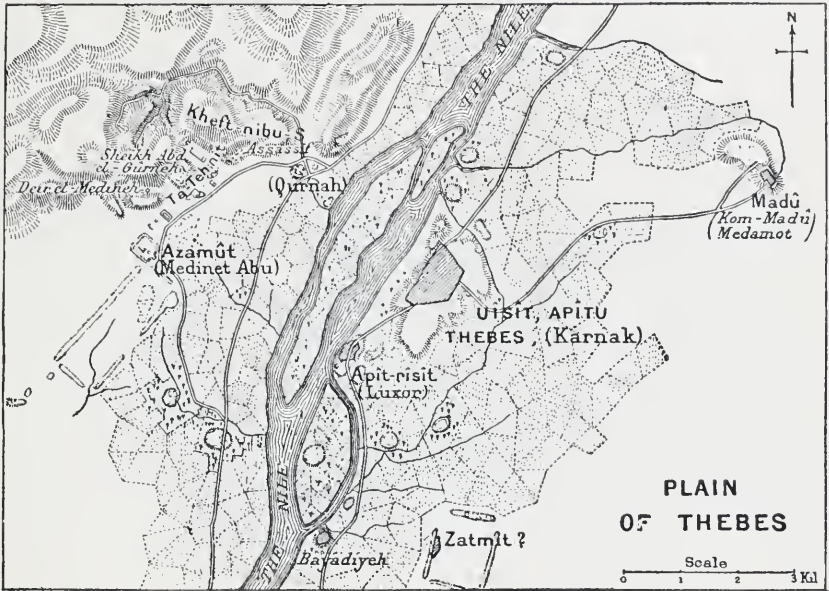

Heracleopolitan family.¹ From this time downwards, the title of “ruler”—*hiqû*—which the Pharaohs themselves

¹ By ascribing to the princes of Siût an average reign equal to that of the Pharaohs, and admitting with LEPSIUS that the IXth dynasty consisted of four or five kings, the accession of the first of these princes would practically coincide with the reign of Akhthoës. The name of Khiti, borne by two members of this little local dynasty, may have been given in memory of the Pharaoh Khiti Miribrî; there was also a second Khiti among the Heracleopolitan sovereigns, and one of the Khitis of Siût may have been his contemporary. The family claimed a long descent, and said of itself that it was “an ancient litter”; but the higher rank and power of “prince”—*hiqû*—it owed to Khiti I. [Miribrî?—ED.] or some other king of the Heracleopolitan line.

sometimes condescended to take, was hereditary in the family, who grew in favour from year to year. Khîti I., the fourth of this line of princes, was brought up in the palace of Heracleopolis, and had learned to swim with the royal children. On his return home he remained the personal friend of the king, and governed his domains wisely, clearing the canals, fostering agriculture, and lightening the taxes without neglecting the army. His heavy infantry,

recruited from among the flower of the people of the north, and his light infantry, drawn from the pick of the people of the south, were counted by thousands. He resisted the Theban pretensions with all his might, and his son Tefabi

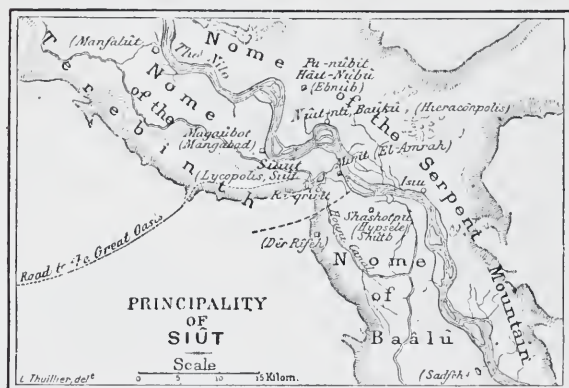

followed in his footsteps. "The first time," said he, "that my foot-soldiers fought against the nomes of the south which were gathered together from Elephantinê in the south to Gaû on the north, I conquered those nomes, I drove them towards the southern frontier, I overran the left bank of the Nile in all directions. When I came to a town I threw down its walls, I seized its chief, I imprisoned him at the port (landing-place) until he paid me ransom. As soon as I had finished with the left bank, and there were no longer found any who dared resist, I passed to the

right bank; like a swift hare I set full sail for another chief. . . . I sailed by the north wind as by the east, by the south as by the west, and him whose ship I boarded I vanquished utterly; he was cast into the water, his boats fled to shore, his soldiers were as bulls on whom falleth the lion; I compassed his city from end to end, I seized his goods, I cast them into the fire." Thanks to his energy and courage, he "extinguished the rebellion



THE HEAVY INFANTRY OF THE PRINCES OF SIÛT, ARMED WITH LANCE AND BUCKLER.¹

by the counsel and according to the tactics of the jackal *Ûapûaitû*, god of Siût." From that time "no district of the desert was safe from his terrors," and he "carried flame at his pleasure among the nomes of the south." Even while bringing desolation to his foes, he sought to repair the ills which the invasion had brought upon his own subjects. He administered such strict justice that

¹ Drawn by Boudier, from a photograph by Insinger, taken in 1882. The scene forms part of the decoration of one of the walls of the tomb of Kheti III.

evil-doers disappeared as though by magic. "When night came, he who slept on the roads blessed me, because he was as safe as in his own house; for the fear which was shed abroad by my soldiers protected him; and the cattle in the fields were as safe there as in the stable; the thief had become an abomination to the god, and he no longer oppressed the serf, so that the latter ceased to complain, and paid the exact dues of his land for love of me." In the time of Khîti II., the son of Tefabi, the Heracleopolitans were still masters of Northern Egypt, but their authority was even then menaced by the turbulence of their own vassals, and Heracleopolis itself drove out the Pharaoh Mirikarî, who was obliged to take refuge in Siût with that Kkîti whom he called his father. Khîti gathered together such an extensive fleet that it encumbered the Nile from Shashhotpû to Gebel-Abufodah, from one end of the principality of the Terebinth to the other. Vainly did the rebels unite with the Thebans; Khîti "sowed terror over the world, and himself alone chastised the nomes of the south." While he was descending the river to restore the king to his capital, "the sky grew serene, and the whole country rallied to him; the commanders of the south and the archons of Heracleopolis, their legs tremble beneath them when the royal uræus, ruler of the world, comes to suppress crime; the earth trembles, the South takes ship and flies, all men flee in dismay, the towns surrender, for fear takes hold on their members." Mirikarî's return was a triumphal progress: "when he came to Heracleopolis the people ran forth to meet him, rejoicing in their lord; women and

men together, old men as well as children. But fortune soon changed. Beaten again and again, the Thebans still returned to the attack; at length they triumphed, after a struggle of nearly two hundred years, and brought the two rival divisions of Egypt under their rule.

The few glimpses to be obtained of the early history of the first Theban dynasty give the impression of an energetic and intelligent race. Confined to the most thinly populated, that is, the least fertile part of the valley, and engaged on the north in a ceaseless warfare which exhausted their resources, they still found time for building both at Thebes and in the most distant parts of their dominions. If their power made but little progress southwards, at least it did not recede, and that part of Nubia lying between Aswân and the neighbourhood of Korosko remained in their possession. The tribes of the desert, the Amamiû, the Mâzaiû, and the Ûaûaiû often

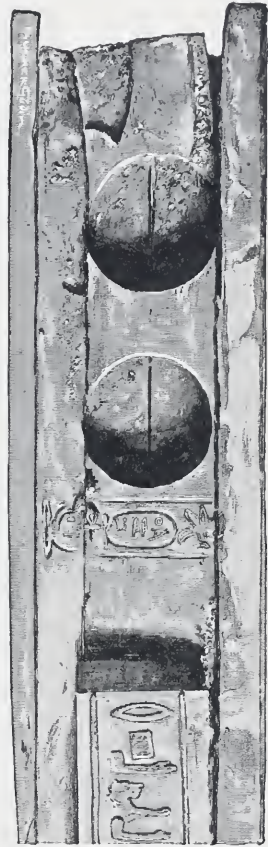

PALETTE INSCRIBED WITH
THE NAME OF MIRIKARÎ.¹

¹ Drawn by Faucher-Gudin, from the original, now in the Museum of the Louvre. The palette is of wood, and bears the name of a contemporary personage; the outlines of the hieroglyphs are inlaid with silver wire. It was probably found in the necropolis of Meîr, a little to the north of Siût. The sepulchral pyramid of the Pharaoh Mirikarî is mentioned on a coffin in the Berlin Museum.

disturbed the husbandmen by their sudden raids; yet, having pillaged a district, they did not take possession of it as conquerors, but hastily returned to their mountains. The Theban princes kept them in check by repeated counter-raids, and renewed the old treaties with them. The inhabitants of the Great Oasis in the west, and the migratory peoples of the Land of the Gods, recognized the Theban suzerainty on the traditional terms. As in the times of *Ûni*, the barbarians made up the complement



THE BRICK PYRAMID OF ANTÛFÁÁ, AT THEBES.¹

of the army with soldiers who were more inured to hardships and more accustomed to the use of arms than the ordinary fellahîn; and several obscure Pharaohs—such as *Monthotpû I.* and *Antûf III.*—owed their boasted victories over Libyans and Asiatics² to the energy of their

¹ Drawn by Faucher-Gudin, from a sketch by PRISSE D'AVENNES. This pyramid is now completely destroyed.

² The cartouches of *Antûfáá*, inscribed on the rocks of *Elephantinê*, are the record of a visit which this prince paid to *Syenê*, probably on his return from some raid; many similar inscriptions of Pharaohs of the XIIth dynasty were inscribed in analogous circumstances. *Nûbkhopirri Antûf* boasted of having worsted the *Amû* and the negroes. On one of the rocks of the island of *Konosso*, *Monthotpû Nibhotpâri* sculptured a scene of offerings in which

mercenaries. But the kings of the XIth dynasty were careful not to wander too far from the valley of the Nile. Egypt presented a sufficiently wide field for their activity, and they exerted themselves to the utmost to remedy the evils from which the country had suffered for hundreds of years. They repaired the forts, restored or enlarged the temples, and evidences of their building are found at Koptos, Gebelên, El-Kab, and Abydos. Thebes itself has been too often overthrown since that time for any traces of the work of the XIth dynasty kings in the temple of Amon to be distinguishable; but her necropolis is still full of their "eternal homes," stretching in lines across the plain, opposite Karnak, at Drah abû'l-Neggah, and on the northern slopes of the valley of Deir-el-Baharî. Some were excavated in the mountain-side, and presented a square façade of dressed stone, surmounted by a pointed roof in the shape of a pyramid. Others were true pyramids, sometimes having a pair of obelisks in front of them, as well as a temple. None of them attained to the dimensions of the Memphite tombs; for, with only its own resources at command, the kingdom of the south could not build monuments to compete with those whose construction had taxed the united efforts of all Egypt, but it used a crude black brick, made without grit or straw, where the Egyptians of the north had preferred more costly stone. These inexpensive pyramids were built on a rectangular base not more than six and a half feet high; and

the gods are represented as granting him victory over all peoples. Among the ruins of the temple which he built at Gebelên, is a scene in which he is presenting files of prisoners from different countries to the Theban gods,

the whole erection, which was simply faced with white-washed stucco, never exceeded thirty-three feet in height. The sepulchral chamber was generally in the centre; in shape it resembled an oven, its roof being "vaulted" by the overlapping of the courses. Often also it was constructed partly in the base, and partly in the foundations below the base, the empty space above it being intended merely to lighten the weight of the masonry. There was not always an external chapel attached to these tombs, but a stele placed on the substructure, or fixed in one of the outer faces, marked the spot to which offerings were to be brought for the dead; sometimes, however, there was the addition of a square vestibule in front of the tomb, and here, on prescribed days, the memorial ceremonies took place. The statues of the double were rude and clumsy, the coffins heavy and massive, and the figures with which they were decorated inelegant and out of proportion, while the stelæ are very rudely cut. From the time of the VIth dynasty the lords of the Saïd had been reduced to employing workmen from Memphis to adorn their monuments; but the rivalry between the Thebans and the Heracleopolitans, which set the two divisions of Egypt against each other in constant hostility, obliged the Antûfs to entrust the execution of their orders to the local schools of sculptors and painters. It is difficult to realize the degree of rudeness to which the unskilled workmen who made certain of the Akhmîm and Gebelên sarcophagi must have sunk; and even at Thebes itself, or at Abydos, the execution of both bas-reliefs and hieroglyphs shows minute carefulness rather than any

real skill or artistic feeling. Failing to attain to the beautiful, the Egyptians endeavoured to produce the sumptuous. Expeditions to the Wady Hammamât to fetch blocks of granite for sarcophagi become more and more frequent, and wells were sunk from point to point along the road leading from Koptos to the mountains. Sometimes these expeditions were made the occasion for pushing on as far as the port of Saû and embarking on the Red Sea. A hastily constructed boat cruised along by the shore, and gum, incense, gold, and the precious stones of the country were brought from the land of the Troglodytes. On the return of the convoy with its block of stone, and various packages of merchandise, there was no lack of scribes to recount the dangers of the campaign in exaggerated language, or to congratulate the reigning Pharaoh on having sown abroad the fame and terror of his name in the countries of the gods, and as far as the land of Pûanît.'

The final overthrow of the Heracleopolitan dynasty, and the union of the two kingdoms under the rule of the Theban house, are supposed to have been the work of that Monthotpû whose throne-name was Nibkhrôûrî; his, at any rate, was the name which the Egyptians of Ramesside times inscribed in the royal lists as that of the founder and most illustrious representative of the XIth dynasty. The monuments commemorate his victories over the Ûâuaiû and the barbarous inhabitants of Nubia. Even after he had conquered the Delta he still continued to reside in Thebes; there he built his pyramid, and there divine honours were paid him from the day after his

decease. A scene carved on the rocks north of Silsileh represents him as standing before his son Antûf; he is of gigantic stature, and one of his wives stands behind him. Three or four kings followed him in rapid succession; the least insignificant among them appearing to have been a

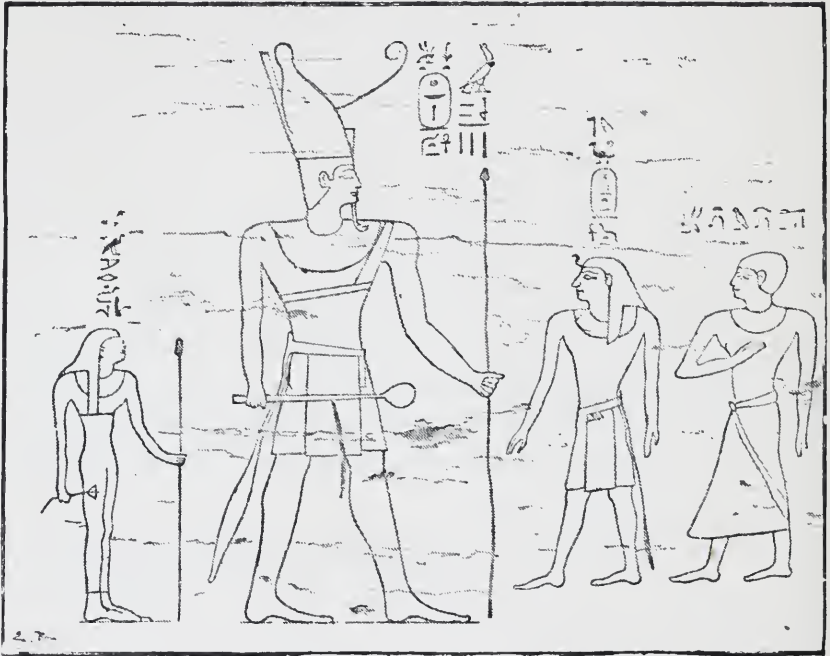

THE PHARAOH MONTHOTEP RECEIVING THE HOMAGE OF HIS SUCCESSOR—ANTUF
—IN THE SHAT ER-RIGÂLEH.¹

Monthotepû Nibtoûiri. Nothing but the prenomen—Sonkheri—is known of the last of these latter princes, who was also the only one of them ever entered on the official lists. In their hands the sovereignty remained unchanged from

¹ Drawn by Boudier, from a sketch by PETRIE, *Ten Years' Digging in Egypt*, p. 74, No. 2.

what it had been almost uninterruptedly since the end of the VIth dynasty. They solemnly proclaimed their supremacy, and their names were inscribed at the head of public documents; but their power scarcely extended beyond the limits of their family domain, and the feudal chiefs never concerned themselves about the sovereign except when he evinced the power or will to oppose them, allowing him the mere semblance of supremacy over the greater part of Europe. Such a state of affairs could only be reformed by revolution. Amenemhât I., the leader of the new dynasty, was of the Theban race; whether he had any claim to the throne, or by what means he had secured the stability of his rule, we do not know.¹ Whether he had usurped the crown or whether he had inherited it legitimately, he showed himself worthy of the rank to which fortune had raised him, and the nobility saw in him a new incarnation of that type of kingship long known to them by tradition only, namely, that of a Pharaoh convinced of his own divinity and determined to assert it. He inspected the valley from one end to another, principality by principality, nome by nome, "crushing crime, and arising like Tûmû himself; restoring that which he found in ruins, settling the bounds of the towns, and establishing for each its frontiers." The civil wars had disorganized everything; no one knew what ground

¹ Brugsch makes him out to be a descendant of Amenemhât, the prince of Thebes who lived under Monthopû Nibtûiri, and who went to bring the stone for that Pharaoh's sarcophagus from the Wady Hammamât. He had previously supposed him to be this prince himself. Either of these hypotheses becomes probable, according as Nibtûiri is supposed to have lived before or after Nibkhrôûri.

belonged to the different nomes, what taxes were due from them, nor how questions of irrigation could be equitably decided. Amenemhât set up again the boundary stelæ, and restored its dependencies to each nome: "He divided the waters among them according to that which was in the cadastral surveys of former times." Hostile nobles, or those whose allegiance was doubtful, lost the whole or part of their fiefs; those who had welcomed the new order of things received accessions of territory as the reward of their zeal and devotion. Depositions and substitutions of princes had begun already in the time of the XIth dynasty. Antûf V., for instance, finding the lord of Koptos too lukewarm, had had him removed and promptly replaced. The fief of Siût accrued to a branch of the family which was less warlike, and above all less devoted to the old dynasty than that of Khîti had been. Part of the nome of the Gazelle was added to the dominions of Nûhri, prince of the Hare nome; the eastern part of the same nome, with Monait-Khûfui as capital, was granted to his father-in-law, Khnûmhotpû I. Expeditions against the Ūaûaiû, the Mâzaiû, and the nomads of Libya and Arabia delivered the fellahîn from their ruinous raids and ensured to the Egyptians safety from foreign attack. Amenemhât had, moreover, the wit to recognize that Thebes was not the most suitable place of residence for the lord of all Egypt; it lay too far to the south, was thinly populated, ill-built, without monuments, without *prestige*, and almost without history. He gave it into the hands of one of his relations to govern in his name, and proceeded to establish himself in the heart of the country,

in imitation of the glorious Pharaohs from whom he claimed to be descended. But the ancient royal cities of Kheops and his children had ceased to exist; Memphis, like Thebes, was now a provincial town, and its associations were with the VIth and VIIIth dynasties only. Amenemhât took up his abode a little to the south of Dahshûr, in the palace of Titoûi, which he enlarged and made the seat of his government. Conscious of being in the hands of a strong ruler, Egypt breathed freely after centuries of distress, and her sovereign might in all sincerity congratulate himself on having restored peace to his country. "I caused the mourner to mourn no longer, and his lamentation was no longer heard,—perpetual fighting was no longer witnessed,—while before my coming they fought together as bulls unmindful of yesterday,—and no man's welfare was assured, whether he was ignorant or learned." —"I tilled the land as far as Elephantinê,—I spread joy throughout the country, unto the marshes of the Delta.—At my prayer the Nile granted the inundation to the fields:—no man was an hungered under me, no man was athirst under me,—for everywhere men acted according to my commands, and all that I said was a fresh cause of love."

In the court of Amenemhât, as about all Oriental sovereigns, there were doubtless men whose vanity or interests suffered by this revival of the royal authority; men who had found it to their profit to intervene between Pharaoh and his subjects, and who were thwarted in their intrigues or exactions by the presence of a prince determined on keeping the government in his own hands.

These men devised plots against the new king, and he escaped with difficulty from their conspiracies. "It was after the evening meal, as night came on,—I gave myself up to pleasure for a time,—then I lay down upon the soft coverlets in my palace, I abandoned myself to repose,—and my heart began to be overtaken by slumber; when, lo! they gathered together in arms to revolt against me,—and I became weak as a serpent of the field.—Then I aroused myself to fight with my own hands,—and I found that I had but to strike the unresisting.—When I took a foe, weapon in hand, I made the wretch to turn and flee;—strength forsook him, even in the night; there were none who contended, and nothing vexatious was effected against me." The conspirators were disconcerted by the promptness with which Amenemhât had attacked them, and apparently the rebellion was suppressed on the same night in which it broke out. But the king was growing old, his son *Ûsirtasen* was very young, and the nobles were bestirring themselves in prospect of a succession which they supposed to be at hand. The best means of putting a stop to their evil devices and of ensuring the future of the dynasty was for the king to appoint the heir-presumptive, and at once associate him with himself in the exercise of his sovereignty. In the XXth year of his reign, Amenemhât solemnly conferred the titles and prerogatives of royalty upon his son *Ûsirtasen*: "I raised thee from the rank of a subject,—I granted thee the free use of thy arm that thou mightest be feared.—As for me, I apparelled myself in the fine stuffs of my palace until I appeared to the eye as the flowers of my garden,—and I perfumed

myself with essences as freely as I pour forth the water from my cisterns." Ûsirtasen naturally assumed the active duties of royalty as his share. "He is a hero who wrought with the sword, a mighty man of valour without peer: he beholds the barbarians, he rushes forward and falls upon their predatory hordes. He is the hurler of javelins who makes feeble the hands of the foe; those whom he strikes never more lift the lance. Terrible is he, shattering skulls with the blows of his war-mace, and none resisted him in his time. He is a swift runner who smites the fugitive with the sword, but none who run after him can overtake him. He is a heart alert for battle in his time. He is a lion who strikes with his claws, nor ever lets go his weapon. He is a heart girded in armour at the sight of the hosts, and who leaves nothing standing behind him. He is a valiant man rushing forward when he beholds the fight. He is a soldier rejoicing to fall upon the barbarians: he seizes his buckler, he leaps forward and kills without a second blow. None may escape his arrow; before he bends his bow the barbarians flee from his arms like dogs, for the great goddess has charged him to fight against all who know not her name, and whom he strikes he spares not; he leaves nothing alive." The old Pharaoh "remained in the palace," waiting until his son returned to announce the success of his enterprises, and contributing by his counsel to the prosperity of their common empire. Such was the reputation for wisdom which he thus acquired, that a writer who was almost his contemporary composed a treatise in his name, and in it the king was supposed to address

posthumous instructions to his son on the art of governing. He appeared to his son in a dream, and thus admonished him: "Hearken unto my words!—Thou art king over the two worlds, prince over the three regions. Act still better than did thy predecessors.—Let there be harmony between thy subjects and thee,—lest they give themselves up to fear; keep not thyself apart in the midst of them; make not thy brother solely from the rich and noble, fill not thy heart with them alone; yet neither do thou admit to thy intimacy chance-comers whose place is unknown." The king confirmed his counsels by examples taken from his own life, and from these we have learned some facts in his history. The little work was widely disseminated and soon became a classic; in the time of the XIXth dynasty it was still copied in schools and studied by young scribes as an exercise in style. *Ûsirtasen's* share in the sovereignty had so accustomed the Egyptians to consider this prince as the king *de facto*, that they had gradually come to write his name alone upon the monuments. When Amenemhât died, after a reign of thirty years, *Ûsirtasen* was engaged in a war against the Libyans. Dreading an outbreak of popular feeling, or perhaps an attempted usurpation by one of the princes of the blood, the high officers of the crown kept Amenemhât's death secret, and despatched a messenger to the camp to recall the young king. He left his tent by night, unknown to the troops, returned to the capital before anything had transpired among the people, and thus the transition from the founder to his immediate successor—always a delicate crisis for a new dynasty—seemed to come about quite

naturally. The precedent of co-regnancy having been established, it was scrupulously followed by most of the succeeding sovereigns. In the XLIInd year of his sovereignty, and after having reigned alone for thirty-two years, Ûsirtasen I. shared his throne with Amenemhât II.; and thirty-two years later Amenemhât II. acted in a similar way with regard to Ûsirtasen II. Amenemhât III. and Amenemhât IV. were long co-regnant. The



AN ASIATIC CHIEF IS PRESENTED TO KHÛMHOÏPÛ BY NOFIRHOÏPÛ, AND BY KHÛCI, THE SUPERINTENDENT OF THE HUNTMEN.¹

only princes of this house in whose cases any evidence of co-regnancy is lacking are Ûsirtasen III., and the queen Sovknofriûri, with whom the dynasty died out.

It lasted two hundred and thirteen years, one month, and twenty-seven days,² and its history can be ascertained

¹ Drawn by Faucher-Gudin, from a chromolithograph in LEPsius, *Denkm.*, ii. 133.

² This is its total duration, as given in the Turin papyrus. Several Egyptologists have thought that Manetho had, in his estimate, counted the

with greater certainty and completeness than that of any other dynasty which ruled over Egypt. We are doubtless far from having any adequate idea of its great achievements, for the biographies of its eight sovereigns, and the details of their interminable wars are very imperfectly known to us. The development of its foreign and domestic policy we can, however, follow without a break. Asia had as little attraction for these kings as for their Memphite



SOME OF THE BAND OF ASIATICS, WITH THEIR BEASTS, BROUGHT FROM
KHNÛMHOPTÛ.

predecessors; they seem to have always had a certain dread of its warlike races, and to have merely contented themselves with repelling their attacks. Amenemhât I.

years of each sovereign as consecutive, and have hence proposed to conclude that the dynasty only lasted 168 years (BRUGSCH), or 160 (LIEBLEIN), or 194 (ED. MEYER). It is simpler to admit that the compiler of the papyrus was not in error; we do not know the length of the reigns of Ûsirtasen II., Ûsirtasen III., and Amenemhât III., and their unknown years may be considered as completing the tale of the two hundred and thirteen years.

had completed the line of fortresses across the isthmus, and these were carefully maintained by his successors. The Pharaohs were not ambitious of holding direct sway over the tribes of the desert, and scrupulously avoided interfering with their affairs as long as the "Lords of the Sands" agreed to respect the Egyptian frontier. Commercial relations were none the less frequent and certain on this account. Dwellers by the streams of the Delta were accustomed to see the continuous arrival in their



THE WOMEN PASSING BY IN PROCESSION, IN CHARGE OF A WARRIOR AND OF A MAN PLAYING UPON THE LYRE.

towns of isolated individuals or of whole bands driven from their homes by want or revolution, and begging for refuge under the shadow of Pharaoh's throne, and of caravans offering the rarest products of the north and of the east for sale. A celebrated scene in one of the tombs of Beni-Hasan illustrates what usually took place. We do not know what drove the thirty-seven Asiatics, men, women, and children, to cross the Red Sea and the

Arabian desert and hills in the VIth year of Ûsirtasen II. ;¹ they had, however, suddenly appeared in the Gazelle nome, and were there received by Khîti, the superintendent of the huntsmen, who, as his duty was, brought them before the prince Khnûmhotpû. The foreigners presented the prince with green eye-paint, antimony powder, and two live ibexes, to conciliate his favour ; while he, to preserve the memory of their visit, had them represented in painting upon the walls of his tomb. The Asiatics carry bows and arrows, javelins, axes, and clubs, like the Egyptians, and wear long garments or close-fitting loin-cloths girded on the thigh. One of them plays, as he goes, on an instrument whose appearance recalls that of the old Greek lyre. The shape of their arms, the magnificence and good taste of the fringed and patterned stuffs with which they are clothed, the elegance of most of the objects which they have brought with them, testify to a high standard of civilisation, equal at least to that of Egypt. Asia had for some time provided the Pharaohs with slaves, certain perfumes, cedar wood and cedar essences, enamelled vases, precious stones, lapis-lazuli, and the dyed and embroidered woollen fabrics of which Chaldaea kept the monopoly until the time of the Romans. Merchants of the Delta braved the perils of wild beasts and of robbers lurking in every valley, while transporting beyond the isthmus products of Egyptian manufacture, such as fine linens, chased or

¹ This bas-relief was first noticed and described by Champollion, who took the immigrants for Greeks of the archaic period. Others have wished to consider it as representing Abraham, the sons of Jacob, or at least a band of Jews entering into Egypt, and on the strength of this hypothesis it has often been reproduced.

cloisonné jewellery, glazed pottery, and glass paste or metal amulets. Adventurous spirits who found life dull on the banks of the Nile, men who had committed crimes, or who believed themselves suspected by their lords on political grounds, conspirators, deserters, and exiles were well received by the Asiatic tribes, and sometimes gained the favour of the sheikhs. In the time of the XIIth dynasty, Southern Syria, the country of the "Lords of the Sands," and the kingdom of Kadûma were full of Egyptians whose eventful careers supplied the scribes and story-tellers with the themes of many romances.

Sinûhît, the hero of one of these stories, was a son of Amenembât I., and had the misfortune involuntarily to overhear a state secret. He happened to be near the royal tent when news of his father's sudden death was brought to Ûsirtasen. Fearing summary execution, he fled across the Delta north of Memphis, avoided the frontier-posts, and struck into the desert. "I pursued my way by night; at dawn I had reached Pûteni, and set out for the lake of Kimoîrî. Then thirst fell upon me, and the death-rattle was in my throat, my throat cleaved together, and I said, 'It is the taste of death!' when suddenly I lifted up my heart and gathered my strength together: I heard the lowing of the herds. I perceived some Asiatics; their chief, who had been in Egypt, knew me; he gave me water, and caused milk to be boiled for me, and I went with him and joined his tribe." But still Sinûhît did not feel himself in safety, and fled into Kadûma, to a prince who had provided an asylum for other Egyptian exiles, and where he "could hear men speak the language of

Egypt." Here he soon gained honours and fortune. "The chief preferred me before his children, giving me his eldest daughter in marriage, and he granted me that I should choose for myself the best of his land near the frontier of a neighbouring country. It is an excellent land, Aïa is its name. Figs are there and grapes; wine is more plentiful than water; honey abounds in it; numerous are its olives and all the produce of its trees; there are corn and flour without end, and cattle of all kinds. Great, indeed, was that which was bestowed upon me when the prince came to invest me, installing me as prince of a tribe in the best of his land. I had daily rations of bread and wine, day by day; cooked meat and roasted fowl, besides the mountain game which I took, or which was placed before me in addition to that which was brought me by my hunting dogs. Much butter was made for me, and milk prepared in every kind of way. There I passed many years, and the children which were born to me became strong men, each ruling his own tribe. When a messenger was going to the interior or returning from it, he turned aside from his way to come to me, for I did kindness to all: I gave water to the thirsty, I set again upon his way the traveller who had been stopped on it, I chastised the brigand. The Pitaîtîû, who went on distant campaigns to fight and repel the princes of foreign lands, I commanded them and they marched forth; for the prince of Tonû made me the general of his soldiers for long years. When I went forth to war, all countries towards which I set out trembled in their pastures by their wells. I seized their cattle, I took away their vassals

and carried off their slaves, I slew the inhabitants, the land was at the mercy of my sword, of my bow, of my marches, of my well-conceived plans glorious to the heart of my prince. Thus, when he knew my valour, he loved me, making me chief among his children when he saw the strength of my arms.

“A valiant man of Tonû came to defy me in my tent; he was a hero beside whom there was none other, for he had overthrown all his adversaries. He said: ‘Let Sinûhît fight with me, for he has not yet conquered me!’ and he thought to seize my cattle and therewith to enrich his tribe. The prince talked of the matter with me. I said: ‘I know him not. Verily, I am not his brother. I keep myself far from his dwelling; have I ever opened his door, or crossed his enclosures? Doubtless he is some jealous fellow envious at seeing me, and who believes himself fated to rob me of my cats, my goats, my kine, and to fall on my bulls, my rams, and my oxen, to take them. . . . If he has indeed the courage to fight, let him declare the intention of his heart! Shall the god forget him whom he has heretofore favoured? This man who has challenged me to fight is as one of those who lie upon the funeral couch.’ I bent my bow, I took out my arrows, I loosened my poignard, I furbished my arms. At dawn all the land of Tonû ran forth; its tribes were gathered together, and all the foreign lands which were its dependencies, for they were impatient to see this duel. Each heart was on live coals because of me; men and women cried ‘Ah!’ for every heart was disquieted for my sake, and they said: ‘Is there, indeed, any valiant

man who will stand up against him? Lo! the enemy has buckler, battle-axe, and an armful of javelins.' When he had come forth and I appeared, I turned aside his shafts from me. When not one of them touched me, he fell upon me, and then I drew my bow against him. When my arrow pierced his neck, he cried out and fell to the earth upon his nose; I snatched his lance from him, I shouted my cry of victory upon his back. While the country people rejoiced, I made his vassals whom he had oppressed to give thanks to Montû. This prince, Ammiânsi, bestowed upon me all the possessions of the vanquished, and I took away his goods, I carried off his cattle. All that he had desired to do unto me that did I unto him; I took possession of all that was in his tent, I despoiled his dwelling; therewith was the abundance of my treasure and the number of my cattle increased." In later times, in Arab romances such as that of Antar or that of Abû-Zeit, we find the incidents and customs described in this Egyptian tale; there we have the exile arriving at the court of a great sheikh whose daughter he ultimately marries, the challenge, the fight, and the raids of one people against another. Even in our own day things go on in much the same way. Seen from afar, these adventures have an air of poetry and of grandeur which fascinates the reader, and in imagination transports him into a world more heroic and more noble than our own. He who cares to preserve this impression would do well not to look too closely at the men and manners of the desert. Certainly the hero is brave, but he is still more brutal and treacherous; fighting is one object of his

existence, but pillage is a far more important one. How, indeed, should it be otherwise? the soil is poor, life hard and precarious, and from remotest antiquity the conditions of that life have remained unchanged; apart from firearms and Islam, the Bedouin of to-day are the same as the Bedouin of the days of Sinûhit.

There are no known documents from which we can derive any certain information as to what became of the mining colonies in Sinai after the reign of Papi II. Unless entirely abandoned, they must have lingered on in comparative idleness; for the last of the Memphites, the Heracleopolitans, and the early Thebans were compelled to neglect them, nor was their active life resumed until the accession of the XIIth dynasty. The veins in the Wady Maghara were much exhausted, but a series of fortunate explorations revealed the existence of untouched deposits in the Sarbût-el-Khâdim, north of the original workings. From the time of Amenemhât II. these new veins were worked, and absorbed attention during several generations. Expeditions to the mines were sent out every three or four years, sometimes annually, under the command of such high functionaries as "Acquaintances of the King," "Chief Lectors," and Captains of the Archers. As each mine was rapidly worked out, the delegates of the Pharaohs were obliged to find new veins in order to meet industrial demands. The task was often arduous, and the commissioners generally took care to inform posterity very fully as to the anxieties which they had felt, the pains which they had taken, and the quantities of turquoise or of oxide of copper which they

had brought into Egypt. Thus the Captain Haroëris tells us that, on arriving at Sarbût in the month Phamenoth of an unknown year of Amenemhât III., he made a bad beginning in his work of exploration. Wearied of fruitless efforts, the workmen were quite ready to desert him if he had not put a good face on the business and stoutly promised them the support of the local Hâthor.

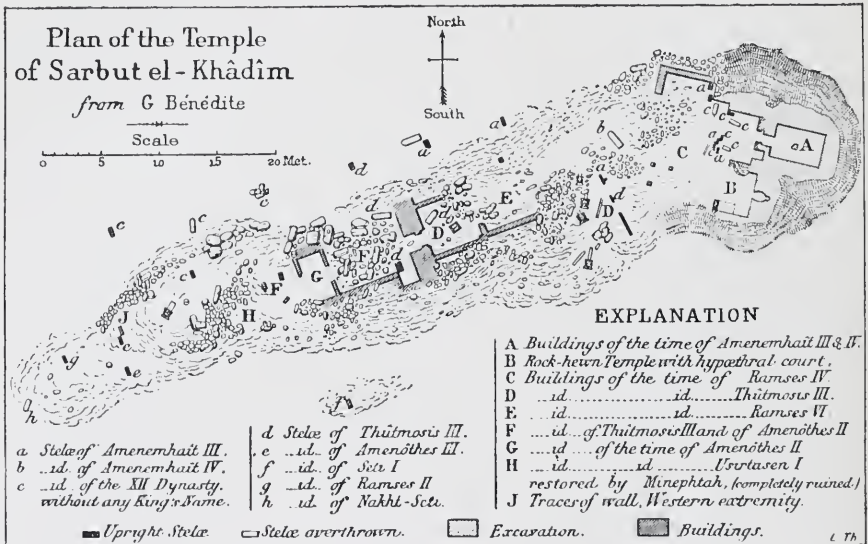

And, as a matter of fact, fortune did change. When he began to despair, "the desert burned like summer, the mountain was on fire, and the vein exhausted; one morning the overseer who was there questioned the miners, the skilled workers who were used to the mine, and they said: 'There is turquoise for eternity in the mountain.' At that very moment the vein appeared." And, indeed, the

wealth of the deposit which he found so completely indemnified Haroëris for his first disappointments, that in the month Pachons, three months after the opening of these workings, he had finished his task and prepared to leave the country, carrying his spoils with him. From time to time Pharaoh sent convoys of cattle and provisions—corn, sixteen oxen, thirty geese, fresh vegetables, live



THE RUINS OF THE TEMPLE OF HÂTHOR AT SARBÛT-EL-KHÂDÎM.¹

poultry—to his vassals at the mines. The mining population increased so fast that two chapels were built, dedicated to Hâthor, and served by volunteer priests. One of these chapels, presumably the oldest, consists of a single rock-cut chamber, upheld by one large square pillar, walls and pillar having been covered with finely sculptured

¹ Drawn by Boudier, from a photograph in the *Ordnance Survey, Photographs*, vol. iii. pl. 8.

scenes and inscriptions which are now almost effaced. The second chapel included a beautifully proportioned rectangular court, once entered by a portico supported on pillars with Hathor-head capitals, and beyond the court a narrow building divided into many small irregular chambers. The edifice was altered and rebuilt, and half destroyed; it is now nothing but a confused heap of ruins, of which the original plan cannot be traced. Votive stelæ of all shapes and sizes, in granite, sandstone, or limestone, were erected here and there at random in the two chambers and in the courts between the columns, and flush with the walls. Some are still *in situ*, others lie scattered in the midst of the ruins. Towards the middle of the reign of Amenemhât III., the industrial demand for turquoise and for copper ore became so great that the mines of Sarbût-el-Khâdîm could no longer meet it, and those in the Wady Maghara were re-opened. The workings of both sets of mines were carried on with unabated vigour under Amenemhât IV., and were still in full activity when the XIIIth dynasty succeeded the XIIth on the Egyptian throne. Tranquillity prevailed in the recesses of the mountains of Sinai as well as in the valley of the Nile, and a small garrison sufficed to keep watch over the Bedouin of the neighbourhood. Sometimes the latter ventured to attack the miners, and then fled in haste, carrying off their meagre booty; but they were vigorously pursued under the command of one of the officers on the spot, and generally caught and compelled to disgorge their plunder before they had reached the shelter of their "douars." The old Memphite kings

prided themselves on these armed pursuits as though they were real victories, and had them recorded in triumphal bas-reliefs; but under the XIIth dynasty they were treated as unimportant frontier incidents, almost beneath the notice of the Pharaoh, and the glory of them—such as it was—he left to his captains then in command of those districts.

Egypt had always kept up extensive commercial relations with certain northern countries lying beyond the Mediterranean. The reputation for wealth enjoyed by the Delta sometimes attracted bands of the Haiû-nîbû to come prowling in piratical excursions along its shores; but their expeditions seldom turned out successfully, and even if the adventurers escaped summary execution, they generally ended their days as slaves in the Fayûm, or in some village of the Saïd. At first their descendants preserved the customs, religion, manners, and industries of their distant home, and went on making rough pottery for daily use, which was decorated in a style recalling that of vases found in the most ancient tombs of the Ægean archipelago; but they were gradually assimilated to their surroundings, and their grandchildren became fellahîn like the rest, brought up from infancy in the customs and language of Egypt.

The relations with the tribes of the Libyan desert, the Tihûnû and the Timihû, were almost invariably peaceful; although occasional raids of one of their bands into Egyptian territory would provoke counter raids into the valleys in which they took refuge with their flocks and herds. Thus, in addition to the captive Haiû-nîbû,

another heterogeneous element, soon to be lost in the mass of the Egyptian population, was supplied by detach-

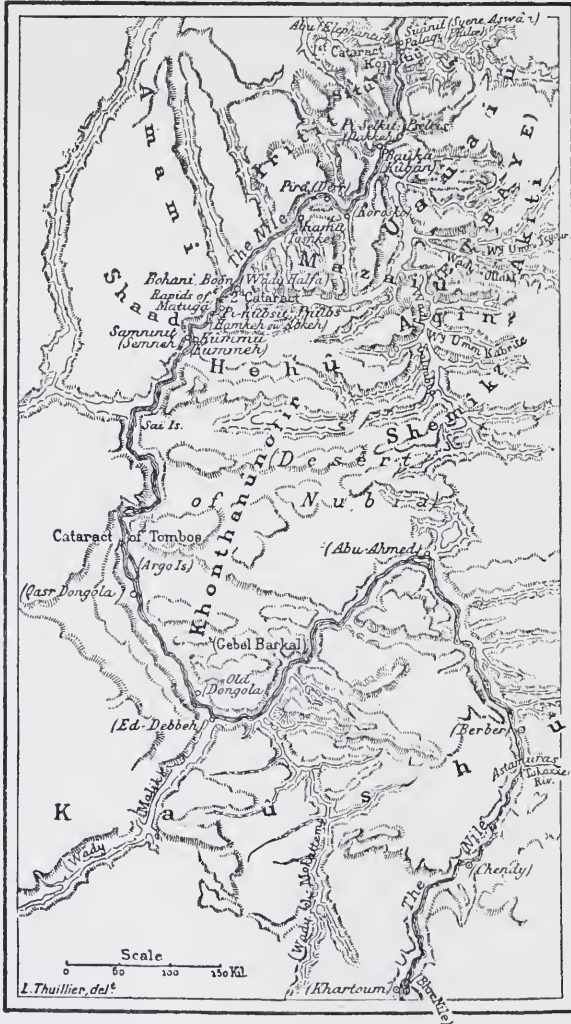

ments of Berber women and children. The relations of Egypt with her northern neighbours during the two

hundred years of the XIIth dynasty were chiefly commercial, but occasionally this peaceful intercourse was broken by sudden incursions or piratical expeditions which called for active measures of repression, and were the occasion of certain romantic episodes. The foreign policy of the Pharaohs in this connexion was to remain strictly on the defensive. Ethiopia attracted all their attention, and demanded all their strength. The same instinct which had impelled their predecessors to pass successively beyond Gebel-Silsileh and Elephantinê now drove the XIIth dynasty beyond the second cataract, and even further. The nature of the valley compelled them to this course. From the Tacazze, or rather from the confluence of the two Niles down to the sea, the whole valley forms as it were a Greater Egypt; for although separated by the cataracts into different divisions, it is everywhere subject to the same physical conditions. In the course of centuries it has more than once been forcibly dismembered by the chances of war, but its various parts have always tended to reunite, and have coalesced at the first opportunity. The Amami, the Iritît, and the Sitiû, all those nations which wandered west of the river, and whom the Pharaohs of the VIth and subsequently of the XIth dynasty either enlisted into their service or else conquered, do not seem to have given much trouble to the successors of Amenemhât I. The Ūâûaiû and the Mâzaiû were more turbulent, and it was necessary to subdue them in order to assure the tranquillity of the colonists scattered along the banks of the river from Philæ to Korosko. They were worsted by Amenemhât I. in several encounters.

Ûsirtasen I. made repeated campaigns against them, the earlier ones being undertaken in his father's lifetime. Afterwards he pressed on, and straightway "raised his frontiers" at the rapids of Wady Halfa; ³ and the country was henceforth the undisputed property of his successors. It was divided into nomes like Egypt itself; the Egyptian language succeeded in driving out the native dialects, and the local deities, including Didûn, the principal god, were associated or assimilated with the gods of Egypt. Khnûmû was the favourite deity of the northern nomes, doubtless because the first colonists were natives of Elephantinê, and subjects of its princes. In the southern nomes, which had been annexed under the Theban kings and were peopled with Theban immigrants, the worship of Khnûmû was carried on side by side with the worship of Amon, or Amon-Râ, god of Thebes. In accordance with local affinities, now no longer intelligible, the other gods also were assigned smaller areas in the new territory—Thot at Pselcis and Pnûbsît, where a gigantic nabk tree was worshipped, Râ near Derr, and Horus at Miama and Baûka. The Pharaohs who had civilized the country here received divine honours while still alive. Ûsirtasen III. was placed in triads along with Didûn, Amon, and Khnûmû; temples were raised to him at Semneh, Shotaûi, and Doshkeh; and the anniversary of a decisive victory which he had gained over the barbarians was still celebrated on the 21st of Pachons, a thousand years afterwards, under Thutmosis III. The feudal system spread over the land lying between the two cataracts, where hereditary barons held their courts, trained their

armies, built their castles, and excavated their superbly decorated tombs in the mountain-sides. The only difference between Nubian Egypt and Egypt proper lay in the greater heat and smaller wealth of the former, where the narrower, less fertile, and less well-watered land supported a smaller population and yielded less abundant revenues.

The Pharaoh kept the charge of the more important strategical points in his own hands. Strongholds placed at bends of the river and at the mouths of ravines leading into the desert, secured freedom of navigation, and kept off the pillaging nomads. The fortress of Derr [Kubbân?—Ed.], which was often rebuilt, dates in part at least from the early days of the conquest of Nubia. Its rectangular boundary—a dry brick wall—is only broken by easily filled up gaps, and with some repairs it would still resist an Ababdeh attack.¹ The most considerable Nubian works of the XIIth dynasty were in the three places from which the country can even now be most effectively commanded, namely, at the two cataracts, and in the districts extending from Derr to Dakkeh. Elephantinê already possessed an entrenched camp which commanded the rapids and the land route from Syene to Philæ. Ûsirtasen III. restored its great wall; he also cleared and widened the passage to Sehêl, as did Papi I. to such good effect that easy and rapid communication between Thebes and the new towns was at all times

¹ The most ancient bricks in the fortifications of Derr, easily distinguishable from those belonging to the later restorations, are identical in shape and size with those of the walls at Syene and El-Kab; and the wall at El-Kab was certainly built not later than the XIIth dynasty.

practicable. Some little distance from Philæ he established a station for boats, and an emporium which he called Hirû Khâkerî—"the Ways of Khâkerî"—after his own throne name—Khâkerî.¹ Its exact site is unknown, but it appears to have completed on the south side the system of walls and redoubts which protected the cataract provinces against either surprise or regular attacks of the barbarians. Although of no appreciable use for the purposes of general security, the fortifications of Middle Nubia were of great importance in the eyes of the Pharaohs. They commanded the desert roads leading to the Red Sea, and to Berber and Gebel Barkel on the Upper Nile. The most important fort occupied the site of the present village of Kubân, opposite Dakkeh, and commanded the entrance to the Wady Olaki, which leads to the richest gold deposits known to Ancient Egypt. The valleys which furrow the mountains of Etbaï, the Wady Shauanîb, the Waddy Umm Teyur, Gebel Iswud, Gebel Umm Kabriteh, all have gold deposits of their own. The gold is found in nuggets and in pockets in white quartz, mixed with iron oxides and titanium, for which the ancients had no use. The method of mining practised from immemorial antiquity by the Ûaûaiû of the neighbourhood was of the simplest, and traces of the workings may be

¹ The widening of the passage was effected in the VIIIth year of his reign, the same year in which he established the Egyptian frontier at Semneh. The other constructions are mentioned, but not very clearly, in a stele of the same year which came from Elephantinè, and is now in the British Museum. The votive tablet, engraved in honour of Anûkît at Sehêl, in which the king boasts of having made for the goddess "the excellent channel [called] 'the Ways of Khâkeûri,'" probably refers to this widening and deepening of the passage in the VIIIth year.

seen all over the sides of the ravines. Tunnels followed the direction of the lodes to a depth of fifty-five to sixty-five yards; the masses of quartz procured from them were broken up in granite mortars, pounded small and afterwards reduced to a powder in querns, similar to those used for crushing grain; the residue was sifted on stone tables, and the finely ground parts afterwards washed in bowls of sycamore wood, until the gold dust had settled to the bottom.¹ This was the Nubian gold which was brought into Egypt by nomad tribes, and for which the Egyptians themselves, from the time of the XIIth dynasty onwards, went to seek in the land which produced it. They made no attempt to establish permanent colonies for working the mines, as at Sinai; but a detachment of troops was despatched nearly every year to the spot to receive the amount of precious metal collected since their previous visit. The king Ūsirtasen would send at one time the prince of the nome of the Gazelle on such an expedition, with a contingent of four hundred men belonging to his fief; at another time, it would be the faithful Sihâthor who would triumphantly scour the country, obliging young and old to work with redoubled efforts for his master Amenemhât II. On his return the envoy would boast of having brought back more gold than any of his predecessors,

¹ The gold-mines and the method of working them under the Ptolemies have been described by Agatharchides; the processes employed were very ancient, and had hardly changed since the time of the first Pharaohs, as is shown by a comparison of the mining tools found in these districts with those which have been collected at Sinai, in the turquoise-mines of the Ancient Empire.

and of having crossed the desert without losing either a soldier or a baggage animal, not even a donkey. Sometimes a son of the reigning Pharaoh, even the heir-presumptive, would condescend to accompany the caravan. Amenemhât III. repaired or rebuilt the fortress of Kubbân, the starting-place of the little army, and the spot to which it returned. It is a square enclosure measuring 328 feet on



ONE OF THE FAÇADES OF THE FORTRESS OF KUBBÂN.¹

each side; the ramparts of crude brick are sloped slightly inwards, and are strengthened at intervals by bastions projecting from the external face of the wall. The river protected one side; the other three were defended by ditches communicating with the Nile. There were four entrances, one in the centre of each façade: that on the east, which faced the desert, and was exposed to the severest attacks, was flanked by a tower.

¹ Drawn by Boudier, from a photograph by Insinger, taken in 1881.

The cataract of Wady Halfa offered a natural barrier to invasion from the south. Even without fortification, the chain of granite rocks which crosses the valley at this spot would have been a sufficient obstacle to prevent any fleet which might attempt the passage from gaining access to

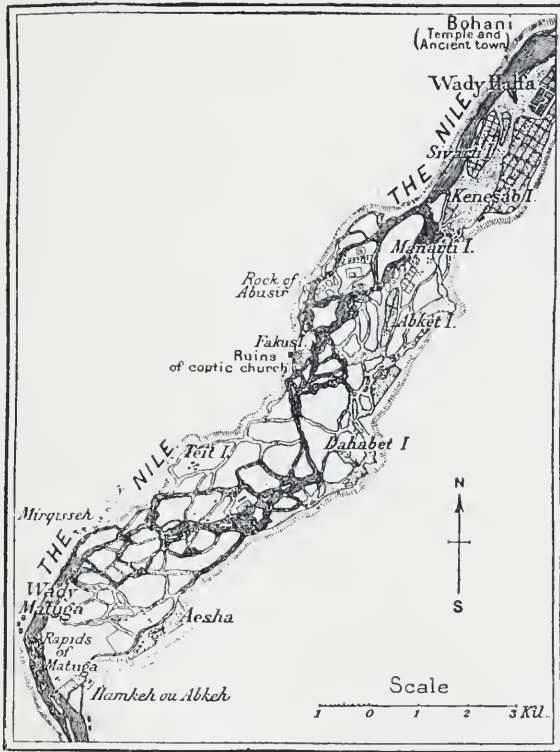

L. Thuillier. del^t

THE SECOND CATARACT BETWEEN HAMKEH AND WADY HALFA.

northern Nubia. The Nile here has not the wild and imposing aspect which it assumes lower down, between Aswân and Philæ. It is bordered by low and receding hills, devoid of any definite outline. Masses of bare black rock, here and there covered by scanty herbage, block the

course of the river in some places in such profusion, that its entire bed seems to be taken up by them. For a distance of seventeen miles the main body of water is broken up into an infinitude of small channels in its width of two miles; several of the streams thus formed present, apparently, a tempting course to the navigator, so calm and safe do they appear, but they conceal ledges of hidden reefs, and are unexpectedly forced into narrow passages obstructed by granite boulders. The strongest built and best piloted boat must be dashed to pieces in such circumstances, and no effort or skilfulness on the part of the crew would save the vessel should the owner venture to attempt the descent. The only channel at all available for transit runs from the village of Aesha on the Arabian side, winds capriciously from one bank to another, and emerges into calm water a little above Nakhiet Wady Halfa. During certain days in August and September the natives trust themselves to this stream, but only with boats lightly laden; even then their escape is problematical, for they are in hourly danger of foundering. As soon as the inundation begins to fall, the passage becomes more difficult: by the middle of October it is given up, and communication by water between Egypt and the countries above Wady Halfa is suspended until the return of the inundation. By degrees, as the level of the water becomes lower, remains of wrecks jammed between the rocks, or embedded in sandbanks, emerge into view, as if to warn sailors and discourage them from an undertaking so fraught with perils. *Ûsirtasen I.* realized the importance of the position, and fortified its approaches.

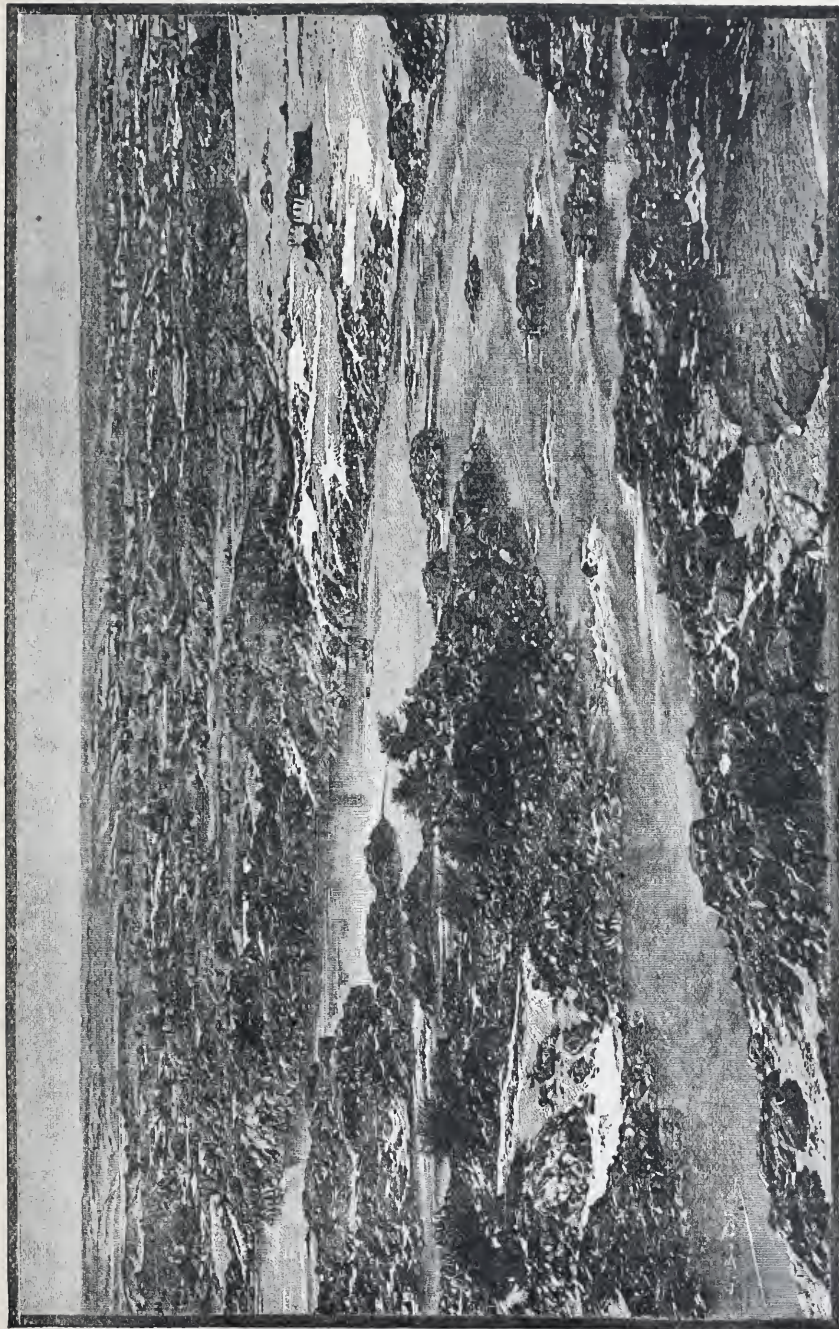

THE SECOND CATARACT AT LOW NILE, SEEN FROM ABUSIR.

Drawn by Boudier, from a photograph by Beato.

He selected the little Nubian town of Bohani, which lay exactly opposite to the present village of Wady Halfa, and transformed it into a strong frontier fortress. Besides the usual citadel, he built there a temple dedicated to the Theban god Amon and to the local Horus; he then set up a stele commemorat-

ing his victories over the peoples beyond the cataract. Ten of their principal chiefs had passed before Amon as prisoners, their arms tied behind their backs, and had been sacrificed at the foot of the altar by the sovereign himself: he represented them on the stele by enclosing their names in battle-

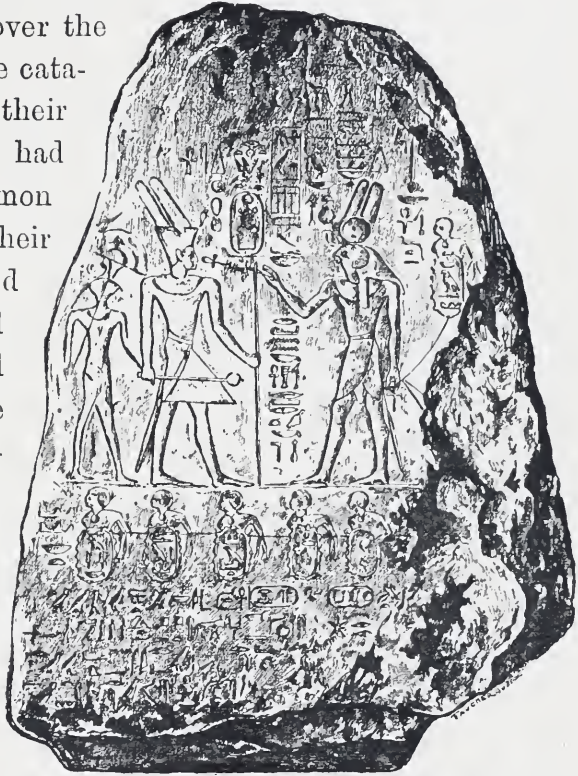

THE TRIUMPHAL STELE OF ÛSIRTASEN I.¹

ment ed car- touches, each sur- mounted by the bust of a man bound by a long cord which is held by the conqueror. Nearly a century later Ûsirtasen III. enlarged the fortress,

¹ Drawn by Faucher-Gudin, from a photograph of the original in the museum at Florence.

and finding doubtless that it was not sufficiently strong to protect the passage of the cataract, he stationed outposts at various points, at Matûga, Fakus, and Kassa. They served as mooring-places where the vessels which went up and down stream with merchandise might be made fast to the bank at sunset. The bands of Bedouin, lurking in the neighbourhood, would have rejoiced to surprise them, and by their depredations to stop the commerce between the Said and the Upper Nile, during the few weeks in which it could be carried on with a minimum of danger. A narrow gorge crossed by a bed of granite, through which the Nile passes at Semneh, afforded another most favourable site for the completion of this system of defence. On cliffs rising sheer above the current, the king constructed two fortresses, one on each bank of the river, which completely commanded the approaches by land and water. On the right bank at Kummeh, where the position was naturally a strong one, the engineers described an irregular square, measuring about two hundred feet each side; two projecting bastions flanked the entrance, the one to the north covering the approaching pathways, the southern one commanding the river-bank. A road with a ditch runs at about thirteen feet from the walls round the building, closely following its contour, except at the north-west and south-east angles, where there are two projections which formed bastions. The town on the other bank, Samninû-Kharp-Khâkerî, occupied a less favourable position: its eastern flank was protected by a zone of rocks and by the river, but the three other sides were of easy approach. They were provided with

ramparts which rose to the height of eighty-two feet above the plain, and were strengthened at unequal distances by enormous buttresses. These resembled towers without parapets, overlooking every part of the encircling road, and from them the defenders could take the attack-

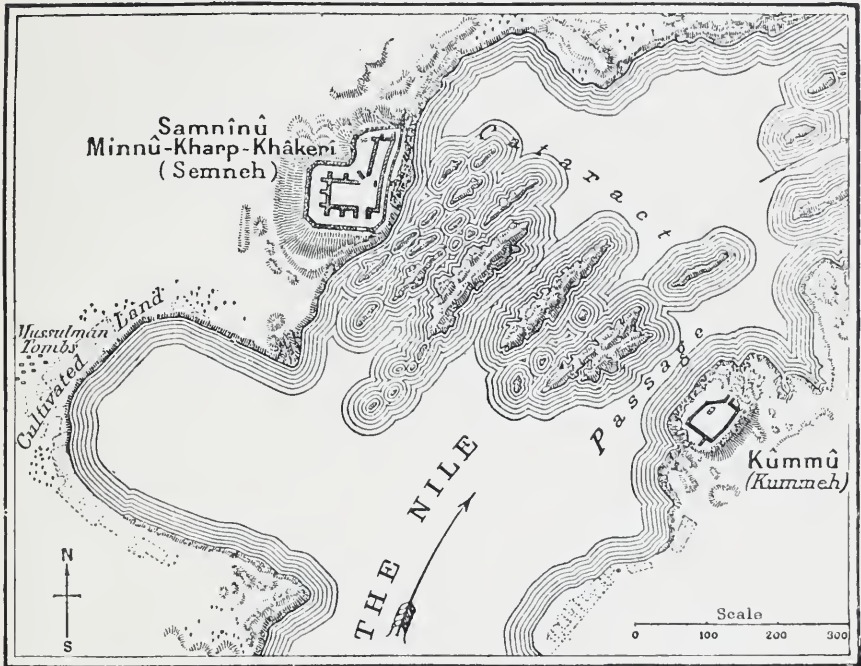

L. Thuillier, del^t

THE RAPIDS OF THE NILE AT SEMNEH, AND THE TWO FORTRESSES BUILT BY ÛSIRTASEN III.¹

ing sappers in flank. The intervals between them had been so calculated as to enable the archers to sweep the intervening space with their arrows. The main building is of crude brick, with beams laid horizontally between;

¹ Map drawn up by Thuillier from the somewhat obsolete survey of Cailliaud

the base of the external rampart is nearly vertical, while the upper part forms an angle of some seventy degrees with the horizon, making the scaling of it, if not impossible, at least very difficult. Each of the enclosing walls of the two fortresses surrounded a town complete in itself, with temples dedicated to their founders and to the Nubian deities, as well as numerous habitations, now in ruins. The sudden widening of the river immediately to the south of the rapids made a kind of natural roadstead, where the Egyptian squadron could lie without danger on the eve of a campaign against Ethiopia; the galiots of the negroes there awaited permission to sail below the rapids, and to enter Egypt with their cargoes. At once a military station and a river custom-house, Semneh was the necessary bulwark of the new Egypt, and *Ûsirtasen* III. emphatically proclaimed the fact, in two decrees, which he set up there for the edification of posterity. "Here is," so runs the first, "the southern boundary fixed in the year VIII. under his Holiness of *Khâkeri*, *Ûsirtasen*, who gives life always and for ever, in order that none of the black peoples may cross it from above, except only for the transport of animals, oxen, goats, and sheep belonging to them." The edict of the year XVI. reiterates the prohibition of the year VIII., and adds that "His Majesty caused his own statue to be erected at the landmarks which he himself had set up." The beds of the first and second cataracts were then less worn away than they are now; they are therefore more efficacious in keeping back the water and forcing it to rise to a higher level above. The cataracts acted as indicators of the

inundation, and if their daily rise and fall were studied, it was possible to announce to the dwellers on the banks lower down the river the progress and probable results of the flood. As long as the dominion of the Pharaohs reached no further than Philæ, observations of the Nile

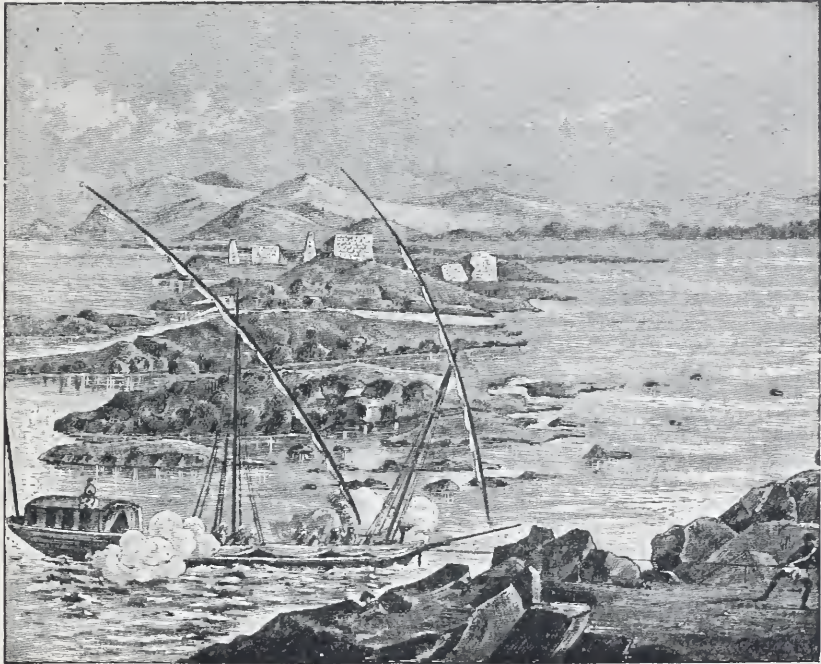

THE CHANNEL OF THE NILE BETWEEN THE TWO FORTRESSES OF SEMNEH AND KUMMEH.¹

were always taken at the first cataract; and it was from Elephantinê that Egypt received the news of the first appearance and progress of the inundation. Amenembâit III. set up a new nilometer at the new frontier, and gave

¹ Reproduction by Faucher-Gudin of a sketch published by CAILLIAUD, *Voyage à Méroë, Atlas*, vol. ii, pl. xxx.

orders to his officers to observe the course of the flood. They obeyed him scrupulously, and every time that the inundation appeared to them to differ from the average of ordinary years, they marked its height on the rocks of Semneh and Kummeh, engraving side by side with the figure the name of the king and the date of the year. The custom was continued there under the XIIIth dynasty; afterwards, when the frontier was pushed further south, the nilometer accompanied it.

The country beyond Semneh was virgin territory, almost untouched and quite uninjured by previous wars. Its name now appears for the first time upon the monuments, in the form of Kaûshû—the humbled Kûsh. It comprised the districts situated to the south within the immense loop described by the river between Dongola and Khartoum, those vast plains intersected by the windings of the White and Blue Niles, known as the regions of Kordofan and Darfur; it was bounded by the mountains of Abyssinia, the marshes of Lake Nû, and all those semi-fabulous countries to which were relegated the “Isles of the Manes” and the “Lands of Spirits.” It was separated from the Red Sea by the land of Pûanît; and to the west, between it and the confines of the world, lay the Timilhû. Scores of tribes, white, copper-coloured, and black, bearing strange names, wrangled over the possession of this vaguely defined territory; some of them were still savage or emerging from barbarism, while others had attained to a pitch of material civilization almost comparable with that of Egypt. The same diversity of types, the same instability and the same want of intelligence

which characterized the tribes of those days, still distinguish the medley of peoples who now frequent the upper valley of the Nile. They led the same sort of animal life, guided by impulse, and disturbed, owing to the caprices of their petty chiefs, by bloody wars which



KÛSHITE PRISONERS BROUGHT TO EGYPT.¹

often issued in slavery or in emigration to distant regions. With such shifting and unstable conditions, it would be difficult to build up a permanent State. From time to time some kinglet, more daring, cunning, tenacious, or better fitted to govern than the rest, extended his dominion

¹ Drawn by Faucher-Gudin, from the water-colour drawing by Mr. Blackden.

over his neighbours, and advanced step by step, till he united immense tracts under his single rule. As by degrees his kingdom enlarged, he made no efforts to organize it on any regular system, to introduce any uniformity in the administration of its affairs, or to gain the adherence of its incongruous elements by just laws which would be equally for the good of all: when the massacres which accompanied his first victories were over, when he had incorporated into his own army what was left of the vanquished troops, when their children were led into servitude and he had filled his treasury with their spoil and his harem with their women, it never occurred to him that there was anything more to be done. If he had acted otherwise, it would not probably have been to his advantage. Both his former and present subjects were too divergent in language and origin, too widely separated by manners and customs, and too long in a state of hostility to each other, to draw together and to become easily welded into a single nation. As soon as the hand which held them together relaxed its hold for a moment, discord crept in everywhere, among individuals as well as among the tribes, and the empire of yesterday resolved itself into its original elements even more rapidly than it had been formed. The clash of arms which had inaugurated its brief existence died quickly away, the remembrance of its short-lived glory was lost after two or three generations in the horrors of a fresh invasion: its name vanished without leaving a trace behind. The occupation of Nubia brought Egypt into contact with this horde of incongruous peoples, and the contact soon entailed a struggle. It is

futile for a civilized state to think of dwelling peacefully with any barbarous nation with which it is in close proximity. Should it decide to check its own advances, and impose limits upon itself which it shall not pass over, its moderation is mistaken for feebleness and impotence; the vanquished again take up the offensive, and either force the civilized power to retire, or compel it to cross its former boundary. The Pharaohs did not escape this inevitable consequence of conquest: their southern frontier advanced continually higher and higher up the Nile, without ever becoming fixed in a position sufficiently strong to defy the attacks of the Barbarians. *Ûsirtasen I.* had subdued the countries of *Hahû*, of *Khonthanûnofir*, and *Shaad*, and had beaten in battle the *Shemik*, the *Khasa*, the *Sûs*, the *Aqîn*, the *Anû*, the *Sabiri*, and the people of *Akîti* and *Makisa*. *Amenemhât II.*, *Ûsirtasen II.*, and *Ûsirtasen III.* never hesitated to "strike the humbled *Kûsh*" whenever the opportunity presented itself. The last-mentioned king in particular chastised them severely in his VIIIth, XIIth, XVIth, and XIXth years, and his victories made him so popular, that the Egyptians of the Greek period, identifying him with the *Sesostris* of *Herodotus*, attributed to him the possession of the universe. On the base of a colossal statue of rose granite which he erected in the temple of *Tanis*, we find preserved a list of the tribes which he conquered: the names of them appear to us most outlandish—*Alaka*, *Matakaraû*, *Tûrasû*, *Pamaïka*, *Uarakî*, *Paramakâ*—and we have no clue as to their position on the map. We know merely that they lived in the desert, on both sides of the Nile, in the latitude of *Berber* or thereabouts. Similar

expeditions were sent after *Ûsirtasen's* time, and *Amenem-hât III.* regarded both banks of the Nile, between *Semneh* and *Dongola*, as forming part of the territory of *Egypt* proper. Little by little, and by the force of circumstances, the making of *Greater Egypt* was realized; she approached nearer and nearer towards the limit which had been prescribed for her by nature, to that point where the Nile receives its last tributaries, and where its peerless valley takes its origin in the convergence of many others.

The conquest of *Nubia* was on the whole an easy one, and so much personal advantage accrued from these wars, that the troops and generals entered on them without the least repugnance. A single fragment has come down to us which contains a detailed account of one of these campaigns, probably that conducted by *Ûsirtasen III.* in the *XVIth* year of his reign. The Pharaoh had received information that the tribes of the district of *Hûâ*, on the *Tacazze*, were harassing his vassals, and possibly also those *Egyptians* who were attracted by commerce to that neighbourhood. He resolved to set out and chastise them severely, and embarked with his fleet. It was an expedition almost entirely devoid of danger: the invaders landed only at favourable spots, carried off any of the inhabitants who came in their way, and seized on their cattle—on one occasion as many as a hundred and twenty-three oxen and eleven asses, on others less. Two small parties marched along the banks, and foraging to the right and left, drove the booty down to the river. The tactics of invasion have scarcely undergone any change in these countries; the account given by *Cailliaud* of the first

conquest of Fazogl by Ismail-Pasha, in 1822, might well serve to complete the fragments of the inscription of Ūsirtasen III., and restore for us, almost in every detail, a faithful picture of the campaigns carried on in these regions by the kings of the XIIth dynasty. The people are hunted down in the same fashion; the country is similarly ravaged by a handful of well-armed, fairly disciplined men attacking naked and disconnected hordes, the young men are massacred after a short resistance or forced to escape into the woods, the women are carried off as slaves, the huts pillaged, villages burnt, whole tribes exterminated in a few hours. Sometimes a detachment, having imprudently ventured into some thorny thicket to attack a village perched on a rocky summit, would experience a reverse, and would with great difficulty regain the main body of troops, after having lost three-fourths of its men. In most cases there was no prolonged resistance, and the attacking party carried the place with the loss of merely two or three men killed or wounded. The spoil was never very considerable in any one locality, but its total amount increased as the raid was carried afield, and it soon became so bulky that the party had to stop and retrace their steps, in order to place it for safety in the nearest fortress. The booty consisted for the most part of herds of oxen and of cumbrous heaps of grain, as well as wood for building purposes. But it also comprised objects of small size but of great value, such as ivory, precious stones, and particularly gold. The natives collected the latter in the alluvial tracts watered by the Tacazze, the Blue Nile and its tributaries. The women

were employed in searching for nuggets, which were often of considerable size; they enclosed them in little leather cases, and offered them to the merchants in exchange for products of Egyptian industry, or they handed them over to the goldsmiths to be made into bracelets, ear, nose, or finger rings, of fairly fine workmanship. Gold was found in combination with several other metals, from which they did not know how to separate it: the purest gold had a pale yellow tint, which was valued above all others, but electrum, that is to say, gold alloyed with silver in the proportion of eighty per cent., was also much in demand, while greyish-coloured gold, mixed with platinum, served for making common jewellery.¹ None of these expeditions produced any lasting results, and the Pharaohs established no colonies in any of these countries. Their Egyptian subjects could not have lived there for any length of time without deteriorating by intermarriage with the natives or from the effects of the climate; they would have degenerated into a half-bred race, having all the vices and none of the good qualities of the aborigines. The Pharaohs, therefore, continued their hostilities without further scruples, and only sought to gain as much as possible from their victories. They cared little if nothing

¹ Cailliaud has briefly described the auriferous sand of the Qamânyl, and the way in which it is worked: it is from him that I have borrowed the details given in the text. From analyses which I caused to be made at the Bûlaq Museum of Egyptian jewellery of the time of the XVIIIth dynasty, which had been broken and were without value, from an archaeological or artistic point of view, I have demonstrated the presence of the platinum and silver mentioned by Cailliaud as being found in the nuggets from the Blue Nile.

remained after they had passed through some district, or if the passage of their armies was marked only by ruins. They seized upon everything which came across their path—men, chattels, or animals—and carried them back to Egypt; they recklessly destroyed everything for which they had no use, and made a desert of fertile districts which but yesterday had been covered with crops and studded with populous villages. The neighbouring inhabitants, realizing their incapacity to resist regular troops, endeavoured to buy off the invaders by yielding up all they possessed in the way of slaves, flocks, wood, or precious metals. The generals in command, however, had to reckon with the approaching low Nile, which forced them to beat a retreat; they were obliged to halt at the first appearance of it, and they turned homewards “in peace,” their only anxiety being to lose the smallest possible number of men or captured animals on their return journey.

As in earlier times, adventurous merchants penetrated into districts not reached by the troops, and prepared the way for conquest. The princes of Elephantinê still sent caravans to distant parts, and one of them, Siranpîtû, who lived under Ūsirtasen I. and Amenemhâit II., recorded his explorations on his tomb, after the fashion of his ancestors: the king at several different times had sent him on expeditions to the Soudan, but the inscription in which he gives an account of them is so mutilated, that we cannot be sure which tribes he visited. We learn merely that he collected from them skins, ivory, ostrich feathers—everything, in fact, which Central Africa has furnished as

articles of commerce from time immemorial. It was not, however, by land only that Egyptian merchants travelled to seek fortune in foreign countries: the Red Sea attracted them, and served as a quick route for reaching the land of Pûanît, whose treasures in perfumes and rarities of all kinds had formed the theme of ancient traditions and navigators' tales. Relations with it had been infrequent, or had ceased altogether, during the wars of the Heracleopolitan period: on their renewal it was necessary to open up afresh routes which had been forgotten for centuries.

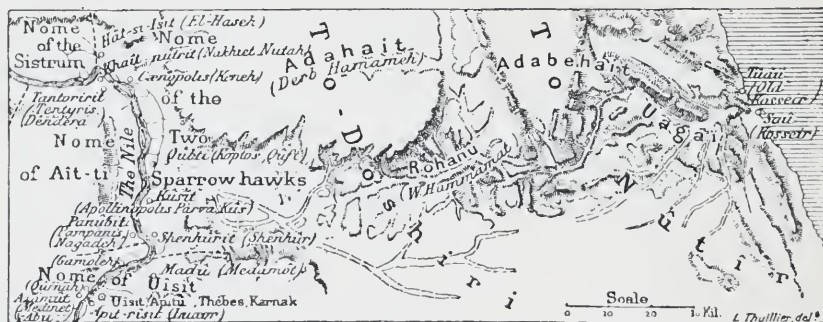

THE ROUTES LEADING FROM THE NILE TO THE RED SEA, BETWEEN KOPTOS AND KOSSEIR.

Traffic was confined almost entirely to two or three out of the many,—one which ran from Elephantinê or from Nekhabît to the “Head of Nekhabît,” the Berenicê of the Greeks; others which started from Thebes or Koptos, and struck the coast at the same place or at Saû, the present Kosseir. The latter, which was the shortest as well as the favourite route, passed through Wady Hammamât, from whence the Pharaohs drew the blocks of granite for their sarcophagi. The officers who were sent to quarry the stone

often took advantage of the opportunity to visit the coast, and to penetrate as far as the Spice Regions. As early as the year VIII. of Sônkherî, the predecessor of Amenemhât I., the "sole friend" Hûnû had been sent by this road, "in order to take the command of a squadron to Pûanût, and to collect a tribute of fresh incense from the princes of the desert." He got together three thousand men, distributed to each one a goatskin bottle, a crook for carrying it, and ten loaves, and set out from Koptos with this little army. No water was met with on the way: Hûnû bored several wells and cisterns in the rock, one at a halting-place called Baît, two in the district of Adahât, and finally one in the valleys of Adabehât. Having reached the seaboard, he quickly constructed a great barge, freighted it with merchandise for barter, as well as with provisions, oxen, cows, and goats, and set sail for a cruise along the coast: it is not known how far he went, but he came back with a large cargo of all the products of the "Divine Land," especially of incense. On his return, he struck off into the Ûagai valley, and thence reached that of Rohanû, where he chose out splendid blocks of stone for a temple which the king was building: "Never had 'Royal Cousin' sent on an expedition done as much since the time of the god Râ!" Numbers of royal officers and adventurers followed in his footsteps, but no record of them has been preserved for us. Two or three names only have escaped oblivion—that of Klnûmhotpû, who in the first year of Ûsirtasen I. erected a stele in the Wady Gasûs in the very heart of the "Divine Land;" and that of Khentkhitioîrû, who in the XXVIIIth year of Amenemhât II. entered the haven of Saû

after a fortunate cruise to Pûanît, without having lost a vessel or even a single man. Navigation is difficult in the Red Sea. The coast as a rule is precipitous, bristling with reefs and islets, and almost entirely without strand or haven. No river or stream runs into it; it is bordered by no fertile or wooded tract, but by high cliffs, half disintegrated by the burning sun, or by steep mountains, which appear sometimes a dull red, sometimes a dingy grey colour, according to the material—granite or sandstone—which predominates in their composition. The few tribes who inhabit this desolate region maintain a miserable existence by fishing and hunting: they were considered, during the Greek period, to be the most unfortunate of mortals, and if they appeared to be so to the mariners of the Ptolemies, doubtless they enjoyed the same reputation in the more remote time of the Pharaohs. A few fishing villages, however, are mentioned as scattered along the littoral; watering-places, at some distance apart, frequented on account of their wells of brackish water by the desert tribes: such were Nahasît, Tap-Nekhabît, Saû, and Tâû: these the Egyptian merchant-vessels used as victualling stations, and took away as cargo the products of the country—mother-of-pearl, amethysts, emeralds, a little lapis-lazuli, a little gold, gums, and sweet-smelling resins. If the weather was favourable, and the intake of merchandise had been scanty, the vessel, braving numerous risks of shipwreck, continued its course as far as the latitude of Sûakin and Massowah, which was the beginning of Pûanît properly so called. Here riches poured down to the coast from the interior, and selection became a difficulty: it was hard to

decide which would make the best cargo, ivory or ebony, panthers' skins or rings of gold, myrrh, incense, or a score of other sweet-smelling gums. So many of these odoriferous resins were used for religious purposes, that it was always to the advantage of the merchant to procure as much of them as possible: incense, fresh or dried, was the staple and characteristic merchandise of the Red Sea, and the good people of Egypt pictured Pûanît as a land of perfumes, which attracted the sailor from afar by the delicious odours which were wafted from it.

These voyages were dangerous and trying: popular imagination seized upon them and made material out of them for marvellous tales. The hero chosen was always a daring adventurer sent by his master to collect gold from the mines of Nubia; by sailing further and further up the river, he reached the mysterious sea which forms the southern boundary of the world. "I set sail in a vessel one hundred and fifty cubits long, forty wide, with one hundred and fifty of the best sailors in the land of Egypt, who had seen heaven and earth, and whose hearts were more resolute than those of lions. They had foretold that the wind would not be contrary, or that there would be even none at all; but a squall came upon us unexpectedly while we were in the open, and as we approached the land, the wind freshened and raised the waves to the height of eight cubits. As for me, I clung to a beam, but those who were on the vessel perished without one escaping. A wave of the sea cast me on to an island, after having spent three days alone with no other companion than my own heart. I slept there in the shade of a thicket; then I set my legs

in motion in quest of something for my mouth." The island produced a quantity of delicious fruit: he satisfied his hunger with it, lighted a fire to offer a sacrifice to the gods, and immediately, by the magical power of the sacred rites, the inhabitants, who up to this time had been invisible, were revealed to his eyes. "I heard a sound like that of thunder, which I at first took to be the noise of the flood-tide in the open sea; but the trees quivered, the earth trembled. I uncovered my face, and I perceived that it was a serpent which was approaching. He was thirty cubits in length, and his wattles exceeded two cubits; his body was incrustated with gold, and his colour appeared like that of real lapis. He raised himself before me and opened his mouth; while I prostrated myself before him, he said to me: 'Who hath brought thee, who hath brought thee, little one, who hath brought thee? If thou dost not tell me immediately who brought thee to this island, I will cause thee to know thy littleness: either thou shalt faint like a woman, or thou shalt tell me something which I have not yet heard, and which I knew not before thee.' Then he took me into his mouth and carried me to his dwelling-place, and put me down without hurting me; I was safe and sound, and nothing had been taken from me." Our hero tells the serpent the story of his shipwreck, which moves him to pity and induces him to reciprocate his confidence. "Fear nothing, fear nothing, little one, let not thy countenance be sad! If thou hast come to me, it is the god who has spared thy life; it is he who has brought thee into this 'Isle of the Double,' where nothing is lacking, and which is filled with all good things. Here

thou shalt pass one month after another till thou hast remained four months in this island, then shall come a vessel from thy country with mariners ; thou canst depart with them to thy country, and thou shalt die in thy city. To converse rejoices the heart, he who enjoys conversation bears misfortune better ; I will therefore relate to thee the history of this island." The population consisted of seventy-five serpents, all of one family : it formerly comprised also a young girl, whom a succession of misfortunes had cast on the island, and who was killed by lightning. The hero, charmed with such good nature, overwhelmed the hospitable dragon with thanks, and promised to send him numerous presents on his return home. "I will slay asses for thee in sacrifice, I will pluck birds for thee, I will send to thee vessels filled with all the riches of Egypt, meet for a god, the friend of man in a distant country unknown to men." The monster smiled, and replied that it was needless to think of sending presents to one who was the ruler of Pûanit ; besides, "as soon as thou hast quitted this place, thou wilt never again see this island, for it will be changed into waves."—"And then, when the vessel appeared, according as he had predicted to me, I went and perched upon a high tree and sought to distinguish those who manned it. I next ran to tell him the news, but I found that he was already informed of its arrival, and he said to me : 'A pleasant journey home, little one ; mayst thou behold thy children again, and may thy name be well spoken of in thy town ; such are my wishes for thee !' He added gifts to these obliging words. I placed all these on board the vessel which had come, and prostrating

myself, I adored him. He said to me : ‘ After two months thou shalt reach thy country, thou wilt press thy children to thy bosom, and thou shalt rest in thy sepulchre.’ After that I descended the shore to the vessel, and I hailed the sailors who were in it. I gave thanks on the shore to the master of the island, as well as to those who dwelt in it.” This might almost be an episode in the voyages of Sindbad the Sailor ; except that the monsters which Sindbad met with in the course of his travels were not of such a kindly disposition as the Egyptian serpent : it did not occur to them to console the shipwrecked with the charm of a lengthy gossip, but they swallowed them with a healthy appetite. Putting aside entirely the marvellous element in the story, what strikes us is the frequency of the relations which it points to between Egypt and Pûanit. The appearance of an Egyptian vessel excites no astonishment on its coasts : the inhabitants have already seen many such, and at such regular intervals, that they are able to predict the exact date of their arrival. The distance between the two countries, it is true, was not considerable, and a voyage of two months was sufficient to accomplish it.

While the new Egypt was expanding outwards in all directions, the old country did not cease to add to its riches. The two centuries during which the XIIth dynasty continued to rule were a period of profound peace ; the monuments show us the country in full possession of all its resources and its arts, and its inhabitants both cheerful and contented. More than ever do the great lords and royal officers expatiate in their epitaphs upon the strict justice which they have rendered to their vassals

and subordinates, upon the kindness which they have shown to the fellahîn, on the paternal solicitude with which, in the years of insufficient inundations or of bad harvests, they have striven to come forward and assist them, and upon the unheard-of disinterestedness which kept them from raising the taxes during the times of average Niles, or of unusual plenty. Gifts to the gods poured in from one end of the country to the other, and the great building works, which had been at a standstill since the end of the VIth dynasty, were recommenced simultaneously on all sides. There was much to be done in the way of repairing the ruins, of which the number had accumulated during the two preceding centuries. Not that the most audacious kings had ventured to lay their hands on the sanctuaries: they emptied the sacred treasuries, and partially confiscated their revenues, but when once their cupidity was satisfied, they respected the fabrics, and even went so far as to restore a few inscriptions, or, when needed, to replace a few stones. These magnificent buildings required careful supervision: in spite of their being constructed of the most durable materials—sandstone, granite, limestone,—in spite of their enormous size, or of the strengthening of their foundations by a bed of sand and by three or four courses of carefully adjusted blocks to form a substructure, the Nile was ever threatening them, and secretly working at their destruction. Its waters, filtering through the soil, were perpetually in contact with the lower courses of these buildings, and kept the foundations of the walls and the bases of the columns constantly damp: the saltpetre which the waters

had dissolved in their passage, crystallising on the limestone, would corrode and undermine everything, if precautions were not taken. When the inundation was over, the subsidence of the water which impregnated the subsoil caused in course of time settlements in the most solid foundations: the walls, disturbed by the unequal sinking of the ground, got out of the perpendicular and cracked; this shifting displaced the architraves which held the columns together, and the stone slabs which formed the roof. These disturbances, aggravated from year to year, were sufficient, if not at once remedied, to entail the fall of the portions attacked; in addition to this, the Nile, having threatened the part below with destruction, often hastened by direct attacks the work of ruin, which otherwise proceeded slowly. A breach in the embankments protecting the town or the temple allowed its waters to rush violently through, and thus to effect large gaps in the decaying walls, completing the overthrow of the columns and wrecking the entrance halls and secret chambers by the fall of the roofs. At the time when Egypt came under the rule of the XIIth dynasty there were but few cities which did not contain some ruined or dilapidated sanctuary. Amenemhât I., although fully occupied in reducing the power of the feudal lords, restored the temples as far as he was able, and his successors pushed forward the work vigorously for nearly two centuries.

The Delta profited greatly by this activity in building. The monuments there had suffered more than anywhere else: fated to bear the first shock of foreign invasion,

and transformed into fortresses while the towns in which they were situated were besieged, they have been captured again and again by assault, broken down by attacking engines, and dismantled by all the conquerors of Egypt, from the Assyrians to the Arabs and the Turks. The fellahîn in their neighbourhood have for centuries come to them to obtain limestone to burn in their kilns, or to use them as a quarry for sandstone or granite for the doorways of their houses, or for the thresholds of their mosques. Not only have they been ruined, but the remains of their ruins have, as it were, melted away and almost entirely disappeared in the course of ages. And yet, wherever excavations have been made among these remains which have suffered such deplorable ill-treatment, colossi and inscriptions commemorating the Pharaohs of the XIIth dynasty have been brought to light. Amenemhât I. founded a great temple at Tanis in honour of the gods of Memphis: the vestiges of the columns still scattered on all sides show that the main body of the building was of rose granite, and a statue of the same material has preserved for us a portrait of the king. He is seated, and wears the tall head-dress of Osiris. He has a large smiling face, thick lips, a short nose, and big staring eyes: the expression is one of benevolence and gentleness, rather than of the energy and firmness which one would expect in the founder of a dynasty. The kings who were his successors all considered it a privilege to embellish the temple and to place in it some memorial of their veneration for the god. Ûsirtasen I., following the example of his father, set up a statue of himself in the

form of Osiris: he is sitting on his throne of grey granite, and his placid face unmistakably recalls that of Amenemhât I. Amenemhât II., Ûsirtasen II., and his wife Nofrît have also dedicated their images within the sanctuary.



THE STATUE OF NOFRÎT.¹

Nofrît's is of black granite: her head is almost eclipsed by the heavy Hâthor wig, consisting of two enormous tresses of hair which surround the cheeks, and lie with an outward curve upon the breast; her eyes, which were formerly inlaid, have fallen out, the bronze eyelids are lost, her arms have almost disappeared. What remains of her, however, gives us none the less the impression of a young and graceful woman, with a lithe and well-proportioned body, whose outlines are delicately modelled under the tight-fitting smock worn by Egyptian women;

the small and rounded breasts curve outward between the

¹ Drawn by Faucher-Gudin, from a photograph by Insinger. In addition to the complete statue, the Museum at Gizeh possesses a torso from the same source. I believe I can recognize another portrait of the same queen in a beautiful statue in black granite, which has been in the Museum at Marseilles since the beginning of the present century.

extremities of her curls and the embroidered hem of her garment; and a pectoral bearing the name of her husband lies flat upon her chest, just below the column of her throat. These various statues have all an evident artistic relationship to the beautiful granite figures of the Ancient Empire. The sculptors who executed them belonged to the same school as those who carved Khephren out of the solid diorite: there is the same facile use of the chisel, the same indifference to the difficulties presented by the material chosen, the same finish in the detail, the same knowledge of the human form. One is almost tempted to believe that Egyptian art remained unchanged all through those long centuries, and yet as soon as a statue of the early period is placed side by side with one of the XIIth dynasty, we immediately perceive something in the one which is lacking in the other. It is a difference in feeling, even if the technique remains unmodified. It was the man himself that the sculptors desired to represent in the older Pharaohs, and however haughty may be the countenance which we admire in the Khephren, it is the human element which predominates in him. The statues of Amenemhâit I. and his successors appear, on the contrary, to represent a superior race: at the time when these were produced, the Pharaoh had long been regarded as a god, and the divine nature in him had almost eliminated the human. Whether intentionally or otherwise, the sculptors idealized their model, and made him more and more resemble the type of the divinities. The head always appears to be a good likeness, but smoothed down and sometimes lacking in expression.

Not only are the marks of age rendered less apparent, and the features made to bear the stamp of perpetual youth, but the characteristics of the individual, such as the accentuation of the eyebrows, the protuberance of the cheek-bones, the projection of the under lip, are all softened down as if intentionally, and made to give way to a uniform expression of majestic tranquillity. One king only, Amenemhât III., refused to go down to posterity thus effaced, and caused his portrait to be taken as he really was. He has certainly the round full face of Amenemhât or of Ûsirtasen I., and there is an undeniable family likeness between him and his ancestors; but at the first glance we feel sure that the artist has not in any way flattered his model. The forehead is low and slightly retreating, narrow across the temples; his nose is aquiline, pronounced in form, and large at the tip; the thick lips are slightly closed; his mouth has a disdainful curve, and its corners are turned down as if to repress the inevitable smile common to most Egyptian statues; the chin is full and heavy, and turns up in front in spite of the weight of the false beard dependent from it; he has small narrow eyes, with full lids; his cheek-bones are accentuated and projecting, the cheeks hollow, and the muscles about the nose and mouth strongly defined. The whole presents so strange an aspect, that for a long time statues of this type have been persistently looked upon as productions of an art which was only partially Egyptian. It is, indeed, possible that the Tanis sphinxes were turned out of workshops where the principles and practice of the sculptor's art had previously

undergone some Asiatic influence; the bushy mane which surrounds the face, and the lion's ears emerging from it, are exclusively characteristic of the latter. The purely human statues in which we meet with the same type of countenance have no peculiarity of workmanship which could be attributed to the imitation of a foreign art. If the nameless masters to whom we owe their existence desired to bring about a reaction against the conventional technique of their contemporaries, they at least introduced no foreign innovations; the monuments of the Memphite period furnished them with all the models they could possibly wish for.

Bubastis had no less occasion than Tanis to boast of the generosity of the Theban Pharaohs. The temple of Bastit, which had been decorated by Kheops and Khephren, was still in existence: Amenemhât I., *Ûsirtasen* I., and their immediate successors confined themselves to the restoration of several chambers, and to the erection of their own statues, but *Ûsirtasen* III. added to it a new structure which must have made it rival the finest monuments in Egypt. He believed, no doubt, that he was under particular obligations to the lioness goddess of the city, and attributed to her aid, for unknown reasons, some of his successes in Nubia; it would appear that it was with the spoil of a campaign against the country of the Hûâ that he endowed a part of the new sanctuary.¹

¹ The fragment found by Naville formed part of an inscription engraved on a wall: the wars which it was customary to commemorate in a temple were always selected from those in which the whole or a part of the booty had been consecrated to the use of the local divinity.

Nothing now remains of it except fragments of the architraves and granite columns, which have been used over again by Pharaohs of a later period when restoring or altering the fabric. A few of the columns belong to the lotiform type. The shaft is composed of eight



ONE OF THE TANIS SPHINXES IN THE GÍZEH MUSEUM.¹

triangular stalks rising from a bunch of leaves, symmetrically arranged, and bound together at the top by a riband, twisted thrice round the bundle; the capital is

¹ Drawn by Faucher-Gudin, from a photograph by Émil Brugsch-Bey, taken in 1881. The sphinx bears on its breast the cartouche of Psiúkhanú, a Tanite Pharaoh of the XXIst dynasty.

formed by the union of the eight lotus buds, surmounted by a square member on which rests the architrave. Other columns have Hâthor-headed capitals, the heads being set back to back, and bearing the flat head-dress ornamented with the uræus. The face of the goddess, which is somewhat flattened when seen closely on the eye-level, stands out and becomes more lifelike in proportion as the spectator recedes from it; the projection of the features has been calculated so as to produce the desired effect at the right height when seen from below. The district lying between Tanis and Bubastis is thickly studded with monuments built or embellished by the Amenemhâits and Ûsirtasens: wherever the pickaxe is applied, whether at Faku or Tell-Nebêsheh, remains of them are brought to light—statues, stelæ, tables of offerings, and fragments of dedicatory or historical inscriptions. While carrying on works in the temple of Phtah at Memphis, the attention of these Pharaohs was attracted to Heliopolis. The temple of Râ there was either insufficient for the exigencies of worship, or had been allowed to fall into decay. Ûsirtasen III. resolved, in the third year of his reign, to undertake its restoration. The occasion appears to have been celebrated as a festival by all Egypt, and the remembrance of it lasted long after the event: the somewhat detailed account of the ceremonies which then took place was copied out again at Thebes, towards the end of the XVIIIth dynasty. It describes the king mounting his throne at the meeting of his council, and receiving, as was customary, the eulogies of his “sole friends” and of the courtiers who surrounded him: “Here,” says he,

addressing them, "has my Majesty ordained the works which shall recall my worthy and noble acts to posterity. I raise a monument, I establish lasting decrees in favour of Harmakhis, for he has brought me into the world to do as he did, to accomplish that which he decreed should be done; he has appointed me to guide this earth, he has known it, he has called it together and he has granted me his help; I have caused the Eye which is in him to become serene, in all things acting as he would have me to do, and I have sought out that which he had resolved should be known. I am a king by birth, a suzerain not of my own making; I have governed from childhood, petitions have been presented to me when I was in the egg, I have ruled over the ways of Anubis, and he raised me up to be master of the two halves of the world, from the time when I was a nursling; I had not yet escaped from the swaddling-bands when he enthroned me as master of men; creating me himself in the sight of mortals, he made me to find favour with the Dweller in the Palace, when I was a youth. . . . I came forth as Horus the eloquent, and I have instituted divine oblations; I accomplish the works in the palace of my father Atûmû, I supply his altar on earth with offerings, I lay the foundations of my palace in his neighbourhood, in order that the memorial of my goodness may remain in his dwelling; for this palace is my name, this lake is my monument, all that is famous or useful that I have made for the gods is eternity." The great lords testified their approbation of the king's piety; the latter summoned his chancellor and commanded him to

draw up the deeds of gift and all the documents necessary for the carrying out of his wishes. "He arose, adorned with the royal circlet and with the double feather, followed by all his nobles; the chief lector of the divine book stretched the cord and fixed the stake in the ground."¹ This temple has ceased to exist; but one of the granite obelisks raised by Ûsirtasen I. on each side of the principal gateway is still standing. The whole of Heliopolis has disappeared: the site where it formerly stood is now marked only by a few almost imperceptible inequalities in the soil, some crumbling lengths of walls, and here and there some scattered blocks of limestone, containing a few lines of mutilated inscriptions which can with difficulty be deciphered; the obelisk has survived even the destruction of the ruins, and to all who understand its language it still speaks of the Pharaoh who erected it.

The undertaking and successful completion of so many great structures had necessitated a renewal of the working of the ancient quarries, and the opening of fresh ones. Amenemhât I. sent Antuf, a great dignitary, chief of the prophets of Mînu and prince of Koptos, to the valley of Rohanû, to seek out fine granite for making the royal sarcophagi. Amenemhât III. had, in the XLIII^d year of his reign, been present at the opening of several fine veins of white limestone in the quarries of Turah, which probably

¹ STERN, *Urkunde über den Bau des Sonnentempels zu On*, pl. i. ll. 13-15. The priest here performed with the king, the more important of the ceremonies necessary in measuring the area of the temple, by "inserting the measuring stakes," and marking out the four sides of the building with the cord.

furnished material for the buildings proceeding at Heliopolis and Memphis. Thebes had also its share of both limestone and granite, and Amon, whose sanctuary up to this time had only attained the modest proportions suited to a provincial god, at last possessed a temple which raised him to the rank of the highest feudal divinities. Amon's career had begun under difficulties: he had been merely a vassal-god of Montû, lord of Hermonthis (the Aûnû of the south), who had granted to him the ownership of the village of Karnak only. The unforeseen good fortune of the Antufs was the occasion of his emerging from his obscurity: he did not dethrone Montû, but shared with him the homage of all the neighbouring villages—Luxor, Medamut, Bayadiyeh; and, on the other side of the Nile, Gurneh and Medînet-Habu. The accession of the XIIth dynasty completed his triumph, and made him the most powerful authority in Southern Egypt. He was an earth-god, a form of Mînû who reigned at Koptos, at Akhmîm and in the desert, but he soon became allied to the sun, and from thenceforth he assumed the name of Amon-Râ. The title of “sûton nûtirû” which he added to it would alone have sufficed to prove the comparatively recent origin of his notoriety; as the latest arrival among the great gods, he employed, to express his sovereignty, this word “sûton,” king, which had designated the rulers of the valley ever since the union of the two Egypts under the shadowy Menes. Reigning at first alone, he became associated by marriage with a vague indefinite goddess, called Maût, or Mût, the “mother,” who never adopted any more distinctive name: the divine son who

completed this triad was, in early times, Montû; but in later times a being of secondary rank, chosen from among the genii appointed to watch over the days of the month or the stars, was added, under the name of Khonsû. Amenemhât laid the foundations of the temple, in which the cultus of Amon was carried on down to the latest times of paganism. The building was supported by

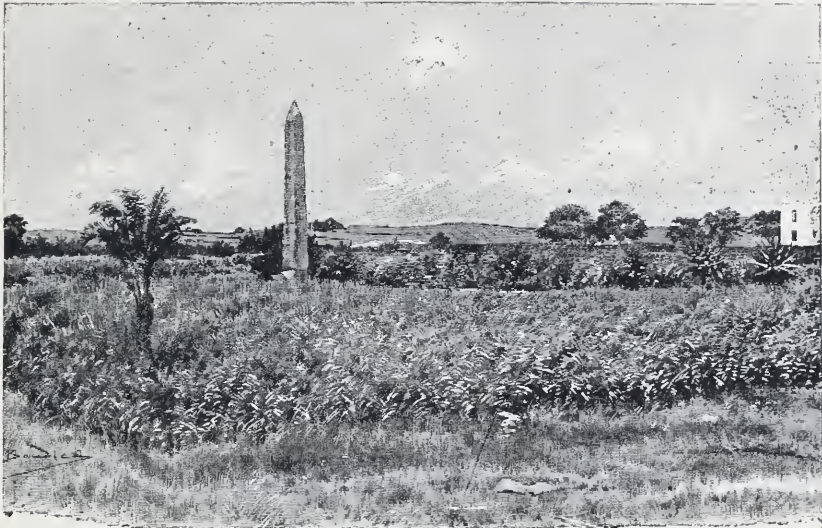

THE OBELISK OF ÛSIRTASEN I., STILL STANDING IN THE PLAIN OF HELIOPOLIS.¹

polygonal columns of sixteen sides, some fragments of which are still existing. The temple was at first of only moderate dimensions, but it was built of the choicest sandstone and limestone, and decorated with exquisite bas-reliefs. Ûsirtasen I. enlarged it, and built a beautiful house for the high priest on the west side of the sacred lake. Luxor, Zorit, Edfû, Hierakonpolis, El-Kab,

¹ Drawn by Boudier, from a photograph by Insinger.

Elephantinê, and Dendera,¹ shared between them the favour of the Pharaohs; the venerable town of Abydos became the object of their special predilection. Its reputation for sanctity had been steadily growing from the time of the Papis: its god, Khontamentit, who was identified with Osiris, had obtained in the south a rank as high as that of the Mendesian Osiris in the north of Egypt. He was worshipped as the sovereign of the sovereigns of the dead—he who gathered around him and welcomed in his domains the majority of the faithful of other cults. His sepulchre, or, more correctly speaking, the chapel representing his sepulchre, in which one of his relics was preserved, was here, as elsewhere, built upon the roof. Access to it was gained by a staircase leading up on the left side of the sanctuary: on the days of the passion and resurrection of Osiris solemn processions of priests and devotees slowly mounted its steps, to the chanting of funeral hymns, and above, on the terrace, away from the world of the living, and with no other witnesses than the stars of heaven, the faithful celebrated mysteriously the rites of the divine death and embalming. The “vassals of Osiris” flocked in crowds to these festivals, and took a delight in visiting, at least once during their lifetime, the city whither their souls would proceed after

¹ Dümichen pointed out, in the masonry of the great eastern staircase of the present temple of Hâthor, a stone obtained from the earlier temple, which bears the name of Amenemhât; another fragment, discovered and published by Mariette, shows that Amenemhât I. is here again referred to. The buildings erected by this monarch at Dendera must have been on a somewhat large scale, if we may judge from the size of this last fragment, which is the lintel of a door.

death, in order to present themselves at the "Mouth of the Cleft," there to embark in the "bari" of their divine master or in that of the Sun. They left behind them, "under the staircase of the great god," a sort of fictitious tomb, near the representation of the tomb of Osiris, in the shape of a stele, which immortalized the memory of their piety, and which served as a kind of hostelry for their soul, when the latter should, in course of time, repair to this rallying-place of all Osirian souls. The concourse of pilgrims was a source of wealth to the population, the priestly coffers were filled, and every year the original temple was felt to be more and more inadequate to meet the requirements of worship. *Ûsirtasen I.* desired to come to the rescue: he despatched *Monthotpû*, one of his great vassals, to superintend the works. The ground-plan of the portico of white limestone which preceded the entrance court may still be distinguished; this portico was supported by square pillars, and, standing against the remains of these, we see the colossi of rose granite, crowned with the Osirian head-dress, and with their feet planted on the "Nine Bows," the symbol of vanquished enemies. The best preserved of these figures represents the founder, but several others are likenesses of those of his successors who interested themselves in the temple. *Monthotpû* dug a well which was kept fully supplied by the infiltrations from the Nile. He enlarged and cleaned out the sacred lake upon which the priests launched the Holy Ark, on the nights of the great mysteries. The alluvial deposits of fifty centuries have not as yet wholly filled it up: it is still an irregularly shaped pond, which dries up in

winter, but is again filled as soon as the inundation reaches the village of El-Kharbeh. A few stones, corroded with saltpetre, mark here and there the lines of the landing



ÛSIRTASEN I. OF ABYDOS.¹

stages, a thick grove of palms fringes its northern and southern banks, but to the west the prospect is open,

¹ Drawn by Faucher-Gudin, from a photograph by M. de Banville.

and extends as far as the entrance to the gorge, through which the souls set forth in search of Paradise and the solar bark. Buffaloes now come to drink and wallow at midday where once floated the gilded "bari" of Osiris, and the murmur of bees from the neighbouring orchards alone breaks the silence of the spot which of old resounded with the rhythmical lamentations of the pilgrims.

Heracleopolis the Great, the town preferred by the



A PART OF THE ANCIENT SACRED LAKE OF OSIRIS NEAR THE TEMPLE OF ABYDOS.¹

earlier Theban Pharaohs as their residence in times of peace, must have been one of those which they proceeded to decorate *con amore* with magnificent monuments. Unfortunately it has suffered more than any of the rest, and nothing of it is now to be seen but a few wretched remains of buildings of the Roman period, and the ruins of a barbaric colonnade on the site of a Byzantine basilica almost contemporary with the Arab conquest. Perhaps

¹ Drawn by Boudier, from a photograph by Émil Brugsch-Bey, taken in 1884.

the enormous mounds which cover its site may still conceal the remains of its ancient temples. We can merely estimate their magnificence by casual allusions to them in the inscriptions. We know, for instance, that Ûsirtasen III. rebuilt the sanctuary of Harshâfitû, and that he sent expeditions to the Wady Hammamât to quarry blocks of granite worthy of his god: but the work of this king and his successors has perished in the total ruin of the ancient



THE SITE OF THE ANCIENT HERACLEOPOLIS.¹

town. Something at least has remained of what they did in that traditional dependency of Heracleopolis, the Fayûm: the temple which they rebuilt to the god Sobkû in Shodît retained its celebrity down to the time of the Cæsars, not so much, perhaps, on account of the beauty of its architecture as for the unique character of the religious rites which took place there daily. The sacred lake contained a family of tame crocodiles, the image and incarnation

¹ Drawn by Boudier, from a photograph by Golénisheff

of the god, whom the faithful fed with their offerings—cakes, fried fish, and drinks sweetened with honey. Advantage was taken of the moment when one of these creatures, wallowing on the bank, basked contentedly in the sun: two priests opened his jaws, and a third threw in the cakes, the fried morsels, and finally the liquid. The crocodile bore all this without even winking; he swallowed down his provender, plunged into the lake, and lazily reached the opposite bank, hoping to escape for a few



SOBKÛ, THE GOD OF THE FAYÛM, UNDER THE FORM OF A SACRED CROCODILE.¹

moments from the oppressive liberality of his devotees. As soon, however, as another of these approached, he was again beset at his new post and stuffed in a similar manner. These animals were in their own way great dandies: rings of gold or enamelled terra-cotta were hung from their ears, and bracelets were soldered on to their front paws. The monuments of Shodît, if any still exist, are buried under

¹ Drawn by Faucher-Gudin, from a photograph by Émil Brugsch-Bey, taken in 1885. The original in black granite is now in the Berlin Museum. It represents one of the sacred crocodiles mentioned by Strabo; we read on the base a Greek inscription in honour of Ptolemy Neos Dionysos, in which the name of the divine reptile "Petesúkhos, the great god," is mentioned.

the mounds of Medinet el-Fayûm, but in the neighbourhood we meet with more than one authentic relic of the XIIth dynasty. It was Ûsirtasen I. who erected that curious thin granite obelisk, with a circular top, whose fragments lie forgotten on the ground near the village of Begig: a sort of basin has been hollowed out around it, which fills during the inundation, so that the monument lies in a



THE REMAINS OF THE OBELISK OF BEGIG.¹

pool of muddy water during the greater part of the year. Owing to this treatment, most of the inscriptions on it have almost disappeared, though we can still make out a series of five scenes in which the king hands offerings to

several divinities. Near to Biahmû there was an old temple which had become ruinous: Amenemhât III. repaired it, and erected in front of it two of those colossal statues which the Egyptians were wont to place like sentinels at their gates, to ward off baleful influences and evil spirits. The colossi at Biahmû were of red sandstone, and were seated on high limestone pedestals, placed at the end of a rectangular court; the temple walls hid the lower part of the pedestals, so that the colossi appeared to tower above a great platform which sloped gently away from them on all sides. Herodotus, who saw them from a distance at the time of the inundation, believed that

¹ Drawn by Boudier, from a photograph by Golénisheff.

they crowned the summits of two pyramids rising out of the middle of a lake. Near Illahun, Queen Sovkûnofriûri herself has left a few traces of her short reign.

The Fayûm, by its fertility and pleasant climate, justified the preference which the Pharaohs of the XIIth dynasty bestowed upon it. On emerging from the gorges



THE RUINED PEDESTAL OF ONE OF THE COLOSSI OF BIAHMÛ.¹

of Illahun, it opens out like a vast amphitheatre of cultivation, whose slopes descend towards the north till they reach the desolate waters of the Birket-Kerun. On the right and left, the amphitheatre is isolated from the surrounding mountains by two deep ravines, filled with willows, tamarisks, mimosas, and thorny acacias. Upon

¹ Drawn by Faucher-Gudin, after Major Brown.

the high ground, lands devoted to the culture of corn, durra, and flax, alternate with groves of palms and pomegranates, vineyards and gardens of olives, the latter being almost unknown elsewhere in Egypt. The slopes are covered with cultivated fields, irregularly terraced woods, and meadows enclosed by hedges, while lofty trees, clustered in some places and thinly scattered in others,



A VIEW IN THE FAYÛM IN THE NEIGHBOURHOOD OF THE VILLAGE OF FIDEMÎN.¹

rise in billowy masses of verdure one behind the other. Shodît [Shâdû] stood on a peninsula stretching out into a kind of natural reservoir, and was connected with the mainland by merely a narrow dyke; the water of the inundation flowed into this reservoir and was stored here during the autumn. Countless little rivulets escaped from it, not merely such canals and ditches as we meet with in the Nile Valley, but actual running brooks, coursing

¹ Drawn by Boudier, from a photograph by Goléuischeff.

and babbling between the trees, spreading out here and there into pools of water, and in places forming little cascades like those of our own streams, but dwindling in volume as they proceeded, owing to constant drains made

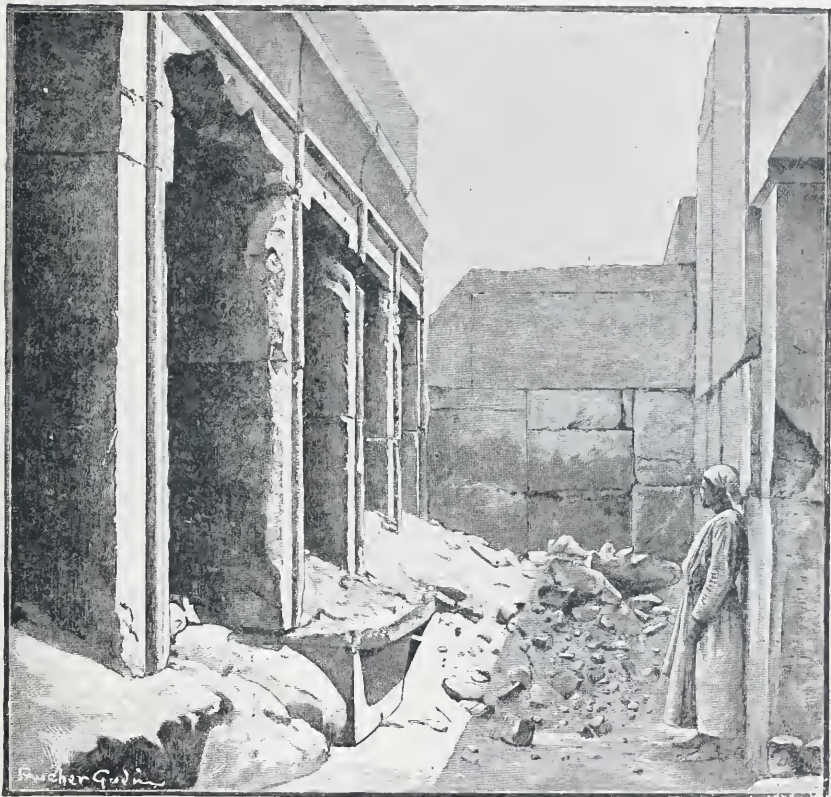

THE COURT OF THE SMALL TEMPLE TO THE NORTH OF THE BIRKET-KERUN.¹

on them, until they were for the most part absorbed by the soil before finally reaching the lake. They brought down in their course part of the fertilizing earth accumulated by the inundation, and were thus instrumental in

¹ Drawn by Faucher-Gudin, from a photograph by Major Brown.

raising the level of the soil. The water of the Birkeh rose or fell according to the season of the year. It formerly occupied a much larger area than it does at present, and half of the surrounding districts was covered by it. Its northern shores, now deserted and uncultivated, then shared in the benefits of the inundation, and supplied the means of existence for a civilized population. In many



THE SHORES OF THE BIRKET-KERUN NEAR THE EMOUCHURE OF THE WADY NAZLEH.¹

places we still find the remains of villages, and walls of uncemented stone; a small temple even has escaped the general ruin, and remains almost intact in the midst of the desolation, as if to point out the furthest limit of Egyptian territory. It bears no inscriptions, but the beauty of the materials of which it is composed, and the perfection of the work, lead us to attribute its construction

¹ Drawn by Boudier, from a photograph by Golénisheff.

to some prince of the XIIth dynasty. An ancient causeway runs from its entrance to what was probably at one time the original margin of the lake. The continual sinking of the level of the Birkeh has left this temple isolated on the edge of the Libyan plateau, and all life has retired from the surrounding district, and has concentrated itself



THE TWO PYRAMIDS OF THE XIITH DYNASTY AT LISHT.¹

on the southern shores of the lake. Here the banks are low and the bottom deepens almost imperceptibly. In winter the retreating waters leave exposed long patches of the shore, upon which a thin crust of snow-white salt is deposited, concealing the depths of mud and quicksands beneath. Immediately after the inundation, the lake regains in a few days the ground it had lost: it encroaches

¹ Drawn by Boudier, from a photograph by Émil Brugsch-Bey.

on the tamarisk bushes which fringe its banks, and the district is soon surrounded by a belt of marshy vegetation, affording cover for ducks, pelicans, wild geese, and a score of different kinds of birds which disport themselves there by the thousand. The Pharaohs, when tired of residing in cities, here found varied and refreshing scenery, an equable climate, gardens always gay with flowers, and in the thickets of the Kerun they could pursue their favourite pastimes of interminable fishing and of hunting with the boomerang.

They desired to repose after death among the scenes in which they had lived. Their tombs stretch from Heracleopolis till they nearly meet the last pyramids of the Memphites: at Dahshur there are still two of them standing. The northern one is an immense erection of brick, placed in close proximity to the truncated pyramid, but nearer than it to the edge of the plateau, so as to overlook the valley. We might be tempted to believe that the Theban kings, in choosing a site immediately to the south of the spot where Papi II. slept in his glory, were prompted by the desire to renew the traditions of the older dynasties prior to those of the Heracleopolitans, and thus proclaim to all beholders the antiquity of their lineage. One of their residences was situated at no great distance, near Miniet Dahshur, the city of Titoûi, the favourite residence of Amenemhât I. It was here that those royal princesses, Nofirhonît, Sonît-Sonbît, Sîthâthor, and Monît, his sisters, wives, and daughters, whose tombs lie opposite the northern face of the pyramid, flourished side by side with Amenemhât III. There, as of old in their harem,

they slept side by side, and, in spite of robbers, their mummies have preserved the ornaments with which they were adorned, on the eve of burial, by the pious act of their lords. The art of the ancient jewellers, which we have hitherto known only from pictures on the walls of tombs or on the boards of coffins, is here exhibited in all its cunning. The ornaments comprise a wealth of gold gorgets, necklaces of agate beads or of enamelled lotus-flowers, cornelian, amethyst, and onyx scarabs. Pectorals of pierced gold-work, inlaid with flakes of vitreous paste or precious stones, bear the cartouches of *Ûsirtasen III.* and of *Amenemhât II.*, and every one of these gems of art reveals a perfection of taste and a skilfulness of handling which are



PECTORAL ORNAMENT OF *ÛSIRTASEN III.*¹

perfectly wonderful. Their delicacy, and their freshness in spite of their antiquity, make it hard for us to realize that fifty centuries have elapsed since they were made. We are tempted to imagine that the royal ladies to whom they belonged must still be waiting within earshot, ready to reply to our summons as soon as we deign to call them; we may even anticipate the joy they will evince when these sumptuous ornaments are restored to them, and we need to glance at the worm-eaten coffins which contain their stiff and disfigured mummies to recall our imagination to the

¹ Drawn by Faucher-Gudin, from a photograph by *Émil Brugsch-Bey.*

stern reality of fact. Two other pyramids, but in this case of stone, still exist further south, to the left of the village of Lisht: their casing, torn off by the fellahîn, has entirely disappeared, and from a distance they appear to be merely two mounds which break the desert horizon line, rather than two buildings raised by the hand of man. The sepulchral chambers, excavated at a great depth in the sand, are now filled with water which has infiltrated



THE PYRAMID OF ILLAHUN, AT THE ENTRANCE OF THE FAYÛM.¹

through the soil, and they have not as yet been sufficiently emptied to permit of an entrance being effected: one of them contained the body of Ûsirtasen I.; does Amenemhât I. or Amenemhât II. repose in the other? We know, at all events, that Ûsirtasen II. built for himself the pyramid of Illahun, and Amenemhât III. that of Hawâra. "Hotpû," the tomb of Ûsirtasen II., stood upon a rocky hill at a distance of some two thousand feet from the cultivated lands. To the east of it lay a temple, and close

¹ Drawn by Faucher-Gudin, from a photograph by Golénischeff.

to the temple a town, Haît-Ûsirtasen-Hotpû—"the Castle of the Repose of Ûsirtasen"—which was inhabited by the workmen employed in building the pyramid, who resided there with their families. The remains of the temple consist of scarcely anything more than the enclosing wall, whose sides were originally faced with fine white limestone covered with hieroglyphs and sculptured scenes. It adjoined the wall of the town, and the neighbouring quarters are almost intact: the streets were straight, and crossed each other at right angles, while the houses on each side were so regularly built that a single policeman could keep his eye on each thoroughfare from one end to the other. The structures were of rough material hastily put together, and among the *débris* are to be found portions of older buildings, stelæ, and fragments of statues. The town began to dwindle after the Pharaoh had taken possession of his sepulchre; it was abandoned during the XIIIth dynasty, and its ruins were entombed in the sand which the wind heaped over them. The city which Amenembâit III. had connected with his tomb maintained, on the contrary, a long existence in the course of the centuries. The king's last resting-place consisted of a large sarcophagus of quartzose sandstone, while his favourite consort, Nofriuphtah, reposed beside him in a smaller coffin. The sepulchral chapel was very large, and its arrangements were of a somewhat complicated character. It consisted of a considerable number of chambers, some tolerably large, and others of moderate dimensions, while all of them were difficult of access and plunged in perpetual darkness: this was the Egyptian Labyrinth, to which the

Greeks, by a misconception, have given a world-wide renown. Amenemhât III. or his architects had no intention of building such a childish structure as that in which classical tradition so fervently believed. He had richly endowed the attendant priests, and bestowed upon the cult of his double considerable revenues, and the chambers above mentioned were so many storehouses for the safe-keeping of the treasure and provisions for the dead, and the arrangement of them was not more singular than that of ordinary storage depôts. As his cult persisted for a long period, the temple was maintained in good condition during a considerable time: it had not, perhaps, been abandoned when the Greeks first visited it.¹ The other sovereigns of the XIIth dynasty must have been interred not far from the tombs of Amenemhât III. and Ûsirtasen II.: they also had their pyramids, of which we may one day discover the site. The outline of these was almost the same as that of the Memphite pyramids, but the interior arrangements were different. As at Illahun and Dahshur, the mass of the work consisted of crude bricks of large size, between which fine sand was introduced to bind them solidly together, and the whole was covered with a facing of polished limestone. The passages and chambers are not arranged on the simple plan which we meet with in the pyramids of earlier date. Experience had taught the

¹ The identity of the ruins at Hawâra with the remains of the Labyrinth, admitted by Jomard-Caristie and by Lepsius, disputed by Vassali, has been definitely proved by Petrie, who found remains of the buildings erected by Amenemhât III. under the ruins of a village and some Græco-Roman tombs.

Pharaohs that neither granite walls nor the multiplication of barriers could preserve their mummies from profanation : no sooner was vigilance relaxed, either in the time of civil war or under a feeble administration, than robbers appeared on the scene, and boring passages through the masonry with the ingenuity of moles, they at length, after indefatigable patience, succeeded in reaching the sepulchral vault and despoiling the mummy of its valuables. With a



THE MOUNTAIN OF SÛT WITH THE TOMBS OF THE PRINCES.¹

view to further protection, the builders multiplied blind passages and chambers without apparent exit, but in which a portion of the ceiling was movable, and gave access to other equally mysterious rooms and corridors. Shafts sunk in the corners of the chambers and again carefully closed put the sacrilegious intruder on a false scent, for, after

¹ Drawn by Boudier, from a photograph by Émil Brugsch-Bey, taken in 1884.

causing him a great loss of time and labour, they only led down to the solid rock. At the present day the water of the Nile fills the central chamber of the Hawâra pyramid and covers the sarcophagus; it is possible that this was foreseen, and that the builders counted on the infiltration as an additional obstacle to depredations from without.¹ The hardness of the cement, which fastens the lid of the stone coffin to the lower part, protects the body from damp, and the Pharaoh, lying beneath several feet of water, still defies the greed of the robber or the zeal of the archæologist.

The absolute power of the kings kept their feudal vassals in check: far from being suppressed, however, the seignorial families continued not only to exist, but to enjoy continued prosperity. Everywhere, at Elephantinê, Koptos, Thinis, in Aphroditopolis, and in most of the cities of the Said and of the Delta, there were ruling princes who were descended from the old feudal lords or even from Pharaohs of the Memphite period, and who were of equal, if not superior rank, to the members of the reigning family. The princes of Siût no longer enjoyed an authority equal to that exercised by their ancestors under the Heracleopolitan dynasties, but they

¹ Indeed, it should be noted that in the Græco-Roman period the presence of water in a certain number of the pyramids was a matter of common knowledge, and so frequently was it met with, that it was even supposed to exist in a pyramid into which water had never penetrated, viz. that of Kheops. Herodotus relates that, according to the testimony of the interpreters who acted as his guides, the waters of the Nile were carried to the sepulchral cavern of the Pharaoh by a subterranean channel, and shut it in on all sides, like an island.

still possessed considerable influence. One of them, Hapizaûfi I., excavated for himself, in the reign of Ûsirtasen I., nor far from the burying-place of Khîti and Tefabi, that beautiful tomb, which, though partially destroyed by Coptic monks or Arabs, still attracts visitors



and excites their astonishment. The lords of Shashotpû in the south, and those of Hermopolis in the north, had acquired to some extent the ascendancy which their neighbours of Siût had lost. The Hermopolitan princes dated at least from the time of the VIth dynasty, and

they had passed safely through the troublous times which followed the death of Papi II. A branch of their family possessed the nome of the Hare, while another governed that of the Gazelle. The lords of the nome of the Hare espoused the Theban cause, and were reckoned among the most faithful vassals of the sovereigns of the south: one of them, Thothotpû, caused a statue of himself, worthy of a Pharaoh, to be erected in his loyal town of Hermopolis, and their burying-places at el-Bersheh bear witness to their power no less than to their taste in art. During the troubles which put an end to the XIth dynasty, a certain Khnûmhotpû, who was connected in some unknown manner with the lords of the nome of the Gazelle, entered the Theban service and accompanied Amenemhât I. on his campaigns into Nubia. He obtained, as a reward of faithfulness, Monâit-Khûfûi and the district of Khût-Horû,—“the Horizon of Horus,”—on the east bank of the Nile. On becoming possessed of the western bank also, he entrusted the government of the district which he was giving up to his eldest son, Nakhîti I.; but, the latter having died without heirs, Ûsirtasen I. granted to Biqît, the sister of Nakhîti, the rank and prerogative of a reigning princess. Biqît married Nûhri, one of the princes of Hermopolis, and brought with her as her dowry the fiefdom of the Gazelle, thus doubling the possessions of her husband's house. Khnûmhotpû II., the eldest of the children born of this union, was, while still young, appointed Governor of Monâit-Khûfûi, and this title appears to have become an appanage of his heir-apparent, just as the title of “Prince of Kaûshû” was, from the

XIXth dynasty onwards, the special designation of the heir to the throne. The marriage of Khnûmhotpû II. with the youthful Khîti, the heiress of the nome of the Jackal, rendered him master of one of the most fertile provinces of Middle Egypt. The power of this family was further augmented under Nakhîti II., son of Khnûmhotpû II. and Khîti: Nakhîti, prince of the nome of the Jackal in right of his mother, and lord of that of the Gazelle after the death of his father, received from Ûsirtasen II. the administration of fifteen southern nomes, from Aphroditopolis to Thebes. This is all we know of his history, but it is probable that his descendants retained the same power and position for several generations. The career of these dignitaries depended greatly on the Pharaohs with whom they were contemporary: they accompanied the royal troops on their campaigns, and with the spoil which they collected on such occasions they built temples or erected tombs for themselves. The tombs of the princes of the nome of the Gazelle are disposed along the right bank of the Nile, and the most ancient are exactly opposite Minieh. It is at Zawyet el-Meiyetîn and at Kom-el-Ahmar, nearly facing Hibonû, their capital, that we find the burying-places of those who lived under the VIth dynasty. The custom of taking the dead across the Nile had existed for centuries, from the time when the Egyptians first cut their tombs in the eastern range; it still continues to the present day, and part of the population of Minieh are now buried, year after year, in the places which their remote ancestors had chosen as the site of their "eternal houses." The

cemetery lies peacefully in the centre of the sandy plain at the foot of the hills; a grove of palms, like a curtain drawn along the river-side, partially conceals it; a Coptic convent and a few Mahommedan hermits attract around them the tombs of their respective followers, Christian or Mussulman. The rock-hewn tombs of the XIIth dynasty succeed each other in one long irregular line along the cliffs of Beni-Hasan, and the traveller on the Nile sees their entrances continuously coming into sight and disappearing as he goes up or descends the river. These tombs are entered by a square aperture, varying in height and width according to the size of the chapel. Two only, those of Amoni-Amenemhât and of Khnûm-hotpû II., have a columned façade, of which all the members—pillars, bases, entablatures—have been cut in the solid rock: the polygonal shafts of the façade look like a bad imitation of ancient Doric. Inclined planes or flights of steps, like those at Elephantinê, formerly led from the plain up to the terrace. Only a few traces of these exist at the present day, and the visitor has to climb the sandy slope as best he can: wherever he enters, the walls present to his view inscriptions of immense extent, as well as civil, sepulchral, military, and historical scenes. These are not incised like those of the Memphite mastabas, but are painted in fresco on the stone itself. The technical skill here exhibited is not a whit behind that of the older periods, and the general conception of the subjects has not altered since the time of the pyramid-building kings. The object is always the same, namely, to ensure wealth to the double in the other world, and to

enable him to preserve the same rank among the departed as he enjoyed among the living: hence sowing, reaping, cattle-rearing, the exercise of different trades, the preparation and bringing of offerings, are all represented with the same minuteness as formerly. But a new element has been added to the ancient themes. We



THE MODERN CEMETERY OF ZAWYET EL-MEIYETÎN.¹

know, and the experience of the past is continually reiterating the lesson, that the most careful precautions and the most conscientious observation of customs were not sufficient to perpetuate the worship of ancestors. The day was bound to come when not only the descendants of Khnûmhotpû, but a crowd of curious or indifferent

¹ Drawn by Boudier, from a photograph by Insinger.

strangers, would visit his tomb: he desired that they should know his genealogy, his private and public virtues, his famous deeds, his court titles and dignities, the extent of his wealth; and in order that no detail should be omitted, he relates all that he did, or he gives the representation of it upon the wall. In a long account of two hundred and twenty-two lines, he gives a *résumé* of his family history, introducing extracts from his archives, to show the favours received by his ancestors from the hands of their sovereigns. Amoni and Khiti, who were, it appears, the warriors of their race, have everywhere recounted the episodes of their military career, the movements of their troops, their hand-to-hand fights, and the fortresses to which they laid siege. These scions of the house of the Gazelle and of the Hare, who shared with Pharaoh himself the possession of the soil of Egypt, were no mere princely ciphers: they had a tenacious spirit, a warlike disposition, an insatiable desire for enlarging their borders, together with sufficient ability to realize their aims by court intrigues or advantageous marriage alliances. We can easily picture from their history what Egyptian feudalism really was, what were its component elements, what were the resources it had at its disposal, and we may well be astonished when we consider the power and tact which the Pharaohs must have displayed in keeping such vassals in check during two centuries.

Amenemhât I. had abandoned Thebes as a residence in favour of Heracleopolis and Memphis, and had made it over to some personage who probably belonged to the

royal household. The nome of \hat{U} isît had relapsed into the condition of a simple fief, and if we are as yet unable to establish the series of the princes who there succeeded each other contemporaneously with the Pharaohs, we at least know that all those whose names have come down to us played an important part in the history of their times. Montûnsîsû, whose stele was engraved in the XXIVth year of Amenemhât I., and who died in the joint reign of this Pharaoh and his son \hat{U} sirtasen I., had taken his share in most of the wars conducted against neighbouring peoples,—the Anitiû of Nubia, the Monitû of Sinai, and the “Lords of the Sands:” he had dismantled their cities and razed their fortresses. The principality retained no doubt the same boundaries which it had acquired under the first Antûfs, but Thebes itself grew daily larger, and gained in importance in proportion as its frontiers extended southward. It had become, after the conquests of \hat{U} sirtasen III., the very centre of the Egyptian world—a centre from which the power of the Pharaoh could equally well extend in a northerly direction towards the Sinaitic Peninsula and Libya, or towards the Red Sea and the “humiliated Kûsh” in the south. The influence of its lords increased accordingly: under Amenemhât III. and Amenemhât IV. they were perhaps the most powerful of the great vassals, and when the crown slipped from the grasp of the XIIth dynasty, it fell into the hands of one of these feudatories. It is not known how the transition was brought about which transferred the sovereignty from the elder to the younger branch of the family of Amenemhât I. When Amenemhât IV. died, his nearest heir was a woman, his

sister Sovkûnofriûrî: she retained the supreme authority for not quite four years,¹ and then resigned her position

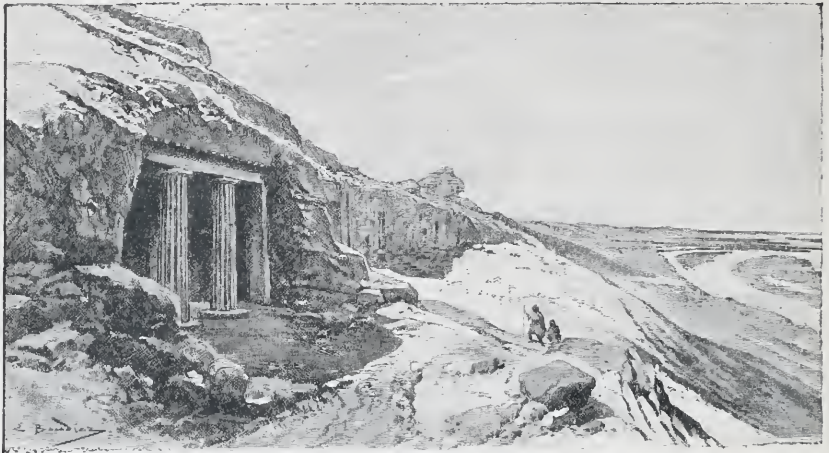

THE TOMBS OF PRINCES OF THE GAZELLE-NOME AT BENI-HASAN.²

to a certain Sovkhotpû.³ Was there a revolution in the

¹ She reigned exactly three years, ten months, and eighteen days, according to the fragments of the "Royal Canon of Turin" (LEPSIUS, *Auswahl der wichtigsten Urkunden*, pl. v. col. vii. l. 2).

² Drawn by Boudier, from a chromolithograph in LEPSIUS, *Denkm.*, i. pl. 61. The first tomb on the left, of which the portico is shown, is that of Khnûmhotpû II.

³ Sovkhotpû Khûtoûiri, according to the present published versions of the Turin Papyrus, an identification which led Lieblein (*Recherches sur la Chronologie Égyptienne*, pp. 102, 103) and Wiedemann to reject the generally accepted assumption that this first king of the XIIIth dynasty was Sovkhotpû Sakhemkhûtoûiri. Still, the way in which the monuments of Sovkhotpû Sakhemkhûtoûiri and his papyri are intermingled with the monuments of Amenemhât III. at Semneh and in the Fayûm, show that it is difficult to separate him from this monarch. Moreover, an examination of the original Turin Papyrus shows that there is a tear before the word *Khûtoûiri* on the first cartouche, no indication of which appears in the facsimile, but which has, none the less, slightly damaged the initial solar disk and removed almost the whole of one sign. We are, therefore, inclined to

palace, or a popular rising, or a civil war? Did the queen become the wife of the new sovereign, and thus bring about the change without a struggle? Sovkhotpû was probably lord of Ūisit, and the dynasty which he founded is given by the native historians as of Theban origin. His accession entailed no change in the Egyptian constitution; it merely consolidated the Theban supremacy, and gave it a recognized position. Thebes became henceforth the head of the entire country: doubtless the kings did not at once forsake Heracleopolis and the Fayûm, but they made merely passing visits to these royal residences at considerable intervals, and after a few generations even these were given up. Most of these sovereigns resided and built their Pyramids at Thebes, and the administration of the kingdom became centralized there. The actual capital of a king was determined not so much by the locality from whence he ruled, as by the place where he reposed after death. Thebes was the virtual capital of Egypt from the moment that its masters fixed on it as their burying-place.

Uncertainty again shrouds the history of the country after Sovkhotpû I.: not that monuments are lacking or names of kings, but the records of the many Sovkhotpûs and Nofirhotpûs found in a dozen places in the valley, furnish as yet no authentic means of ascertaining in what

believe that *Sakhemkhûtoûiri* was written instead of *Khûtoûiri*, and that, therefore, all the authorities are in the right, from their different points of view, and that the founder of the XIIIth dynasty was a Sakhemkhûtoûiri I., while the Savkhotpû Sakhemkhûtoûiri, who occupies the fifteenth place in the dynasty, was a Sakhemkhûtoûiri II.

order to classify them. The XIIIth dynasty contained, so it is said, sixty kings, who reigned for a period of over 453 years.¹ The succession did not always take place in the direct line from father to son: several times, when interrupted by default of male heirs, it was renewed without any disturbance, thanks to the transmission of royal rights to their children by princesses, even when their husbands did not belong to the reigning family. Monthotpû, the father of Sovkhotpû III., was an ordinary priest, and his name is constantly quoted by his son; but solar blood flowed in the veins of his mother, and procured for him the crown. The father of his successor, Nofirhotpû II., did not belong to the reigning branch, or was only distantly connected with it, but his mother Kamât was the daughter of Pharaoh, and that was sufficient to make her son of royal rank. With careful investigation, we should probably find traces of several revolutions which changed the legitimate order of succession without, however, entailing a change of dynasty. The Nofirhotpûs and Sovkhotpûs continued both at home and abroad the work so ably begun by the Amenemhâits and the Ûsirtasens. They devoted all their efforts to beautifying the principal towns of Egypt, and caused important

¹ This is the number given in one of the lists of Manetho, in MÜLLER-DIDOT, *Fragmenta Historicorum Græcorum*, vol. ii. p. 565. Lepsius's theory, according to which the shepherds overran Egypt from the end of the XIIth dynasty and tolerated the existence of two vassal dynasties, the XIIIth and XIVth, was disputed and refuted by E. de Rougé as soon as it appeared; we find the theory again in the works of some contemporary Egyptologists, but the majority of those who continued to support it have since abandoned their position.

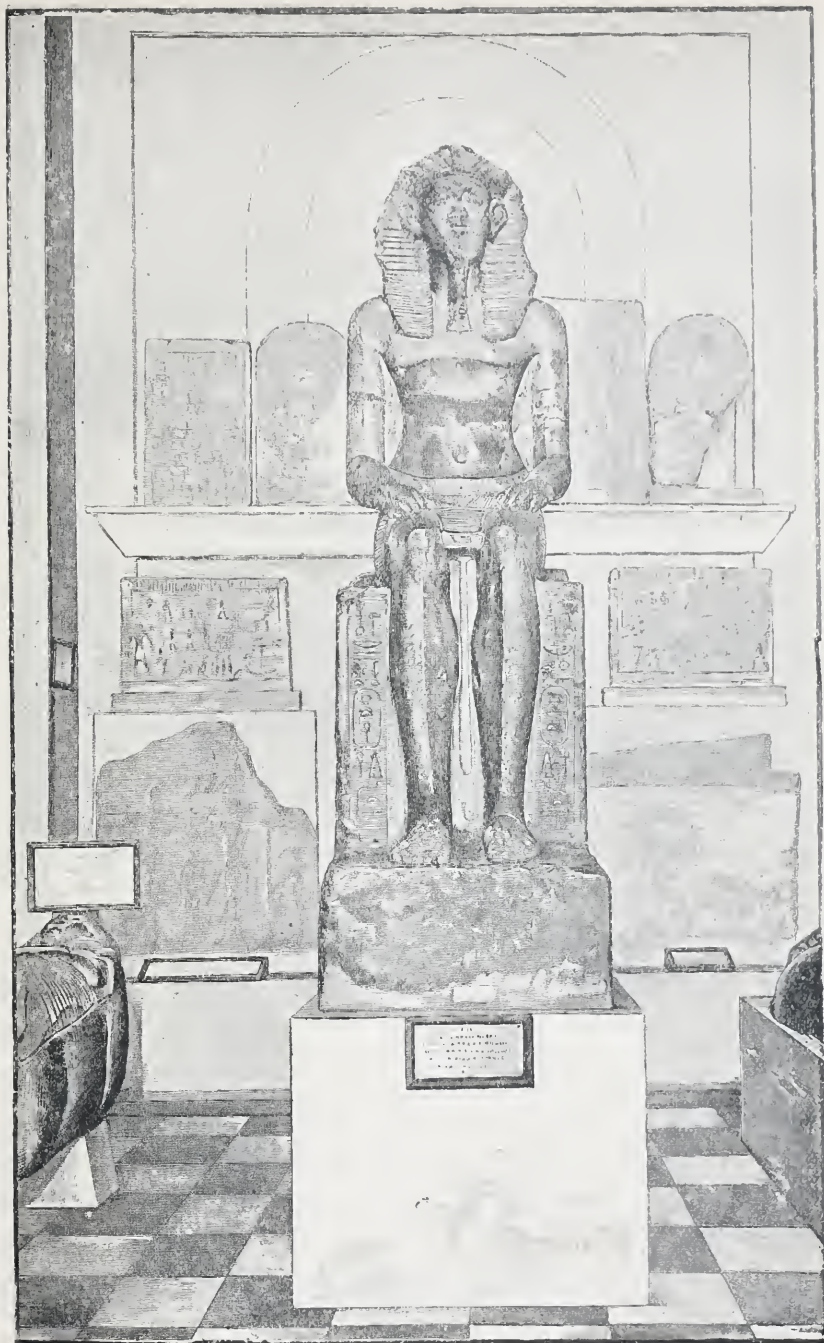

THE COLOSSAL STATUE OF KING SOVKHOTPÛ IN THE LOUVRE.

Drawn by Faucher-Gudin.

works to be carried on in most of them—at Karnak, in the great temple of Amon, at Luxor, at Bubastis, at Tanis, at Tell-Mokhdam, and in the sanctuary of Abydos. At the latter place, Khâsoshûshrî Nofirhotpû restored to Khontamentit considerable possessions which the god had lost; Nozirri sent thither one of his officers to restore the edifice built by Ûsirtasen I.; Sovkûmsaûf II. dedicated his own statue in this temple, and private individuals, following the example set them by their sovereigns, vied with each other in their gifts of votive stelæ. The pyramids of this period were of moderate size, and those princes who abandoned the custom of building them were content like Aûtûabrî I. Horû with a modest tomb, close to the gigantic pyramids of their ancestors. In style the statues of this epoch show a certain inferiority when compared with the beautiful work of the XIIth dynasty: the proportions of the human figure are not so good, the modelling of the limbs is not so vigorous, the rendering of the features lacks individuality; the sculptors exhibit a tendency, which had been growing since the time of the Ûsirtasens, to represent all their sitters with the same smiling, commonplace type of countenance. There are, however, among the statues of kings and private individuals which have come down to us, a few examples of really fine treatment. The colossal statue of Sovkhotpû IV., which is now in the Louvre side by side with an ordinary-sized figure of the same Pharaoh, must have had a good effect when placed at the entrance to the temple at Tanis: his chest is thrown well forward, his head is erect, and we feel impressed by that noble dignity which the Memphite

sculptors knew how to give to the bearing and features of the diorite Khephren enthroned at Gîzeh. The sitting Mirmâshaû of Tanis lacks neither energy nor majesty, and the Sovkûnsaûf of Abydos, in spite of the roughness of



STATUE OF HARSÛF IN THE
VIENNA MUSEUM.¹

its execution, decidedly holds its own among the other Pharaohs. The statuettes found in the tombs, and the smaller objects discovered in the ruins, are neither less carefully nor less successfully treated. The little scribe at Gîzeh, in the attitude of walking, is a *chef d'œuvre* of delicacy and grace, and might be attributed to one of the best schools of the XIIth dynasty, did not the inscriptions oblige us to relegate it to the Theban art of the XIIIth. The heavy and commonplace figure of the magnate now in the Vienna Museum is treated with a rather coarse realism, but exhibits nevertheless most skilful tooling. It is not exclusively at Thebes, or at Tanis, or in any of the other great cities of Egypt, that we meet with excellent

examples of work, or that we can prove that flourishing schools of sculpture existed at this period; probably there is scarcely any small town which would not furnish us at the present day, if careful excavation were carried out, with some monument or object worthy of being placed

¹ Drawn by Boudier, from a photograph by Ernest de Bergmann.

in a museum. During the XIIIth dynasty both art and everything else in Egypt were fairly prosperous. Nothing attained a very high standard, but, on the other hand, nothing fell below a certain level of respectable mediocrity. Wealth exercised, however, an injurious influence upon artistic taste. The funerary statue, for instance, which Aûtûabrî I. Horû ordered for himself was of ebony, and seems to have been inlaid originally with gold,¹ whereas Kheops and Khephren were content to have theirs of alabaster and diorite.

During this dynasty we hear nothing of the inhabitants of the Sinaitic Peninsula to the east, or of the Libyans to the west: it was in the south, in Ethiopia, that the Pharaohs expended all their surplus energy. The most important of them, Sovkhotpû I., had continued to register the height of the Nile on the rocks of Semneh, but after his time we are unable to say where the Nilometer was

STATUE OF SOVKHOTPÛ III.²

¹ From Dahshûr, now at Gîzeh; it has been published in Morgan's *Dahshûr*.

² Drawn by Boudier, from the sketch by Lepsius; the head was "quite mutilated and separated from the bust."

moved to, nor, indeed, who displaced it. The middle basin of the river as far as Gebel-Barkal was soon incorporated with Egypt, and the population became quickly assimilated. The colonization of the larger islands of Say and Argo took place first, as their isolation protected them from sudden attacks: certain princes of the XIIIth dynasty built temples there, and erected their statues within them, just as they would have done in any of the most peaceful districts of the Saïd or the Delta. Argo is still at the present day one of the largest of these Nubian islands: ¹ it is said to be 12½ miles in length, and about 2½ in width towards the middle. It is partly wooded, and vegetation grows there with tropical luxuriance; creeping plants climb from tree to tree, and form an almost impenetrable undergrowth, which swarms with game secure from the sportsman. A score of villages are dotted about in the clearings, and are surrounded by carefully cultivated fields, in which durra predominates. An unknown Pharaoh of the XIIIth dynasty built, near to the principal village, a temple of considerable size; it covered an area, whose limits may still easily be traced, of 174 feet wide by 292 long from east to west. The main body of the building was of sandstone, probably brought from the quarries of Tombos: it has been pitilessly destroyed piecemeal by the inhabitants, and only a few insignificant fragments, on which some lines of hieroglyphs may still be deciphered, remain *in situ*. A small statue of black granite of good workmanship is still standing in the midst of the ruins. It represents Sovkhotpû III. sitting,

¹ The description of Argo and its ruins is borrowed from CAILLAUD, *Voyage à Méroé*, vol. ii. pp. 1-7.

with his hands resting on his knees; the head, which has been mutilated, lies beside the body. The same king erected colossal statues of himself at Tanis, Bubastis, and at Thebes: he was undisputed master of the whole Nile Valley, from near the spot where the river receives its last tributary to where it empties itself into the sea. The

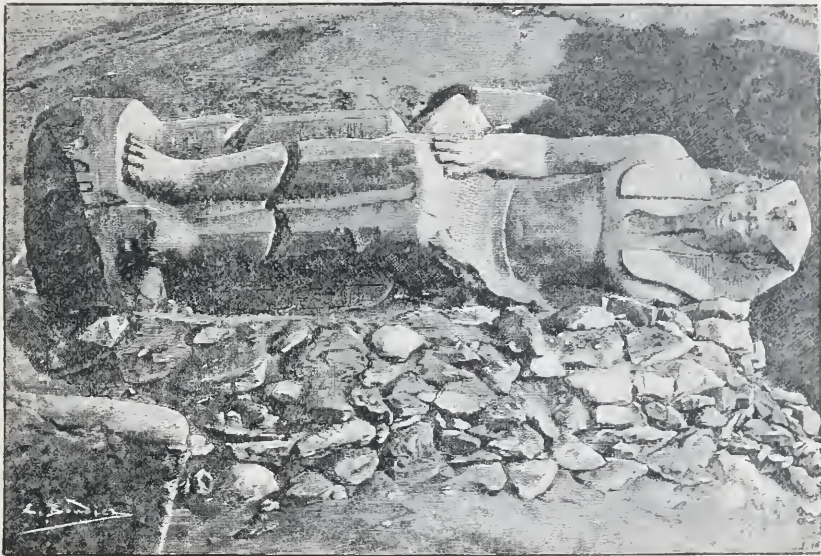

ONE OF THE OVERTURNED AND BROKEN STATUES OF MIRMASHAÛ AT TANIS.¹

making of Egypt was finally accomplished in his time, and if all its component parts were not as yet equally prosperous, the bond which connected them was strong enough to resist any attempt to break it, whether by civil discord within or invasions from without. The country was not free from revolutions, and if we have no authority for

¹ Drawn by Boudier, from the photograph in ROUGÉ-BANVILLE'S *Album photographique de la Mission de M. de Rougé*, No. 114.

stating that they were the cause of the downfall of the XIIIth dynasty, the lists of Manetho at least show that after that event the centre of Egyptian power was again shifted. Thebes lost its supremacy, and the preponderating influence passed into the hands of sovereigns who were natives of the Delta. Xoïs, situated in the midst of the marshes, between the Phatnitic and Sebennyitic branches of the Nile, was one of those very ancient cities which had played but an insignificant part in shaping the destinies of the country. By what combination of circumstances its princes succeeded in raising themselves to the throne of the Pharaohs, we know not: they numbered, so it was said, seventy-five kings, who reigned four hundred and eighty-four years, and whose mutilated names darken the pages of the Turin Papyrus. The majority of them did little more than appear upon the throne, some reigning three years, others two, others a year or scarcely more than a few months: far from being a regularly constituted line of sovereigns, they appear rather to have been a series of Pretenders, mutually jealous of and deposing one another. The feudal lords who had been so powerful under the *Ûsirtasens* had lost none of their prestige under the *Sovkhotpûs*: and the rivalries of usurpers of this kind, who seized the crown without being strong enough to keep it, may perhaps explain the long sequence of shadowy Pharaohs with curtailed reigns who constitute the XIVth dynasty. They did not withdraw from Nubia, of that fact we are certain: but what did they achieve in the north and north-east of the empire? The nomad tribes were showing signs of restlessness on the frontier, the peoples of the

Tigris and Euphrates were already pushing the vanguards of their armies into Central Syria. While Egypt had been bringing the valley of the Nile and the eastern corner of Africa into subjection, Chaldæa had imposed both her language and her laws upon the whole of that part of Western Asia which separated her from Egypt: the time was approaching when these two great civilized powers of the ancient world would meet each other face to face and come into fierce collision.



END OF VOL. II.

INDEX

A

Abhâit (Mahalla ?), 264
 Abousir (Abûsir), 205, 215
 Abû, 291
 Abydos, 85, 97, 219, 254, 262, 265, 290,
 301, 315, 413
 Adabehait, 363
 Adahait, 363
 Administrative officials, 59. *et seq.*, 68,
 96, 130, 233, 333
 "Adventures of Sinûhât," 329, 333
 Agriculture in Egypt, 127-131, 139-141
 Akafûhorû, 215
 Akhmim (Panopolis, — Ekhmim), 252,
 307, 316, 380
 Akhthoes (Khiti I.), 289, 299, 455
 Amamiû, 222, 260, 276, 281, 313, 339
 Amenemhât I., 298, 319-326, 339, 370-
 379, 394, 396, 406
 Amenemhât II., 325, 333, 357, 372, 395,
 396
 Amenemhât III., 325, 334, 344, 353, 358,
 374, 379, 388, 394-397, 407
 Amenemhât IV., 325, 336, 407
 Amentit (Amenti), 7
 Amîtsi, 259
 Ammiânshi, 332
 Amon, 340, 349, 380, 413
 Amoni-Amenemhât, 404
 Amten, 66-76
 Amû, 280
 Anat. *See* Anu
 Anitiû, 407
 Antâf I. (Antef), 307, 318
 Antâf II., 307
 Antâf III., 307, 314
 Antâf V., 320
 Anû, 252
 Anubis, 7, 13, 175, 277, 378
 Anûkît (Anuke), 273
 Anûpûmonkhû, 67
 Aphroditopolis Parva (Zobui), 307, 400
 Api, 78
 Apitu (Thebes), 309

Apollinopolis Magna. *See* Edfû
 Argo, 416
 Army, The Egyptian, 89-92, 304
 Ashmûnein. *See* Khimûnû
 Assi (Assa). *See* Dadkeri Assi
 Astronomy, Ancient Egyptian, 54
 Aswan (Syene), 252, 267, 274, 281, 313,
 345
 Asychis (Sasychis), 203
 Ati, 253, 292
 Atûmû (*see also* Tûmû), 46
 Aûnû of the North (Heliopolis), 306
 Aûnû of the South. *See* Hermonthis
 Aûtûabri I. Horû, 413, 415

B

Bahnesa, Oasis of, 277
 Bahr-Yûsuf, 295-298
 Bait (Bebit), 162
 "Banner," or "Ka Name," 25
 Barter, Methods of, 116-121
 Bastit, 375
 Baûka, 340
 Bayadiyeh, 380
 Bazaars, The, 116, *et seq.*
 Begig, 388
 Beni-Hasan, 304, 305, 327, 404
 Benuu. *See* Bonû
 Berenicê. *See* Nekhabit, Head of
 Bes. *See* Bisû
 Biahmû, 389
 Bikhères, 211
 Biqit, 402
 Birket-Kerum. *See* Mœris, Lake
 Bisû (Bes), 226
 Bohani, 349
 "Book of the Opening of the Mouth," 17
 "Book of the Dead," 227
 Bread, Early method of making, 112
 Bubastis, 175, 263, 375, 413, 417
 Building, Methods and styles of, 103. *et*
seq.
 Burial, Ancient Egyptian modes of, 170
 Busiris, 277

INDEX

C

Cataracts, The, 345
 Cereals of Egypt, 129
 Charms and spells, Ancient, 54, 55
 Cheops. *See* Khûfûi
 "Children of Ruin," 30
 Commerce, Maritime, 218, *et seq.*, 225
 Coptos. *See* Koptos
 Corvée, The, 131-140, 198, 199
 Costumes of the Egyptians, 31, 49
 Crocodilopodis. *See* Shodit
 Cultivation. *See* Agriculture
 Cusæ. *See* Kusit
 Cush (Kush). *See* Kaûshû

D

Dadkeri Assi, 215, 216, 226, 252
 Dadufri, 211
 Dahshûr, 167, 178, 205, 208, 321, 394, 398
 Dakhel, Oasis of, 277
 Dakkeh, 341
 Dangas, The, 226, 270, 278, 279
 Darfur, 354
 Dead. Festival of the, 113
 Denderah, 175, 263, 307
 Derr (Der), 340
 Didûn (Libyan god), 340
 "Divine Palace," The, 7
 "Domains of the Eternal House," 16
 Domestic implements, 109, *et seq.*
 Domestic life of Egyptians, 34, 108, *et seq.*
 Doshkeh, Temple at, 340
 Double, Legends of the, 16, *et seq.*, 25
 Drah abû'l-Neggah, 315
 Dush, Oasis of, 277
 Dynasties of Egypt, The, 211, 215, 252, 289, 308

E

Edfû (Apollinopolis Magna), (Tbû), 381
 Education and schools, 62, 64
 Eileithyiaopolis. *See* El-Kab
 Ekhumim. *See* Akhumim
 El-Arish, 152, 260
 El-Bersheh, 402
 El-Kab (Eileithyiaopolis, Nekhabit), 301, 306, 315, 381
 El-Kharbeh, 384
 Elephantinê, 252, 263, 265, 270, 274, 306, 307, 310, 314, 321, 341, 353, 361, 362, 382, 400
 Embalming, Process of, 172
 Exchange, Methods of. *See* Barter

F

Fakus, 350, 377
 Fellah, Status and life of the, 93, 102, 121, 124, 139-141, 146
 Festivals, Ancient Egyptian, 8, 113
 Feudal lords. *See* Nobility
 Funeral rites, Ancient, 10, 14, 18, 109, 227

G

Gaû, 310
 Gebel Geneffeh, 156
 Gebelên, 307, 315, 316
 Gizeh, 19, 177-179, 184, 414
 Gods of Egypt, 84
 Government, Officials of the, 59, *et seq.*, 68

H

Hahû, 357
 Hâit-Qait, 163, 164
 Hâit-Usirtasen Hotpû, 396
 Hanibu. *See* Haûi-nibû
 Hâpis (Apis), 176
 Hapizaûfi I., 401
 Hâpûnimâit, 74
 Harmâkhis, 3, 378
 Haroêris (Horus), 3, 22, 23, 38, 88, 161, 176, 256, 340, 349, 378
 Harshâfitû (Her-shafui), 298, 386
 Hâ-smonitû, 298
 Hâthor, 43, 115, 161, 162, 175, 263, 335
 Hâtnûb-û, 206, 262
 "Haûi-nibû" (Hanibu), 217, 218, 337
 Hawara, Pyramid of, 396-398
 Heliopolis (*see also* Aûnû of the North), 263, 377
 Heracleopolis Magna (Hininsû, Ahnas. or Henassieh), capital of nome of the Olander, 269, 290, 292, 296-300, 310-312, 385, 386, 394, 406, 409
 Heracleopolis Parva, 290
 Hermonthis (Aûnû of the South), 306, 380
 Hermopolis Magna. *See* Khmûnû
 Heru-sha. *See* Hirû-Shâitû
 Hfûit, 307
 Hibonû (Minieh), 403
 Hierakonpolis (Hibonû, Minieh), 381
 Hiqûit (Heqit), 213
 Hirkhûf, 269-280
 Hiru Khâkeri, 342, 352
 Hirû-Shâitû (Heru-sha), 154, 159, 259, 260, 268, 281, 327, 407
 "History of the Peasant," 96, 269
 "Horizon," The. *See* Khûit
 Horus (Haroêris), 3, 21, 23, 38, 88, 161, 176, 256, 340, 349, 378
 Hosi, 236

INDEX

“ House of Adoration,” 47
 “ House of Books,” 226
 House, The Eternal, 15, 16
 Household of the kings, 49, *et seq.*
 Hâ (Diospolis Parva), 307
 Hââ, District of, 358
 Hânû, 363
 Hypsele (Shashotpu), 401

I

Ibis, The, 79
 Illahun, 389, 396, 398
 Imhotep. *See* Imhotpû
 Imhotpû, 253
 Incantations, etc., 54, 55
 Iritit, 222, 259, 264, 275, 276, 278, 280,
 339
 Irrigation. *See* Agriculture in Egypt
 Isis, 40, 177, 213, 214, 250
 “ Island of the Double,” 366, *et seq.*

J

Justice, Administration of, 136, 137

K

Kaâpirû, 241
 Kaaû, 260
 Kadûma, 329
 Kahun, 104, 109
 Kakiû, 215
 Karnak, 85, 159, 380, 413
 Kasr-es-Sayad, 252, 307
 Kassa, 350
 Kaûshû (Kush), 354, 357, 402, 407
 “ Ka ” (*see* Double), 26
 Kha, The “ Rising,” 167
 Khâfrî, 22, 211
 Khâkerî (Hiru Khakeri), 342, 350
 Khartum, 354
 Khâsoshûshri Nofirhotpû, 413
 Kheops (*see also* Khûfûi), 37, 41, 172,
 174, 178, 186, 198, 200, 204, 208, 212,
 233, 250
 Khephren (Khafra, Khafri), 174, 186,
 188, 196, 198, 200, 204, 210, 373, 414
 Kheres, 215
 Khiti I. *See* Akhthoes
 Khiti II., 312
 Khmûnû (Hermopolis Magna), 305, 401
 Khnûmhotep. *See* Khnûmhotpû
 Khnûmhotpû I. (Khnûmhotep), 50, 320,
 328, 363, 402, 405
 Khnûmhotpû II., 403, 404
 Khnûmû (god of Elephantinê), 88, 213,
 214, 274, 299, 340
 Khontamentit (Khent-Amentî), 382
 Khonthanûnofir, 357
 Khûfûi (*see also* Kheops), 175, 211

Khûit, 179, 185, 207, 233, 241
 King, Functions and occupations of the,
 (*see also* Royal), 27, *et seq.*, 43, 83
 Kom-el-Ahmar, 403
 Konusit, 273
 Koptos (Qobt), 306, 307, 317
 Kordofan, 354
 Korosko, 221, 313, 339
 Kubbân, 341, 342, 344
 Kummeh, 350, 354
 Kûsit (Cusæ), 307

L

Labour corporations, 96
 Laws. *See* Justice
 Letopolis (Sokhem), 45, 263
 Libyans, The, 306, *et seq.*
 Lisht, Pyramids of, 393, 396
 “ Lords of the Sands.” *See* Hirû Shâtû
 Luxor, 380, 381, 413

M

Mâdût, 307
 Mafkait (Mafka), 162
 Magicians, The king’s 54
 Mahatta, Port of, 273
 Maskhonit, 213, 214
 Mastabas, 4-6, 9, 167, *et seq.*, 232
 “ Mastabat-el-Faraoun,” 5, 6, 254
 Matûga, 350
 Maût (Mût), 380
 Mâzaiû (Mâazeh), 222, 224, 260, 264,
 275, 313, 320, 339
 Measurements and surveys, 125, 126
 Medamut, 380
 Medicine, Early practice of, 54
 Medinet-el-Fayûm, 388
 Mêdûm, 167, 168, 172, 209
 Memphis (Minnofirû), 36, 48, 279, 292,
 405
 Mendes, 277
 Menes, 380
 Menkaûhorû (Menkheres, Dynasty V.),
 22, 215, 216, 252
 Menkaûri. *See* Mykerinos
 Menkheres (*see also* Mykerinos Dynasty
 IV.), 211, 215
 Menkheres (Dynasty V.) *See* Menkaû-
 horû
 Mentuhotep. *See* Monthotpû
 Metesouphis I. (Mihtimsaûf), 263, 264,
 275, 279, 281-289
 Metesouphis II., 285-289
 Miama, 340
 Mihi-fûrit, 202
 Mihtimsaûf. *See* Metesouphis
 Military service. *See* Army
 Min (God of Koptos). *See* Minû

INDEX

- Mines and miners at Sinai, 161, 262, 281, 333
 Minnofirâ. *See* Memphis
 Minû, 8, 306, 379
 Mirikari, 312
 Miriri-ônkhnas, 263
 Miriri Papi I. *See* Papi I.
 Mirisônkhû Meri-ankh, 170
 Mirmâshafû, 414
 Mirmiri Mihtimsaûf I. *See* Metesouphis I.
 Mirmiri Mihtimsaûf II. *See* Metesouphis II.
 Mirrûka, Tomb of, 11
 Mirtitfehsi, 41
 Mœris, Lake (Birket-Kerun), 296, 391, 393
 Monâit-Khûfûi, 320, 402
 Money in Egypt. *See* Tabnû
 Monitû, 161, 162, 172, 407
 Monthotpû I., 306, 318, 383, 410
 Monthotpû Nibtoûiri, 318
 Montu (Mentu), god of Hermonthis, 88, 307, 380, 381
 Montûnsisû, 407
 Mykerinos (Menkaûri), 174, 191-203, 211, 286
- Nahasit, 364
 Nakhiti I., 402
 Nakhiti II., 403
 Nârû Khoniti, 296
 Nârû Pahûi, 296
 Nefert. *See* Nofrit
 Nekhabit (Eileithyapolis, El-Kab), 362
 Nekhabit, Head of (Ras Banât), 268, 280, 362, 364
 Nephcheres, 215
 Nephthys, 176, 213
 Nibkaûri, 299
 Nibkhrôûri, 317
 Nibsonit, 67, 74
 Nile,
 Blue, 354
 Green, 217
 Inundations of the, 127, 139
 Rise of the, 127, 354
 White, 354
 Nile-gods, The (Hâpi and his two goddesses, Mirit Qimâit and Mirit Mihit; also Khnûmû, Osiris, Harshâfiû), 298
 Nilometer, The, 354, 415
 Nit, 43, 202
 Nitaûqrit. *See* Nitokris
 Nitokris (Rhodopis), 201, 285, 289, 291
 Nobility of Egypt, The, 76, *et seq.*, 136
 Nofir, 247
 Nofirhotpa II., 410
 Nofiririkeri, 215, 224
 Nofirkeri (title of several kings of Dynasties VII. and VIII.), 27, 291
 Nofirkeri Papi II. *See* Papi II.
 Nofirmâit, 173
 Nofirûs, 291
 Nofrit, 173, 372
 Nofriuptah, 397
 Nomes of Egypt, The, 71, 72, 76, 402
 Nomiû-Shâitû (Nemu-sha), 154
 Nû, Lake, 354
 Nûbkhopirri Antûf, 314
 Nûbri, 320, 402
 Nûit (Nut), 195
 Nût. *See* Nûit
 "Nutir hotpû," 82, *et seq.*
- O
- Oasis of Amon, 296
 Oasis, The Great (Uit, Uhat), (Oasis of El-Khargeh), 277, 314
 Obnos, 215
 Oleander (Narû), Nome of, 295, 299
 On. *See* Aûnû of the North
 "Opening of the Mouth," 17
 Osiris, 7, 13, 21, 32, 40, 96, 176, 195, 285, 299, 371, 382
 Othoes, 289
 Ousirkheres, 215
- P
- Pak-hit, 88
 Palaces of the kings, 45
 Panopolis (Apû). *See* Akhmim
 Papi I., 255, 256, 258, 262, 263, 265, 276, 282, 289, 292, 308
 Papi II., 279, 280, 281, 282, 289, 291, 292, 308, 333, 402
 Papi III. (Sonbû), 291
 Papinakhiti, 280, 281
 Pasht. *See* Bastit
 Pelusium, 156
 Pepi. *See* Papi
 Pharaoh, 21, 23, 25, 28-32
 Philæ, 273, 339, 345
 Phillitis, 200
 Phiops, 289
 Phios, 289
 Phtah, 32, 88, 176, 196, 377
 Phtahhotep. *See* Phtahhotpû
 "Phtahhotpû, The Proverbs of," 229, 230
 Pi-râ. *See* Heliopolis
 Pitaitiû, 330
 Pnûbsit, 340
 Priesthood, The Egyptian, 32, 40, 87, 88
 Pselcis, 340
 Pûanit, 224, 225, 268, 278, 279, 317, 354, 362, 364, 368

INDEX

Punt. *See* Puanit
 Pyramid of Kheops, the Great. *See* Khûit
 Pyramids, The, 167, 232, *et seq.*

Q

Qasr-es-Sayad, 252, 307
 Qonbitû, 48, 137
 Quarries of stone, The, 193, 205, 236, 262, 416
 Queen, Position and functions of the, 40, 41

R

Ra, 20-29, 38, 88, 213, 363, 377
 Râ-Harmakhis, 32
 Rahotep. *See* Rahotpû
 Râhotpû, 173, 241
 Ramses II., 170
 Ranofir, 172, 245
 Ras-Mohammed, 160
 Rathoures, 215
 Ratoises, 211
 Religious rites and ceremonies, 32, 33
 Remedies, Egyptian. *See* Medicine
 Rhodopis (Nitokris), 201, 286, 291
 Rohanû, 262, 363, 379
 Royal etiquette, 28, *et seq.*, 45, 53
 Royal family of Egypt, 38, 41
 Royal household, 47, *et seq.*
 Royal insignia, 28
 Rudîdidit, 213, 215

S

Sabu, Mastaba of, 6
 Sahûri, 214-216, 257, 308
 Saïd (Arabic name of Upper Egypt), 270, 400, 416
 Saïs, 202
 Samnînû-Kharp-Khakeri. *See* Semneh
 Sapi, 239
 Saqqâra, 19, 168, 183, 205, 208, 209, 229, 242, 253, 257, 264
 Sarbût-el-Khâdim, 333-336
 Satit (Sati), 273
 Saû (Kosseir), 362-364
 Scribe, Life and functions of the, 130, *et seq.*, 262
 Seb. *See* Sibû
 Sebek. *See* Sovkû (*or* Sobkhû)
 Sebek-hotep. *See* Sovkhotpû
 Seberkheres, 211
 Sehel, 264, 273
 Selkit, 176
 Semneh, 340, 352, 354, 415
 Sen, 215
 Sephres, 215

Serfs. *See* Slaves
 Shaad, 357
 Shashotpû (Hypsele), 401
 Shataûi, 340
 Shed. *See* Shodit
 Sheikh-el-Beled, 241
 Ships, Egyptian, 218, 219
 "Shipwrecked Sailor, Story of the," 365, *et seq.*
 Shodit, Shadû, *or* Shed (capital of the Fayûm), 298, 386, 387, 390
 Shonitiû, 48
 Shopsiskaf, 211, 212
 Shopsiskeri, 215
 Sibû (Seb), 195
 Si-Hathôr, 343
 Silsileh, Khenû, 221
 Sinai, 159, *et seq.*, 262, 280
 Simûhit and his adventures, 329, 333
 Siranpitû, 361
 Sisires, 215
 Sit, 30, 40
 Sitû, 276
 Siût (Siaût), 113, 277, 305, 308, 311, 320, 390, 400
 Slaves, Status and life of, 94-97, 121-124
 Snofrûi (Snefru), (Horû nib-mâit), 25, 37, 41, 67, 151, 156, 162, 168, 170, 172, 173, 174, 211, 308
 Sokhû, 176
 Sokhitiônkû, 257
 Sonkheri, 318, 363
 Soris, 211
 Soul, Ancient traditions of the, 10, 17
 Souphis I., 211
 Souphis II., 211
 Sovkhotpû I. (Sebek-hotep, *or* Serk-hotep), 408, 409, 415
 Sovkhotpû III., 409, 415
 Sovkhotpû IV., 413
 Sovkû, Sobkû (Sebek), 299, 386
 Sovkûmsaûf II., 413, 414
 Sovkûnofriûri, Queen, 389, 408
 Spells and Incantations, Ancient, 54, 55
 Speos Artemidos (Pakhit), 88
 Sphinx, The Great, 3, 33, 193, 231
 Storehouses, Government (Asûi), 59, 80
 Surveys and measurements, 125, 126
 Syene (Sûânit), 267, 273, 274, 281

T

"Tabnû" (money), 116
 Tamphthis, 211
 Tanis, 263, 357, 374, 375, 414-417
 Tankheres, 215
 Tâû, 364
 Taxes and their collection, 98, 127, 131, 136

INDEX

Tefabi, 312
 Tell-Mokhdam, 413
 Tell-Nebésbeh, 377
 Tenuu. *See* Tonu
 Teti I., 23
 Teti III., 254, 282, 289
 Thebes, 305, 362, 377, 406, 414 (map of, 309)
 Thisis, *or* This, 252, 277, 307, 400
 Thot, 54, 113, 175, 340
 Thoth. *See* Thot
 Thothotpû, 402
 Thutmosis III., 340
 Ti, The tomb of, 9, 14
 Tiba, 262
 Tihûnû, 337
 Timihû, 276, 337, 354
 Titouî, 321, 394
 Tombos, 416
 Tonû (Tenuu), 154, 330
 Tonûatamon, 33
 To-Shit, 296
 To-Shûit, 154
 To-Tamû, 260
 Troiu, 205, 257
 Tum. *See* Tûmû
 Tûmû (*see also* Atûmû), 35, 319
 Turah, 236, 257, 379
 Typhon, 26
 Typhonians. *See* Typhon

U

Uagait, 8, 113
 Uap-uaitû (Anubis), 311
 Uafûitû (Wawa), 222, 224, 260, 264, 275, 278, 280, 313, 317, 320, 339, 342
 Uîrû (Ur, pyramid of Khephren), 186
 Uisît, Nome of (Thebes), 306, 407, 409
 Uit (Uhat), the Great Oasis, 277

Unas, 215, 216, 224, 252, 254, 276, 282
 Uni, 253, 256, 259, 262, 264, 265, 279, 290, 314
 Uræus, The, 26, 31, 39
 Usirkaf (Usercheres), 215, 224
 Usirkeri, 22
 Usirniri Anû, 215, 308
 Usirtasen I., 322, 323, 343, 346, 358, 363, 371, 374, 375, 381, 383, 384, 388, 396, 401, 402, 413
 Usirtasen II., 325, 328, 357, 371, 396, 398
 Usirtasen III., 325, 340, 349, 352, 357, 358, 359, 375, 377, 386, 395

V

Votive offerings ("nutir hotpû"), 84, *et seq.*

W

Wady-el-Arish, 152, 260
 Wady Feirân, 160
 Wady Halfa, 268, 340, 345, 346
 Wady Hammamât, 206, 254, 317, 362, 386
 Wady Maghâra inscription, 175, 216
 Wady Maghâra mines, etc., 163, 336
 Wady Nazleh, 296
 Wady Tamieh, 296
 Wady Tumilât, 156
 Wawa. *See* Uafûitû
 "White Wall," The, 45
 Writers. *See* Scribe

Z

Zawyet el-Meiyyetin, 403
 Zorit, 307, 381
 Zosiri, 162, 168

DS
62
M373
v.2
cop.2

Maspero, (Sir) Gaston
Camille Charles
History of Egypt

PLEASE DO NOT REMOVE
CARDS OR SLIPS FROM THIS POCKET

UNIVERSITY OF TORONTO LIBRARY
