

*du Centaure*

*Plateforme d'observation*

*Temple disparu*

# LOST TECHNOLOGIES of ANCIENT EGYPT

Advanced Engineering  
in the Temples  
of the Pharaohs

CHRISTOPHER DUNN

LOST  
TECHNOLOGIES  
of  
ANCIENT  
EGYPT

---

“Christopher Dunn is an expert in his field. He knows a great deal about stone-cutting tools and has spent many years studying the ancient Egyptian monuments, sculptures, and artifacts. His findings are revolutionary. His word carries weight. If he is right, our perception of who the ancient Egyptians were may completely change. Read this book!”

ROBERT BAUVAL, AUTHOR OF *THE ORION MYSTERY*,  
*MESSAGE OF THE SPHINX* AND *THE EGYPT CODE*

“Christopher Dunn’s painstaking work, literally, makes the ‘stones’ of the Egyptian gods speak. He provides profound archaeological evidence that shows an engineering consistency, suggesting an advanced intelligence, which understood the supreme science of sacred geometry. A must-read book for those who wish to understand the advancement of Egyptology in the world of today.”

J. J. HURTAK, PH.D., AUTHOR OF  
*THE BOOK OF KNOWLEDGE: THE KEYS OF ENOCH*

“Utilizing almost 50 years of professional experience in engineering, manufacturing, tool-making, and space-age precision, Chris Dunn has provided an in-depth analysis of ancient Egyptian statuary, temples, and manufactured artifacts that has never been presented previously. This outstanding book, supremely well researched, amply illustrated, and complete with detailed photographs, will be cited as a major paradigm shift and reference source in the field for many years to come.”

STEPHEN S. MEHLER, M.A., DIRECTOR OF RESEARCH,  
GREAT PYRAMID OF GIZA RESEARCH ASSOCIATION

“Admirers of Egyptian art and architecture are most fortunate that Christopher Dunn directs his experienced engineer’s eye toward the Egyptians’ ancient stonework. By noticing the most minute details he reveals sophisticated craftsmanship and immense significance for all areas of Egyptology. Mathematicians will appreciate the amazing three-dimensional geometry made manifest in very hard stone. Dunn points the way for geometers to uncover sharper, more accurate analyses of the proportions of Egyptian design. This book is an important contribution to scientific scholarship by showing how archaeology can firmly rest on a measurable foundation.”

MICHAEL S. SCHNEIDER, AUTHOR OF  
*A BEGINNER’S GUIDE TO CONSTRUCTING THE UNIVERSE*

“In this book, Christopher Dunn has brought to the field of Egyptology a new approach, which has been needed for decades. His ability as an engineer and master craftsman has given him the insight to discover ancient technologies and techniques that have been missed by traditional Egyptologists. This book is a paradigm change for the way of thinking about our ancient history and ancestors. I highly recommend this beautiful illustrated book to both academic and alternative researchers and for anyone interested in new ways of thinking about our ancient past.”

JOHN DESALVO, PH.D., AUTHOR OF  
*THE LOST ART OF ENOCHIAN MAGIC*  
AND DIRECTOR OF THE GREAT PYRAMID OF GIZA RESEARCH ASSOCIATION

“As with Newton and the apple, Chris Dunn got a vision when visiting Egypt. His engineering background allowed him to unleash incredible facts, and thanks to this highly detailed book, we can now share the same marvels.”

ALAIN HUBRECHT, ARCHITECT, WRITER, PROFESSOR, AND  
FOUNDER OF THE ASSOCIATION TRANSPERSONNELLE BELGE (ATB)

“If you want to see the precise high technologies ancient Egyptians really had, read this book. It is a serious donation to Egyptian legacy and an opus for the future of this planet.”

ANTOINE GIGAL, AUTHOR, RESEARCHER,  
AND PRESIDENT OF GIZA FOR HUMANITY

“I believe, as Chris Dunn superbly details in this book, that ancient Egyptian sculptors and architects were so precise and their works so monumental that they must have used sophisticated technology, probably hidden in their time and now lost to ours.”

MIKE LECKIE, STONE SCULPTOR



# LOST TECHNOLOGIES of ANCIENT EGYPT

**Advanced Engineering in the  
Temples of the Pharaohs**

CHRISTOPHER DUNN



Bear & Company  
Rochester, Vermont • Toronto, Canada

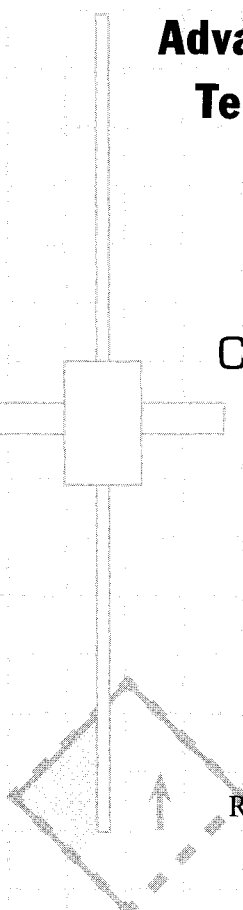

Bear & Company  
One Park Street  
Rochester, Vermont 05767  
www.BearandCompanyBooks.com



Text paper is SFI certified

Bear & Company is a division of Inner Traditions International

Copyright © 2010 by Christopher Dunn

All rights reserved. No part of this book may be reproduced or utilized in any form or by any means, electronic or mechanical, including photocopying, recording, or by any information storage and retrieval system, without permission in writing from the publisher.

### Library of Congress Cataloging-in-Publication Data

Dunn, Christopher, 1946–

Lost technologies of ancient Egypt : advanced engineering in the temples of the pharaohs / Christopher Dunn.

p. cm.

Includes bibliographical references and index.

Summary: "A unique study of the engineering and tools used to create Egyptian monuments"—Provided by publisher.

ISBN 978-1-59143-102-2 (pbk.)

1. Egypt—Civilization—To 332 B.C. 2. Engineering—Egypt—History—To 1500. 3. Technology—Egypt—History—To 1500. 4. Pyramids—Egypt—Design and construction. 5. Temples—Egypt—Design and construction. 6. Monuments—Egypt—Design and construction. I. Title.

DT61.D86 2010

932—dc22

2010011609

Printed and bound in the United States by Lake Book Manufacturing

The text paper is 100% SFI certified. The Sustainable Forestry Initiative® program promotes sustainable forest management.

10 9 8 7 6 5 4 3 2 1

Text design by Jon Desautels and layout by Priscilla Baker

This book was typeset in Garamond Premier Pro with Eurostile and Gill Sans used as display typefaces

To send correspondence to the author of this book, mail a first-class letter to the author c/o Inner Traditions • Bear & Company, One Park Street, Rochester, VT 05767, and we will forward the communication or contact the author at [www.gizapower.com](http://www.gizapower.com).

*To the Egyptians and their  
glorious heritage*



# Contents

Foreword: Shifting Paradigms  
by Arlan Andrews Sr., ScD ix

Foreword: Recognizing the Brilliance of  
Ancient Manufacturing by Judd C. Peck, Esq. xvi

Photographic Credits xxii

Acknowledgments xxiii

Introduction 1

**ONE** The Shadows of Luxor 8

**TWO** The Shadows of Ramses 40

**THREE** The Ramses Challenge 68

**FOUR** The Shadows of Karnak 93

**FIVE** The Shadows of the Serapeum 113

**SIX** The Shadow of the Sphinx 137

**SEVEN** The Shadows of Denderah 168

**EIGHT** Sticks and Stones: Tools of the Trade 197

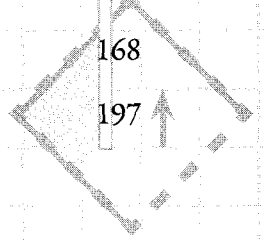



NINE	In the Shadow of an Obelisk	205
TEN	In the Shadow of Egyptian Megamachines	247
ELEVEN	Walking in the Shadow of William F. Petrie	290
TWELVE	Suspending Disbelief	325
	Notes	340
	Selected Bibliography	346
	Index	349

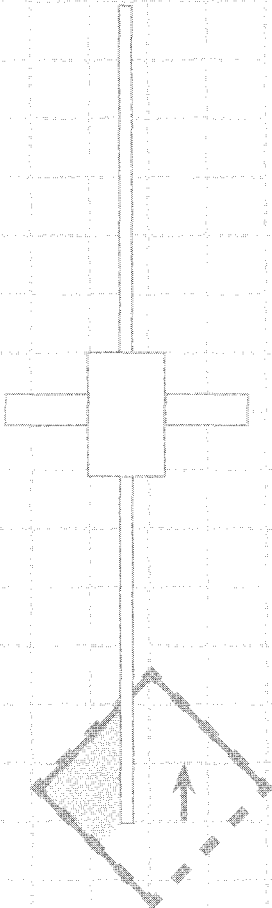



## FOREWORD

# Shifting Paradigms

In the mid-1990s I was co-founder of a NASDAQ-listed software company in Albuquerque, New Mexico, which specialized in presenting digital data in a unique 3D immersive graphical environment (also called virtual reality, or VR). One particular time, we showed the results of our VR work to an undersecretary of the US Department of Transportation—an abstract presentation of rather mundane DOT traffic data from various road intersections around the nation. Because of the intuitive display system, without any interpretation training at all, the undersecretary was able to see patterns, anomalies, and trends in his data, striking evidence of unexpectedly massive distortions and errors, perhaps even fraud, resident in his measurements but unseen before.

So shocked was the bureaucrat that he told the audience of several hundred technophiles, “I will never be able to look at my new data the same way again. Not only that, I won’t even be able to look at my old data the same way.” From this honest and open spontaneous reaction, I coined the saying, “A paradigm shift not only changes the future, it changes the past!”

What researcher Christopher Dunn has accomplished in *Lost Technologies of Ancient Egypt* and in his previous work, *The Giza Power Plant*, is more than a paradigm shift; it is more of a paradigm seismic event. Because once a person with a manufacturing or machining background—engineer, technician, machinist, artisan—reads and understands what Dunn has discovered and analyzed in ancient Egyptian

stonework, that person will never look at ancient Egyptians the same way ever again. That reader will become skeptical of portrayals of ancient Egyptians as primitives in any sense. That reader will begin to analyze every new Egyptian archaeological discovery, to see what else conventional Egyptologists have overlooked. That reader will become part of the new paradigm.

In these pages, Chris Dunn demonstrates an underlying system of incredible precision in the machining, layout, and positioning of both individual objects and groups of features, ranging from the toolmark details in the “Rose Red Rosetta Stone of Abu Roash” to the symmetries of the giant heads of Ramses at the temples in Luxor, to the layout of the column capitals of the Great Hypostyle Hall at Denderah, to the base of the Great Pyramid itself. Thanks to this work, the modern reader sits back in awe and admiration of the Egyptian geniuses of five thousand years ago. The ancient artifacts contain amazing messages, but the stones cannot speak for themselves. This book speaks for them.

In November 2008, I accompanied Mr. Dunn and others to what some have called “the Lost Pyramid” at Abu Roash, some ten kilometers northwest of Giza. I was anxious to see the rose-colored granite piece that the author had described to me years before, anticipating seeing the compound radial cuts and distinguishing toolmarks. I was not disappointed. To any technophile, this one cut stone exhibits mute arguments against primitive tools and primitive peoples. More than any other artifact, it embodies an ancient “language” that still speaks to modern engineers. I immediately dubbed it the “Rose Red Rosetta Stone of Abu Roash.”

I called the stone a “Rosetta” because its discovery reminded me of another paradigm-changing artifact: in 1799, Napoleon’s soldiers found a curious object embedded in a wall of an Egyptian village. Their original report, “A Report on a Stone Found in the Village of Rosetta,” describes a black rock slab inscribed with three languages, one of them being ancient Greek, the others the unknown Egyptian hieroglyphic writing and the cursive or “demotic” Egyptian writing. Reading the Greek portion, the antiquarian Champollion was able to translate

the names of the Pharaohs—written within cartouches—and thence the rest of the hieroglyphic writing itself. He opened up an eventual understanding of the millions of carved figures decorating the ancient temples and tombs of the Nile. Nobody would ever again look at the hieroglyphic carvings as mere magical, mystical figures, but would read the translations of experts who deciphered those cuts and reliefs, uncovering the lost history of Egypt.

The Rosetta stone thus facilitated a change in the worldview of moderns who looked back at ancient Egyptians. Nothing would ever be the same. I maintain that this book has accomplished a similar feat, every bit as meaningful to an understanding of ancient Egypt, if not more so. Once understood, Dunn's discoveries will forever change the perception of the serious researcher.

In a similar manner to Champollion reading ancient Greek and comparing it to the unknown hieroglyphic figures, researcher Christopher Dunn was able to “read” the machine-cut tool marks on the Abu Roash stone and compare them to those made by modern tools capable of the same operations. With years of experience and a trained eye for such details, and armed with the proper paradigmatic perspective, Dunn was able to recognize at once what it meant to produce a stone with a curved cut some 37 feet in diameter, and to reproduce that cut in small, uniform steps across a three-foot width—over 700 nearly identical radial tool cuts! This feat is simply not achievable by human hand alone, using any known tools.

Such toolmarks require at the very least a large saw blade or cutting tool, and sophisticated fixtures to produce the steps between cuts. To suggest that the primitive tools ascribed to the ancient Egyptians could have produced anything like these markings is ridiculous. In my opinion, this machined stone by itself demonstrates the existence of sophisticated tooling that did not exist again until the 1900s.

To the modern engineer, machinist, or toolmaker, the toolmarks on the Rose Red Rosetta Stone of Abu Roash are proof enough that the ancient Egyptians possessed technologies not replicated until the twentieth century—if even then. But *Lost Technologies of Ancient Egypt*

shows more examples, each of which have similar impact—the Ramses heads in Luxor, the carvings and columns at Denderah—further reinforcing the genius of the ancient machinists, engineers, designers, and planners. Taken together, they represent arguments in stone that refute current Egyptological conclusions.

When civilization fails for any reason, metals of all kinds become precious commodities. They become knives, spear points, scrapers, fish-hooks, even plows. Ancient Egypt underwent numerous upheavals caused by droughts, earthquakes, civil wars, religious strife, and foreign invasions. During the times of collapse, the advanced metal tools that the ancient Egyptians used were probably disassembled, cut apart, or melted down. What wasn't immediately used would corrode and disappear after thousands of years. And perhaps some other advanced technology was also employed, the remnants of which we wouldn't recognize today.

Large saw blades and other machine tools, if not secreted away from armies, earthquakes, floods, and mobs, would not endure very long. Over the millennia, few metal objects from our own time would survive or be recognizable. *Life After People*, a popular cable television show that debuted in 2009, shows example after example of the deterioration of manmade objects after years, merely because of lack of maintenance. In five thousand years, approximately the timespan estimated in *Lost Technologies of Ancient Egypt*, almost nothing of today's technology would be left. In a world of resourceful (and destructive) human beings, the devastation would be much worse than Mother Nature alone could cause; marauding bandits and nomads would re-use, recycle, or otherwise destroy even our ubiquitous automobile engine blocks and our porcelain toilet bowls!

It may be that future archaeologists will one day uncover an untouched ancient factory or workshop under the sands or in the caves of Egypt, a place that was purposefully hidden away from destructive recycling, a place that would show us exactly what the ancients used and how. Such a discovery would be the equivalent of the unexpectedly sophisticated two-thousand-year-old Greek computational mechanism, the Antikythera Device! But to recognize their finds as evidence

of ancient technologies, those future discoverers must have minds that are opened to the possibilities that Christopher Dunn has been the first to reveal. Otherwise, that advanced machine shop of the ancients could wind up stored in unnumbered boxes in the basement of the Egyptian Museum in Cairo, labeled merely as “funerary objects.”

Recent discoveries at the archaeological site Göbekli Tepe, in Turkey, indicate that twelve thousand to thirteen thousand years ago, so-called primitives were erecting T-shaped monuments as tall as six meters, ranging in weight from ten to fifty tons, perhaps building a Neolithic cathedral of sorts. Many of these stone pillars exhibit carvings of wildlife and even some human-shaped reliefs. For unknown reasons, the site was deliberately buried approximately ten thousand years ago. Because this site can be dated as existing prior to previously established dates for the beginnings of agriculture and urbanization, not to mention cooperative construction of stone monuments, we can readily believe that conventional chronology is at the least incomplete, if not wholly inaccurate. We see that every new archaeological discovery pushes back civilized development further and further into the past, never in the opposite direction.

So here we have evidence of moving massive stones and carving them in intricate detail dating earlier than 10,000 BCE—thousands of years before the ancient Egyptians were believed to have begun the stone machining that the author examines in this volume and in his previous works. Several thousand years passed between the time of Göbekli Tepe and that of the Egyptian First Dynasty, millennia in which artisans and engineers of ancient times could have perfected their craft, invented their complete suite of enabling tools and supportive technologies, and eventually emigrated to the Nile Valley, becoming part of the incipient civilization emerging there. With centuries of experiment and practice, those who worked in stone could have kept their knowledge secret, offering their finished products to leaders, priests, and the wealthy. As Dunn points out in this volume, even today trade secrets and proprietary knowledge are closely held, even in an educated worldwide civilization with widespread literacy and training. In ancient times

the impulse to secrecy may have been even more necessary for survival.

Alas, the human beings who worked the Rose Red Rosetta Stone of Abu Roash, who machined the statues of Ramses, the columns of Denderah and the stones of the pyramids, were more fragile and evanescent than the mighty tools they employed in their work. If tools of metal are lost in war or natural catastrophe, their flesh and blood designers and operators are even more subject to the vagaries of Fate—disease, injury, wounds, and famine can take away technicians, inventors, planners, and managers, while leaving behind marvelous tools fit only for destruction by desperate people ignorant of their value.

If the knowledge of a specific task, the operation of a given machine tool, or the procedure for laying out vast projects is resident in just a few people, maybe just one, then the loss of that person or group means the knowledge is gone forever, unless it is recorded. This is an eternal problem, not limited to the ancient Egyptians of five thousand years ago. As a modern example, in 1992 while working at the White House Science Office, I invited to a meeting there a person from the National Science Foundation. Although only peripheral to the agenda, this older scientist regaled us with a tale of a lost technology of modern times, namely how to start up the engines of the Saturn V rocket that took American astronauts to the Moon from 1969 to 1972. Incredibly, this leading scientist averred that no one was alive who knew how to start up the engines on the largest rocket ever flown. No one had written down the standard operating procedure, and the rocket men who had developed the technique had all passed away.

So in 1992 CE or 1992 BCE or further back in time, we can find sufficient examples to demonstrate that technologies are not always lost as a result of conspiracy. Ordinary human pride, greed, stubbornness, selfishness, and even carelessness, can account for much of our loss.

In two groundbreaking works, author Christopher Dunn has opened our eyes that ancient Egyptians, and maybe others in the past, designed, planned, laid out, and precisely machined stone statues that would be difficult to reproduce even with today's manufacturing technologies. As the first person to uncover and develop this new paradigm, he has

gone on to investigate other ancient Egyptian artifacts, temples, tombs, and pyramids using this new way of looking at information. He has retrieved knowledge that all before him have overlooked, save Flinders Petrie, whose interest was not primarily proving advanced ancient technology, merely commenting upon interesting findings. A new way of looking at old data could bring new respect to ancient civilizations that left magnificent ruins in a still-troubled part of the world. As we understand more about the origin of Egyptian temples and pyramids, we find a way to bridge the past and the present, a way to look for still other revelations that affect us as human beings.

ARLAN ANDREWS SR., SCD

Arlan Andrews Sr., a registered Professional Engineer, graduated from New Mexico State University with a doctorate in mechanical engineering. Throughout his career he worked as a missile tracker at White Sands Missile Range, as a member of technical staff at Bell Telephone Laboratories, as the advanced manufacturing initiatives manager at Sandia National Laboratory, and as the environmental director at the Naval Air Station, Corpus Christi, Texas. In 1991, Dr. Andrews was assigned to the Technology Administration of the U.S. Department of Commerce as a Fellow for the American Society of Mechanical Engineers (ASME). Following his tenure there, he became an ASME Fellow at the White House Science Office. He later co-founded several high-tech startup companies, one of which was listed on NASDAQ and another still operating in North Carolina. He also founded the nonprofit futurist organization SIGMA, a group of professional scientists and science fiction writers formed to advise the Federal Government on future technologies and events.





FOREWORD

# Recognizing the Brilliance of Ancient Manufacturing

*No one can be a great thinker who does not recognize that as a thinker it is his first duty to follow his intellect to whatever conclusions it may lead. Truth gains more even by the errors of one who, with due study, and preparation, thinks for himself, than by the true opinions of those who only hold them because they do not suffer themselves to think.*

JOHN STUART MILL, *ON LIBERTY*

As a lawyer trained in the areas of evidence and the nature of proof, I have witnessed firsthand the disagreements that occur in the arena of ideas. Sometimes these disagreements make their way into a courtroom, where a trial is held and a judgment made as to which opinion carries the weight of evidence—evidence that ultimately convinces a judge and jury. The court reaches a decision in favor of the party or parties that presented that convincing evidence.

Over the course of this book, Chris Dunn presents evidence that raises a multitude of challenging questions, introducing new ideas and

opinions about the history of craftsmanship in Egypt. This work calls into question established paradigms and theories that have, for many decades, formed the basis of academic studies in schools and universities around the globe and in volumes that occupy the shelves of virtually every library. But first, let me describe how I came to be involved in this debate.

Leaving the formal practice of law in the late 1980s, I have, in the ensuing two decades, become a manufacturer, more specifically a fabricator of sheet metal components for gas turbine engines at Danville Metal Stamping Co., Inc., located in Danville, Illinois, USA. It was here that I first met Dunn, upon my arrival at Danville Metal in 1988. He preceded me at the company by a couple of years and was then serving in the capacity of laser engineer. He later became a manufacturing engineer and, in 1995, brought his manufacturing and engineering skills, as well as his judgment and insight, to the post of Human Resources Manager. As President and CEO, I devote a significant amount of time to human resources and, consequently, my contact with Dunn increased dramatically.

At that time, I had little background or particular interest in Egypt, the pyramids, or ancient technologies and civilizations. Nonetheless, like most humans, I had a natural curiosity about how things are made or done and why. My curiosity then turned toward the subject that Dunn had spent the past twenty years studying in his spare time, and I was impressed by the enthusiasm and sense of wonder he had for it.

Over breakfast after a Sunday walk, Dunn would discuss his thoughts on ancient technologies. Those discussions were often supplemented by a photograph or other visual aid, such as an engineering drawing or a sketch on a napkin or scrap of paper. We would also discuss the online controversies that swirled around his comments, theories, and questions raised in his first book, *The Giza Power Plant*. Dunn's analysis did not stop there; he instead applied the criticism he received to improve his methods and collect further evidence.

In February of 2006, Dunn took another of his many trips to Egypt, this time with a tour group that visited a number of temples in Upper

Egypt. Although he had first visited those temples in 2004, his exposure had been brief and he was interested in more closely inspecting temple artifacts, especially in the Luxor Temple. This new expedition took Dunn deeper into and beyond the issues he had explored previously. He returned from the trip with a new and elevated interest in the accomplishments of the ancient Egyptians in the temples, particularly the statuary. His observations in the temples presented a new frontier of amazing feats, raising questions that were complementary to observations he had made in connection with granite boxes and other aspects of construction in the pyramids.

In April and May of the same year, I took the opportunity to travel with Dunn to witness in person what I had only examined as photographic evidence. This included many looks through the viewfinder of his camera equipped with a telephoto lens and then verifying the results captured by the camera.

From personal observation, I can verify that in this book Dunn has been true to the evidence he observed. As an engineer, Dunn was able to analyze his observations with CAD/CAM programs and geometrical analysis unavailable or incomprehensible to the average observer. Among other things, with advances in digital imaging, a technology used daily in manufacturing, his computer-assisted analysis afforded him the ability to see attributes that could not be seen or analyzed with the naked eye even in the presence of the original artifact.

Using his extensive skills and his tools as an engineer and a toolmaker and bringing to bear his decades of experience in manufacturing, Dunn was relentless in assessing what he could reach and, through his camera lenses, preserving that which he saw. He also used his camera to capture what he could not necessarily reach and was thoughtful and creative in his approach. As the reader will witness in the pages that follow, Dunn thinks well in three dimensions and understands thoroughly the consequences of a particular test, comparison, or view.

After our visit to the temples in 2006, Dunn studied his photographs and detected in the statues certain features that resembled tool marks—the kind of tool marks that a craftsperson or engineer would

recognize. Realizing that he had focused on collecting geometric information and neglected to look for evidence of tool marks, another trip was planned and taken in November of 2008 to further authenticate and more finely focus on what his previous photographs indicated. On this trip I was able, through Dunn's camera, to see the tool marks on the cheek of one of the Ramses in the Temple at Karnak, even though the head of that statue was some 45 feet in the air. I was later able to examine the resulting photograph, as can the reader later in this book.

I vividly remember my first (and then every subsequent) visit to the Luxor Temple. Although smaller than the nearby Temple at Karnak, the Luxor Temple is impressive. The different areas of the Temple provided an interesting variety of architecture from the hall of the Ramses to the colonnade to the plaza to the inner temple. Each had something different to offer and yet they harmoniously fit together. The imposing Ramses statues hewn out of huge solid blocks of granite, the immense columns, and the fact that the Temple, its contents and its surroundings have existed for thousands of years caused me to wonder about the influence it had on the civilization that built it. From these thoughts, my mind was opened to a new awareness.

As I am confronted with the evidence, both in Dunn's book and from my own personal observation, I find myself wondering, among other things, how the technology of the ancient Egyptians that allowed them to carve and shape stone as they did was applied in other areas of their society, such as healthcare and dentistry for example. In our society, advancements in one area of technology are quickly spread to other areas in which those advancements might apply. Wouldn't the ancient Egyptians have done the same?

While my background as an attorney and a manufacturer qualifies me to evaluate Dunn's work objectively, I am still awestruck by what he has revealed in his studies and by the disparity between his findings and the understanding I gained in the course of my traditional education on the subject. If, metaphorically speaking, truth lies at the heart of an onion, I have witnessed firsthand as Dunn peeled away layers of that onion to get closer to the heart of technologies employed in

ancient Egypt, revealing previously unaddressed questions. While the most obvious and prominent of those questions is *how* these ancient artifacts were made to exhibit such remarkable geometry and precision, the second most obvious that follows quickly on the heels of the first is *why*.

At this time, there are no certain answers to these questions, and it is human nature to fill the void of the unanswered question with something. Those who ignore questions because the answers are not apparent are disingenuous. I am reminded of this quotation from John Stuart Mill in *Considerations on Representative Government*: “From despairing of a cure, there is too often but one step to denying the disease; and from this follows dislike to having a remedy proposed, as if the proposer were creating a mischief instead of offering relief from one.”

A skeptic is defined by *Webster’s* as “a person who questions the validity or authenticity of something purporting to be factual,” while the same dictionary defines cynical as “distrusting or disparaging the motives of others.” In his work, Chris Dunn invites us all to be skeptical of things that we may have never really questioned while, at the same time, he invites rigorous skepticism of his own observations. This skepticism is healthy and helpful. It is not cynicism, however. It is not contempt for the theories or ideas of others or for those who proffer those theories or ideas. It is a questioning and a testing of one’s own ideas and theories as well as those of others. In reading and contemplating the pages that follow, I entreat the reader to be skeptical but not cynical.

In exercising skepticism while reading Dunn’s work, also bear in mind this quotation from the Wizard in the play “Wicked”: “Back where I come from we believe all sorts of things that aren’t true . . . we call it history.”

Perhaps a more famous Winston Churchill quote, “history is written by the victors” should be considered. The history of Egypt traditionally taught in the west has, for the most part, been written by western scholars who followed on the heels of their armies. I am confident that the obvious sophistication of the ancient Egyptians revealed in this book will, in due time, prompt western scholars and others around the

world to reexamine what has been written about ancient Egypt and to consider what else the citizens of that ancient civilization, by whatever means, accomplished.

JUDD C. PECK, ESQ.

Judd C. Peck graduated from the University of Illinois College of Law (magna cum laude) in 1978. In 1989, he took the helm of Danville Metal Stamping in Danville, Illinois, and became its President and Chief Executive Officer.



# Photographic Credits

Illustrations and photographs are copyright Christopher Dunn, 2006–2010, except for the following copyright holders who have my sincere thanks and appreciation for their critically important contributions to this book.

Figure 3.5: thanks to Jessica Brackmann of Champaign, Illinois.

Figures 7.15 and 10.31: Dr. Arlan Andrews Sr. of Padre Island, Texas.

Figures 11.1, 11.3, 11.4, 11.8, 11.12, and plate 26: Nick Annies of Cambridge, UK.

Figures 1.19, 4.3, 6.6, 6.9, 11.6, and 11.7: taken by author and printed with the permission of Danville Metal Stamping Co., Inc.

Plate 19 upper and lower left: Jacques Grimault of Paris, France; 2005 Egypt Project.

Figure 9.3: Bart Haas of Pekin, Illinois.

Figures 5.6, 6.15, 9.10, and plate 19 right: Dan Hamilton of Canada.

Figures 9.8 and 9.9: Photograph by David Loveall and copyright Mike Leckie of Eugene, Oregon, 2007.

Figures 6.3, 6.4, and 6.5: Glenn McKechnie, reproduced under the guidelines of Creative Commons License Deed, available at <http://creativecommons.org>.

Figure 6.10 and plate 13: Stephen Mehler of Colorado.

Figures 8.1, 9.11, 9.12, 9.13, and 9.16: Andrea Mikana-Pinkham of Sacred Sites Journeys, Sedona, Arizona.

Plate 11: Joakim Möller of MadCAM Mould and Die CAM Systems, Romakloster, Sweden.

Figures 9.17, 9.20, 9.21, 11.18 upper left, and plate 19 upper and lower left: Patrice Pooyard of Paris, France.



# Acknowledgments

Those who have come into my life—whether personally, professionally, in the flesh, or at the speed of light as packets of electromagnetic energy coursing through the Internet—are the motivators and teachers to whom I am eternally indebted.

For her unwavering support and encouragement, I thank my wife, Jeanne. Her patience and intelligence, not to mention her enthusiasm for my work, are acknowledged with love and appreciation. Thanks and love also to my sons Peter, Alexander, and Geno, who have stood by me and supported all my research and trips to Egypt. For their loving influence in my life, I thank my mother and father and my siblings: Bernard, Celia, Pauline, and Angela.

My sincere gratitude goes to Judd Peck for his wisdom, advice, and friendship. I will always remember and remain humbled by his mission of mercy when he flew to Egypt to assist me in my recovery and return home when I fell ill and was hospitalized in Cairo in 2007. I also extend my sincere appreciation to Edward F. Malkowski, who provided life-saving assistance on that ill-fated trip. Also, my gratitude goes to Cecilia El Nadi, Bahgat El Nadi, Mohamed El Nadi, Semir Gharib, and Sharzhad Awyan for their kindness and help in Egypt. My brother Bernard, sister Angela, and their families who stood by ready to assist, and the people of Danville, Illinois, and many others around the world who expressed concern and gave an outpouring of support to Jeanne and me during this ordeal. My thanks, also, to the staff of the Dar Al Fouad hospital in 6th of October City and Provena Medical Center in Danville, who provided excellent care to a very difficult patient.



The Board of Directors, management, and employees at Danville Metal Stamping have been incredibly supportive and helpful. The opportunities they have given me as well as the encouragement I've received while pursuing this rather offbeat avocation are of inestimable value. For their assistance in several research projects that required machine-tool work, I would like to thank Tom Neal, Don Reed, James Brown, and Doug Carter.

Dr. Arlan Andrews Sr. has helped immensely over the past thirty years with advice and encouragement. I cannot thank him and his wife, Joyce, enough for their incredible support. The irrepressibly passionate Stephen Mehler and Theresa Crater, who sometimes get more excited about my work than I do, have been valuable supporters and have shined their own bright light on the true heritage of the ancient Khemitians (Egyptians). Thanks and blessings to Norma Eckroate for her incredible support and promotion of new information about ancient cultures. For their continued support and feedback I am indebted to Paul and Ardith Keller, Jeff and Judie Summers, David Hatcher Childress, Doug Kenyon, Paul Brenner, Dr. John DeSalvo, Michael Schneider, George Noory, Dr. Dustin Carr, Jennifer Bolm, the late Abd'el Hakim Awyan, Ashraf Williams, Gouda Fayed, Antoine Gigal, Alain Hubrecht, Dr. Hossam Abulfotouh, Carol Radford, Jeff Rense, Bart Haas, Susan Hale, Dan Hamilton, Jaques and Visne Grimault, Susan Alexjander, Dr. Randy Ashton, Dr. Dustin Carr, Steve Garcia, James Hagan, John Heckler, Will Hemphill, Gary Lickfett, Stuart Mitchell, Robert Bauval, Dr. Robert Schoch, Michael Cremo, Dr. J. J. Hurtak, and Colin Wilson.

For their contribution to a greater understanding of Petrie's infamous Core 7, I would like to thank Dr. Stephen Quirke and James Hale of the Petrie Museum; Malcolm McClure and Nick Annies for their assistance in the Petrie Museum; Ian Lawton and Chris Ogilvie-Herald for the impetus provided in their book; Graham Hancock, Santha Faiia, and Nick and Angie Annies for their hospitality while I was in London.

Special thanks go to Dr. Zahi Hawass for his Egyptian hospitality and helpfulness in providing permission to the worker's village, the Great Pyramid, and the Serapeum. To Adel Hussein Mohamed, the

director of Saqqara and lately of Giza, who was a perfect host during the visit to the Serapeum; and to Gail Fallen of Grizzly Adams Productions for making those events possible. Mike Leckie for his talent, expert opinion, and gorgeous photographs; Patrice Pooyard for his vision and passion; John Anthony West, an enormously enjoyable host and companion who I found was always willing to listen to a different point of view; Andrea Mikana for contacting me before visiting the Unfinished Obelisk and asking me if there were any images I needed: the results are outstanding. Denys Stocks, for his professional and thorough answers to my e-mailed questions, and Marcus Allen, for his interest and input regarding the Petrie Core #7.

In preparing this book for publication I am indebted to Greg Brown who offered his help as an editor and a sculptor and who provided expert feedback during the writing of the first draft. From Inner Traditions • Bear & Company, I would like to thank, in the order I met them, Rob Meadows; Cynthia Fowles; Jon Graham; Jeanie Levitan; Kristi Tate; Peri Swan; a marvelous project editor, Chanc VanWinkle Orzell; Manzanita Carpenter; and all others who are a part of this unique publisher's staff.

Last but not least, I should mention the value brought by hundreds of online forum participants who have provided both positive and negative feedback. I appreciate the comments and the challenges, and I hope they will continue.



# Introduction

*Tell me, Mr. Hoover, what are your interests?*

*Madam, I am an Engineer.*

*Really? I took you for a gentleman.*

HERBERT HOOVER, CONVERSATION ON MAKING  
THE ACQUAINTANCE OF A LADY ON A STEAMSHIP

It is possible that Mr. Hoover's confused lady acquaintance had the wrong impression of what an engineer does, since a train driver is also known as an engineer. There are mechanical engineers, electrical engineers, materials engineers, computer engineers, construction engineers, quality engineers, and safety engineers. And all may not be considered gentlemen—many you may meet will be ladies. Each engineer works in a specialized field, and within those particular disciplines are subgroups that work in myriad industries that form the fabric and backbone of modern civilization. Of themselves and their machines, the life of an engineer is frequently punctuated with Scotty's *Star Trek* lament, "Can't take much more o' this, Captain!"

Perhaps unbeknownst to you, the engineers' labors have a direct affect on your daily life. For instance, you have just arrived in the office, hung up your coat, and poured yourself a cup of your favorite morning beverage. An army of engineers and artisans worked to create the technology that has allowed your morning ritual to happen. Crafted into the

car, train, or bus and the elevator that carried you to your destination are the labors of the modern artisan. At some location miles away, perhaps on another continent, the skillful eye and hands of artisans guided the tools that created the coffee maker and processed the coffee.

The Industrial Revolution of the 1800s propelled Western civilization forward in terms of labor-saving devices. Around this time, many of the machines that are now used in manufacturing were either invented or improved. Yet the most basic of machines, the lathe, has been around in one form or another for centuries—originally in the form of a potter's wheel. Its development as an efficient metal-cutting machine grew from the invention of the steam engine, which powered everything from textile mills to Stephenson's Rocket, the first steam locomotive to convert linear motion to rotary motion and use that rotary motion to propel itself along two rails at the dizzying speed of twenty-five miles per hour.

In the past sixty years, technology has advanced rapidly in directions that many people, except science fiction writers and futurists, could not even have imagined possible. Discoveries and innovations in the field of physics have introduced new patterns of thought in the minds of scientists and inventors. Like legs on a centipede, branches of science, engineering, and manufacturing, along with the creative genius of gifted artists who are now an essential part of the design of functional products, move forward, independently and in unison, each drawing on the other for inspiration and survival.

Three hundred years before the Industrial Revolution was in full swing, geniuses arose among their peers and made their mark, adding to the prosperity and understanding of future generations. The genius of Leonardo da Vinci, Copernicus, and Galileo is well known. During this period, mathematicians, astronomers, and philosophers laid the groundwork for the pursuit of scientific inquiry and changing the worldview of humanity and its place in the universe. With its genesis in the 1500s, what is now known as the Scientific Revolution fought against the church and superstitious beliefs to create the foundation of modern science. The heliocentric theory of Nicolaus Copernicus shattered many beliefs of the

earth's preeminence in the universe, and the Catholic church, which opposed such heresy, fought tooth and nail to stop the rush of intellect that ultimately reshaped our beliefs about nature and ourselves. René Descartes, a devout Catholic himself, cut through the confusion that had reigned for so long with a remarkably simple philosophy that to us is a part of life, but in his day was counter to the philosophy of the church, for it would ultimately challenge the church's own philosophy and teachings. In "Discourse on the Method of Rightly Conducting the Reason and Seeking for Truth in the Sciences," Descartes sets forth three guidelines that he followed in his own work:

The first of these was to accept nothing as true which I did not clearly recognize to be so: that is to say, carefully to avoid precipitation and prejudice in judgments, and to accept in them nothing more than what was presented to my mind so clearly and distinctly that I could have no occasion to doubt it.

The second was to divide up each of the difficulties which I examined into as many parts as possible, and as seemed requisite in order that it might be resolved in the best manner possible. The third was to carry on my reflections in due order, commencing with objects that were the most simple and easy to understand, in order to rise little by little, or by degrees, to knowledge of the most complex, assuming an order, even if a fictitious one, among those which do not follow a natural sequence relatively to one another.<sup>1</sup>

From the birth of the Scientific Revolution to the Industrial Revolution the knowledge of the world has advanced at a rapid pace. Up until today, this advancement has spanned five hundred years. Within that time we have gone from an agrarian society with a much lauded, simple, pastoral existence to a complex industrial society with products that were undreamed of when the creator of the world's first successful locomotive, Robert Stephenson, cried out, "full steam ahead!"

Punctuating each stage of civilization's development are major building projects that by necessity or demand incorporate the state-of-the-art

building construction of their period. The landscape of the ancient world is dotted with fabulous structures that are breathtaking in their complexity. The Egyptians and Mayans had their pyramids and temples. The Hindus crafted elaborate temples throughout Asia. The Greeks built the Parthenon, and the Babylonians constructed the Jupiter Temple and the fabled Hanging Gardens. The Romans made their mark all over their world, with engineering geniuses guiding the construction of their famous roads, the Coliseum, and numerous temples and viaducts, while Roman sculptors guided their chisels over marble and alabaster, giving it physical presence and beauty.

With the exception of artifacts such as the mysterious Antikythera Mechanism, an astronomical computer found by fishermen on the sea floor near the island of Antikythera in 1901, the development of technology in the ancient world seems to have clear origins and is fairly well understood.

Going back yet further in time, another deep mystery lies in the question of how the ancient Egyptian civilization could have lasted for three thousand years *without* improving the tools used to quarry and shape stone to near perfection. Since 1984, when *Analog* magazine published my article “Advanced Machining in Ancient Egypt?” controversy on this subject has persisted. The article proposed that the ancient Egyptians were more advanced than previously believed and that they used advanced tools and methods to cut granite, diorite, and other difficult-to-work stone. It does not seem credible that brilliant architects and engineers would continue to use stone tools and copper chisels for three millennia.

Following this article, I have received input from many kind people from different walks of life. Though much of the feedback I have received has been extremely positive and supportive of the idea that ancient cultures were more advanced than classical archaeology has supposed, there has been some criticism from those who believe that I went too far with my conclusions because I made the mistake of imposing a modern engineer’s viewpoint on an ancient civilization, thereby ignoring its cultural origins, and disrespected the Egyptians’ heritage.

In fact quite the opposite is true. Anyone who suggests that the ancient Egyptians were more advanced actually shows more, not less, deference and respect to their civilization. Such a statement does not diminish their culture in any way. Rather, such a suggestion would elevate the Egyptians' status in the world. The cultural assumptions that are disturbed most by the idea of an advanced Egyptian race in prehistory lie in the libraries and halls of Western countries and the belief system that has been generated by generations of Western scholars—beginning with Herodotus. It is our own culture's chauvinistic view of Egypt that threads throughout our history books.

Studies made by archaeologists, historians, and Egyptologists over the past five hundred years have essentially provided us with the modern, conventional view of ancient Egypt. This is an area of intense interest to engineers—such as myself—who find in Egypt a language with which we are familiar. This is the language of science, engineering, and manufacturing. Our counterparts in that ancient land left future generations of scientists, engineers, architects, and those who take their instructions and shape materials to their specifications, with a difficult challenge. This challenge is to recognize what they created and provide evidence-based, reasonable answers that give the ancient engineers credit for what they achieved. With their works, ancient engineers, perhaps unwittingly, created a sort of Mecca for modern engineers and technologists. The engineers and technologists that have taken this “pilgrimage” have discussed many theories, but always at the end we come up short of confidence that the theories are actual truth.

The ancient Egyptians who built the pyramids and temples, who crafted monumental statues out of igneous rock, were thinking with the minds of architects, engineers, and craftspeople. Were ancient archaeologists responsible for the legacy they left us? Without the advice of modern Egyptian architects, engineers, and craftspeople, are today's Egyptian archaeologists missing something? Are modern interpretations of the awesome feats of the ancient Egyptians irrelevant in providing new and powerful information about this ancient culture? Are the thoughts and conclusions of Western writers and travelers who stood in front of



the Great Pyramid one hundred years ago (or some forty-five hundred years after it was built) more intrinsically linked to the ancient Egyptian mind than those who come after them, a century or more later? What can be described as a “modern perspective?” In his time, Herodotus would surely have been considered modern. So were Egyptophiles Petrie, Marriette, Champollion, and Howard Carter—each in possession of a modern mind that was clothed in a fabric of prejudices and stereotypes that existed within their own culture.

When it comes to completely understanding the ancient Egyptians’ level of technological prowess, there can be no final conclusion. What is left to study today is a mere skeleton of what existed at the time of the ancient Egyptians. This skeleton survives as highly sophisticated and precisely crafted sedimentary and igneous rock. It is my belief that the clothes we have placed on this skeleton are mere rags compared to what should be there. I have proposed in the past that higher levels of technology were used by the ancient Egyptians, but you will find in this book that I have rejected some ideas and cast doubt on all my previous assertions as to the level of technology they enjoyed. At the same time, I cast doubt on the methods of manufacture that Egyptologists have asserted were used to build the pyramids and the glorious temples in Egypt. These methods are primitive and include stone and wooden mallets; copper chisels; tube drills and saws; and stone hammers for quarrying, dressing, and sculpting hard igneous rock. Nobody can claim that they know what was in the minds of the ancient Egyptians. All we have are their works: “By their works, ye shall know them.”\*

This book is about the Egyptians’ works, but before understanding the manufacturing and building methods, it is necessary to understand the full scope of each work—exactly what it is we are studying. In the following pages I present another view of ancient Egyptian artifacts: the view of a modern craftsman and engineer made possible through the use and knowledge of modern technology.

After I describe each work, we will examine the methods of con-

---

\*Matthew 7:20.

struction that have been proposed by Egyptologists and discuss some of the arguments against and for considering other methods that are more advanced. It is my sincere wish that the artifacts are respected and understood for what they are. They are priceless treasures and would have astronomical value if produced today using modern tools. Because they are encoded with the knowledge of life on this planet in prehistory and hold a powerful message for future generations, their worth in monetary terms is unfathomable. Their value in raising awareness and dispelling cultural bias, even while short of real answers, cannot be calculated in monetary terms.



1

# The Shadows of Luxor

*The life of man is a self-evolving circle, which, from a ring imperceptibly small, rushes on all sides outwards to new and larger circles, and that without end.*

RALPH WALDO EMERSON, *ESSAY ON CIRCLES*



Within the Ramses Hall at Luxor, subtle curves and shaded hues of geometric perfection create an effect that seems designed to mask the real truth about the artifacts. Waiting for millennia for questions that have not been asked, let alone answered, the perfectly crafted granite statues of Ramses II smile and gaze upon each person who enters the hall and tries to come to terms with and grasp the true meaning of the Temple of Amun-Mut-Khonsu at Luxor.

Sometimes referred to as the world's greatest open air museum, the city of Luxor is situated in Upper Egypt, where once stood the ancient city of Thebes, approximately four hundred miles south of Cairo. The temple complexes of Karnak and Amun-Mut-Khonsu stand within the city, and the latter is commonly referred to as the Luxor Temple. Overlooking the Nile River nearby is the Winter Palace where Howard Carter and Lord Canarvon refreshed themselves in the quiet, cool bar. Graceful lateen sails fill and push feluccas on the river, as clouds, haloed by a crimson sun setting in the west, snake like serpents in the evening sky. Monuments, temples, and tombs of the west bank necropolis lie beyond the sails and include the Valley of the Kings, the Valley of the Queens, the Ramesseum, and roads leading to the temples of the north.

If special recognition was given to the billionth visitor to Luxor, I probably missed it by centuries. Millions of tourists go there every year and, in season, jam to capacity the hotels and luxurious floating mansions that cruise the Nile River. Out-of-season accommodations play host to more visitors than a hotel in a normal town would at the height of any tourist season.

In any society, there are geniuses that innovate and make their mark by providing novel and revolutionary iconic images. Within the confines of three dimensions, the subtleties of individual expression allow philosophy, symbolism, and individuality to flow forth into stone, onto canvas, or through the orchestra. This expression guides the chisel and the pen.



Figure 1.2. Bust of Ramses outside the Temple of Luxor

Nowhere in the ancient world is the marriage of art and engineering better expressed than at Luxor in Egypt. The temples have inspired many to write eloquently about the city's magnificent monuments, its history, and the archaeological studies that have yielded untold riches in antiquities. The incredibly significant aspect of the artistic attributes of the numerous statues of Ramses is that it stimulates both the right and the left brain to study how their imposing beauty is not only a symbol of an incredibly gifted ancient culture, but also a symbol of manufacturing engineering that would be considered quite relevant in our modern world.

### THE RAMSES CHALLENGE

The ultimate function of art in human evolution is a mystery, but there is no mystery about what art does: it communicates, it evokes, it alters the observer. From the profound power of the Lascaux cave images to

the spattering of Jackson Pollock, art calls to something within the observer. In the case of Luxor and the images of Ramses, the art is highly stylized, symbolic, and uniform. Even to today's observer, it carries a deliberate message of divinity and eternity, of awe and majesty—which must have been so much more powerful to the ancient Egyptians. On another level, to the sculptor who has worked in stone and to the technologist whose job it is to shape adamantine materials, it calls out a question and issues a challenge: “What am I? How did I come to exist? Build another just like me.”

It challenges: “Don't just gape in awe and wonder, shake your head, and walk away. Bring me back to life! Know me—who I was and what I was. The only way to do this is to understand what I am and build another! Why am I smiling? Don't think for a minute that I am content sitting here on my pedestal, misunderstood by the droves that have passed by for centuries. There is more here than meets the eye.”

The Ramses challenge was issued in ancient Egypt again and again, from Memphis and Cairo to Luxor and Abu Simbel. Exact replicas of Ramses' image were crafted in limestone, sandstone, quartzite, granite, and diorite. Some pieces, such as the Colossi of Memnon, weigh more than 1,000 tons. Other statues at Luxor weigh 600 tons. In fact, just the crowns that top the statues each weigh more than a ton. The statues are massive—a significant challenge to move and, because they are intricately carved, an even more significant challenge to sculpt. What distinguishes the Ramses statues is the iconic imagery of the perfect face. It seems that no matter which of the Ramses statues we look at, the same smiling face gazes through you, into infinity.

In order to accomplish this effect, the ancient sculptors worked to a uniform system of measurement and a design scheme. Just as today we replicate designs using uniform measures and consistent methods of manufacturing, in ancient Egypt there was a system of design, measurement, and manufacture used to create the Ramses statues. We can then ask the question: What was the fundamental scheme that the ancient Egyptians used to create and re-create this iconic image in stone?

In 1986, I visited Memphis, near Saqqara, and gazed down at the

statue of Ramses in the open-air museum. Looking down the length of the statue, it struck me as peculiar that the left and right nostrils were identical mirror images of each other. It is common knowledge that no adult walking the earth has nostrils that are identically shaped. I thought it was noteworthy, but did not follow up and research it further as my focus at the time was on engineering, not art. I was there to study the pyramids and had not planned to visit any temples during my visit. I didn't realize at the time, though, how important my observation would become to my future research.

My interest in the Ramses statues was rekindled when I visited Luxor in November 2004. Though I had been to Egypt four times before and learned to love the Egyptian people for their hospitality and sense of humor, this was my first visit to the temples in Upper Egypt. Words cannot describe my feelings of wonder and awe as I absorbed the temples not only from a philosophical and spiritual aspect but also with my engineer's brain. These temples impressed upon me indelibly that they were incredibly important from an engineering and scientific perspective.

For an engineer or artisan, to walk through the Temple of Luxor is an exercise in humility. Combining the logical, rational, and objective attributes of left-brain functions with the intuitive, subjective, and holistic qualities of the right brain, the experience of seeing these temples is suffused with profound sadness for a civilization that had risen to great heights and then suffered a cyclic decline.

In exploring what is left—the mere skeletons of the Egyptians' achievements—and then going beyond, a veil is lifted to reveal the incredible material loss of a people who created perfectly crafted buildings and statues from the hardest stones known to humankind. This ancient culture accepted the challenge to develop the tools to work glasslike stone—stone that was created by tremendous forces within the earth and spewed, or squeezed, from its fiery belly—to a high order of magnitude, proportion, and exactitude.

Basalt, diorite, and granite yielded to these ancient tools—the quartz crystals abundantly present in the granite and diorite gave way

to the application of ancient technology now lost. Perfection was the goal, and the ancient Egyptians' stone-working craft, as we shall see, was perfected to the extent that exactness was achieved.

Even if our mind is not normally turned toward philosophy, a visit to Egypt soon finds our thoughts seeking refuge in ruminations of wonder at what once was and what could have (or must have) been had there not been an interruption. From the perspective of a philosopher, the mortality of physical existence is reinforced. We slowly realize that civilizations are like the human body—they have a life cycle. This is a discomfoting thought for those who are faced with the implications of what Egypt's accomplishments mean. We become comfortable to the extent that we can master our environment, but eventually we all must yield to the ultimate master. The natural cycles of the universe and their concomitant forces of nature unleash death and destruction with as much indifference and impartiality as they provide what is necessary for life to exist.

The Temple of Luxor holds a message for our civilization—one that reaches across millennia through the ravages of time, and, though shaken, crippled, and on its knees, it implores us to pay attention.

I was with a delightful, eclectic group of people on a tour of Egypt in November of 2004. The tour was arranged by Andrea Mikana-Pinkham of Body Mind Spirit Journeys, and presenting on the journey were my good friends Stephen Mehler and David Hatcher Childress. A broad range of people from various backgrounds, including engineers, a pilot, salespeople, a doctor, a nurse, a minister, and, from Florida, a sassy barmaid with an infectious laugh, milled around the bus every morning in anticipation of another great day in the field. Everybody was having a wonderful time, and we all had one thing in common: a deep respect for the Egyptian culture and its monuments. Good humor and jokes flew around the bus like the swallows that swirl around the Great Pyramid at dawn.

Before 2004, I had not paid much attention to the temples in southern Egypt. Instead, I focused my attention on the pyramids and what I considered to be their more technical engineering attributes. As a part



of this tour, I was fascinated by the story given by the Egyptologist tour guide, but I was not so fascinated that when an object caught my attention, I refused to wander off to do some exploring on my own.

When you are part of a tour group, your visits to temples are strictly controlled. Generally, the tour operator takes you to Luxor at a time when it is the most visually stimulating: at night, when the temple is lit up with carefully designed and directed lighting. When you walk among the massive columns that reach to the sky like giant redwoods, the chattering of numerous tour guides fades as the power of the temple imposes its own majesty and voice onto your consciousness. This effect became more meaningful to me later, as my interest peaked and I began to learn more about the symbolic and philosophical interpretations that the temple has evoked from the hearts and minds of other researchers.

## THE SECRETS OF THE CROWN

While our guide explained the meaning behind the intricately carved reliefs on the walls of the temples, several pieces of granite that were positioned in front of statues in the Ramses Hall—the first hall visitors enter after passing through the first pylon—managed to catch my attention. The explanations of the symbols on the walls suddenly lost their interest to me. Commanding my attention now were objects that appealed to a part of my nature that had been developed over many years of training and experience in manufacturing.

I recognized the granite pieces' faintly illuminated shapes as the cone-shaped crown of Upper Egypt: the Hedjet. Depicted as a white conical headdress in Egyptian art, images of the crown are found on the Narmer Palette and, famously, on the gold statue of the boy-king Tutankhamen. Another crown found in the Ramses Hall is the Pschent: a combination of the Red Crown of Lower Egypt and the White Crown that symbolizes the unification of the two Egypts. (See figure 1.3.)

During this visit, I was able to examine them only visually and feel their smooth surfaces with my hand, but I was struck by their perfection of form, and I could not detect any deviation from a perfectly crafted

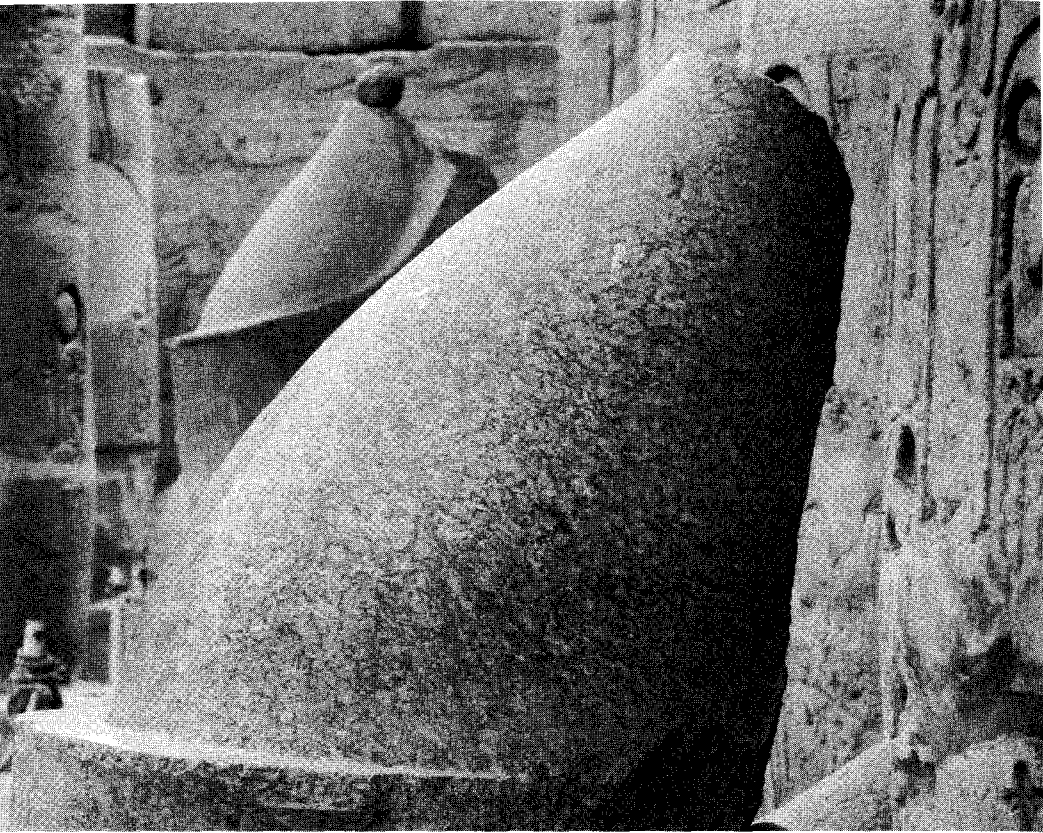

Figure 1.3. The Hedjet (front) with Pschent (back)

contour. Throughout the course of my career, my hands have run across many different machined contours in order to find surface imperfections—and my contact with these Egyptian pieces seemed no different from my previous contact with objects that had been removed from a precision machining center. Except for some minor abrasions (presumably the result of the crowns falling to the ground) there were no pits or ripples or depressions in the compound curved surface. I felt only a flowing, exact surface that seemed as smooth as though it had been spun on a lathe. Because of its geometry, however, it would have been impossible to craft these crowns in such a manner. Along the length and width of each, the surface followed simple arcs that obviously were the result of careful deliberation in concept, design, and manufacture. From a cursory examination, it seemed clear to me that this result demanded adherence to geometry and precision in the manufacturing process.

This impression gnawed at me for a year, until I finally awoke to the

realization that I had to go back and study them further. My opportunity to examine them again wouldn't come until February 2006, when I went to Egypt with John Anthony West on one of his Magical Egypt tours.

My main interest in going with West was to learn more about R. A. Schwaller de Lubicz, who had spent fifteen years at Luxor studying Amun-Mut-Khonsu and had concluded that it was built using a system incorporating precise measures that were a deliberate representation of the universe and man. Amun-Mut-Khonsu is, according to Schwaller de Lubicz, a material expression of cosmic correspondences. His magnum opus was translated into English in two volumes titled *The Temple of Man*.<sup>1</sup> It is considered a difficult work to understand, and West was one of the few people in the English-speaking world who knew Schwaller de Lubicz, supported his conclusions, and wrote about him in his own book *Serpent in the Sky*.<sup>2</sup> A more recent treatment of Schwaller de Lubicz's work is *The Spiritual Technology of Ancient Egypt*, by Edward Malkowski.<sup>3</sup>

Before traveling with West, I bought a Canon digital Rebel XT 8-megapixel camera, and I took my laptop with me on the journey. Had I known at the time what my camera would reveal to me, I would have taken a good tripod too. Regardless, there is not much time for careful photography while on a tour because of time constraints, so it was more a matter of taking typical tourist photos—but doing so while striving, as best as circumstances allowed, to capture centered images of the crowns so that later I could evaluate their symmetry on the computer.

Because our visit to the Temple of Luxor was at night, I could not take the photographs I wanted of the crowns, so I photographed the Ramses statues and the bust near the obelisk outside as well as the obelisk itself, all the while attempting to keep the images square and the axis of the camera in line with the central axis of each object I was photographing.

The next day, after our excursion to Denderah and Abydos, I had the bus drop me off at the temple instead of the hotel in order to photograph the crowns in daylight. At this time, I was able to get better photographs just before dusk—the sun had barely disappeared behind the

wall of the Temple, so it did not cast any sharp shadows. This allowed for a very evenly lighted shot that minimized distortions of the symmetries of the objects I wanted to measure.

To a certain degree, my session was successful, and I was able to ascertain with some certainty that these crowns spoke an untold story. I took a digital image of one of the crowns and loaded it into my graphics program. I then duplicated the image and made a transparency of it so that I could compare opposite sides to determine if they were symmetrical. I discovered that they were—to a remarkable degree of accuracy. (See figures 1.4–1.6.)

This symmetry, of course, compelled me to ponder how it was accomplished. In order to reverse engineer and duplicate an object, we must determine precisely the geometry encoded in its design. A few clicks of the mouse later, I had an answer to at least part of the geometry.

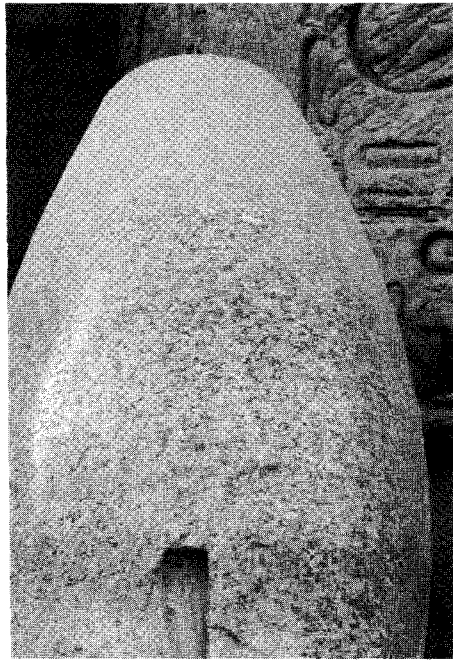

Figure 1.4. The first Hedjet original image

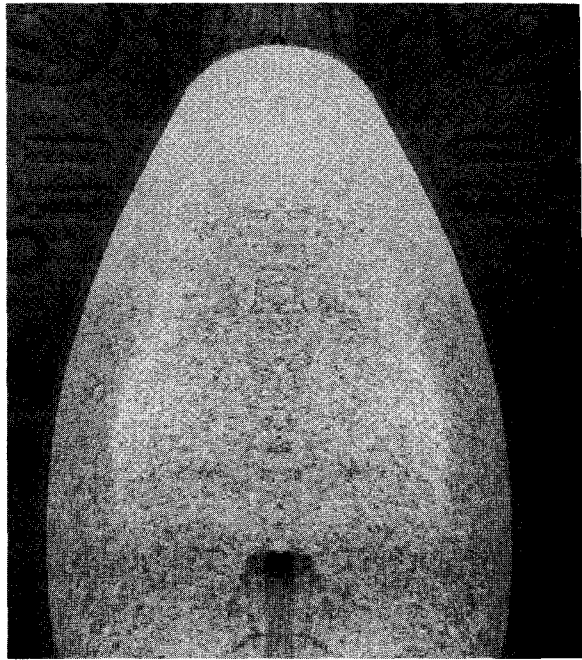

Figure 1.5. The first Hedjet original image and a reverse transparency that is slightly off center was created so that the shadow line can be seen.

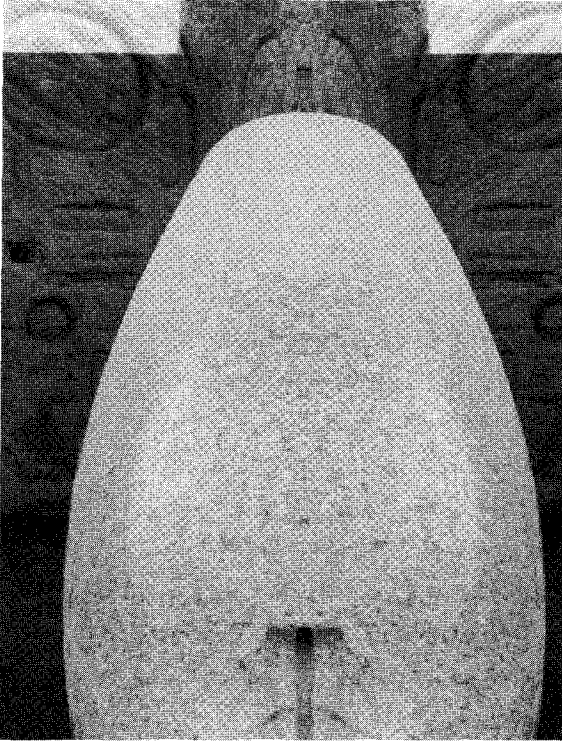

Figure 1.6. The first Hedjet original image and a reverse transparency on center. Note the symmetry between both sides.

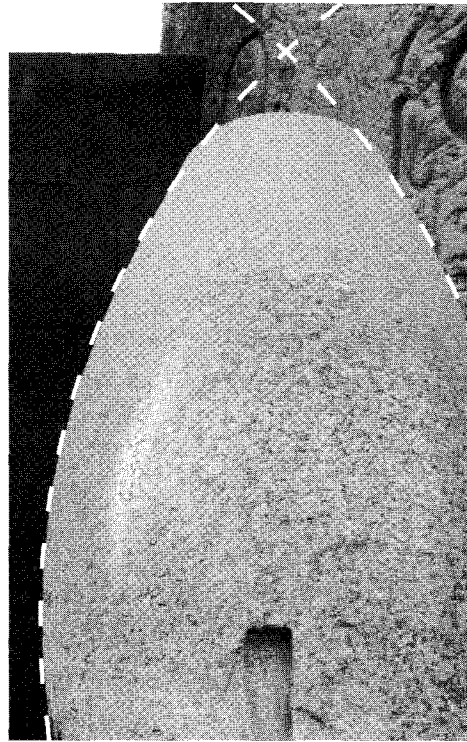

Figure 1.7. Hedjet symmetry with identical radii

Figure 1.7 is a photograph of the front view of the Hedjet. It was taken as close to the center axis as possible so that the symmetry of the piece could be measured. As it turns out, we can determine fairly conclusively that the crown was designed and crafted to incorporate a true radius of the same dimension on both the left and right sides when the Hedjet is viewed from the front.

I analyzed another crown in the hall in the same way (see figures 1.8 through 1.10), and though it blends with the head of the pharaoh, it is crafted with a similar exact geometry.

On the first Hedjet, toward the top of the crown, the contour of the granite starts to move away from a true radius and follows another contour. We could determine exactly what that contour is if the crown was intact, but instead we must examine other crowns that do not have their tops broken off.

The next question that sprang to my mind was whether the radius

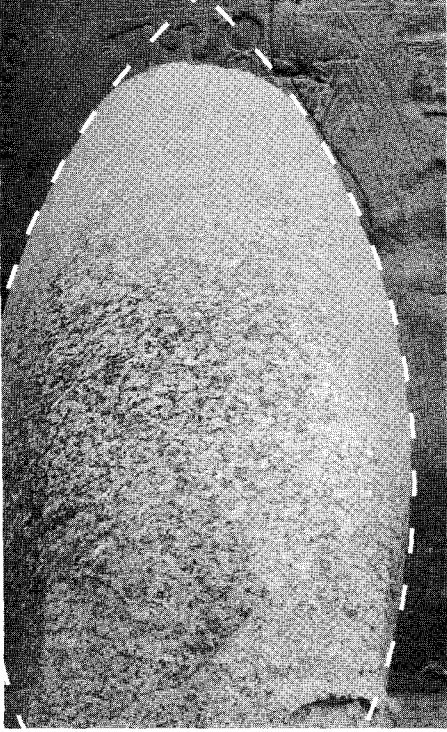

Figure 1.8. The second Hedjet symmetry with identical radii

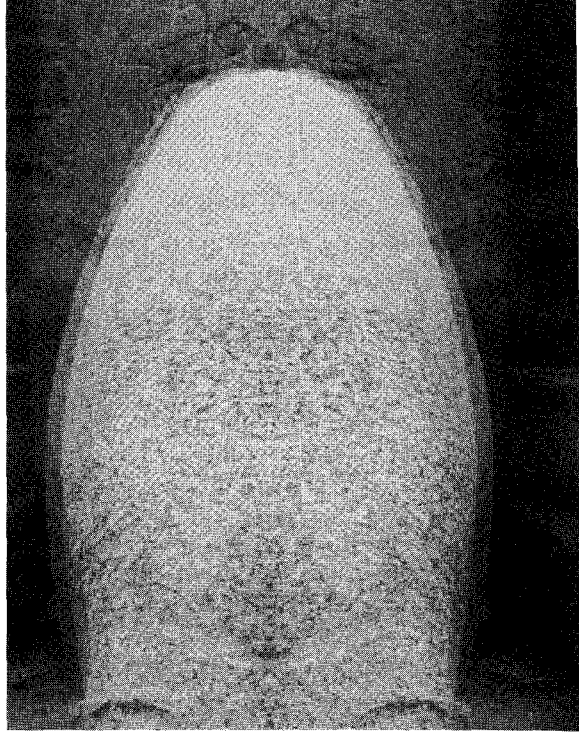

Figure 1.9. The second Hedjet original image and a reverse transparency that is slightly off center

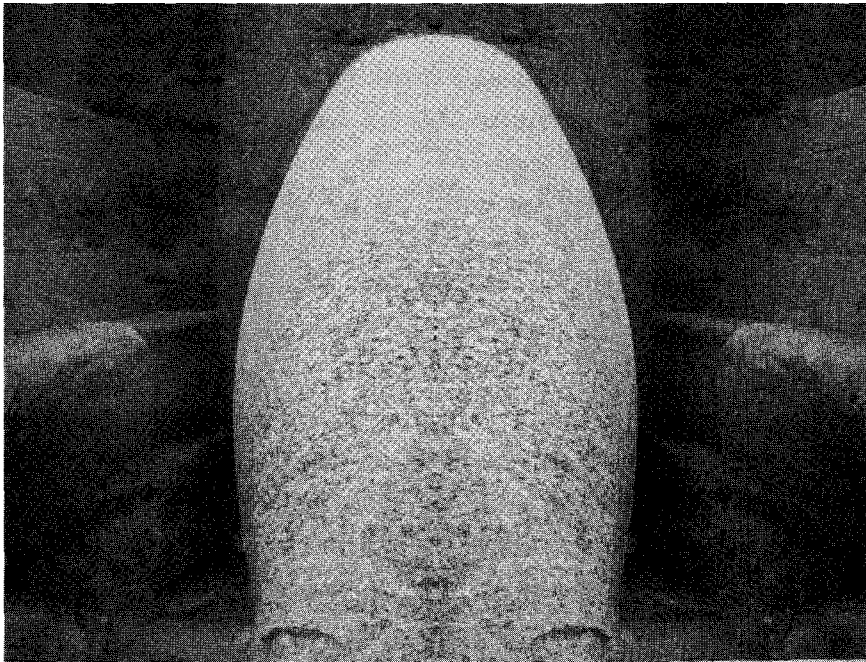

Figure 1.10. The second Hedjet original image and a reverse transparency on center. Note the symmetry between both sides.

was spun around a central axis—similar to the geometry on a bowling pin. Unfortunately, the answer to this question would take more time, because I had not taken any photographs of the Hedjet from the side—in fact, the question had not occurred to me until I was back at home, studying the photographs on my computer. When I was in the field, I was looking for symmetry and knew that the front and back were not symmetrical, so I didn't bother taking any photographs from that angle.

I was a bit chagrined that I didn't have the presence of mind to take those photographs, but I continued working with the ones I did have and determined that I absolutely had to return to Egypt and finish what I had started—or at least I had to take this mode of inquiry to the next level within my reach. I believed that at Luxor I had discovered a quality and precision of manufacturing granite that rivaled or surpassed what I had studied near the pyramids in Lower Egypt.

Because I had already taken two weeks of vacation, Judd Peck, the CEO of Danville Metal Stamping, my employer, was a bit perplexed when I asked for more time and told him that I needed to go back to Egypt when I had returned only a couple of weeks earlier. To convince him that the trip was legitimate, I shared with him what I had discovered in my many photographs.

Judd Peck is the president and CEO of a gas turbine engine manufacturing company with 410 employees. He is also a member of the Illinois Bar and a well-respected attorney in the community with impeccable judgment and common sense. After viewing the photographs for thirty minutes, he nodded and said, "I see what you mean."

The next day, I received a surprise: Judd came to my office and asked me if I was traveling alone to Egypt. What he had seen must have inspired him—he asked if he could tag along and carry my tripod. Of course, I was delighted to have him as a traveling companion, and in the last part of April through the first part of May, we went to Luxor to continue taking more tourist photographs.

As it happens, the quality department at Danville Metal Stamping had recently reviewed some new technology called Capture 3D. This

uses digital photography to take a stereo image of a contoured surface and then imports the images into proprietary software. The accuracy of the surface is compared to a computer model design and the imperfections are highlighted. In the world of *metrology*—the science of measurement—it is a relatively new technology, but one that yields reliable results. Judd and I were part of a panel that reviewed the technology and, in doing so, learned about some of the other work that had been performed by the company, such as digitizing and creating computer replicas of the statues on the Charles Bridge in Prague, in the Czech Republic.

With that resource in mind, I gathered some more equipment to assist me in my task: a sturdy Manfrotto tripod, a right-angle viewer, a telephoto zoom lens with macro focusing, and a wide-angle lens. Along with my digital camera, I brought to Egypt a film camera that accepted the same lenses.

The first day in Luxor we visited the Temple of Amun-Mut-Khonsu and spent about six hours there with very few tourists present. On this trip I discovered that it is best to experience the temples of Egypt in silence. I'm not sure how the ancients experienced these structures, but emanating from them—seemingly inversely proportional to the level of ambient noise—is a profound majesty. The hum of the city was an omnipresent background during my viewing, but within the colonnades and sanctuary of the temple itself, city sounds faded to insignificance and all was stillness and quiet. Similarly, on another trip that Judd and I took to Denderah, we were lucky enough to be there when all the tour buses had left. We spent several hours enjoying that temple in silence.

I found myself absorbed in thought as I went to work taking a set of photographs of artifacts that for months had consumed my mind with their overwhelming uniqueness. My thoughts turned to the recent Internet competition for the new list of Wonders of the World. I thought it was ironic that the Wonders of the World that I framed in my camera viewfinder on this visit were not even mentioned. In terms of beauty and the knowledge and skill they illustrated, the statues of Ramses II at Luxor and other locations in Egypt surpassed all other



competition candidates in terms of advanced geometry and complex manufacturing precision in one of the hardest-to-work materials known to mankind. As I hope to demonstrate here, the statues of Ramses challenge the Giza pyramids themselves as the most perfectly engineered artifacts of ancient Egypt—and perhaps of human history.

The polished glint of granite again compelled me to run my hand over its smooth, but now familiar contour. Again, I marveled at the feat of engineering and the fact that the granite crowns were originally placed on top of the heads of the Ramses statues that populate the precincts of the temple. Some of these statues are 40 feet tall, beyond the scrutiny of earthbound observers, yet the creators of these wonders had seen fit to place upon them crowns that were carved with, what I suspected from my examination so far, extraordinary exactitude.

Setting to work with my camera, I began to take more photographs, and I captured the images I failed to get the last time I was in Egypt. This time, my camera was firmly mounted on a tripod stand with a remote shutter-release button.

When I took the side-view photo of the Hedjet depicted in figure 1.7, I was unable to get a perfect right-angle view of the front because of barriers in the vicinity: A pillar was close to one side, and another crown was close to the other, but I was able to set the tripod to the side and obtain a shot at about 75 degrees. Upon review of the image, the answer to my previous question was answered: the side view of the Hedjet revealed that the contour on the front was also a true radius. Interestingly, though, at this angle, the radius had reduced in size by about 15 percent. (See figure 1.11; Radius B is 85 percent of Radius A.) Moreover, as the radius transitioned from the side to the front, the center point of the radius moved down slightly.

Fortunately, there were other crowns to study, and I set up my camera to focus on another on the west side of the hall—one of three crowns that had been placed in front of three statues positioned between the columns. In taking the series of photographs shown in figure 1.12, I attached a compass to the tripod and moved the camera around the crown in 45 degree increments. When I analyzed the results in the com-

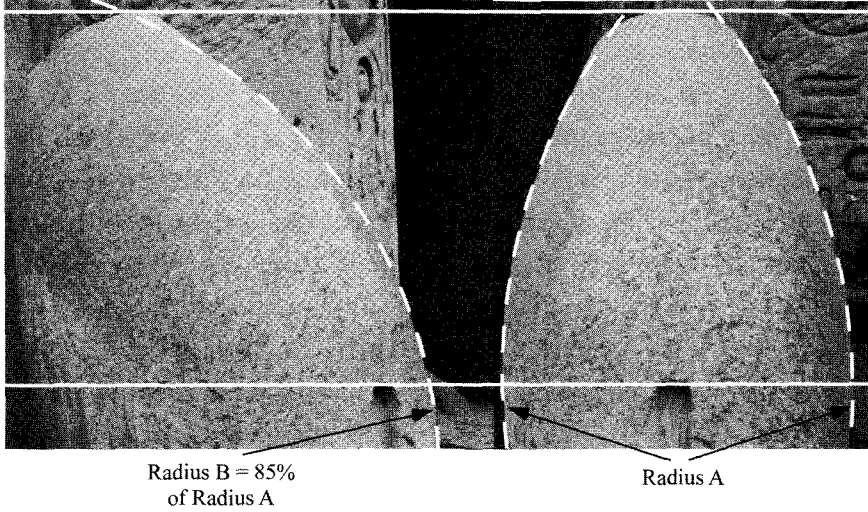

Figure 1.11. The Hedjet, side and front

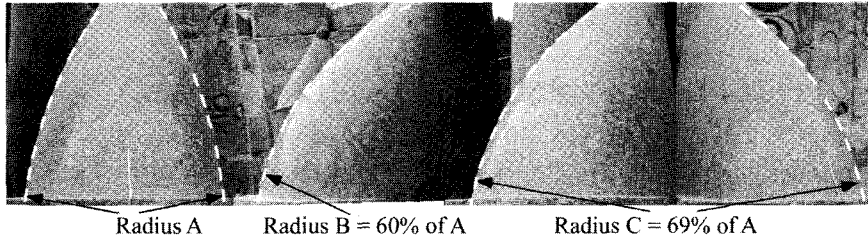

Figure 1.12. Front, side, and angled view of a crown

puter, I was astounded at the amazing accomplishment of these ancient craftsmen and, more important, of the fact that they saw fit to design these crowns to incorporate such a difficult and complicated work of art and engineering. From a conceptual and design standpoint, designing the crowns in this way would be a fairly straightforward task, but did the designer have any idea what he was asking of the craftsman who would cut his design into stone? He might have said to his friends, “Hey, want to see what I did to drive the guys in the shop crazy? I just made the design of the crown exponentially more difficult to manufacture.”

To accomplish such cutting today in one of the hardest natural

materials known and with such a high order of precision would require specialized equipment and careful planning. What tools did the ancient Egyptian artists and engineers possess? Were the tools they used as sophisticated as the products they created? What I discovered was not the product of a simple mind. The crowns are sophisticated products with difficult and exact surfaces that would challenge any craftsman, even one who is trained in today's methods and equipped with today's tools.

The next order of business was to take a photograph from the top of a crown looking down. My tripod was built so that I could extend a rod horizontally, but I discovered that the legs would not reach high enough above the crown to allow me to use it. This meant I had to hold the camera at arm's length while hoping that the resulting photograph would be useful.

The results were tantalizing enough to allow me to speculate that I could confirm more remarkable geometry if I could take a shot along the central axis of the crown, with all the features in full view. As it was, I had to be satisfied with what I had already obtained, because there was no way I could improve on the situation without building a platform. Preferably—and perhaps the Supreme Council of Antiquities will see fit to fund this one of these days—an engineering company should take a crown and fully digitize its geometry on a coordinate measuring machine or by some other technology accepted by the National Institute of Standards and Technology, formerly the National Bureau of Standards.

Nevertheless—imperfect shooting conditions aside—the results are noteworthy. From the top looking down, the crown at the widest point forms an almost full circle. It is interesting to note that in this view, the center point of the radius is off center relative to the top of the crown. This indicates that even though the upper right quadrant of the crown reveals less of the surface than the lower right quadrant, and the dotted line is theoretically touching the surface higher on the crown in the upper quadrants than the lower quadrants, there is still an almost perfect circle. This can mean only one thing that is extremely important

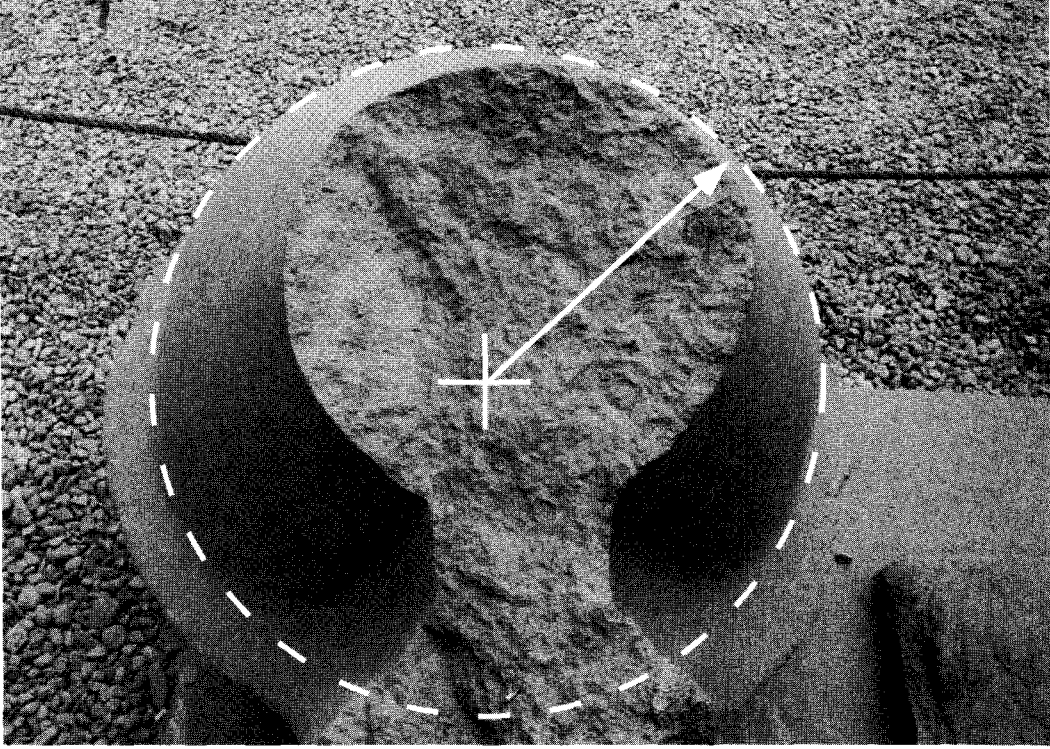

Figure 1.13. Looking down on the circle geometry of the crown

to an understanding of the sophistication of the designers and carvers of this artifact: to rotate a round object and observe the same radius at a different orientation indicates that what is being observed is a sphere and that this basic shape was used to design the crown.

To illustrate this: if you have a tulip-shaped wine glass in your cabinet, examine its shape as you move it around in your hand. Essentially, you are examining surface geometry that is similar to that of these Hedjet of Upper Egypt.

The wine glass is not exactly the same as the Hedjet, but it has the basic elements that contribute to the Hedjet's shape: a large radius blending with a smaller radius at the bottom. The tilted glass illustrates how a smaller radius could be evident in the Hedjet and supports the idea that the Hedjet approximated a sphere—at least toward the bottom of the crown.

If we look down on the wine glass, we can see that when it is tipped at an angle, the results are similar to those in the photograph looking down from the top of the Hedjet.

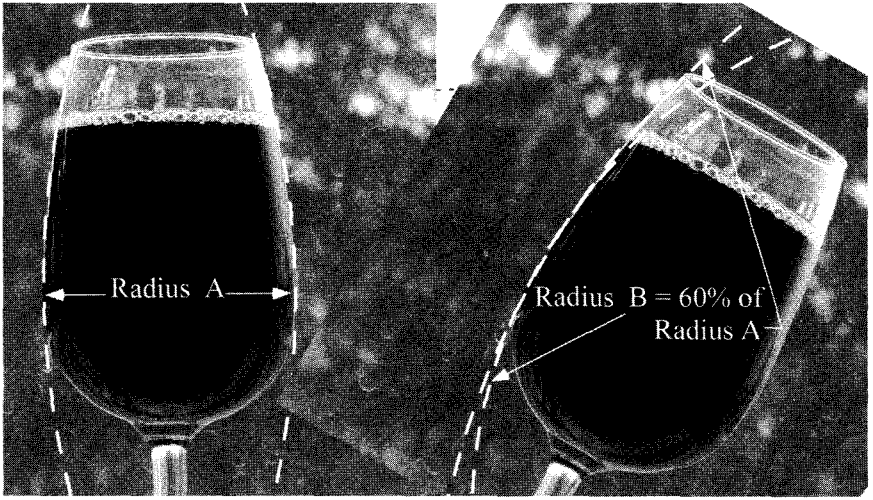

Figure 1.14. Geometry of a wine glass

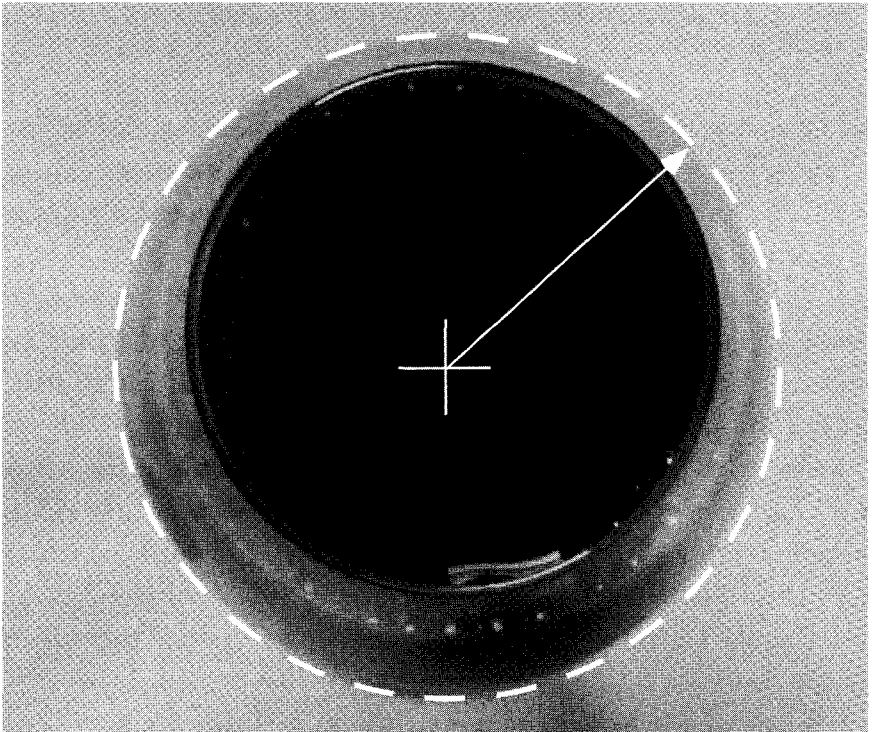

Figure 1.15. Looking down on the wine glass

From figure 1.15, then, it is clear that the geometry of the Hedjet was a sphere at the base and a sphere (the top knot) at the top. Between these two principle cosmic shapes, an infinite number of spheres were incorporated to form a perfectly smooth and precise surface. To understand how this works, we must examine an intact, unbroken crown that has escaped the ravages of time and abuse. One of the finest examples is found on the head of a statue at Karnak.

The upper profile is a circle that is a cross section of a blend radius between the top knot (a sphere) and the body of the crown. The bottom profile is where the White Crown portion blends with the Red Crown portion, and where the two meet is a precise blend radius, as figure 1.16 illustrates.

In figure 1.16, the blend radius of the White Crown (Hedjet) near the top knot, identified as A, and the surface geometry of the Red Crown (Deshret) identified as B, are profiles between which the surface

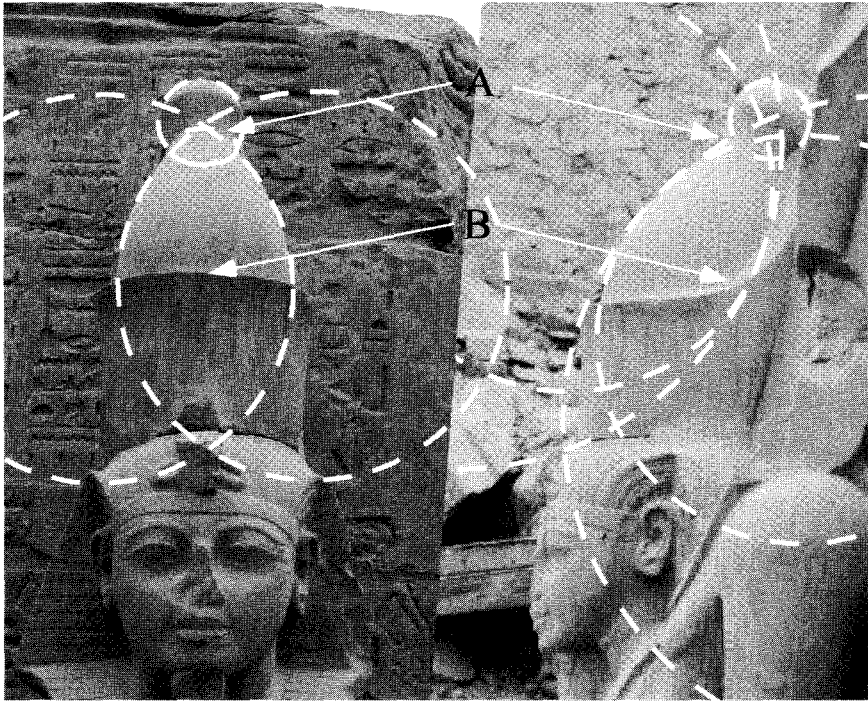

Figure 1.16. Front (left) and side (right) views of a Pschent at the Temple of Karnak

of the Hedjet is smoothly rotated around the central axis of the crown. The images indicate that the radial profile of this surface changes in size as it sweeps around to the front—constantly reducing in dimension. After examining figure 1.16, we might ask if the geometry of the White Crown is fashioned after the shape of a bowling pin, for which the same radius profile is turned, as on a lathe or a potter's wheel. As it turns out, this might indeed be the case. In figure 1.17, a series of spheres are drawn



Figure 1.17. The spherical nature of the Hedjet part of the Pschent

to fit within arcs based on the actual shape of the front of the Pschent, then are mirrored to create the theoretical opposite side at the back.

The best description of the Hedjet is that it is similar to a bowling pin that is tilted on an angle and that when it's combined with the Deshret it adopts precise geometries that make it more complicated to manufacture than a shape that could be produced on a lathe.

This is easily said, but how did they accomplish this in hard granite? To understand what the ancient Egyptians were able to accomplish, it would help to discuss where art becomes secondary to engineering. Art does not require the degree of exactitude found in these crowns to convey a message or evoke an emotion. Art, in general, is thought of—and usually is—outside of architecture. It is free-flowing, intuitive, and unconstrained by what are typically regarded as left-brain functions (e.g., the logical, disciplined application of precise geometry and mathematics). To understand this, we can look at a modern artifact that was created by modern tools to represent Ramses and that finds its way into the homes of those who have traveled to Egypt or who shop online for Egyptian iconic statues.

Figure 1.18 shows a statue that is obviously the work of a sculptor. As we can gather from the photograph, there was no expectation

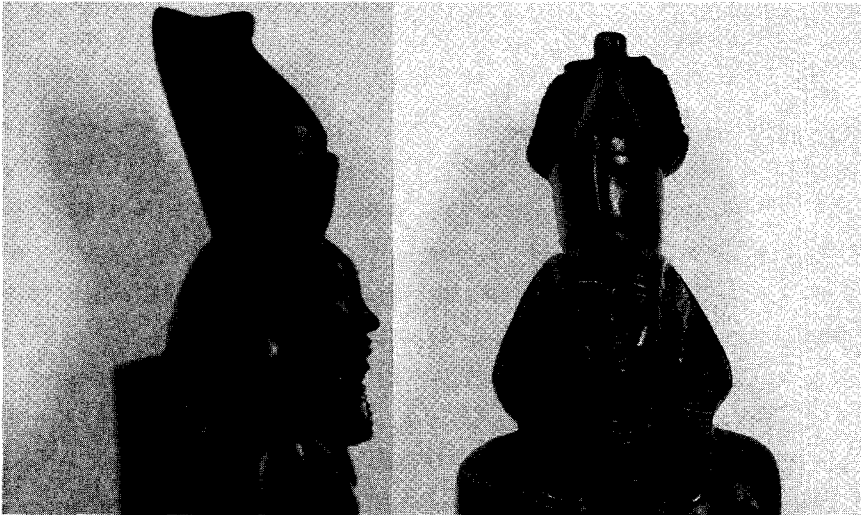

Figure 1.18. Souvenir statue of Ramses



of precision in the manufacture of the object, and none was achieved. That wasn't the objective for this object, and tools that would ensure precision were not employed in its creation. Bruno Walter, the famous orchestral conductor, said, "By concentrating on precision, one arrives at technique, but by concentrating on technique, one does not arrive at precision."<sup>4</sup> A corollary to this is that in order to achieve precision, we have to concentrate on precision. There is no getting around the exactness we find in the granite crowns. They were not the result of random coincidence, but the application of tools and techniques that were far more advanced than the tools and techniques that are currently attributed to the ancient Egyptians.

To find further illustration, we can examine briefly craftwork as it has been applied for many years. To the uninitiated, manufacturing plants might appear as behemoths that spew forth smoke and a stream of modern products. To the initiated, however, they are places where a very specialized subset of society and culture exists. There, institutional knowledge is passed from generation to generation and formal and informal hierarchies are established to create order and an understanding of how things should work. A casual visitor cannot recognize this. How could they? It may take some time spent in a manufacturing plant to learn that there are different skill levels and knowledge associated with those skills.

Outside of manufacturing, *precision* has a different meaning. We may appreciate the precision of our cars and cell phones, though we are oblivious to the technologies that are employed in their creation. As products have flowed out of manufacturing plants to consumers these past fifty years, they have transformed the world. What we enjoy today is the result of a manufacturing evolution focused on meticulousness and consistency intended to eliminate variables in the manufacturing process.

If we compare an automobile built fifty years ago to one built today, the changes are startling. Even if we look back thirty years to the mid-seventies and examine the fit and finish of our cars, we can see a huge difference in the precision of how parts fit together—the gap between a car door and the body, for instance.

Another difference we see in consumer products is the rounding and stretching of once angular body shapes to flowing curves and organic shapes. Notice how lights with oval, shaped contours follow three-dimensional curves to blend smoothly with the body of a car. All of these qualities are made possible by the introduction of new technologies into manufacturing that allow artistic engineering design modeled in a computer to transfer to machines that create dies with an exactness that at one time would have been either too costly or downright impossible to accomplish.

Because I have been involved in and witnessed these changes over the years, I have become familiar with definite surfaces and what was—and is—involved in creating them. Techniques have evolved from creating wooden or plastic models, and then tracing the models in machines in order to duplicate their shapes in hard steel to using computer models to generate instructions for machines to follow. I have run my hands over countless surfaces to check for irregularities and imperfections. The elimination of these imperfections has progressed over the years to what we have today. We now enjoy different kinds of aircraft, cars, refrigerators, televisions, and cell phones. They have a different look and a different “feel” to them than products of fifty years ago.

Figure 1.19 is the punch part of a die that creates the inner hub for an aircraft engine assembly. The hub starts out as flat sheet stock and is formed around the punch to create the shape seen in the figure. Because it is a round and concentric object, its geometry is not as complex as those of the Egyptian crowns. The rounded end of the punch is an ellipsoid shape. Figure 1.19 illustrates the minimum number of radii needed to create the ellipsoid as well as the elliptical shape itself superimposed on the tool. The similarities between the die and the crowns lie in the precision and the “feel” of the surfaces. Also common to both are the concentric circles that comprise their geometry. To have made this piece fifty years ago, we would have used a template mounted to a rail at the back of the lathe along which a stylus traveled to guide the tool that cut the material. Today, such shapes are routinely described in a computer program and downloaded into the lathe’s computer memory for execution.

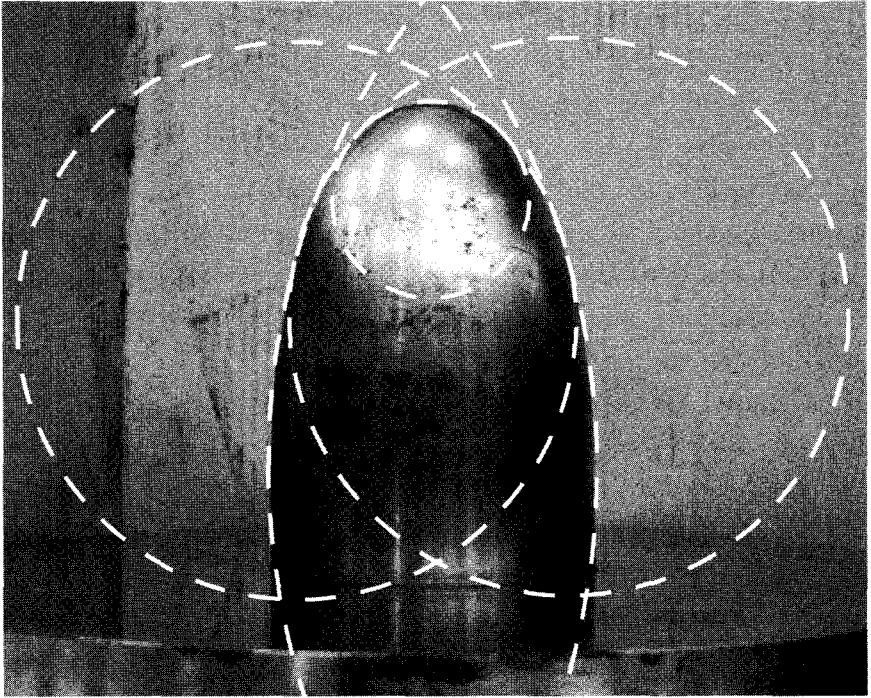

Figure 1.19. Part of a tail cone die used to create the inner hub of an aircraft engine

With the introduction of the ellipsoid, we can now look at the crowns in a different way. By drawing perfect ellipses and superimposing them on the photographs of the crowns, it becomes clear that the ancient Egyptians used this geometry, rather than a simple radius, in their design of the crowns.

The implications of finding such overwhelming evidence of sophisticated geometry can be argued by scholars into the future. Suffice it to say that elliptical geometry is not generally discussed in association with Egyptian geometry. For the purposes of the discussion here, though, I am more interested in how the geometry was crafted with such exactness in hard granite. This, then, is why I believe the crowns at Luxor are so important. They do not have the “feel” of products made by hand. They do not have the “feel” or the geometry of products made with simple and primitive machines or tools. If you travel to Luxor and run your hands over their surfaces of the crowns, you can compare

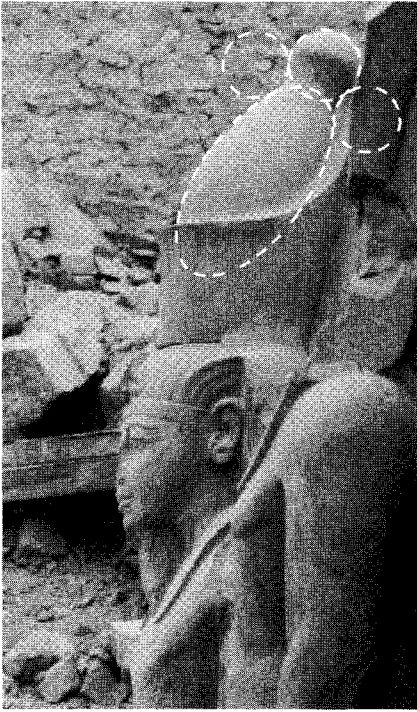

Figure 1.20. Karnak ellipse 1



Figure 1.21. Karnak ellipse 2

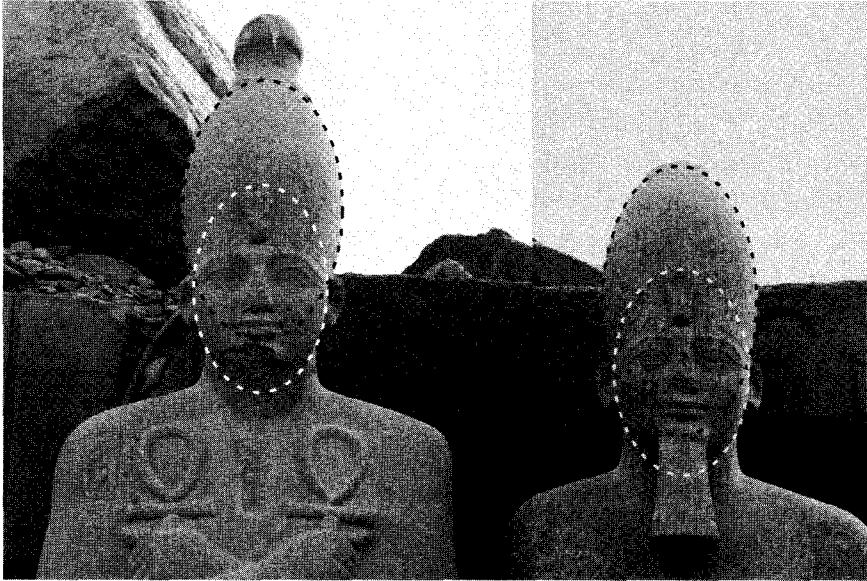

Figure 1.22. Karnak ellipse 3

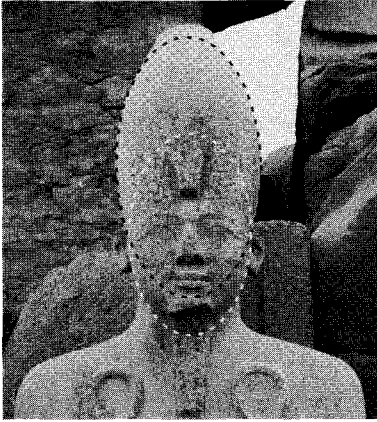

Figure 1.23. Karnak ellipse 4

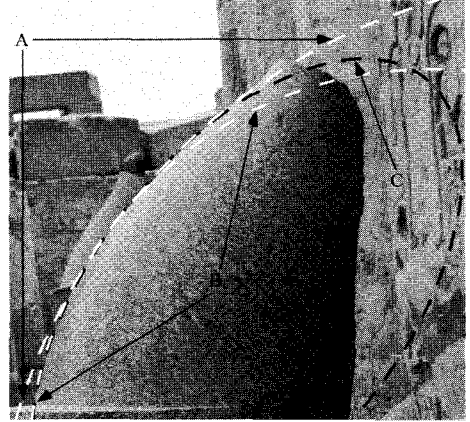

Figure 1.24. Ellipse of the first Hedjet of Ramses at Luxor

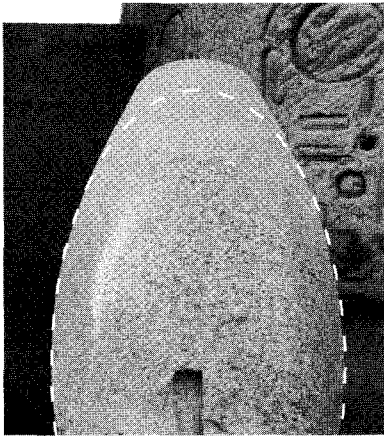

Figure 1.25. Ellipse of the second Hedjet of Ramses at Luxor

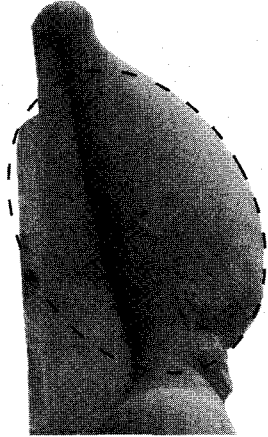

Figure 1.26. Ellipse of the third Hedjet of Ramses at Luxor

the “feel” of their smooth contours to those of your own car. These objects have the same kind of definitiveness and meticulousness as the dies that formed the body of your car. While you are online purchasing your ticket to Luxor, pick up your computer mouse and notice that it is crafted with compound radial surfaces. Contours that transition from large to small radii are products of precisely machined molds. We take

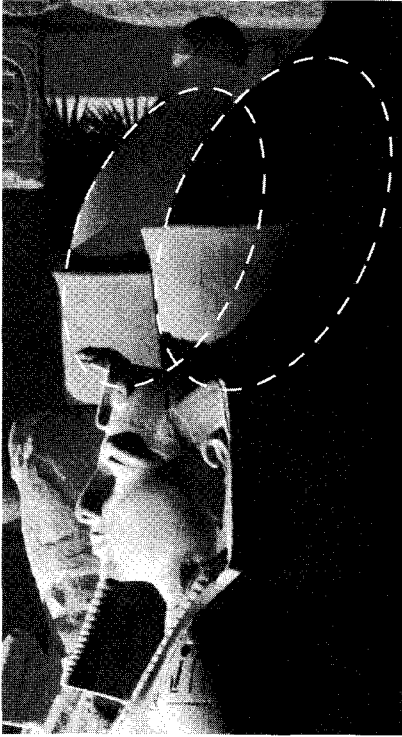

Figure 1.27. Ellipse of the fourth Hedjet of Ramses at Luxor. Photograph of the seated statues of Ramses in Ramses Hall, taken with a telephoto lens from the Sharia al-Corniche, the road that passes between the temple and the River Nile.



Figure 1.28. Ellipse of the fifth Hedjet of Ramses at Luxor. *Note:* Both figures 1.27 and 1.28 were taken at a distance in order to minimize the tilt of the camera from the horizontal plane. Even then, because of the height of the statues, the camera had to be tilted upward in order to capture the image.

them for granted, but there is an unseen world behind their creation.

And yet supposedly the crowns were crafted more than three thousand years ago. How could this be? How did the ancient Egyptians accomplish this? Why even conceive of such products if there were no tools to accomplish their making? What system of measure did they use?

The ancient Egyptians were known to use grids in their designs.<sup>5</sup> This indicates that they would have used what we know as Cartesian

geometry, though undoubtedly they would have called it something different. Nonetheless, being in the same world as us, we can be assured that they were working in three-dimensional space and had identified the orthogonal axes of orientation that we know as  $x$ - $y$ - $z$ . They probably also had developed the concept of pitch and yaw, the rotational axes that are associated with navigation within three-dimensional space. For these constructs, too, the ancient Egyptians would more than likely have had their own labels.

When fixing a Cartesian view to a crown that approximates the crown's orientation on the Ramses head, we see that its contours are not simple lathed shapes, but instead, they change continuously by degrees while conforming to a shape that, when measured at any angle around the object, is a true radius or combination of blended radii that form an ellipsoid. The sweeping curved surface was not the result of a random burst of artistic whimsy and a flourish with the chisel. It was a decidedly disciplined, orderly application of a design with tools that have not

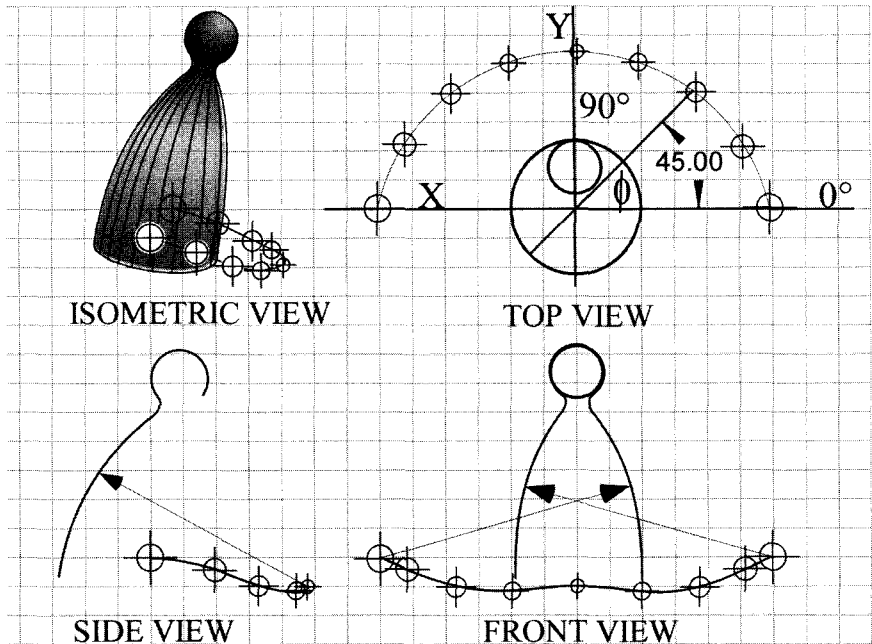

Figure 1.29. Inferred center points of radii around each crown

yet been found in the archaeological record, but which were built to achieve the precise removal of material.

The design and precise geometry that was crafted into Ramses' crown is a symbol of a society that was disciplined in precision engineering and craft. The pieces could not have been created without the aid of some kind of mechanical device that guided the tool along a prescribed contour. Neither was this mechanical device a simple machine. Figures 1.29 and 1.30 illustrate a path of the center point of an arc extrapolated from the geometry of the crown. If the designers were to convey to the engineers or craftsmen what they wanted, drawings similar to figure 1.29 and figure 1.30 may have been used. The design is one thing, but devising from the drawing a means of cutting the design into granite—with the exactitude noted in the photographs and transmitted through the palms of my hands to my brain as I felt each surface—is entirely another matter. Creating such an object today using modern computers, software, and computer numerical controlled (CNC) machines would present some significant challenges, to be sure—but not as much head scratching would be involved today as there would have been forty-nine years ago, when I first entered the manufacturing trade as a young apprentice. Applying the tools of fifty years ago to the Ramses challenge would severely tax craftsmen skilled in manufacturing, and the tools and instruments necessary to ensure such precise geometry would not even be in a sculptor's toolbox.

If we consider the use of a hand-operated device that allowed a tool to pivot around its center point, thereby striking an arc from the top knot of the crowns to the base of the granite, geometry dictates that as the tool sweeps along an arc, its path would be constrained such that precision is assured. The tool would need to be robust enough that it would not wander from its course. After accomplishing one pass, the pivot point of the tool would need to move along an orbital path around the granite. We can see from figure 1.12 (see p. 23) that the center point of the arc is actually lower at 45 degrees than it is at 90 degrees. This indicates that the center point's orbit around the crown may describe not a simple arc, but a wave. To explain this further, assume that the side



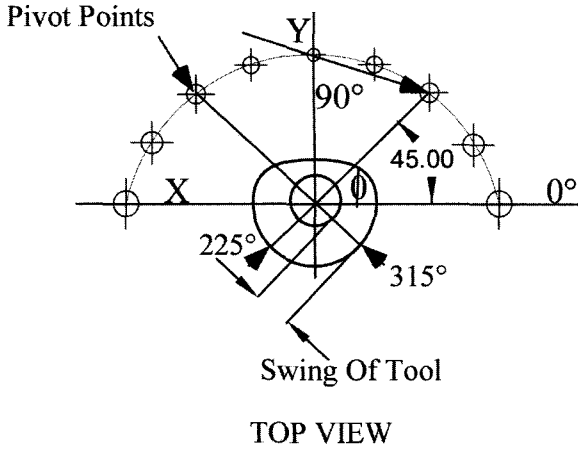

Figure 1.30. Directing the tool

view of the crown describes a contour that is at 270 degrees of a circle. Using polar coordinates (described in figure 1.30), we start the tool at 0 degrees and move it clockwise around the crown. At 315 degrees, the center point of the arc is lower than it is at 270 degrees, and the same applies at 225 degrees. As the tool is swung along its arc, the axis along which it moves follows an unwavering arc with precision between the tangency point of the blend radius at the top knot and the base, while the radius of the arc from 0 to 270 degrees gets incrementally smaller. Then, from 270 to 180 degrees, it starts to get larger again at the same precise increments that it did on the other side.

The challenges involved in creating the Ramses crown would be significant in any era. Fifty years ago we might question why we should devise such complex machines to create a crown that is going to sit atop a statue that is 40 feet in the air and far removed from close inspection. In today's world, if we had to create a dozen or so of these crowns and they all followed the same general design scheme—with some variations—it would be more efficient to create a computer model and generate a CNC program to automatically machine the piece. Then we would need to find a machine large enough to cut these crowns on—because they are not small by any means.

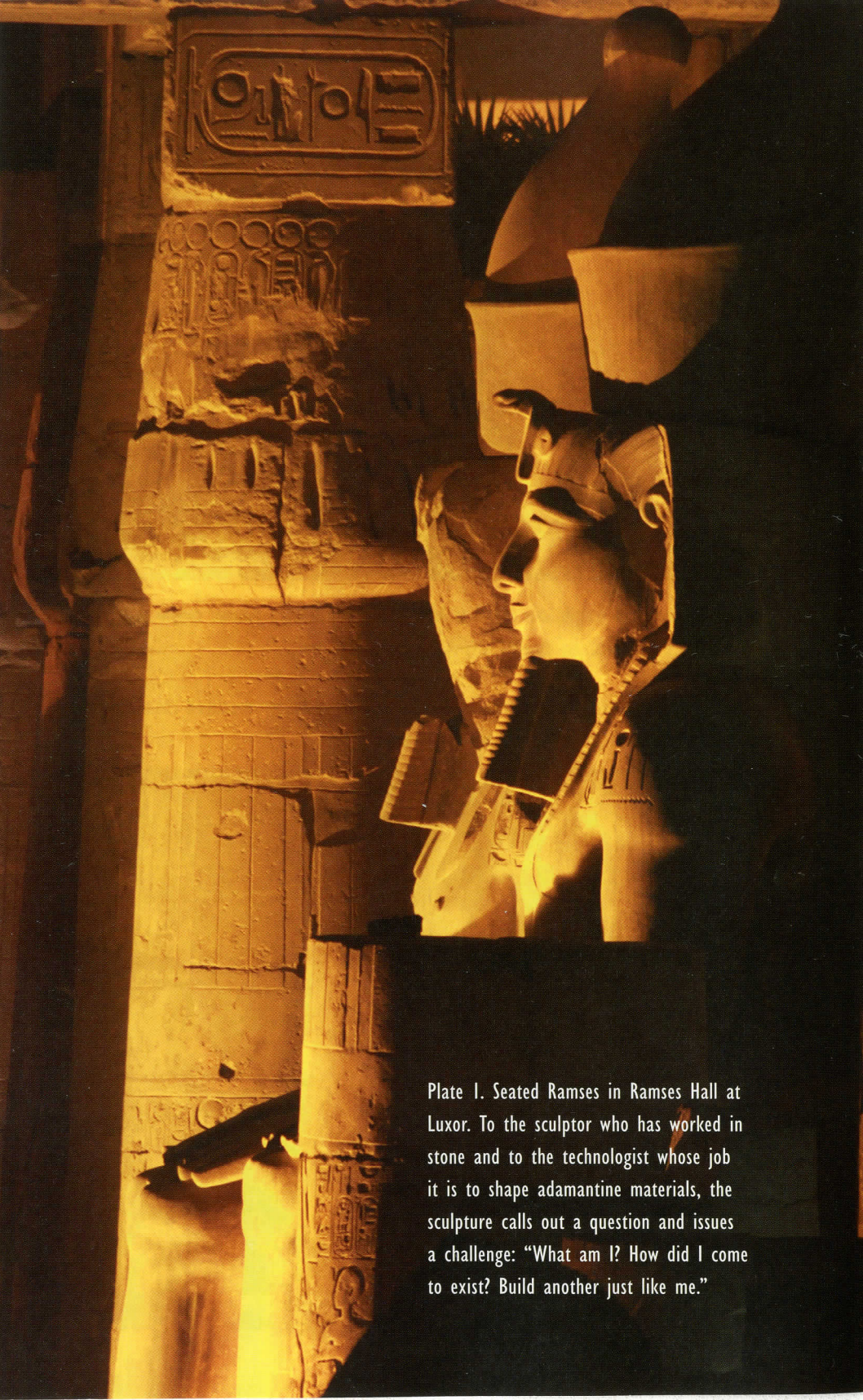

Plate I. Seated Ramses in Ramses Hall at Luxor. To the sculptor who has worked in stone and to the technologist whose job it is to shape adamantine materials, the sculpture calls out a question and issues a challenge: "What am I? How did I come to exist? Build another just like me."



Plate 2. Along the length and width of each crown, the surface follows simple arcs, a result of careful deliberation in concept, design, and manufacture.

Plate 3. The scale of the Egyptians' accomplishment is no better described than Ramses looking down on a throng of visitors to the temple.



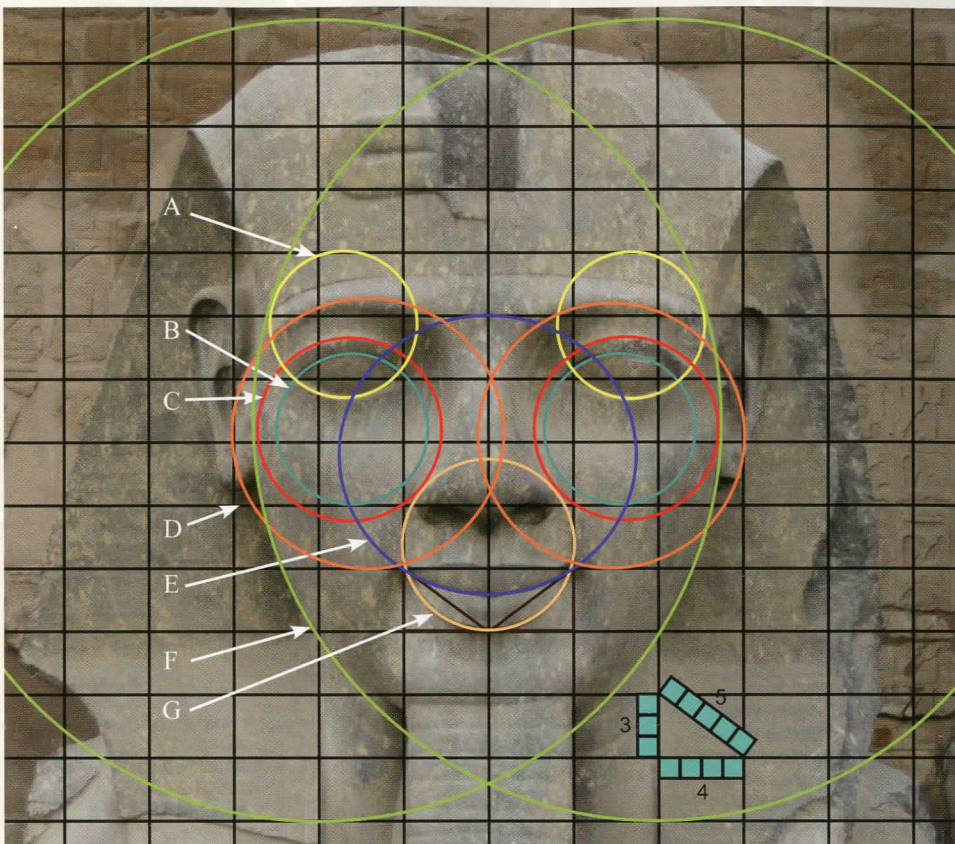

Plate 4. Ramses geometry speaks of unambiguous quality and exactness.

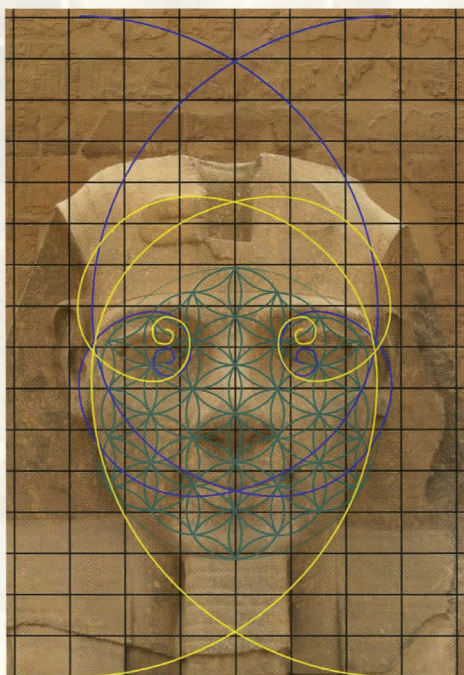

Plate 5. A happy coincidence and interplay between ancient geometry and art

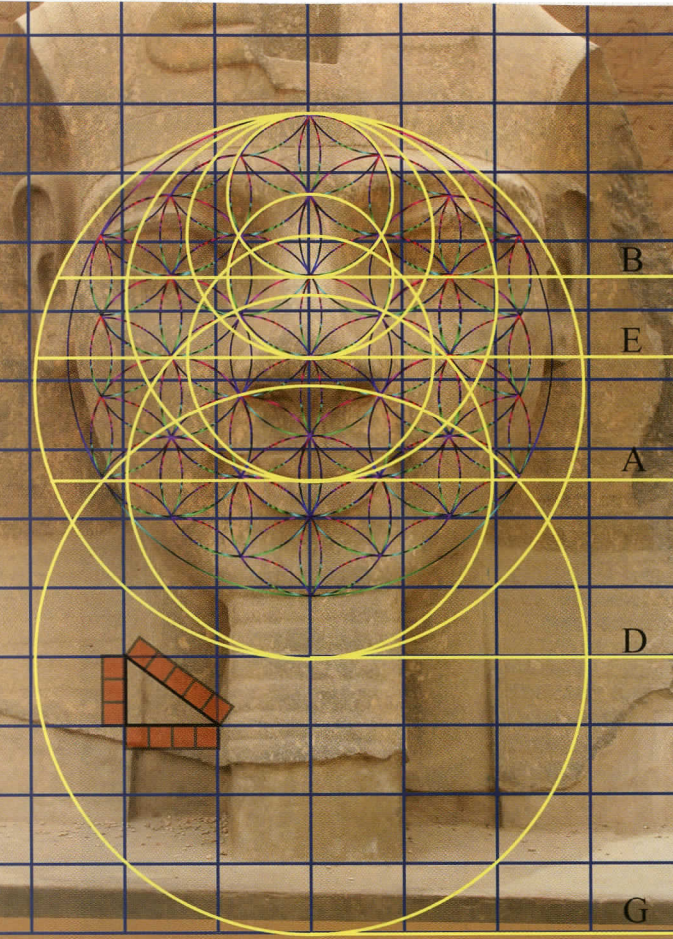
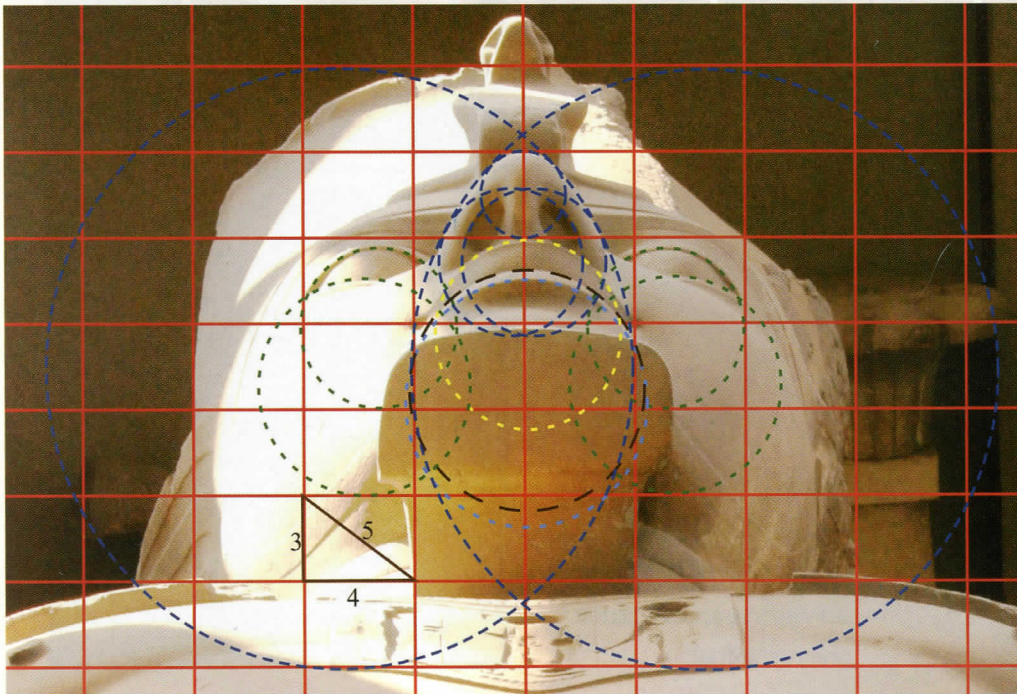

Plate 6. Divine harmony and iconic art combine in a symphony cut into stone.

Plate 7. Ramses at Memphis provides further evidence of uncompromising precision with ancient three-dimensional profiling.



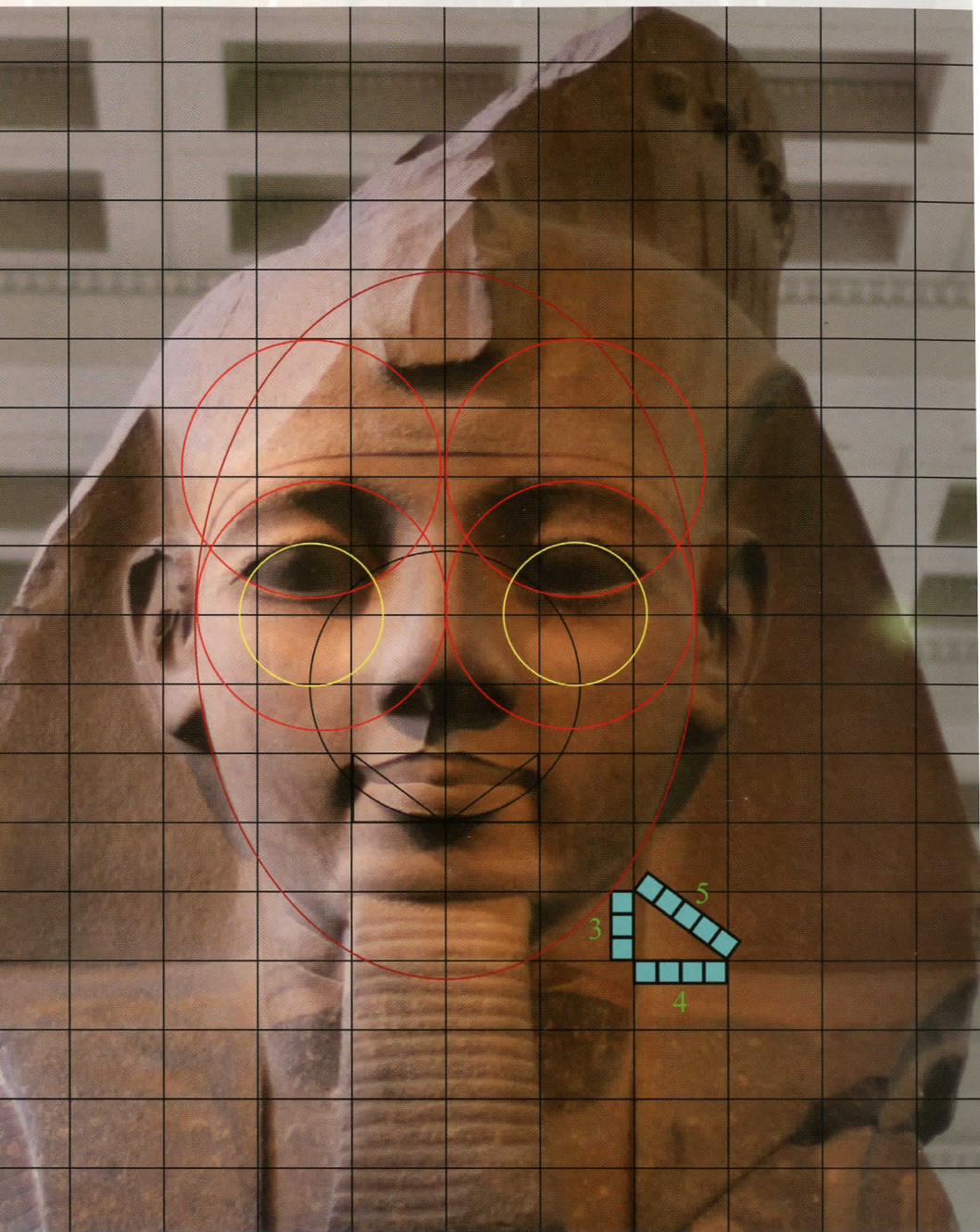

Plate 8. The Ramessesum Ramses inspires those in his presence to pay respect and understand what they behold.



Plate 9. The shadow cast along the face of Ramses at Karnak reveals the path of ancient tools.

Plate 10. Though unseen by the visitor, these ancient tool marks are revealed with the help of a telephoto lens and a computer's digital zoom.

Plate 11. The path a modern machine would take to craft a human head

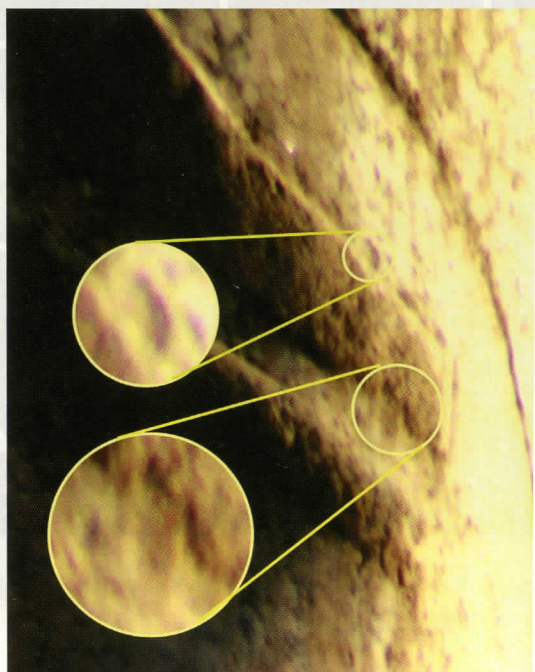
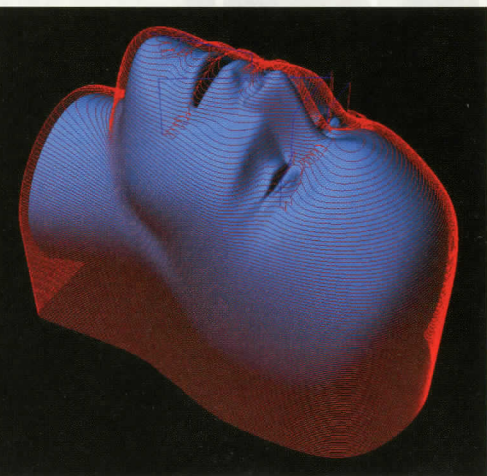



Plate 12 (left and below).  
Modern tools against  
ancient surfaces reveal  
a level of precision that  
should not exist.

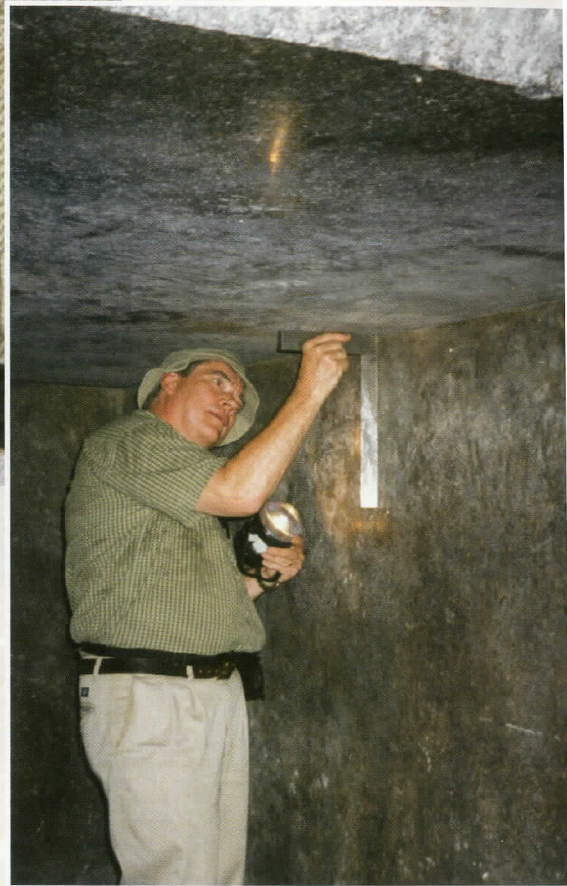

Plate 13. Inspecting the corners of the  
inside of the box in Khafre's pyramid  
and finding unnecessary precision for  
the stated purpose of the box

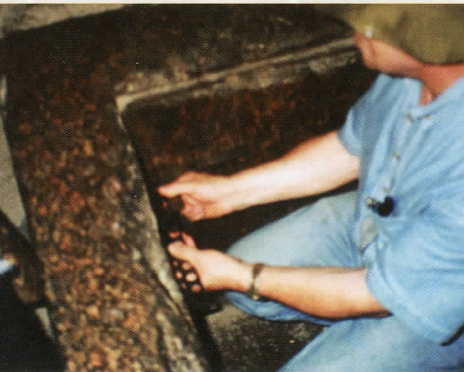

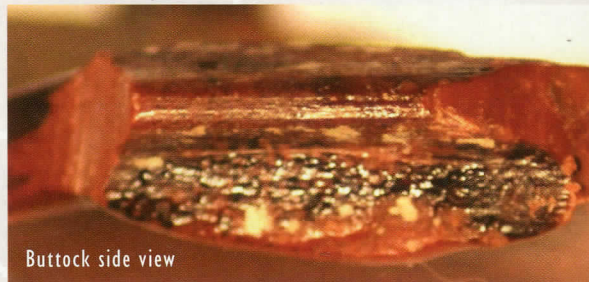

Plate 14. While Ramses' face held a benign and almost joyous look, Nefertari holds visitors at bay with pursed lips and a haughty stare.





Bench side view



Buttock side view

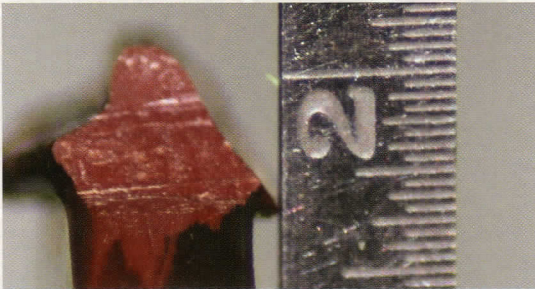
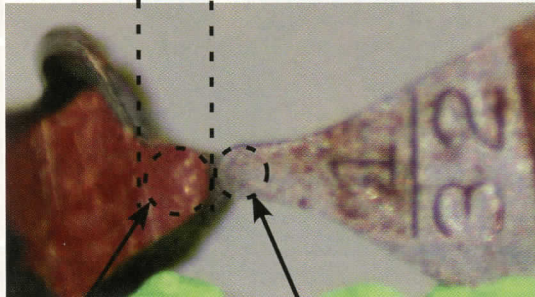

Plate 15. Wax impression taken of an undercut where Amun's buttock meets the bench on the Amun Mut statue in the Luxor Museum

→ ← .078 inch  
1.98 millimeters



∅ .071 inch  
1.80 millimeters

∅ .062 inch  
1.57 millimeters

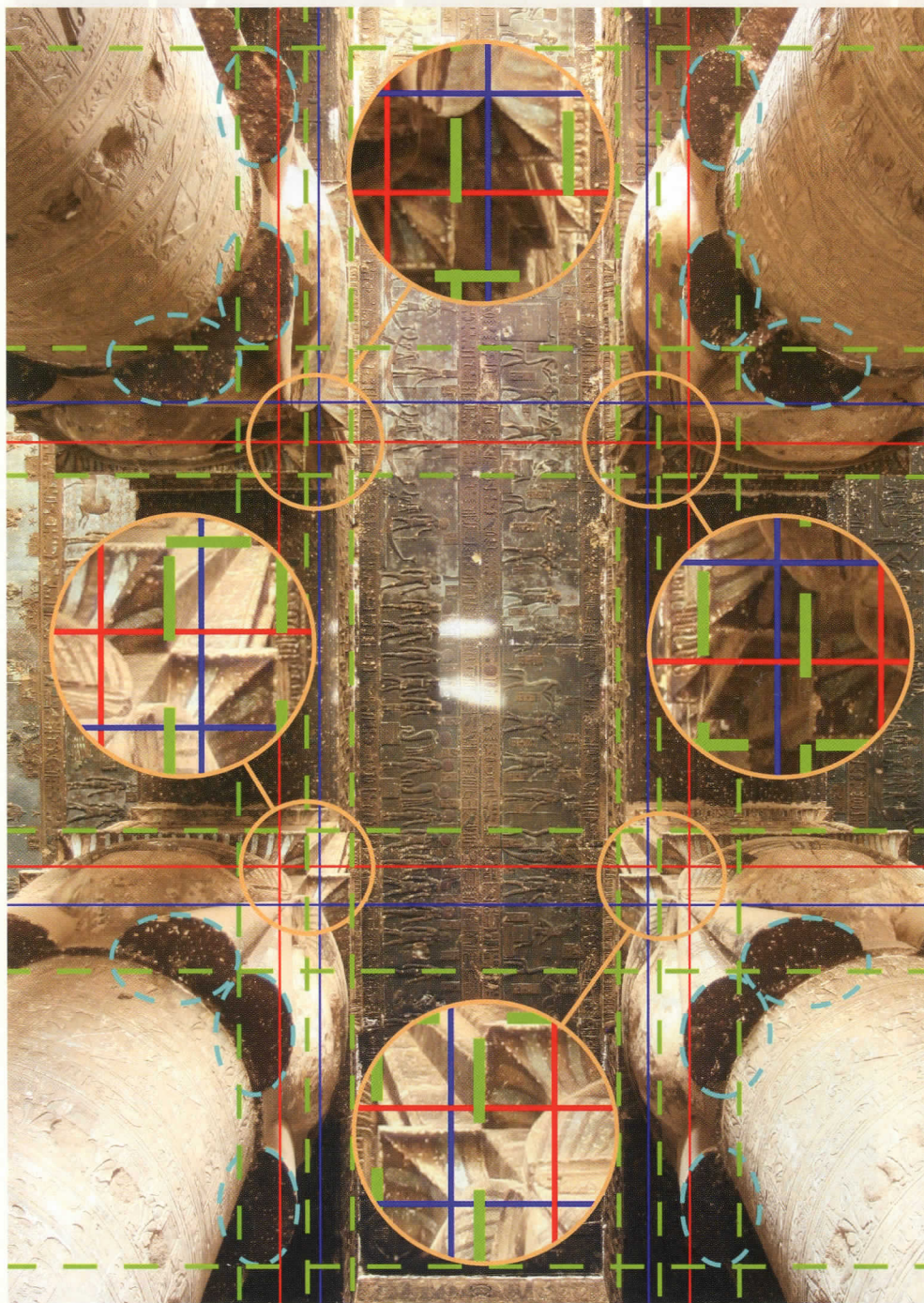

Plates 16 and 17 (above and opposite). The columns in the hypostyle hall at Denderah represent a unified assembly of manufacturing, engineering, and architectural brilliance. Connecting individual capitals, solid red and blue lines cross where the cornice and cowl intersect. Green dashed lines define the straight-line geometric elements of the cornice. Ellipses define the bottom of Hathor's tresses.





Plate 18. Views of one of several deep shafts in the Unfinished Obelisk trench

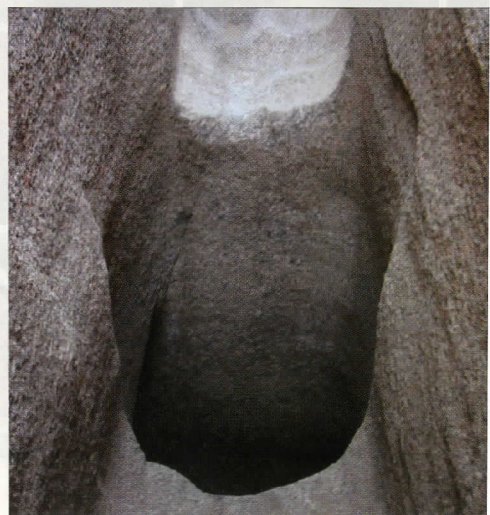



Finished block of granite

Long trench

Plate 19. A view from the top of the pyramid at Abu Roash

Plate 20. The curved granite stone at Abu Roash



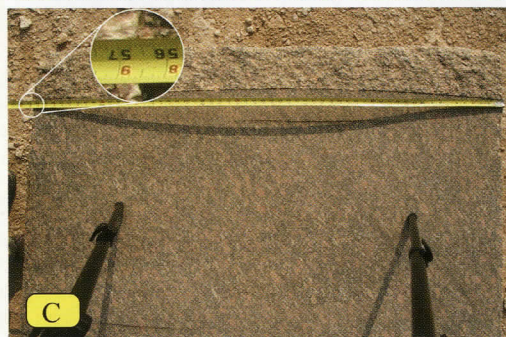
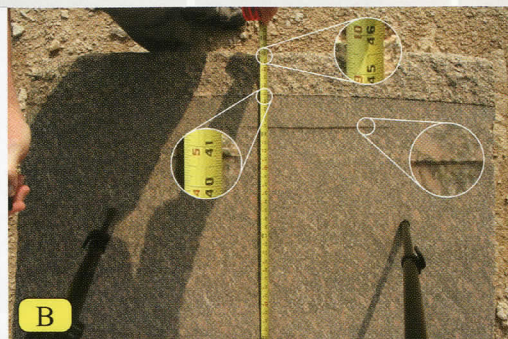
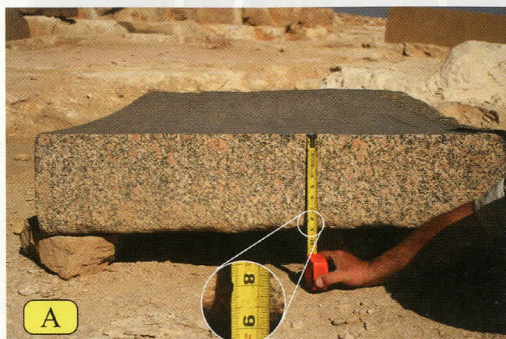

Plate 21. Measuring the stone at Abu Roash

Plate 22. Using a milling machine to replicate the curvature cut into the stone at Abu Roash

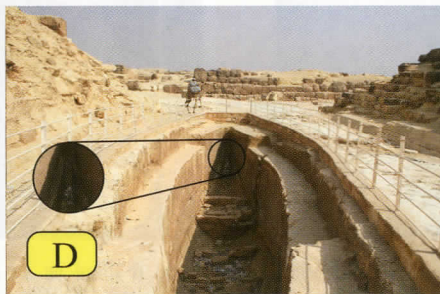

Plate 23. The Giza Saw Pits. These long trenches have been labeled “boat pits” by Egyptologists and are considered to be the symbolic transport of the dead king into the afterlife.

Plate 24. Did megamachines once cast their shadow on the Giza Plateau? There are some who believe they still do.

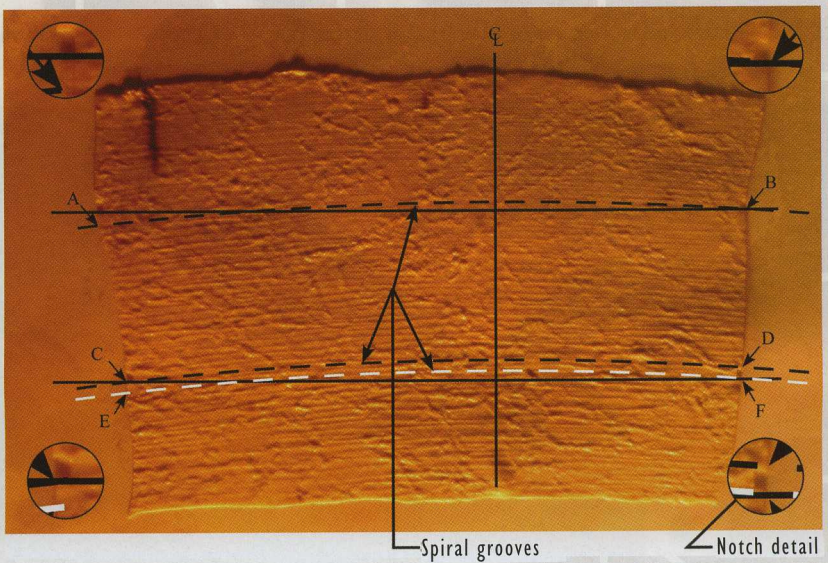





Plate 25. Petrie's Core 7. The left photograph shows it tilted on an angle, while the right photograph illustrates the core in a vertical orientation.

Plate 26. Geometry of a spiral groove on the unfolded latex impression of the Petrie's Core 7



What we find in Egypt, therefore, are examples of ancient ingenuity and technology that up to now have had no place in academic understandings of Egyptian history. Moreover, we have become so effective at convincing the world that the Egyptian civilization was not as technologically advanced as the Greeks or Romans, and certainly not the West, that many modern Egyptians themselves believe our story and are loath to accept any other.

It has been a common theme that the ancient Egyptians used simple, even primitive, tools and methods—so revisionist historians cast their eyes around the world to give credit to another culture. For instance, it has been speculated that these accomplishments were created by Atlanteans or aliens, because the prevailing view is that the ancient Egyptians could not possibly have done the work. I do not support such views. It is my firm belief that the work was performed by Egyptians—but Egyptians who possessed much superior knowledge and tools than we have heretofore credited to them. Consider the simple fact that these hidden symbols of technology became evident and understandable only through the use of modern technology and its standards of exactness and consistency.

Conception, execution, and verification are the phases of manufacturing. The ancient Egyptians must have used all three, with the last phase—verification—confirming the success of the first two. The only phase available for us to study is the last phase. From what we have learned from Ramses' crowns, we can determine that clearly the ancient Egyptians' level of technology must have been higher than what is revealed by the archaeological record. The question we are left with, though, is this: What technology did they possess? While the results of the ancient Egyptians' technology are now revealed by modern tools such as digital cameras and computer software, this does not mean that these tools were available to them. There is still a huge question mark regarding this facet of ancient history. In order to understand more about the technology used to create the crowns, we must take our studies further and look at how the rest of the statues were made. In the next chapter, complexity reaches a new level as we come face to face with the astounding results of an even more difficult challenge: Ramses' head.

## 2

# The Shadows of Ramses

*Uneasy lies the head that wears a crown.*

SHAKESPEARE, *HENRY IV, PART 2, ACT 3, SCENE 1*

*Our life is an apprenticeship to the truth that around every circle another can be drawn; that there is always another dawn risen on mid-noon, and under every deep a lower deep opens.*

*This fact, as far as it symbolizes the moral fact of the Unattainable, the flying Perfect, around which the hands of man can never meet, at once the inspirer and the condemner of every success, may conveniently serve us to connect many illustrations of human power in every department.*

RALPH WALDO EMERSON, *ESSAY ON CIRCLES*

The symbols left behind by the ancient Egyptian culture, a civilization that was brought down by a force of nature we tremble to imagine, have been the inspiration of countless scholars, artists, and ordinary laypeople. When it comes to studies of ancient Egyptian art and sculpture, the images we see evoke admiration and wonder and spark the imagination



Figure 2.1. The Cosmic Egg

about what the Egyptian civilization found important. Resoundingly, what emerges is that the ancient Egyptians were deeply immersed in the mysteries of life and the survival of the soul after death. At the same time, they were not so submerged in spiritual matters that they eschewed materialistic comfort and pleasure. They acknowledged the hand of superior forces in the universe, and they spent a considerable portion of their wealth paying homage to the fickleness of gods as nature was interpreted by them and appeasing and preparing to be affected by nature's cycles on both a personal and community level.

From what we studied in chapter 1, we can gather that as a community, the Egyptians must have had an education system that taught citizens to understand geometry, and that they used geometry in a sophisticated way. The crowns in the Luxor and Karnak temples provide insight into a heretofore hidden school of design and manufacturing that started on the drawing board and resulted in finely crafted, very exact, and exquisite artifacts. Though they have been severely damaged by unknown forces, a sufficient amount of evidence remains that allows us to gather data with which to make an accurate analysis. Scattered on the ground from Alexandria to Cairo to Aswan, the evidence tooled into granite, diorite,

quartzite, and basalt—the hardest substances the ancient Egyptians could find in large amounts—may be all that is left to tell us how technically advanced these people were. To seriously consider replicating their accomplishments is a step toward understanding their advancement.

Continuing with the Ramses challenge, in this chapter we will study the head on the Ramses statue that sits outside the Temple of Luxor just a few feet from the obelisk. We don't know what forces separated the head from the body, but for our purposes, it seems quite fortuitous, in that it allows for a close inspection.

The ancient Egyptian engineers and craftsmen were more than capable of designing and manufacturing elegant, sophisticated, and precise shapes out of difficult-to-work granite, and they crafted impressive Hedjets and Pschents—the crowns of Egypt. It goes without saying—and, as we will see, the evidence shows—that the designers of the Ramses statue used the same talent to set about designing and crafting the pharaoh's head. As we can see by reviewing the process, this proved to be even more of a challenge than the crafting of the crowns.

During my visit in February 2006, I took photographs of the Ramses head after I photographed the crowns. At the time, I had not analyzed the crowns and was not expecting the symmetry and exactness that I saw in them. Similarly, from the perspective of a manufacturer, I pondered the symmetry of the Ramses head without really expecting the results that I ultimately gathered. It seemed highly improbable to me that a complex, three-dimensional surface profile could be replicated with exact precision from one side of the head to the other without employing some fairly sophisticated manufacturing techniques. I took my photographs not knowing what I would later uncover.

Ramses' exaggerated smile cannot be seen on the faces of normal people. I have looked for examples of such a smile and have not seen one on even the happiest face. Certainly, there are mouths that curl up at the corners, and a smile from such a mouth is a pleasure to behold. Ramses' face, however, is relaxed, and only the mouth appears to be smiling; there is no effect on the eyes and cheek muscles. We might wonder whether such a mouth was seen in ancient Egypt among the

citizenry or whether the designers were trying to please their gods by presenting an idealized image to them that they would find pleasing.

When I imported my original image of the head into the computer (see figure 2.3), I struck a horizontal line across the face and rotated the image until the line was barely touching the underside of the bottom eyelid. I then duplicated this image and flipped it horizontally so that the left cheek became the right cheek. I then made a 50 percent transparency of the image and lined it up with the jawline. As shown in figure 2.3, there is no variation between the left jaw and the right jaw.

Thinking about only this correspondence in the geometry of the face made me sit up and take notice. This symmetry means that the face was crafted so that a mirror image of the outline of the face was transposed to the opposite side. It is an incredible accomplishment that this exact line moved in three-dimensional space to create a perfect mirror image when viewed in two dimensions. My mind was racing at this point. What did the ancient Egyptians use to create such perfection? How did they inspect the geometry of the face? The same questions I asked when I studied the crowns flashed into my brain—though with more force and consternation. A human face is by far more complex and sophisticated than an ellipsoid that is blended with another form to form a crown (which we examined in chapter 1).

Of note, also, is the close alignment of the ears. Figure 2.2 shows clearly Ramses' left ear with some of its upper portion missing. In figure 2.3, this is evident, but at the same time, the ear cavity is very close to a perfect match. To be able to define the geometry of the ear is a challenge. To reproduce the geometry in three dimensions on opposite surfaces with 3 feet of granite in between these points—and to control their positions as precisely as these photos indicate—dispels forever the notion of ancient sculptors chipping away with stone hammers and stone or copper chisels.

Close your eyes and imagine a line that bisects your head vertically down the center, and then lightly touch the same point on your left and right ear with your index fingers. The touch of each finger feeds through pathways to the brain, the ears, and the fingers to create a sense of orientation. While undertaking this exercise, notice how your index



Figure 2.2. Ramses Head

fingers move slightly until you have a sense of equilibrium between the two. Yet how close is each fingertip to the imaginary axis bisecting your head? It's impossible to tell! Even though the left hand does know what the right hand is doing and both fingers provide sensory feedback to the brain—through the fingertips and ears—the brain cannot determine how precisely each ear was placed in relationship to the central axis of the head. Even the visual benefit of performing this exercise in front of a mirror will leave you lacking accurate data.

Figure 2.4 shows Ramses from two different angles and provides a view of each ear that is close to perpendicular to the face of the ear. I set up the camera to capture an image that was the same angle from the central axis. To accomplish this, I made adjustments so that the tip of the nose seemed barely to touch the far cheek from both angles. It should be noted that I could not achieve absolute precision under the circumstances because of the terrain and the lighting: I took the image on the right at a lower elevation than the one on the left, and this causes



Figure 2.3. Reverse transparency overlay matching the jawline

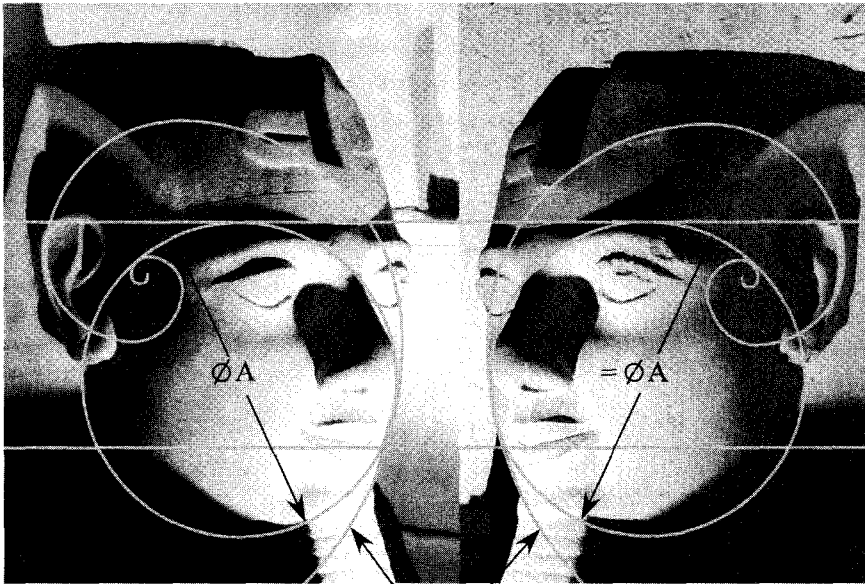

Fibonacci spiral

Figure 2.4. Left and right view of Ramses' head



a misalignment with the statue, because the camera angle is tilted up more for the right shot than when I shot the left side. Nonetheless, the results are quite intriguing.

The lines were applied to the photographs as references in order to size the two images of Ramses in the computer. I should stress here that the images were not distorted from their original aspect ratio during this process. I superimposed the Fibonacci spiral there to see if any correspondences occurred. Amazingly, there seems to be an uncanny and harmonious congruity between the spiral and the circle, as well as between the spiral and elements of both sides of the head. As I sized it to fit one side, then mirrored it for the other, the spiral was not changed in its size or aspect ratio.

Fibonacci, also known as Leonardo Pisano, published his discovery of the properties of the series 1, 1, 2, 3, 5, 8, 13, 21, 34, and so forth, in his book *Liber Abaci* in 1202,<sup>1</sup> but the mathematical construct was previously used in Indian mathematics by mathematician Virahanka (sixth century CE).<sup>2</sup> It has also been said, not without controversy, to have been used by the Egyptians in their architecture—to define, for instance, the geometry of height and slope of the Great Pyramid.

I should state here that my inclusion of Fibonacci spirals and circle geometry is not the result of a search for esoteric symbolism in the statue; it is simply a means to discern how the ancient Egyptians had created Ramses. I am not arguing that the ancient Egyptians intentionally encoded it into their statue. My investigation is intended more to illustrate the symmetry and exactness of the piece and explore the manufacturing implications than to argue for secret mystery schools, sacred science, and Leonardo da Vinci-style occult symbolism. Though I find these subjects fascinating, they are outside the scope of this book, and there are others who are far more knowledgeable than I on these subjects—so I will leave any such discussions to them.

The line that follows the shape of the ear in figure 2.6 is not a Fibonacci spiral but was generated from one ear, then copied and mirrored on the other. From the photographs, it is clear that there are slight differences between the two ears—but one ear is damaged and

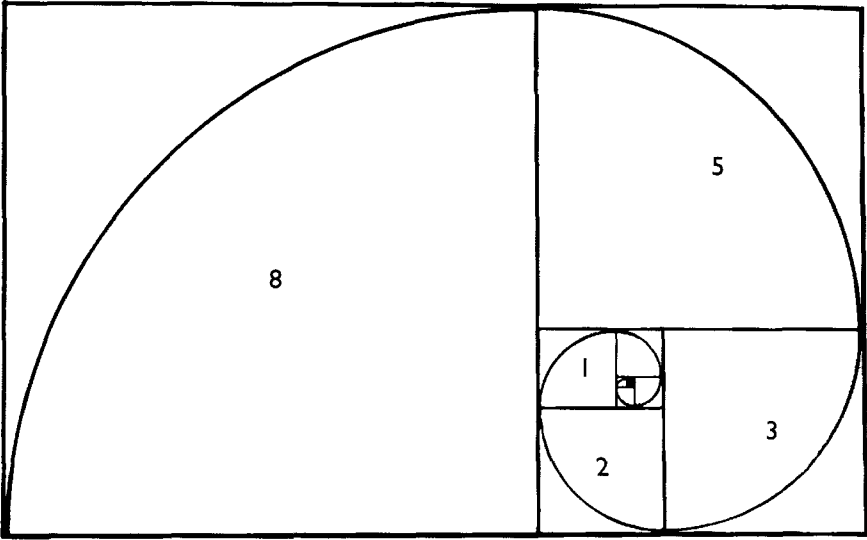

Figure 2.5. Fibonacci spiral

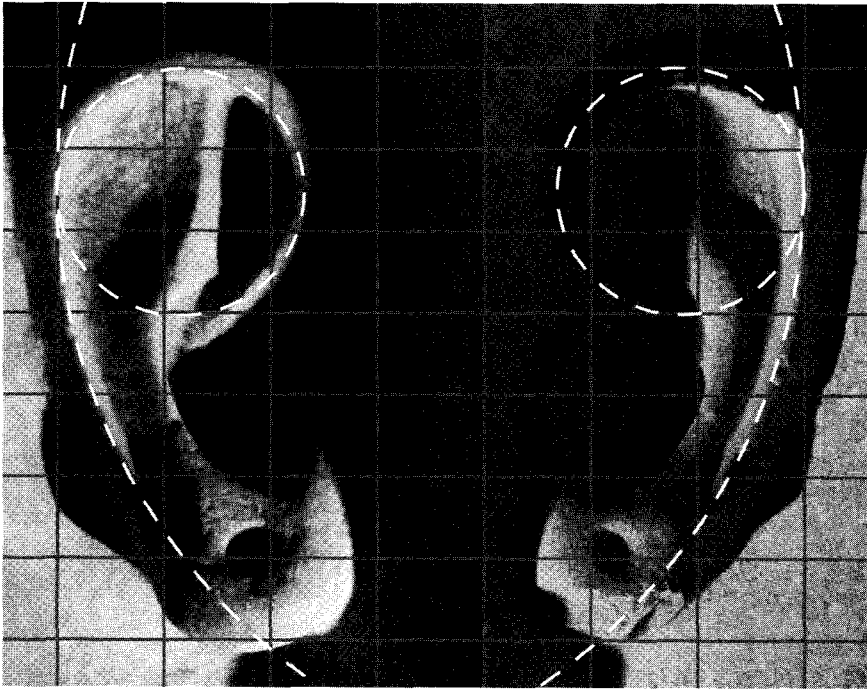

Figure 2.6. Ramses' ears

the lighting on both varies such that we cannot state with confidence that they are identical within precise tolerances. What we can state, however, is that figures 2.3, 2.4, and 2.6 illustrate a nearly impossible task for a sculptor. The probability of the finger on your left ear and the finger on your right ear being positioned within the tolerances shown in this series of photographs is virtually zero. The possibility of a sculptor creating a head with a jaw line that is identical on both sides and two ears that are within the tolerances as shown in these photos is also vanishingly small.

To accomplish what we see here, one has no other option but to focus on *precision*. We are confronted here not with a coincidence, a stroke of luck impressed with crude, handheld tools, but a stark reality that the order of precision found on Ramses' head demanded that the sculptor move into the realm of engineering and its essential science of measure: metrology.

If we study the face further, it becomes obvious that the reverse

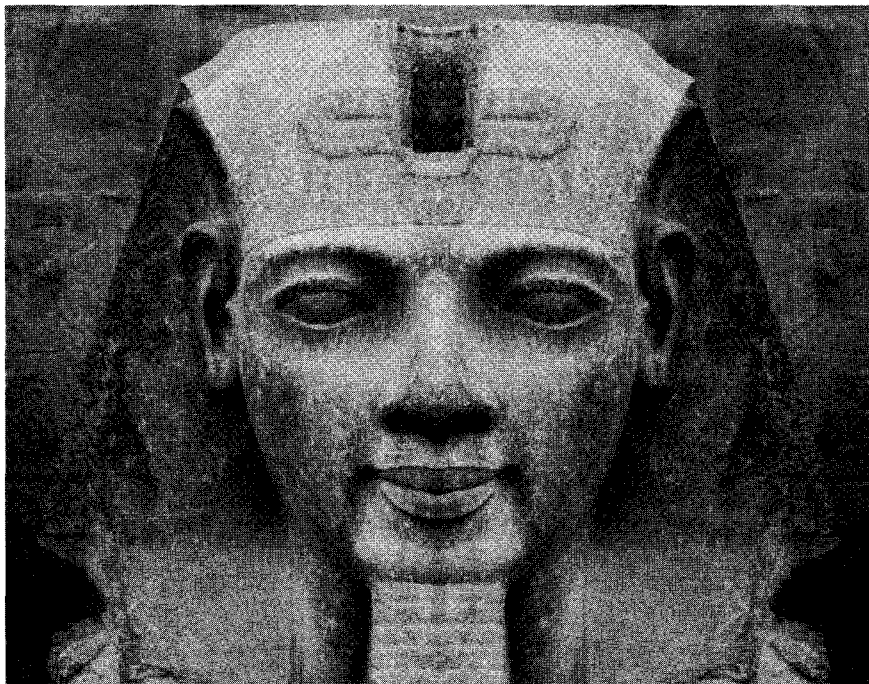

Figure 2.7. Reverse transparency matching the eyes and mouth



Figure 2.8. Reverse transparency matching the nose

image is not a perfect match. The nose, mouth, and eyes—all principle features of the face—do not match with the jaw in alignment. Nonetheless, moving the transparency over these features slightly brings them together, though not all at the same time.

### RAMSES' SHADOW

Given the off-center alignment of the photographs of Ramses' head, it became clear that I had to return to Egypt. When I examined the photographs I took of Ramses' head in February and began to compare the symmetry from one side of the face to the other, I realized that in the photographs I took when my camera was handheld (as opposed to on a tripod), the central axis of the camera frame was not quite in alignment with the central axis of the statue. I knew that I could not capture an image that was perfectly in alignment without trial

and error, and what I had produced had errors, so I determined that I could do better if I was able to use a tripod stand and take a series of photographs while moving the stand incrementally around the head and keeping the nose in the center of my viewfinder. To understand why this tripod setup is so important, we can consider the following series of sketches that represent a view from above looking down on the head.

The ideal camera setup is illustrated in figure 2.9. To achieve this, the camera axis is oriented exactly along the central axis of the head, which is a theoretical line that bisects the features of the head. If an image of the head is then taken, flipping the image on its horizontal axis would make for an identical image.

Figure 2.10 shows the head rotated 1 degree from center. What this means is that when the image is copied and flipped and compared to the original, some features will not match.

The arrangement we see in figure 2.11 is the same one that was captured by my camera with my first set of photographs of Ramses' head—when I copied, flipped, and overlaid a transparency onto the original. As we saw in figure 2.3, the mouth, nose, and eyes do not match, but the jaw outline matches perfectly. This is because the outline of the face is used to establish the central axis of the photograph and the nose is rotated slightly off-center.

As depicted in figure 2.7, by making the mouth the center point, the outline of the face is thrown off axis and the nose is thrown off axis. The eyes, because they are approximately at the same distance from the camera as the mouth, then come into alignment.

Even with a less than perfect alignment, however, I was elated by this discovery. The implications were immediately clear to me—and they were enormous. My preliminary studies indicated that the statue was crafted so that the left side was a mirror image of the right side. I realized then what was needed: I had to take another series of photographs and hope that one of them presented a closer alignment with the central axis of the head.

The photographs I took in May 2006 were certainly an improvement

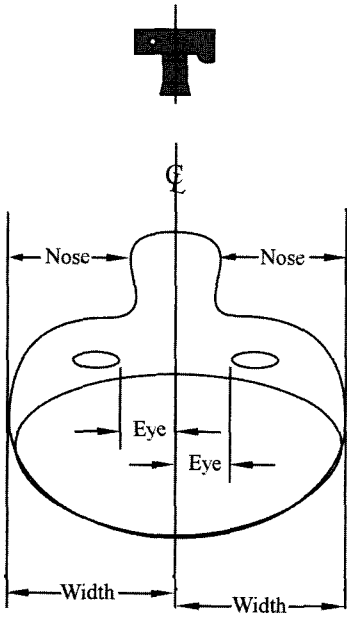

Figure 2.9. Top view of camera setup. The central axis is identified with an L overlapping a C, which is the standard notation engineers use in their drawings to denote a centerline.

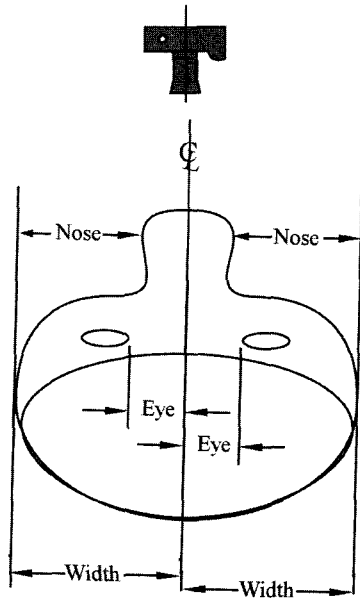

Figure 2.10. Rotated head

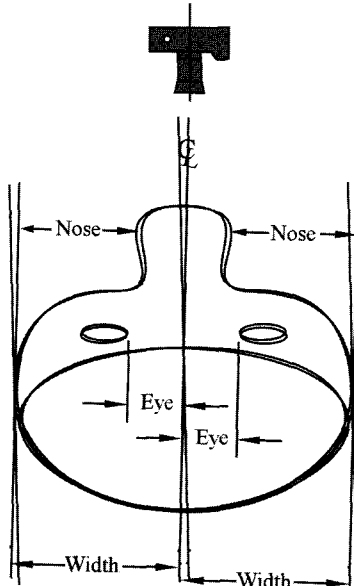

Figure 2.11. Double image



Figure 2.12. Ramses' symmetry, taken in incremental steps while moving the camera in an arc around the statue

upon those I took in February. However, I was still not quite satisfied with the results and returned in 2008 with a better camera that resulted in figure 2.12, which is photograph 70 of a series of 94 photographs that I took while moving the camera in action mode while panning in an arc around the statue, keeping the nose in the center of the viewfinder. I then duplicated the image and mirrored it and made a transparency, then positioned this over the original to match the features of the face.

As we can see, the match is much closer, but not perfect. Figure 2.12 shows that the jawline, mouth, and eyes match, but the nose is slightly off center. Figure 2.13 shows a close-up of the nose and mouth with the nose in alignment. It should be noted that the amount of error in the orientation of the camera is actually half of the width of the shad-

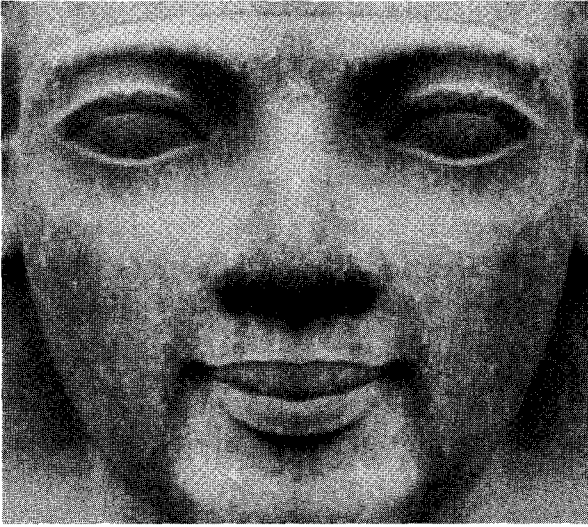

Figure 2.13. Ramses' nose symmetry

ows revealed when different features are brought into alignment. If the camera was adjusted by half the amount of the error shown, then all shadows may disappear.

As we can see from studying figure 2.13, the jawline, mouth, and eye from the right side appear to line up perfectly with the left, but it appears that the nose is slightly off center. In figure 2.14, the nose is brought into alignment and a shadow appears around the jaw and the lips. The shadow is quite useful for our study, because it actually provides a reference line with which to calculate the percentage of error from one side of the face to the other. These results are stunning—beyond anything I had imagined.

Though visually the comparison between the two sides of the face is remarkably similar, dimensionally it requires further examination with metrology equipment to measure exactly the differences between the two sides. From a manufacturing perspective, the dimensional variation from a perfect form (i.e., the tolerance band) on the contoured surface of a form die depends on the ultimate function or purpose of the piece. Today's machine tools can produce complex contoured surfaces to a level of accuracy that was not within the capability of machines forty



years ago. When we compare Ramses' head and modern machined surfaces, the analogy does not register as relevant or fitting, because the end products are created for completely different reasons, and a statue does not require the same precision as a contoured surface for, say, a rocker panel, a trunk lid, or a hood for a car body. Nevertheless, the comparison using a digital photograph compelled me to try to determine some kind of dimensional reference so that we can say with a reasonable amount of certainty that I was not influenced by an optical illusion.

To this end, and in order to draw from the photograph a relative dimension from one cheek to the other, I enlarged the photograph to approximately five times that of a human head and applied dimensions (measured in inches) from a vertical centerline to the outline of the jaw. In this way, there was no interference with an overlying transparency and the resulting shadow; thereby there was less uncertainty as to exactly where the edge of the face was.

The results in figure 2.14 show that the camera's axis was shifted to the left of the axis of the head, and the dimensions of the nose and the ears indicate that a mere 0.140-inch (3.55-millimeter) rotation of the camera to the right would bring these dimensions closer to being the same. On a human scale, the amount of error in the orientation of the camera would be 0.028 inch (0.711 millimeter), just slightly more than the thickness of a thumbnail. The dimensions of the jaw line are within a tolerance band of plus or minus 0.010 inch (0.254 millimeter), which on a human scale is plus or minus 0.002 inch (0.0508 millimeter). Close to the ears the tolerance band increases to plus or minus 0.065 inch (1.65 millimeters), which on a human scale is plus or minus 0.013 inch (0.33 millimeter).

Though they do not achieve perfection—but are much closer to the central axis of the head than those I had taken in February and May of 2006—the photographs featured in figures 2.12, 2.13, and 2.14 taken in November 2008 illustrate that slight variations in the camera angle can yield different results. Without specialized equipment and special permission, it is impossible to achieve the laboratory-type analysis that I am convinced must be achieved in order to quantify exactly the accuracy to which these statues were crafted. With the aid of two-

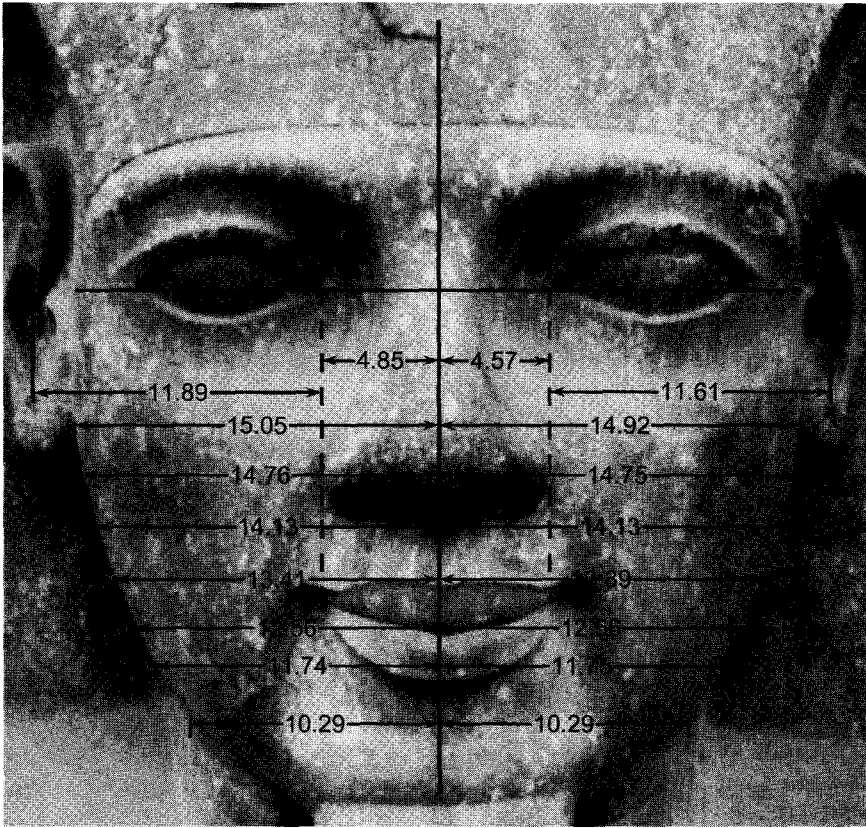

Figure 2.14. Ramses precision

dimensional computer software, though, we can extract some basic geometric information about the artifacts and compare one half of each face against the other. In this manner, we can glimpse, through the fog of millennia, the minds of the designers of the sculpture, and we can conclude that a sophisticated geometric protocol was used. Designers, engineers, and craftspeople in the modern era may relate to the complex sculpted surfaces that have been proven here to create both sides of the face in mirror image.

The contoured surfaces of Ramses' symmetrical face would be familiar to designers of everyday products that are created routinely today with computer algorithms known as non-uniform rational B splines (NURBS), which allow them to smoothly morph one shape to

another with unbroken perfection. By using NURBS, computer-aided design programs create contours of airplane wings, turbine blades, and even the computer keyboard at your fingertips. Surfaces are now routinely designed and manufactured to the apparent precision of Ramses' head. Incredibly, the ancient Egyptians were also able to routinely craft Ramses' head and achieved the same results again and again from the north to the south of their linear, Nile-based empire.

The stunning implications are analogous to looking through the static interference pattern of time and confusion and seeing the elegance and precision that is normally built into a Lexus in a place where only the most rudimentary techniques of manufacturing are thought to have existed. The techniques that the ancient Egyptians are supposed to have used—those taught us in school—would not produce the precision of a Model T Ford, let alone a Lexus or a Porsche.

## BACK TO THE DRAWING BOARD

There should be no question in our minds now that Ramses' face was carefully designed using a system of measure that was based on geometric proportions. But what geometric shapes did the ancient Egyptians use, and how were they applied in the design?

We know that the ancient Egyptians used a grid in their designs,<sup>3</sup> and that such a method or technique for design is intuitively self-evident. It does not require a quantum leap of an artisan's imagination to arrive at what is today a common design method. In fact, it is used now not just for design, but also for describing organizational and conceptual methodology. Grids, graphs, and charts are used to convey information and to plot and organize work.

With this in mind, therefore, I took the photograph of Ramses and laid a grid over it. Of course, my first task was to establish the size and number of the cells used in the grid. I assumed that the features of the face would lead me to the answer, and studied which features were most prominent. After musing over this question for a while, I took a chance on a grid that was based on the dimensions of the mouth. It seemed to

me that the mouth had something to tell us due to its unnatural shape, so I placed a grid with cell dimensions that were the same height and half the width of the dimensions of the mouth. It was then a simple matter to generate circles based on the geometry of the facial features. I didn't expect, though, that they would line up with grid lines in so many locations. In fact, I was astounded by this discovery. Going through my mind was: "Okay—now when does this cease to be a coincidence and become a reflection of truth?"

### PYTHAGORAS MEETS RAMSES

Plumbing the grid for further information, I discovered that Ramses' mouth had the same proportions as a classic 3-4-5 right triangle. The idea that the ancient Egyptians had known about the Pythagorean triangle before Pythagoras, and they may have even taught Pythagoras its concepts, has been discussed by scholars, though not without controversy.<sup>4</sup> Ramses presented me with a grid based on the Pythagorean triangle, whether it was the ancient Egyptians' intentions or not. As we can see in plate 4, the Pythagorean grid allows us to analyze the face as it has never been analyzed before.

In a manner similar to that of the geometry of the crowns, as discussed in chapter 1, plate 4 shows that circle geometry was also used in the design of the face. The correspondences that appear between the grid and the circles that are generated by the facial features are numerous and noteworthy. This design scheme is fairly simple and elegantly harmonious, because all elements are interrelated and have connections to each other, whether crossing or touching their companion elements. For example, Circle A, the bottom eyelid, and Circle C, which describes the top of the upper eyelid, touch Circle F, which outlines the jaw. At the same time, Circle A is tangent to the grid and crosses the grid and Circle B at the same point. All the circles are tangent to the grid except circle C, which is tangent to the jawline. Circle G, which describes the arc of the lower lip, is tangent to the grid and Circle C. These elegant correspondences were created with full knowledge that

minor changes in the circle diameters would provide different information, so it could be argued that a different geometric scheme could have been intended. However, the point in presenting it this way is to illustrate the geometric constructs that an artist might use if they were going to paint a portrait of a perfectly symmetrical head. What elevates the importance of this design is the fact that it was three dimensionally crafted, with elegance and precision, in hard granite.

### FIBONACCI MEETS RAMSES

We may ask if there might be another way to describe the geometry of Ramses' face. I pondered this question for a long time, and while examining the shape of the ear, I thought perhaps a Fibonacci spiral might have been employed in the design.

A Fibonacci spiral is created by blending a series of arcs that are generated using three corners of each of the squares depicted in figure 2.5 (see p. 47)—with one corner as the center point of each radius. As it turns out, the Fibonacci spiral did not match the geometry of the ear. Yet because I had already drawn the spiral in the computer and had the image of Ramses up on my computer screen, I tried to see if there were any correlations using a Fibonacci spiral with the geometry of the face and the Pythagorean grid. Once I established the grid pattern and the circles, I trimmed back the circles and drafted the outline of the nose to create figure 2.15.

Using the outline of the Ramses face with just the Pythagorean angle grid, I applied a series of well-known geometric constructs to determine whether any correlation existed between Ramses' head and more advanced geometry than what I had seen so far. Quite remarkably, the oval that frames Ramses face is based on the Pythagorean 3-4-5 triangle (its height is 1.333 times greater than its width).

As we discovered earlier, the Fibonacci spiral is based on the number series 1, 1, 2, 3, 5, 8, 13, 21, and so forth (see figure 2.5 on p. 47). Figure 2.16 illustrates how the spiral corresponds to the drawing of the Ramses' face and the grid.



Figure 2.15. Ramses' outline drawing

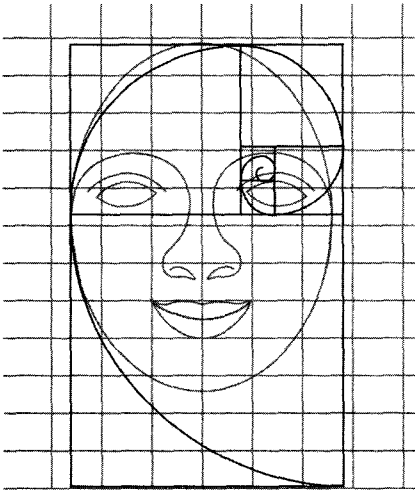

Figure 2.16. Ramses, Pythagoras, and Fibonacci

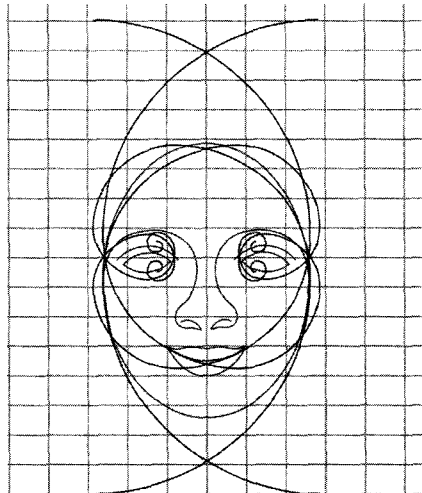

Figure 2.17. Ramses with four Fibonacci spirals

Figure 2.16 illustrates the construction of the Fibonacci spiral using the Fibonacci series 1, 1, 2, 3, 5, and 8. As we can see, the spiral has been sized to touch the right jaw and to circle the eye. We can note other correspondences to the bottom line of the grid and the top of the oval that was created from the outline of Ramses' jawline.

Figure 2.17 was created using copies of the spiral that are mirrored horizontally and vertically. The vertically flipped pair was aligned with Ramses' mouth. We can see correspondences where the spirals cross and where they end on grid lines at the top and the bottom.

### LEONARDO MEETS RAMSES

The Golden Ratio, or Greek Phi  $\phi$ , expressed as the mathematical constant 1.6180339887, has been used in art and architecture, including in such Renaissance masterpieces as Leonardo da Vinci's painting of the Last Supper and in the Notre Dame Cathedral in Paris. Its proportions are said to be embodied in the human form and can also be found in nature, but certainly it is used deliberately by those who strive to achieve aestheticism in their work. The proportions of the Golden Ratio, also known as the Golden Section, are expressed using both triangular and rectangular shapes.

Figure 2.20 illustrates four Golden Rectangles of equal proportion. The rectangles that frame the width of the nose look narrower than the

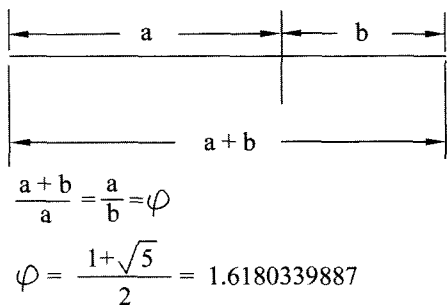

Figure 2.18. The Golden Ratio

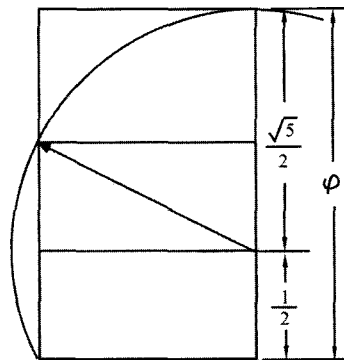

Figure 2.19. The Golden Rectangle

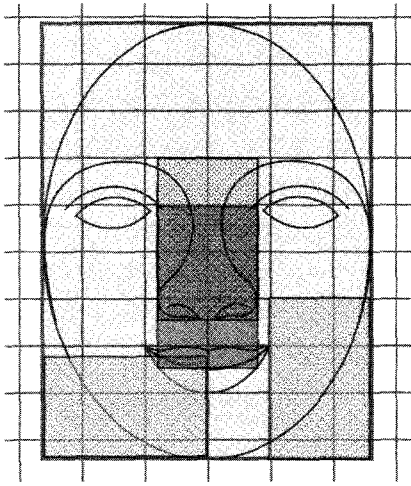

Figure 2.20. Ramses' Golden Rectangles

other two, but this is an optical illusion caused by two overlapping and offset rectangles. The rectangle was generated using the width of the nose as the base square multiplied by 1.618033, the Golden Ratio, to achieve the height ratio. The rectangle was then positioned under the nose, where we see it lined up with the eyebrow grid line.

Three copies of this Golden Rectangle were then made, and two were then fitted to the bottom corners of the Golden Rectangle that frames the oval shape of Ramses' face, with one Golden Rectangle on the left bottom corner rotated 90 degrees. The third Golden Rectangle was then shaded differently and placed with the bottom surface aligned with the Ramses' mouth. As figure 2.20 illustrates, the top of this Golden Rectangle corresponds with the grid line that is tangent to Ramses' eyebrows.

It would seem reasonable at this juncture to suggest that the key to Ramses' geometry has been discovered. The face, grid, and Golden Rectangle working in unison strongly imply that all three were used in the placement of the different features of the face. This geometry and the circles seem to give us enough information to explain the two-dimensional drawing of Ramses. However, while this is a compelling argument, the testimony of the famous architect I. M. Pei may cast



doubt on the intentional application of the Golden Section by the ancient Egyptians. His design of the pyramid at the Louvre in Paris is considered to be a masterpiece and incorporates the Golden Section in its design. During an interview with Ekwanim Productions of Paris he was asked if he was inspired by the same proportions that are found in the Great Pyramid. Pei claimed that he came by the Golden Section naturally and that he has abandoned strict adherence to measurement, preferring to arrive at his designs through his intuitive and artistic eye for what is pleasing, and the Golden Section appeals to a more right-brain approach to shaping the architectural landscape. The question should be asked, therefore, whether the ancient Egyptians were similarly influenced. Regardless of what their answer might be, however, engineers working under the direction of Pei, as well as those involved with the designers of Ramses, had to apply measurement to convey to the craftspeople the information they needed in order to bring what may have been inspired creativity into physical manifestation.

Unfortunately, the question of Ramses' head is much more complicated, because it involves three-dimensional geometry, not just lines and circles on a flat piece of paper.

## RAMSES BOUQUET

While working in my CAD program, my wife suggested that I see how the Flower of Life fit with the geometric scheme that was crafted into Ramses' face. I didn't think much of the idea (probably a typical left-brain engineer response), but nevertheless, I set about drafting a Flower of Life in my computer. The results are fascinating to look at, but far be it from me to suggest that the designers were dropping flowers all over their plans! Yet this superimposition illustrates, in an analogous way, the complexity of the three-dimensional geometry of Ramses.

The Flower of Life symbol is considered to be sacred among many cultures around the world and is seen as symbolic of the connectedness of all life and spirit in the universe. It is found inscribed in some temples in Egypt—most notably at Abydos, where it is drawn, with meticu-

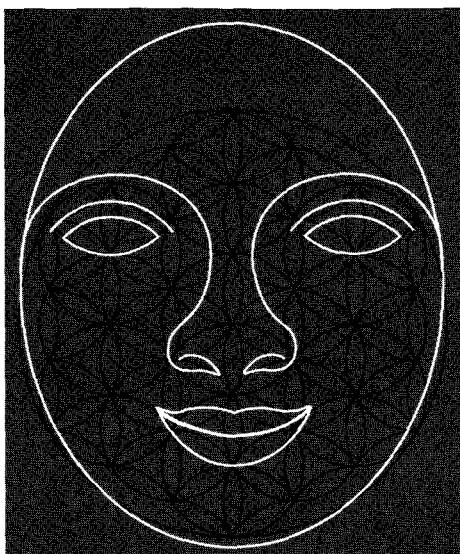

Figure 2.21. Ramses bouquet: the Flower of Life

lousness, in red ochre on a giant granite support column in the Osirian. The temple contains several of these drawings, and they are believed to have been placed there when the Osirian was filled with sand, for they are located high on the column.

The geometry of the flower consists of intersecting circles that create six equally spaced petals. The arrangement of the flowers in a mandala is supposed to symbolize unity with the cosmos and aspiration for harmony and perfection. It is a powerful icon in the Indian culture, and it commands profound philosophical and religious reverence.

Though I am not arguing that the use of these geometric elements were necessary to create Ramses' head, the correlations with the statue of Ramses do illustrate the reality of a greater sophistication than what two-dimensional images can convey.

## FROZEN MUSIC

The mathematical principles of musical harmony are directly related to geometry. Pythagoras brought these concepts to the Western world

and inspired the orderly and disciplined understanding of objects we observe and create. Leonardo da Vinci used geometric archetypes, sometimes called *sacred geometry*, in his art. The German writer Goethe and the English expatriate Oscar Wilde, as well as the philosopher A. W. Schlegel, considered architecture to be “frozen music.”

Grand musical events are planned with the accompaniment of the imposing grandeur of frozen music. To celebrate the inauguration of Cairo’s Theatre de l’Opera in 1869, Ismail Pasha, Khedive of Egypt, commissioned Giuseppe Verdi to write an opera. Inspired by ancient Egyptian architecture and with the help of Auguste Mariette, he produced *Aida*, which has played for large audiences at Luxor and more recently on a large, specially built stage at the foot of the Giza Plateau. Egyptologist Zahi Hawass pleaded for the set to be removed, because it detracted from the archaeological value of the area.<sup>5</sup>

Though we don’t normally consider objects around us to be musical, as a carefully designed and crafted geometric shape, a musical instrument that sits quietly in the corner of the living room could be considered frozen music. In this respect, the analogy between architecture and music can be considered correct—but it may also pose the question of whether there is such a thing as frozen music at all. It could be argued that when an observer is introduced to and interacts with a geometric structure, whether it is an instrument to play or a building within which to play, it has an effect on the senses. Without the presence of people, the building responds to subtle energies from the earth and the environment through seismic or thermal movement of its structural components. An instrument adds its own voice, responding in resonance to weak forces, but the output cannot be discerned by the human ear. The grand piano sitting in the corner of my living room plays a faint encore after all sources of sound are turned off and nothing but quiet reigns.

Scottish composer Stuart Mitchel discerns frozen music in the design of the Rosslyn Chapel in Scotland. His analysis of the architecture of this structure reveals archetypal designs that are associated with certain frequencies that affect membranes that have been dusted with

fine sand or powder. The powder organizes itself into patterns on the membrane according to the acoustic wave pattern generated by the frequency on the surface of the membrane. Stuart's music can be sampled at [www.tjmitchel.com](http://www.tjmitchel.com).

The geometric proportions of the Temple of Amun Mut Khonsu (commonly known as the Temple of Luxor, though it is not the only temple in Luxor) were measured by Schwaller de Lubicz and were found to have been designed with harmonic proportions encoded in the dimensions of their architecture. To experience the temples of Egypt is to become absorbed in harmonic proportion, and they have influenced many travelers.

In *The Beginner's Guide to Constructing the Universe*, Michael Schneider writes, "Earthly Music was seen as a mirror image of the heavenly ideal descending from above."<sup>6</sup> After working with a Ramses' head and discovering the correlation between its features and well-known geometric shapes, I decided to draw the example that Schneider gives

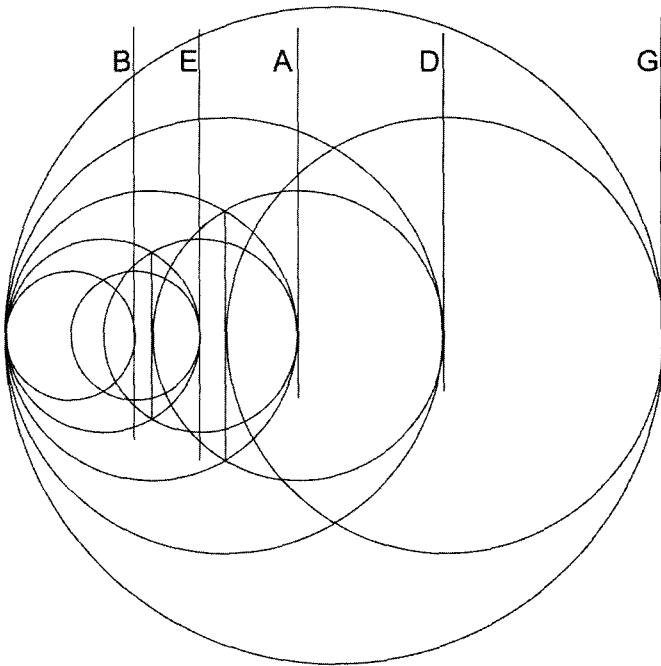

Figure 2.22. Harmonic scale of Apollo Zeus harp

in his lavishly illustrated book of the harmonic sequence of an Apollo Zeus harp. One of the sequences given includes the notes B flat, E flat, A flat, D flat, and G flat (the five black notes on a piano). The notes were played on the harp covering three octaves, from high notes to low notes, and are described as overlapping circles with nodes that represent the length of a string.

I then overlaid the image of Ramses with the Flower of Life with the geometry of the head, rotating it 90 degrees and scaling it so that the small circles were the same size as the flowers. The top circle was then placed over the uppermost flower. The correspondences that flowed from this arrangement are shown in plate 6.

#### RAMSES' HARP CORRELATION TABLE

Musical Note	Flower of Life	Face and Grid
B	Center of three flowers	Bottom eyelid
E	Center of three flowers	Tip of nose
A	Center of two flowers	Parting of lips and lower lip profile/Vertical lines on grid
D	Perimeter of flower	Vertical and horizontal lines on grid
G	Center of two flowers	Horizontal line on grid

With the *Flower of Life*, the face takes on a more three-dimensional appearance, which is necessary in order for us to appreciate fully what was accomplished. The geometry is more complicated, but not as complicated as what is necessary to create two identical, mirrored, three-dimensional surfaces in granite. The intricate web of correspondences among the face, the harmonic sequence, the flower, and the grid seems to establish a physical manifestation and integrated expression of art, mathematics, music, and engineering.

In chapter 1, we saw the perfection of the Hedjet and the Pschent. They presented us with a hint of techniques in ancient Egypt that have

been unknown until now—techniques whose application required workers with both the knowledge of absolute accuracy in manufacturing and the tools to accomplish it. We are leaving Ramses' face with a greater understanding of the difficulty involved in manufacturing the head. Though we have worked thus far with only a two-dimensional view, our results have yielded enormous implications. In the next chapter, we will examine the third dimension of Ramses' head: a 90-degree view of its profile from both left and right. We will then examine other Ramses figures to compare their geometry to the one we have been studying and examine some ideas as to how these mammoth objects could be created today.

### 3

## The Ramses Challenge

*An answer brings no illumination unless the question has matured to a point where it gives rise to this answer which thus becomes its fruit. Therefore learn how to put a question.*<sup>1</sup>

ISHA SCHWALLER DE LUBICZ,  
*HER-BAK: THE LIVING FACE OF ANCIENT EGYPT*

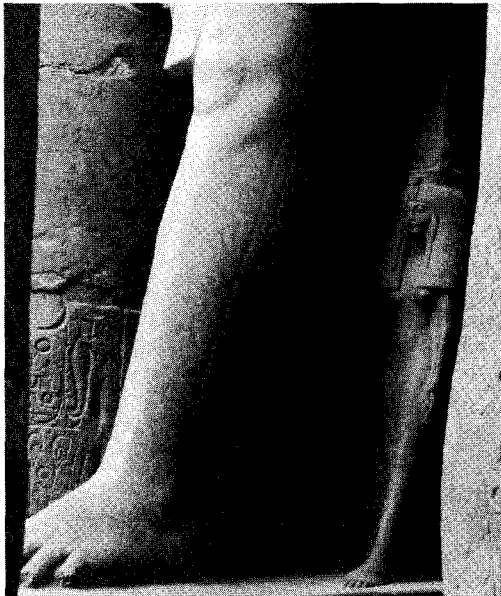

Figure 3.1. Nefertari, Ramses' guiding hand

## RAMSES' SMILE

As I pondered the features of Ramses' face, I found it quite curious that his mouth was turned up in an exaggerated smile (see figure 3.2). Though some might argue that having a wife with the attributes of Nefertari would give any man cause to smile, visitors to the temple are faced with what seems to be a synthetic smile that gives the face of Ramses a rapturous countenance. Examining the mouth closely, there appears to be anomalous geometry that does not blend with the contoured surface of the face. In fact, it appears that the face was cut first and then a separate tool shaped the mouth—and that this tool followed a contour that left a sharp cusp along the upper *vermilion border* (the junction between the mouth and the facial skin) of the mouth. It is particularly pronounced at the *philtrum* (the trapezoid-shaped indentation that joins the nose with the mouth) and forms a sharp, triangular point.

Figure 3.2. Ramses' smile at Luxor





The triangular point where the philtrum meets the vermilion border on the Ramesseum Ramses is even more pronounced. The smile, though, does not appear as exaggerated as on the Ramses at Luxor.

Why is the curve of the Luxor Ramses' smile so exaggerated? Further, as we've seen, only the mouth is smiling; the rest of the face is at rest. Even if the muscles of the cheeks were pulled up, as they would be if anyone tried to smile this big, it is doubtful such curved lips could be achieved.

I puzzled over Ramses' unnatural smile, but it seemed to me that it wasn't shaped this way merely to achieve a Pythagorean triangle; perhaps there was another reason for its appearance. Creating a line drawing from the features of the face and then removing the photograph revealed an image that was uncomplicated and distinct (see figure 3.3). Then it dawned on me that I was studying a face that was not in situ, but close to eye level—originally, the head was connected to a statue that was approximately 40 feet tall.

The seated Ramses figures at Luxor tower above the tourists at the temple. The proportion of both the people and their interaction with the statues has some bearing on the design of the statue, as we can dis-

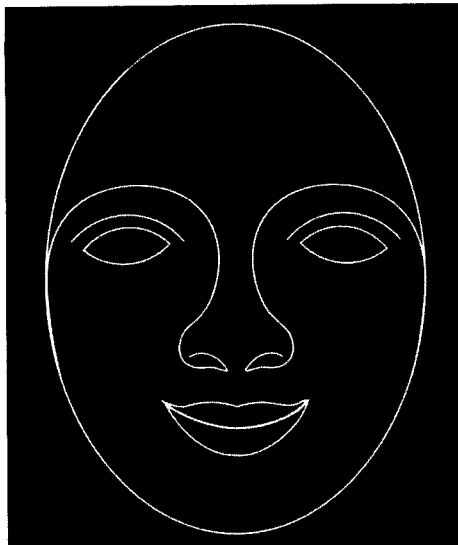

Figure 3.3. Ramses' iconic features.

cern from the face. Ramses' smile appears exaggerated only when we view the head at the same elevation. When viewed from the ground, the smile from the shortest to the tallest statue, 40 to 60 feet (13 to 18 meters) high, appears more natural. We can see one illustration of this effect when we look at our own mouth in the mirror, then notice that when we raise our head, our mouth appears downturned. To understand this effect even further, we can hold an egg vertically by the ends and draw a straight line horizontally from one side to the other. When we rotate the egg either toward or away from ourselves, the straight line appears curved. Obviously, when the ancient Egyptians visited the temple, they preferred to meet with a beneficent-looking king, rather than one who had a frown frozen on his face. Thus, the seemingly unnatural smile of Ramses when we view it straight on was calculated to appear natural via the perspective of someone at ground level. This is why the Ramesseum Ramses' smile looks natural: the photograph was taken looking up at the statue.

We can note another example of geometric warping for visual effect in the fluted Doric columns of the Parthenon. The Greeks developed a technique known as *entasis* to avoid an optical illusion caused by the shaft's fluting (parallel vertical lines): In a tall structure such as the Parthenon, these lines appear concave. To compensate, the Greek architects made the columns slightly convex, so that to the viewer they seemed straight.

Modern architects and engineers are still trying to understand how the ancient Greeks were able to build the Parthenon in ten years when the restoration of the monument has continued for more than three decades and is still not complete. What they have learned and shared along this arduous path of rediscovery is that the Greeks were highly skilled at building visual compensations into their structures. Columns were crafted and positioned to compensate for how the eye interprets what it sees at a distance. Subtle variances in the surfaces of platforms, columns, and colonnades provide the appearance of geometric proportion, whereas if they had worked from the perspective of a flat datum surface, the brain would interpret the results as being slightly skewed.<sup>2</sup>

In the face of Ramses, we see that such compensatory concepts did not originate with the Greeks, but instead were used by the Egyptians at Memphis and Thebes more than a thousand years earlier. If a normal mouth had been crafted onto Ramses' face, it would appear from the ground to be turned down in a frowning shape. To confirm this, we can look at the image of the statue of Ramses at Memphis, near Saqqara.

The statue of Ramses at Memphis is estimated to have originally weighed more than 300 tons. Though it once stood upright, the statue now lies on its back in the open-air museum at Memphis. It is crafted of fine limestone and, as the photograph taken from the viewing mezzanine illustrates (see plate 7), is manufactured using the same inexplicable precision and product value as the Ramses statues at Luxor. The symmetry is maintained between both halves of the face, and the exact surface of both sides of the face of the statue is composed of curves of varying dimensions that flow together. The Memphis Ramses provides us with information that we are able to infer by viewing the front and side views of the Luxor Ramses, because the photographs of the front and side of Ramses' head at Luxor provide two-dimensional views of three-dimensional geometry. The Memphis Ramses, on the other hand, provides us with information that clearly shows that the features on both sides of the face are mirrored in not just two dimensions ( $x$  and  $y$ ), but three ( $x$ ,  $y$ , and  $z$ ).

The appearance of true arcs on the contour of the eyelid of the Memphis Ramses suggests that the eyeball itself is an accurate sphere around which a radius is drawn in one axis to create the eyelid and, as a naturally occurring function of geometry, when viewed at other angles, always appears as a radius, though with different dimensions. In fact, similar to the crowns that we studied in chapter 1, the entire face has the appearance of being made up of nothing but blended spheres or ellipsoids that predict that, regardless of the angle from which they are viewed, they would present to the eye natural blended radial surfaces.

The down-to-earth reason for the unnatural smile, therefore, is that when viewed from the ground, it appeared to be natural. The photo-

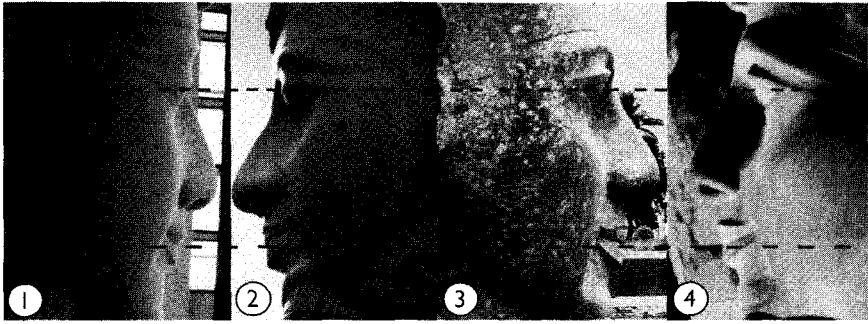

Figure 3.4. The four Ramses statues: (1) Ramses in the open-air museum at Memphis; (2) Ramses bust from the Ramesseum; (3) Ramses bust outside the Temple of Luxor pylon, taken with the camera facing west; (4) Seated Ramses in the Ramses Hall in the Temple of Luxor, taken with a telephoto lens and with the camera facing east, from the Sharia al-Corniche outside the temple.

graphs of the bust of Ramses at Luxor were taken with Ramses' head at ground level. We see Ramses at Memphis along his length, and the mouth seems to be turned in a downward arc. As we can see in figure 3.4, when viewed from the side, each of the Ramses statues—at Memphis, Luxor, and the Ramesseum Ramses—has a mouth that curls up in an exaggerated smile.

Initiates who entered this temple of learning would see an affectionate gaze and normal smile on the lips of Ramses. As they approached the front pylons of the temple and passed through into the Ramses Hall, they would look up at the faces of Ramses and see that they were being observed.

Not only is the mouth designed to appear normal from below, but also the eyes were crafted with the same consideration as the smile. Their geometry is such that they appear normal when viewed from below. Full of challenges and surprises, Ramses in figure 3.4 clearly presents us with another technique of its creators: the top eyelid is pushed forward, giving the appearance of an eye that is looking down rather than straight ahead, while the head remains erect. And why wouldn't this godlike statue give an appearance of love and caring? Why wouldn't he smile down at the temple's initiates, as they gathered to feed their spirits and

luxuriate in the majesty of inspired science, engineering, and craftsmanship that is the Temple of Amun-Mut Khonsu?

From a manufacturing perspective, in the case of the Luxor bust, it appears that the geometry of the face was contoured and finished before the lips were cut with a different tool that followed a different tool path in order to profile the lips with precision—though not quite dead center to the face. We can discern a small radius where the lips meet the vermilion border (though this is more distinct on the Ramesseum Ramses). Intriguingly, the depth of cut increases beneath the uncommonly sharp and distinct philtrum. In figures 3.5, 3.6, and 3.7, the level of precision is greater in the Egyptian Ramses than in the Greek statue and, perhaps, dimensionally superior to the perfection of a woman's lips.

A colossal granite statue of Ramses II towering 60 feet (18 meters) once greeted the ancient Egyptians as they walked through the Temple of the Ramesseum, the mortuary temple of Ramses II. The temple is situated on the west bank of the Nile where the statue was felled by forces unknown and the torso and head separated from the body, which now lies supine within the temple walls. The bust weighs more than 7 tons and is dated from around 1270 BCE. A photograph of this statue, plate 8, shows the shape of the mouth from below. As the ancient Egyptians intended, from on high, Ramses is smiling down on pilgrims in the temple. As you can see, the mouth appears natural.

It is evident in plate 8 that the Ramesseum Ramses has equal, if not more, exact symmetry than the Ramses at Luxor. The geometry of the face is changed, and the question may be asked if this is because the two Ramses were made differently. At this juncture, it is difficult to say without a more detailed examination because of the difference in the camera angle when each Ramses was photographed. When we perform the reverse transparency overlay and bring all the facial features together, however, it is clear that the Ramesseum Ramses was crafted with the similar geometric patterns and with remarkable symmetry from the tip of the nose to the ears and moving along the skull to the upward curve of the Nemes crown.



Figure 3.5. Jessica's perfect lips



Figure 3.6. Imperfect lips



Figure 3.7. Lips that are too perfect?



Figure 3.8. Shadow of the Ramesseum Ramses

When I further investigated the symmetry of the jawline, I drew a line to bisect the head midway between the jaw. The photograph was expanded to five times the size of a human head, and then I made measurements using the measurement tool in CAD using 2 decimal point precision in inches. Figure 3.9 confirms that the geometry of the Ramesseum Ramses is more precise than that of the head outside the Luxor Museum.

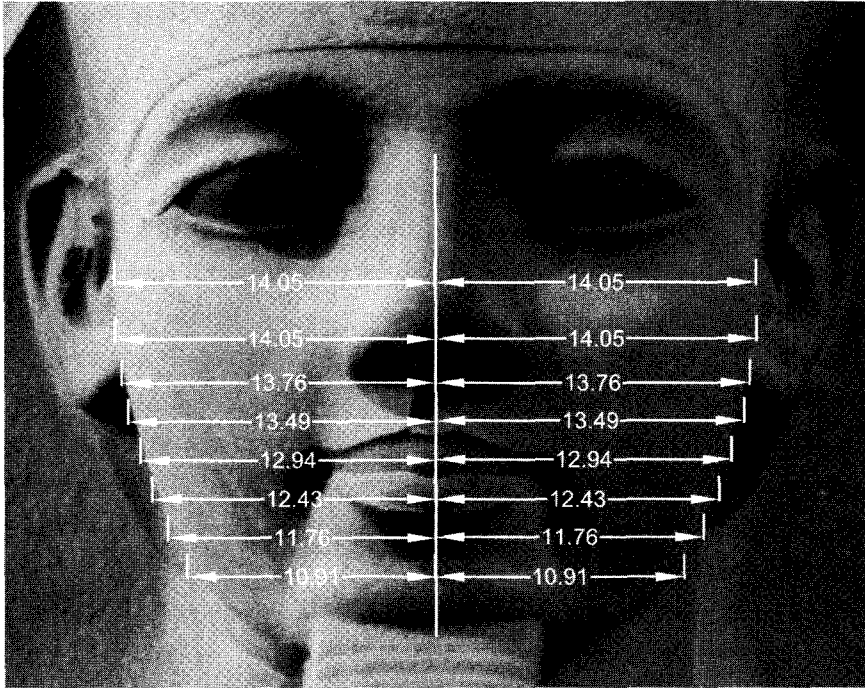

Figure 3.9. Measuring the face of the Ramesseum Ramses

The design protocol described in chapter 2 seems to be evident in all the Ramses statues. Surely, the implications of this discovery would prompt another study to coax from the Ramses statues all three-dimensional measurements from which accurate models could be created and analyzed further, yielding even better results.

### WITNESS TO A SMALL MISTAKE

Ramses' smile in the statue of Ramses from the Ramesseum may appear innocent enough, but the mouth is loaded with silent information regarding a manufacturing mistake and the work that was performed in an attempt to correct it. Figure 3.10 shows this close-up. As in other Ramses faces, it appears that when the statue was created, the contours of the face were crafted first and then another tool was employed to cut the contours of the lips, leaving an unnatural cusp



at the vermilion border. In fact, it would appear that for some reason, the lips on the Ramesseum Ramses were cut deeper than necessary, particularly when we compare them to those of the Luxor and Memphis Ramses heads shown in figure 3.4. This detail is not present on the statue of Ramses at Memphis—perhaps because the Memphis statue was crafted from limestone instead of granite, which would make it easier to remove material in order to smooth the cusp. On the other hand, when the heads sat 40 feet, or 12 meters, in the air, these mistakes would be imperceptible to visitors and, therefore, not considered important. They do, however, become more pronounced when we study them in closer detail out of the context of the overpowering majesty of a grand temple.

In figure 3.10, we perhaps find a reason for the lips being cut deeper into the face. In the corner of the mouth on the left side of Ramses' lips is an undercut that gives him an almost snarling appearance. This is

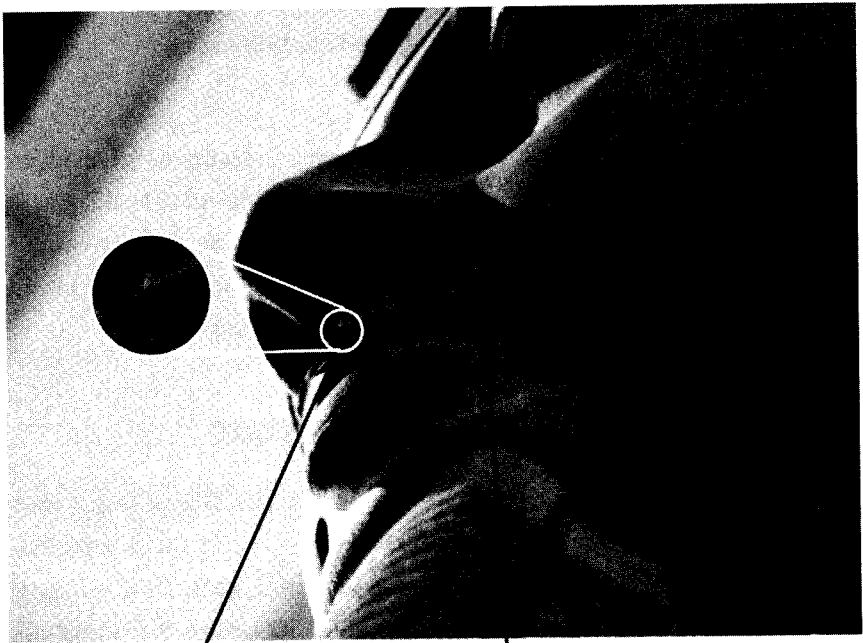

Cusp where the philtrum and  
vermilion border meet

Undercut

Figure 3.10. Ramses' mouth

clearly a mistake in the crafting of the mouth, but what does the mistake imply? From a manufacturing perspective, this undercut is obviously the reason for the lips being cut deeper. It seems this was done to remove as much of the mistake as possible without going too deep into the face. If the craftsmen had pushed the contours of the lips uniformly into the face in order to remove the undercut entirely, the margin between the vermilion border and the lips would be even more unnatural and bizarre looking. Moreover, this would have taken much more work to accomplish. As it is, the cusp is overlooked by casual observers—including me, until I started to examine the photographs in greater detail in my computer. What is more startling to me and to others who have performed work in brittle materials is the uniformity of the lips and, though they are cut deeper into the face, the existence of the cusp that is so sharply defined without significant crumbling of the edge. This point alone may cause us to wonder what kind of tools the ancient Egyptians possessed. It does not seem possible that such a mistake could result from the slip of a stone chisel. The undercut and the cusp on the Ramesseum Ramses point clearly to a previously unknown method of stone cutting in which a substantial amount of material is removed by mistake—and without being noticed.

When we examine a close-up of the Ramses statue at Luxor, it appears that the lips are similarly crafted, though not cut as deep into the face as on the bust of the Ramesseum Ramses—and without the mistaken undercut. Intriguingly, we can see a faint tool path that follows the contour of the upper lip from the nostril to the vermilion border on Ramses' right upper lip. Associated with these lines appear to be several cuts that are slightly deeper, causing a ripple effect at the border—but this observation deserves more investigation and cannot be considered conclusive at this juncture. Nevertheless, the irregularity at the vermilion border seems fairly conclusive, especially as seen in figure 3.11, where the shadow from the light reveals the variations. On the other hand, Ramses' left lip, seen in figure 3.12, has a shadow that is consistent with the graceful arc of the lip that keeps the light from shining onto the upper lip.



Figure 3.11. Detail of right vermillion border



Figure 3.12. Detail of left vermillion border

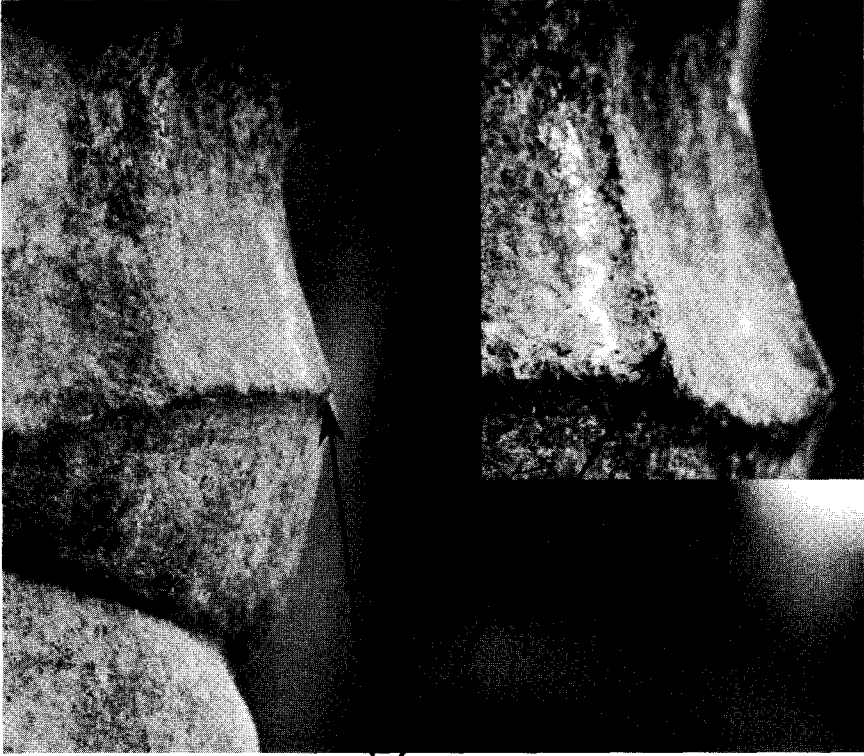

Sharp philtrum ridge

Figure 3.13. Tool marks on Ramses' mouth

If we examine the upper lips more closely, faint marks left by a cutting tool (witness marks) show that a mistake was made on Ramses' right lip, causing a jagged edge at the vermilion border, but his left lip was shaped accurately—though there, too, we can detect faint witness marks of the tool that cut the contour from the nose down to the border (see figure 3.13).

For purposes of displaying here the best evidence possible, this was too tantalizing to ignore. I had previously traveled to Egypt specifically to photograph the Ramses heads to determine their symmetry, which demanded a technique that did not include zooming in on small sections of the head. I needed the entire head in my viewfinder. Yet with the ability to take high-resolution photographs, what appeared to be

tool marks became evident when I zoomed in digitally on my computer. It became clear to me while writing this chapter that in order to finish it properly, I had to make another trip to Egypt. The digital zooms were intriguing, but I could obtain better photographs using optical zooms with a macro lens. I would then have high-resolution, close-up images with greater detail and clarity.

In chapters 1 and 2, we learned that if we are to accept Ramses' challenge to create another just like him, in simply creating the head and crown alone, we are faced with an enormous task. These, however, are only a small fraction of the entire statue. As we have learned, the seated statues at Luxor are approximately 40 feet in height, and the raw block from which each was made must have weighed up to four hundred tons. The head is a small representation of the fine craftsmanship that fittingly swells modern Egyptians' pride in their ancestors.

For our study, it is bittersweet fortuity that a head was available for close study, but I would certainly not have enjoyed being in the vicinity when it fell to earth. The forces that caused it to separate from the body must have been enormous—for one characteristic of the Ramses statues is their “unnatural” appearance because they are controlled by engineering considerations that must take into account strength and stability rather than anthropometric accuracy. The arms and legs of Roman and Greek statues do not have the same substantial connections to the principle mass of stone that Egyptian statues have, and therefore, they are more natural in appearance. The standing statues in the Ramses Hall do not have arms and legs that separate from the body. They are cut more in *alto rilievo*; the body of each statue is carved out of and is firmly a part of a sturdy pillar, a gargantuan rock. There is no separation of any appendage from the torso or the pillar.

The Nemes crown, which is adorned with a *uraeus* (cobra), is more of a headdress than a crown, and most statues have this feature. From an engineering viewpoint, the headdress serves to give stability and strength to the head, because it provides mass by being integrally a part of the body, flaring outward to span the width of the shoulders. Stability and strength at the front of the neck is provided by the false

beard, which is firmly attached to the chest and provides a buttress to the chin. With the characteristics of a bas relief, the ears are a part of the head and the Nemes crown. False beards were worn by the pharaohs of Egypt because they were believed to provide them with godlike powers. The false beard on all the statues in Egypt are carved from the native rock, just like the rest of the statue.

In the standing statues, native rock connects the pillar to the back of the legs. In figure 3.1 (see p. 68), we can see that a little added symbolic support to the pharaoh's outstretched leg is given by his wife, Nefertari, who appears to be naked, but because of the smoothness around the groin, may be depicted as wearing a seductive, diaphanous garment. Figure 3.14

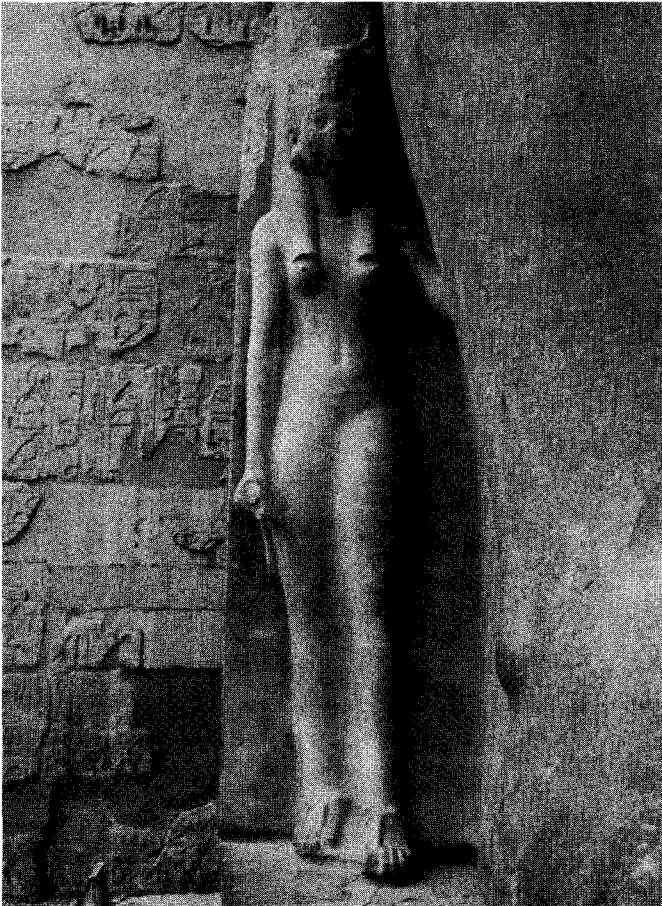

Figure 3.14. Nefertari's gown.



seems to clarify this conjecture. Note in figure 3.1 that Nefertari also has a web of granite between the back of her leg and the back pillar.

The seated statues of Ramses have modified arms that allow the forearm to rest unnaturally on the thigh. A human's elbow and forearm does not rest on the thigh when a person is seated upright with his hands on his knees. By adding length to the upper arm and mass to the forearm, the designers eliminated a potential weak spot in the statue, and they firmly attached all elements of the body by leaving webs between arms and chest, and legs and pillar.

Seemingly, the ancient Egyptians were more focused on engineering strength and efficiency than on creating true-to-life statues. The forearms and the hands of the seated Ramses are relatively smooth and devoid of natural human features, such as knuckles on the fingers and the toes.

The absence of knuckles on the fingers and toes of Ramses is more pronounced when we compare him to the statue of Constantine, now on display in an interior courtyard at the Musei Capitolini, Rome.

From its head to its toes, Ramses presents a unique challenge to modern engineers. How would we replicate such a piece of art? While there are areas of the statue that are asymmetrical, they do not detract from the places that are. If we had a statue that was more humanlike in appearance, with natural variances between left and right, the challenge would be easier—we could rule out the need for extreme precision and the tools and engineering considerations that go along with it. As it is, the symmetry between both sides of the face epitomizes and summarizes the most difficult aspects of the challenge.

To gain an understanding of what we are faced with in trying to replicate the statues, we can select a familiar item in the home or office—a computer mouse, a telephone, a CD player or radio. These are symbols of modern technology. If we were asked what technology they symbolize, we would probably answer “communication” or “entertainment.” They certainly symbolize these two; more meaningful to me is that they symbolize the evolution of manufacturing.



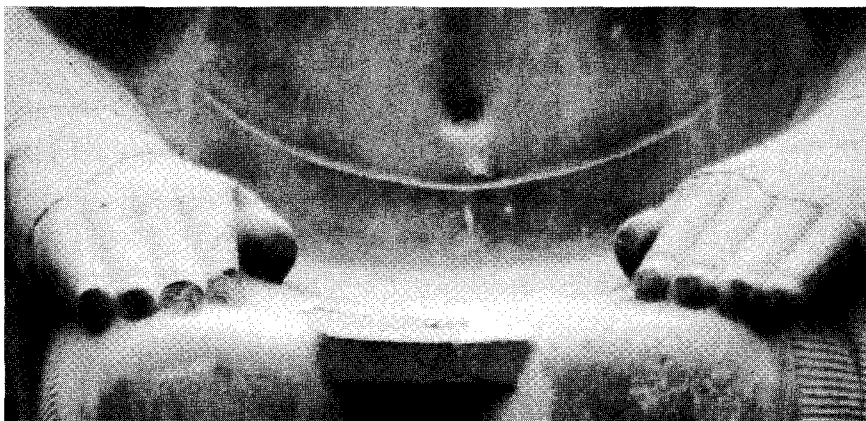

Figure 3.16. Ramses absent his knuckles



Figure 3.17. Ramses' toes

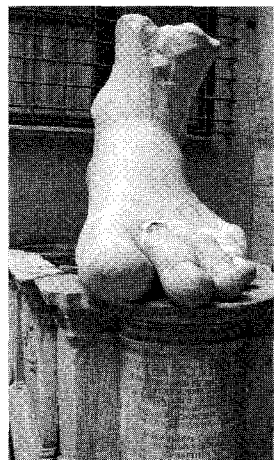

Figure 3.18. Constantine's toes

If we study these items closely, we note that they have smooth contours with geometries that blend to create a three-dimensional shape that is pleasing to the eye. For functional engineered devices, however, this kind of contouring was not always the case. When product design and development were in the hands of engineers who accessed their left brain more than their right brain, all kinds of monstrosities were created. We may remember some of the original appliances that were developed to make our life easier—but for those who don't recall, there

are museums and books to teach us of these baby steps toward what we enjoy today. An old steam iron or vacuum cleaner has engineering functionality, but compared to what is available today, neither may appeal to our artistic sensibilities.

Since the dawn of the Industrial Revolution, the evolution of manufacturing has reached a point where the poorest quality product that comes to market today is vastly superior to the finest quality that was available one hundred years ago. Machines and manufacturing processes have been perfected to the point that many of the variables and imperfections that used to appear randomly have been all but eliminated. We take them for granted, but high-quality, inexpensive consumer goods were not always available.

Influencing the evolution of manufacturing all along have been artists who were employed to exert their influence on consumer products quite simply to make them more visually appealing and feed the desire to buy more products. As a case in point, a Bang and Olufsen phonograph turntable has been exhibited in the Museum of Modern Art. To put it bluntly, it was the desire for profit that forced the evolution of manufacturing. Behind this desire for profit, however, were the desires of the population to have in their possession creations that gave them pleasure—whether from making their lives easier or impressing their friends and neighbors with their latest acquisitions.

For most people today, the science and engineering behind a product is subordinate to its visual appeal. Little notice is given to how a device works—to how electrons move through circuits and cause motion such as sound or how energy moves through cavities to produce motion such as propulsion. Shapes and colors that appeal to the right brain overpower the analytical left-brain function in the majority of people and are usually the deciding factors when we select a product for purchase.

Yet even if we ignore the functionality of a product, its external appeal still speaks of technologies that are employed in its creation. We probably have, within arms length, numerous examples of high technology. A soda can or a water bottle exhibit evidence of some of the processes necessary to make them. The roundness and uniformity of a

drink container clearly indicates the use of a lathe. By studying a water-bottle top, we can discern the action of an injection mold that, when separating from the plastic, has to turn slightly in order to clear the helical screw threads. Examine your cell phone and wonder how such a product came to be. It is a perfect example of science and technology as well as manufacturing excellence. The book you are now holding in your hands came into existence through the function of machines—through wonderful examples of manufacturing precision that have evolved over the centuries.

### RAMSES' SYMBOL

The Temple of Amun Mut Khonsu has inspired philosophers to try to understand the symbolism behind its walls. R. A. Schwaller de Lubicz discerned a structure that by its design and dimensions symbolized a connection with the cosmos. It is a structure that conveys principles of harmony found in music and art. The Golden Ratio and dimensions of harmonic intervals are encoded in the walls and columns through their placement and the application of reliefs. Schwaller de Lubicz stressed that the ancient Egyptians had a sacred science in which there was no distinction between the material and the spiritual. They believed both worked in harmony.

For me, the symbolism in the temple was that the statues of Ramses reflected the state of the art that was present at the time they were created. The question, therefore, is this: What minimum requirements must be met to produce a statue such as those of Ramses? To answer this question, we first must consider the most difficult tasks to accomplish, both in design and execution—perhaps, re-creating the head and replicating its geometry and precision. Once we have decided how this could be done, knowledge of the production of the rest of the body will follow. To re-create the head, we would have to design and build a means of mirroring one side of the face in order to create the other. Perhaps we could create a model and a pantograph-type device with a stylus that could follow the contours of a model while cutting the gran-

ite. That may solve how the granite was cut, but then we are still left with how the model was made to such exacting standards.

The statues of Ramses are exact. Using computer graphics and comparing the geometry of one side of the crown and head with the other and also with drafting elements such as rectangles and circles, it becomes clear that these statues must have been cut with the assistance of mechanical devices that caused the cutting tool to move along predetermined boundaries to produce an accurate representation in granite of the specific design. The only remaining question: To what quantifiable measure does the right side of the face vary with the left? In other words, after further analysis using laser scanning equipment and comparing both sides, to what extent will they vary?

Figures 3.19 and 3.20 illustrate two-dimensional grids that would produce in three dimensions a point cloud—that is, every point on the right side of the face would have an identical point on the left side of the face. We assume a point lies where each horizontal line on the grid crosses a vertical line. This point is projected on the contour of the features of the face using Cartesian coordinates. When the tool has finished cutting, with regard to the jawline, we can see a perfect radius in the two-dimensional view and, creating that radius, a curve moving in three dimensions.

Figure 3.20 represents a simple cross section of the Ramses head at the tip of the nose, the  $x$ ,  $y$ ,  $z$  zero point as identified in figure 3.19 and figure 3.20. With the nose now turned up, the  $z$  axis is now vertical and the  $y$  axis would be represented by a line moving away from the observer and graphically represented as a dot. In other words, the head has been rotated 90 degrees around the  $x$  axis seen in figure 3.19, and a vertical flat plane has been established through the tip of the nose. The profile was created by drawing the right side, then copying the profile in mirror image. Sectioning the head in this way, in 1-inch increments along the  $y$  axis, would result in many different profiles and an infinite number of profiles in between. These are the constraints we are faced with when we attempt to understand how the head of the statue was designed. We can only wonder at how these profiles were applied to granite.

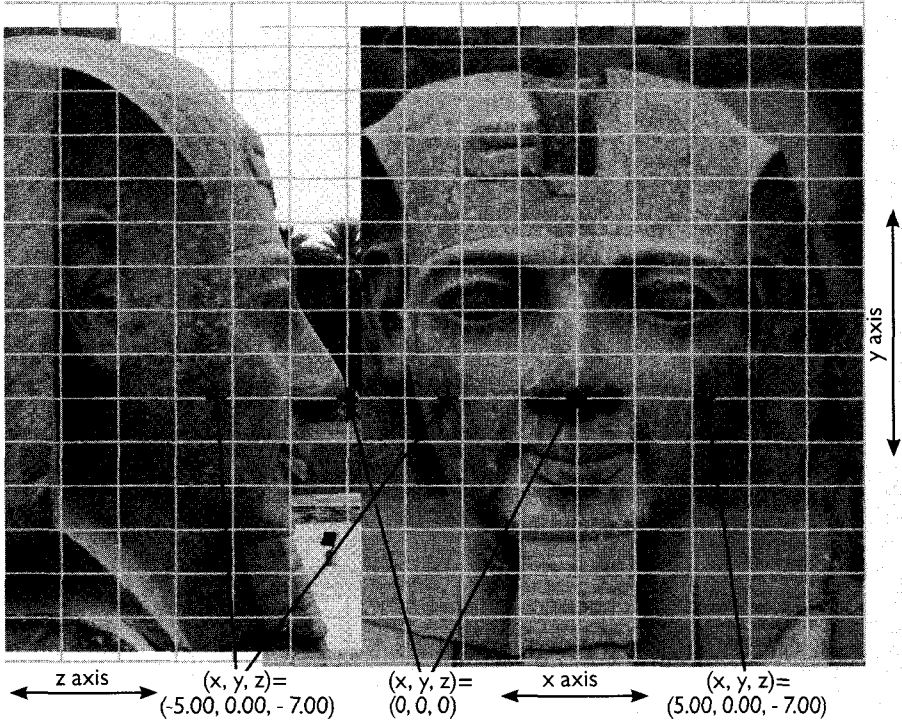

Figure 3.19. Charting Ramses' face

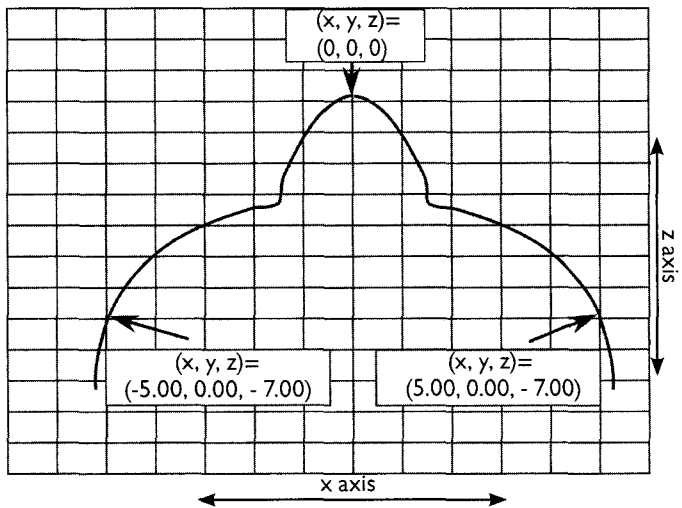

Figure 3.20. Cross section

Historically, the quality of products has improved over time, and consumers of those products—you and I—would not tolerate the quality that was commonplace even fifty years ago. Some manufacturers have gone out of business by not being able to improve operations enough to compete with higher-quality and cheaper products. If we draw a parallel between the precision of the Ramses statues and the precision of modern products, we are faced with Egyptian artifacts that conformed to specific standards of design and measure in their world. In other words, the Ramses statues had to have received similar attention with respect to geometry and exactness as the automobile in your driveway. In fact, without receiving such attention, they could not have been made.

The questions we must ask the Ramses statues are these: “What do you truly represent? What tools did your maker have to allow him or her to create you?” It is one thing to draw a circle on paper, but it demands extraordinary attention to define in granite a circle that moves along a third axis but that, when viewed in two dimensions, is a perfect radius. We have the technology to do it today—but what may have existed in ancient Egypt? Besides Ramses’ head, what other indications are there that Egyptians in a long-past epoch had similar advanced technology when all we have found in the archaeological record are simple tools? Is there evidence of such accuracy elsewhere in Egypt? What conclusions can we draw from other temples? Or is Luxor an anomaly and a miracle of superhuman touch guided by the gods? This is not an uncommon conclusion. It is often reached by many a confounded visitor to the miracle that is the Temple of Amun Mut Khonsu.

## THE COSMIC EGG

Proverbs were an important part of the ancient religion of Egypt. A concept that was burned into the Egyptian philosophy was “know thyself.” Ancient Egyptians were reminded of the spiritual aspect of this concept when they visited their temples—that is, the divine essence of the Creator and the heavens was encoded within them. The Egyptians’ heart was their temple, and all the Egyptians needed to



Figure 3.21. Ramses' egg

learn about the universe could be found there. The expression was inscribed on the temple walls, and the ancient Egyptians also took it with them to the afterlife by having it inscribed in their tombs: “The kingdom of heaven is within you; and whosoever shall know himself shall find it.”

# 4

## The Shadows of Karnak

*We read the past by the light of the present, and the forms vary as the shadows fall, or as the point of vision alters.*

JAMES ANTHONY FROUDE, *SHORT STUDIES ON GREAT SUBJECTS VOL III. SOCIETY IN ITALY IN THE LAST DAYS OF THE ROMAN REPUBLIC*

Figure 4.1. Monolithic trunkless legs of hewn granite at Karnak





The quotation illustrates the conflict that can arise when we study the shadows of a photograph. Using shadows to form conclusions presents a double-edged sword. Though a clearly outlined geometric shape that is free of shadows and is taken in the full light of day provides substantial evidence to form an analysis, shadows can either be your friend or they can be misleading. For instance, the shadow that light throws on the upper lip of the Ramses statue (as shown in figures 3.11 and 3.12 on p. 80) reveals a difference in the smoothness between Ramses' the upper right and the left lip. To state more than what is obvious in the photograph would be to read more into your analysis than there is. Similarly, the parallel striations that we can see on the upper lip and the philtrum in figure 3.13 (see p. 81) are not the best evidence to conclude that the tool that cut the statue followed these particular paths. On the other hand, to achieve the symmetry and precision found on the statues, the craftsmen's tool had to have a precise geometric path to follow. Perhaps, then, these telltale witness marks or "ghost" marks can actually provide us with evidence of the method of manufacture. If so, more of them may be found if we look closer.

It is estimated that the Parthenon in Athens took ten years to build. Rebuilding efforts of portions of the temple that have suffered the ravages of natural and human forces have been ongoing painstakingly for the past thirty years. A shadow thrown across the cusp of the fluted columns of the Parthenon provides information regarding the geometry and precision with which the flute was cut. The restorers of these columns carefully scrape and chisel the flutes after a specially made machine has cut the flutes in replacement sections. Why? Because the machine could not replicate the ancient technique. Senior science editor of PBS's *Nova*, Evan Hadingham, writes:

Today's restorers have been replacing damaged column segments with fresh marble. To speed up the job, engineers built a flute-carving machine. The device, however, is not precise enough for the final detailing, which must be done by hand. This smoothing of the flutes calls for an expert eye and a sensitive touch. To get the ellipti-

cal profile of the flute just right, a mason looks at the shadow cast inside the groove, then chips and rubs the stone until the outline of the shadow is a perfectly even and regular curve.<sup>1</sup>

No records exist that explain how the ancient Greeks built their temples, but modern attempts to replicate their achievements inspired Mr. Hadingham to ask if the original builders had better tools than today's artisans.

Similarly, no credible records explain how the ancient Egyptians built their temples, and we could ask the same question of them that is asked about Greek artisans: What tools did the ancient Egyptians use to craft their statues? If we listen to conventional archaeologists, we might conclude that they used a combination of round and straight copper saws charged with abrasive sand, stone hammers, and stone chisels to cut granite. All of these tools were wielded using the energy, skill, and eye of human artisans. But the geometry and symmetry of these statues raise a troubling question about the efficacy of these ancient tools. To be certain, they have been demonstrated to be capable of removing material and shaping hard stone such as granite,<sup>2</sup> but not to the level of precision and sophistication that we see in a Ramses statue.

In today's manufacturing shops, some products can be machined to desired geometric tolerances without requiring that the marks left by the tool be removed by a secondary process, such as polishing. Any process whereby a tool affects material along a defined path will, without polishing, leave witness to the path of the tool. The tool might be a three-dimensional printer, building discrete amounts of plastic material in thin layers to create all manner of three-dimensional shapes, or a rotating tool bit that cuts material along a geometric path that's defined by mathematically and incrementally slicing a three-dimensional object along one of its axes. If we are driven to the conclusion that the symmetrical accuracy of the Ramses statues could be achieved only with the assistance of mechanical axes that guide the tool along a predetermined path, then the striations found around the eyes (see figure 4.2) would not be surprising. These marks follow a path that a guided tool would



Figure 4.2. Signs of a tool's path on a statue of Ramses?

follow to create these features. We should also note that these marks are not visible to the naked eye, but instead were captured by a 15.2 megapixel camera using an ultraviolet filter.

If we speculate that these marks were secondary to the handcrafted creation of the piece, then we might wonder what created them and why. Are they water stains left on the surface of the granite after a downpour? Or are they inherent features of the granite? To answer these questions, we need to understand what modern tool marks look like and then compare them to those on the Ramses statues. Moreover, if the methods for creating the geometry of the Ramses heads used a tool that was meticulously controlled through mechanical means, then the method would have been used on other statues.

Figure 4.3 illustrates two types of tool marks. Inset 1 shows the surface of a conical steel die that was cut on a lathe. The witness marks of the tool are helical; the tool moves constantly along a linear path while the material rotates. Though these marks are quite clear, to the touch the surface is very smooth; we can feel no ripples. Sheet metal is formed around the shape of this die in a press.

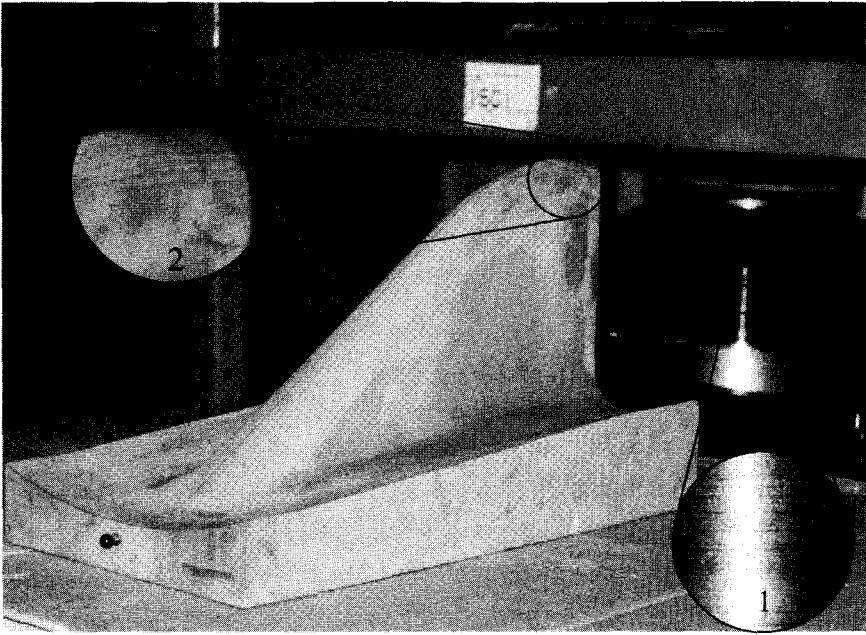

Figure 4.3. Tool paths on aerospace tools

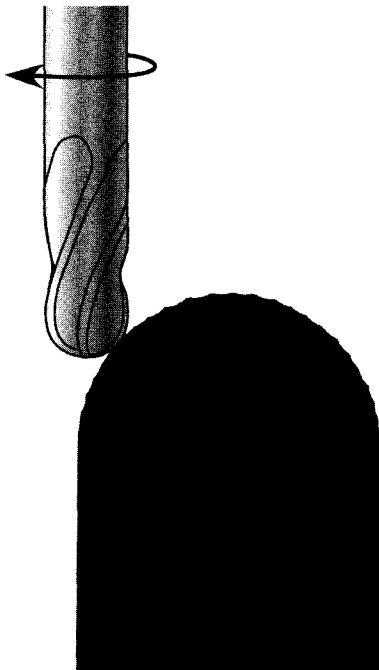

Figure 4.4. Geometry of a tool path formed by a ball-end cutter

Inset 2 shows the surface of a manufacturer's model for a jet engine part. The tool marks are more pronounced on the top of the fin—the result of a convex radius cutting a convex radius and leaving a pattern of concave cuts. Figure 4.4 shows an example of the type of surface created with multiple passes from a ball-end milling cutter that leaves a cusp between each pass. The distance between the passes could be reduced to create a smoother surface, but for the purpose of this model, it was not necessary and would have added more cost to its manufacture.

Given what appear to be tool marks on the Ramses head at Luxor, we next must study other statues to see if there are witness marks from the tools that created them. Lighting and the angle of the camera contribute greatly to the ability to see these kinds of witness marks, though this figure is not the clearest example and provides only a hint of what was discovered after we left the Temple of Luxor and visited the Temple of Karnak in the mid-afternoon on November 12, 2008.

The Temple of Karnak is a sprawling site that covers more than 247 acres. It is considered the largest temple in the world, rivaled only by Angkor Wat in Cambodia, and presents to visitors a stunning collection of monolithic pieces of stone crafted into statues, obelisks, columns, and walls. Karnak is made up of three main temples with several smaller, enclosed temples and outer temples. Construction continued on the temple for thirteen hundred years under approximately thirty different pharaohs.

The sheer volume of granite, diorite, and alabaster that was cut precisely into statues around Luxor attests to the ancient Egyptians' mastery of their craft. The Greeks and Romans did not sculpt statues in igneous rock. Granite was not fashioned into statues until the development of more modern power tools with steel bits. In *The Materials of Sculpture*, Nicholas Penny writes:

Granite had occasionally been worked in shallow relief, for architectural ornament where it was the local building stone, and for the stiff figures of sixteenth-century calvaries in Brittany, but, before the advent of improved metals and power-driven tools in the nineteenth

century, the idea of making statues out of it was seldom seriously entertained by sophisticated sculptors.<sup>3</sup>

Whether using a hand-powered chisel or a power tool, shaping granite with a chisel is accomplished by percussive forces acting perpendicular to the surface of the granite. The marks left by these tools, if not polished out, are randomly scattered over the surface of the stone. Similarly, if a bush hammer (one that has nine or more hardened, pyramidal points ground into the face) is used, a mottled surface is created. Bush hammering is a common method of giving stone a rough surface—and is often used for steps in order to make them skid-proof.

The tool marks visible on the Ramses statues in the Temple of Luxor do not have the appearance of being made by chisels or hammers of any kind. So what kind of tool would the ancient Egyptians have used? Down the left side of the head of one of Ramses statues at Karnak are some tantalizing clues that may give us a clearer idea of what took place in these ancient statuary workshops. I was close to the end of my visit to Karnak when I set up my tripod to photograph the Ramses statue in the forecourt just outside the Great Hypostyle Hall. I peered through my camera lens fitted with a 300 mm zoom lens as the sun set in the west and cast its light across the left side of the face. The evening light revealed a series of striations that flowed in graceful arcs down the cheek and into the neck of the statue. Are the striations on this statue and the Ramses at Luxor simply the result of dirty water running down the statue, or are they witnesses to a sophisticated method of cutting? A close-up of the cheek (see plate 9) provides more detailed information of cusps between what may be the route taken by a mechanically guided tool. These marks demand further attention before reaching clear conclusion.

Upon examining plate 10, though, we see the shape of the tool that was most likely used to perform fine detailing on the face and around the eyebrows. At the top of the eyebrow are marks that follow a path down the crown and the brow and end at the top of the eyebrow, where it cut slightly deeper than the surrounding surface leaving rectangular

indentations. The indentations are conspicuous by the shadow on the bottom surface caused by the sun grazing across its edge in the corner, and the path of the tool is discernible in the striations that flow down the brow to where we can see the top-of-the-eyebrow indentation. There are six of these indentations, which appear to be equally spaced. Also, below the eyebrow is an area where the tool cut away part of the eyebrow. This cut is noticeable down to the eyeliner. These indentations lie along distinguishable striations that flow from the top of the brow down to the neck. These mistakes tell us that those who created the statue must have determined that the errors were not severe enough to need correcting—a logical conclusion, for they are not noticeable to the naked eye from ground level.

How did these mistakes happen? I consulted with Greg Brown, a sculptor and an editor at *The News Gazette* in Champaign-Urbana, Illinois, and he regarded the mistakes as not those that a skilled sculptor would make with the tools at his or her disposal on a sculpture of that scale. For one thing, the parallel striations down the face into the neck are not the kind of marks that would be left by a sculptor using hand tools. We both concurred that these marks have all the characteristics of machining. Further, when a tool that applies force in order to remove material along a specified path is stopped while the force is still being applied, it will continue to remove material in the place where it has stopped. In other words, if a rectangular tool that is energized like a jack hammer and that's guided along a geometric path on a piece stops moving, the tool will continue jack-hammering away at the material, causing an indentation. Given the mistakes left on the statue at Karnak during the cutting process, possible methods used by the ancient Egyptians are brought out of the shadows and into the light.

We gained a rough estimate of the size of the rectangular depressions by comparing the size of a human face to Ramses at Luxor, overlaying a transparency of the Karnak Ramses over the Luxor Ramses, then measuring the rectangles. The measurement reveals a tool size of approximately 0.30 inch (7.62 millimeters)  $\times$  0.180 inch (4.572 millimeters). From a technical perspective, these dimensions are probably

optimal for a tool that is performing finish cuts. The surface area that strikes the granite is not large, so fine detailing can be accomplished with such a tool. The tool marks show that the orientation of the tool as it made a pass over the granite provided the widest cut. That the width's dimension is greater than the height means that the distance between passes can be greater than if a square tool face was used with the same surface area.

Figures 4.5, 4.6, and 4.7 show different views of the statue and the remarkable striations that are evident from the top of the crown to the neck. Inserted in the photographs are magnifications of an area below the ear that show more mistakes made by the manufacturers of this

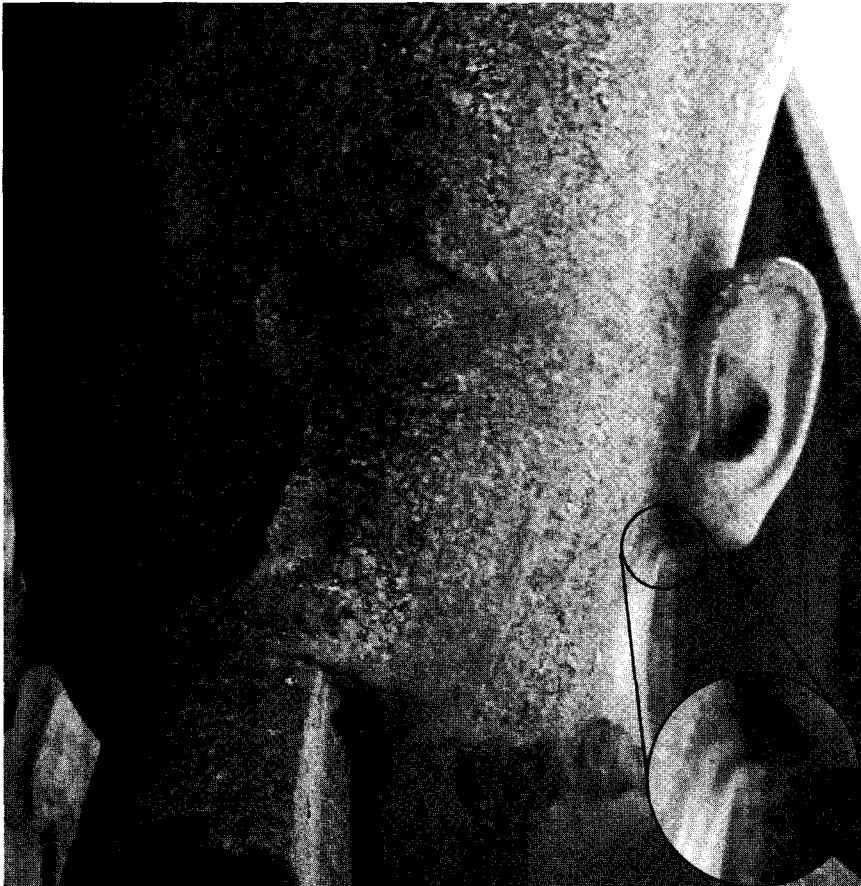

Figure 4.5. Karnak Ramses' tool marks beneath the ear from the front



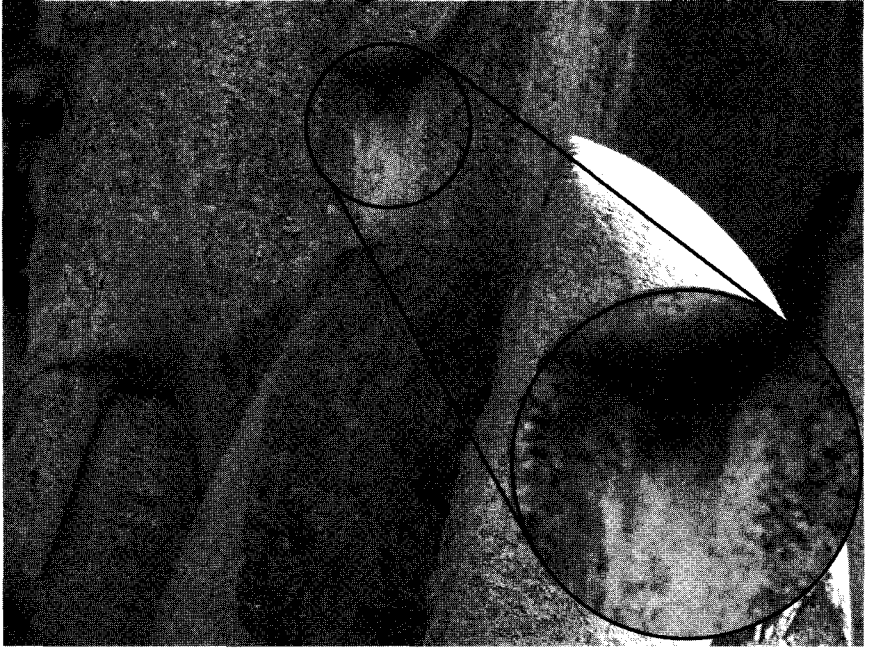

Figure 4.6. Karnak Ramses' tool marks beneath the ear from the side

piece. They say that the devil is in the details and these details raise some thorny questions. Branching from the fundamental question of “why?” we can ask: What extra effort went into creating these mistakes? We might conclude that usually, a sculptor who shaped a piece of granite into a human head with a hammer and chisel would expend enough effort to reduce the material to the required shape, and then would have only to polish away the tool marks. There doesn't appear to be any logical reason for a sculptor to make and leave these marks of superfluous cutting in such a hard material. These are more than a slip of the chisel and may be more the result of an unattended machining process than the work of a proud and highly skilled sculptor.

Introducing the concept of machines capable of performing this kind of work in ancient Egypt is highly controversial. For many engineers, the product is enough to show that machines had to have been used, but to archaeologists and Egyptologists, the absence of machines in the archaeological record is enough to say that all these works were



Figure 4.7. Karnak Ramses' tool marks beneath the side-rear

created by hand. Here, however, I present this information to provide engineers, technical people, and even interested modern sculptors with observations that they may not find in a textbook.

For those who may not be familiar with how a sculpture of a Ramses'

head would be made today, we can look at plate 11 as an example. This image resulted from a search on the Internet. Anyone with a computer can Google “tool path software” and receive hits for all manner of products that are created with three-dimensional modeling and machining software. This example is reprinted here with the kind permission of Joakim Möller, president of MadCAM Mould and Die CAM Systems, in Romakloster, Sweden. Mr. Möller’s permission was freely given without knowledge or endorsement of the context within which his image was being displayed. It can be viewed at [www.madcamcnc.com/Tutorials/4-axis%20demo/4-axis%20Tutorial.html](http://www.madcamcnc.com/Tutorials/4-axis%20demo/4-axis%20Tutorial.html).

As we can see in plate 11, the protocol for guiding a tool across a three-dimensional contour has not changed for more than three millennia. This is not surprising if we consider the geometry and precision of the Ramses heads, but this does not mean we can conclude that the ancient Egyptians possessed sophisticated computers and software that could generate code to feed into machines that in turn shaped their environment. Machines moved along exact, mechanically guided axes for many years before the advent of computer software. But as mentioned earlier, creating a Ramses head on one of these earlier machines would have been a significant challenge. Yet the evidence seems to be stacking up in favor of revising what we have been taught about the level of technology possessed by the ancient Egyptians.

Once I had a good idea of the kind of impressions the ancient Egyptians’ tools left on the surface of the granite, I examined other photographs that I had taken to see if the marks showed up on other statues.

Going back to Luxor, we see that a close-up of Ramses’ mouth (figure 4.8) reveals that the irregular, jagged edge along the vermilion border of the upper right lip was created by a series of cuts from a rectangular tool. A closer look at the left lip indicates that though the line is more precise, it is still the result of a rectangular tool being applied in one place before being moved over and reapplied to cut again. This is a very curious feature, because the lips themselves show no sign of “pick” marks, but instead are smoothly contoured surfaces. Only at the upper vermilion border can we see these marks. No doubt where the upper



Approximately .30 inch (7.62 millimeters)

Figure 4.8. Close-up of a Luxor Ramses' mouth

and lower lips meet, the tool used was much smaller. The marks here indicate that a round tool was used to define the junction of the closed lips, with a rough estimate of the size being a diameter of 0.09 inch (2.286 millimeters). The tool probably had a bull nose and the shape of a punch. It appears that this detailing was done by plunging the tool into the granite and then moving it across the profile of the lip the distance of a tool width, and then repeating the process.

When considered with the mistake made on the mouth of the Ramesseum Ramses (figure 3.10, p. 78), a strong argument can be made that these details were applied by hand after the head was carved with larger and more efficient tools and methods. A logical sequence of steps would be to cut the geometry of the head using one program or model and a large, more robust tool that would remove material efficiently. Then, with a smaller tool use separate programs or models to cut the mouth, eyes, and ears. A close-up of Ramses' right eye with magnified inset provides more evidence of the plunge technique used to craft the finer details of the statue (figure 4.9). After these tasks had been completed, a hand tool could have been applied to create a sharper definition at the borders of the facial features—the shape of which had

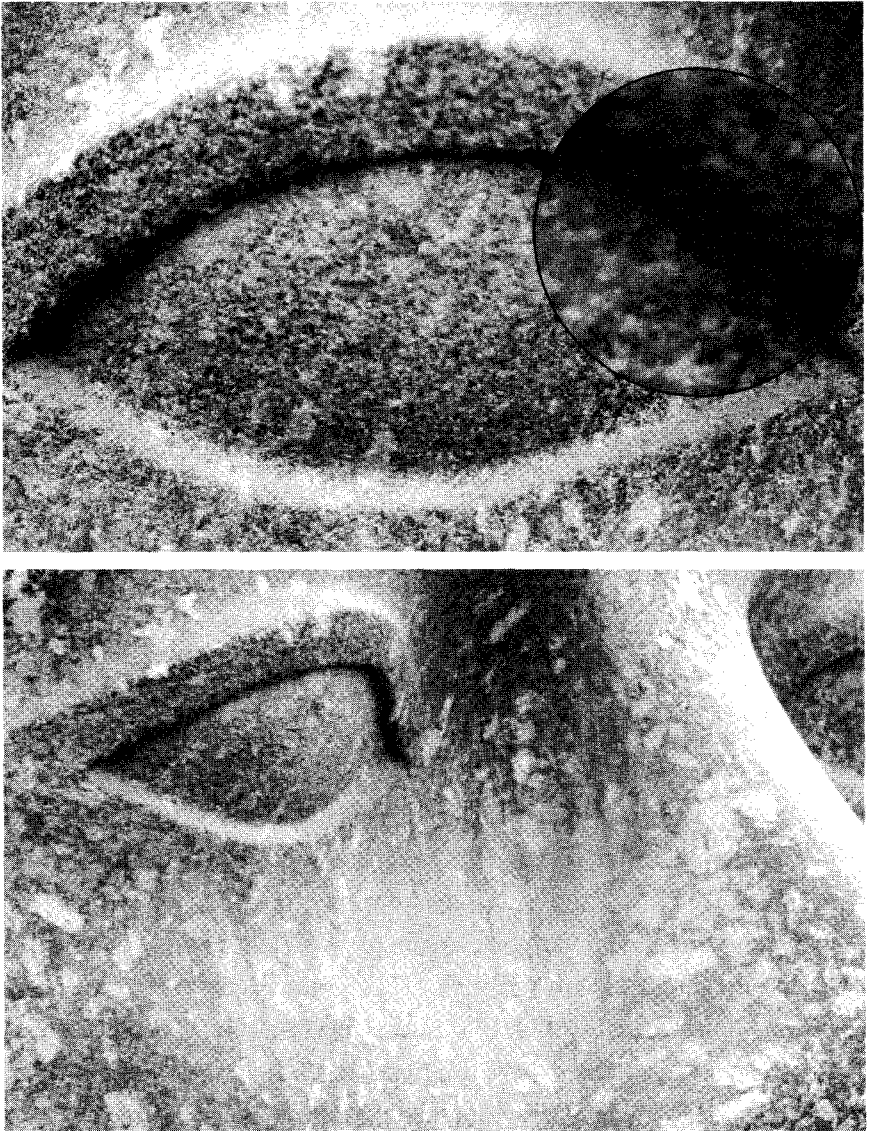

Figure 4.9. Close-up of a Luxor Ramses' eye

already been defined using mechanical assistance. A more distinct view of a cusp left between paths that the tool followed is seen in figure 4.9. Finding the mouth slightly off center with the jaw line and nose (seen in figure 2.13, p. 53) is not surprising in this scenario and may be

explained by the introduction of another tool and a reorientation of the mechanical axes with the geometry of the head.

Even if we ignore the seeming imprecision of the existence of tool marks on the Ramses' statues, we cannot ignore the exactness of their geometry. This degree of accuracy proves an important point. To achieve geometric perfection by hand involves an enormous amount of very careful grinding and polishing. Yet there are no scratches on the Ramses head that we would normally associate with grinding and polishing. Moreover, grinding and polishing would show more of the random direction of the artisan's stroke. It appears, from all the evidence that I have seen in Egypt, that the ancient artisans had achieved the net shape of their final product without leaving behind any areas that we could look at and identify as an area that required a little more polishing than another, which has long been the hallmark of crafting precision products by hand. In modern times, on the other hand, very exact surfaces can be cut on a machine, and tool marks are left to show the path over which the tool traveled. Depending on the requirements of the tool, sometimes the tool marks have to be removed, other times, as in figure 4.3 (see p. 97), it is not necessary.

While there are over one hundred known Ramses in Egypt, it is astonishing to learn that Amenophis III, also known as Amenhotep, had more than two hundred fifty statues crafted in his likeness. Once we see the exacting accuracy on one statue, we can only imagine more than two hundred fifty being created. We can imagine a production assembly line, with roughers, finishers, and fine detailers; followed up by an army of craftsmen applying deeply etched hieroglyphs and reliefs. Moreover, the execution of the design across Egypt, from Abu Simbel in the south to Memphis and Alexandria in the north, implies that a standardized system of measure and production-line manufacturing must have existed that would not be out of place in today's society.

The amount of time it would take to accomplish all of this work in igneous rock is extraordinary. The statues of Egyptian pharaohs were crafted with symmetry—as though each sculpture was a stylized representation of only their most perfect image. Was this a self-image that the

pharaohs wished their subjects to see, or was it the result of techniques that the craftsmen developed in their cloistered workshops with tools of which we have yet to gain knowledge? Ramses is not the only pharaoh with perfect symmetry. Amenophis III and most other Egyptian statues are also crafted to an extraordinary symmetry.

The dimensions applied to the outline of the jaw on Amenophis III indicate a precision of plus or minus 0.06 inch (1.52 millimeters), which on a human scale would be 0.01 inch (0.254 millimeter), or half the thickness of a thumbnail. The continuation of the use of ellipses in the design is evident in the face and crown of figure 4.10 as well as in figure 4.11.

Some of the statues I photographed, though severely damaged, have

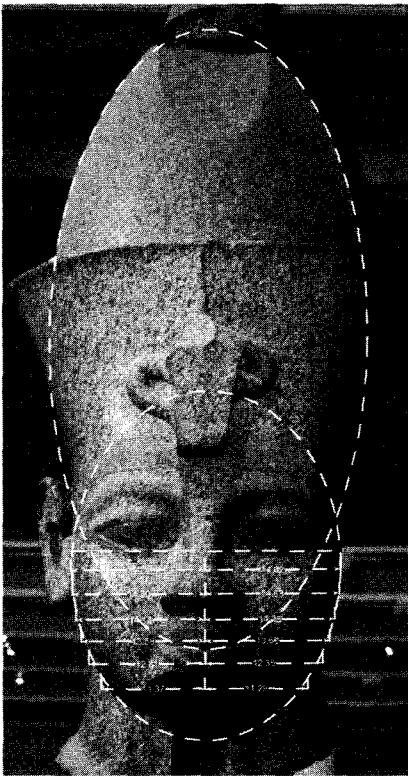

Figure 4.10. Amenophis III from the Temple of Mut in Thebes

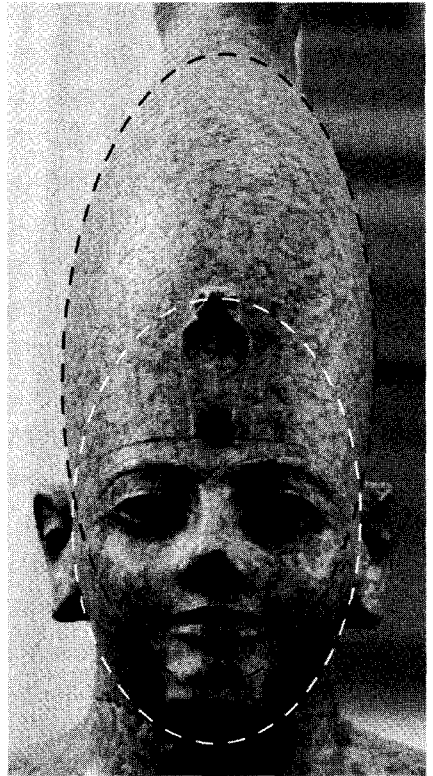
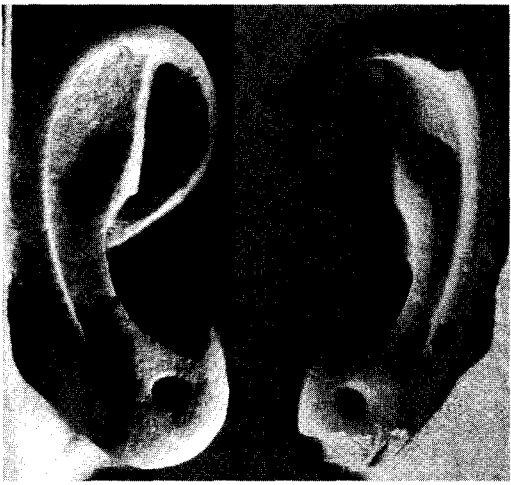

Figure 4.11. Red granite figure of king from the temple of Karnak with elliptical design

outstanding features that invite this kind of photographic study. While little attention is given to the ears of a statue because there are more outstanding features to look at, in studying the ears of Egyptian statues, there appears to be a mechanical precision and application of geometry in how they were crafted. A close-up of Ramses' ears at Luxor and

Left ear of standing statue of Ramses in the Ramses Hall, Luxor



Right ear and left ear of Ramses outside Luxor Temple

Left ear of Amenophis III at Karnak



Figure 4.12. Ramses' ears with Amenophis III left ear



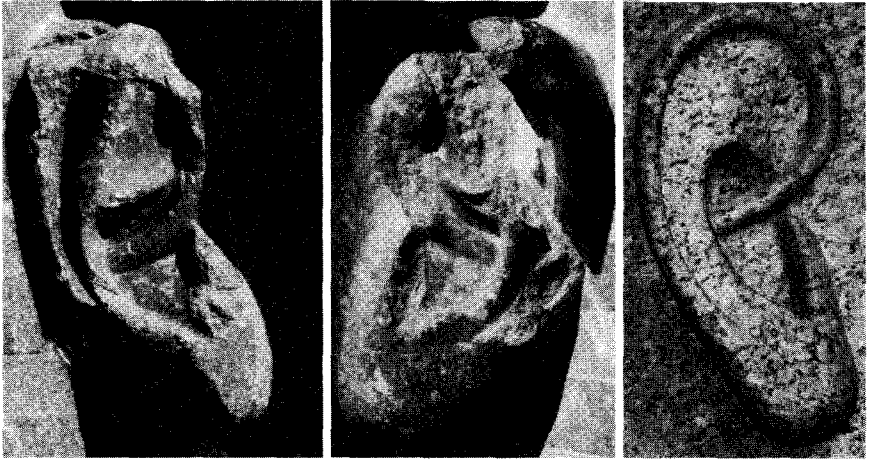

Figure 4.13. Ramses' ears at the Ramesseum with Amenophis III's ear from the temple of Mut

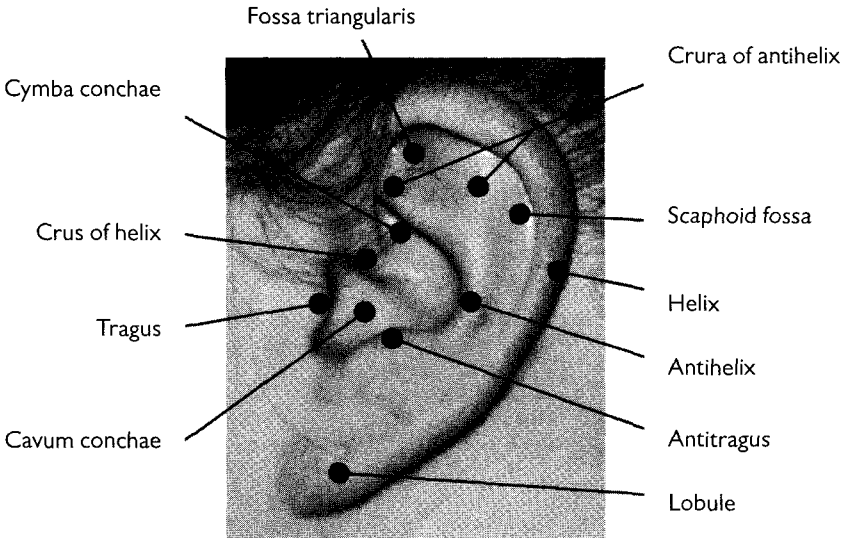

Figure 4.14. Jeanne's ear

Karnak and on the remains of the shattered bust at the Ramesseum (see figure 4.13) reveals uncommonly sharp inside corners and fine detailing. We cannot help pondering the kinds of tools employed to create these features. Though there is evidence on the Karnak Ramses statue of a rectangular tool driven against the granite (see plate 9), leaving sev-

eral depressions above the eyebrow, the shape of this tool could not have been responsible for the final finish of the ears.

The Ramses at the Ramesseum, especially, reveals inexplicable features that are not found in a normal ear. The insides of the *cavum conchae* and the *cymba conchae* come to sharp corners, whereas a normal ear is rounded in the corners. From a manufacturing perspective, if the ear was created using a hammer and stone chisel, these features would require more work to accomplish than would the rounded corner that we see in a human ear. If the feature resulted from a special tool being driven into the granite, then a tool with a small radius with a rake angle would remove the material more efficiently, because there would be less surface area to cut.

From this chapter, along with chapters 1, 2, and 3, the picture that is beginning to emerge is that the ancient artisans were more interested in efficiency than exact replication of the human form. We have studied in detail only the head and crown, but all over these ancient statues we can find examples of mechanical exactness and economical production. Features left out, such as the knuckles, along with standardized design, may suggest an intentional stylization, but they might also have been ways simply to make the already enormously difficult manufacture of a statue slightly less taxing.

Of all the statues I have studied, one shows a most perfect ear, free of damage and dirt: the only ear that Amenophis III has remaining is his right ear (see figure 4.13), which epitomizes in its simplicity of form a perfection on a smaller scale with what the ancient artisans did on a larger scale: applying simple geometry using a minimum number of circles, or radii, to create three-dimensional form.

Without quantifiable measurements, we cannot argue that the geometry and symmetry of ancient Egyptian statues were dimensionally perfect. We can only, as up to now, provide a preliminary study. What has been shown could have the effect of combining imperfections to give the impression of perfect geometry, and the process of overlaying one image with another may produce a “forced” symmetry in which features blend and appear to become one. Nonetheless, there can be no doubt that symmetry was the Egyptians’ objective in creating these statues, and even if

they did not achieve perfection, they came much closer than what could be accomplished by visual comparison.

Today, archaeologists employ modern imaging tools to analyze ancient artifacts. In Thebes, archaeologists are reconstructing a colossus of Ramses II that was destroyed by Christians hundreds of years ago. Like a puzzle, hundreds of pieces lay strewn on the ground. Each piece is photographed in three dimensions on a revolving metal caster plate, then the images are analyzed in a computer and reconstructed in virtual space. This technology can record images that are within 40 microns (0.00157 inch) of the surface that is measured, and these will be used to determine the feasibility of reconstructing the colossal statue.<sup>4</sup>

Replicas of ancient statues have also been made using modern, computer-controlled machinery. The information that is given to the computer to create the shapes is taken from the statues themselves using laser scanning or stereo photographic imaging techniques. The results are then fed into the computer, and paths are generated for tools to follow in the machine. A replica of the bust of Emperor Constantine was created in this manner using Delcam CAD/CAM software generated from the information gleaned from the original bust in Rome.

The next likely step in analyzing the Ramses statues would be to scan their geometry into the computer to create a computer model, then bisect the head and compare one side to the other to accurately determine the variation between the two halves. From what we have studied in chapters 2 and 3, there is good reason to believe that the information gathered will contribute significantly to our understanding of our past. We might find further evidence that the ancient engineers were more like us than we previously thought.

The ancient Egyptian artisans had to have had some means of taking precise measurements. This statement becomes more meaningful when we study artifacts with less complex geometry that can be measured with simple, modern-day instruments in the field. This is where we will go next. From Luxor, we will travel to Cairo, where there is much to be learned in a mysterious underground complex near the Step Pyramid at Saqqara.



5

# The Shadows of the Serapeum

*Art without engineering is dreaming; engineering without art is calculating.*

ANONYMOUS

*The difference between men is in their principle of association. Some men classify objects by color and size and other accidents of appearance; others by intrinsic likeness, or by the relation of cause and effect. The progress of the intellect consists in the clearer vision of causes, which overlooks surface differences.*

RALPH WALDO EMERSON, *ESSAY ON HISTORY*

Before I experienced exalted vistas of granite and a rush of wonder in the temples in Upper Egypt, I undertook a descent into the shadows of what must be the most confounding and enigmatic archaeological site in the world. While the statues of Luxor and columns of Dendarah provide lift to the mind and spirit, we find a different perspective in the subterranean vaults of a temple located northwest of the step pyramid at



Figure 5.1. The entrance to the Serapeum

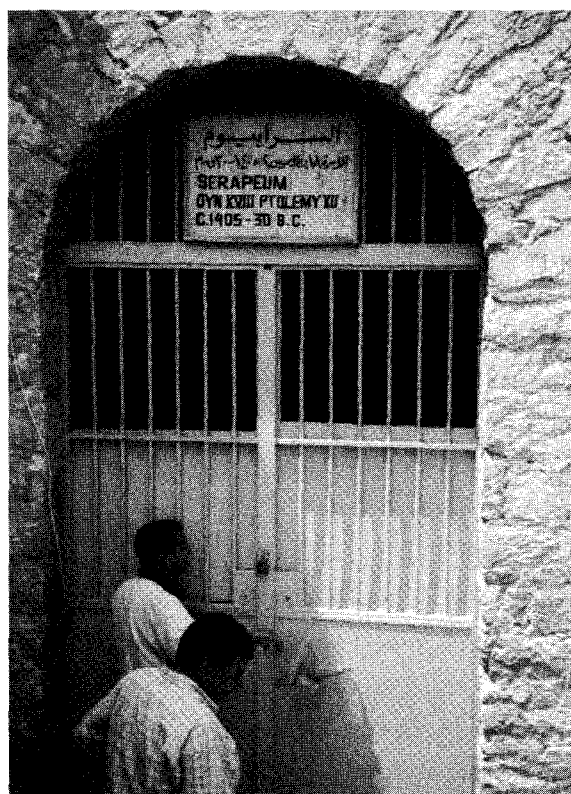

Figure 5.2. Entering the Serapeum

Saqqara. There is little above ground to identify these vaults except the hut of an Egyptian tomb guard (also known as a *ghaffir*) and low walls on both sides of an inclined path that lead to formidable, dungeonlike iron doors. Attached to the iron bars that form a transom light above the yellow painted doors, a sign painted in Arabic and English reads: SERAPEUM DYN XVIII PTOLEMY XII CA.1405–30 BCE.

I first visited the Serapeum in 1995 with a Canadian researcher named Robert McKenty. Since that time, my mind has returned to its mystery and the confounding challenge that it presents modern researchers. It is not on the tourists' venue because it is considered too dangerous to visit, and it is closed to the public. At the time of my visit in 1995, I possessed a precision-machined parallel that I had been using to determine the flatness of numerous granite blocks scattered around the Giza Plateau. The edge on the parallel was accurate to within 0.0002 inch (0.005 millimeter), or  $\frac{1}{10}$  the thickness of a human hair.

I brought it with me on the day of our visit because Robert had asked me to accompany him to Saqqara, where, in the courtyard in front of Unas's pyramid, he thought he had discovered a piece of granite that might be the result of machining. As it turned out, the object was not exact, and there was nothing about the piece that indicated

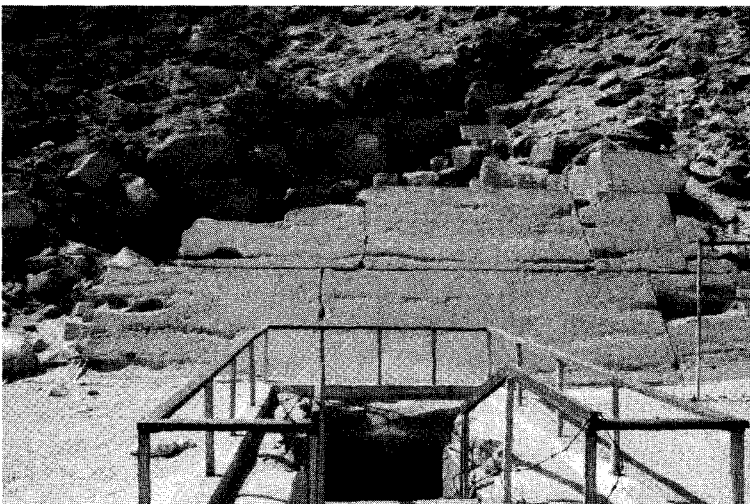

Figure 5.3. Queen Unas's pyramid with massive casing stone

that it was machined. Above the entrance to the pyramid, however, was a very impressive casing stone that surpasses those found on any of the pyramids on the Giza Plateau—one block above the entrance passage measures approximately 25 feet (7.62 meters) long and 5 feet (1.524 meters) high. Much has been written about the casing stones on the Great Pyramid, but this was the first time I had knowledge of this massive limestone block on the minor Queen's pyramid.

Unknown to me at the time I visited the pyramid were other artifacts not too far away that would receive my attention and put my parallel to good use. It was about noon and a typical hot day at Saqqara, with the sun beating down unmercifully on our heads. We had already kicked up a great deal of sand traipsing all around the step pyramid and the associated temples and lesser pyramids, so we headed over to the Serapeum, where the Netherland Television people—who had brought me to Egypt to interview me with Graham Hancock and Robert Bauval—were filming. I was not on the storyboard today, having fulfilled my obligation in the Great Pyramid a day earlier, but I appreciated the opportunity to wander a site that is not normally visited by tourists.

First to greet a visitor who enters the Serapeum tunnels is a massive piece of granite sitting on the floor in an entrance hall. The piece is estimated to weigh approximately 20 tons and has a rough finish. To the right, a larger piece of granite sits in a dimly lit passage where there is barely enough room to get around. The rough outside dimensions of the piece are 7 feet (2.133 meters) in height, 7 feet (2.133 meters) in width, and 13 feet (3.962 meters) in length. With granite weighing 175 pounds per cubic foot, as a solid piece this piece would weigh approximately 55 tons. Peering at the top of the piece, though, I could see that the inside had been roughed out, leaving a wall thickness of approximately 1.5 feet (45.72 centimeters). With this material removed, the box weighs approximately 38 tons.

The entrance hall is larger in width and height than the tunnels where the boxes are installed. Cut into the walls are rectangular depressions that bring to mind images of large cutting tools boring into the

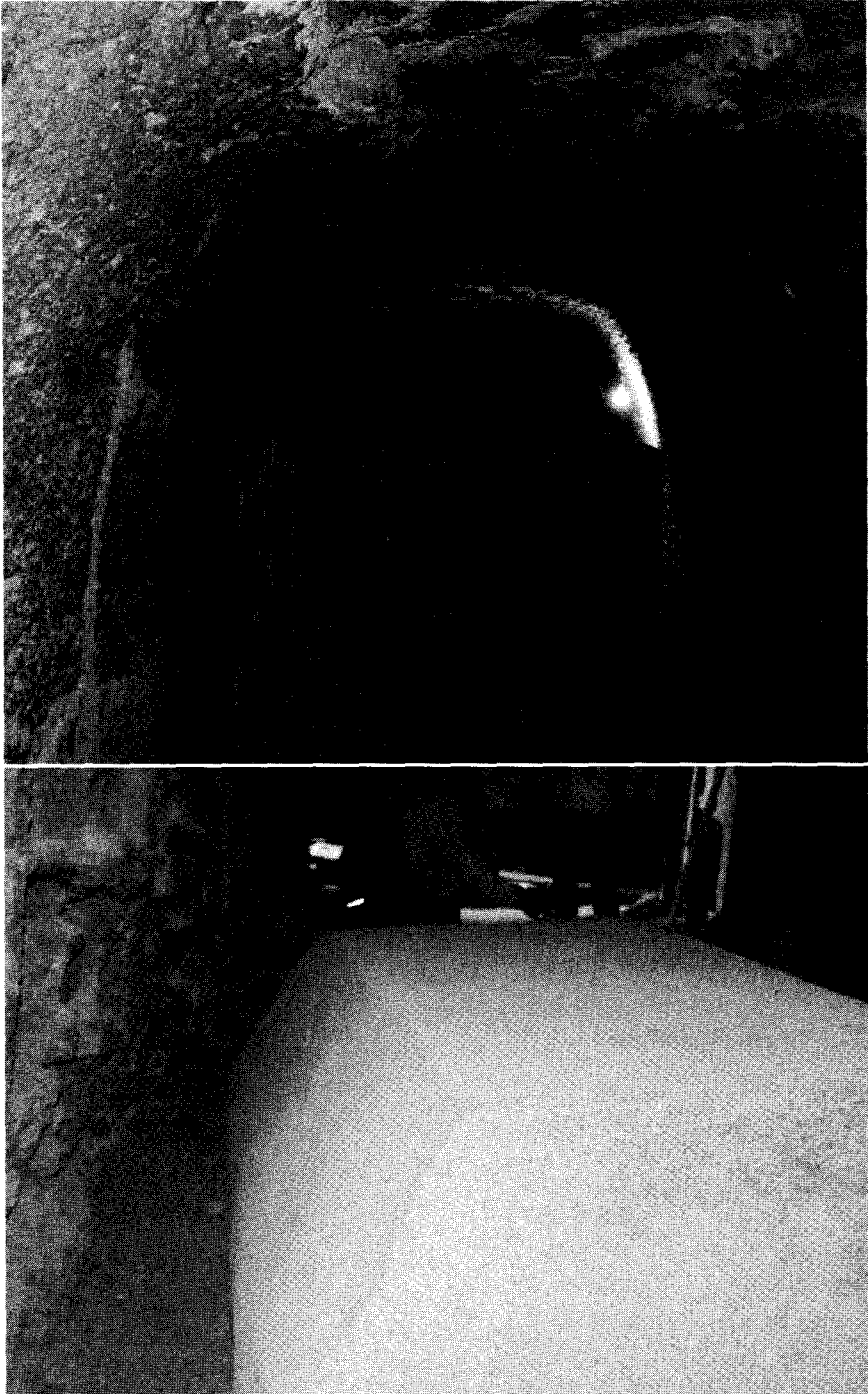

Figure 5.4. Roughed out box and lid in the Serapeum



rock to remove material quickly. Along their vertical length, the bottoms of some of the depressions are concave, while others are flat. Some have an arched top and others do not. The arrangement of depressions is haphazard and does not appear to conform to any particular design criteria. Egyptologists' accounts of the Serapeum speak of hundreds of votive stelae lying in the passageways or embedded in the walls: "These stelae contained dedications to Osiris-Apis and, as already mentioned,

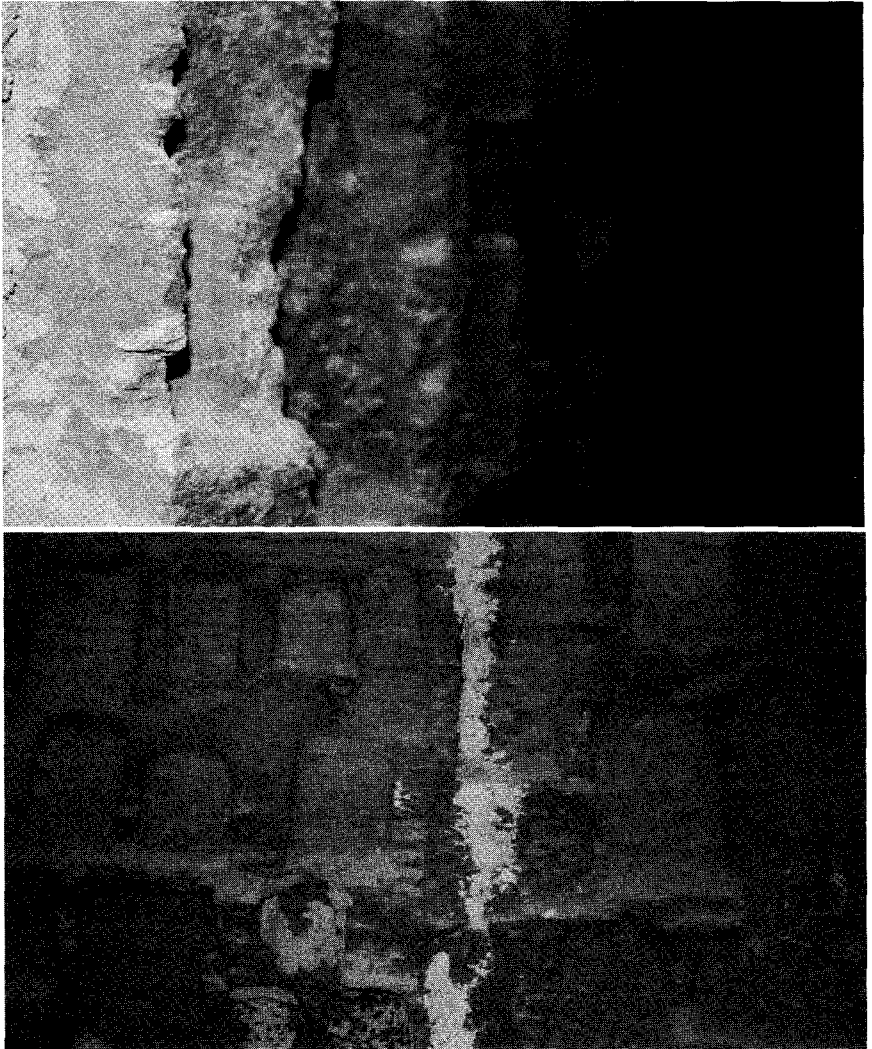

Figure 5.5. Serapeum entrance hall with rough and random depressions cut in wall

were sometimes dated by the regnal years of the reigning monarch.”<sup>1</sup> From these stelae, scholars gathered the chronology of the site, for they provided data giving the duration of reigns from the beginning of the twenty-sixth dynasty to the end of the Ptolemaic period.

The niches in the wall are curious features and look remarkably similar to the depressions that are seen on the unfinished obelisk at Aswan. There, on the top of the obelisk and around the trench, we can see similar rectangular depressions, though these have been interpreted as being the result of bashing the area with stone balls. If we consider the discovery of votive stelae installed in these niches, it would be logical to assume that the niches were created specifically to house them. On the other hand, if these depressions were the marks left by the tunnel borers, they may have been convenient places to place the stelae, for not all the stelae were installed in wall niches, and the walls beyond the entrance hall are mostly devoid of them.

From a historical perspective of the purpose of these niches, the final analysis will surely come down on the side of the Egyptologists. The stelae have been found in situ and the tunnel boring tools have not. Nonetheless, from an engineer’s perspective, they do have the same appearance as the tool marks on the Unfinished Obelisk at Aswan, and

Figure 5.6. The Unfinished Obelisk at Aswan with evident quarry marks (Photograph courtesy of Dan Hamilton)

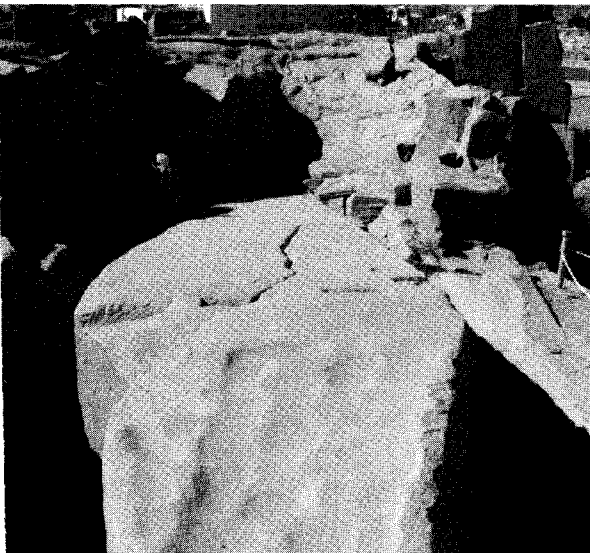

an argument could be made that the stelae were made to fit existing depressions in the wall that were left by ancient tools plunging into the rock to carve out this mysterious underground cavern.

Though dark and dusty, the Serapeum was a welcome relief from the heat. Shadows were thrown at intervals along the numerous tunnels by incandescent bulbs, and the place appeared more mysterious because a number of alcoves or crypts were cut at right angles on each side of the tunnel. Both the tunnels and the crypts had barrel-shaped vaulted ceilings that had suffered damage over the millennia, as evidenced by places where large pieces of limestone had separated from the bedrock and fallen. Some areas were protected by wooden frames with thick plywood sheets on top. A fine dust that had been kicked up from the floor hung in the air.

In the center of each crypt there was a large granite box with a lid on top. All of the boxes were finished on the inside and the bottom side of the lid, but not all were finished on the outside. It appears that work stopped suddenly in the Serapeum, for there were boxes in several stages of completion: boxes with lids, boxes that had yet to have the lids placed on them, and the rough box and lid near the entrance. The floor

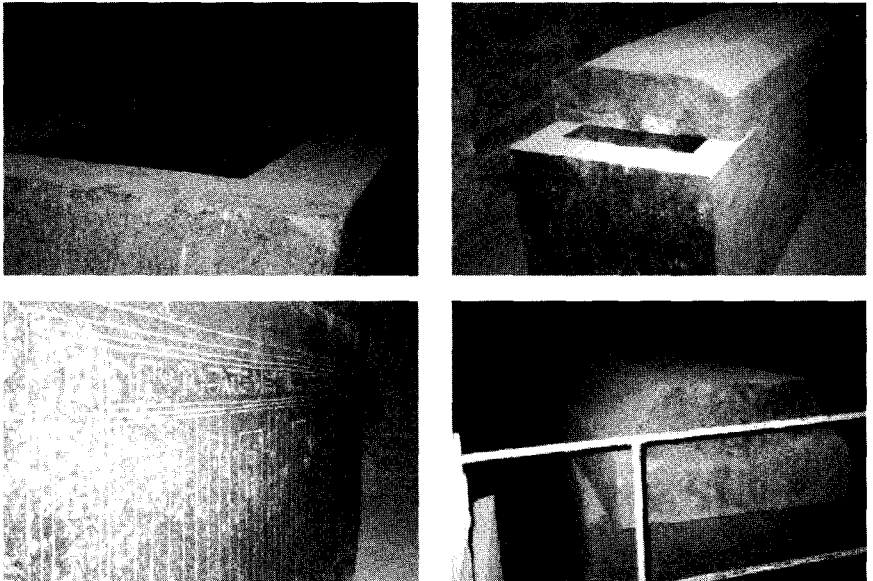

Figure 5.7. Boxes in the Serapeum

of each crypt was several feet lower than the tunnel floor. Iron railings were installed to prevent visitors from falling.

The historical explanation for the boxes in the Serapeum is that they were funerary sarcophagi that were used to hold the carcasses of the sacred Apis Bull—even though no bulls (or their skeletons) were found inside them, so it is assumed that they were rifled in antiquity.

The Apis Bull was considered to be a god by the ancient Egyptians, and the Serapeum was reputed to house the burial vaults of the Apis cult. With the passage of time and following the removal of many artifacts and dust and rubble from the site, the Serapeum probably looks different today than it did one hundred thirty years ago, and early explorers gave their attention primarily to what could be gleaned from the debris. Yet nagging questions still dwell in my mind about this mysterious, hypogeal refuge from the sandy desert and piercing sun—questions about significant details not found in the historical literature. With the debris removed, my attention was drawn immediately to the engineering of the granite boxes.

Auguste Mariette (1821–1881) is credited with the modern discovery and exploration of the bedrock tunnels that are what is left of the Temple of Serapis—the Serapeum. Mariette is considered one of the greatest explorers and Egyptologists of his era, and he was the founder of the world-famous Cairo Museum. He is credited with doing more for the preservation of Egyptian monuments and prevention of the pillage of antiquities than any other scholar of his generation. In his exploration of the Serapeum he followed on the heels of other explorers, and he notes the work of the Roman geographer Strabo, the first person to have written about the Serapeum and a recorder whose work has survived the centuries. In his *Geography*, Strabo writes: “There is also a temple of Serapis, situated in a very sandy spot, where the sand is accumulated in masses by the wind. Some of the sphinxes which we saw were buried in this sand up to the head, and one half only of others was visible. Hence we may conceive the danger, should any one, in his way to the temple, be surprised by a [sand] storm.”<sup>22</sup>

In *Le Serapeum de Memphis*, Mariette writes with no small amount

of intensity and passion and reveals a mind that believes it is on the trail of a major discovery:

Did it not seem that Strabo had written this sentence to help us rediscover, after over eighteen centuries, the famous temple dedicated to Serapis? It was impossible to doubt it. This buried Sphinx, the companion of fifteen others I had encountered in Alexandria and Cairo, formed with them, according to the evidence, part of the avenue that led to the Memphis Serapeum . . .

It did not seem to me possible to leave to others the credit and profit of exploring this temple whose remains a fortunate chance had allowed me to discover and whose location henceforth would be known. Undoubtedly many precious fragments, many statues, many unknown texts were hidden beneath the sand upon which I stood. These considerations made all my scruples disappear. At that instant I forgot my mission (obtaining Coptic texts from the monasteries), I forgot the Patriarch, the convents, the Coptic and Syriac manuscripts, Linant Bey himself, and it was thus, on 1 November 1850, during one of the most beautiful sunrises I had ever seen in Egypt, that a group of thirty workmen, working under my orders near that sphinx, were about to cause such total upheaval in the conditions of my stay in Egypt.<sup>3</sup>

Mariette's workers began to excavate the avenue flanked by these sphinxes, which were carted off for display in various museums. After some wrangling with the Egyptian government over permissions, which delayed the work for several months, Mariette's workers continued and eventually gained access to the tunnels.

Apparently unknown to Mariette at the time of his discovery was the report of the Englishman A. C. Harris (1790–1869), who identified the Serapeum as the same one described by Strabo and announced his discovery in a lecture in London in 1848. Prior to Harris, a French explorer named Paul Lucas (1664–1737) published his account of a somewhat terrifying descent into the dark and mysterious tunnels in

*Voyage de Louis XIV dans la Tuquie, L'Asie, Soutie, Palestine, Haute & Basse Egypt, &c.* (Rouen, 1719):

After examining this monument [the obelisk at Matariya] and viewing the three beautiful pyramids that we found on our way, we finally arrived at the pit that we were looking for. It appeared square from the outside and 12 feet in diameter and around 30 feet deep. We all went down and lit up several candles that I had brought with me. As soon as we reached the bottom, we found a hole in which we had to lie on our stomachs for about twenty feet. This first entrance was guarded by a snake that frightened us, and which we killed. If the entrance to Lake Aveine had been as frightening as the one I have just mentioned, poets could have written more dreadful descriptions of Hell that they have left us. After having traversed, with much trouble, this narrow channel, we found ourselves in a large corridor, on both sides of which one could see an endless number of pots of clay of which I have spoken, and of which the covers were sealed with mortar. There were a large number that were broken; the others were still intact: there were within these pots birds, embalmed and swathed in bands and cloth, like the mummies. The underground vault was huge and had many galleries leading to the right and to the left. It was impossible to visit them all. Adopting the strategy of Ariadne and her lover before he entered the Labyrinth to fight the Minotaur, I had brought two thousand fathoms [3,646 meters] of string, but this ran out before I reached the end of the cavern, after which we were not prepared to penetrate further.

All the galleries were cut in the rock, and there were a mixture of kinds of chambers, those filled with these pots, and the others with mummies, most of them reduced to dust. I noticed in many of the niches the heads of bulls, from which I deduced that this was the place where the god Apis was interred; I have no doubt that the bull-head that was given to me for M. de Valincourt by M. le Maire, Consul in Egypt, came from this place. It had been found by the Arabs of Sacara in a chamber cut in the rock and hermetically

sealed, which by a singular chance was opened and an embalmed bull found.

I found something similar in the catacombs that I have described; this bull was buried in a large case, upon which the head was represented: this case was gilded and painted, and surrounded by a beautiful balustrade around 5 feet high, also gilded and painted in various colours. There was also found in the same area eight urns of white stone, upon the covers of which are represented the heads of young girls, and upon the sides many sorts of hieroglyphs. . . .<sup>4</sup>

Aidan Dodson assesses Lucas's discovery:

The large gilded and painted case that was surrounded by a five-foot high balustrade, by Lucas's account, is considered to have been made of wood by modern Egyptologists. However, there is some doubt cast on the accuracy of Lucas's work because of his presumed lack of literary skills and the fact that his book was assembled from his notes by a ghost writer.<sup>5</sup>

Also clouding an accurate understanding of the provenance of the site is the disappearance of Mariette's excavation journals after he entrusted them to Eugène Grébaut at the Louvre in Paris. The archaeological report of Mariette's excavations was left to Gaston Maspero, who completed it in 1880, using an incomplete manuscript left by Mariette.

With uncertainty and confusion surrounding the discovery of the Serapeum, experts on the archaeology of the site, such as Dodson, Ibrahim, and Rohl, have attempted to bring some sense of order to the history of the Serapeum, but they are working with artifacts that provide less than the best evidence for a solid, scientific theory—and they are working with hearsay accounts from ghost writers who cannot provide the accuracy of the original researcher whose methods, by today's standards, are considered crude: "When Mariette first undertook excavation work at Sakkara he was 29 years of age and without previous archaeological experience. In those days tomb clearance and analysis of finds in

situ were still crude operations, to say the least, for it was not until the 20th century that archaeology became a more exacting science.”<sup>6</sup>

Despite the confusion, there seems to be no equivocation from Egyptologists about the purpose of the site. This was indeed the burial place of the sacred Apis Bull: Bull heads were found in niches in the tunnels, and a statue of a bull was retrieved from the tunnels and now sits in the Louvre Museum in Paris.

Because the ancient Egyptians worshipped the Apis as a god, a search was made throughout the land for a replacement of one that died or was about to be sacrificed. When an Apis died, people throughout the land mourned and practiced a self-imposed celibacy. Until another Apis was found—a bull recognized by distinct black and white markings with a saddle mark and white blaze on the forehead—there was no sex. To say that the mourners were motivated to find a bull, and in a hurry, would be an understatement. Once the animal was found, the new god incarnate was installed with celebration and joy. The continuity of the Apis god among the Egyptians was assured, signifying that the heavens were pleased and that the land and its people would be protected and flourish.

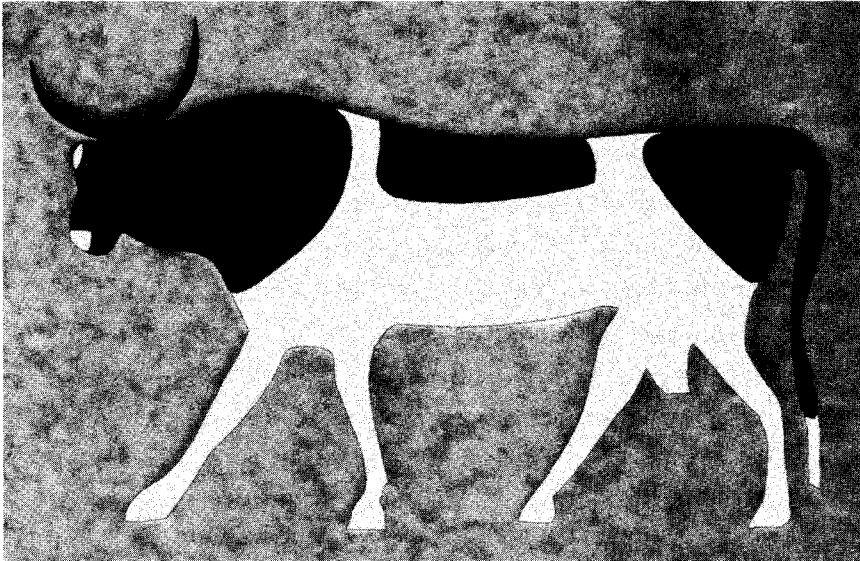

Figure 5.8. The Apis Bull



Exploring the tunnels of the Serapeum for the first time was both intriguing and frustrating. Along the dusty corridors were more than twenty-two large boxes. Each was cut from a solid block of granite, and remarkable to each was a feature that was characteristic of fourth-dynasty boxes. The inside corners have small radii (see figure 5.7), and such features are significant to engineers and craftsmen because of the added difficulty and time required to create a sharp inside corner in hard igneous rock that is made up of 55 percent silicon quartz crystal (a hardness of 7 on the Mohs scale). The technological questions it raises are straightforward—for example, what type of tool was used and why such sharp corners were needed—but after the passage of time, we can only speculate based on circumstantial evidence (the boxes themselves) and engineering sense. Reconciling these technical questions and their implications with the cultural context of the site as described by Egyptologists requires some mental gymnastics. One question in an engineer's mind: Why did the Egyptians transport 70 tons of rock five hundred miles down the Nile just to house the body of an animal? Though we must recognize that different cultures have invested significant expense in worshipping animals, there is something about this particular site that does not add up.

In one of the crypts there is a granite box with a broken corner, and this box is accessible by means of steps down to the lower floor. The outside of the box appears to be roughly finished, but the glint of a high polish on the inside surfaces beckoned me to climb inside. Running my hand along the surface of the granite reminded me of the thousands of times I have run my hand along a granite surface plate when I was working as a machinist and later as a tool and die maker. The feel of the stone was no different, though I was not sure of its flatness or accuracy. To check my impression, I placed the edge of my precision-ground parallel against the surface—and I saw that it was dead flat. There was no light showing through the interface of the steel and the stone, as there would be if the surface was concave, and the steel did not rock back and forth, as it would if the surface was convex. To put it mildly, I was astounded. I did not expect to find such exactitude, because this order

of precision is not necessary for the sarcophagus of a bull—or any other animal or human.

I slid the parallel along the surface both horizontally and vertically, and there was no deviation from a true, flat surface. The flatness was similar to precision-ground surface plates that are used in manufacturing for the verification of exactly machined parts for tools, gauges, and myriad other products that require extremely accurate surfaces and dimensions. Those familiar with such products and the relationship between gauges and surface plates know that the gauge may show that the stone is flat within the tolerance of the gauge—in this case 0.0002 inch (0.00508 millimeter) flatness. If the gauge is moved 6 inches along the stone surface, however, and the same conditions are found, it cannot be claimed with certainty that the stone is within the same tolerance over 12 inches—unless the plate has been inspected by another means and is calibrated to a known standard.

Nonetheless, moving the steel edge along the granite provided enough information for me to conclude that I needed a longer straight edge—and, preferably, even more sophisticated alignment equipment—to determine the accuracy of the inside surfaces of the box. I was also impressed to find that each corner of the box had a small radius that ran from the top of the box to the bottom, where it blended with the corner radius of the floor of the box.

Returning to the hotel that evening, my mind was consumed by what I had seen. These artifacts were meticulously crafted boxes on a very large scale. Whoever decided to make them in this way did not have a whimsical fantasy about how pretty they would be as the bulls' final resting places. It just didn't make sense to think that the ancient Egyptians would pour such resources into manufacturing coffins while the mausoleum where the god Apis rested was rough cut and undecorated, except for a jumble of stelae with no pretense to geometric balance and harmony. As for the boxes, once the lid was on top of each of them, nobody would see the perfectly flat and polished surfaces or the conformity to orthogonal precision. Visitors would see only a dusty, dark, and rough-hewn catacomb that looked more like a

London Underground tunnel than a mausoleum designed for a god.

The challenges that these boxes would present to an engineer with modern stone-working tools are significant. This was confirmed for me when I arrived back in the United States and contacted Tru-Stone Corporation, a Minnesota-based manufacturer of granite surface plates, angle plates, V-blocks, and machine bases. In 1995, I provided Eric Leither, their engineer, with the specifications for creating one of these boxes, and he responded:

Dear Christopher,

First I would like to thank you for providing me with all the fascinating information. Most people never get the opportunity to take part in something like this. You mentioned to me that the box was derived from one solid block of granite. A piece of granite of that size is estimated to weigh 200,000 pounds if it was Sierra White granite, which weighs approximately 175 lb. per cubic foot. If a piece of that size was available, the cost would be enormous. Just the raw piece of rock would cost somewhere in the area of \$115,000.00. This price does not include cutting the block to size or any freight charges. The next obvious problem would be the transportation. There would be many special permits issued by the D.O.T. and would cost thousands of dollars. From the information that I gathered from your fax, the Egyptians moved this piece of granite nearly 500 miles. That is an incredible achievement for a society that existed hundreds of years ago.<sup>7</sup>

Mr. Leither goes on to say that Tru-Stone did not have the equipment to create this box and that they would have to create it in five pieces, then ship it to its destination and bolt it together on site.

After my treatment of this discovery in my earlier articles and my first book—which reflected my excitement—some readers concluded and have claimed that such work cannot be done today, but it was not my intention to mislead readers into concluding that modern engineers could not devise the means to create these artifacts today. It was my intention to portray the artifacts as incredible, out-of-place anoma-

lies that display attributes that are uncharacteristic of the capabilities of the tools available during the time period when they were allegedly produced.

In 1999, I had another opportunity to visit Egypt, and during my time there, I tried to access the Serapeum again, for this time I had brought with me a longer straight edge and a toolmaker's solid square. Try as I might, though, I was unable to gain access to the temple. I was told it was too dangerous due to water damage and that pieces of the ceiling were in danger of collapsing. I had obviously asked the wrong person for help, though the local businessman I had met at the Mövenpick Restaurant at Giza claimed that he had influence and could assist me.

In 2001 my luck changed when I was invited to be part of a documentary that Grizzly Adams Productions was making for PAX television. I arrived in Cairo at 1:00 a.m. and was helped into a taxi that was driven by a man who was quite obviously intoxicated and who, after several stops for food, water, gas, and a bathroom—all accompanied by conversations with friends—took almost two hours to arrive at a destination that would normally take less than an hour. After we arrived at the Oasis, the driver held my suitcase hostage while demanding *bak-sheesh* on top of the money I had paid for the taxi.

It was during this time that I met Dr. Zahi Hawass, who was at that time the director of the Giza Plateau. (Dr. Hawass has since been promoted to chairman of the Supreme Council of Antiquities.) We first met at the Cairo Hilton coffee shop, where Gail Fallen, *Grizzly Adams* field producer, introduced me to the camera crew. Dr. Hawass was charming and charismatic and listened attentively as Gail described what the video was about and what its main thrust was. Dr. Hawass was cordially dismissive of the reference to a Hall of Records, and he turned to me and asked, "What do you do?" I told him that I was an engineer and was here to pay respect to the amazing engineering feats of his ancestors. He seemed content with that answer, and the meeting concluded with arrangements for him to be interviewed the following day.

Gail Fallen had shown interest in going to the Serapeum, and after the filming was finished, we visited Dr. Hawass in his office on the Giza Plateau in hopes of receiving permission. Dr. Hawass was even more ebullient and charming than when we first met. He gave us a slip of paper with permission to see several archaeological sites: the Great Pyramid, the workers' village, and the rock tunnels of the Serapeum.

I was particularly interested in seeing the workers' village, which was a part of the Giza Plateau mapping project undertaken by the Oriental Institute in Chicago, under the direction of Dr. Mark Lehner. I was immediately struck by the difference in workmanship between the constructed walls of the village and those of the pyramids. Though the construction on the Giza Plateau was of the highest quality, with close-fitting limestone blocks, the stones built into the walls of the village were rough in shape and more like those you would find in a shepherd's dry-stone wall in the north of England than where the world's finest stonemasons once lived.

When I visited the limestone quarries near Bedford, in southern Indiana, I met a quarry worker, Tom Adams, at his home. His house, like all the other houses in the area, was built of dressed limestone that was square and regular and mortared in place to create a straight and true structure. The limestone walls of the house may not have been as precise as the Great Pyramid, but at least they reflected the stoneworking capabilities of the local industry and the skill of those who worked in the quarries and lived in the houses.

My impression was that the newly discovered settlement, the so-called workers' village, was not the home of the pyramid builders, but instead was built later out of some of the waste gathered from the plateau. Within the walls of the settlement were chunks of undressed granite, and on the plateau by Khafre's pyramid are large granite casing blocks that were stripped from the pyramid and that have quarry marks on them and pieces broken off the ends.

Dr. Hossam Abulfotouh asked Mark Lehner about this contemporaneous inconsistency when he attended one of Dr. Lehner's lectures at the American Researches Center in Cairo on December 6,

2006.<sup>8</sup> Engaging specialists in interpreting ancient artifacts in Egypt is absolutely necessary in establishing a credible hypothesis. Without their input, there cannot be a comprehensive understanding of the past. For instance, the pyramids on the Giza Plateau were built not by Egyptologists or archaeologists but by engineers and craftsmen. It is not surprising, therefore, that Egyptologists overlook engineering features and nuances that would be recognized immediately by those who are trained in those disciplines.

From the workers' village, our taxi driver took us to Saqqara and the office of Adel Hussein Mohamed, the director of Saqqara. With consummate Egyptian hospitality, Dr. Mohamed asked us to join him for some tea before entering the Serapeum, and we were delighted to accept. After a short time, the inspector of Saqqara joined us, and we made our way to the entrance to the rock tunnels.

Adel and Mohamed, the inspector, were both extremely good-natured men. I have found during my travels in Egypt that the Egyptian people are the most good-natured people in the world. Their sense of humor is irresistible, and they love to joke around. Walking into the Serapeum was a quite solemn affair, but when I took my flashlight out of my backpack and it fell from my fumbling hands to the ground and the batteries spilled out, the party relaxed and had a good laugh over my clumsiness.

With permission from my host, I climbed inside the box with the opening in the corner and took my gauges out of my backpack. I had with me a solid precision square that had a 14-inch (35.56-centimeter) blade. The square had been calibrated to be accurate within 0.00005 inch (0.00127 millimeter) square. I wiped the dust from the surface of the granite with a damp T-shirt, placed the square against the underside of the lid, and brought the blade in contact with the inside of the box. When I shined a flashlight behind the blade, I did not detect any gap or imprecision on either the lid or the inside surface of the box. Gail Fallen took a photograph while I held the flashlight to illuminate the square. As seen in plate 12, the granite surface was finely tooled to a mirror finish. The reflection off the surface indicates an

optical accuracy—there are no distortions or aberrations in the reflected image. Nonetheless, this does not mean that the surface was flat within nanometers or wavelengths of light—or even the tolerance of the square. What we see is a comparative test using a common gauge that has a known dimension. The results, however, do command attention and should encourage further inspection using more sophisticated metrology instruments, such as autocollimators and specialized laser alignment equipment that can provide surface mapping and orthogonal tolerances.

That an examination with more sophisticated instruments has not yet been performed does not diminish these results when we tackle the question of ancient Egyptian manufacturing sophistication. On the contrary, it dovetails with what I discovered in the temples in Upper Egypt—with the geometry and accuracy found on the Ramses statues. The difference between the statues and the boxes is that the boxes in the Serapeum are crafted with simple geometry that is easily measured, while the Ramses statues require analysis in a computer. What is found in one and reinforced in another is a clear picture of a civilization that had developed state-of-the-art craftsmanship in cutting hard igneous rock to an extremely high level of sophistication.

When compared to the geometry of a Ramses statue, the granite boxes seen in figure 5.7 (see p. 120) has relatively simple geometry consisting of flat and square surfaces. Nonetheless, the difficulty in creating this object should not be brushed aside, because upon measuring the opposite wall, I noted that it too is flat and square with the underside of the lid, which means that the vertical surfaces had to be crafted parallel to each other. Such perfection is not an accident and cannot be produced with the tools found in the archaeological record.

I next slid a precise, hardened steel, 12-inch straight edge along the surface of the granite, and I detected no deviation on a horizontal or vertical run of the instrument. Significant to me, as I drew on my own experience with precision steel on precision granite, was the perfection of the surface up to the tangency point of the corner radius. Having done such work myself and having been trained by craftsmen of old

in creating accurate right-angle surfaces by hand, my mind was full of questions. I did not check the inside vertical corner of the wall for squareness at this time, but I did use a Brown and Sharp radius gauge to inspect the corner radius where the two surfaces meet. I can testify, that when I went through my set of radius gauges in order to select the closest fit, the  $\frac{5}{32}$  inch (4 millimeter)-radius gauge fit snugly in the corner.

The inside corners of the boxes are a confounding puzzle. I wondered why craftsmen would take the time and trouble to work out the corner to a small radius of  $\frac{5}{32}$  inch (4 millimeters). In laymen's terms, a round pencil would fit very nicely in the corner. For the assumed purpose of the box, the resting place of an Apis Bull's carcass, a 24-inch radius would leave plenty of room for the bovine deity. It doesn't make sense to work out the corners to such a small dimension. Next, to make sure that the inside surface of the box was perfectly flat to the tangency point of the radius causes great consternation among technologists who are familiar with this kind of work.

The added cost of having a  $\frac{5}{32}$ -inch radius as opposed to a 24-inch radius would be astronomical if the material was worked by hand. The popular belief that the ancient Egyptians had all the time in the world and could devote months or years to create this box falls flat when we consider the logic involved in creating the box this way. The squareness of the inside corner of the box in the horizontal plane was not checked at this time because of time constraints.

The conditions I witnessed among the boxes indicate a high level of technology. Though Tru-Stone did not have the capabilities to produce such an item, if a manufacturer was under contract from NASA or the Department of Defense to create one identical to those found at the Serapeum—with no expenses spared to do the job—they would certainly find a way. Yet the discussion among their engineers would go beyond what was currently available to them for tools, and they would consider tools that they would need to build specially in order for them to fulfill the contract.

The rough removal of material from the inside of the box would



not present a huge challenge, with the exception that craftsmen were working with a 55-ton block of stone. In considering the finishing of the inside of a Serapeum box, we could draw several conclusions:

1. The dimensions between the opposite walls of the box are the same at the top and at least at the bottom of the square's blade, perhaps to the bottom of the box itself.
2. The lid could not have been on the box when the inside of the box was finished, therefore:
  - The top surface of the box was likely cut flat and square to the inside surfaces.
  - The underside of the lid must have been made to the same surface flatness as the walls.
  - To arrive at this level of precision, the manufacturers would have needed metrology instruments. None have been found in the archaeological record.

Another fact we must consider is the existence of a rough box and lid in the tunnels. This indicates that the boxes were shaped roughly outside the Serapeum, more than likely before they were shipped from the quarries five hundred miles away. Certainly, having the quarrymen perform this task would have reduced the weight of the stone by about 20 tons. Interestingly, evidence in the Cairo Museum suggests that sarcophagi were shipped with the lids attached as part of a single piece of stone. Then, upon delivery, the lids were sawed off. One such box is located on the first floor of the Cairo Museum—it has part of the lid still attached to the bottom and a groove where the saw terminated.

After the lid was separated from the box proper, they were both brought into the Serapeum and were finished underground. We might ask why the work was not completed outside, in the fresh air, or why the work was not performed as the box was in transit from the quarry. We may never know the answers to these questions, but possible answers should be examined along with all the other inexplicable artifacts that do not seem to fit within the conventional view of this ancient culture.

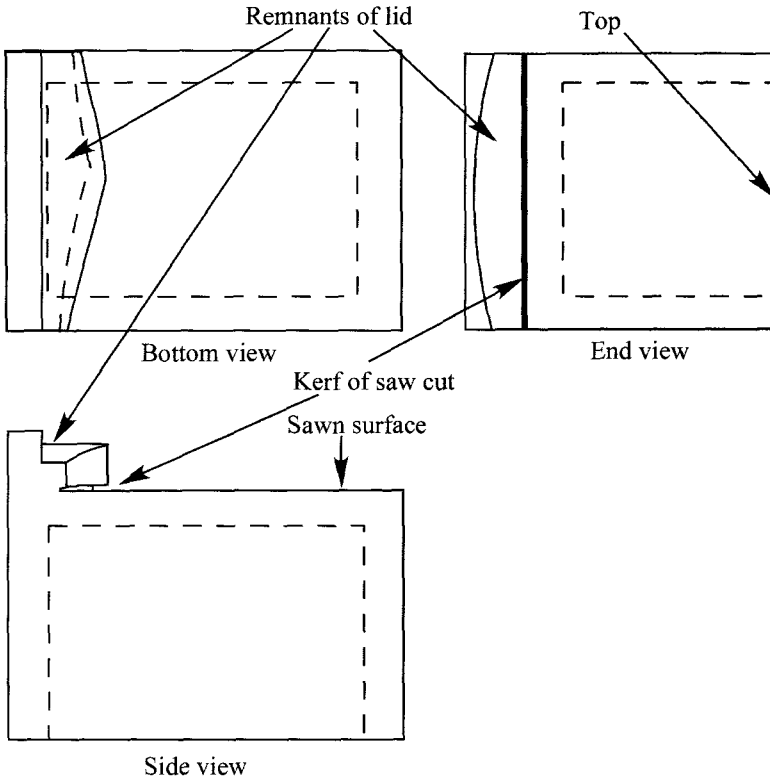

Figure 5.9. Drawing of box in Cairo Museum with remnants of a lid on the bottom

One possible answer for why the boxes were finished within the cooler confines of the tunnels may relate to the accuracy of the surfaces and the need to maintain their accuracy. If they were finished outside and then brought underground, the difference in temperatures would cause the granite to shrink in an unpredictable way, which could affect the surface flatness. This is a concern with all precision manufacturers. Surface plates may be rough machined to within 0.001 inch and then stored outside until an order is received. At that point it is brought into a controlled environment and the surface ground and lapped to specific tolerance. Also, the end users of these products need to make sure they are used in a similar controlled environment. Another reason may have something to do with proprietary processes that the artisans intended to keep hidden.

The engineering context of precision where precision is not necessary indicates the existence of sophisticated tools. These have not been found in the archaeological record, but the existence of them must be taken into account when we consider the mountain of circumstantial evidence to support their use.

In the case of the Serapeum, the list of tools and instruments that are necessary to create the granite boxes has grown. We can say with certainty that exact measuring instruments existed, for this work and the work at Luxor and Karnak could not have been accomplished without them. They are the most important and necessary tools for such work. The wooden squares, plumb bobs, and alignment instruments on display in the Luxor and Cairo Museums are incapable of giving even the most talented craftsman the information he needs to know that his work has achieved this kind of accuracy. Even if these boxes and monuments were crafted today with modern tools, such instruments are limited in what they can measure—and they most certainly cannot explain the precision and geometry that we will look at next. In the next chapter, we will examine artifacts that are similar in geometry, and others with geometry that is more complicated than a simple box, but not as complex as the head of Ramses.

It is to Giza now that we will travel, to follow in William Flinders Petrie's footsteps. Unlike this distinguished man of science, however, who studied on the Giza Plateau in his undergarments beneath a large umbrella in order to gain a wide berth from Victorian tourists, I will not be wearing pink underwear.



## 6

# The Shadow of the Sphinx

*You admire this tower of granite, weathering the hurts of so many ages. Yet a little waving hand built this huge wall, and that which builds is better than that which is built. The hand that built can topple it down much faster. Better than the hand and nimbler was the invisible thought which wrought through it; and thus ever, behind the coarse effect, is a fine cause, which being narrowly seen is itself the effect of a finer cause. Everything looks permanent until its secret is known.*

RALPH WALDO EMERSON, *ESSAY ON CIRCLES*

Using the slow strokes of ancient, ink-dipped quills to the rapidity of modern computers and every instrument in between, inspired minds have churned out hundreds of books replete with superlative prose in an attempt to explain the Giza Plateau, where the most famous Wonders of the Ancient World command the skyline. Whether seen from the shadows of the Sphinx enclosure bathed in the golden hue of sunrise, or from the shaded balcony of Hakim Awyan's home in the village of Nazlet el Samaan, or from the rooftop of Gouda Fayed's famous Sphinx Guest House as the sun sets in the west between the Great Pyramid and Khafre's pyramid, this most famous site in the world leaves the viewer with an impression of awe.



Figure 6.1. The Giza Plateau

To the uninitiated, a trip to the Giza Plateau can be a frustrating affair. When I first visited in 1986, the walk up to the plateau from the Mena House was like running the gauntlet. I had to avoid aggressive sellers from souvenir shops that lined the east side of the street and sold everything from small models of pyramids and T-shirts to replicas of Tutankhamen's mask and papyrus, and workers from nearby stables who insisted that they take you on a camel or horse ride across the plateau. In 2001, a particularly aggressive salesman wearing a *galabeya* opened the door of the taxi I was riding in and tried to get inside to sell his goods. By 2006, the area had been spruced up considerably, and the storefronts were freshly painted. A police station now occupied the souvenir shop, and its officers kept a close watch over the area, protecting visitors from aggressive sellers.

My visit in November of 2008 found a different place altogether. The road up to the plateau now has a particularly robust steel gate, and visitors are directed to a new tourist center, where they buy tickets for access to the plateau and the pyramids. Entrance to the plateau is now

through a turnstile and there are toilets available in the building where security police scan bags and give visitors a welcoming smile.

The entrance fees to archaeological sites in Egypt and elsewhere keep going up, but tourists keep flocking to see these miracles of architecture. Since my first visit to Egypt in 1986, the Egyptian people have awakened to the real value of their antiquities and are pricing them accordingly. Though it may have once cost only two dollars to explore the plateau—and that included entrance to all the pyramids—there is only one Great Pyramid in the world, and to be in its shadow now for only ten dollars is a bargain, particularly when we consider what we have paid in airfare just to get there.

There is a special energy around the Giza Plateau. Some would argue that it is due to the intrinsic design and function of the pyramids; others might dismiss this idea and claim that it is because of the holiday atmosphere of the hordes of tourists that visit the site each year. Throngs of tourists are targets for local merchants, with their hawkers spilling out onto the plateau on a daily basis to sell myriad trinkets and baubles to foreign visitors. Children dart around groups of tourists, pleading to sell hieroglyph-adorned bookmarks, small statuettes, or an Egyptian headdress known as an *egal*. Elaborately adorned pen sets and plaster cast models of famous statues of gods, goddesses, and kings are all offered for sale, and a friendly banter along with bartering is always appreciated by the sellers—but more appreciated is giving them the asking price. I have explored the plateau more than a dozen times over the past twenty-four years, yet it is one place in the world that I cannot seem to get out of my system. I find myself going back again and again for the experience of being in the presence of such magnificent achievements even as I am reminded of my own fragile existence.

The Great Pyramid has stood without question as the first and foremost Wonder of the Ancient World. Though recently an effort was made to revise the list of the Wonders of the World, the pyramids of Egypt need no vote to qualify them. Those in doubt need only perform a detailed study of their construction. No other place in the world is

blessed with such architecture and such exactness of manufacture. Even today, the precision that is found on the casing stones on the Great Pyramid is not required for construction of, for instance, a modern skyscraper. In 1883, William Flinders Petrie described the casing stones on the Great Pyramid as having an optician's precision, but on a scale of acres.<sup>1</sup> This is a slight exaggeration by Sir William, for the casing stones, while flat within 0.010 inch (0.254 millimeter), are certainly not optically precise. Still, the point is very well taken that the precision is not normal for stonework intended for a structure built today. The ancient Egyptians developed their tools and techniques to produce such a high order of accuracy that even the stones on the minor pyramids to the east of the Great Pyramid are cut with exacting precision and fit.

The most forceful arguments for disputing conventional views on the origins of the pyramids are thrust skyward from the desert sands as towering geometric miracles of stone. It is the engineering of the Giza Plateau that challenges historians and researchers and that has

Figure 6.2. Queen's Pyramid casing stones to the east of the Great Pyramid



attracted so many diverse views. Egyptologists admit that there is still much to learn about the pyramids of Egypt, and an air of real mystery is conveyed to the public in Egyptologists' presentations on the site. For instance, well-known Egyptologists such as Zahi Hawass, the outspoken chairman of the Supreme Council of Antiquities, and Mark Lehner, the charismatic Egyptologist with the Oriental Institute in Chicago, opened the door to the recent high level of interest in the Giza Plateau when they appeared in a 1993 documentary, *Mysteries of the Sphinx*.

Because of the tendency of engineers to focus more on engineering matters rather than on archaeology, history, or anthropology, they are often accused of stripping artifacts of their cultural context and cherry-picking the evidence. Yet as an engineer, I strongly argue that the engineering context is, in fact, a cultural context in and of itself—one that is less susceptible to ambiguity than the cultural context of mummies and potsherds, which can be added decades or even centuries after a building has been completed.

For an engineer, a visit to the Giza Plateau is a bewildering, perplexing, and thought-provoking test of education and experience. The ancient Egyptians were engineering wizards whose work never fails to impress, regardless of how many times we visit. It is also a place that, throughout its history, has fueled controversy and heated debate. At times, I have found myself at the heart of that debate because of my controversial published views on how the ancient Egyptians cut hard igneous rock. My original article "Advanced Machining in Ancient Egypt?",<sup>2</sup> published in 1984, tackled the ancient Egyptians' methods of cutting stone, but more recently my focus has been on the precision and geometry with which the stone was cut. This aspect of Egyptian craftsmanship does not receive the attention it deserves from academics, for if we are being honest, we would have to put aside theories about how the ancient Egyptians used bits of string or wood to create square corners and explain why granite boxes that were supposedly created with crude tools to house a mummy had inside surfaces that were flat and square to within a fraction of a human hair and had corner radii smaller than 0.25 inch (6.35 millimeters).



While I was in Egypt in 1995, I brought with me some gauges to inspect the flatness of artifacts that, when I saw them in 1986, had seized my attention by their exact appearance. Just looking at an artifact, however, is not good enough when attempting to determine its true characteristics. I needed some kind of known reference with which I could compare its exactness. I also needed something simple and transportable. The precision-ground straight edge I used in 1995 allowed me to determine a higher order of accuracy in many different artifacts than what has been described in any previous literature written on the subject. The flatness of the straight edge I used was true to within one tenth the thickness of a human hair, or 0.0002 inch (0.005 millimeter).

The granite blocks outside the pyramid were flat, but with a few exceptions, they did not have a polish and could not be considered as precise as the gauge. Yet the surface inside the sarcophagus in Khafre's pyramid (the second largest pyramid on the Giza Plateau) was remarkable in that sliding the gauge along it both vertically and horizontally was no different from sliding it along a modern granite precision surface plate that we might find in a machine shop or tool room. Discovering such precision was an unexpected surprise to me. I wondered why the craftsmen cut the inside surface of a sarcophagus to such great accuracy if its intended purpose was to be someone's burial place. Since I first wrote about this aspect of Egyptian craftsmanship, nobody has given me a satisfactory answer to this question. One argument presented to me was that the king was viewed as a god, and if the king wanted a flat polished surface, he could have one. This answer, however, raises a crucial question: How did the ancient king become aware of ultra-precise flat surfaces?

Despite all arguments against considering the ancient Egyptians to be more advanced than conventional wisdom believes, I was left wondering. While pondering this question, my mind went back to when I was serving an apprenticeship and had to create a small surface plate from cast iron. The exercise was supposed to teach apprentices how to use hand tools to create flat surfaces by filing, hand scraping, and lapping the surface till it was flat. The iron plate was first machined on a

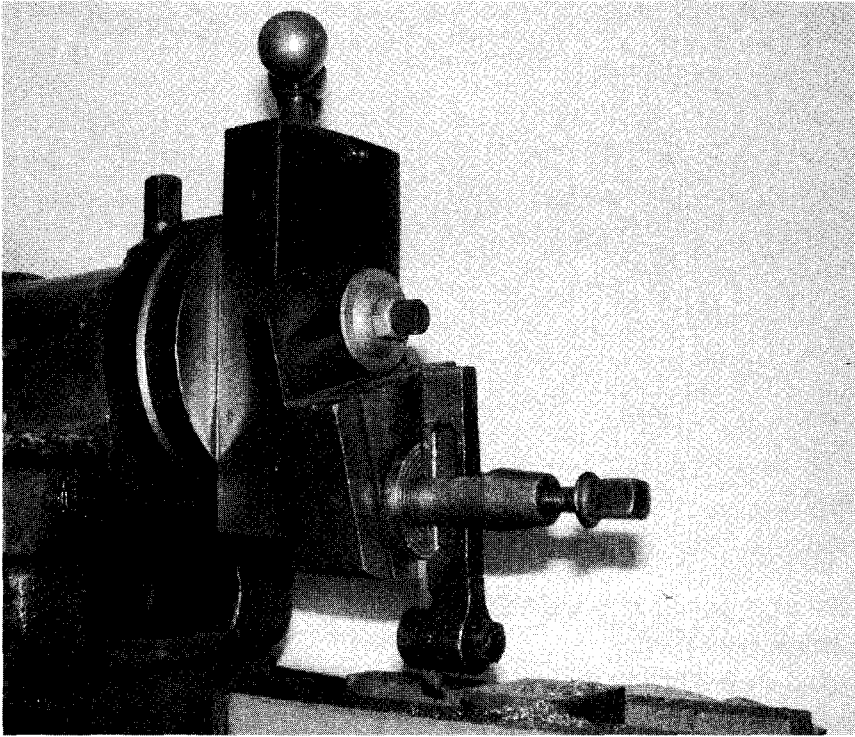

Figure 6.3. Shaper machine tool slide and clapper box. Photograph by Glenn McKechnie, September 2005.

shaping machine (a machine that is rarely seen today but was popular fifty years ago) by passing a single-point tool repeatedly over the metal to establish the basic surface.

After the plate was machined flat, we used a draw file to remove the tool marks, and then a thin layer of India blue paste was applied to the surface. A precision master straight edge (a flat iron or steel plate) was then slid across the surface in order to identify surface imperfections, or high spots. The high spots were identified where the bluing, which doesn't dry, is rubbed away on the peaks, exposing the metal. We worked down the high spots using a hand scraper, and finally, a lapping plate across the entire surface. After the plate was equally flat all over, we cut a swirl pattern (figure 6.4) into the surface using the sharp convex curved edge of the scraper (figure 6.5). This technique was used

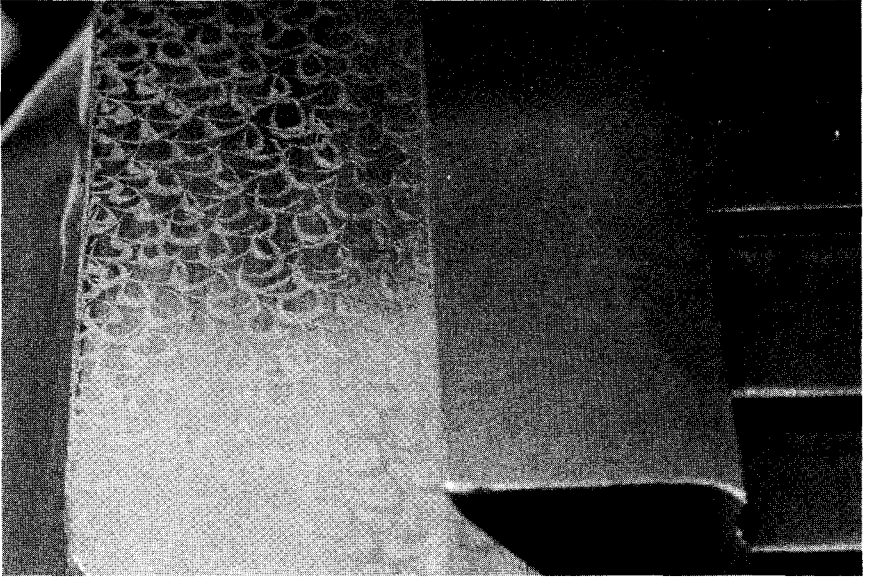

Figure 6.4. Appearance of slideway frosted for improved oil retention. Photograph by Glenn McKechnie, September 2005.

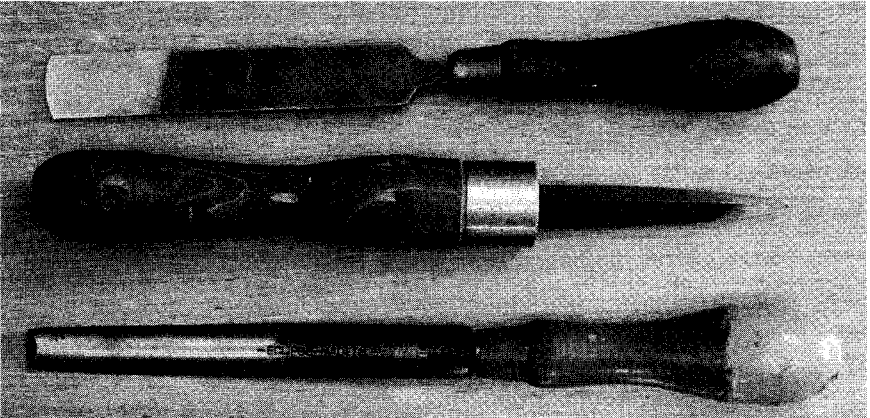

Figure 6.5. Three different engineering hand scrapers. Photograph taken by Glenn McKechnie on the 24th March 2005.

especially if the flat surface being created was a part of a machine and other components were to slide over it to retain oil in the slight depressions the scraper had made on the surface rather than have it swept away by another surface sliding against it.

A single paragraph does not begin to explain the full extent of a master scraper's craft, and certainly others may be better able to describe it. Within all trades there are particular tricks and techniques that are not obvious to an outside observer. Traditionally, these have been held close to the vest, because they were seen as job security. While helpful books have been written for an apprentice to read about his trade, his skill and understanding were gained mainly through on-the-job-training under the guidance of a journeyman or master. The life of the craftsman is echoed in the words of the famous dancer Isadora Duncan, who wrote, "What one has not experienced, one will never understand in print."<sup>3</sup>

When I was confronted in Khafre's pyramid, then, with an accurate stone artifact that was created in ancient times and found it similar to those that can be found in the inspection department of a modern manufacturing company, I was understandably shocked and excited. A surface plate (figure 6.6) is used in manufacturing as a baseline or datum from which a manufactured item, such as a sophisticated combustor for a jet engine, is measured. Before the Industrial Revolution, there was little need for flat surfaces that held to such high levels of accuracy, so

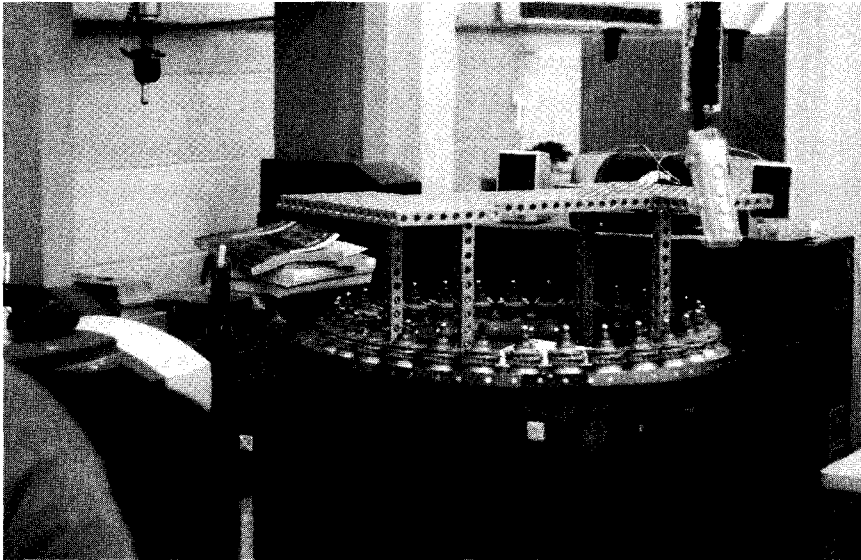

Figure 6.6. Black granite surface plate with jet engine assembly (Courtesy of Danville Metal Stamping Co.)

to find one that was crafted more than four thousand years in the past was remarkable.

In 1999, I was invited to speak at a conference held at the Tree of Life Bazaar in Nazlet el Samaan, near Giza. This was a time when interest in the Giza Plateau reached a fever pitch, and all sorts of intrigue and skullduggery was bandied about on the Internet. There seemed to be an excitement in the air and a belief that the turn of the century into the new millennium was going to bring new revelations and discoveries about our ancient origins—and many thought that Giza was where these discoveries would be made. In their book *Giza the Truth*, Chris Ogilvie-Herald and Ian Lawton coined the phrase “millennium fever” and attached it to principle researchers who had written an alternative view of the pyramids and other archaeological sites in Egypt.<sup>4</sup> The book caused some consternation among independent researchers, but it brought balance to the debate and prompted me to address some of the counter arguments in their book and to produce more and better evidence.

It was with this principle in mind that I approached both the conference and the new measurements I would be taking. I carried in my backpack a precision-ground, 12-inch straight edge: The hardened steel edge was final machined on a surface grinder, and flat on one edge to within 0.0001 inch (0.0025 millimeter). I also had a toolmaker’s solid square that was similarly accurate. I knew exactly on which artifacts I wanted to use these instruments: the inside corners of the granite boxes at the Temple of the Serapeum at Saqqara and those inside the pyramids. Also in my toolkit was a set of Starrett radius gauges for inspecting the machined radius that makes the transition from one surface or contour of an artifact to another. These instruments are critical to our understanding of the basic attributes displayed by these artifacts from antiquity.

As I noted before, on this visit in 1999, I was unable to access the rock tunnel at the Serapeum—but there was certainly enough other work to do. Following my morning presentation on the advanced machining methods of the ancient Egyptians, the entire conference

group and the film crew made their way to the Giza Plateau and into the bedrock chamber of Khafre's pyramid—the one in which, in 1995, I had inspected the flatness on the inside surfaces of the black granite box (commonly known as the sarcophagus). In 1995, I exclaimed “space-age precision” to a group of Spanish tourists who were looking on as I shone my flashlight behind the precise edge of my steel parallel and noted the stunning accuracy of the black surface. This test would have shown deviation in the flatness of the surface by revealing any amount of light seeping under the straight edge—and I could detect none except in areas where indentations occurred.

Though I wrote articles that hailed this remarkable example of precision craftsmanship as additional proof of the level of technology practiced by the pyramid builders, in the back of my mind was the nagging need to go back to Egypt with additional instruments to accomplish more tests. Every time I visit Egypt, I approach these relics of the past with eager anticipation mixed with trepidation.

The cool confines of the passageway leading to the bedrock chamber of Khafre's pyramid were a welcome relief from the burning Egyptian sun. My backpack weighed heavily on my shoulders as I joined the group and made my descent. It felt familiar and right to be there at this time. I was excited to demonstrate the remarkable abilities of the ancient Egyptians that I had noted four years earlier with the eclectic group of people who attended the conference as well as to be able to document the event on film. But still there was that tinge of doubt in the back of my mind. Had I made a mistake in the past? Will the new instruments reveal anything significant?

I climbed into the granite box, which is set into the floor of the chamber, and placed my straight edge on the inside surface of the box. The edge had been prepared differently than that of the straight edge I used in 1995: it had a chamfer on both corners, which gives the user a clearer view of any light that would pass through areas that do not conform to the precision of the straight edge. Before several witnesses, I slid this edge along the smooth interior of the granite box with my flashlight shining behind it and demonstrated its absolute flatness.

While I was doing this, though, I was anxious to perform other tests. The square corners were of critical importance to me. Modern machine axes are aligned orthogonally, or exactly perpendicular, to each other to insure accuracy—and to assure that the corners a machine cuts into an object are square and true.

The requirements for producing such accuracy go beyond coincidental simplicity. I wasn't expecting the corners of the sarcophagus to be perfectly square, for perfection is extremely difficult to achieve and to find it in an ancient artifact that was supposed to serve as a coffin would be a miracle. Yet I was not prepared for what I found: I was astonished as I slid my square along the top of the parallel (I used the top of the parallel to raise the square above the corner radius) and found it fit perfectly on the adjacent surface. The significance of the find came over me, and I pointed it out to others in the group. The film crew was busy capturing it on video as I went to each corner and performed the same test. On three corners, the square sat flush against both surfaces. The fourth corner had a gap that was detected by the light test, though its variance from being a true square may have been no more than 0.002 inch (0.0254 millimeter) (see plate 13).

What does this tell us about the methods used to create this box? The implications of my previous question about why the builders found it necessary to create a coffin with perfectly flat inside surfaces had just

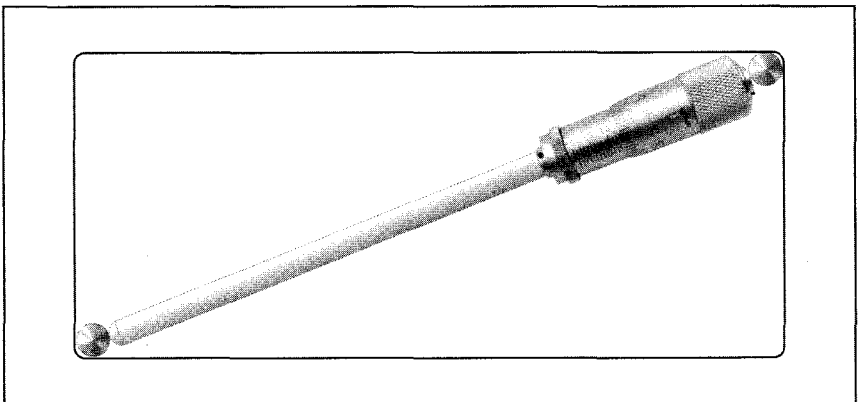

Figure 6.7. Using an inside micrometer to measure between corners inside a box

been raised exponentially. Why go to extreme trouble to create a box with perfectly flat inside surfaces as well as go to extraordinary lengths to make sure the inside corners are square—to within a tolerance normally expected of modern machinists and toolmakers?

In order to create a box with square corners, there has to be some way to measure them. The layperson who knows the ways of a carpenter may create square corners by measuring from corner to corner and making sure the distance is equal, but a solid granite box crafted to such exact specifications is a different class of work from that of cabinet making or squaring a structural frame.

There could be no adjusting Khafre's granite box after the insides were finished to achieve perpendicularity. The only adjustment would be to lap the entire surface again and have a means to take measurements all along. To imagine creating this without orthogonal machine axes to guide a cutting tool is to imagine a task that borders on the impossible—or at least the hugely improbable considering the box's stated purpose is a coffin.

Nonetheless, the diagonal measurement method could be used to verify what was already achieved using controlled mechanical axes, but we would need specialized equipment to do it. Before the introduction of laser metrology instruments, we might have employed two perfectly round bars in which the radius of the diameter is larger than the box's corner radii. With them touching the adjacent flat surfaces, a means of measuring between the bars would be employed. Before the introduction of laser metrology instruments, we would have used a precision inside micrometer as seen in figure 6.7.

The method shown, however, only provides information at one point in the cavity, and the box in Khafre's pyramid, as measured by Petrie, is 29.95 inches (76.073 centimeters) deep. In order to have a complete and accurate measure of the square corner down to the bottom of the box, there must be many measurements taken using this method.<sup>5</sup> Moreover, a precision square would still need to be employed to assure that the adjacent surfaces were square and flat with the tangency point of the corner radius.



6 *OBJECTS AND METHODS*

and to put aside Western reserve, and treat them with the same familiarity to which they are accustomed between different classes. With such intercourse I have found them a cheerful, warm-hearted, and confiding people.

The list of instruments employed was as follows:—

A*	Standard scale, steel	100 inches long, divided to 1 inch.	
B*	Steel tape	1,200 "	50 "
C	Steel chain	1,000 "	20 "
D	Pine poles, a pair 1 inch diameter	140 "	10 "
E*	Pine rods, a pair 1 × 2 inches	100 "	1 "
F*	Pine rods, 10 of ½ × 1 "	60 "	1 "
	(Joining together into two lengths of 250 "	each.)	
G*	Pine rods } 3 of ½ × 2 inches	60 "	1 "
	for levelling } 2 " × 1 "	60 "	1 "
H*	Pine rods, 2 " × 1 in. 40 & 20	"	1 "
J	Box on mahogany rods, 2 of 1 × 1 25	"	12 "
K	Boxwood scale, 1 25 × 13 12	"	2 ½ "
L	Steel scale, 1 07 × 04 12	"	1 0 "
M*	Ivory scales, 2 of 1 18 × 08 10	"	1 0 "
N*	Boxwood scale, 1 18 × 08 10	"	2 0 "
O*	Gun metal scale, 1 00 × 09 6	"	1 0 "
P*	Ivory scale, 1 0 × 08 1	"	1 0 ½ "
	(The divisions of those marked * are all known to within 1/1000 inch.)		
Q	Double calipers, 72 inches long.		
R	Supports for catenary measurement by tape and chain.		
S	10 thermometers for scale temperatures.		
a	Theodolite } 10 inch circle, divisions 5, vernier 3"	} telescope × 35.	
	by Gambay } 7 inch circle, " 10, " 10"		
b	Theodolite } 5 inch circle, " 30, " 1"	} telescope × 6.	
	by King } 5 semicircle, " 30, " 1"		
c	Theodolite } 4 inch circle, " 30, " 1"	} telescope × 8.	
	by Troughton } 4 semicircle, " 30, " 1"		
d	Box sextant } 1.64 inch radius, division 30, vernier 1"		
	by Troughton }		
e	Hand level in brass case.		
f	Gun metal protractor, by Troughton, 59 diam, divisions 30.		
g	Mahogany goniometer, 11 and 9 inch limbs.		
h	Queen's chamber air channel goniometer.		
j	Sheet steel square, 35 and 45 inches in the sides. //		
k	Folding wooden tripod stand, old pattern.		
l	Rigid tripod stand, 30 inches high, octahedral.		
m	Rigid tripod stand, 16 "		
n	Rigid iron tripod, 12 "		
o	12 signals, with plumb bobs.		

Figure 6.8. List of Petrie's measuring instruments

Petrie did not address the square corners of the boxes when he performed his measurements. However, he did perform a detailed study of the inside and the outside of the box with a range of instruments—detailed in figure 6.8—that were quite sophisticated for his time and crafted by the finest engineers.

Not only, then, do we have an artifact with flat surfaces that are similar to a modern surface plate, we have one with inside corners similar to what we would find with a toolmakers square on a surface plate with the blade touching an angle plate (see figure 6.9). With the question of the orthogonal exactness now raised, along with one hundred and twenty years of advances in technology, any engineer, including Petrie himself if he were alive, would insist that the box in Khafre's pyramid be measured again using the latest metrology instruments

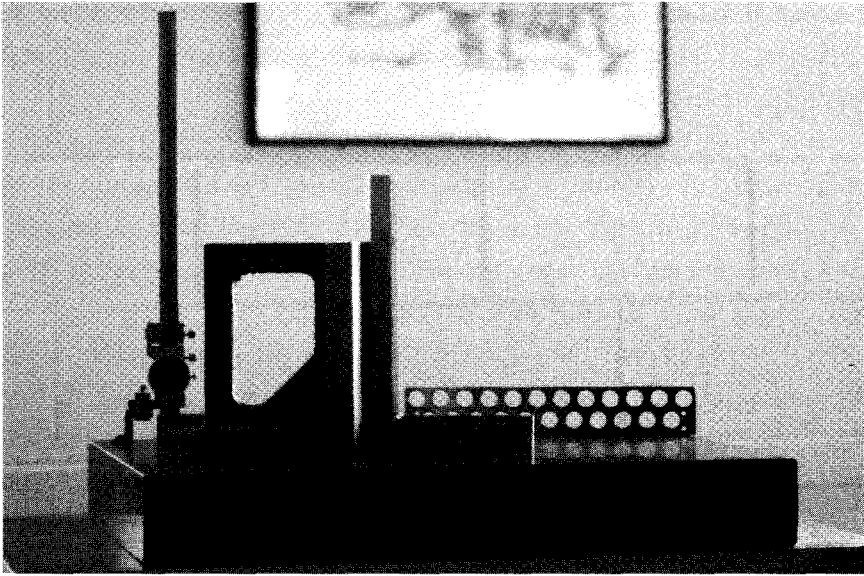

Figure 6.9. A surface plate, angle plate, and a precision square

available. Petrie wrote about tolerable safe theories in his final chapter: “. . . others may by some further discovery be shown to have been intended, but most of these will probably bear the test of time, and certainly bear the test of exact measurement.”<sup>6</sup>

If we were to inspect this box today, at the very least the inside measurements of the width and lengths should be taken with inside micrometers—or, preferably, special rods equipped with dial indicators. The examination could be performed, preferably, by an Egyptian engineer or an Egyptian architect. Even a layperson could perform these checks after receiving some training, as the level of skill necessary to use these instruments is not as difficult to attain as for the instruments Petrie was using—and the result would be more reliable.

What else is significant about this so-called sarcophagus? The corners themselves! After conducting the test with the parallel and the square in May, I pulled out my radius gauges to check the corner radius and thought about a documentary I had seen in March. In the 1999 Fox special *Opening of the Lost Tomb*, a dolerite ball was shown to the audience under one of the satellite pyramids next to Khephren’s pyramid and

asserted to be the means by which the ancient Egyptians created granite artifacts. This method involved bashing the granite with a round ball until the desired shape was achieved.

I'm not disputing that this is a viable means of creating a box, and, indeed, there is evidence at Memphis near Saqqara that some boxes were created in this manner (see figure 6.10). This box has large corner radii and is extremely rough and tapered toward the bottom—exactly what you would expect to produce using a stone ball.

Likewise, it would be impossible to create the corner radius of the box inside Khafre's pyramid with such a primitive method. While inspecting the inside of the granite box in Khafre's pyramid I checked the corner radius with my radius gauges. I started with a half-inch radius gauge and kept working my way down in size until I selected the correct one. The inside corner radius of the box inside Khafre's pyramid revealed a 0.09375-inch (1.009-millimeter) radius. There is, however, a rise in the material toward this radius and a cusp where another rise, presumably from the tool that cut the adjacent surface, meets the corner. The radius at the bottom, where the floor of the box met the wall, had an approximately 0.4375-inch (11.125-millimeter) radius. Clearly, an 8-inch ball will not fit into a corner with a radius this size or even one five times larger.

So what kind of tool may have been used to cut the inside corners of these boxes? In 2001, I was able to take wax impressions of the south-



Figure 6.10. Granite box at Memphis (Photograph courtesy of Stephen Mehler)

west corner inside the box. Figure 6.11 shows that the corner reveals the geometry of the tool and may lead us to determine the method of manufacture. While other engineers may provide their own ideas to the puzzle, one possible reason for the corner profile is not uncommon in machining today. A grinding wheel may start out cutting a surface with a sharply defined radius on its edge. Through use, over time the corners become worn and the wear will appear as a taper from the edge. It appears that the cutting tool used to finish the inside of the box in Khafre's pyramid became worn, and we are left to study its profile on the inside corner of the box where the tool cut the north to south surface and then the east to west surface, leaving a cusp there the shape of the tool overlapped.

It is an incredible piece of work that speaks of a higher technology in its creation and perhaps even in its use. Even if we put aside the question of how it was manufactured, it still shouts the question: For what non-technological purpose might it be necessary to have such precision and accuracy? If we understand what it takes to perform such work, we are left with no alternative but to acknowledge a high level of technological prowess on the part of the ancient Egyptians.

Artifacts such as these fly in the face of any previous explanations

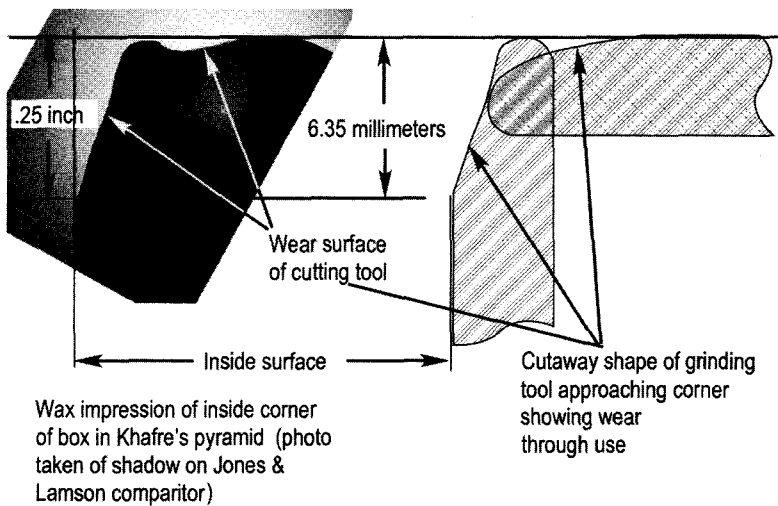

Figure 6.11. Wax impression of the inside corner

of the ancient Egyptians' stonecutting methods. Egyptologists are now abandoning their previous assertions that these marvelous granite artifacts were cut using copper chisels. Moreover, though Denys Stocks and Mark Lehner have recently demonstrated how the ancient Egyptians may have cut granite using primitive methods,<sup>7</sup> these demonstrations do not come close to explaining the remarkable exactness, geometry, and tool marks cut into the stones found on the Giza Plateau and at other sites in Egypt.

As we wander around the Giza Plateau, we find this precision in the most unlikely places. For instance, a single diorite block in the southeastern wall of the Valley Temple duplicates the accuracy found on the inside of Khafre's pyramid box. In the Valley Temple there are several places where the inside corners comprise blocks that wrap around to create a part of the adjacent wall. This suggests that the blocks were positioned and then the inside walls were cut to specific dimensions. The diorite block is the finest example of precision, but there are sections of the granite pillars that are similarly precise, perhaps due to

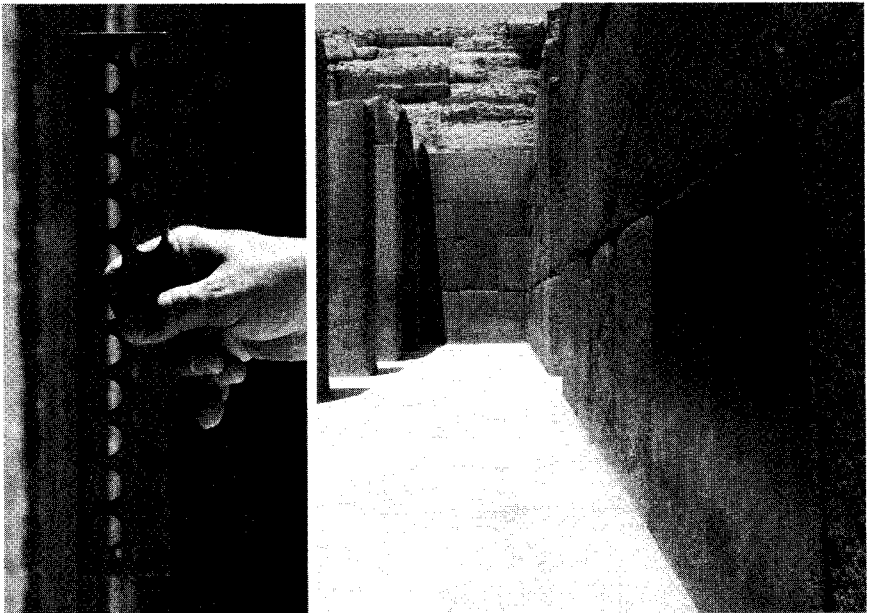

Figure 6.12. Valley Temple diorite wall block

being buried in sand and protected from wind erosion, unlike much of the rest of the granite.

Though there is now no doubt that accuracy and symmetry were part and parcel of the ancient Egyptians' manufacturing and building scheme, there is a vast difference between a simple, precise flat surface and the complex geometry of a symmetrical Egyptian statue. As viewed orthogonally along a specific axis, we have an impression of precision, but examining a three-dimensional object with a two-dimensional photograph does not provide complete information: though it looks as if the right side of Ramses' head is precisely mirrored on the left side, there are myriad points on the surface of each side that must be inspected to determine exactly how similar they are. The outline of the major features provides us with sufficient information to allow us to see just this, and we can hope this work will be performed in the future, preferably by experts in the field of metrology using 3-D photography and computer analysis.

Fortunately, I have inspected less complex surfaces that were created using the same geometric protocol of describing simple tangent circles. Yet instead of the tangent circles morphing into different shapes, as in face of Ramses or the wire frame that binds the geometry to create the surface and tool path of MadCam's head (see plate 11), these tangent circles are projected along a precise axis that can be measured.

In 1995, I inspected a block on the Giza Plateau that caught my attention because of its smooth surface and what appeared to be machined corners and a rounded surface. I presented my findings in my book *The Giza Power Plant*. As time and technology progressed, I found myself examining the block again each time I returned to Egypt. On some occasions, I invited witnesses to examine the block with me. In February 2006, I invited John Anthony West. In May 2006 I was accompanied by Judd Peck, whereas Arlan Andrews and Randy Ashton joined Judd and me in November 2008.

John West is very good at reaching the heart of an issue using simple analogies. In summarizing the evidence of precision at Giza, he said, "It's like finding a Porsche where only a wheelbarrow should be."

This is a great analogy! To discover precision normally found only on modern artifacts in artifacts from a period of time when the wheel was not supposed to have existed raises eyebrows, many questions, and an overarching sense that such accuracy was the result of a period of technological development of tools that were capable of nothing less.

In 2004, I walked with Stephen Mehler, author of *Land of Osiris* and *From Light into Darkness*, across the plateau to show him the block I had described in my book when he turned in the wrong direction. The block I had written about was about one hundred yards east of the southeast corner of Khafre's pyramid, but Stephen was heading down to the Valley Temple. As it turned out, on a previous trip to Egypt, he had looked for the block that I described in my book and had mistakenly identified another block south of the Valley Temple. Because I had not yet seen the block Stephen had found, we headed down the causeway toward the Sphinx and the block.

I was curious to see this example of ancient Egyptian stonework, and my curiosity was rewarded: it provides an excellent example of what could be described as an evolutionary step from a simple flat surface to the more complex geometries of ancient Egyptian statuary. In other words, if we consider a flat surface as the projection of a flat vertical line along a horizontal line, then the block on the south side of the Valley Temple is the projection of a profile composed of tangent radii and straight lines along a perpendicular horizontal line.

What is remarkable and important about the Valley Temple contoured block is that it shows that the ancient Egyptians crafted not only flat surfaces, but also contoured surfaces, with uncommon precision. As any engineer can tell you, a customer's specifications regarding the accuracy of their product will determine its final cost. When considering the significance of this contoured block, therefore, we must keep in mind that it was obviously an architectural element that at one time was positioned on the top of a wall—beyond the close examination of passersby. If the contour varied slightly from its path, it would not be noticed, nor would it affect the purpose it served.

There is an even greater mystery to this forgotten piece of Egyptian



Figure 6.13. Granite block outside the Valley Temple

architecture. If we discount the smaller piece nearby as originally a part of the piece we are studying, there is only one piece that has survived. If the entire wall of the temple was capped by dozens of these elements (see figure 6.14) that weigh approximately 17 tons each, where did the rest of them go? It seems that more of them would have survived if such a large number of pieces had been manufactured. A clue that provides a possible answer to this question comes from an unlikely place.

Sliding the 12-inch straight edge along the crown of the convex radius there, I could not detect any variation, which would be revealed by light showing through the straight edge's interface with the stone. At several locations around the arc I repeated the inspection with the gauge coaxial with the centerline of the radius and found remarkable consistency.

From a photograph taken of the end of the cornice, we discovered that the ancient Egyptians applied the geometry of tangent circles in building three-dimensional form (see figure 6.16, p. 159). I tried to detect a



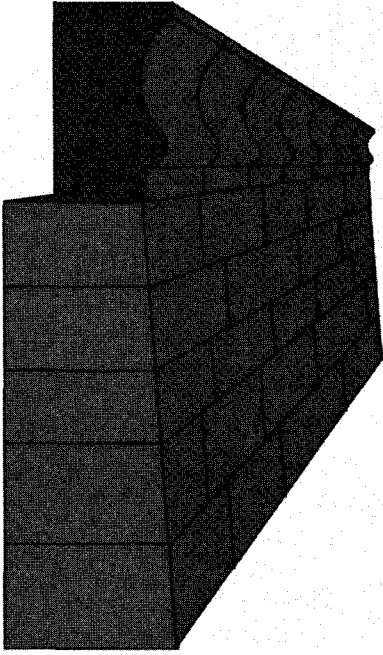
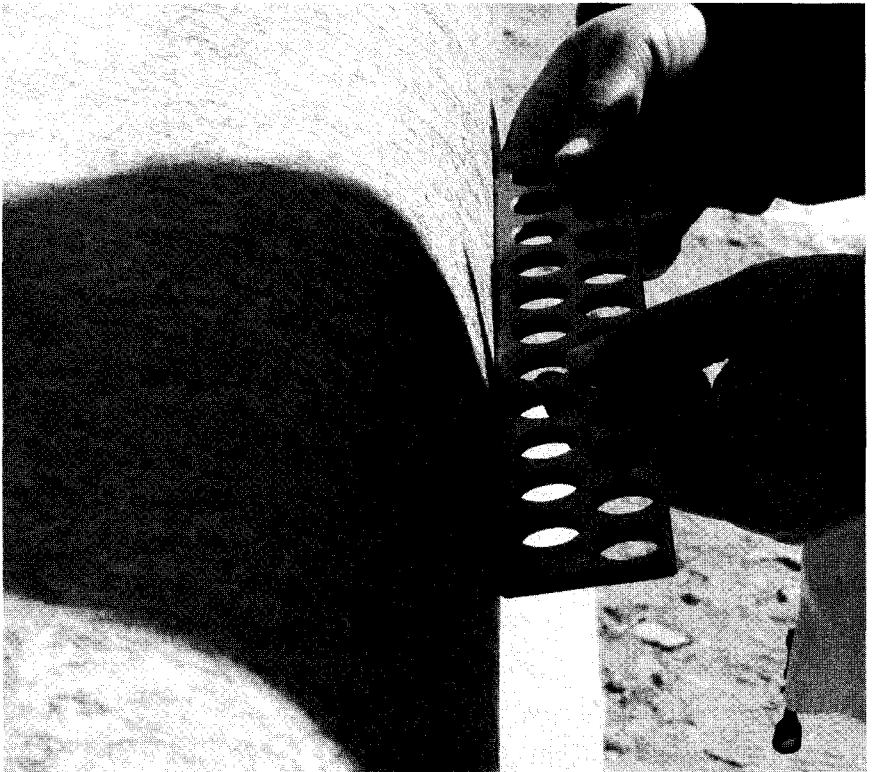

Figure 6.14. Cornice on top of Valley Temple wall

Figure 6.15. Inspecting the accuracy of the cornice



variation in the smoothness of the transition between the large concave radius and the small convex radius, but I could detect nothing but perfection of form. There are no ripples on the surface. There are no ridges or bumps or depressions. The precision and geometry of the piece cause it to stand apart from many other artifacts lying around it. It surpasses the columns and wall blocks that make up the construction of the temple, and I cannot help but wonder what important purpose it served.

Because the block was broken off at the end on an angle, the large circle (see figure 6.16) does not fit close to the end. It should also be noted, that the large circle is approximate, given the unevenness of the end. The radius at the far end, however, represents with reasonable accuracy the concave arc that begins at the bottom and ends tangent to the top convex radius. With this information, we can be reasonably certain, especially following what we have learned of the design protocol on the statues and crowns, that the piece was crafted to conform to exactness using true arcs as the design elements.

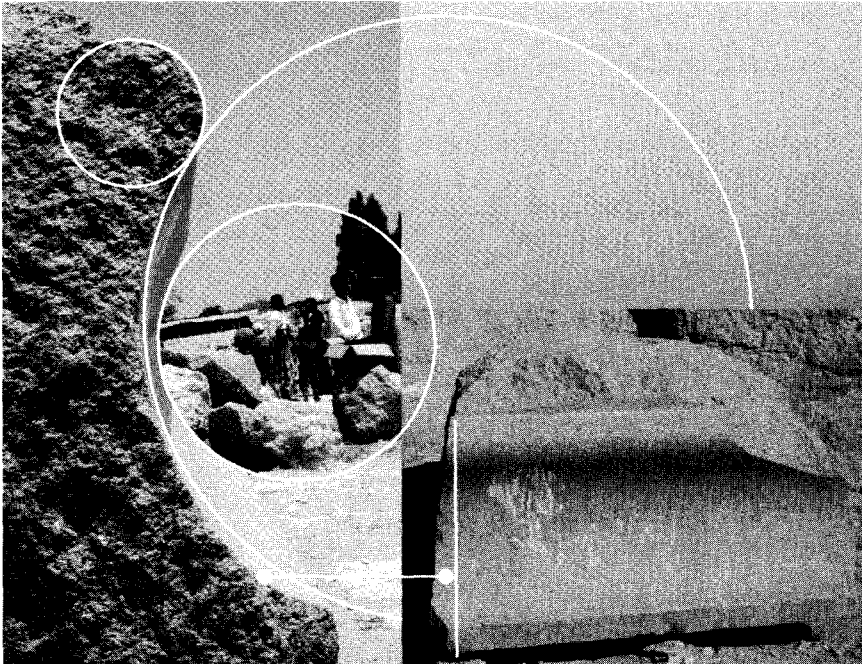

Figure 6.16. Cornice geometry

But, the question still remains: Why go to such trouble for an architectural detail that goes into a building? From a distant epoch in time, it would not be surprising to find a cornice that had been bush hammered and then given a polish without regard to a high level of precision. But to discover not only strict constraints in the design, but also the adherence to machinelike precision on a granite block that is destined merely to look elegant and attractive provides more evidence in the emerging picture of lost technology in ancient Egypt.

The answer to the mystery of how the Valley Temple cornice block may have been used may be at the place where Stephen Mehler and I were heading before he diverted my attention. I described this granite block as being similar to a couch. In 2008, while I was on the Giza Plateau with Judd Peck, Arlan Andrews, and Randy Ashton, we walked over to the block and found it being used for just that purpose by a young Egyptian woman and her boyfriend.

This piece of granite has all the hallmarks of machining. Cut into

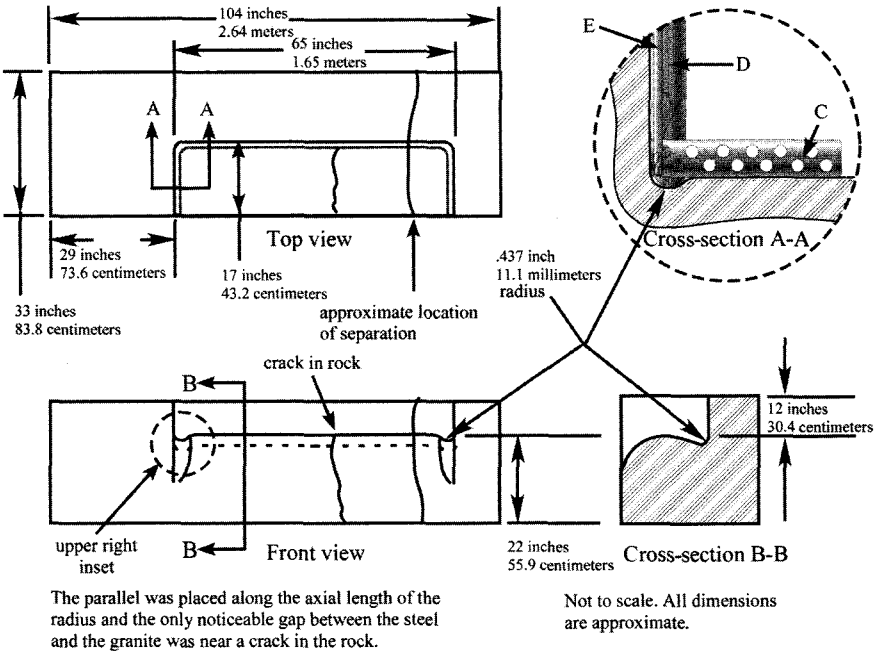

Figure 6.17. Design of Giza granite "couch"

the piece are characteristics that experienced machinists and designers use to allow a more rigid, stronger tool to be used to machine it. But, you may say, there were no machines in ancient Egypt! Why, then, would these features exist? We could say that there have been no machines found in the archaeological record that we can argue were responsible for this kind of work. This presents a bit of a conundrum, for there are no tools whatsoever in the ancient Egyptians' toolbox that can be used to replicate what has been crafted in igneous rock, and which imposes its majesty on our consciousness. But before we begin discussing what tools might have been responsible for cutting Egyptian stone in antiquity, let us take a look at what is machinelike about this block.

From a manufacturing perspective, this piece would be more difficult to manufacture than the cornice. The cornice has a simple contour that is projected along a precise path without interruption. The "couch" has three vertical walls that I call *arms* and *back* with a transitional and true 0.4375-inch (11.112-millimeter) tangent "blend" radius between the profile of the seat and the vertical arms and back that is consistent by comparative measure all around. The comparative measure was made from forming wax that was pressed into the radius and then checked in several places along the arm and back (see figure 6.18).

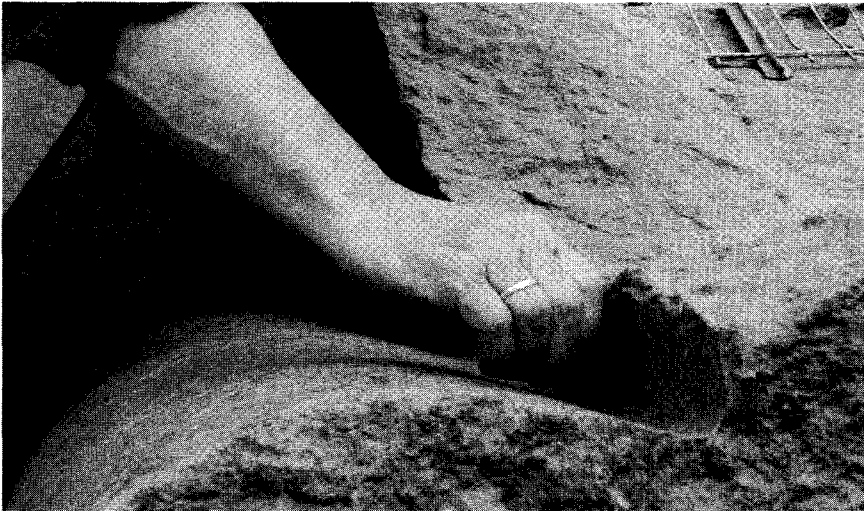

Figure 6.18. Checking the corner radius (Photograph courtesy of Dan Hamilton, 2004)

The seat of the “couch” comprises tangent radii that flow down to the front with no discernible variation, ripple, dips, bumps, or ridges. The quality and precision of the piece are the same as on the cornice near the Valley Temple. The only drift from perfection is a crack that runs perpendicular to the length. The radii are expressed in figure 6.19

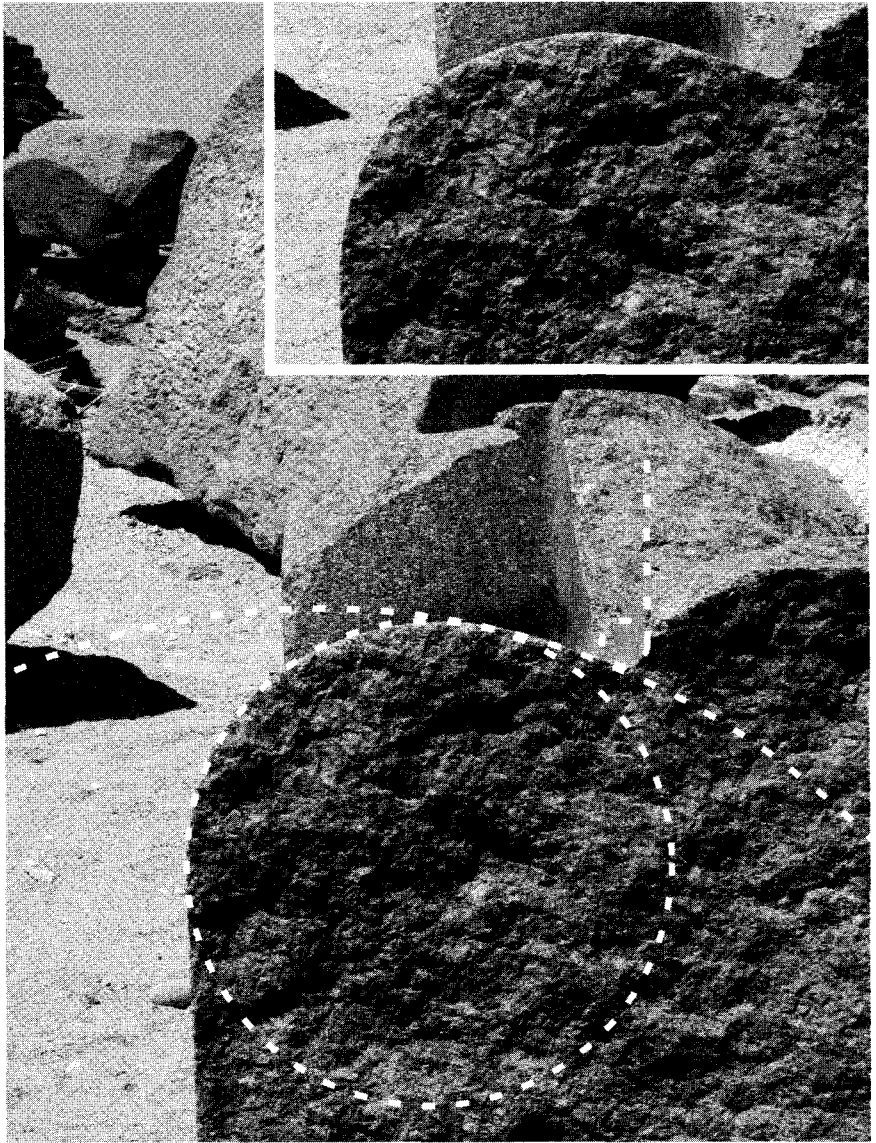

Figure 6.19. Radial components of the “couch”

as three circles. There are slight variations in this view because of the unevenness of the broken ends. The inset shows the end view without the drafted overlay.

I inspected the seat by holding the straight edge at several locations along its length and around the contour. There was no variation in the accuracy of the contour along the length of the seat (or the radii's axes).

We can clearly see the machinist-friendly feature of the couch in the corner of figure 6.20—the radius relief in the corner. This technique is commonly used by designers who wish to have a corner that has strength and also allows for the use of a larger, instead of a weaker, tool in machining. In view A-A in figure 6.17, we see the difference. Using a tool the diameter of D instead of E along with a relief cut into the seat allows straightedge C to fit closer to the *arm*.

The contoured block on the Giza Plateau is an extraordinary piece.

Figure 6.20. Inspecting the accuracy of the seat

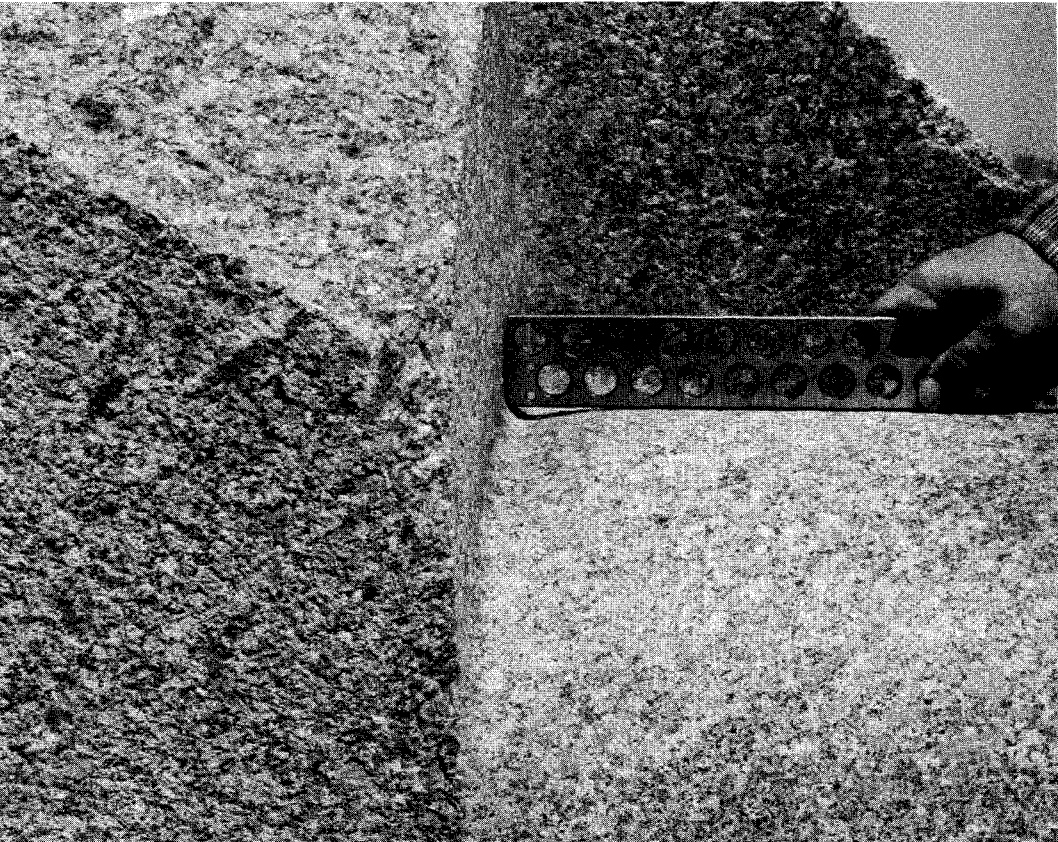

Because of its design, it suggests that it was made so that another component would fit against it—but I have no idea what that other component could be and what it would do. Perhaps it too, like the cornice, was merely another architectural element that had been broken out of its original place and has been lying out in the open on the plateau for millennia.

In 2006, while traversing the plateau to the east of the Great Pyramid, I came across an unusual doorway that sparked a connection in my mind to what I had written about in *The Giza Power Plant* and what I have puzzled over for years. The cornice block on the south side of the Valley Temple had diverted my attention from the block I was taking Stephen Mehler to see, but with this new evidence, a case for a connection between the Valley Temple cornice and the contoured block on the plateau started to emerge.

My focus in this book is the evidence of engineering and engineering symbolism behind ancient Egyptian artifacts. As we have seen, there is symbolism behind their design and use of sacred geometry, such as the Pythagorean triangle, the Golden Ratio, and the Fibonacci spiral. To the ancient Egyptians, doors held a special symbolism. They even went so far as to create false doors in their buildings that had all the architectural elements of a door except a functional opening. When I saw this door, then, I naturally wondered about the purpose or symbolism behind the round-shaped lintel. To include it in the design of a doorway took a great deal of extra effort—and what purpose did it serve? The doorway into the temple at Saqqara has a similar inexplicable design that elicits all manner of speculation. There, the stone is cut to resemble a series of round beams spanning the temple entrance. Throughout the Saqqara temple complex, symbolism has not taken a backseat. The complex is replete with unusual and perplexing architectural details that give us the feeling that while the Egyptians were engineering, they were thinking about the inexplicable mysteries of the universe.

These ancient doors, however, suggest a use for both the cornice and the contoured block on the Giza Plateau. In figure 6.23, we can see that the two complement each other very well. They also provide us

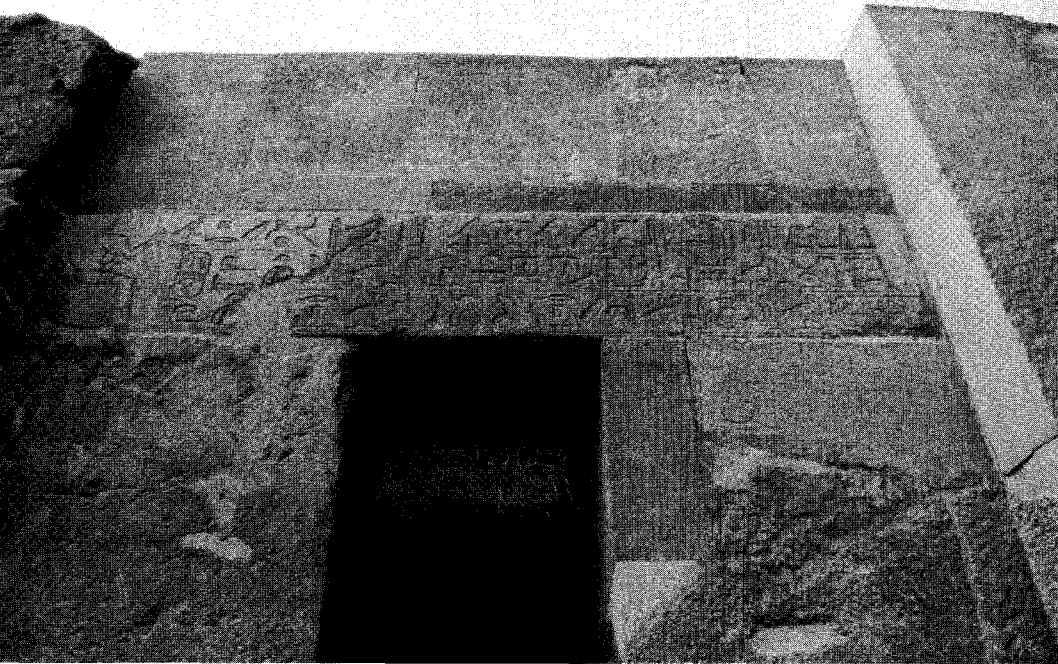
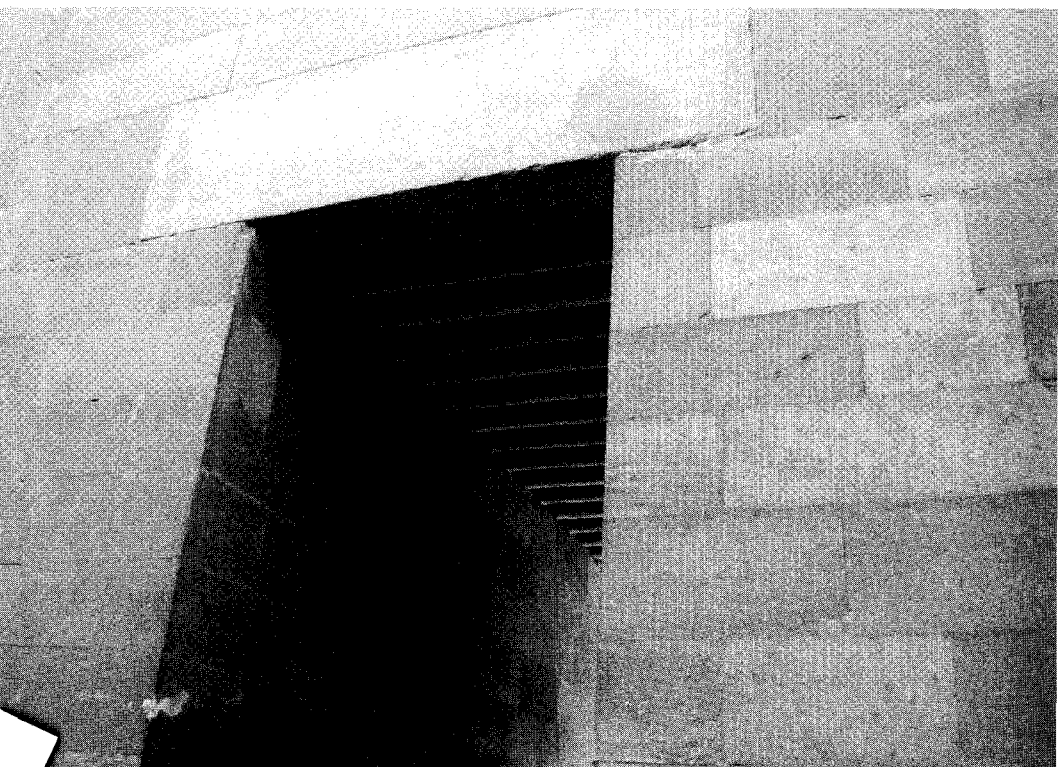

Figure 6.21. Doorway east of the Great Pyramid

Figure 6.22. Doorway to the Temple at Saqarra





with a reason why there are not dozens of granite cornices outside the Valley Temple. Quite simply, the Valley Temple may not have had cornices on top of its walls, but it had one in a position of prominence over an important gateway or doorway. What remains a mystery, however, is this: if the lintel and the cornice were at one time used on the same

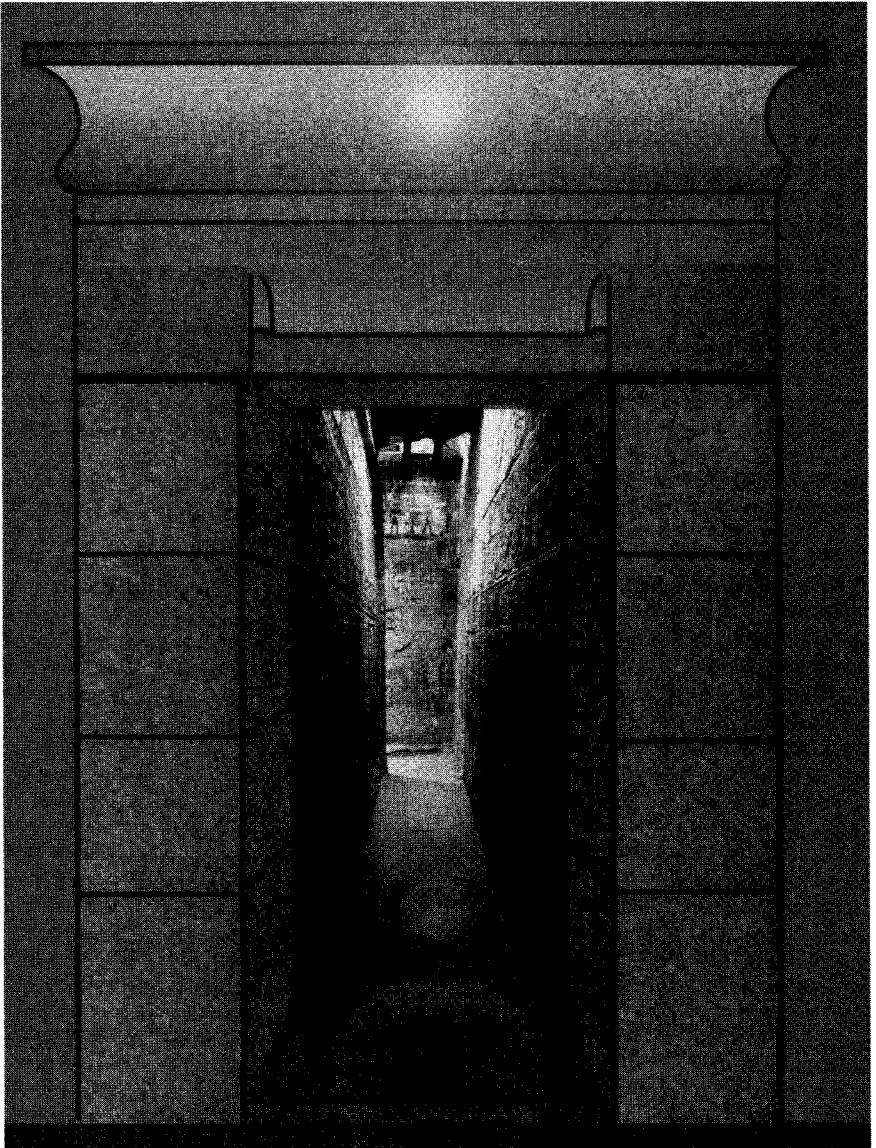

Figure 6.23. The mysteries that may lie beyond a door

doorway, how did they arrive at their current locations, several hundred yards or meters apart?

Now that we have discerned the possible architectural perfection in the doorway, we must travel through it to Upper Egypt, where the cornice is in elevated abundance and glorified by a brilliant execution of design. We must next go to Denderah, where the precision of a Rolls Royce might come to mind. Denderah is a finely crafted jewel in the desert. Though tattered and worn from the ravages of time, the Great Hypostyle Hall's rough edges recede after a few hours of study, and the consummate intelligence of Egypt's architects, engineers, and artisans comes to life.

7

# The Shadows of Denderah

*No man can reveal to you aught but that which already  
lies half asleep in the dawning of your knowledge.*

KAHLIL GIBRAN, *THE PROPHET ON TEACHING*



Figure 7.1. The Temple of the goddess Hathor at Denderah

The record of precision found at the Temple of Amun Mut Khonsu in Luxor was a surprising discovery, because I did not expect to find the same level of precision that I found in and around the pyramids, which I viewed as being more mechanical than the temples in both geometric appearance and functionality. It was inspiring to learn that the temples in Upper Egypt were crafted using an application of manufacturing exactness that rivaled the pyramids—and that reinforces the importance of the temple in the ancient Egyptian culture.

Cathedrals, churches, synagogues, mosques, and temples are functional structures. Though built as a tribute to a culture's god or gods, most places of worship are constructed to reflect the highest ideals and skills that humans have reached at that time. Some may argue that in today's world, those ideals have declined, if we judge by the architecture and building materials that are used in modern buildings and compare them to those used for the monolithic and grand architecture of our ancestors. The temple in ancient Egypt was a functional construction that was probably more a part of the ancient Egyptians' life than the pyramids. It was a place for the public to interact with its gods, to experience the energies of the holy of holies, and to become rejuvenated within a structure that people knew had an important message for them on many levels. They interacted with the temple both consciously and subconsciously. Perhaps not knowing all of its mysteries, but gaining insights into a reality that was cosmic in proportion, their minds and consciousness were expanded to embrace their surroundings, as the temple embraced them.

From Luxor, Judd and I traveled to the temples of Abydos and Denderah. Because we were not a part of a tour group, we hired a taxi and became part of a convoy that left Luxor at 8:00 a.m. sharp. It was an interesting transaction. We were approached by a man near the Sheraton Hotel who gave us a card that had a nice-looking photo of a Mercedes on the front with his photograph and phone number. I asked him how much he would charge to travel to Denderah. He then showed me his car, which was a Peugeot station wagon in good condition. Not a Mercedes, I thought, but okay. We hired him for

the trip. He picked us up in the morning in a beat-up older Peugeot and promptly drove to his brother's house, got him out of bed, and turned the responsibility of driving over to him. His brother, Hamde, not quite as polished and smooth as Ahmed, rushed out of his house, pulling his galabeya over his head, and drove like a madman to connect with the convoy.

In this land known for its enigma and wonder, a helter-skelter taxi ride at the tail end of a convoy of tourist buses dispels all romantic notions of the past. Twenty-first-century Egypt flies by with all the clatter and confusion of the modern world. We were heading sixty kilometers north of Luxor to the provincial city of Qena. Though security is one reason tourists are convoyed with armed policemen to these ancient temples, a more pressing concern is to move large masses of people efficiently, in accordance with a very tightly controlled schedule.

Though we visitors may sit back and feel special about the extraordinary measures that are taken to ensure that we have a fast, comfortable, and safe passage along these stretches of road, during our journey, it soon became quite clear why side roads are closed and armed guards are posted at the intersections. The taxi in which we were traveling had to stop for gas, and during the refueling period, the entire convoy passed and the side roads had opened up, spilling all manner of chaos into our path. Fortunately, a Nissan police vehicle held back for us and shepherded us through the bedlam with its siren and honking horn and with a driver whose sharp words showed no respect for man or beast. Without doubt, a journey that usually takes one to one and a half hours would have been increased exponentially under these chaotic conditions if we didn't have someone clearing our way.

Our destination was one of the most enigmatic sites in all of Egypt: the Temple of Hathor at Denderah. In ancient times it was known as the Castle of the Sistrum. It was so named after the sistrums (ancient Egyptian percussion instruments or hand-held rattles) carved



intricately in relief on the walls and, more strikingly, those atop the faces of Hathor that form the capitals of the columns, which soar to a height of 50 feet (15.24 meters) in the Great Hypostyle Hall. The temple is also known as Per Hathor (*Per* being an ancient Egyptian word to describe “house of”), the House of Hathor, or the Domain of Hathor. Throughout Egypt’s dynasties, it was said to have been a place of pilgrimage and worship, but after the ruin of the pharaonic way, Denderah was abandoned and left to the encroachment of wind-blown sand that piled high outside the temple and inside the Great Hypostyle Hall. For more than a thousand years—until the middle of the nineteenth century—Hathor’s temple remained inundated by the desert.

Like other temples of the Nile, the Temple of Hathor has a long history and has been modified or rebuilt a number of times. Some of its architecture dates to the Ptolemaic and Roman period during the first century BCE. On a rear external wall relief are depicted Cleopatra and her son Ptolemy XV, Philopator Philometor Caesar, who was fathered by Julius Caesar. The Romans constructed a birth house next to the entrance, and the Coptic Christians erected a church.

During the New Kingdom (1550–1070 BCE) Thutmose III, Amenhotep III, and Ramses II and III are believed to have added to the structure. There is also an older birth house and an eleventh-dynasty chapel dedicated to King Nebhepetre Mentuhotep II, but there is reason to suspect that its original foundation dates back to a remote period of time. Inscriptions on the present structure refer to the work of earlier builders. The oldest construction activities occurred in the time of the Old Kingdom (2650–2134), during the reign of Pepi I (2321–2287) and Khufu (2589–2566).

All these additions, however, pale in comparison to the breathtaking magnificence of the temple itself. It is difficult to describe, because it was specifically designed to convey, through profound experience, incredibly important information. The eighteenth-century writer Amelia Edwards, with elevated prose, attempts to match its superlative attributes:

The immense girth of the columns, the huge screens which connect them, the ponderous cornice jutting overhead, confuse the imagination, and in the absence of given measurements appear, perhaps, even more enormous than they are. Looking up to the architrave, we see a kind of Egyptian Panathenaic procession of carven priests and warriors, some with standards and some with musical instruments. The winged globe, depicted upon a gigantic scale in the curve of the cornice, seems to hover above the central doorway. Hieroglyphs, emblems, strange forms of kings and gods, cover every foot of wall space, frieze and pillar. Nor does this wealth of surface-sculpture tend in any way to diminish the general effect of size. It would seem, on the contrary, as if complex decoration were in this instance the natural complement to simplicity of form. Every group, every inscription, appears to be necessary and in its place; an essential part of the building it helps to adorn.<sup>1</sup>

In 1898, Sir William Flinders Petrie excavated a section of the cemetery behind the temple enclosure for the Egypt Exploration Fund and discovered burials dating from the fourth dynasty onward, including burial tombs, called *mastabas*, from the sixth to the eleventh dynasties. Petrie first traveled to Egypt in 1880 and returned in 1883. In the early 1890s, Petrie became interested in predynastic times and how Egypt formed its civilization, and he returned a third time in 1893. He believed that people of Punt were the progenitors of Egyptian civilization and began excavations in Coptos. Although he did not find any evidence to support his theory, he did find a large cemetery where the deceased were not mummified and were buried in the fetal position. Petrie also discovered cemeteries like this, first in Abydos and then in Denderah, the ancient capital of the sixth Nome.

On the ceiling in the Great Hypostyle Hall, ancient blue paint, with its muted brilliance, competes for attention beneath the black, sooty residue of ancient fires. The ceiling is divided into seven sections, and finely carved reliefs occupy the architraves depicting the astrological signs of the zodiac encircled by the slender form of Nut,



the goddess of the heavens. In the western architrave, along with Nut, is the god Geb, representing the earth, and the six northern signs of the Egyptian zodiac. Beneath Nut's gentle protective canopy are Aries, the Ram (Amun); Taurus, the Bull (Apis); Gemini, the Twins (two sprouting plants); Cancer, the Crab (Anubis); Leo, the Lion (Osiris); and Virgo, the Virgin (Isis). The seventh and most eastern architrave shows Nut and the remaining six signs of the zodiac: Libra, the Scales; Scorpio, the Scorpion (Sit-Typhon); Sagittarius, the Archer; Capricorn, the Goat (Mendes); Aquarius, the Water Carrier; and Pisces, the Fishes (Nephthys).

The second and sixth architraves exhibit the twelve hours of the night, and at each end a winged figure represents the wind. The third shows the sun during the twelve hours of the day as well as the moon, represented by the sacred eye. The fourth and central architrave is elaborated with winged disks and vultures (see figure 7.3). The fifth presents the twelve hours of the day, depicted as boats bearing sun disks, and the figures of the gods to whom each hour was sacred.<sup>2</sup>

Each interior wall is covered with similar reliefs that speak of tremendous skill and talent. Even obscure parts of the temple, such as the stairwells, are covered with marvelous decorations swelled with three-dimensional pride that leave us admiring their design and execution. The entire composition is highly ornate without appearing ostentatious. For an art lover, it could easily distract attention from the heart of its architecture—the engineering marvel that is the colonnade in the Great Hypostyle Hall. Twenty-four massive columns soar to the symbolic heavens, and each supports a capital composed of four heads of the goddess Hathor. A detailed examination of several of these capitals reveals knowledge similar to what we have examined at Luxor. Yet there is more—an accomplishment of engineering that makes even the superlative outpourings of admiration by Amelia Edwards seem inadequate.

February 2006 photographs of the temple walls and columns, after detailed analysis, prompted my return in April of that of same year with



better camera equipment: better lenses, a right-angle viewer, and a quality tripod. I had become fascinated by the symmetrical precision of the statues at Memphis, Luxor, and Karnak—but what we see at Denderah are not necessarily statues. Though they could be considered so, they actually indicate the fusion of art and technology into a wondrous expression of engineering and confounding mystery.

Visitors to the Temple of Denderah today are greeted with a highly eroded and damaged work of art that was originally crafted and assembled with all the precision and craftsmanship we might expect from a modern manufacturer who is blessed with advanced tools for cutting, measuring, and assembly. Our senses are overcome with superlative art and architecture, but the engineering that allows Denderah to exist has key characteristics that are seldom discussed and that have not risen to the level of notice enjoyed by the pyramids in the north.

Though superlative reliefs on the walls and ceiling receive most of the attention, throughout the temple there are outstanding examples of the builders' engineering prowess. The walls, ceiling, and columns are put together with such exactness that we can only sit back in awe of such an incredible accomplishment. Though not immediately apparent to the tourist who is rushed through the temple on a tight schedule, the meticulous care with which the elements of the temple are crafted is truly astounding. The principal elements of classical architecture that we see in the Temple of Denderah have been copied all over the world. They can be found in every major public building in nearly every country on the planet.

On each of the columns themselves, above Hathor's head, a cornice sweeps outward to form a low flat crown and a base for the sistrum above, which is also topped with a cornice to meet the elements of the architraves. From Hathor's neck to where the sistrum flares out to support the architraves, a complex arrangement of surfaces combine to create features that caused me to stare in slack-jawed wonder. The uniform contours of the stylized tresses that frame each of Hathor's now ravaged faces flow into blends that, with uncompromised exactness, create the outline of her angular face. Above the forehead the cowl makes a simi-

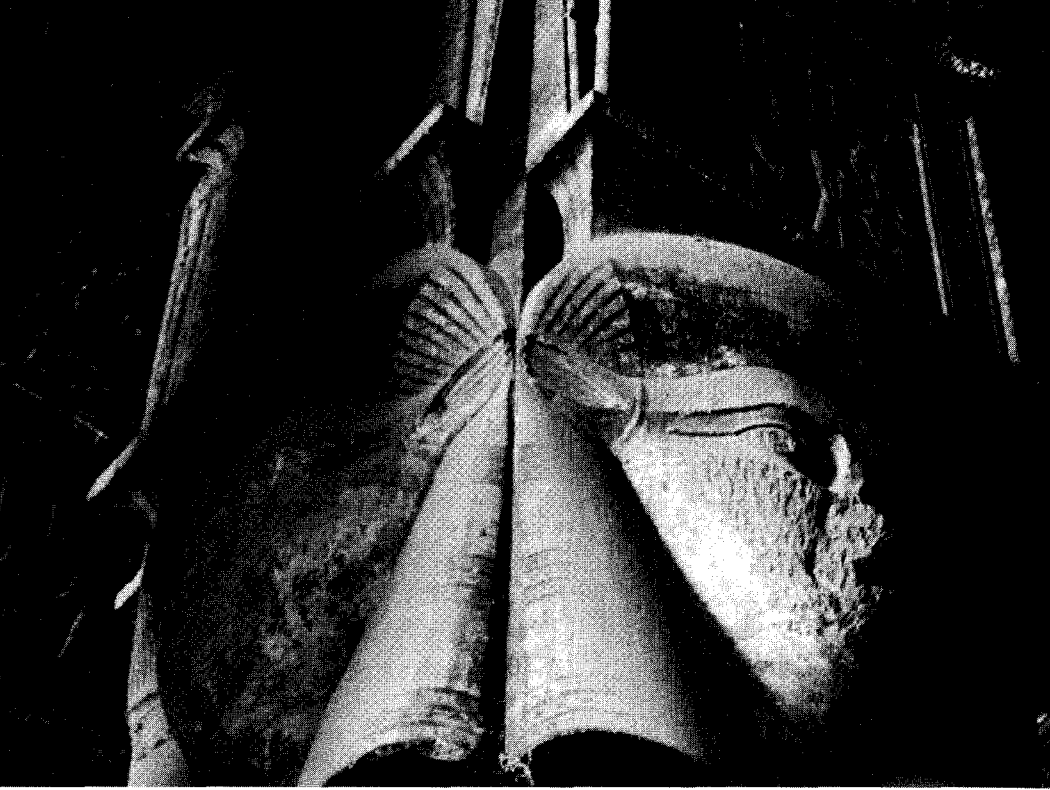

Figure 7.4. Capital on a column in the Great Hypostyle Hall

larly precise transition into the cornice below the friezes that adorn the four sides of the sistrum.

In February 2006, I took some digital photographs within the Great Hypostyle Hall and other parts of Denderah. After I looked closely at these images in my CAD program, I applied some reference lines—and what was revealed was quite surprising. So much so that I had to return to take more photographs, but this time with my camera firmly fixed on a stable tripod and with a right-angle viewer through which I could approximate a perpendicular and orthogonal orientation.

Like the set of photographs I took at Luxor, the February 2006 photographs of the ceiling at Denderah indicated that the capitals of the columns in the Great Hypostyle Hall were crafted with machine-like precision. The uniformity of the surfaces with exact corners where a blend radius transitioned from the sweeping contour of one geometric element into the flat surface of another was evident when I zoomed in on the capitals. Unfortunately, I zoomed in digitally, rather

than optically, hence the need for my return with a mounted camera and a zoom lens. This was how I could capture relative measures of the columns and analyze them in the computer in much the same way as manufactured products are analyzed today.

Along with Judd, at Denderah I was extremely fortunate to have the help of an old temple guard named Mohammed. Traveling to Denderah behind the afternoon convoy on Sunday, we had only a short time there, but enough time to share tea and a warm conversation. We arranged to meet Mohammed on Tuesday, when he would accommodate our need for a lengthy stay at the temple, making sure we had enough time in the crypt and the Great Hypostyle Hall to set up and take photographs. It was arranged that we would travel behind the early morning convoy and leave when the last convoy was ready to travel back to Luxor in the late afternoon.

In my travels to Egypt this past decade, it has always happened that someone fortuitously came forward to offer the kind of help I needed. This was one of those moments: with sincerity and kindness, a temple guard became the epitome of Egyptian hospitality and gave us access and freedom to study and take detailed, invaluable photographs.

We had six hours to study and take photographs, but I spent much more time analyzing the results in the computer. These results present a totally different view of the temple than what we can discern with the naked eye. Visitors to the temples in Upper Egypt are greeted with structures that have been severely weathered and damaged over the millennia. The floor and bases of the columns are rough and show where repairs have been made to broken areas. The capitals of the columns have been intentionally and systematically defaced. Of the ninety-six faces of Hathor that grace the top of the columns, not one has escaped the vandalism of ancient fury.

John Anthony West—an erudite scholar who personifies Euripides' statement "the tongue is mightier than the blade"—offered an interesting perspective on the destruction of statuary in Egypt. At the Temple of Philae, he pointed out that it was almost as though the statue, or relief, in the case of Philae (figure 7.5), was being decommissioned. It

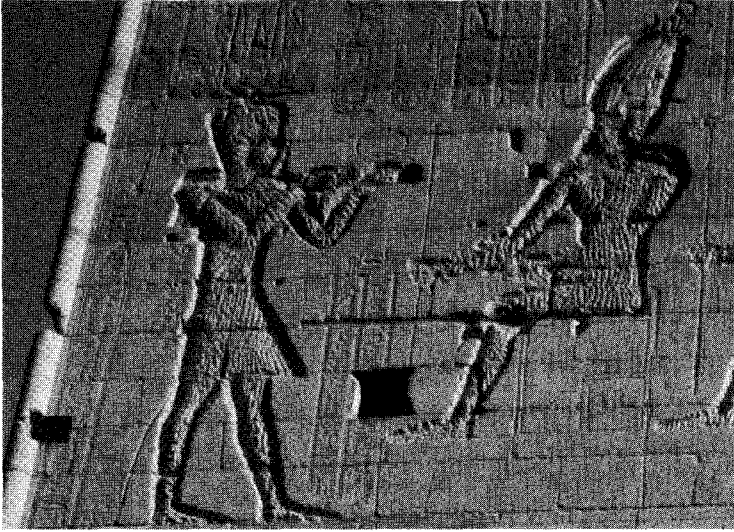

Figure 7.5. The pylon at the Temple of Philae

was not the work of vandals, because the defacement was dutifully and skillfully carried out, with carefully placed chisel marks.

The ancient Egyptians believed that statues contained the power of those they represented, and that through their noses, the statues breathed the essence of the deity—their life force. By cutting off the nose, they cut off the life breath to the statue, and it ceased to hold power over the people. My own impression at Denderah was that the destruction of Hathor's faces followed a significant catastrophic event that brought death and destruction to the Egyptians. Hathor was worshipped as the goddess of drunkenness and sex, but she was also known as the goddess of destruction who, upon the bidding of Ra, brought hardship and pain. Perhaps the survivors decommissioned or defaced the faces of Hathor because of a mind-consuming terror that she would bring more death and destruction.

Fortunately, the vandals missed a carved image of Hathor tucked away in one of the architraves. With telephoto zoom lens, I was able to pull out of the shadows a clear photograph of what the faces on the capitals might have actually looked like.

Interestingly, the face of Hathor at Denderah, is remarkably similar



Figure 7.6. The face of Hathor in the architrave at Denderah

to that of Nefertari at Luxor (plate 14), who appears as Hathor, with the horned-disk headdress. Unlike the Ramses faces that look down on visitors with a smile, Hathor at Denderah seems more interested in the drama played out on the ceiling than on the ground, while Nefertari does little to warm a traveler's heart with her hard granite, cold, haughty stare and pursed lips.

While I was setting up the camera and taking photographs, numerous tour groups rushed through the temple during the day. Some guides laced their official story of the temple with accounts of how the temple was built. The common theme, as it has long been written in Egyptology reference books on temple and pyramid building, is that the ancient Egyptians built an earthen ramp, dragged the stones up the ramp, and placed them in position. In the case of the temples, the columns were carved after all the stones were placed by working from the top down: as the masons worked their way down, the earth and ramp were removed.

As soon as the story was told, the guide yelled, "*Yala yala*" (let's go), and the group moved deeper into the temple, leaving me to ponder the contradiction before me. Through the viewfinder of my camera, I studied unusual elements of the capitals in the Great Hypostyle Hall that are significant in understanding their geometry. In order to comprehend how something has been made, we must clearly measure and understand all of its characteristics. Without knowing what it is,

we cannot state with certainty how it was made. When we analyze any part of a statue or structure, we should always identify the most difficult aspects of the work, because without being able to explain how the most difficult tasks were accomplished, the simple explanations for simple tasks—however narrow a segment of the work they comprise—do not satisfy the evidence in its entirety.

While the guide explained how the columns were put together (by dragging the blocks up earthen ramps and then chiseling them to the final shape), I pondered the manufacture and the “machined” appearance of surfaces that comprise the geometry of Hathor’s capital.

Figure 7.7 identifies two features that stand out, to me, as being crafted with an uncommon order of precision, and are therefore worthy

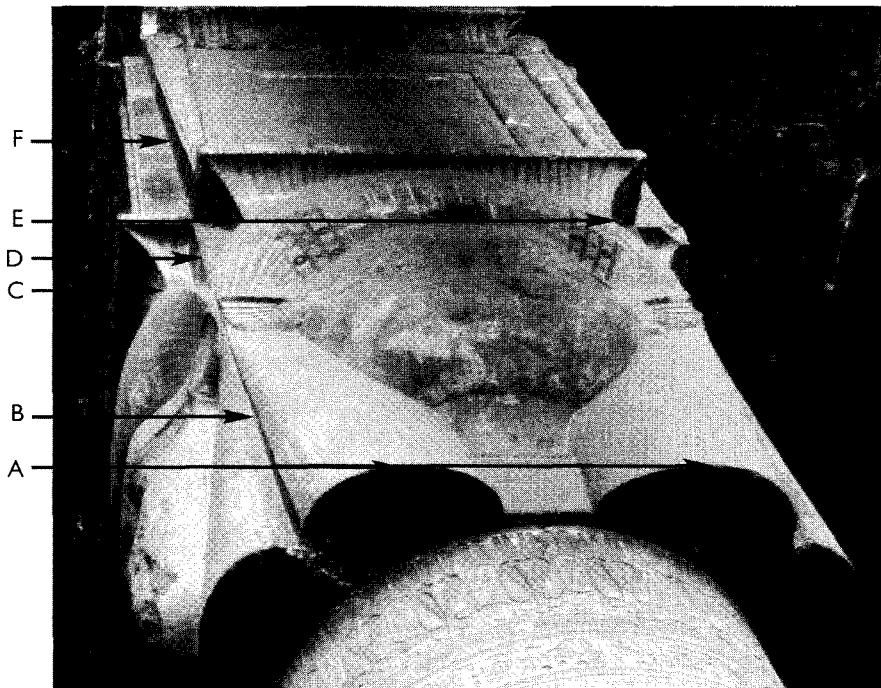

Figure 7.7. The Denderah capital. Points to remember: point A, crown point where Hathor’s tresses meet the top of the column; point B, inside corner that defines the end of one face of the capital; point C, point where Hathor’s cowl and the cornice meet; point D, outside corner that defines the end of one face of the capital; point E, points on both sides where Hathor’s cowl and the cornice meet.



of a detailed examination. Point E, the cornice/cowl intersection, is where two adjacent cornices meet Hathor's cowed hairstyle. This point is where the radial surface, Hathor's cowl, meets two flat surfaces, the cornices on both sides of the cowl. The surfaces of the cornice appear smooth and regular, with the remains of ancient paint still evident, and the corners are sharp. Sharp outside corners are not difficult to create, but the presence of a sharp inside corner, cut on any piece, leads us to wonder what kind of tools were used to create it, especially when consistent and precise geometry seems to be associated with the sharp corner. From the base of the capital, where the tresses meet the top of the column, to the top of the sistrum, each corner transitions from an inside corner at the base to an outside corner at the cornice, and then it continues as an inside corner at the sistrum (arrows B, D, and F).

This sharp *inside corner* came into my viewfinder the day after I discovered another sharp corner on the headless statue of Amun with his wife Mut in the Luxor Museum. Where Amun's left buttock meets the bench both Amun and Mut are sitting on, I detected an undercut that was about 2 inches in length (50.8 millimeters). Because photography was forbidden in the museum, I had to be satisfied with merely taking a wax impression of the corner and examining it later (see plate 15).

The wax I used is hard (Kerr brand) that requires heating to 132–33°F prior to being molded against the feature to be inspected. It is commonly used in manufacturing to take impressions of small, complex internal machined features so that they can be more easily measured for conformity. The undercut on the statue is 0.078 inch (1.98 millimeters) deep, and, comparing it to a 1/2-inch radius gauge, it has a 0.0355-inch (0.90-millimeter) radius. It was obviously a mistake made in contouring the statue, but it is a mistake that speaks volumes when we try to determine how the ancient Egyptians cut their statues. An ancient craftsperson would have had to invest a considerable amount of time and painstaking effort to create such a feature by hand. It could not be created suddenly by the slip of a stone or copper or bone or wood—the cutting materials cited in the archaeological record. These kinds of mistakes are not made intentionally, but are made unwittingly

and suddenly in a way that causes some anguish if the mistake cannot be accepted by the customer. On a statue, though, it is doubtful that, unless pointed out, anyone noticed the mistake.

Intriguingly, along the length of the undercut are parallel striations that follow the path of the groove. The striations range from a distinct ridge to faint lines—and, as we have learned, these are known to machinists as witness marks or ghost marks. Their presence on a surface indicates the use of a tool that leaves a consistent impression of its geometry on the surface of the material as it travels along a path, removing material as it goes. The appearance of such marks generally rules out free abrasives, which tend to create random patterns. In the case of the statue in the Luxor Museum, the witness marks inside the groove are evidence of a tool that may have been worn on the crown where two ridges appear about 0.015 inch (0.381 millimeter) apart. Away from the crown, on both sides, the striations are less distinct, but they can certainly be seen as faint parallel lines.

If we consider the nature of the cut and the presumed unanticipated action of the tool that created the groove where the left buttock of Amun meets the bench, it makes sense that more advanced tools than those accepted to date were in the hands of the ancient Egyptians. Although these kinds of tools have not been found in the archaeological record of any dynasty of the ancient Egyptians, we are left with artifacts that present circumstantial evidence that they may once have existed. Also, in light of what we discussed in previous chapters, this discovery gives some hope of solving the innumerable questions and controversies associated with the crafting of ancient Egyptian stone artifacts.

From a cursory analysis of the photographs taken in February 2006, I detected a quality about the geometric arrangement on the Hathor capitals that demanded a thorough examination. With this in mind, in May I took digital photographs of the capitals, keeping in mind the necessity to capture images that were squarely aligned with the ceiling and centrally located between columns or on center with a single column. My objective was to compare the cornice/cowl intersection (points

C and E in figure 7.7) and the tresses/crown point (point A in figure 7.7) with the other elements of the capital's geometry.

The capitals are complex, three-dimensional, contoured combinations of geometric elements that have been elevated a distance of 50 feet (15.2 meters) above the floor, and the crafting and position of these elements provides significant information regarding the level of manufacturing sophistication possessed by the builders. As we can see in figure 7.8, a view looking up at a capital reveals a remarkable precision. Particularly because all points where lines intersect have three axes determining their position. In other words, a two axes view with the photograph taken perpendicular to the capital will reveal two-dimensional precision. With the photograph taken on an angle from 50 feet (15.2 meters) below, a third axis is introduced and errors can be amplified. On an  $x-y-z$  grid, the front view of the cornice and cowl could be considered to be the  $x$  and  $y$  axes, while the view from the side is the  $z$  axis.

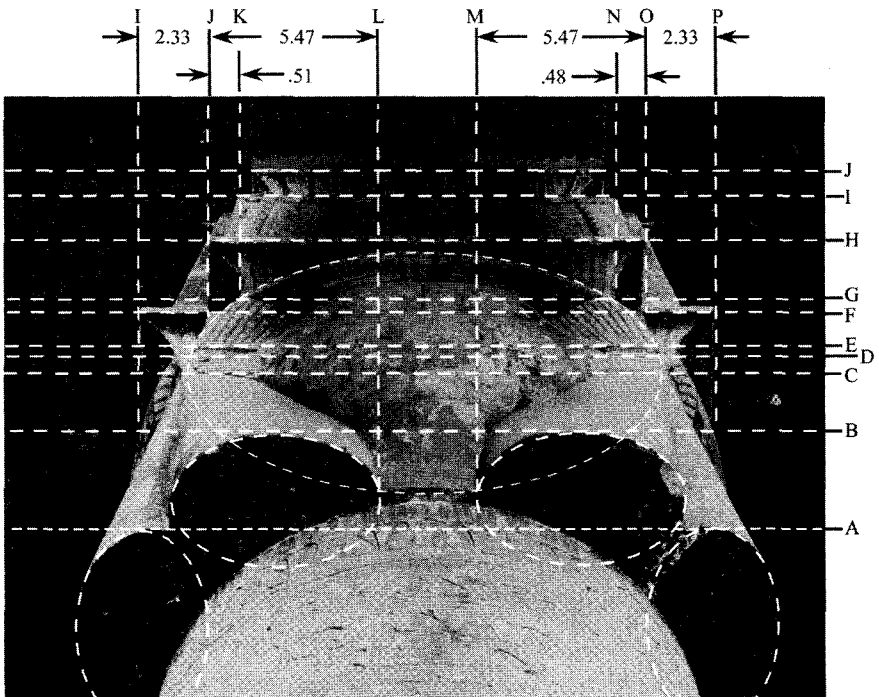

Figure 7.8. Capital geometry

For purposes of studying the alignment of the various elements, what the camera captured is sufficient to see that the flat surfaces F, H, I, and J (figure 7.8) are parallel to each other. At the cornice/cowl intersection are two points on equal sides of the center of the face where three surfaces meet. The cornice/cowl intersections are identified with lines G, K (left), and N (right). Any one of the following conditions could mean that these lines would miss the intersection point completely.

- The cornice on the front had some manufacturing variation from one side to the other.
- The cornice on the side had some manufacturing variation from one side to the other.
- The cowl was manufactured with some variation from side to side in the torus-shaped contour that sweeps down to the forehead—that is, top to bottom and side to side. (*Note:* Because of the angle of the camera, the top of the cowl does not appear in the photograph, and what is seen is the surface of the cowl's contour. This is a significant observation that makes the exactness more remarkable.)

While we are only studying one face of the capital, there are indications that this exactness was crafted on the other three sides as well. Remarkably, line D crosses the cornice/cowl intersections of both the right and the left side of the capital. It is interesting to note, also, that Hathor's ears, commonly seen to resemble those of a cow, come into play when line D crosses the top rib on the inside of the ear on both sides. Moreover, these features of the capital that consist of cleverly crafted three-dimensional contours find a correspondence on their tops and bottoms with line C and line E.

The dimensions applied are relational; they lack a system of measure and are not intended to provide dimensional data. They were measured in my CAD program after the vertical lines were applied and have no bearing on absolute accuracy because of the scale in which they were drawn. Further studies would need to be made to quantify the amount

of any variance to geometric perfection that Hathor's capital may possess. Nonetheless, geometric perfection cannot be claimed when we see line B crossing the crown points of Hathor's tresses. Not to disrespect the craftsman who created this sculpture, because we recognize his or her appreciation for the ellipse—on Hathor's cowl and where the tresses end at the top of the column—even if he or she did leave a high spot, revealed by the ellipse, on the right (Hathor's left). The question before us would be, therefore, is this error contained in the  $y$  or  $z$  axis? That will remain a mystery until further studies can be performed.

The adjacent faces at right angles to our view of figure 7.8 provide us with a tantalizing view of what we might find when the Hathor capitals are completely analyzed. Not only do the cornice/cowl intersections line up, but also, as seen with line A, the bottom of their tresses where the inside corner is cut, seen more clearly in figure 7.7, share the same horizontal plane. And here, again, we see the prolific use of ellipses in the design scheme.

When we view the capitals of Hathor from the ground with the naked eye, we fail to see the methods used to craft and assemble them. Close-up photographs, however, reveal that they were made out of more than one block and skillfully and exactly assembled with joints that are hardly detectable.

The design of the capital shown in figure 7.9 is typical of all those I examined. Figure 7.10 prompts some intriguing speculation about their manufacture. Were they crafted before being assembled, or were the blocks stacked up, in the manner suggested by Egyptologists, and then crafted in situ? It would seem that for purposes of quality control, a scheme whereby the stones are cut before being assembled would allow for greater precision, for it is quite obvious from the photographs that the split lines between the blocks necessitated exact surfaces in order for them to fit without a gap between them. In terms of difficulty, it would be hard to argue for one method over another. Either way, there are huge hurdles to overcome in replicating this ancient miracle. This fact becomes more relevant when we expand our analysis to that of the columns' relationships to each other.



Split lines

Figure 7.9. Assembling Hathor capitals

In studying figure 7.9 and figure 7.10, it appears that the enormously difficult task of creating the inside sharp corners may have been overcome by making the cornice separately before assembly. There is a faint hint of a joint where the cornice meets Hathor's cowl in figure 7.10 and, while difficult to state assertively at this juncture, where the back of the cornice meets the flat surface where Hathor's cowl ends, the corner is so sharp that it would be reasonable to suggest that the entire cornice was made separately before it was assembled in the capital.

This would raise other problems of manufacture. There would need to be a near-perfect geometric design that was applied to both the cornice and the cowl. It is not surprising to find, therefore, the ancient

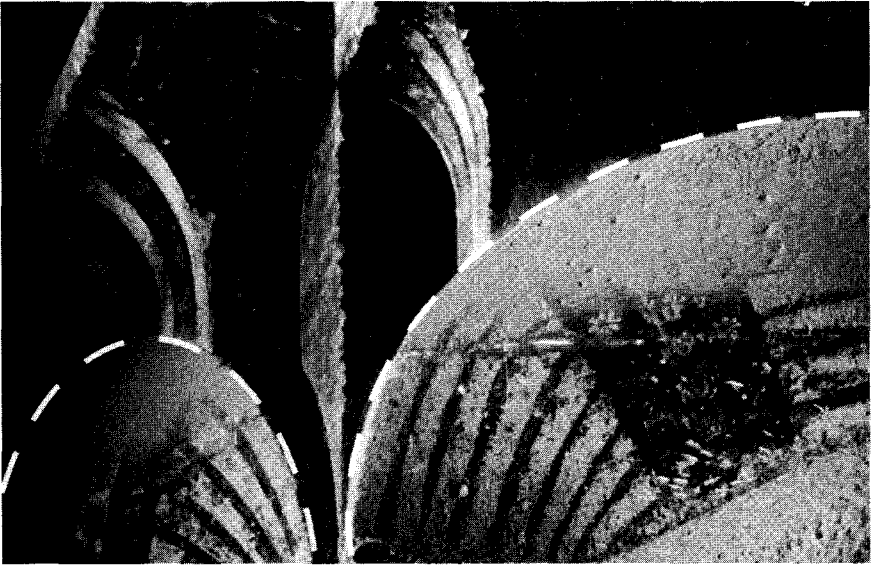

Figure 7.10. Hathor's capital assembly

Egyptians use of an ellipse as seen in figure 7.9 and sections of ellipses in figure 7.10.

However, I am not sure if Hathor's cowl is truly an ellipse. A circle viewed on an angle will appear as an ellipse. Similarly, an ellipse viewed on an angle may appear to be an ellipse with a different aspect ratio, or even a circle. Perhaps in the fullness of time answers to these puzzling questions will come. What we leave the capital with, though, is an understanding of the possible engineering and manufacturing that had to have been expended to bring Hathor to life in the Great Hypostyle Hall at Denderah.

Considering the columns' height, examining one capital to determine its geometry and precision reveals a quality of work that is surprisingly accurate for an architectural element constructed more than three thousand years ago. After seeing the Ramses sculptures at Luxor, however, should we be surprised? At Luxor, though, we were examining statues, and not the placement of architectural elements inside a building. The real test of a builder's skill is not just the crafting of a precise column, but the placement of that column in relationship to other columns.

Plate 16 is a photograph taken at the center of four columns. The image was aligned with horizontal and vertical lines drawn in the CAD program, and the lines were positioned over key features. The straight and flat surfaces have green lines, the inner cornice/cowl intersections have red lines, and the outer cornice/cowl intersections have blue lines. Also drawn were green lines touching the V-shaped grooves that were cut along the length of the tresses and which distinguished one side from the other. The bottoms of the tresses approximate ellipses to a degree of accuracy that eliminates chance and that reinforces the geometry seen at Luxor and Karnak in the *White Crowns*. In plate 16, four magnified insets of the cornice/cowl intersection give a better view of the location of the intersection in relationship to the crossed lines.

I have some experience on a smaller scale with assembling to exacting specifications precisely crafted objects with unusual geometries, thus what my camera revealed in plate 16 gave me a new level of respect for the ancient Egyptians' manufacturing and assembly abilities. To understand the significance of what this arrangement of four columns represents, we can study figure 7.11 on page 190.

The cornice/cowl intersection is a point in three-dimensional space that is created where three surfaces come together. In order for the condition seen in plate 16 to exist, the ancient Egyptians crafted identical capitals with precision, and then, maintaining similar precision, they mounted them on top of each column—the surface of which was perfectly flat and of the same elevation—with minuscule variation, column to column.

The point where the cornice and cowl meet, have to be accurately manufactured to dimension A and dimension B, as seen in figure 7.11 on page 190. The cornice/cowl intersection points provide the most powerful evidence with respect to a possible method. Seen from below, these points are barely noticeable, and I doubt whether anyone would give it any attention if it varied one side to the other or if one capital was rotated so as to throw off the alignment slightly. It is quite possible that those who crafted the columns were not interested in this point, but that their tools were such that precision was copied from capital to



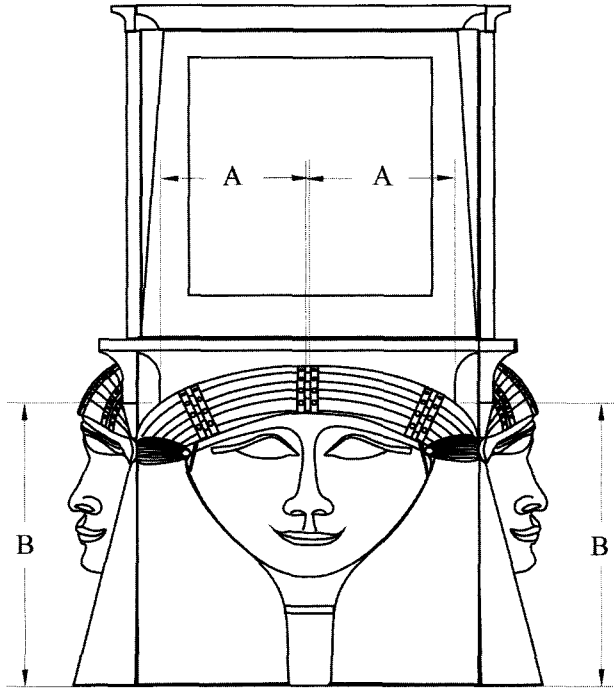

Figure 7.11. The capital's necessary precision

capital, replicating the same geometry each time. It is astounding that even with precision crafted into the capitals and each one lined up for installation that the builders were able to position them with such accuracy. This surely has to be one of the most incredible accomplishments of the ancient Egyptians.

Taking the study one step further, I analyzed six columns and illustrate their alignment in plate 17. Again, red and blue lines cross their own color at the cornice/cowl intersection, connecting each capital and column with orthogonal perfection.

Before we move away from the columns in the Great Hypostyle Hall, there is another feature associated with Hathor to which we should pay closer attention. Statues of Hathor usually depict her with bovine ears. Hathor was often depicted as a full cow with the sun disk between her horns or as a slender woman wearing horns and a sun disk headdress. Hathor in the Great Hypostyle Hall at Denderah is seen with cow ears,

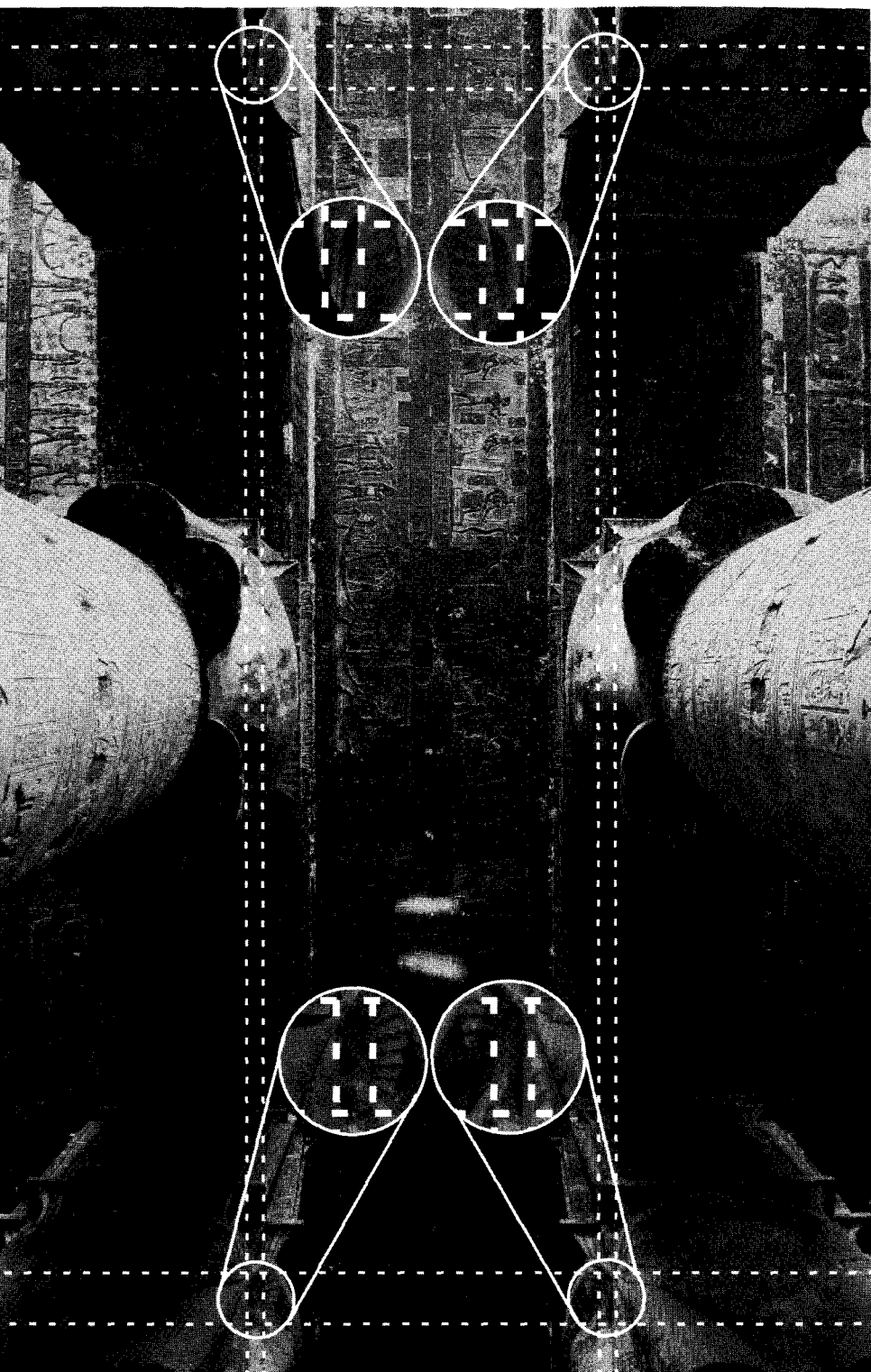

Figure 7.12. Hathor's ears

and it is the location of the ears that gives us some indication of the geometric replication of the capitals.

At first glance, the ears do not seem to be part of an exact geometric design. Looking at an ear, what we see is a feature that looks as though it was scooped out of the rock with a chisel. Figure 7.12, however, seems to tell us something different: these features were not the result of a sculptor's chisel, which might have been concerned with only one ear at a time, or even a team of sculptors who were each working on a separate ear.

From a distance that exceeds 20 feet, the ears on the outer capitals are in alignment with each other. These are three-dimensional contoured features, not flat surfaces with a simple radius that are crafted into other three-dimensional surfaces. Figure 7.12 speaks to the accuracy of the cowl into which the ears are cut and the replication of the ear geometry.

I have spent a considerable amount of time trying to come to terms with how the temple was assembled. As I think of this structure in the comfort of my study, it appears in my mind as a highly complex assembly of precision parts. Even the reliefs on the architraves appear to conform to a particular pattern. Though there are variations between the anthropomorphic reliefs depicted in figure 7.13, their overall shape and dimension is remarkably similar.

These images are just a small example of the vast array of images that cover every square inch of the inside of the temple. There seems to be strong evidence to support the view that the walls were carved after the blocks were placed. The ceiling, however, seems to be a different matter. Each of the ceiling blocks is perfectly fitted against the others. Even after millennia, the blocks do not show signs of drifting apart.

It would seem that to cut the reliefs on the ceiling would be much more easily accomplished on the ground than after the blocks were put in place. If this was done, however, it would have been an incredible accomplishment to match the reliefs from one block to another, and such perfection would certainly support more the point of view that the carvings were made after the blocks were put in place. Yet there are two blocks in the ceiling that seem to support the idea of the ceiling blocks

being installed fully finished: Intricate carving and precise surfaces were ready to meet another ceiling block. Perhaps the blocks were finished along the joint surfaces, and then, with the ceiling surface turned up, the reliefs were applied. Yet even this scenario does not quite explain a very subtle but significant difference in the way the shape of a dog's legs flows from one ceiling block to the other.

It appears in figure 7.14 that the carving of Anubis on the left was performed while the blocks were separate. The clear demarcation of the split line interrupts the natural form of the left leg, as seen in Anubis on the right, and there is a clear discontinuity along the neck.

While visiting the temple in November 2008, I had a further discussion with Arlan Andrews about the possibility that the Temple of



Figure 7.13. Two reliefs of the goddess Sekhmet on the architraves

Denderah was carved before being assembled. The topic came up when he was pondering how the reliefs were carved on the walls in the stairways to the roof. These stairways are very narrow, and the walls on both sides are intricately carved with reliefs. The blocks that comprise the walls are fitted with an exactness similar to that found on the casing stones of the Great Pyramid. As figure 7.15 illustrates, the joint is noticeable only because of the leaching of salts between the surfaces. This is common throughout the entire temple and is the only reason we are able to see the finely fitted joints on the capitals in the Great Hypostyle Hall.

Dr. Andrews suggested that the wall's stones must have been carved before being placed because of the enormous constraints that the artisans would have been faced with in this dark cramped space. Considering the evidence found on the ceiling, the idea makes sense. It also adds to the picture that is already taking shape of a culture that was using methods that we have so far not clearly identified.

Considering the level of perfection that is seen in the rest of the ceiling blocks and walls, if indeed they were carved before being put into place, the Egyptians accomplished an amazing feat of craftsmanship and engineering. Regardless of which side you come out on in the argument, along with all the other wonders at Denderah, it should surely elevate this temple to the status of Wonder of the Ancient World.



Figure 7.14. Figures of Anubis carved in the ceiling blocks



Figure 7.15. The stairway at Denderah

While driving back to Luxor on Sunday in May 2006, Judd and I were treated to a sight similar to the one Amelia Edwards described on her journey up the Nile to visit the holy man Sheik Selîm:

“Do you see Sheik Selîm?” cries Talhamy breathlessly, rushing up from below. “There he is! Look at him! That is Sheik Selîm!”

And so we find out that it is not a monkey but a man—and not only a man, but a saint. Holiest of the holy, dirtiest of the dirty, white-pated, white-bearded, withered, bent, and knotted up, is the renowned Sheik Selîm—he who, naked and unwashed, has sat on that same spot every day through summer heat and winter cold for the last fifty years; never providing himself with food or water; never even lifting his hand to his mouth; depending on charity not only for his food but for his feeding! He is not nice to look at, even by this dim light, and at this distance; but the sailors think him quite beautiful, and call aloud to him for his blessing as we go by.<sup>3</sup>

Today, our Sheik Selîm was not a stationary broken-down man, but a gentleman of stature with a determined stride and an equally determined nakedness. He was walking down the middle of the road with the indifference and gait of a camel: a haughty stare toward his destination with no mind for yapping dogs or playful children. While tourists—other than myself and my distinguished fellow traveler, of course—gawked, the local inhabitants paid little attention. It is customary in Egypt to give “unusual” characters a wide berth, which is why William Flinders Petrie performed his triangulations on the Giza Plateau dressed only in pink underwear and positioned under a large umbrella. To the Victorian tourist of his day, the sight was enough for them to give *him* a wide berth.

The world has changed drastically since the time of the building of the temple of Denderah, both in attitudes and technology. The methods the Egyptians used described in textbooks and academic journals, however, have changed little since Petrie’s day. In the next chapter I discuss these methods to see if there has been any progress regarding recognizing the ancient Egyptians’ true capabilities. Has it progressed over the past one hundred thirty year period since Petrie became the father of British Egyptology?



## 8

# Sticks and Stones: Tools of the Trade

*Quarrymen of the Pyramid age would have accused Greek historian Strabo of understatement as they hacked at the stubborn granite of Aswan. Their axes and chisels were made of copper hardened by hammering.*

DR. I. E. S. EDWARDS, EGYPTOLOGIST<sup>1</sup>

When Sir William Flinders Petrie presented his discoveries to the Royal Society in London, if he had been asked about a hard drive, he probably would have mentioned the London-to-Brighton run, which was to take place for the first time on Saturday, November 14, 1896. At the start of this memorable drive, a red flag was symbolically destroyed as the speed limit was increased from four miles per hour to fourteen miles per hour, which made redundant the man who was required to walk in front of a motor vehicle holding a red flag as a warning to pedestrians. Petrie was born in 1853 as the second Industrial Revolution began to pick up steam. Trains, ships, and factories increased their pace. Computers were not even a dream at the time, and the first working, efficient internal combustion engine was one year away from being patented in 1854 by the Italians Eugenio Barsanti and Felice Matteucci.

Since that era, creativity and invention has propelled us through





Figure 8.1. The Cairo Museum

time to the present, when electrons move letters faster than the post office ever thought possible and pink underwear on the Giza Plateau, such as the kind Petrie wore to keep away tourists, may not be considered as unusual as it used to be. In the one hundred thirty years since Petrie published his seminal studies of the pyramids and temples of Egypt, the hand tools and building and sculpting tools used by men and women have improved exponentially in capability and efficiency and hard drives are better known as integral devices in a computer.

Yet we are taught that during the three thousand years that the ancient Egyptians flourished on this planet, the tools used by men and women did not change. How could this be? The finely crafted and precise boxes inside the pyramids at Giza were supposedly created in the fourth dynasty, 2500 BCE, or forty-five hundred years ago. The

finely crafted and precise boxes inside the rock tunnels of the Serapeum were supposedly created in the eighteenth dynasty, 1550–1200 BCE, or thirty-five hundred years ago. We are asked to believe that in a one-thousand-year span, the ancient Egyptians did not make any significant improvement in their tools and methods for cutting hard igneous rock. We, however, have examined the results of their labor, and it is clear that the Egyptians were not stupid people. In fact, they were geniuses in their accomplishments, yet we are to accept that while they tapped into the awesome power of the human spirit and creativity, they did not ask, over the course of a full millennium, how they could do their job better—how they could demand less pain and strain from their workforce, how they could do more with less effort, how they could reduce injuries and provide workers with more time off. If there is any mystery to ancient Egypt, it is why a paradigm that was established one hundred thirty years ago still holds force among many Egyptologists and archaeologists.

The ancient Egyptian toolbox, we are told, contained simple tools made of materials that can be found in nature without further development or processing. These tools can be found in the Cairo Museum and the Luxor Museum as well as lying around the quarry at Aswan:

- Wooden squares
  - Wooden plumb bobs
  - Wooden bows for bow drills
  - Wooden sledges, or sleds, for hauling
  - Wooden pry bars for levering heavy weights
  - Wooden handles for axes
  - Wooden hammers or mallets
- 
- Copper chisels
  - Copper saws
  - Copper tubular drills
  - Copper adzes

- Stone dolerite pounders or hammers
- Stone chisels
- Stone axes

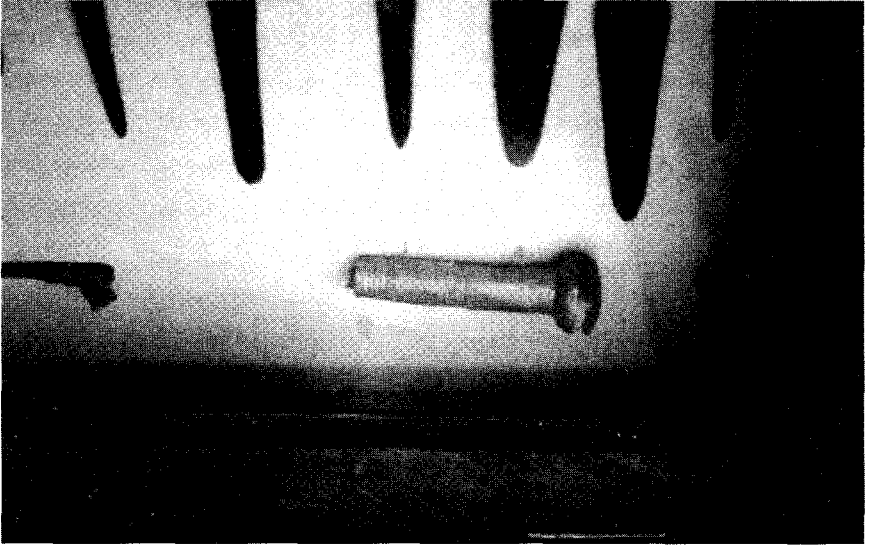

Figure 8.2. Tool case in the Cairo Museum

In 1986, when I visited the Cairo Museum, I asked a friendly Egyptologist guide how the pyramids were built. He led me to two cases where a collection of copper implements were housed. In it were several copper chisels and other assorted implements. After having spent three days exploring the plateau and going through each of the pyramids more than once, I stared at the case in disbelief. How could these paltry primitive tools be responsible for such an engineering accomplishment? It just didn't seem possible, especially after seeing the enormous amount of granite used in the construction. Yet here a respected Egyptologist insisted that it was so. It turns out that nothing has persuaded Egyptologists to think otherwise in the two decades since that time.

I asked the guide how it was possible that a soft metal such as copper could cut hard stone—particularly granite. His answer was to guide me to a travel agent through whom I could buy plane tickets to Aswan, where, he said, I could see how the granite was quarried. He explained that slots were cut into the granite, and then wood was inserted into the slots and soaked with water. After the wood swelled, the hydraulic pressure caused the granite to split. It was then dragged out of the quarry on sleds and transported down the Nile River on barges to Cairo and subsequently to the pyramids, where it was fitted into place.

The guide gave me the official understanding of Egyptologists, who have surveyed the accomplishments of the ancient Egyptians and considered what scholars found in the archaeological record, and thereby concluded that they possessed all they needed to explain everything. There was no mystery. Everything was available to explain how all the artifacts from that period were crafted. The chisels in the cases were there, so obviously they played a part. At the Aswan quarries there were dolerite balls lying around—so they obviously played a part—and tombs were found with carpenter's instruments in them, so obviously they played a part as well.

The unfortunate fact is that singly and collectively these tools do not explain the full scope of the work. The copper chisel will not cut granite, but copper that is rubbed against quartz sand, which in turn

rubs against stone, will wear both the copper and the stone. The impact of a dolerite hammer or pounder that is struck against a rock surface will crush the surface slightly, and after the loose material is brushed aside, more pounding can remove more material. A flint chisel struck against rock will crush the impact point so that small amounts of rock may be removed to accomplish fine detailing.

All of this work has been demonstrated by experimentalists who have attempted to explain how the ancient Egyptians built their monuments. In fact, a tremendous effort has gone into demonstrating how these simple tools worked and why they belonged in the ancient Egyptian toolbox.<sup>2</sup>

What is lacking in all the experiments that purport to explain how the ancient Egyptians crafted their statues and monuments are detailed manufacturing processes that leave us convinced that these methods are accurate and true to the evidence. To accomplish this, experimentalists must follow these steps:

1. Have experts examine rigorously and thoroughly the original artifact, paying close attention to the most difficult characteristics to reproduce.
2. Describe the theorized method used by the Egyptians.
3. Perform the work, including that which is most difficult.
4. Compare the experimental results with the original artifact—taking into account all the characteristics of the original.

In all cases, experimentalists have accomplished only steps 2 and 3. When steps 1 and 4 have been attempted, evidence has been overlooked or ignored. There is no argument that a hard stone bashed onto a softer stone will remove some of the softer stone. Will a flint chisel in the hands of a careful craftsman enable the craftsman to form stone into three-dimensional shapes such as small statuettes or hieroglyphs? Absolutely! Can quartz sand abrade rock in such a way that it gradually wears away the rock and leaves an impression of the object used to press down on or rub against the quartz? There is no argument that it cannot. An army of researchers could make a million slots in granite

using flat and tubular pieces of copper that rub back and forth on sand, but unless the results match the evidence left behind by the ancient Egyptians, these results prove nothing about the ancient Egyptian stone-working methods. Steps 1 and 4 are not fully satisfied.

What we have been taught is that the ancient Egyptians were in possession of only simple hand tools, and that the only metals available to the Egyptians of the fourth dynasty, when the Giza Pyramids were built, were copper, gold, and silver. What is inferred, therefore, is that absent the tools made from these materials, the simple abrasive experiments actually demonstrate the stone-working methods of ancient Egypt. We are told that the ancient Egyptians had not yet developed the knowledge to extract the raw materials necessary to produce iron and steel. It has been suggested that they may have used meteoric iron, because they found it lying on the ground, but they did not mine the ore and smelt it in a foundry. Support for this view is the lack of evidence that they used tools made of any material other than copper, stone, and wood. Yet absence of evidence is not evidence of absence. Although sophisticated tools made of iron or steel may not yet have been discovered in the archaeological record, what has been found is not adequate enough to explain how the artifacts were created.

In all experimentalists' efforts to convince the public that their theories are correct, not one has provided convincing evidence that what they have accomplished explains all the evidence. There seems to be a tremendous effort not to disturb the status quo when it comes to the stories such scholars tell about ancient Egypt. As long as experimentalists can scratch out a few cubic centimeters of stone using primitive tools, the ancient Egyptians are kept in their place in the history books. They describe to us a sinewy, linear view of history, from club-wielding cavemen to copper-saw-rubbing, dolerite-ball-bashing Egyptians to the Olympic accomplishments of the Greeks and then to the gladiatorial strength of the Romans—and so on to modern Western humans, who exercise their sinews on a treadmill with a symbol of their intellectual muscle in the shape of an iPod strapped to their arm.

In the previous chapters, we have examined artifacts that provide a

basis for the first step in the search for answers to the mystery of how the ancient Egyptians cut hard igneous rock with such proficiency and skill. We have examined the artifacts in their full glory, fully crafted and placed in their intended or subsequent resting places. In order to understand how they came to exist it is necessary to go to the source from whence they came—the quarries at Aswan in Upper Egypt.

In the next few chapters, we will examine in closer detail how Egyptologists have explained how the obelisks of Egypt were quarried and cut. We will review some of the literature that has been written on the subject as well as discuss the work of Mark Lehner, Denys Stocks, and Roger Hopkins in the *Nova* documentaries *Secrets of Lost Empires: Obelisk* (or *Obelisk 1*) and *Secrets of Lost Empires: Pharaoh's Obelisk* (*Obelisk 2*).

We will then address a subject that Sir William Flinders Petrie started in 1883, when he described the spiral grooves on an ancient Egyptian granite core as a “drunken screw.” I revived the subject in 1984 with a rather controversial theory about how the ancient Egyptians drilled holes in granite that showed a remarkable feed rate of the drill. Rather than focus on my own theory of how such things were accomplished, I will concentrate on those who have published the results of their own experiments, to see if their results are capable of explaining the evidence at hand. This involves my own experiment in performing a granite drilling using a copper tube and an abrasive and comparing the results with the granite core in the Petrie Museum at the University College, London. The results are noteworthy and some of them were unexpected.

## 9

# In the Shadow of an Obelisk

*So as regards these two great obelisks,  
Wrought with electrum by my majesty for my father  
Amun,  
In order that my name may endure in this temple,  
For eternity and everlastingness,  
They are each made of one block of hard granite,  
Without seam, without joining together!*

INSCRIPTION ON THE BASE OF  
HATSHEPSUT'S OBELISKS IN  
THE KARNAK TEMPLE<sup>1</sup>

Of all the iconic symbols of Egypt, the obelisk rises above all but the pyramids, both figuratively and physically. If it had been possible for Western invaders and influence peddlers to cart off the Egyptian pyramids, they probably would have done so, but with the marshaling of sufficient manpower and materials, the coveted Egyptian obelisks made their way intact, and sometimes in pieces, to the favored environs of imperial powers—which were, of course, their major cities such as Lisbon, Rome, Paris, London, and New York.





Although only twenty-nine obelisks survive from the distant past, the ancient Egyptian landscape was at one time dotted with what is estimated to be more than one hundred of these enigmatic shafts of pink granite. They were placed like an arrangement of acupuncture needles that pierced the sky, perhaps to disperse negative forces that occasionally threatened to accumulate among the populace, and served to protect large, open spaces where people congregated in and around temples, where the obelisks stood, normally in pairs, as powerful talismans for the temple and conduits from the empyrean. The obelisk was a focal point that gave the population heart and connection to their solar deity, the god Ra.

The ancient Romans had a passion for carrying off many of Egypt's obelisks, and their labors eventually resulted in Rome having more Egyptian obelisks than those that remained standing in Egypt itself. The obelisk that graces the center of the grand piazza of St. Peter in the Vatican was originally transported from Heliopolis to the Julian Forum of Alexandria under the orders of Emperor Augustus. It is the second largest obelisk in Rome, standing at slightly more than 75 feet (22.8 meters) in height and weighing approximately 330 tons (907 kilograms). In 37 CE, Caligula had the forum demolished, and the obelisk was transferred to Rome. From its place in the center of the Circus, it cast a shadow across the arena where Nero's inhuman taste for blood sports was gratified.

In 1586, Pope Sixtus V, who was known to have spilled his own share of blood while leading his flock, ordered the obelisk to be moved to the Basilica of St. Peter, where a temporary wall was erected while it was hoisted upright. Gathering behind the wall and on every rooftop and terrace in the vicinity, which included the roof of the basilica, an eager crowd strained for a glimpse of the work where Domenico Fontana, the architect who built the Lateran Palace and reconstructed the Vatican Library, directed the gangs that strained against the spokes of capstans. He held his breath, praying that his invention for hoisting the immense

tonnage would hold together and work. Arrangements had been made for Fontana to jump on a fast horse and escape should his enterprise fail, for the heads of those who displeased Sixtus V were known to end up on spikes, after their necks were stretched on the gallows.

During the transportation of the obelisk, the Bishop of Rome exorcized the horizontal shaft in an attempt to eradicate its pagan past and convert it to Christianity. When it was raised to its vertical position and the holy water had evaporated, a Christian cross, blessed by the pope, was affixed to the pyramidion.

The obelisk in St. Peter's piazza does not have the reliefs and hieroglyphs typically found on Egyptian obelisks, such as the one remaining at Luxor and those at Karnak. As seen in figure 9.1 and figure 9.2 these ancient reliefs stand out as a remarkable testament to the capability of the ancient artisans and their tools. Because I had examined the precision and symmetry of the Ramses statues and crowns, I was struck by the incredible beauty and consistency of three-dimensional form in the sunken reliefs on obelisks. On Hatshepsut's obelisk at Karnak (figure 9.1), for instance, the reliefs seemed to display a mechanical accuracy, using many of the same symbols as the obelisk at Luxor.

Some of the reliefs, such as the owls, have an eerie quality (see figure 9.2). With the light shining up the granite shaft at night, there is an optical illusion: After viewing the obelisk for a few moments, the sunken reliefs, their three-dimensional forms illuminated within the deep outline of the figures, appear as bas-relief figures projected outward from the surface of the granite.

While exploring the Temple of Karnak, I came across a piece of granite behind the Ramses statue just outside the Great Hypostyle Hall. It appeared to be part of a broken obelisk, and the workmanship of the reliefs, when seen up close, provided more detailed evidence of the astounding and flawless work of the ancient Egyptians. When viewed from a distance, the profusion of sunken reliefs on all four sides of the obelisks make the structure look like a beautiful piece of art. The right brain takes over, and the senses are overcome by the visual effect. Upon closer inspection of the extraordinary lengths the artisans

Figure 9.2. The obelisk  
outside the Temple of Amun  
Mut Khonsu at Luxor

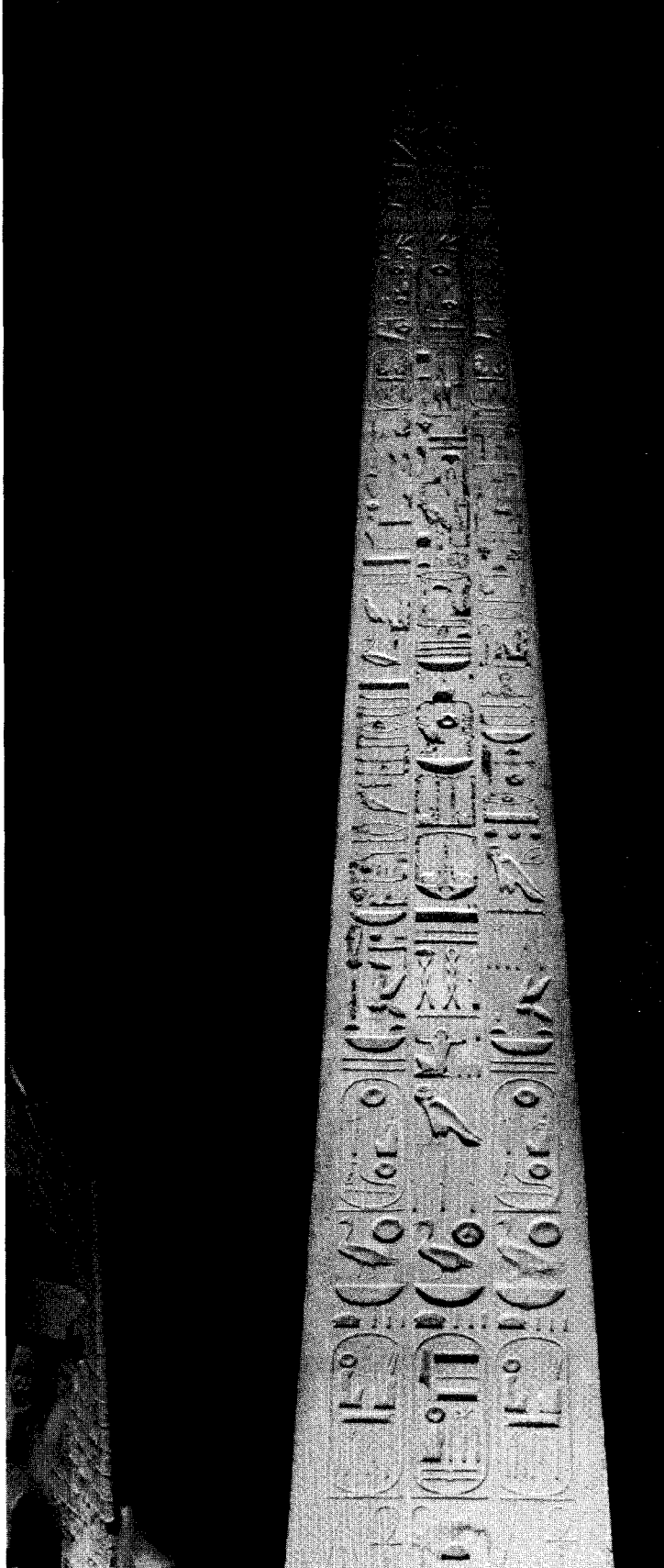

went to in order to execute their design, the left brain takes over, and it becomes obvious to sculptors, artisans, and engineers that the carving was accomplished with a high degree of discipline and with little variation in exactness and form from one relief to the next, from one obelisk to the next.

In figure 9.3, the depth of the sunken relief is consistent with most of the reliefs on the obelisk. To the right of my finger, however, are mere scratches that seem out of place and are, even to the most casual observer, different in quality from what the ancient Egyptian artisans were capable of producing, even on the same piece of granite. This seemed to be a common occurrence, and one that suggests that artifacts crafted by an older civilization were adopted and personalized by later cultures that were not quite as adept, and that did not possess the same kinds of tools as the original artisans.

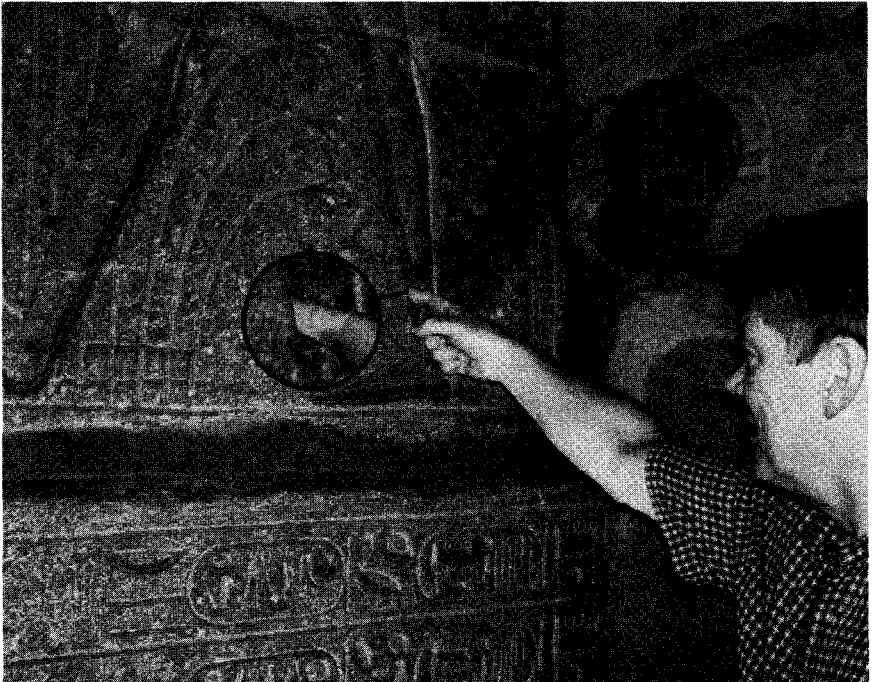

Deep relief applied by original  
artisans (inset left)

Shallow scratches applied later  
(inset right)

Figure 9.3. Sunken relief of a Nebet (basket)

As seen in figures 9.4 and 9.5, there is more to the ancient artisans' sunken reliefs than first meets the eye. One of the reliefs next to an owl inspired me to take a wax impression of the inside corner. My interest in this feature was the evidence of a corner radius that appeared to have been cut slightly deeper than necessary and that went below the three-dimensional contours of the relief. Significant in all the reliefs on Egyptian statues and obelisks that I have seen is the shape of the relief defined by a deep cut that is perpendicular to the outside surface, whether that surface is the flat face of the obelisk or the rounded contour of a statue. This particular relief was sunk from a flat face to a depth of approximately 0.5 inch (1.27 centimeters), where it terminated with a radius, though not a true radius from the tangency point of the straight surface.

Though the depth of the relief is technically impressive, the features to the right of where the wax impression was taken are even more so,

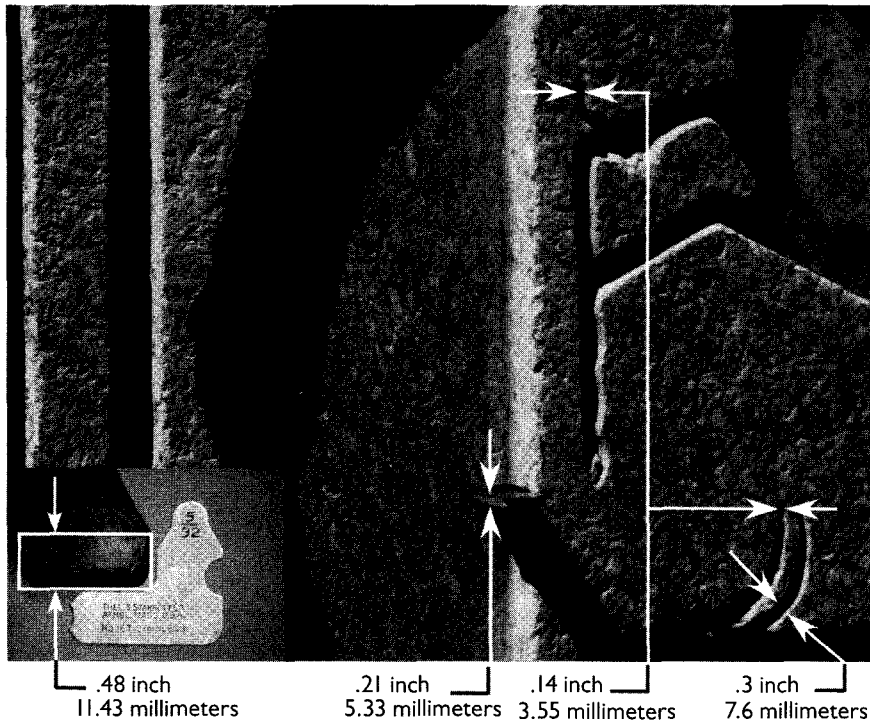
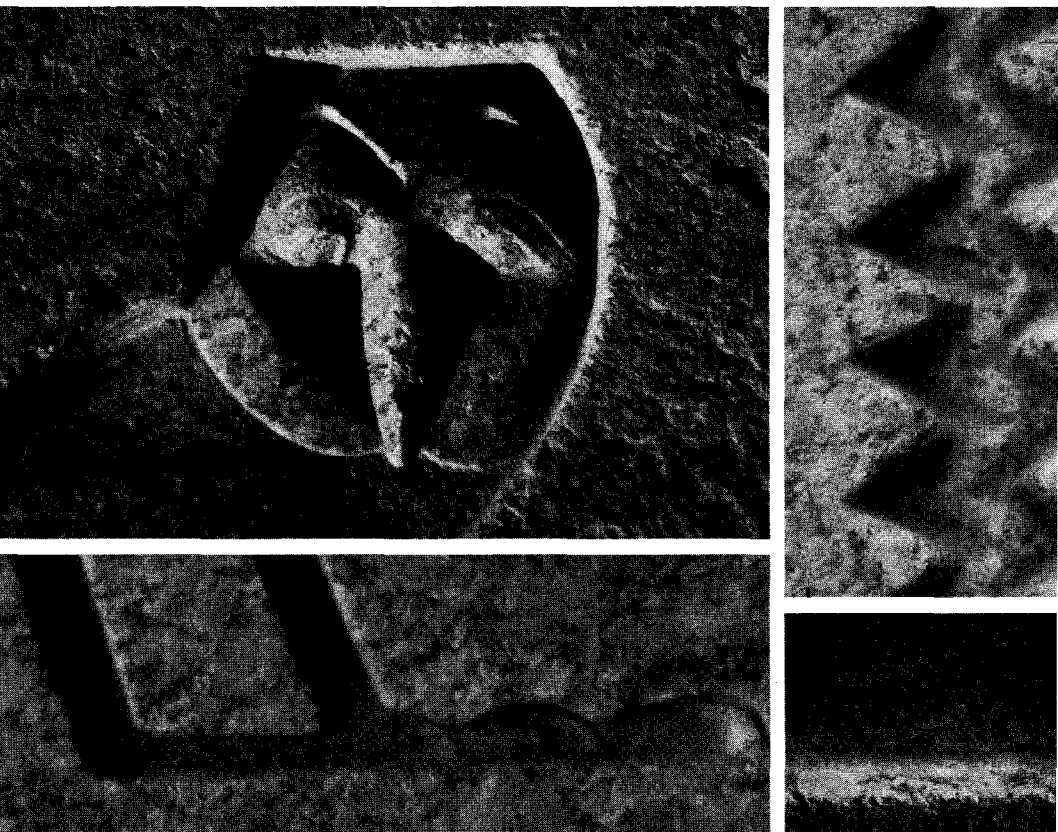

Figure 9.4. Photograph of details of wax impression

and give us a better idea of the capabilities of ancient Egyptian tools. These are the extremely narrow cuts achieved when the artisans created the talons of an owl. The two sweeping arcs start out 0.3 inch (7.6 millimeters) wide and end at 0.14 inch (3.55 millimeters) wide. When compared to the primitive scratches in figure 9.3, there can be no argument that a different class of tool and artisan created them.

The surfaces that outline the shapes of the reliefs and provide their depth are not polished and do not show any marks to indicate that they achieved their final shape by the action of tools that scraped or rubbed along their length to remove discrete amounts of material. Figure 9.5 provides several views of these surfaces, and they appear to have been the result of a tool that plunged straight into the granite, withdrew, moved over, and plunged down again. A template could have been used to guide the tool and achieve the consistency of form that we see on other

Figure 9.5. Examples of deep reliefs



artifacts—particularly on obelisks. To achieve the narrow cuts that are evident in figure 9.4, it would be preferable to repeatedly plunge into the material to create the outline and remove the bulk of the material to form the relief. This is because a tool with a 0.14-inch (3.55-millimeter) cross section is better able to withstand compression forces acting upon it than shear forces acting perpendicular to its length (see figure 9.6).

The figure in 9.5 that represents water or Uat (the zig-zag line) seems to provide confirmation that the outline of the relief was created first and then the material in the center was removed. In this relief, we can see the raised part of the center, which may, considering its width, have been broken down and then smoothed rather than tooled, as the complex, three-dimensional surfaces of other reliefs probably were. The falcon's talons at the lower left of figure 9.5 also give us indications of this.

There are no surviving tools or machines that can be shown to have produced this work. Those that survive are incapable of such accuracy, especially on an industrial scale. There are some controversial theories about how the pyramids of Egypt were built, but the accepted conventional theory of copper chisels and stone or wooden hammers simply does not hold up because such technology cannot reproduce the results we see. Further, because this answer does not suffice, it invites nonconventional solutions.

Yet these are not heard by the general public, who know of only the conventional theories that all children are taught in school and that

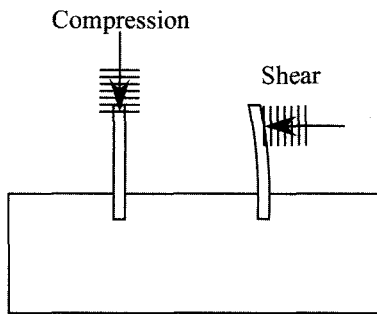

Figure 9.6. Compression versus shear force on tool



audiences see on the Discovery Channel and on PBS when the manufacturing methods of the ancient Egyptians are discussed. On such programs, copper chisels and stone pounders, crude as they may be, are not posited as a *possible* method of manufacturing; their existence in the archaeological record is presented as *proof* that such tools were used to produce the monumental megaliths that dot the Egyptian landscape. Obelisks are a prime example of what such a crude technology was supposed to have achieved.

It is important to give as accurate a description as possible of the characteristics of the sunken reliefs in Egyptian obelisks in order to judge whether modern attempts to show how they were created satisfy the evidence. For instance, in the PBS *Nova* documentary *Secrets of Lost Empires: Obelisk*, Roger Hopkins, a stonemason who participated in the making of this documentary as a consultant and expert witness, discusses the reliefs with Egyptologist Mark Lehner: “Even with modern tools and, you know, diamond wheels and all that, we would have, you know, we would have a tough time getting it to this kind of perfection.”<sup>2</sup>

Not deterred by Hopkins’s expert opinion, Mark Lehner picks up a dolerite pounder and demonstrates his theory of how the ancient Egyptians roughed out big hieroglyphs using it. After pounding for an hour he sincerely declares: “I’m convinced that with their skill and their rapport with the stone and a great deal of time and patience, that this is the way they carved the fine details like the hieroglyphs on the obelisk.”<sup>3</sup>

Lehner points out that scenes in Egyptian tombs indicate that workers are sanding and tapping out details of a statue using stone chisels and refers to drawings in the tomb of Rekh-mi-rē, who was a governor of Thebes during the reigns of Tuthmosis III and his son Amenophis II. His lavishly illustrated tomb contains many scenes of the craftsmen he oversaw, including sculptors depicted in figure 9.7. Illustrations such as these are used by Lehner and other Egyptologists as proof that the methods suggested by tomb drawings were the ones used to craft colossal statues and obelisks, with their deep sunken reliefs.

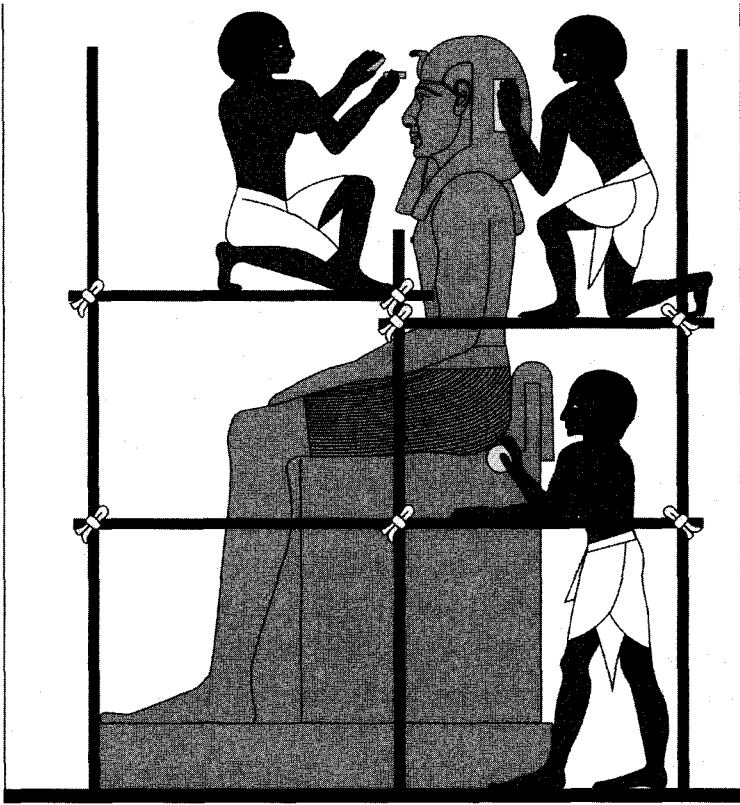

Figure 9.7. Depiction of a statue being worked on in the tomb of Rekh-mi-rē at Thebes. Drawing by C. Dunn, adapted from <http://history.memphis.edu/hypostyle/Tour/building5.htm>, with Ramses likeness added.

To his credit, Lehner admits that his efforts fell short of the quality of the ancient work on the simplest of shapes: the symbol for Ra, or the sun. His efforts produced a very shallow and rough relief compared to the original smooth, perfect profiles that are incised almost 1 inch deep. If he had managed to sink a perfectly formed falcon with narrow cuts of 0.14 inch wide, he might be able to argue that what is seen in figure 9.7 is an accurate representation of how the ancient Egyptians may have performed such intricate carvings.

Yet lacking replication of the more difficult accomplishments of the ancient Egyptians using such methods, the tomb drawing does

not explain the Ramses statues, and we cannot help but wonder what knowledge the artists in Rekh-mi-rē's tomb possessed about how the Ramses colossi were actually made. Was Rekh-mi-rē a prolific theorist in his day, and are these drawings mere speculations on how these colossal statues were created? Or is it possible that they describe how workers cleaned the statue and that what has been interpreted to be stonework tools may merely be sponges or sticks for cleaning out the corners? Either way, the evidence of the tomb drawings is hearsay, and the question remains regarding the correctness of connecting them to the hard evidence on the ground, which we cannot replicate when we use these tomb drawings for guidance.

Regardless of the ideas that are offered to explain how an object can be created, what counts are the results and how closely the results produced using those theories as guidelines conform, in this case, to the results produced by the ancient Egyptians. What results would we look for, then, to prove that the methods used by the ancient Egyptians to quarry, shape, sculpt, move, and erect a 400-ton obelisk have been demonstrated?

Lehner arguably does not prove methods in his obelisk documentary. For starters, the obelisk he uses is only 40 tons, and the reliefs that the cuts are not even close to the quality of the ancient reliefs. Another Egyptologist who was a part of Lehner's team, Denys Stocks, omits from his report a complete engineering description of the original artifact and clear photographic evidence of the artifacts that he attempts to replicate to prove his point. Although Stocks shows that he could chisel an ankh into soft limestone with a copper chisel, in his book *Experiments in Egyptian Archaeology*, he neglects to thoroughly describe the ancient Egyptian reliefs so that readers can compare his results with the originals. Also, his experiment in drilling granite using a copper tube neglects to describe the tool marks of ancient core drilling, as discussed by Petrie. We will address this topic in greater detail in the next chapter.<sup>4</sup>

Lehner mentions that having a rapport with the stone would bring greater success. This has a nice ring to it, because artists do connect with

the materials they work with and seem to develop an inner knowledge of how the material will respond to their touch. This quality of work is not necessarily quantifiable in a scientific sense, but rather is a unique gift that artists and sculptors possess. It was important for me, therefore, to seek the opinion of a modern sculptor who had gained a rapport with the material he has worked with over many years and who has produced significant works of art. I contacted Mike Leckie, a modern sculptor who has crafted many kinds of marbles, limestone, alabaster, and other rocks into incredibly beautiful shapes. His website presents photographic evidence of and commentary on the stages of creating a statue in marble. Figures 9.8 and 9.9 are photographs of a finished work that can be seen in progress at [www.mikeleckie.com/in-progress-marble.html](http://www.mikeleckie.com/in-progress-marble.html) and are reproduced here with his kind permission.

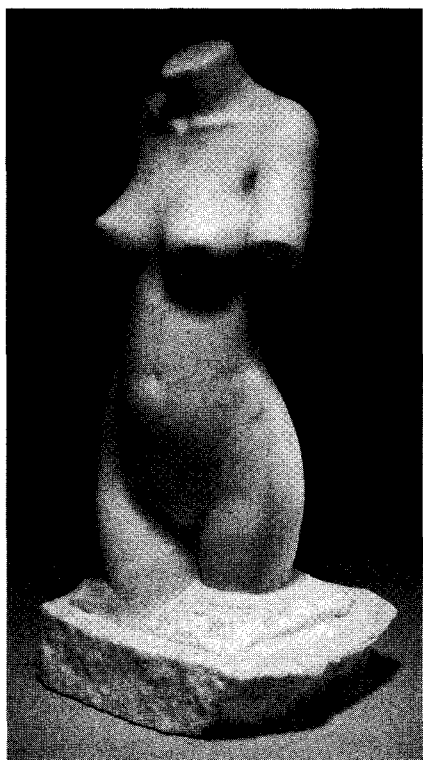

Figure 9.8. Mike Leckie's *Bather in Marble*, front

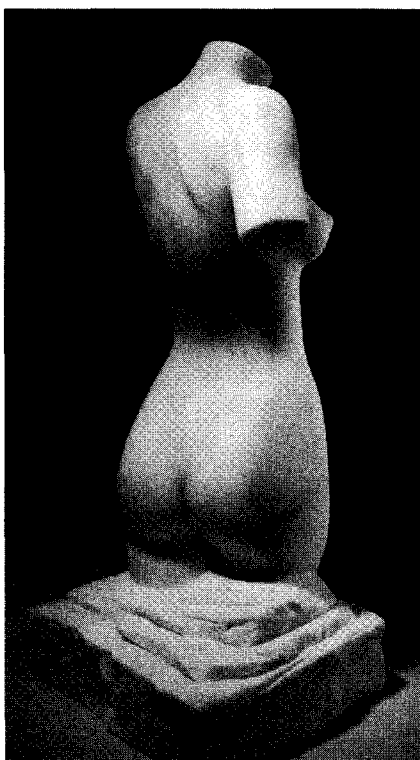

Figure 9.9. Mike Leckie's *Bather in Marble*, back

I was anxious to get Mr. Leckie's opinion on the Ramses statues at Luxor, and I forwarded to him my text that addresses those incredible works. In response, Mr. Leckie wrote to me his expert opinion on these immense accomplishments of art and engineering:

March 18, 2009

Dear Chris,

Thank you for this opportunity, I have been interested in Egypt and its sculpture since I was a child.

As a stone sculptor, I can say that the granite of the Ramses head and figures is an extremely hard stone, and I believe tools much more durable than hardened copper chisels must have been used in the carving process. It would be necessary for me to upgrade my normal tools to carve such granite. My modern diamond blades and grinding points would be worn out before the head was started. The ancient carvers must have had advanced technology.

Although the ancient Egyptians had stone chisels and hammers, which could cut the extremely hard granite, even with an army of disposable labor, completing four large sculptures exactly alike with hand tools would take more time than we can conceive of as possible. Modern man with all his modern tools would be challenged to finish one Ramses in a generous timeline. Creating four of them as large as they are, all the same, seems almost impossible.

Best regards,

Mike Leckie

[www.mikeleckie.com](http://www.mikeleckie.com)

From the time of Greeks until modern times, sculptors have preferred to work in stone other than granite, though with the rise of modern steel tools and materials, granite has been used on occasion.

The documentary produced by Lehner et al. is an interesting study that purported to demonstrate how the ancient Egyptians were able to quarry, shape, and incise deep reliefs into obelisks, transport the obelisks over many miles, and then pivot them into a vertical position on

a pedestal within or in front of a temple or other important building. It is important to note that the documentary's results fail in every way to demonstrate the more difficult aspects of the work. Nevertheless, it is an enjoyable study, thanks in part to the irreverent good humor of stonemason Roger Hopkins.

During the making of the obelisk documentaries, which were broadcast by PBS's *Nova* in 1999 and 2001, Peter Tyson, the online producer for *Nova*, went to Hamada Rashwan's quarry, which had been contracted to provide the *Nova* team with an obelisk for their experiment. There, Tyson interviewed Rashwan, an engineer and the owner of the granite quarry, which also provides some labor for the experiment. Rashwan has been in the quarrying business for twenty-nine years. Tyson asks him if he has learned anything from his ancestors about quarrying and moving granite. Significantly, this man who has been around the quarrying of Aswan granite for a lifetime, replies: "Yes, of course, because as you know, all the ancient Egyptian obelisks were produced in this area, the Unfinished Obelisk area. I don't think the ancient Egyptians used people, the workers, to raise obelisks. They used very advanced engineering techniques. I think that is the true way."<sup>5</sup>

Considering the difficulty and effort involved in moving obelisks from Egypt to Rome or London or New York, we might well ask why the Romans, English, French, and Americans didn't go to their own quarries and, with their modern iron tools, simply create obelisks of their own? Certainly, they wouldn't have had to move them as far, and the risks involved in seafaring would not be an issue. The answer to this question is better understood after a trip to the Unfinished Obelisk at Aswan, where the *Nova* team, following in the footsteps of other researchers, tries their hand at quarrying a 9-ton obelisk near to where the original 1,200-ton mass rests, as it has for millennia, still attached to the bedrock.

Roger Hopkins is tasked with carving out an obelisk using the tools that Egyptologists maintain the ancient Egyptians used. For quarrying, they theorize that dolerite pounders—dolerite is a very hard, greenish rock—were wielded by hand and bashed against the granite. The balls are 5 to 12 inches in diameter and weigh an average of 12 pounds (see

figure 9.10). As Hopkins works away at his task, Mark Lehner demonstrates how he believes the ancient Egyptians worked the granite in the tight confines of a deep trench that is only 26 inches wide at its widest point. As his workers scrape the bottom of the trench with their dolerite pounders, they respectfully avoid removing any of the granite.

Hopkins has been at the task for seven days when Lehner approaches him to view his progress. Lehner is not impressed, to say the least, for Hopkins had made very little headway, but proposed that he speed things up using more modern techniques.

This is not the first time Hopkins has been involved with Lehner and has had to call in modern tools when running into difficulty with supposedly ancient methods. *Nova*'s "This Old Pyramid" documentary had similarly run into difficulties using "ancient" techniques in the creation of a small pyramid. Lehner and Hopkins had to resort to steel tools and heavy machinery to lift most of the blocks that went into it.

There is some confusion regarding the exact amount of material removed in an hour in Hopkins's and Lehner's experiment. At one point, Lehner mentions that in two to three hours, 2 millimeters had



Figure 9.10. Dolerite ball at the Unfinished Obelisk (Photograph courtesy of Dan Hamilton, 2004)

been removed from a small square patch, presumably one quarter of the size of the patch assigned to a worker in the trench. If we calculate the amount of material removed per hour in the Hopkins and Lehner efforts, we learn the following:

### LEHNER AND HOPKINS

Width of square	12 inches	30.48 centimeters
Depth of square	0.078 inch	0.2 centimeter
Hours worked	2.5	2.5
Cubic mass/hr removed*	4.493	74.322
Weight of granite/cubic measure <sup>†</sup>	0.097 lb	0.0027 kg
Total weight of granite removed	0.436 lb	0.201 kg

\*The calculation used to determine cubic mass per hour is (width × width × depth) ÷ 2.5.

†Weight of granite = 168 lb/cu.ft; 2691 kg/cu.m

While at Hamada Rashwan's quarry, *Nova* producer Peter Tyson also tries his hand at quarrying with a dolerite pounder.

I got a nasty taste of their job—minus the cramped space and the pressure to succeed. Cupping a greenish-black dolerite ball in my hands, I brought it down with a crack onto a block of granite. Over and over, I bounced it on the same spot, till I thought I'd scrape the skin off my palms. After ten minutes, my wrists hurt from trying to guide the 12-pound rock in at an angle—the better to break the granite—and stabs of pain began shooting up my arms. Mark Lehner recalled that after once pounding for several hours, he could barely type on a computer: (“All I wanted to do was smash the keys,” he said.) I did it for only 20 minutes, and all I had to show for it was a baby's palmful of granite dust. And the granite's surface looked no different than when I'd started.<sup>6</sup>

Three baby's palms filled with granite dust after one hour of pounding would be somewhat dispiriting. Nonetheless, my own efforts were



no more successful when I attempted the same thing in 2006. The mid-day sun beat down unmercifully as I walked along the meandering granite path around the Unfinished Obelisk, an ancient relic that had seen the same sunrise a million times since it was abandoned by the quarrymen. The hill was pockmarked with the remains of ancient slots that were cut by masons in order to split granite blocks from the stone faces. Little is known about the original topography of the site because this quarry had been worked for millennia. Across the length and breadth of Egypt, millions of tons of Aswan granite can be found in the shape of building blocks, architectural elements, statues, and, most prominently, the famous obelisks that pierce the sky like giant punctuation marks, commanding visitors to look upward and know their place and mortality in an ancient and infinite universe.

I had plenty of water, an Egyptian *agal* (braided headband), and a *keffiyeh* (white cotton scarf) thrown to me by merchants in feluccas who had approached our Nile boat the previous evening. The Arabic strains of the soulful singing of Oum Kalthoum from our Arabian Nights evening had faded in my head, to be replaced by Noel Coward's famous lampoon of British colonial mentality, "Mad dogs and Englishmen go out in the noon day sun." I searched indigenous faces for signs of mirth. There were plenty.

"What's your name?" asked a cheeky young boy with a smile on his face and trinkets in his outstretched hand.

"Christopher." I replied. "What's yours?"

"Mohammed," he replied. "Welcome to Alaska!" he laughed.

"*Al hamdu lilla*" (praise be to God), I replied, soaking my scarf with water and securing it to my head with my *agal*. I love Egyptian quick-witted humor, and they love foreigners who can join them in making fun of—foreigners—and there's plenty of fun to be had in Egypt. The scarf blocked the sun, and the slight blowing breeze created a natural air-conditioning effect. It was practical, but not quite a dashing Indiana Jones look.

As I approached the obelisk, which is still attached to the bedrock against the granite hillside, I remembered when I first visited in 1986,

upon the advice of an Egyptologist in the Cairo Museum. Twenty years later, I noticed that the site had changed drastically. Instead of ascending a staircase straight up to the middle of the obelisk, a path with occasional steps wound around what would have been the pyramidion that crowns the traditional obelisk. Though money changed hands, there were no tickets sold in 1986, so there was no reception area, ticket booth, or gate to pass through, as there are today. Also missing back then were the ubiquitous guards that are now posted with rifles at every high point in the vicinity—a necessity given the existence of terrorists striving to kill tourists in order to destabilize the government. Of course, in 1986 there were few tourists, but in 2006 they flock to the site daily. In 1986, the only vehicle in the vicinity was the taxi that drove us to the site, and I had the entire quarry to myself.

The Unfinished Obelisk offers compelling indirect evidence regarding the level of technology its creators had reached—not so much by indicating clearly what methods were used, but by the overpowering indications of what methods could not have been used. I was not the first to realize the significance of the Unfinished Obelisk's sober challenge to theories about the methods employed by the ancient Egyptians in quarrying and shaping granite. The value of this artifact is that it provides an important contribution to the complete story of how obelisks were made—from the raw bedrock to the finished items that proudly stood in prolific number throughout Egypt.

Lehner, Hopkins, and I (independently and separately) came to the Unfinished Obelisk sixty-five to seventy-five years after it was first revealed to the modern world in its full glory. Between 1921 and 1922, Reginald Engelbach (1888–1946), the chief inspector of antiquities in Upper Egypt, undertook the task of having the rubble cleared from the trench that surrounds the obelisk, and, in 1923, he wrote an exhaustive study titled *The Problem of the Obelisks*:

Before the clearance, all the visitor could see of the obelisk was the top surface of the pyramidion and about 20 yards of shaft, which sloped down into a vast heap of sand, chips and granite boulders. It

has now become one of the most visited sights in Aswan, since nothing of its kind is to be seen elsewhere.

Most persons, having seen the temples and tombs of Egypt, become more or less blasé to them. This is largely due to the fact that no-one—least of all the dragomans [guide or interpreter]—brings home to them the enormous difficulties the Egyptians overcame. They dismiss them as beyond their understanding, and many closer students of the monuments than the average visitor have boldly affirmed that the Egyptians knew engines and forces of nature of which we are to-day ignorant. This is quite a wrong idea; it is, as a matter of fact, far easier to explain every step in the mechanics of a large obelisk to the non-technical reader than those of an iron bridge. Though modern research robs the Egyptians of the magical powers attributed to them, it makes them more admirable in the eyes of the practical man, as it shows that they could do, with the most primitive tools, feats of engineering which we, with some 3,000 years of mechanical progress behind us, are barely able to copy.<sup>7</sup>

### **Engelbach's Measurements of the Obelisk**

Length: 137 feet

Base: 13 feet 9 inches

Pyramidion base: 8 feet 2 inches

Pyramidion height: 14 feet 2 inches

Weight (if it had been extracted): 1,168 tons<sup>8</sup>

Little seems to have changed since Engelbach's time. Alternative ideas were expressed about the Egyptian monuments even in the 1920s and were summarily dismissed in much the same way as they are today. Yet in a discussion with an Egyptologist with the Department of Tourism in 2004, I was told that every time she accompanies engineers around the Unfinished Obelisk, they dismiss the official theory as unworkable



and start discussing how it really could have been accomplished. This may be considered hearsay, or worse—thought of as pandering—but it rings true to me, for I too have been in the company of engineers who are of the same mind and engineers are not known for pandering, especially toward other engineers. If everybody knew of Engelbach's work and his opinion of such speculations, would these types of conversations still take place? They most certainly would.

It is postulated that the obelisk was abandoned because a crack had developed during the quarrying process. This seems to be a logical assumption, and it is commonly accepted to be true. Yet having invested such a huge effort in the trenching process, the ancient Egyptians—if they were continuing to create sarcophagi, statues, and other building blocks—could still use the cracked obelisk for a great deal of usable stone that was not cracked. They would merely need to cut the quarried piece into shorter sections to get some good stone for their labor. In fact, it appears that this is what was attempted in an area near the pyramid-

Figure 9.12. Series of drilled holes on top of Unfinished Obelisk

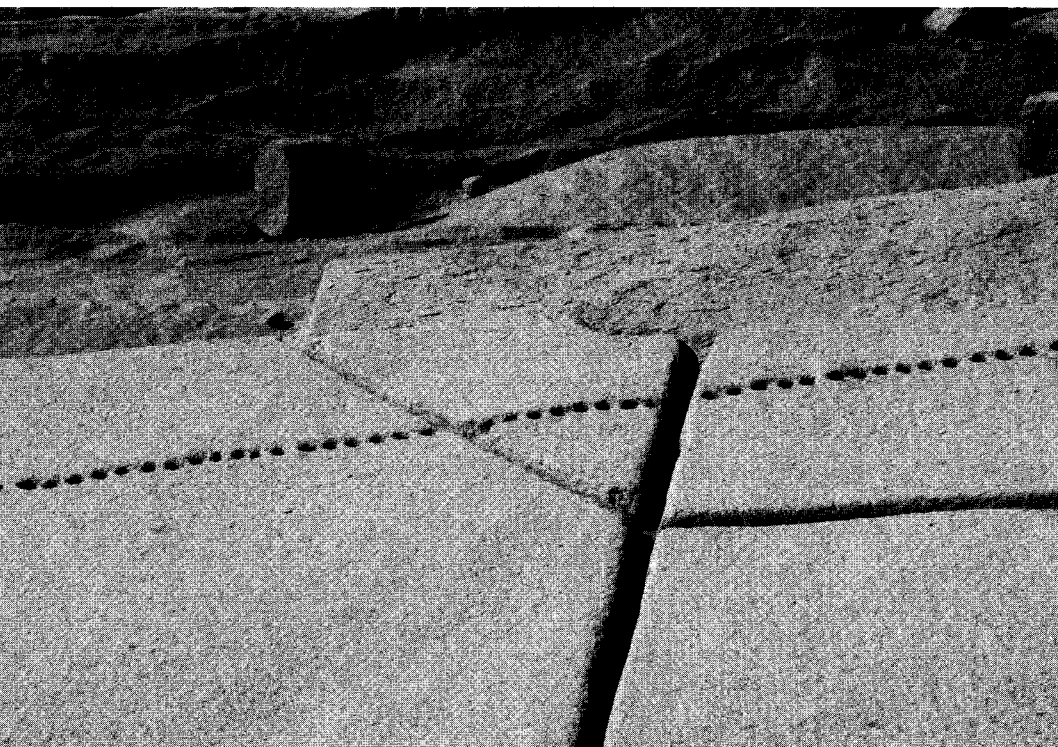

ion, where there is a series of holes drilled in a line (see figure 9.12).

The line of drilled holes seems to outline a small obelisk, if you take into account that the outline also includes the groove, which may have originally been a line of holes before being dug out. Considering that the outline crosses the crack to what might be the pyramidion, it would indicate that when they were drilled the obelisk had not yet cracked. Was the crack that has long been theorized to be the reason why the obelisk was abandoned actually caused by work performed at a later date? It seems unlikely as fissures are in abundance throughout the granite bedrock, and this fissure through the granite appears to coincide with a fissure in the bedrock hill to the south (see figure 9.11).

Why the obelisk was abandoned will probably always be a mystery. There are no records that tell us that the quarry workers expended an enormous amount of resources on the granite hill and found a crack, so they picked up their tools and went to hammer somewhere else. We could speculate that all work ended while the obelisk was being excavated because of a cataclysmic event that disrupted the Egyptian civilization. All quarrying ended at Aswan and elsewhere, and it wasn't taken up again until the Romans controlled the country in the first century BCE. In fact, the unfinished obelisk may be the last artifact to be quarried in ancient Egypt, and as such, it would represent the state of the art in quarrying and moving large objects—notwithstanding the fact that it was not moved.

As I walked around the obelisk, I noticed several areas that display evidence that has been used to lend support to the traditional theory of how the ancient Egyptians quarried granite. Egyptologists posit the simplest of methods for shaping stone. Natural materials such as dolerite are drawn from the earth with no further value added to them. The pyramidion and other parts of the obelisk have several shallow depressions that have been shaped by an object that left rounded corners at its perimeter. Nearby, a shelf of granite has the same marks, and these rounded features are commonly seen at the bottom of the deep trench that defines the shape of the obelisk. All over the quarry and in the trench around the obelisk dolerite stones were found in antiquity so it is

natural to conclude that the marks left in the trench around the obelisk were created using dolerite pounders.

I walked a short distance away from the base of the obelisk to an area where granite blocks and dolerite balls were found lying around. I pondered the traditional theory while picking up one of the balls and wondered whether I was holding what amounted to a red herring and the rounded features that are seen on the surface of the granite were created by some other method? While I had always questioned this theory, after trying my hand at the methods suggested by Engelbach, my skepticism increased.

Visitors to the Unfinished Obelisk approach it from the north and follow an eastern path around the pyramidion. They can encircle it to the west, where a viewing platform is located. The retaining wall present in 1986 was removed, and the bedrock slopes down to the obelisk, where visitors can get a clear view of the trench. When I revisited in 2006, I went over to a block of granite near the platform. It looked as though someone had been there before and had been bashing at the surface. I picked up one of the dolerite balls that were lying in the vicinity and started to pound on the already bruised granite, taking note of the amount of material I was removing.

The trick to working granite using a dolerite pounding ball is to allow gravity to do most of the work. If the ball is smashed against the granite with the hands in full contact with the ball and adding weight behind the strike, severe damage to the user can occur over time due to the forces acting on the muscles and connective tissues in the arms, hands, and wrists. Those who have attempted to force the ball against the granite without releasing it have, as Lehner complained, suffered after just a short time.

The same results can be achieved without significant pain to the user if the dolerite ball is released before it hits the granite block. Nonetheless, as I went at it using this method, the results were not much better. Raising the pounder about 3 feet from the granite surface, I rapidly brought it down and released it just before it struck. I was rewarded by a puff of dust from the granite's surface. I tried to build a rhythm

and imagined getting into a hypnotic state with ancient chants timing my swing so that all thoughts of how miserable the job was could fade away and it was just me and the granite and the smack, smack, smack of the ball all day long. It was impossible. Catching the ball became very tricky; it did not always rebound off the granite along its original path. In fact, the task became quite dangerous as the ball bounced in unexpected directions. The uncertainty of the method meant my mind had to be alert. Moreover, after striking the granite successfully for about five minutes, a layer of granite dust covered the surface of the stone and had to be removed because it served as a cushion between the ball and the granite. The removal of waste from a cramped space would have been a significant consideration, as it is in all manufacturing and excavation processes. Notably, the surface finish of the granite created by the dolerite ball did not resemble the surfaces that define the obelisk.

My efforts yielded no better results than those of Lehner, Hopkins, or Tyson. Like Tyson, I was not constrained by the trench walls, nor did I have the risk of striking my toes or anyone else's toes who happened to be next to me. Climbing into the trench, the uncertainty of success using these methods became even more obvious. There is not much room down there (see plate 18), and while anyone can crouch down and strike a ball against the bottom of the trench, the efficiency of the process would diminish significantly as the corners were worked. With a round ball, the flat horizontal surface would diminish as long as the worker was increasing the depth of the channel and not working out the corners. At some point, the corners have to be worked on, which means that the ball could not be released from the hands without bouncing off at an angle (see figure 9.13).

Theoretically, that angle is predictable, but not if the ball is egg-shaped or irregular, as was mine and as were all others that were lying around. Depending on how the ball hits the granite, it becomes quite difficult to catch and maintain a rhythm. Back at my horizontal surface, puffs of dust rose from the granite as the ball came up and fell again. After several minutes of this exercise, very little material was removed, but the nearby 13-foot-9-inch (4.19-meter) deep troughs with several test





Figure 9.13. In the obelisk groove at Aswan

bores cut even deeper, bore stark unadorned testimony to the full scope of the work, and I questioned whether people who only knew of this inferior method of material removal would even conceive of taking on such a project.

Engelbach speculated that approximately one hundred thirty quarymen worked in the trench at the same time, and each worked an area of around 26 square inches. His own experiments were unusually successful compared to the experiments of those who followed him, and he reported the following results:

To return to the trench, it is interesting to speculate on the amount of time which was expended in making it. To ascertain this, I tried pounding for an hour by hand at various times on one of the quarters of a two-foot task, and I found that I had reduced the level by about 5 millimetres (0.2 inches) average. With practice I could perhaps have done more. Let us assume that the ancients could extract 8 millimetres (3.15 inches) [sic], [should be 0.315 inches or 8 millimeters] per hour from a similar area; then the time taken to make the trench must be the time taken to do the deepest part. In this obelisk the trench would have to be 165 inches [419.1 centimeters] to make it of square cross section and we must allow at least 40 inches [101.6 centimeters] for the under-cutting (p. 49), making a total depth of trench required of 205 inches. Supposing that 3.15 inches [should be 0.315 inches] were extracted from a quarter of each party's task per hour, it will require  $4 \times 205 / 3.15 \times 12 \times 30$  or 7.2 months of twelve hours per day. The undercutting would have taken at least as long again, even though it could be done from both sides at once.<sup>9</sup>

From Engelbach's description of his own performance, he was inside the trench when he worked. He says: "I tried pounding for an hour by hand at various times on one of the quarters of a two-foot-task." This statement also indicates that the work was not conducted continuously for one hour, but "at various times," which indicates that he had rested in between the various times that he pounded.

Adding together each of the various times, Engelbach pounded for a total of one hour and had reduced the level of a 12-inch (30.48-centimeter) patch by 0.2 inch (5 millimeters). Comparing Engelbach's success with Lehner's, Tyson's, and my own, the amount of material he removed, if calculated properly, would be five to eight times the amount we were able to achieve. Yet there is uncertainty behind all of our efforts because no one made an accurate description of the granite before and after the work was performed. Nor were any measurements of weight taken to determine if the amount of granite removed was actually as stated.

The profile of the trench with their rounded corners shown in figure 9.13 pose a serious question as to whether Engelbach's material removal was the same across the full surface of the 12-inch square patch and included the rise to the wall of the obelisk or the bedrock, depending on which side of the trench he performed his tests. To be confident that he had done this, we would require a more complete description of how he had arrived at his measurements. This description should include measurements from a flat horizontal plane to various points on the concave surface of the patch, including up the side of the radius to the wall, and then, after the work was performed, more measurements must be taken from the same flat horizontal plane to the same points. As it is, we have only Engelbach's statement that he was able to reduce the level of the granite by 0.2 inch (5 millimeters).

Even if Engelbach had worked on a 12-inch square flat area and reduced the amount by 0.2 inch (5 millimeters), questions would still remain regarding the difficulties associated with dolerite balls and a horizontal-to-vertical corner radius and how they affect any conclusion we might reach in calculating the entire 13-foot-9-inch depth of the trench. As seen in figure 9.14, reducing the level of a 12-inch patch by 3 inches using a 6-inch ball would leave 11 percent more material in the corners than if the corners were squared. But this material would eventually have to be worked out by attacking the sides, or the trench would become narrower and narrower. Bringing the ball down vertically onto a horizontal flat surface of the granite provides the greatest force and, therefore, the greatest material removal. When the rounded corners

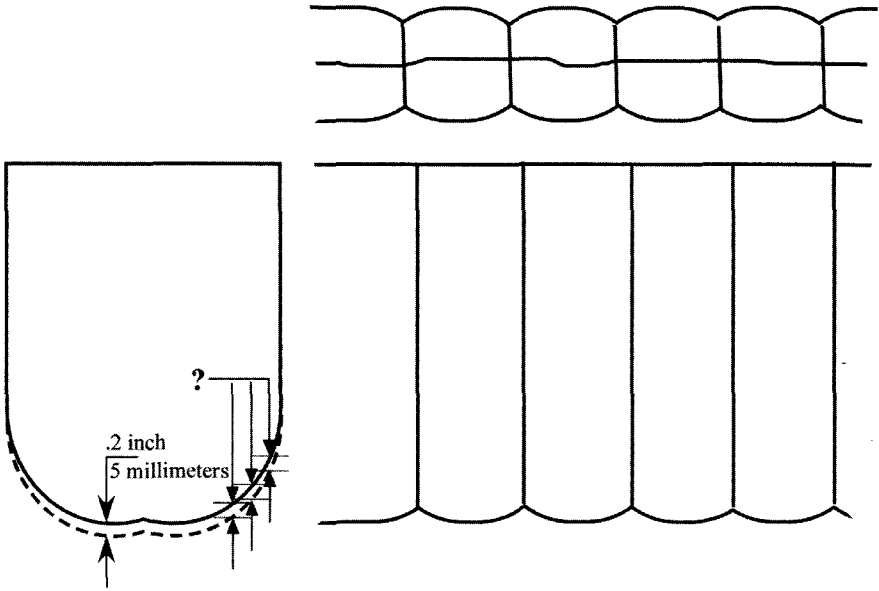

Figure 9.14. Cross section of obelisk groove at Aswan

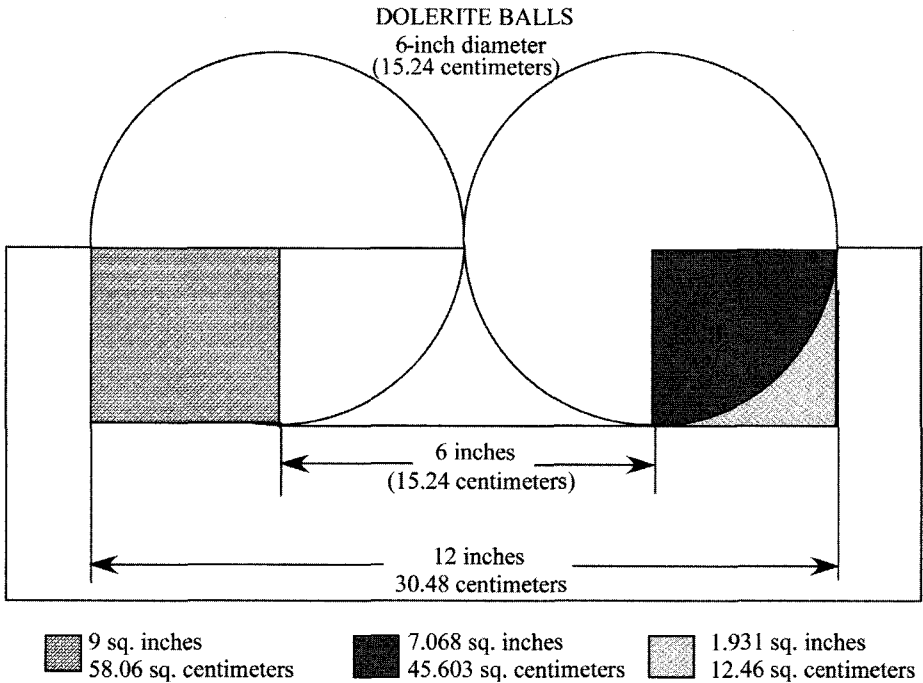

Figure 9.15. Surface area considerations using a round ball

must be worked, the ball has to be guided on an angle or, if applied vertically, it delivers a glancing blow. Either way, the ball will bounce off to the side and become difficult to handle. Lehner's obelisk documentary shows the workers in the trench scraping rather than bashing the corner radius with their pounders.

Engelbach discusses the use of rammers, in which the dolerite is lashed to long pieces of wood and thrust like a spear against the granite. Theoretically, there may be some merit to this method, but its practical application raises the question of how much force could be applied to the wood and rope before either material failed. This becomes significant if we consider the difference between what Engelbach proposes and the information I received in an e-mail from Denys Stocks on October 31, 2001, about his experiments with dolerite pounders.

Mr. Stocks estimated that his removal rate of granite for flattening prior to chiseling a hieroglyph using a stone chisel was around 20 to 25 cubic centimeters in 45 minutes. This calculates to about 26 to 33 cubic centimeters per hour. I used this calculation in an article I had written for *Atlantis Rising* titled "The Obelisk Quarry Mystery," which was republished in an anthology titled *Forbidden History*.<sup>10</sup> In the article I had used Stocks's material removal rates and calculated how long it would take to pound out a proposed workman's patch down to the deepest level necessary to define the features of the obelisk. Following the article, I received a recommendation to access Engelbach's book *The Problem of the Obelisks*. I had assumed that Stocks's more current information would have been sufficient, but Engelbach, unknown to me at the time I wrote the article, by virtue of his exhaustive study and publication, was considered to be the authority on the obelisk-quarrying mystery.

It was also pointed out to me that Stocks's material removal rates applied to flattening a piece of granite and were not quarrying rates. This seemed a slight quibble, for I had asked for material removal rates and did not specify quarrying or dressing/flattening granite. The limits of the tool indicated to me that whether we used the term *quarrying* or *flattening*, bringing a dolerite pounder down with full force onto

granite would yield the same results. The only difference might be an occasional check with a straight edge to inspect the flatness of the surface. Certainly, from my own experience using a dolerite pounder, there wasn't too much worry about overshooting a flat surface if an additional blow or two was taken before inspecting. Nonetheless, because Engelbach was not discussed in the article, it was considered incomplete and my calculations incorrect. Fortunately, I am now able to address that oversight.

Providing a reasonable conclusion that establishes an accurate length of time to quarry the obelisk using published information demands further field research and gathering of accurate information. For instance, the difference between Stocks's and Engelbach's material removal rates is so vast, it is impossible to reconcile. A fairly regular cadence for repeatedly pounding a stone ball against a hard surface would be about sixty times per minute, with the ball being lifted about 3 feet and brought down against the rock. This was about average for the beat I used in 2006. Using this beat, I could have accomplished the same flattening as Stocks—that is, flattening a small area of the granite. What is puzzling to me, though, and casts doubt on Engelbach's results, is that his material removal rate was stated to be 464.51 cubic centimeters/hour while Lehner's was 74.32 cubic centimeters/hour (my estimate of Lehner's based on his statements made on the *Nova* documentary) and Stocks's estimated 30 cubic centimeters/hour.

#### ENGELBACH'S EXPERIMENTAL RESULTS

Width of square	12 inches	30.48 centimeters
Depth of square	0.2 inch	0.5 centimeter
Hours worked	1	1
Cubic mass/hr removed	28.800	464.515
Weight of granite/cubic measure*	0.097 lb	0.0027 kg
Total weight of granite removed	2.794 lb	1.254 kg

\*Weight of granite = 168 lb/cu.ft.; 269 kg/cu.m

Engelbach had somehow managed to remove in an hour 6.25 times the amount of material than Lehner removed in his experiment—but he does not stop there. He speculates that the ancient Egyptians would have increased what he was able to do by 63 percent, which is ten times more than Lehner was able to accomplish.

#### ENGELBACH'S THEORIZED ANCIENT RESULTS

Square Width	12 inches	30.48 centimeters
Depth of Square	0.315 inch	0.8 centimeter
Hours worked	1	1
Cubic mass/hr removed*	45.360	743.224
Weight of granite/cubic measure	0.097 lb	0.0027 kg
Total weight of granite removed	4.400 lb	2.007 kg

\*Weight of granite = 168 lb/cu.ft; 2691 kg/cu.m

In Stocks's, Lehner's, and Engelbach's experiments listed in the tables above, there is uncertainty, and the difference between Engelbach's and Stocks's results is even more pronounced. Engelbach's material removal rate is fifteen times greater than that of Stocks—but then he ignored his own results and credited the ancient Egyptians with removing 63 percent more material than he had removed himself in the same period of time. If we consider what might be necessary to achieve this difference, we may say that Stocks was applying fifteen times less force than Engelbach in a given period of time. This would be equivalent to four blows a minute to Engelbach's sixty blows, or Engelbach's nine hundred blows to Stocks's sixty blows—which is impossible. Even the difference in the weight of the ball does not lead us to a satisfactory answer. If Engelbach's dolerite pounders were fifteen times bigger than those used by Stocks they would exceed the width of the channel. Besides, Engelbach told us that "these balls measure from 5 to 12 inches in diameter, their weights averaging 12 pounds."<sup>11</sup> Could it be that Engelbach was applying fifteen times more force on the granite than Stocks? Having hefted dolerite pounders within that range, and

having bashed them into granite repeatedly, I'd have to say no.

We also have Engelbach's unfounded speculation that the ancient Egyptians were able to remove 63 percent more material in an hour than he claimed to have removed, which would make their efforts twenty-five times greater than those of Stocks. Suffice it to say that there is more than enough reported variation in the material removal rate of granite by researchers that the whole idea of this method being used to quarry obelisks is fragile and subject to serious questioning.

Neither should it go without notice that in the back of Engelbach's mind was the translation of an inscription describing the time frame in which the ancient Egyptians had quarried, dressed, moved, and erected Hatshepsut's obelisk at Karnak, more than one hundred miles away. The inscription at the base of this obelisk is translated by Engelbach:

. . . so surely these two great obelisks, which My Majesty hath wrought with electrum for my father Amûn, that my name may abide in this temple eternally, are of one block of enduring granite, without seam or joining. . . . My Majesty exacted work thereon from the (regnal) year 15, the first of the sixth month (of the absolute year) until the year 16, the last day of the twelfth month, making seven months of exaction in the mountain.<sup>12</sup>

With his optimistic ancient quarrying rates, Engelbach gave 7.2 months for carving the channel and undercutting the obelisk in order for it to be separated from the bedrock. Yet he presents conflicting and confusing data when he addresses how the undercut could have been carved. He adds 40 inches for the horizontal undercutting of the Unfinished Obelisk, reaching a total of 205 inches, using that dimension as part of his calculation. He then states that "the undercutting would have taken at least as long again, even though it could be done from both sides at once."<sup>13</sup> From this I take it that the 40 inches were added to accommodate the quarryman, who, after reaching the total depth of 205 inches, had to work horizontally beneath the obelisk. Yet in making his calculations for Hatshepsut's obelisk, Engelbach writes:



Before leaving the subject of the time taken, let us apply the results obtained from my pounding experiments to the obelisk of Queen Hatshepsôwet at Karnak, of which the measurements are given on page 30 [given as base 7.9 ft pyramidion base 5.8 ft pyramidion height 9.7 ft. total height 97 ft. weight 323 tons]. To the base measure of 94 inches we must add, say 30 inches for undercutting, making a total depth required of 124 inches. Calculating in the same way as before, we find the time necessary would be 4.4 months, working twelve hours a day. For detaching it from below we may add a similar period, making 8.8 months.<sup>14</sup>

At 8.8 months, Engelbach's hypothetical quarrymen would already have exceeded the time it took for Hatshepsut's obelisk to be quarried, moved, and erected. Still ahead were the tasks of lifting the obelisk out of the quarry, finishing the surfaces to a near-perfect flatness, and sinking along the length of the four sides the deep, three-dimensional reliefs. Needless to say, the chasm appears to be widening between Engelbach's theoretical optimistic ancient Egyptian results and the historical timeline of the obelisk's creation.

Engelbach allows only 30 inches of extra depth for the quarrymen to work on the undercut, in contrast with 40 inches for the unfinished obelisk. Even then, he is using material removal rates that he assumed the ancient Egyptians achieved and which far exceeded his own results, which researchers that followed have been unable to qualify. I would agree that the ancient Egyptians could remove a greater amount of material in an hour than he could, but not using the tools that he proposed. The idea that stone balls were used to quarry granite obelisks, or any other granite artifact, not only has not been proved, but also the evidence to support the notion falls apart under scrutiny.

An additional difficulty not adequately addressed by either Engelbach or Lehner is that turning the work of bashing vertically onto the granite surface with a dolerite ball and working horizontally—working, in effect, without gravity's help—is far more difficult, dangerous and less efficient than working *with* gravity on a horizontal surface.

If we were to half the removal rate that Engelbach used to calculate the undercutting, we would still be performing the task more efficiently than Stocks or Lehner, who were applying force vertically. Such a claim that half the amount of material may be removed per hour when cutting underneath the obelisk as compared to the rate when cutting vertically alongside is not supportable, and to imagine the ancient Egyptians hammering away at the wall face with stone balls, stone axes, or any other kind of stone implements, and removing eleven times more adamantine granite an hour than Stocks removed is similarly unfounded.

There is a tendency to romanticize the abilities of the ancient Egyptians because they produced structures that were miraculous for their time and certainly would pose a serious challenge to ours. They were somehow immensely more talented with sticks and stones than modern researchers have been able to demonstrate using the same implements. When pondering the theories proffered by Egyptologists, one gets the impression that an ancient Egyptian quarry worker was like a maestro playing a complete symphony on a violin made of a cigar box and a stick and producing the quality of a Stradivarius.

The argument is pleasing and poetic, but the trouble is that, metaphorically speaking, when modern scholars make a violin from a cigar box and a stick, its results are precisely what you would expect from a cigar box and a stick. So the question persists: From what instruments did the symphonic architecture in ancient Egypt materialize?

For a manufacturer or a technologist, the subject is more cut and dried, and it resides in real-world engineering. The material removal rates of tools are known, and if a tool is capable of removing only a certain amount of material under certain conditions, the only efficiencies to be gained are organizational efficiencies in reducing the time spent to support the use of the tool. Estimating engineers do not take the material removal rate of a tool and quote a job that assumes a 63 percent increased removal rate. They will calculate the material removal rate and add time to their quotation for ancillary tasks that support its use. In the case of the standard Egyptian obelisk, the ancillary tasks are the removal of waste, taking breaks for drinking and eating, tending to

injuries, and periodically exchanging workers. To do otherwise would drive a company into bankruptcy. An engineer or construction superintendent would not look at the demands imposed by a granite obelisk on a worker with a dolerite pounder with any degree of optimism.

Yet we are still faced with a nagging question: if the ancient Egyptians did not use dolerite pounders, then what did they use? I have pondered this question both on site and during the intervening years. I believe we have to look closer at the quarry marks and ask ourselves if these are truly the marks left by a dolerite ball. For instance, in plate 18, we can see a long view of the trench with Dan Hamilton standing inside one of the test shafts. Figure 9.16, figure 9.17, and plate 18 pose questions that dolerite pounders do not answer.

What these photographs show is that the tool that cut the trench

Figure 9.16. Vertical cuts with horizontal striation down the north side of the obelisk





Figure 9.17. Test shaft with sharp inside corner near base of obelisk

left horizontal marks that are familiar to machinists and are consistent either with a tool that is drawn out of a hole and then reinserted to begin cutting again or with a tool that cuts while performing a horizontal sweeping motion, or both. Down the entire length of each scallop on the wall of the bedrock and the obelisk, we can see clearly these horizontal striations, and most of them are in line with each other (see figure 9.16). Other features that argue against the dolerite pounder theory are sharp inside corners in the test shafts as seen in figure 9.17 as well as the undercut area seen in plate 18, which are evident in the upper and lower left photographs. These sharp corners are clearly not the result of a 6-inch round ball.

Considering the implied efficiency in quarrying and delivering Hatshepsut's obelisk in seven months, the use of more advanced tools must be introduced into the equation. With what has been proposed so far, the job would quite simply not be done in time. In examining the

trench around the Unfinished Obelisk and especially the test shafts, which plunge through the granite up to 19 feet from the top of the obelisk, the introduction of mega-machinery does not seem out of place—except that there have been no machines found in the archaeological record.

A thorny question is now on the table: with dolerite pounders making their way back to the scrap heap where they belong, what kind of tools did the ancient Egyptians use to quarry their obelisks? The horizontal striations are typical in cutting when the feed of a tool that is removing material pauses along its path, withdrawn to remove waste, and the interruption of the tool leaves a mark on the surface. Also, it could be that as the tool was rocked back and forth against the walls of the trench to clear the waste on the vertical wall, horizontal striations appeared where the tool pressed the cutting surface against the side wall to keep the trench from narrowing.

The tool marks on the trench are most certainly not precision machining. However, machining may provide a clue in explaining the features found on this mysterious ancient work site. With this in mind, I provided a drawing to Don Reed, the supervisor of the tool room at Danville Metal Stamping, and asked him if he could machine some holes in a piece of aluminum—or any other suitable material. I provided him with a drawing of the hole placement (see figure 9.18) and asked that the tool be a ball end mill (depicted in figure 4.4 on p. 97 and figure 6.17 on p. 160). I didn't expect that the result would be identical to the marks left on the Unfinished Obelisk, as I was asking a skilled toolmaker to execute the work, being aware that when quarrying rock the toolmaker has no control over how his or her tools are being used or abused.

The results were presented to me by an excellent toolmaker, Doug Carter, and were what I expected of the geometry suggested in figure 9.18. Figure 9.19 illustrates the results, but indicates that more than likely the ancient Egyptians did not use a tool that rotated horizontally. The ball end mill certainly left radial impressions on the bottom of the cut as expected, but they are not the same as those at the bottom of the obelisk's channel. More than likely, the obelisk channel

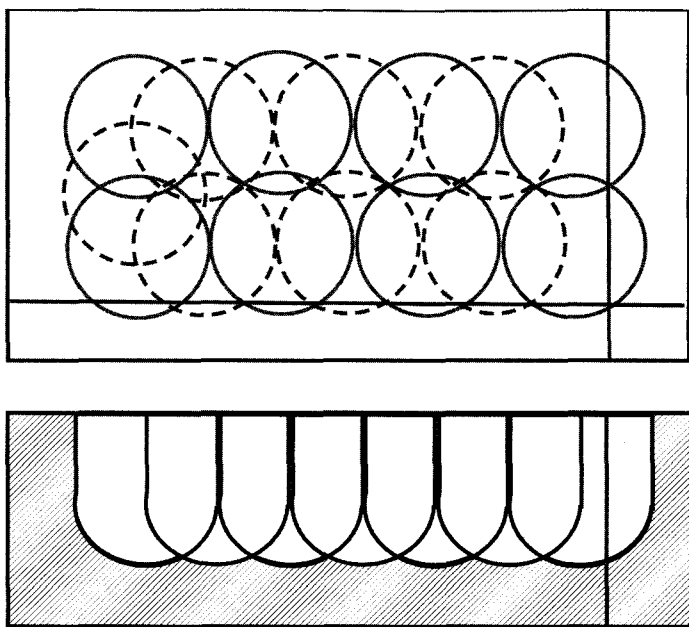

Figure 9.18. Drawing of drilling requirement in aluminum

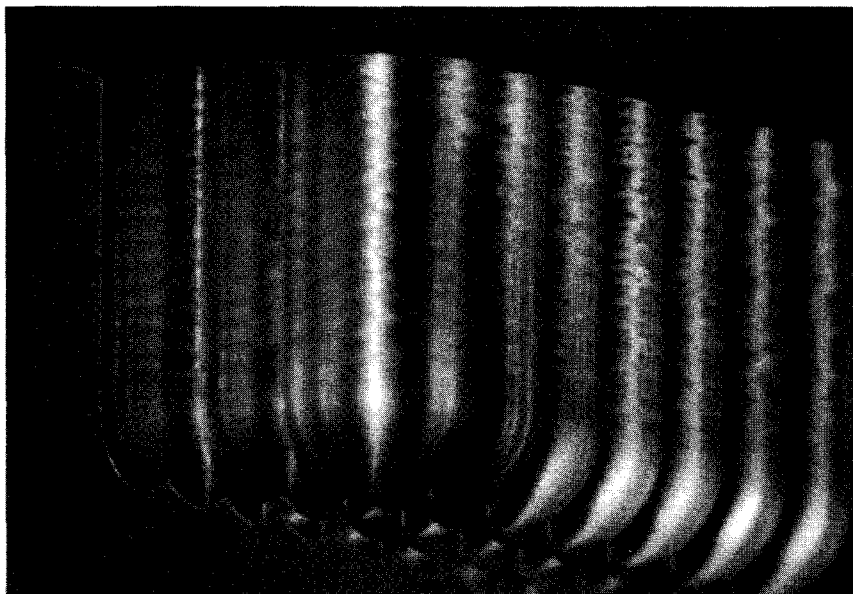

Figure 9.19. Tool marks with periodic horizontal striations

was cut using a tool that functioned similar to a chain saw, except it was much wider as the intention was to remove as much material as possible in an efficient manner. An idea of what such a machine might look like is seen in figure 9.20. Also, the horizontal striations on the aluminum were as expected, as these always appear when a tool is plunged into the material and is then removed for cleaning out waste, then reinserted in the hole to continue cutting.

However, there are indications that the machinery that plowed out the material around the obelisk was more versatile than the one shown in figure 9.20 and could actually cut around corners. Figure 9.21 provides evidence of undercutting that was made near the obelisk. Needless to say, this image fully discharges the dolerite ball theory and suggests either a more versatile machine than that depicted in figure 9.20, or another type of machine designed specifically for this kind of operation.

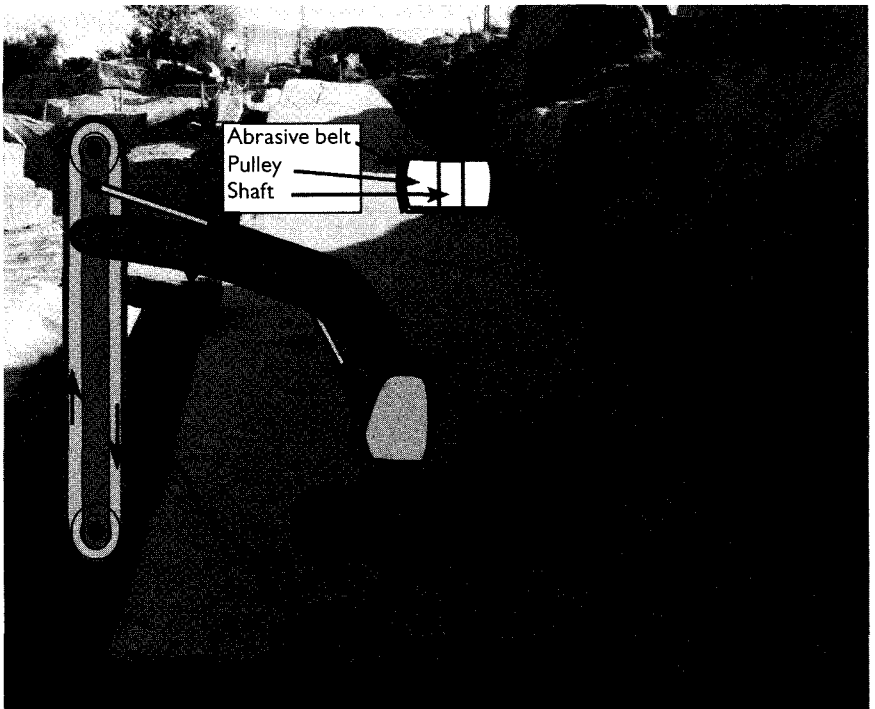

Figure 9.20. Theoretical equipment for trenching around the obelisk



Figure 9.21. Undercut near the unfinished obelisk (Courtesy of Patrice Pooyard)

There should be no doubt by now that the ancient Egyptians were exceedingly brilliant in their conception and execution of large-scale projects. But what powered the tool and how it was applied against the rock are questions that lead us to the real world of the ancient temple, statue, and obelisk builders. This was a world that engaged in engineering on a massive scale and building a civilization for millennia. Surely such a grand vision that allowed the ancient Egyptians to think in these terms also requires us to grant them the intelligence to have developed tools that are of a similar scale in their grandeur.

To suggest, however, that the ancient Egyptians used megamachines in prehistory is stretching the evidence to limits that are unacceptable to historians and Egyptologists. There have been no megamachines from the ancient past found in Egypt. Similarly, there have been no megamachines from prehistory found in Rome or Greece, though writings



about them exist and theories about what they might have looked like have been tested.

Is it too much of a leap to go from dolerite pounders to machines, without any intermediate technologies such as iron tools? If we consider everything found in Egypt in an engineering context and look at other evidence of megamachines in action, a picture emerges that provides momentum to make that leap. From the Unfinished Obelisk we are going to travel to the outskirts of Cairo to a site that is off the well-beaten tourist path. We are going to Abu Roash, the site of an unusual pyramid and a mysterious piece of granite that provides more clues to the immensity of scale upon which the ancient Egyptians applied their genius.



## 10

# In the Shadow of Egyptian Megamachines

*Heaven wheels above you, displaying to you her eternal  
glories, and still your eyes are on the ground.*

DANTE ALIGHIERI<sup>1</sup>

Immense in size and enigmatic in their design, the pyramids and temples of Egypt are a perennial source of speculation and wonder. They have challenged the minds of generations of engineers and scientists, who marvel at their construction and complexity of design.

In my discussions with fellow engineers over the years, there has been no disagreement that what was created in ancient Egypt is sophisticated in a way that would severely stretch even modern capabilities. In fact, when they visit Egypt, modern engineers, with modern tools and technology at their disposal, gape in awe at what the ancient Egyptians accomplished. Where are the answers to our questions about how such stonework was created? A prehistoric culture was empowered with a vision and genius to design and build pyramids and temples that are miracles of precisely tooled stone on a gargantuan scale. Surely they would not limit their genius to conceiving only the final product. It seems that such genius could influence the design and building of tools capable of producing works of such majesty.



Figure 10.1. View of the Giza Pyramids from the pyramid at Abu Roash

Academic historians may argue that modern engineers are overly influenced by their machines, thus all the Egyptians' works are interpreted through the prism of modern technology and there is little respect for the abilities and talents of the ancient Egyptians who, they believe, made do with simple tools. For their part, engineers argue that the ancient Egyptian toolbox accepted by scholars has no tools in it that are capable of producing what is found in Egypt, and that to advance our understanding of that time in prehistory, we must assign sensible and workable tools and methods that can physically demonstrate the capability to create such work. Experimental trials have already demonstrated the inadequacy of conventional understanding of technology used.

The artifact discussed in this chapter presents a challenge to modern engineers, for it cannot be produced using any of the methods proposed by conventional theorists. I first heard of the area where this artifact is located during a lecture by independent Egyptologist Stephen

Mehler, a passionate and enjoyable companion and presenter who brings almost forty years of research, both in the field and in the library, to his unique perspective on Egyptian history. More than any person I have met, Mehler respects the abilities of the ancient Egyptians, and he honors the ancient Egyptians and an Egyptian elder named Hakim (now deceased, may he rest in peace) in his books: *The Land of Osiris* and *From Light into Darkness: The Evolution of Religion in Ancient Egypt*.<sup>2</sup>

<sup>3</sup> In November 2004, we both shared our perspectives and findings during a conference and tour of Egypt. I was particularly intrigued by a part of Mehler's presentation that addressed the pyramid at Abu Roash (also spelled Abu Roashh, Abu Rowash, and Abū Ruwaysh). The site was not on the regular tourist venue, and even though it was only five miles away from the Mena House, where the presentation was given, I had no time left to visit the site. Besides, I did not expect to find incredible stonework there, because, from the photographs Stephen showed, there was not much left of the pyramid, and no sarcophagi, statues, or building blocks caught my eye. There are some researchers who argue that the pyramid was completely finished before being ravaged by forces of nature, and then was plundered by humans, but others believe that the pyramid was never finished—which I am inclined to believe. Its unfinished state was probably due to the same forces that halted the quarrying of the Unfinished Obelisk and brought the ancient civilization to a screeching halt.

The pyramid at Abu Roash is credited to Khufu's son, Djedefra, who chose a site five miles away from his father's pyramid—but for what reason? There are only speculations. Perhaps he was the black sheep of the family and had a greater ego than Khufu, so he wanted to be buried at a higher elevation. Who knows? Nonetheless, Mehler makes a cogent observation in his book *The Land of Osiris*.

The only evidence linking Djedefra to Abu Roash were the remains of a king's head carved in dark purple quartzite found in some rubble near the site. A cartouche found with the head had the title Djedefra, so it was then assumed this was an individual who had

the pyramid constructed for his tomb. Egyptologists state the style of the structure is a throwback to the 3rd Dynasty pyramids and is quite inferior compared to the Great Pyramid. The pyramid was built on a small hill and would only have been 190 feet tall if it had been completed, and is estimated to have been 348 feet to a side. When compared to the Great Pyramid which is 484 feet high (with capstone added, 454 feet high as it stands today) and 755 feet to a side, this pyramid would appear minuscule. Why would the son, having become king and with the same resource, material and manpower available to him as his father, have chosen to build such an inferior monument to himself?<sup>4</sup>

Two of three quartzite heads found during an excavation at the site in the early 1900s are in the Louvre Museum in Paris, and the third is in the Egyptian Museum in Cairo. All of the heads were assigned to Djedefra.

In 2006, I had the opportunity to visit Abu Roash after the Magical Egypt Tour with John Anthony West. Instead of traveling home after the tour, I checked into the Mövenpick Hotel to meet up with David Childress, Jennifer Childress, and Steve Zagata, who were visiting Cairo at the time. They were also intrigued by Abu Roash, and because David was the publisher of Stephen Mehler's book, he was aware of the site through Stephen's writings. On February 21, 2006, we hired a taxi and headed north on the Alexandria road to a mysterious place I had never visited before but was going to see merely out of curiosity, without any expectations of finding anything of significance.

After traveling a few miles along the road to Alexandria, our driver's Peugeot veered suddenly off the road and darted through a gap in a fence. This was not quite what I was expecting, but I hung onto my hat as the driver gunned the engine and the car started a rough and meandering climb up a hill with no sign of anything to indicate that this was a well-traveled road. Our driver had a talent for dodging the boulders that occasionally appeared on the path, and he had an air of confidence about him that indicated he had been here many times before.

As the taxi climbed the hill, we became level with a Ghaffir's hut

that was perched on the hillside. Running from the direction of the shack was a man wearing a galabeya and a smile. He approached the car and chatted with the taxi driver who told us that he was the guard for the site and would be expecting some baksheesh when we left. That seemed reasonable, so we went on and finally arrived at the summit to the north of what appeared to be a rough collection of blocks that resembled a mastaba. Surrounding the truncated and partially built—or partially destroyed—pyramid was a rough stone wall that was similar in construction to the Giza workers' village. The stones were made of very rough blocks that were arranged like crazy paving.

My first impression was that compared to Giza, it was as unimpressive a site as I had seen, and I didn't wonder why it was not on the list of sites that most tourists visit. This may change, however: the place has just recently received a revival of sorts and is being proclaimed "the Lost Pyramid" by Zahi Hawass. In walking around the pyramid, we came to the descending passageway (see figure 10.2), which eventually reaches a level where a large swath of material had been scooped out of the bedrock. Other passages, such as the descending passage in the Great Pyramid as well as the one in Khafre's pyramid at Giza and Sneferu's pyramids at Dahshur and Meidum, also lead to bedrock. The passage in the pyramid at Abu Roash is much wider—approximately 14 feet wider—than what is found in a finished pyramid (the Great Pyramid passageways being only 41 inches). This gives rise to the speculation that it was designed to allow passage of very large blocks that would be used in the construction of the chamber below where enough finished limestone to provide dimensions similar to those of other pyramids would be installed. The pit is open to the sky, so it could also be argued that the masonry could have been lowered from the top when the downward passage was completed. These are the conundrums that pyramids evoke—with no satisfying answers for those who may ruminate on them.

After I searched this planned bedrock chamber for significant evidence of stone cutting, I climbed to what served as the top of the pyramid in order to take in the view of the area. I was careful to stay away from the open pit because of the uneven surface, an abundance of loose



Figure 10.2. The descending passageway inside the pyramid at Abu Roash



Figure 10.3. Looking up to the top of the pyramid from the bottom of the pit



Figure 10.4. Starting the climb to the top of the pyramid



Figure 10.5. The pit from the top of the pyramid at Abu Roash



rubble, and trip hazards. Also, from the top of the pyramid is an uninterrupted view of the three major pyramids at Giza, which is always an attention grabber, no matter where you are located within sight. While it is tempting to look around and feast your eyes on your surroundings, in Egypt it is always recommended that you keep your eyes on the ground while walking in elevated places.

When I moved to the east side of the pyramid, I could see below some of the structures that are claimed to be associated with mortuary ceremonies. Unlike those at Giza, these are not constructed of megalithic blocks of stone, such as those in Khafre's temple, the Valley Temple, and the Sphinx Temple at Giza. Instead, they are cobbled together with small, rough blocks that could have been the tailings or chips from a limestone quarry, and they were plastered over with mud brick. It seemed clear to me that these structures were the product of a later culture and not the one that was responsible for building the pyramids at Giza or the one building the pyramid at Abu Roash.

Taking in more of the view, I saw a long gash in the ground running north to south between two rough stone walls, but, more important, an object in the forecourt closer to the pyramid below caught my eye (see plate 19). Though all around the site there are blocks of granite without any semblance of finish, unlike what we found at Giza, this lone block at Abu Roash was very different. As it turns out, it was different in a highly significant way.

A trip to the top of the Abu Roash pyramid is a brief excursion, for there is little to see once you have visited all four sides, and there are only a few steps between them. As I made my way down to the base of the pyramid, I was anxious to examine more closely what appeared from the top to be a finely finished surface on a block of granite—yet this block was unique beyond being the sole finished piece on the site. Upon approaching it, I could see that someone before had also seen some significance in it, because they had raised it up and placed it on rough blocks of stone. This was convenient for me, because it meant I didn't have to stoop as far to see it or wonder how thick the piece was if sand had gathered around it.

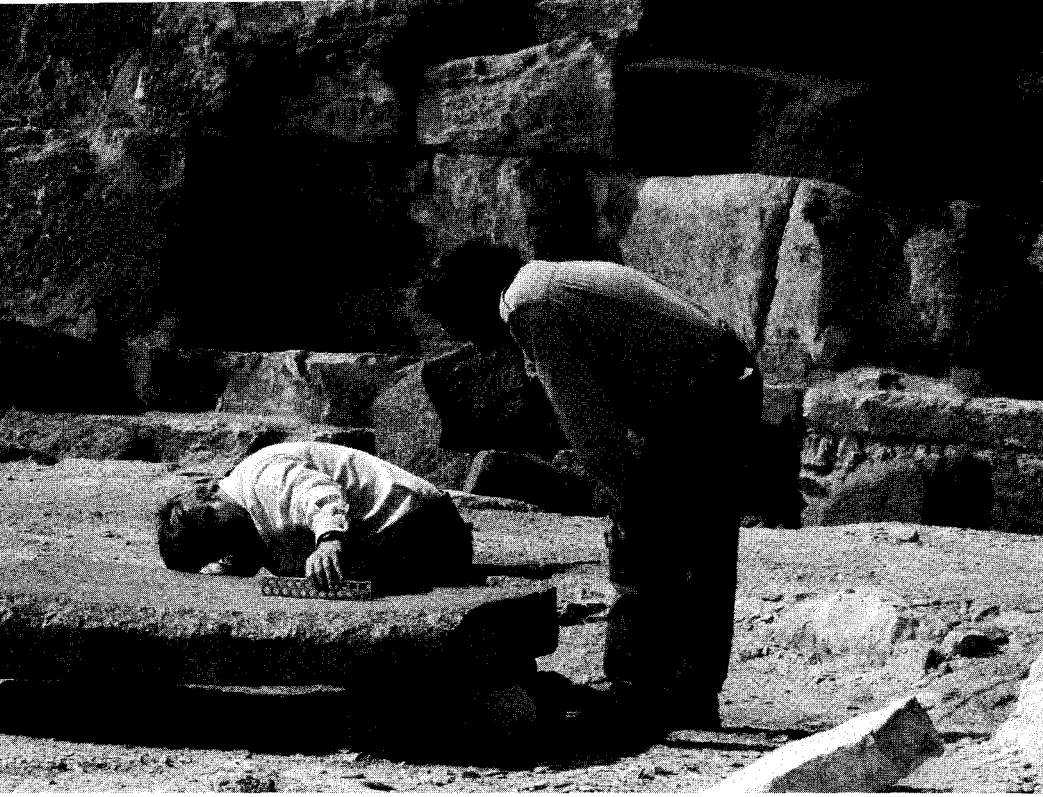

Figure 10.6 Chris Dunn and David Childress examine the granite block at Abu Roash.

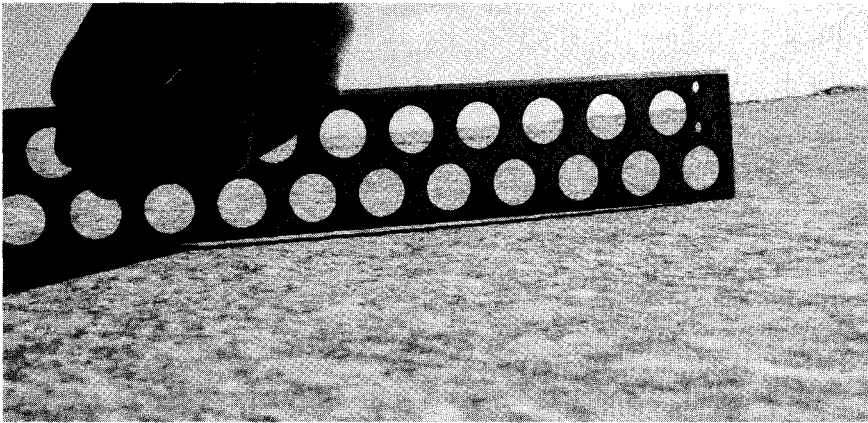

Figure 10.7. Concave surface of the granite block at Abu Roash

As it turns out, the finished surface I saw from the top of the pyramid was indeed a very smooth, seemingly machined surface—but it did not have the flatness of other machined blocks of granite I had inspected. The surface was actually concave. It was totally unexpected

to find a machined concave surface on a block of granite. After visiting numerous sites around Egypt, from Saqqara to Aswan, and measuring perfectly flat surfaces on granite artifacts, coming across one with a concave surface (see plate 20) that was fully exposed made me sit up and take notice, because it provided opportunities for examination that were not offered by the curved paving blocks near Khephren's pyramid.

Knowing that someone must have had knowledge of this stone in the past, it was imperative that I find out who may have taken note of these inexplicable features of the granite. I found the following obscure reference that while lacking in detail, may have been addressing this particular stone: "When Petrie investigated he found a curved fragment thought to be from a pink granite sarcophagus in the burial chamber and the French-Swiss team have recently found a copper axe blade which was part of a foundation deposit."<sup>5</sup>

We can see another inexplicable feature of this stone. The smooth concave surface (figure 10.8) ends in another concave radius where this block had evidently broken away from another block. I took some other photographs during my visit this day, but after looking closely at what I had when I arrived home, I realized that I needed better photographs in order to analyze the artifact properly. Nonetheless, the implications of the piece amazed me while at the same time giving me a better understanding of the ancient Egyptians' mastery of their craft than what is conveyed in tomb drawings, such as those shown in figures 10.9 and 10.10.

Nothing on this planet compares to ancient Egyptian stonework. It must be studied in the way that Dr. Peter Lu, of Yale University, studied ancient China. He concluded that the ancient Chinese must have used compound machines three thousand years ago. His research, published in *Science*,<sup>6</sup> is systematic, logical, and hard to refute.

He made this groundbreaking discovery while studying jade burial rings M1:7 from Tomb 1 of the Chu minister at Henan Xichuan Xiasi (552 BCE) that had been carefully inscribed with what appeared to be equally spaced spiral grooves. A simple camera and computer-aided design program were the tools with which Dr. Lu was able to draw his inference. Replication of the spirals was accomplished experimentally

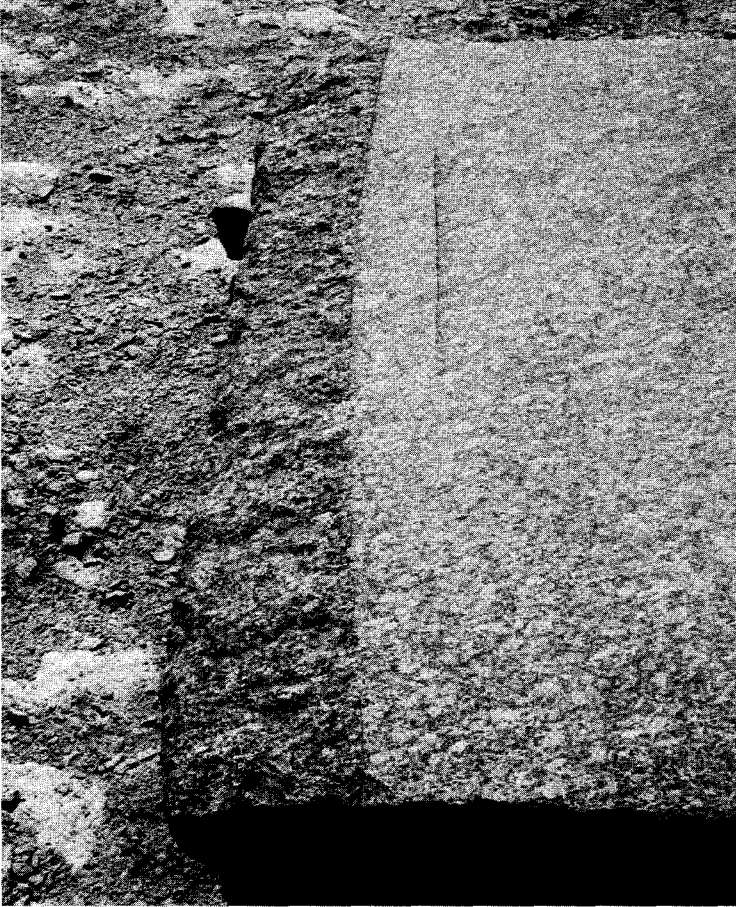
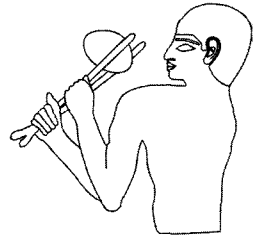

Figure 10.8. Radial features of the granite block at Abu Roash

by a mechanical scribing tool guided by precise linear and rotational motions.

If we apply the same methods as those of Dr. Lu, what would the stone at Abu Roash tell us about its origins and the tools that were employed to make it? After my visit in February 2006, I tried to imagine the kind of tool that created this piece and how it was applied. Because of the radial features, it became clear that only a large circular saw would have been able to create the two radii on this block. The question that nagged me, though, was what was the size of the saw? My photographs were not taken along the same axis as the radius, so any



Figures 10.9 (right) and 10.10 (below). Tomb drawings of Egyptian stoneworkers

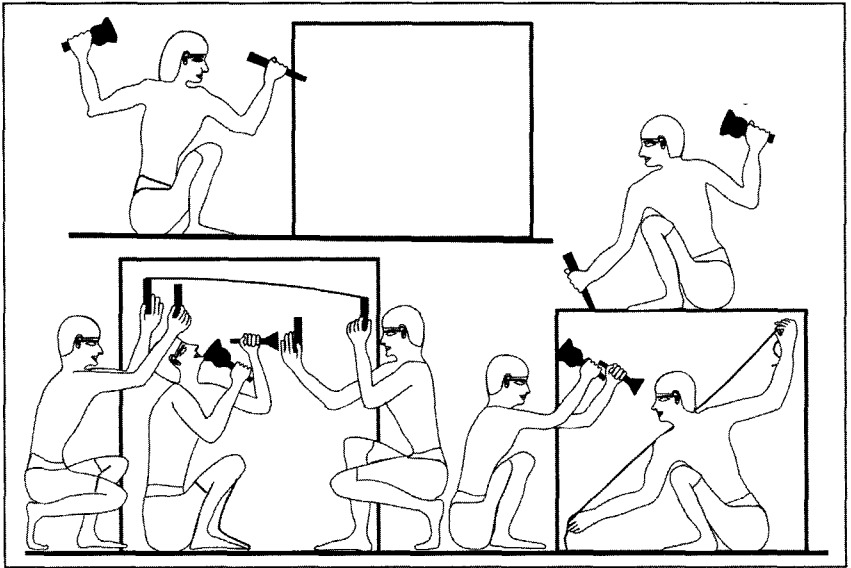

dimensions calculated from them would be wrong. A better set of photographs was necessary to accurately calculate the radius. Here again, I was affected by the same tantalizing and passionate need that was similar to how I felt after examining my photographs from Luxor and other sites: I had to gather more data.

Judd Peck and I traveled the same route to Abu Roash on May 4, 2006, that I had traveled in February—though this time with a different taxi driver. The routine, however, was the same: the friendly fellow from the shack came to us, we agreed to baksheesh, and we had the site to ourselves. This time, I packed a good tripod, a right-angle viewer, a remote shutter release, and a more versatile lens. Though I don't claim to be a professional photographer, I listened to their advice, which was to get good optics and electronics. The EOS Canon Digital Rebel was

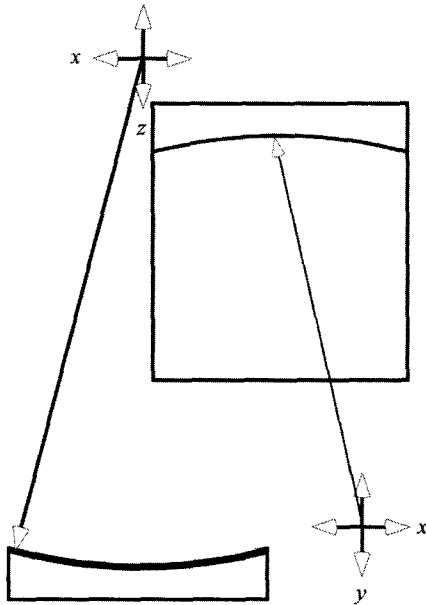

Figure 10.11. Drawing of the Abu Roash stone depicting the  $x$ ,  $y$ , and  $z$  axes

not the best camera on the market, but for what I was doing, it was good enough, and better lenses and electronics meant I didn't have to suffer the anomalies of a cheap digital camera.

I set up my tripod on top of the stone, and I was able to get a photograph close enough to the axis of the radius that ended the machined surface (plate 21 B and C), which I have identified as the  $z$  axis in figure 10.11. Then I took a photograph along the length of the block to get as close as I could to parallel the axis of the surface radius (plate 21 E), which I have identified as the  $y$  axis in figure 10.11. The concave surface radius rotates around the  $y$  axis and the concave radius where the cut terminates rotates around the  $z$  axis. Except for two surface irregularities at 12 inches and 37 inches, as seen in plate 21 B, the surface is true to the segment of a cylinder.

Looking closer at the surface of the block in figure 10.12, we can see striations that are spaced between approximately 0.030 inch (0.762 millimeter) to 0.06 inch (1.52 millimeters) apart. These are a common feature on many artifacts found in Egypt, including some holes and the

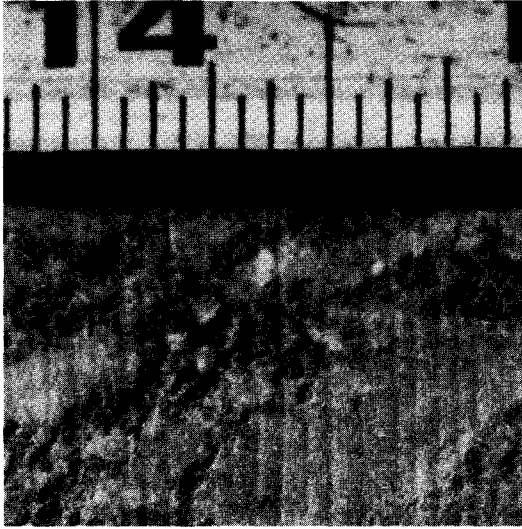

Figure 10.12. Close-up of surface showing saw-cut feed rate

cores that were extracted from the holes. With respect to the tools that created these marks, Petrie describes cutting with saws in his 1883 book, *The Pyramids and Temples of Gizeh*, and he concludes that the ancient Egyptians must have had cutting materials harder than quartz and that the marks were created through the action of a single cutting point:

We therefore need have no hesitation in allowing that the grav-  
ing out of lines in hard stones by jewel points, was a well-known  
art. And when we find on the surfaces of the saw-cuts in diorite,  
grooves as deep as  $\frac{1}{100}$  inch, it appears far more likely that such were  
produced by fixed jewel points in the saw, than by any fortuitous  
rubbing about of a loose powder. And when, further, it is seen that  
these deep grooves are almost always regular and uniform in depth  
and equidistant, their production by the successive of the jewel  
teeth of a saw appears to be beyond question. The best examples  
of equidistance are the specimens of basalt No. 4 (Pl. viii.), and of  
diorite No. 12; [see figure 10.13] in these the fluctuations are no  
more than such as always occur in the use of a saw by hand-power,  
whether worked in wood or in soft stone.<sup>7</sup>

The straight saws varied from .03 to 0.2 inch thick, according to the work; the largest were 8 feet or more in length, as the cuts run lengthways on the Great Pyramid coffer, which is 7 feet 6 in. long. The examples of saw cuts figured in Pl. xiv. [see figure 10.13] are as follow [sic]. No. 1, from the end of the Great Pyramid coffer of granite, showing where the saw cut was run too deep into the stuff twice over, and backed out again. No. 2, a piece of syenite, picked up at Memphis; showing cuts on four faces of it, and the breadth of the saw by a cut across the top of it. This probably was a waste piece from cutting out a statue in the rough. No. 3, a piece of basalt, showing a saw cut run askew, and abandoned, with the sawing dust and

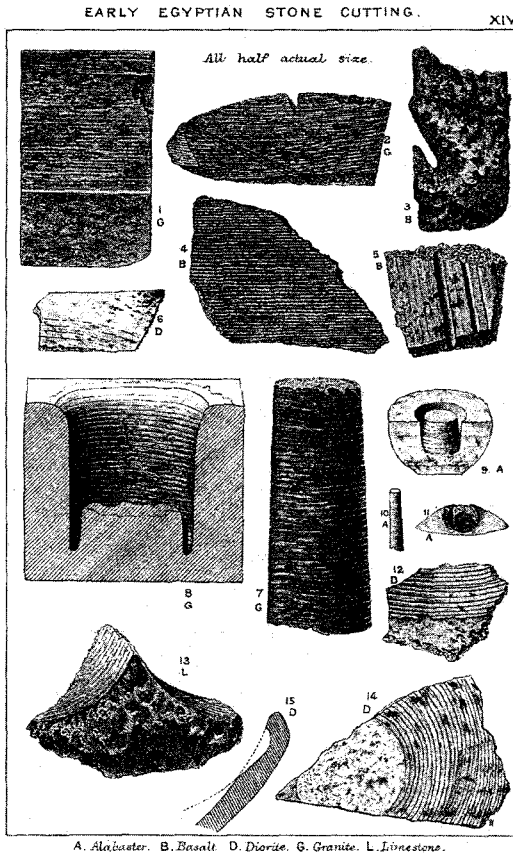

Figure 10.13. Plate xiii from *The Pyramids and Temples of Gizeh*



sand left in it; a fragment from the sawing of the great basalt pavement on the East of the Great Pyramid. No. 4, another piece from the same pavement, showing regular and well-defined lines. No. 5, a slice of basalt from the same place, sawn on both sides, and nearly sawn in two. No. 6, a slice of diorite bearing equidistant and regular grooves of circular arcs, parallel to one another; these grooves have been nearly polished out by crossed grinding, but still are visible. The only feasible explanation of this piece is that it was produced by a *circular saw* [author's italicized emphasis]. The main examples of sawing at Gizeh are the blocks of the great basalt pavement, and the coffers of the Great, Second, and Third Pyramids, the latter, unhappily, now lost.<sup>8</sup>

Because most of the literature discussing the sawing of blocks is centered on the Giza Plateau, we will leave Abu Roash for a while and travel to Giza to examine the basalt pavement to the east of the Great Pyramid that Petrie had examined. Taking an overall view of the pavement, we can see that many of the tool marks would not even be noticed if we were not looking for them or were not familiar with these types of surfaces. In fact, an afternoon spent studying the pavement will confirm the fact that most tourists who visit the pyramids pass it by without even a second look. The majority of the surfaces on the top and side are rough—presumed by some theorists to have been dressed with a hammer. The bottoms were not important to the builders, for they set the blocks like tiles in gypsum mortar, and we can see the rough contours of the underside of the paving blocks embedded in this material.

I had been able to take many photographs of this pavement, and while Petrie discusses three examples from the basalt pavement in his book, there are more than a dozen blocks in this pavement with all manner of saw marks. Some appear to be straight and others are curved, similar to those on the block at Abu Roash. The saw marks appear distinct and vary in pitch very little with each striation, for the most part, following a uniform path from one end to the other.

As we can see on figure 10.15 A, the width of the saw cuts on

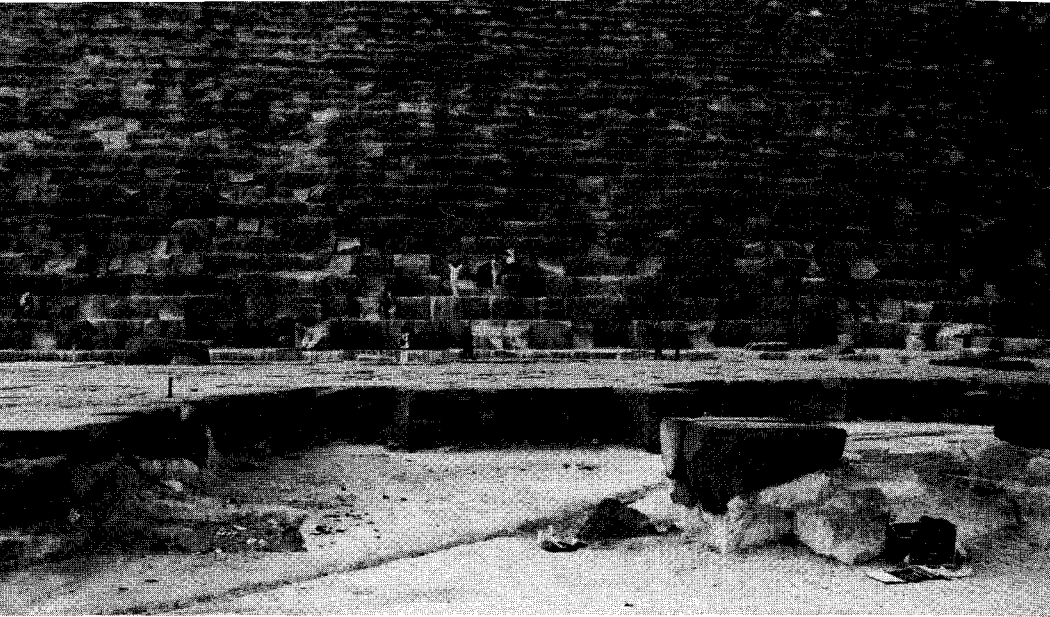

Figure 10.14. The basalt pavement east of the Great Pyramid

the basalt pavement are approximately 0.23 inch (6 millimeters). The striations in figure 10.15 B (seen with the northeast side of the Great Pyramid in the background) and C give photographic evidence of those that Petrie discussed in his book. Other blocks have more unusual features, and there is no easy conclusion as to how they were created. For instance, in figure 10.16, we see evidence of saw marks that appear to be radial, judging by the termination of the cut.

It appears that the piece was cut in two stages. As we can see in figures 10.16 A and B, there is a regular long cut across the piece with the evidence of a step where either the saw was moved or the piece moved—it is impossible to tell which as either scenario could cause this effect. Toward the end of the right side of the piece, however, it appears that a circular saw cut farther down from where the long cut (area L) would normally have ended, and figure 10.16 C shows the striations gradually changing their angle until the termination point is met—that termination point appearing to be a concave radius (area M). Yet figure 10.16 B does not indicate a radius at the termination point, and we might conclude that a view of the piece on an angle that sees a straight cut only on a curved face would produce this geometry. When we look down on the piece in figure 10.16 A, however—albeit this is not quite a vertical

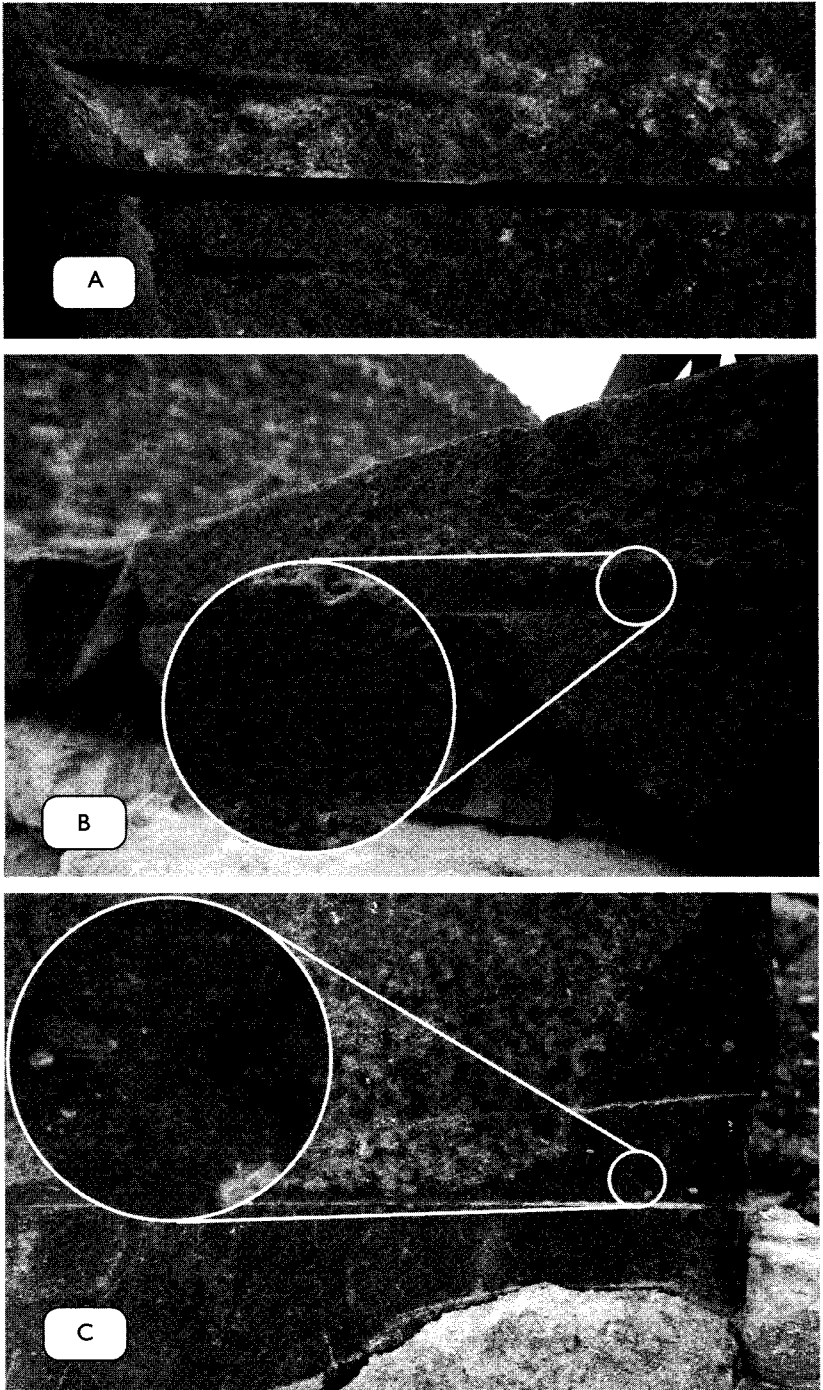

Figure 10.15. Collection of photographs from the basalt pavement near the Great Pyramid

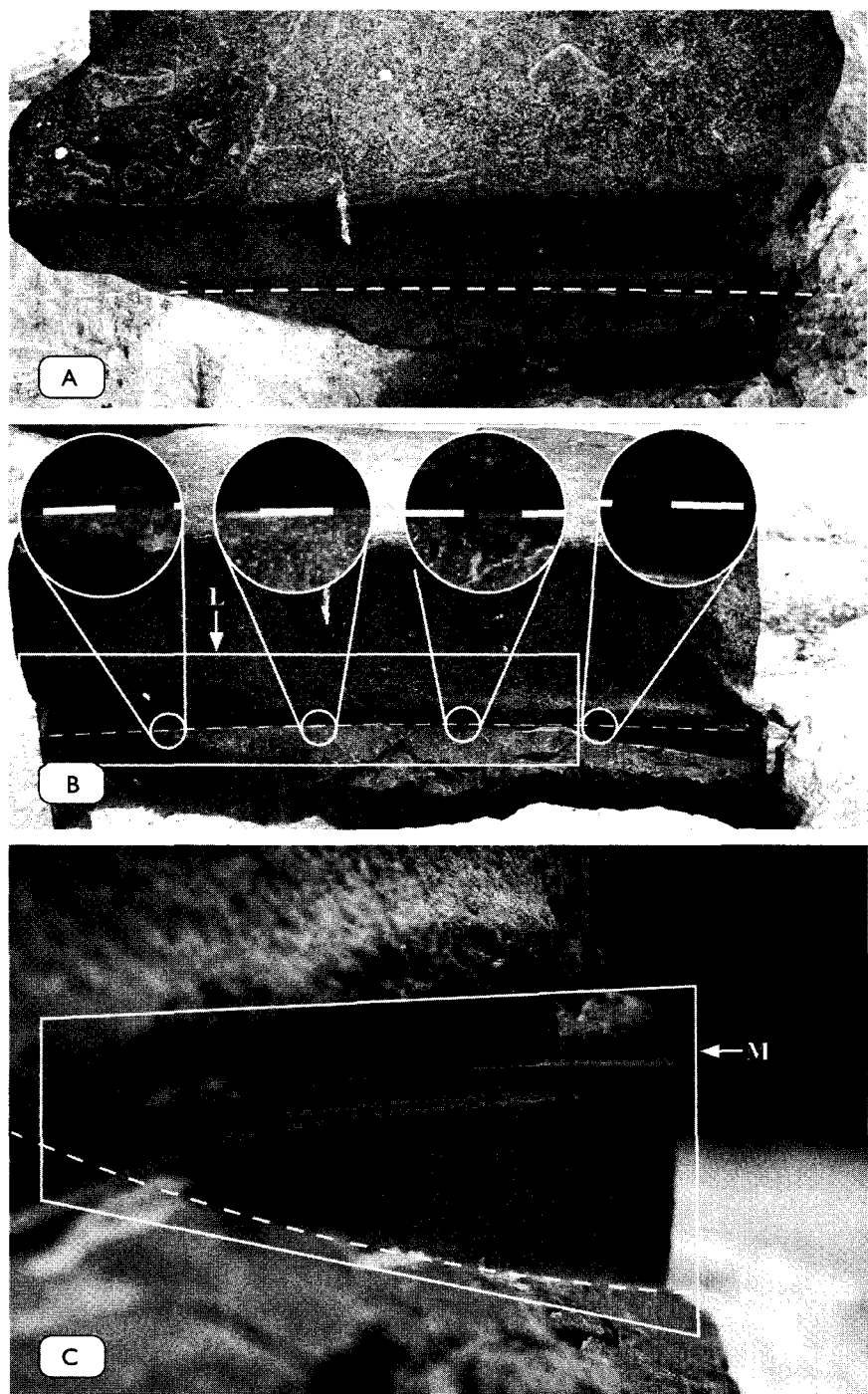

Figure 10.16. Three images of the same basalt pavement block east of the Great Pyramid

perspective—the curve of the face does not appear significant enough to create such an effect.

Notwithstanding the appearance of a radial cut, the use of circular saws when cutting these basalt blocks is dismissed by Robert G. Moores Jr. In an article titled “Evidence for Use of a Stone-Cutting Drag Saw by the Fourth Dynasty Egyptians,” Moores writes, “The cut grooves could not have been produced by a rotating blade such as found on a circular saw. A rotating blade does not make scratches of variable radius. Even if the blade was four meters in diameter we would expect to see a pattern of circular scratches across the cut face of two meters radius, but this is not the case.”<sup>9</sup>

Moores describes the striations on blocks of basalt as having “. . . essentially-parallel grooves up to a half millimeter [.02 inch] deep, spaced about one to two millimeters [0.039–0.078 inch] apart. In cross section the grooved face would approximate a sine curve, with the valleys being slightly narrower than the lands between.”<sup>10</sup>

There are numerous examples of plunge cuts, where a saw left a slot

Figure 10.17. Striated block of basalt on the Giza Plateau

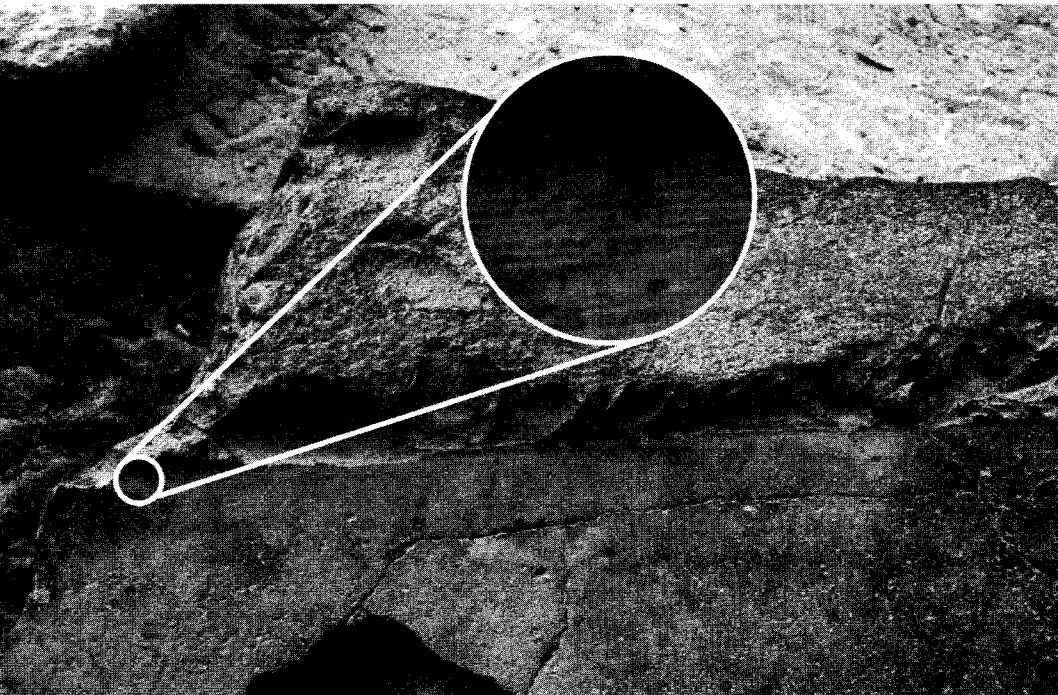

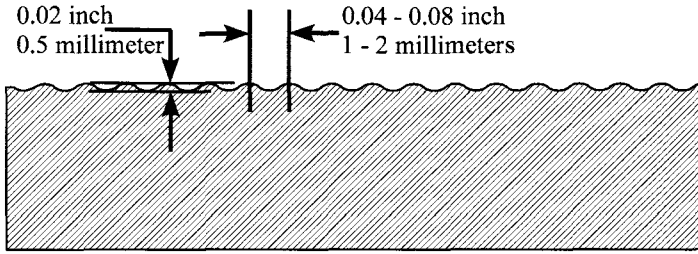

Figure 10.18. The sine curve addressed by Moores

in the basalt. Figure 10.16 and figure 10.20 show these types of cuts. The example Moores gives in his article shows the same cut but on a different block. On a block he identifies as block A, he measured the width of the cut where the saw ended and reported it to be 0.118 inch (3 millimeters; see figure 10.21). He notes: “In cross section, the kerf, i.e., narrow slot that the blade makes while cutting, has, by eye, a perfectly radiused bottom, about three millimeters wide, that tapers outward with an included angle of about eight degrees, (fig. 6.) [see figure 10.21]. The kerf sides are very smooth—not striated.”<sup>11</sup> Moores’s observations regarding the perfect radius and smooth sides are important to remember as we discuss his proposed methods of manufacture.

Without going back in time and talking to the pyramid builder, it is impossible to explain every anomalous action that created the complex variety of evidence on the basalt pavement. Considering that the now-exposed blocks that reveal these saw cuts were originally covered by adjacent blocks, it is not unreasonable to speculate that the sawed parts of the blocks were given a quick shave in order to remove irregularities that were inherent in the quarrying process and were holding one block apart from its neighbor. If we consider the overall roughness of the blocks, this quick shave was more than likely given by the only tools available on the site, and they were the tools used for finishing and cutting to size all of the blocks that went into building the pyramid. It is well known that these blocks are extremely precise in their cutting, especially those that make up the walls of the inner chambers and also the casing blocks—assuming they were all of the same exactness as the

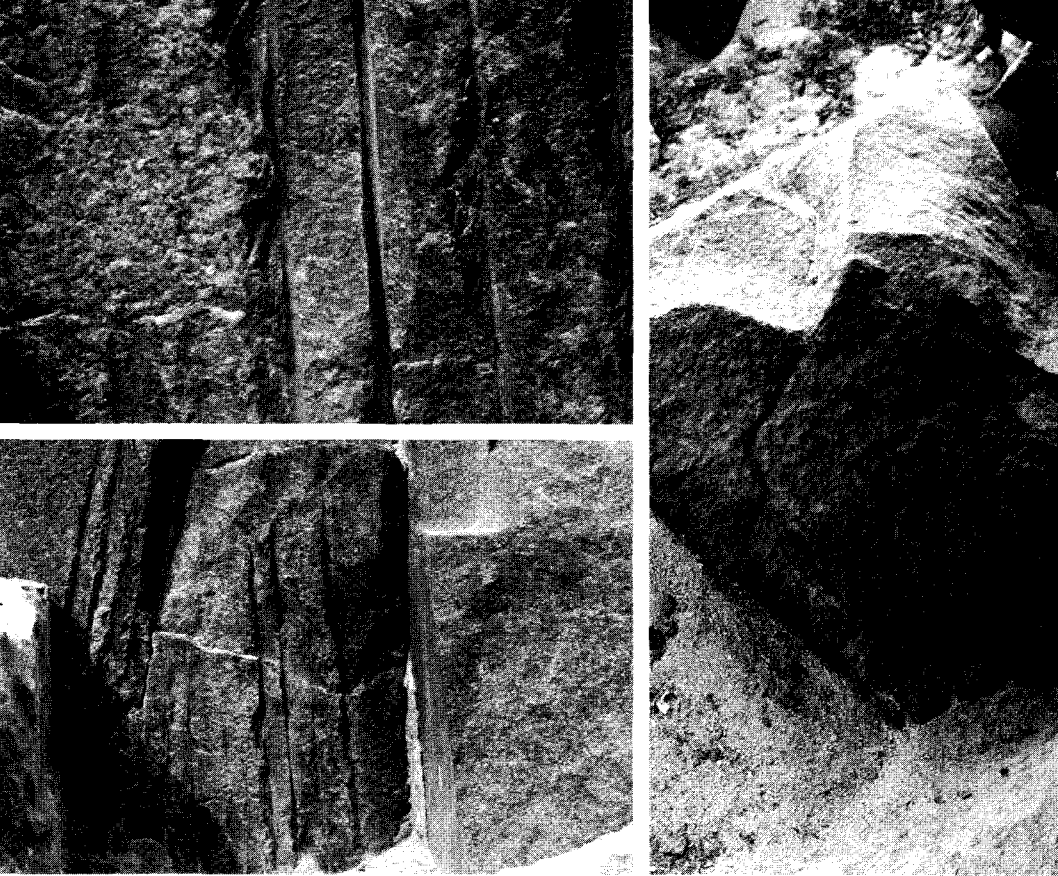

Figure 10.19. Slots sawed into basalt blocks



Figure 10.20. Sawed basalt (identified as block A by Moores)

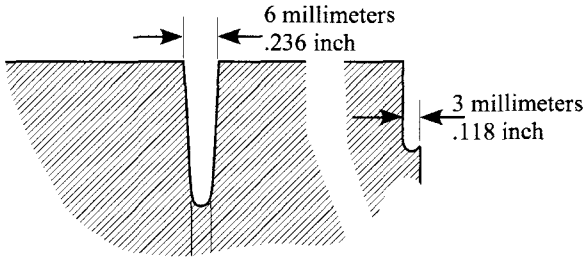

Figure 10.21. Cross section of slot. Drawing by C. Dunn after Moores's figure 6.<sup>12</sup>

few that survive. It could be argued, therefore, that the roughing tools were not on the plateau, but were applied elsewhere.

The quick shave proposed by Moores involved the use of a drag saw. The device, Moores admits, "... [i]s somewhat more advanced than general views of the pyramid builders' technology level now held."<sup>13</sup> In this respect, Moores pushed the envelope of Egyptological thinking. But did he go far enough? Figure 10.22 shows Moores's concept of how the marks on the basalt were made.

Moores proposes a blade made of copper with a notched leading edge. The blade was 157 inches (4 meters) long and 23.6 inches (60 centimeters) broad and was wedge-shaped from 0.393 inch (1 centimeter) at the top to 0.118 inch (3 millimeters) at the cutting edge. Moores estimates the weight of the blade was 308 pounds (140 kilograms). Quartz

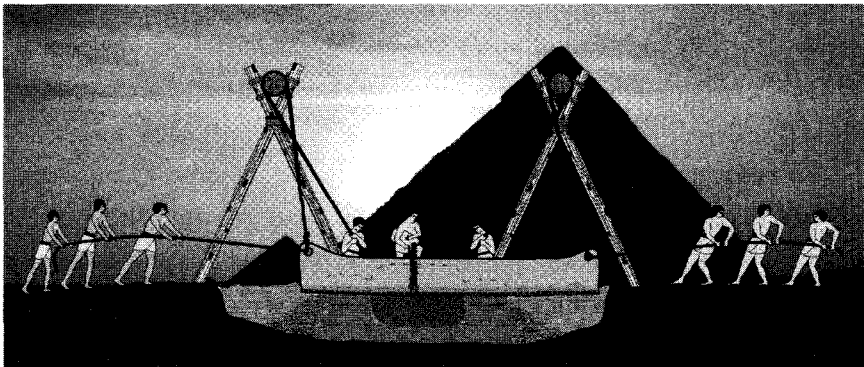

Figure 10.22. Moores's concept of the pyramid builders' drag saw. Drawing by C. Dunn after Moores's figure 11.<sup>14</sup>



sand was used in the process as an abrasive. It was rubbed against the basalt both as a loose medium and also, by quartz sand that was embedded into the copper. This process, with fresh sand being added to the cut as used sand and sawed rock was flushed away, impressed the shape of the blade into the basalt.

As we see in figure 10.22, a team of workers dragged a blade across a block that was fixed inside a trench filled with water. The blade was suspended on ropes that were controlled by workers, who, according to Moores, managed the blade's incremental descent into the basalt.

Using the cadence of a 78.7-inch (2-meter) pendulum, Moores calculates that the blade swung from one side to the other in approximately 2.84 seconds. Using the distance between the striations of 0.039 inch (1 millimeter), Moores then calculates that in one cycle, (two strokes, one in each direction) the saw plowed into the basalt 0.078 inch (2 millimeters). Using the physics of the pendulum, he then calculates that in one minute, the saw could have cut through 1.653 inches (42 millimeters) of basalt.<sup>15</sup>

These are extremely positive outcomes and do not seem to satisfy all questions that could be raised about the practicality of Moores's solution. It is hard to imagine the successful employment of the physics of a pendulum on a swinging 308-pound object that ultimately is met with a hard, solid surface covered in sand. It is also hard to imagine a 308-pound blade slicing through basalt at a rate of 1.653 inches (42 millimeters) per minute. If we take into consideration the fact that the blade is wedge-shaped, which would mean its increasing width would impede its progress into the slot, the impossibility of the operation becomes more evident.

Fortunately, information has been published on experiments using saw blades made of copper plus quartz sand to cut granite. These experiments were carried out by Denys Stocks in March 1999 at a quarry in Aswan using a 32-pound (14.5-kilogram) copper saw blade that was 5.9 feet (1.8 meters) long, 5.9 inches (15 centimeters) deep, and 0.236 inch (6 millimeters) thick. The blade was weighted down with four stones on each end, for approximately 99.2 pounds (45 kilograms). Stocks provides

sawing rates that are significantly less than those calculated by Moores. Using wet sand, Stocks was able to cut a 2.46-foot (75-centimeter) slot in granite to a depth of 3.149 inches (8 centimeters) in 30 hours. This calculates to 0.105 inch (0.267 centimeters) per hour cutting rate and a volume of stone removal that is 360 cubic centimeters (a rate of 12 cubic centimeters per hour). Stocks experimented using dry sand, and he cut a 3.117-foot (95-centimeter) slot to a depth of 1.181 inches (3 centimeters) in 14 hours, which calculates to 0.084 inch (0.214 centimeter) per hour, and a stone removal weight of 170 cubic centimeters or 12 cubic centimeters per hour.<sup>16</sup> He reports the total weight of copper used to achieve these results as 459 grams in 14 hours, which would be 33 grams in one hour.

Stocks's experiments show that a hand-powered saw advanced into the granite more slowly over a long cut than a short cut, but the rate of material removal was almost the same. If we apply Stocks's data to determine how long it would take to saw the six sides of the granite box in Khafre's pyramid, it would take approximately 6,270 hours<sup>17</sup> (see box on p. 272 for details). The total hours given are conservative estimates and do not take into account additional widening of the saw-cut, which Stocks measured to be 2.5 centimeters at the top and 6 millimeters at the bottom (emphasis added by author for clarity).<sup>18</sup>

It is impossible to reconcile Stocks's experimental results with Moores's hypothetical results using a drag saw. In pondering the results of Moores's proposed sawing rate of 1.653 inches (42 millimeters) per minute (2,520 millimeters per hour) compared to Stocks's experimental sawing rate of 2.14 millimeters per hour, we should take into account how modern saws perform when cutting granite. United States Patent 7082939, filed in 2003, describes an improved frame saw using carbon alloy steel blades with replaceable segments that are impregnated with diamonds. The patent cites a down-feed rate in granite of 30 millimeters per hour.<sup>19</sup>

These modern rates are 14 times greater than those achieved by Stocks, which is not surprising, but 84 times *less* than Moores's proposed rates. Considering the operating conditions, Stocks's rates make

**COMPUTATION OF APPROXIMATE HOURS TO SAW  
GRANITE BOX IN KHAFRE'S PYRAMID**

<b>Basic Measurements</b>	
Stocks's length of saw-cut	95
Stocks's depth of saw-cut	3
Square centimeters	285
Hours worked	14
Square centimeters per hour*	20.36

\*Added by author

<b>Granite Box in Khafre's Pyramid*</b>		
<b>Top + Bottom</b>	<b>East + West</b>	<b>North + South</b>
Box length, 263.35	Box length, 263.35	Box width, 106.4
Box width, 106.4	Box height, 96.82	Box height, 96.82
Square centimeters, 28,020.44	Square centimeters, 25,498.81	Square centimeters, 10,302.16
<b>Total, 56,040.88</b>	<b>Total, 50,997.62</b>	<b>Total, 20,604.32</b>

\*Dimensions given by Petrie converted to centimeters by author.

<b>Totals</b>	
Total square centimeters of Khafre's box	127,642.8
Stocks's square centimeters	20.36
<b>Total hours for box</b>	<b>6,270.22</b>

sense, while Moores's hypothetical sawing rates once again seem impossible using the equipment he proposes. However, Moores does point out that his results are the maximum achievable using the cadence of a pendulum and recognizes that the hardness of the rock and friction could slow the process down. The capabilities of modern saws prove that Moores is correct in this one statement, which occupies the space of only one sentence in his article.<sup>20</sup>

Before we return to Abu Roash, we must resolve the difference between Petrie's observations and Moores's with respect to the use of circular saws. The evidence Moores was looking at would certainly point to the use of straight saws. Yet there are other blocks on the pavement that pose a problem to the notion of the exclusive use of straight saws.

As we survey the area of the pavement, we see the marks of ancient tools that will appear to change geometry as our point of view changes. To understand what is happening, we can look at figure 10.23, which gives three examples of saw cuts on two different types of surfaces. Block A has a straight cut on a flat surface. This kind of cut will always look straight, regardless of any variation in the viewing angle. Block B has a curved cut on a flat surface. The radius of the curve will appear to shorten as the block is rotated down, or lengthen if the block is rotated up. Block C has a straight cut on a curved surface. We see that the straight cut of C-1 is curved in the  $z$  axis, looking perpendicular from the top ( $y$  axis), but a radius of varying size is seen depending on the viewing angle, see C-2 and C-3. Views from the side will also exhibit varying sizes of radii. If we use the radius of C and create a full circle, then the views seen in C-2 and C-3 are actually sections of an ellipse. An ellipse in a unique manufacturing process will be discussed further when we return to the granite stone at Abu Roash.

While the apparent curvature of the block seen in figure 10.16

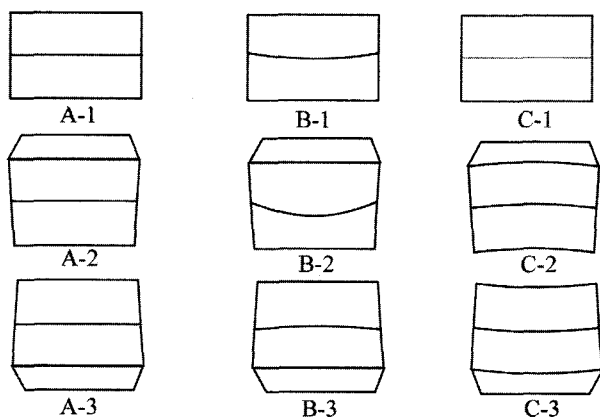

Figure 10.23. The geometry of a flat and radial saw cut on a flat or radial surface

(p. 265) is too ambiguous to provide a solid conclusion, another block lies a short distance away from the pavement and would go unnoticed by the casual traveler unless he or she stumbled over it. That block can't be explained by the use of straight saws, because the surface is curved in a way that would eliminate the random arching of a blade or any amount of uncontrolled meandering by a shaky operator.

Figure 10.24 contains three views of this basalt block that when viewed from the side at an angle, the saw cut seen in figure 10.24 A ends with a radius. Without examining the block further, it could be argued that a hand-operated straight saw created the cut, and that the operators of the saw did not keep the saw straight as it moved through the cut, but instead allowed it to drift up and down. This is a common occurrence and, in fact, achieving a perfectly straight cut with a hand-powered saw is almost impossible. Fully impossible is the achievement of a concave radius for the obvious reason that it is physically impossible to create a saw cut where the entrance and exit points are higher than the middle with a flat-edged straight saw. Some may argue that the saw could bend and create this condition, and indeed they are more than welcome to prove their claim. Stocks did not observe this condition during his experiments and neither have I during my experience working with handsaws that were thinner than Stocks's.

If we look at figure 10.24 B, which is a view of the front of the cut surface, the striations are clear, but the radius where the cut ends is larger from this angle. The reason for this is explained in figure 10.24 C, in which we are looking at the surface from the top. It is clear from this angle that the entire surface is curved. It is possible, therefore, that the geometry of this block is the same as the example shown in figure 10.23 C-1, C-2, and C-3, in which a surface was cut on a radius and the tool that cut the radius left a step that was straight when viewed straight on, though it appeared curved if viewed on an angle, such as when viewed from two angles, to the side and from above, such as the view in figure 10.24 A. The radius appears smaller than B and C, which indicates that the cut surface is curved and not flat. Along with Petrie's testimony to the use of circular saws at Giza, what we can gain from

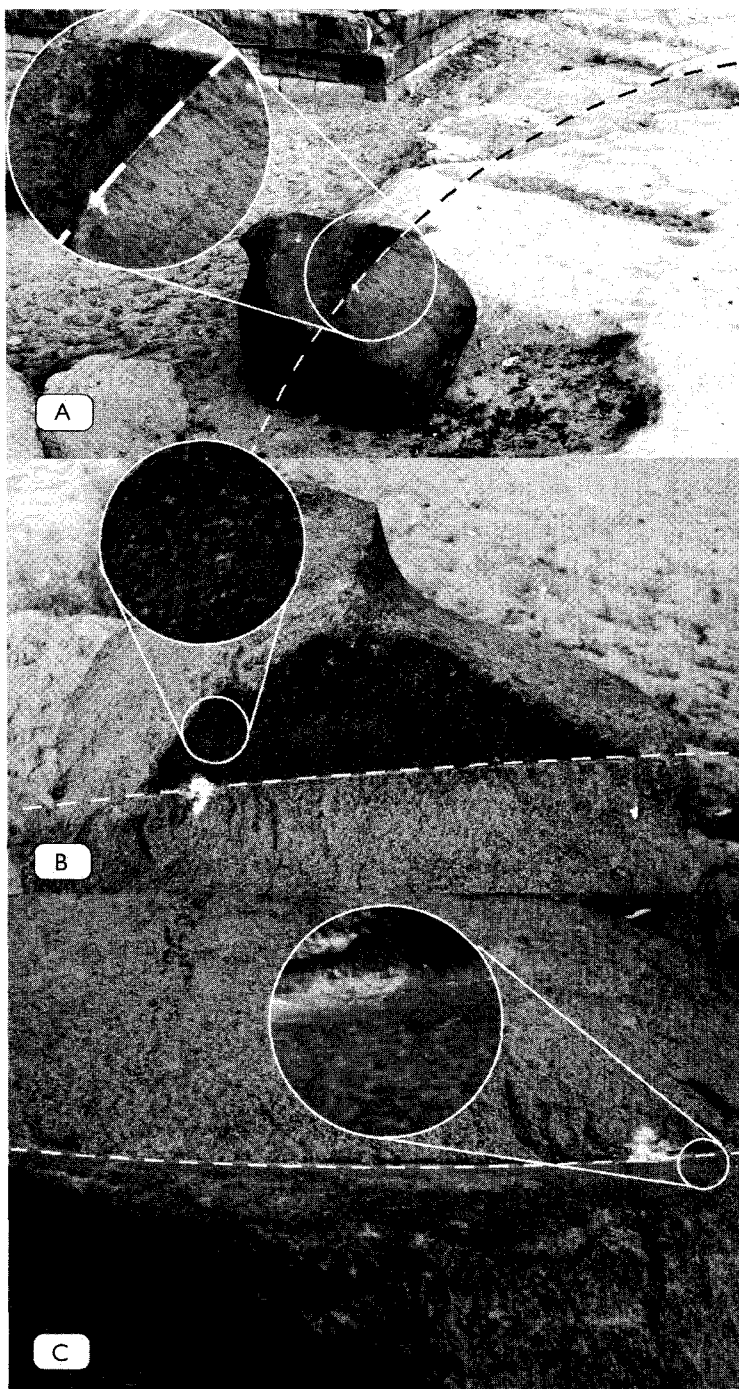

Figure 10.24. Evidence of circular cutting tools on the Giza Plateau

this block is further evidence that efficient circular tools were used on the Giza Plateau, though we are still left to wonder about what they looked like, how they were driven, and from what material they were made.

As discussed earlier, Moores's observation of the root of one of the saw cuts he examined (see figures 10.19, 10.20, and 10.21 on pages 268 and 269) describes the bottom of the saw cut as being a perfect and smooth radius. Of his experiment in sawing granite at Aswan, however, Stocks notes that, "[a]s before, similar parallel striations were visible on the sides and the bottom of the slot."<sup>21</sup> This seems to be in conflict with the evidence noted by Moores on the Giza Plateau. Unfortunately, we have nothing to compare how similar Stocks's striations are with ancient saw cuts because in his article, Stocks does not provide a thorough comparative analysis with photographic proofs.

The Giza Plateau provides further evidence for the use of circular saws, but first the stone at Abu Roash demands more attention: though the marks on the basalt blocks at Giza indicate the use of circular saws, the striations left on them are different from those on the granite block at Abu Roash. Though the ones at Giza appear to follow straight or curved lines, the striations on the stone at Abu Roash drift from side to side from similar theoretical lines. As seen in figure 10.25, the striations wander slightly from a true straight or curved path, but, inexplicably, each of the striations wanders in the same direction as its neighbor and follows a parallel path. This does not support the view that abrasive slurry was at work to create these marks. It seems to be powerful evidence that fixed cutting points that are set into a rotating cutting tool were acting on the surface. Why, then, were the lines wandering from a true path? A possible explanation for these striations is that there was some wobble in the saw as it moved across the granite. Yet other characteristics of the piece seem to pose more questions.

The radius where the cut surface terminates is puzzling when we consider different ways in which the block may have been made. Often in the dark early hours of the morning, I came up with numerous methods for cutting this piece, but each of them failed to provide a practical solution. One suggestion made to me was that the blade that cut the

piece was a straight saw but that it was warped and cut the curve on the stone face. If that were possible, it would explain one radius on the block, but whether you view the block from above, or along its length, you see a radius. When considering this and pondering on how this inexplicable geometry was cut into the granite, the straight saw has to be eliminated, because it would be impossible for it to cut a concave radius along its face and along its edge. Another suggestion given to me was that the stone was cut by a stone ball swinging from a pivot point. Yet the evidence suggests a far greater amount of control and certainty than that of a swinging ball—regardless of the skill put into the swing.

I tried to imagine a process in which the piece would be cut in one single sawing operation, but I could not come up with a method that did not demand more out of the tool than was possible due to an increase in surface area being cut. In other words, assuming a larger block was being cut along the striated surface with the saw on an angle, depending on the thickness of the entire block, the thin block, which is the one we are studying, would break apart from the thicker one. But passing the stone across the saw on an angle would result in an increase in

Figure 10.25. Striations on the stone at Abu Roash

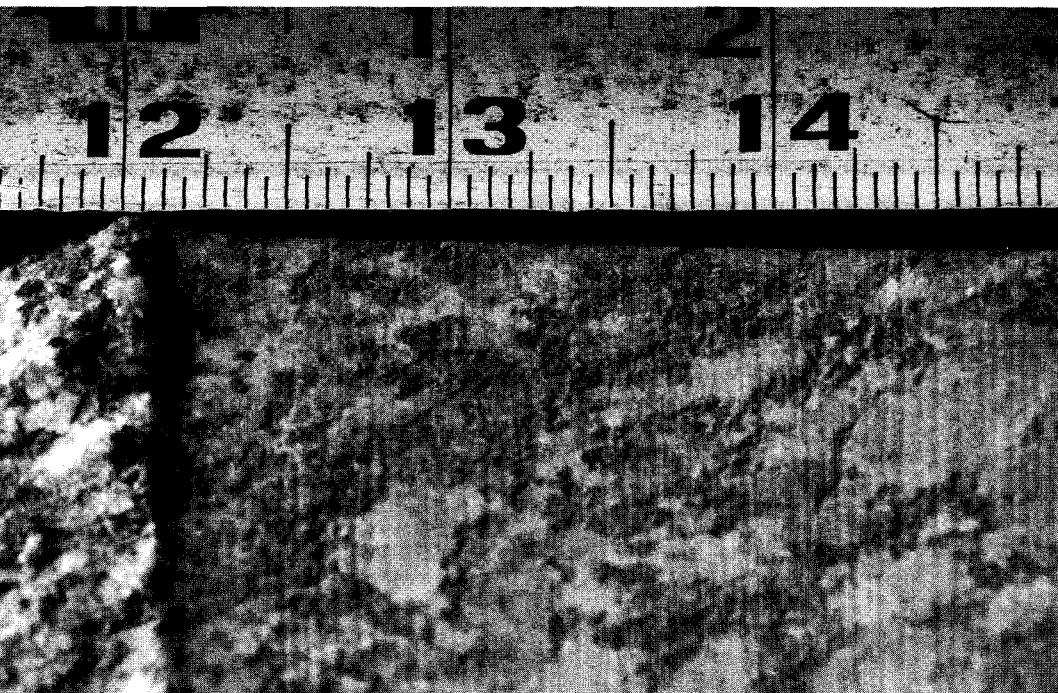



the surface area being cut. In pursuing an answer to the puzzle, while providing an answer to Petrie’s question about the size of the saw, it was necessary to calculate the radius of the saw and the granite block at Abu Roash, provided the attributes to calculate the radius, with, perhaps, a tolerance of 5 percent of the diameter. To achieve this, it was necessary to use both radii swung around the *y* and *z* axes referenced in figure 10.11 on page 259 (see figures 10.26 and 10.27).

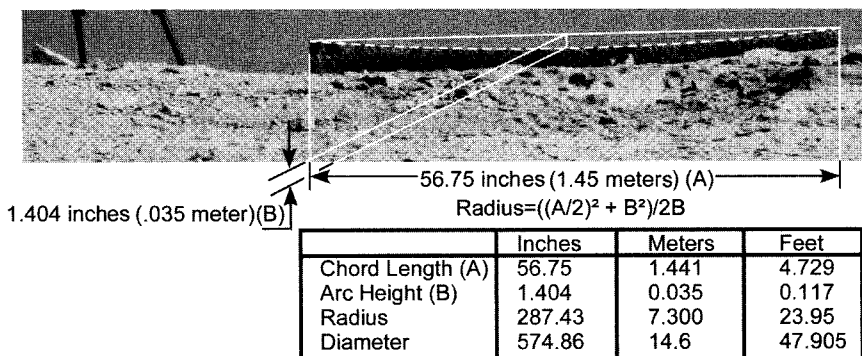

Figure 10.26. Calculating the *y* axis radius.

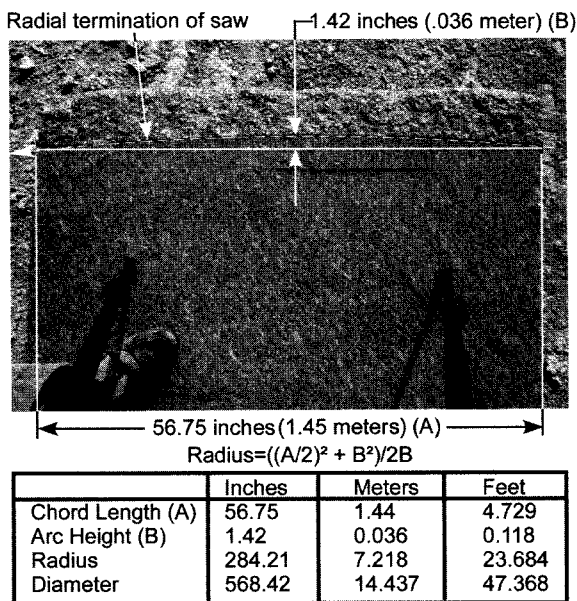

Figure 10.27. Calculating the *z* axis radius

Three points were selected along the arcs in both figures 10.26 and 10.27 to create circles. Zooming in on the arc, it was determined that the radius in figure 10.27 (which defines where the cut ended) is accurate over approximately 93 percent of the arc. As seen in figures 10.26 and 10.27, using the dimensions of the chord (56.75 inches (1.441 meters) and the sagitta, or arc height—1.404 inches (0.035 meter)—in the *y* axis, and the dimensions of the chord and the arc height—1.42 inches (0.036 meter)—in the *z* axis. The radius of the arc is 23.95 feet (7.3 meters) in the *y* axis and is 23.684 feet (7.218 meters) in the *z* axis.

It should be noted that the sagitta of the *y* axis radius was taken on the end of the block nearest the camera and that the radius may not be the same where the surface meets the end of the cut where the stone is broken off. Taking all of this into account, the figures given here are the result of measurements taken under specific conditions. I make no assertion that they are perfect measurements and that they are not subject to change if the stone is examined under laboratory conditions. I recognize, also, that others may take their own photographs and achieve different results, or may achieve different results from my photographs.\* The two and three decimal point callouts do not imply two and three decimal point precision. Yet I do assert that they both indicate, with close agreement, that the saw that cut this block had a very large diameter.

Our view of the calculated arcs along their theoretical axes does not reveal the saw's true diameter. It assumes that the centers of these radii were located perpendicular to the camera's axis, whereas the cut surface being studied had a concave radius cut along its length. These conditions suggest that the saw that cut both radii must have been on an angle or that the granite block was pushed into the saw at an angle. By

---

\*An article published in *Atlantis Rising* magazine entitled *The Mega Saws of the Pyramid Builders* (Issue 70, July/August 2008, Doug Kenyon, editor) contained a different photograph that was taken in 2007. After returning to Abu Roash in November 2008, I was able to take another photograph from a lower point. This photograph, used here, resulted in a different radius and, therefore, a different diameter saw. It should be noted, however, that the difference between the two is within 5 percent of their respective diameters. Also changed here is the formula to correct the tilt angle, which was published in AR 70 as (cutter diameter / radius<sup>2</sup> = Sin of angle of tilt) and is corrected here to read (cutter diameter / radius<sup>2</sup> = radian measure), from which the sine of the tilt angle can be obtained.

knowing the dimensions of both radii, therefore, we can make a more accurate calculation of the saw diameter.

When viewed at right angles, the radius cut at an angle into the stones is seen as a segment of an ellipse. A useful trick in machining is to tilt a cutter on an angle to machine a larger radius into a work piece. The rules are that the block has to be much narrower than the cutter in order to avoid creating more of an elliptical shape. The formula, that is usually found secreted in a toolmaker's toolbox under or inside a copy of *Machinery's Handbook*, is given as the *cutter diameter/diameter of desired radius = radian measure*. The following table was created by adjusting the cutter diameter until the radius from the top view and the radius from the end view produced an angle that combined added to approximately 90 degrees. A difference of 0.6 degrees is noted and expected, considering the lack of a precise laboratory inspection of the block.

In calculating the diameter of the saw, I used an Excel spreadsheet and input the known radii, seen from the top and the end, then adjusted the diameter of the cutter until both angles equaled 90 degrees:

#### CALCULATIONS OF THE DIAMETER OF THE SAW

	Top View		End View	
	Feet	Meters	Feet	Meters
Cutter diameter	37.5	11.43	37.5	11.43
Radius measured	23.684	7.22	23.95	7.30
Radian measured	0.792		0.782	
Angle	45.4		44.8	

This was tested in a milling machine on a micarta plastic 1/61 scale model, the results of which were compared to the photograph of the granite (see plate 22). The process involved tilting a cutter on a 45-degree angle and cutting along the  $x$  axis (identified as the  $y$  axis in figure 10.11, p. 259) until I had reached a point where I could break off the material at the cutting edge. The piece that broke away from the

block had all the characteristics of a pyramid casing stone, but the angle was not consistent with Egyptologists' speculation on the angle of the pyramid. Lehner, though unsure of the exact angle, proposes a range of 48 to 52 degrees.<sup>22</sup> Considering the slope of the pavement, however (see figure 10.4, p. 253), a block with a 45-degree angle would be tilted in the opposite direction of Lehner's hypothetical angles, which means that we cannot use this block as evidence of the angle of the nearby pyramid. Whether this granite block is the piece of sarcophagus that Petrie had noted is also uncertain at this juncture.

It seems fairly certain that the block at Abu Roash was not cut with the saw tilted on an angle, but with the block rotated at 45 degrees and moved into the saw, perpendicular to the saw's axis of rotation. To cut the block by pushing it at an angle against the face of the saw not only would apply significant lateral forces, but also it would be inefficient, because the volume of material to be removed would be increased tremendously. Without going back in time and witnessing how this block was cut, we can only speculate, but having thought long and hard about a possible method that would remove the least amount of material and provide the features evident on the block, it involves cutting the block in three operations as seen in figure 10.28.

The small step seen 4 inches away from the radial break on the granite indicates that the block may have been moved through the saw in three stages. If this was the case, then it is possible that two blocks with the same 45-degree angle were created, and then the angle was recut on each to the pyramid angle.

The operation seen in figure 10.28, stage A, created the compound arc and broke off what appears to be a block with the pyramid angle (shaded area). Stage B cut parallel to the bottom of the block and produced another triangular block, which may have also been used as a pyramid block. These blocks are nowhere in the vicinity at the site and must have been carried off with many other blocks. These cuts left a thinner block, which is the focus of our study. At this point, the block would have had a flat face with a step down to the radial break (see figure 10.28 B and E). Then again, for unknown reasons, it appears that the builders

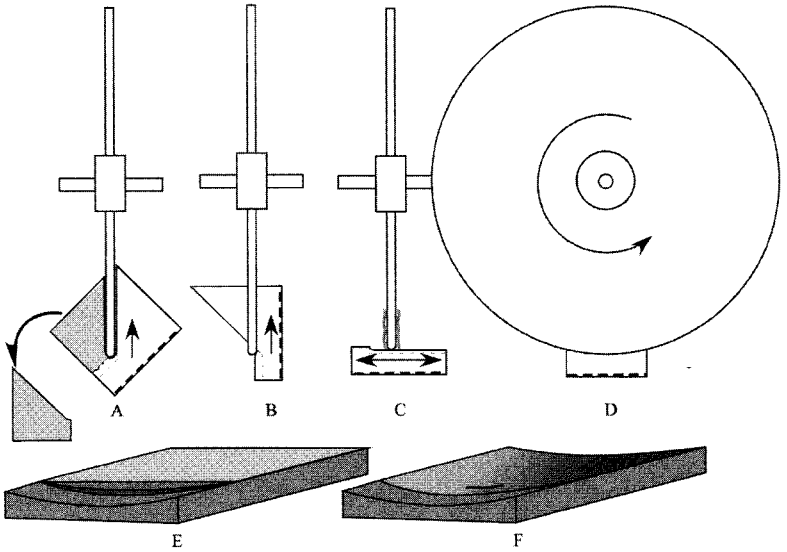
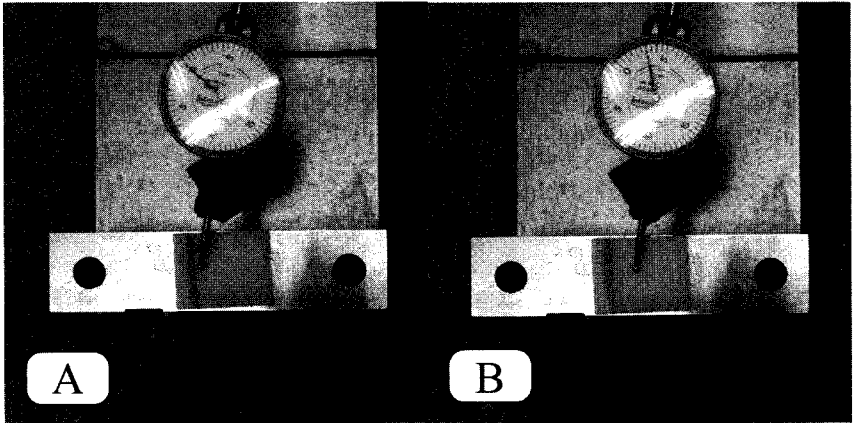

Figure 10.28. Proposed stages of cutting the block



Plastic model with indicator near break and set to zero.

Plastic model with indicator near step with a reading of  $-.003$  inch.

Figure 10.29. Machined model with step

decided to make the surface even across the length and passed the piece across the saw, where at two points there was movement in the block, and steps in the surface were left (see figure 10.28 C and F).

This theory was tested on a piece of plastic, and a predictable step was created where the cutter was used perpendicular to the surface rather

than at an angle and, therefore, cut a smaller radius. When the full width of the block was reached, the cutter was passed along the entire surface and then the step was measured to be 0.003 inch at its deepest part using an Interapid indicator (see figure 10.29). Across a block the size of the stone at Abu Roash, the step would have measured 0.183 inch deep. Without an exact measurement of the step in the Abu Roash block, I would estimate that it was no more than 0.25 inch. Figure 10.30 provides a close-up of the area showing the parallel striations.

It seems bordering on the impossible to imagine such an operation being performed by ancient Egyptians, but what other method would create each of the following?

1. A compound radius
2. Parallel striations that follow an uneven path across the stone
3. A step about 4 inches away from the break

Figure 10.30. Stone at Abu Roash with machined step



The wobble of the striations provides support for the proposed method, for it would be very likely that a saw blade that is approximately 37 feet in diameter would have some lateral movement, even with small inaccuracies in the bearing—unless there are stabilizing bearings that apply support on both sides toward the outer rim. The evidence in the stone shows clearly that a tool with fixed cutting points was passed across the surface with a reasonable degree of regularity, given the distance between the striations—but seen from one end to the other, there is lateral movement in the striations, which indicates a wobble in the tool.

Because the machines that cut the Chinese jade burial rings and the Egyptian granite blocks are no longer in existence, the evidence is considered circumstantial. Yet it provides us with a fairly accurate picture of at least their diameter, if not quite how they were driven or the materials used in manufacturing the saw.

As we consider the megasaw at Abu Roash, it might be useful to consider machines with similar dimensions that are in use today. Between 1987 and 1994, megamachines that were thought of as marvels of modern technology chewed through 31.6 miles (51 kilometers) of chalk marl beneath the English Channel at a rate of 482 feet (150 meters) per week. Hardened steel and carbide bits at predetermined placements around the cutting face of a Tunnel Boring Machine (TBM) traveled around an 84-foot circumference, creating a tunnel that was 27 feet (8.2 meters) in diameter. These were monster machines designed for a mammoth project in which size truly mattered.

With the new evidence gained from Abu Roash, we now know that when the ancient Egyptians tackled mammoth projects, size also mattered. The evidence shows that when it came to designing equipment that was up to the job of pyramid building, nobody did it better than the ancient Egyptians. While the TBMs that bored through the English Channel were 27 feet (8.2 meters) in diameter, objective evidence shows that the ancient Egyptians used megasaws for cutting granite, limestone, and basalt that exceeded that diameter. We can calculate the size of these saws by the impression they left on the granite block seen in plate 21.

We should not be surprised that a culture able to conceive and build the largest and most impressive structures on the planet did not limit their efforts to just the constructions, but also to the tools they used to build them. The ancient Egyptians created an abundance of evidence from which methods of manufacture can be inferred.

As this evidence drove me to grapple with these concepts, I was stunned by their implications, and I tried to imagine what such a saw would look like, how it was installed on the Abu Roash Plateau, and how the stone to be cut was secured and moved through the blade. The radius on the stone indicated that it was cut slightly off the center line of the saw, which meant that the block was secured to a table that must have been 15–16 feet (4.57–4.87 meters) from the ground. It seems a bit extreme to have to haul blocks of stone 15 feet in the air to be able to cut them, but then it finally dawned on me that there are other features at Abu Roash and at Giza that may provide an answer to this mystery.

Close to where this stone is located and cut into the bedrock there is a deep trench that is 121.39 feet (37 meters) long and 31.5 feet (9.5 meters) deep (see figure 10.31). Similar trenches can be seen on the Giza Plateau on the east side of the Great Pyramid. These long trenches have been labeled *boat pits* by Egyptologists because of their shape, and they are considered to be the symbolic transport of the dead king into the afterlife. Considering the appearance of solar boats in Egyptian art, particularly the prolific reliefs inside the Temple of Denderah and the discovery of a boat in a rectangular pit south of the Great Pyramid, the association of the pits with boats is understandable. The trench at Abu Roash, however, is quite narrow and deep and does not accurately represent the shape of a boat's hull. In addition, no remains of boats were found in these trenches—unlike the rectangular trench south of the Great Pyramid, where, in 1954, an ancient Egyptian boat was found in pieces. The boat was reconstructed, and it is now housed in a museum built specifically for its display. Within an engineering context, it would not be far-fetched to propose that the empty trench in the vicinity of Abu Roash was originally used to accommodate the lower part of the saw's massive diameter (see figure 10.32). This, more than likely, will



not be a popular suggestion among Egyptologists, but from an engineering perspective, it makes more sense—considering the work that was required to construct Abu Roash—than installing symbolic items for the use of the pharaoh's soul in the afterlife.

The revolutions per minute of a saw that is 37 feet in diameter would be relatively low. If we consider that a 1-inch-diameter diamond-tipped drill rotates at 900 rpm, the surface speed calculates to  $3.1415926 \times 900/12 = 235.619$  surface feet per minute. In one revolution, a saw that is 37 feet in diameter would travel 116.24 feet, so it would require just 2.03 rpm to achieve 235.619 feet per minute at the cutting edge. Of course, this is based on modern tools—the kind of materials embedded



Figure 10.31. Trench at Abu Roash

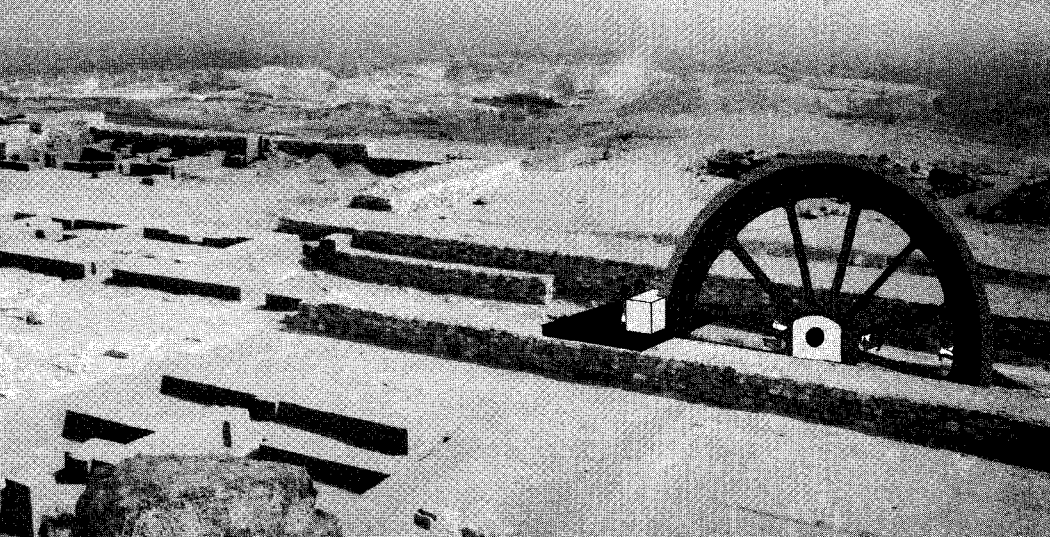

Figure 10.32. Abu Roash with a megasaw installed in its trench

in the substrate of the segments of the outer rim of the saw (if they had reached the same logical idea expressed in the aforementioned patent) are a mystery.

After this enlightening visit to Abu Roash, I returned to the Giza Plateau where seven so-called boat pits located at various places around the pyramids have been uncovered. Two of the largest pits—or slots, as they really appear to be—are oriented north to south on the east side of the Great Pyramid (see plate 23 A and B). Others are located between the queen's pyramids (plate 23 C and D). Another rather dilapidated pit with a fence that has fallen down (plate 23 E) is near Khafre's pyramid to the north of the contoured stone discussed in chapter 6 (refer to figures 6.17–6.20, pp. 160–63). Note that the inset in plate 23 D shows a radial undercut on one end of the trench, which is indicative of a circular saw's action.

When we look at the trenches on the Giza Plateau and consider the enormous task of cutting millions of blocks of stone not just for the Great Pyramid, but also for the other pyramids on the site, the use of megasaws that can cut efficiently through granite and limestone to exacting tolerances somehow gives the manufacture of pyramids a different perspective—a perspective that allows a sense of comportment with engineering on an appropriately massive scale, and one that takes into account methods and machines that were equal to the task at hand.

The whole plateau would have been a hive of activity, with quarried stone being moved onto the plateau next to the saws, in line to be cut to shape for placement in the pyramids. At the same time, ancillary workshops would have manufactured cutting segments that were installed on the rims of the saws as others were worn through use.

It is well known that the biggest enemy of the life of a tool is heat. With a given segment of the saw working only for a fraction of the time it takes to rotate 360°, as it is in contact with the piece being cut, the heat generated during the cutting process would dissipate as the saw turned slowly around. It might also have been beneficial to fill the saw pits with water and have the saw pass through the water after cutting in order to cool it and wash away rock dust embedded in the edge. By the time a given segment of the saw had to cut again, it would have lost most of its water and dried off. A totally dry process, however, would be preferable for waste removal.

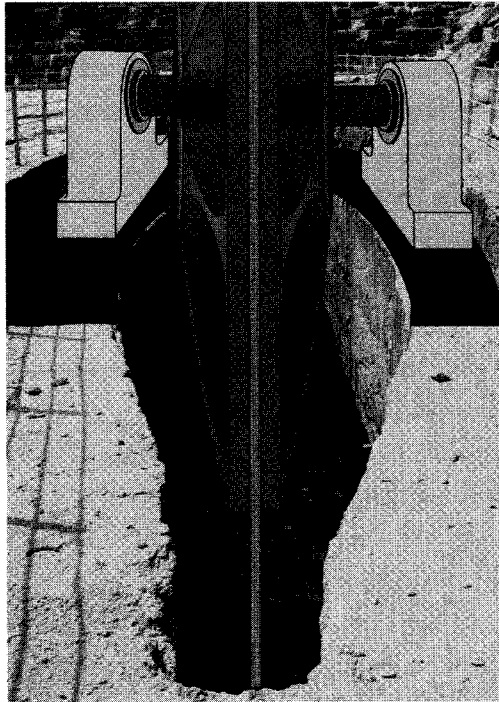

Figure 10.33. Installation of a saw in the trench shown in plates 23 C and D

The removal of waste is a concern. The pits are more than twice as long as their depth, most likely, to allow workers access to remove the waste. One trench on the Giza Plateau has steps descending from one end—an indication that frequent access was necessary.

A discussion of the materials and power available to the ancient Egyptians to manufacture and drive the saws must also consider materials and methods that have not yet been found in the archaeological record. This discussion must take into account not only this chapter, but all the previous chapters of this book.

How many other pits or features near the pyramids may be found lying under the sands of Egypt? As Zahi Hawass has said many times, 70 percent of Egypt's treasures are waiting under the shifting sands for one fortuitous turn of the spade.

The tool marks on the stone at Abu Roash provide evidence for the movement of the tool that cut the granite. Since 1995, tool marks similar to these have been at the center of an ongoing Internet debate concerning a granite core that was taken from a drilled hole and thrown on a prehistoric trash heap at Giza. Sir William Flinders Petrie stumbled onto this piece of granite, took it back to London, and wrote about it in his book *The Pyramids and Temples of Gizeh*. The granite core now resides in the Petrie Museum at the University College, London, along with some other interesting pieces that will shed even more light on the manufacturing capabilities of the ancient Egyptians.

The tool marks left on ancient Egyptian granite tell a story. This story is one of remarkable capability. Resident in academic arguments regarding the efficiency of the ancient Egyptians is that time did not mean the same to the ancient Egyptian artisans as it does to twenty-first century artisans. All of their monuments, we are told, were crafted with simple tools and the time it would take using these simple tools to manufacture all of their monuments and statues. The evidence in the Petrie Museum, however, strongly argues against this notion. The evidence shows that they were using processes that modern manufacturers may yet need to discover. Let's look at that evidence.



# 11

## Walking in the Shadow of William F. Petrie

*Where is the other evidence of this culture? Show me a potsherd. Show me a tomb. Show me an inscription. Show me any other piece of sculpture that dates from this period.<sup>1</sup>*

MARK LEHNER, EGYPTOLOGIST

Sir William Flinders Matthew Petrie was born in 1853 and died in 1942. In the course of his career, he wrote 102 books and articles appearing in forty-eight journals and six magazines, resulting in 1024 numbered items. His shadow was cast over all who came before him and has influenced those who came later. He is considered to be the father of British Egyptology.

In 1972, Eric P. Uphill created a comprehensive bibliography of Petrie's work. He thanks Ms. Ann Petrie, Sir William's daughter, for allowing him to search her home for rare articles to make his bibliography more complete. His introduction to the bibliography provides insight into how Petrie was viewed by his peers of that time:

Petrie died during the Second World War so that although his passing was recorded by both learned journals and the press, it did not

Figure 11.1.  
Outside the Petrie  
Museum in 2003



receive the attention that would undoubtedly have been accorded it in peaceful and less difficult times. Much has been written about Petrie, perhaps the most controversial figure in the whole annals of archaeology, both during his lifetime and afterwards, and probably more eulogies both critical and uncritical have been accorded him than to any other Egyptologist since Champollion. Some have written serious analytical discussions of his work and achievements, or allegedly frank assessments of his faults, yet no one has produced a list of his publications.<sup>2</sup>

Professional disagreement can sometimes turn into heated debate, though such debates may not have been as public in Petrie's day as they are now considering the development of communication technology and how it is used to promote ideas. One of the more widely known debates of the modern era was a contentious disagreement at the American Association for the Advancement of Science Convention in Chicago in 1992 between Egyptologist Dr. Mark Lehner of the Oriental Institute and geologist Dr. Robert Schoch of Boston University. Schoch became involved with ancient Egyptian studies when he was persuaded by John Anthony West to write an opinion on West's claim, after Schwaller de Lubicz, that water weathering on the Great Sphinx, and especially

on the Sphinx enclosure wall, was indicative of a much earlier-than-accepted date for its carving. After performing an on-site analysis, Schoch reported that the Great Sphinx is thousands of years older than scholars generally believe. Lehner called these findings “pseudoscience,” and the normal cool politeness of academic debate was thrown on the sacrificial fire as heated voices continued past the time allotted and on into the hallway after the presentation.

Lehner argued: “You don’t overthrow Egyptian history based on one phenomenon like a weathering profile” and “that is how pseudoscience is done, not real science.”<sup>3</sup>

Schoch, however, held to his evaluation, which was based on the science in which he has been trained—geology—and he reiterated his studies of the Sphinx’s erosion. He used sound waves, which suggested that the monuments crevices were carved sometime between 7000 and 5000 BCE.

Scholars of Egyptian history have been scornful of Schoch’s science because it is contrary to the research that generations of Egyptologists and archaeologists have developed. Because of his understanding that people from that period were believed to be hunter-gatherers who had not advanced sufficiently to build cities like those of the ancient Egyptians, Lehner asked for evidence of a culture living at that time that was advanced enough to carve the Sphinx. Lehner added, however, that he was willing to consider evidence, such as a potsherd, that would provide a cultural context for this lost civilization.

Dr. Schoch responded that perhaps later civilizations came on to the scene and cleaned up the area.<sup>4</sup> To a layperson and a scientist, this idea does not seem outlandish, considering what we know about how later cultures can absorb and mask previous cultures by destroying or corrupting evidence, as Dr. Andrews pointed out in the foreword to this book. Modern societies, while living and working in the shadows of a previous generation’s constructions, create artifacts that are entirely different and may give future archaeologists the wrong idea of what existed here previously should there be a break in the generational transfer of knowledge. Also, when we look at the evidence highlighted in the previous chapters

of this text, this idea does not sound so foreign, and it becomes obvious that more has been lost than we previously believed.

Schoch is also not the first to propose that the ancient Egyptian civilization was older than scholars believe it to be. Lehner himself benefited from followers of the sleeping prophet, Edgar Cayce, whose organization, the Association of Research and Enlightenment, funded his research in Egypt in search of the fabled lost continent of Atlantis—evidence of which was supposed to come to light in 1998. Ultimately, Lehner rejected this outside-the-box view after he failed to find evidence of lost civilizations, and seems to reject the ideas of those who might think that they have succeeded.

The relevance of ancient megalithic construction and precision cutting of igneous rock relies on engineering principles, not on geology or Egyptology. The potsherds Lehner asked to see that would change his mind about ancient Egyptian history are found in Egypt and in museums all over the world. The ones I have studied reside not in Egypt, but are situated in a glass display case in the Petrie Museum in London. The recent documentaries that have been broadcast by Egyptologists have been a distraction from what was really going on in ancient Egypt. They mislead by not addressing the incredible precision of the available artifacts. They do not address the remarkable geometry and exactness of the ancient Egyptians' statues, and they have ignored evidence presented by Flinders Petrie in 1883 that proves that the ancient Egyptians used highly sophisticated methods for cutting stone—including efficient and versatile lathes.

The lathe is a natural development from the potter's wheel depicted in ancient artwork and presumed to have existed in ancient Egypt. The type of potter's wheel in ancient Egypt is taken from an Egyptian relief showing the god Khum seated at what is theorized to be a kick wheel.

From the early origins of potter's wheels, improvements evolved the technology to what we see today, and the spin-off of the potter's wheels that are still in use are found in every manufacturing plant in the world. They have progressed from manually driven machines to water-driven and steam engine-driven line shaft pulleys and belts to the electric



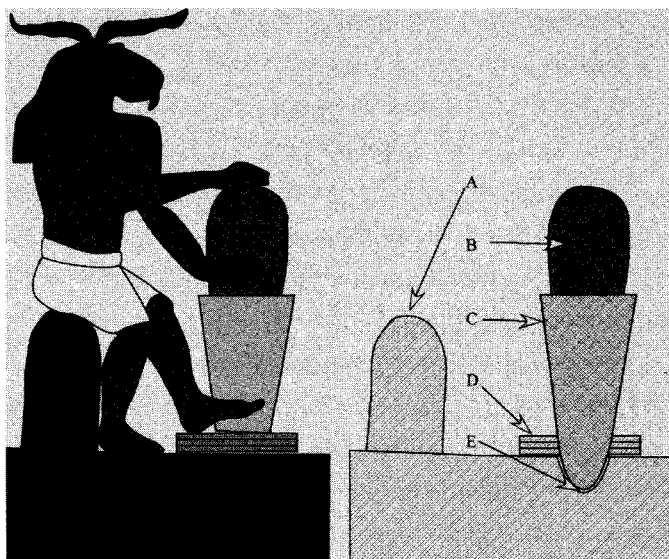

Figure 11.2. Egyptian relief showing the god Khum and a cross section of a potter's wheel assembly: A. Bench B. Work C. Rotating table D. Kick wheel E. Bearing. Drawing by C. Dunn after Hodges.<sup>5</sup>

motor. In 1968, I was employed as a journeyman lathe turner in the tool room at the venerable J and S Eyres Ltd. engineering company in Manchester, England. This was the only company where I worked that had an old-fashioned line shaft driving several machines. Manufacturing and repairing the leather belts for the line was considered a craft in and of itself, with specialists employed to perform such work.

The potsherds in the Petrie Museum, however, are of a different quality than what can be produced on a potter's wheel or even a woodworking lathe of the kind used by undeveloped cultures. What is depicted in figure 11.2 does not explain two potsherds that Petrie describes in *The Pyramids and Temples of Gizeh* and which are called out there as 14 D and 15 D in figure 10.13 (see p. 261):

The principle of rotating the tool was, for smaller objects, abandoned in favour of rotating the work; and the lathe appears to have been as familiar an instrument in the fourth dynasty, as it is in mod-

ern workshops. The diorite bowls and vases of the Old Kingdom are frequently met with, and show great technical skill. One piece found at Gizeh, No. 14, shows that the method employed was true turning, and not any process of grinding, since the bowl has been knocked off its centring, recentred imperfectly, and the old turning not quite turned out; thus there are two surfaces belonging to different centrings, and meeting in a cusp. Such an appearance could not be produced by any grinding or rubbing process which pressed on the surface. Another detail is shown by fragment No. 15; here the curves of the bowl are spherical, and must have therefore been cut by a tool sweeping an arc from a fixed centre while the bowl rotated. This centre or hinging of the tool was in the apex of the lathe for the general surface of the bowl, right up to the edge of it; but as a lip was wanted, the centring of the tool was shifted, but with exactly the same radius of its arc, and a fresh cut made to leave a lip to the bowl. That this was certainly not a chance result of hand-work is shown, not only by the exact circularity of the curves, and their equality, but also by the cusp left where they meet. This has not been at all rounded off, as would certainly be the case in hand-work, and it is clear proof of the rigid mechanical method of striking curves.<sup>6</sup>

As seen in the photographs of the bowl shard housed in the Petrie Museum, illustrated in Petrie's drawing is the backside, convex part of a bowl shard (figure 11.3 A). In my article "Advanced Machining in Ancient Egypt?" and in my book, *The Giza Power Plant: Technologies of Ancient Egypt*, with a chapter of the same name, I incorrectly illustrated it as a concave, dish-shaped feature. After visiting the museum and examining the artifact in question, University College London (UCL) ref. UC41398, I am now able to correct this error.

Petrie, however, did not discuss a more important feature of this shard: the concave surface on the opposite side of the surface he had illustrated. This is surprising, because the radial gouge on the dished side of the potsherd (see figure 11.3 B, C, and D) can provide a clue as to what may have caused the bowl to be knocked off axis in the lathe—

or at least another result of the bowl's displacement in the lathe. The questions it raises, however, cannot be answered by conceptualizing the lathes used in ancient time that are depicted in history books. The groove on the "dish" may have been the result of the material shifting on its axis causing the tool to plunge into the material, knocking it off-axis and causing the biaxial, convex radius on the outside of the bowl.

Because it has the impression of the geometry of the tool bit being applied to the surface, the existence of the gouge also proves Petrie's contention that the surfaces noted on his 15 D were created with a single-point tool and were not the result of rubbing with abrasive. This is an important point when we consider the ancient Egyptians' level of technology.

Regarding the use of a single-point tool, Petrie writes:

That the Egyptians were acquainted with a cutting jewel far harder than quartz, and that they used this jewel as a sharp pointed graver,

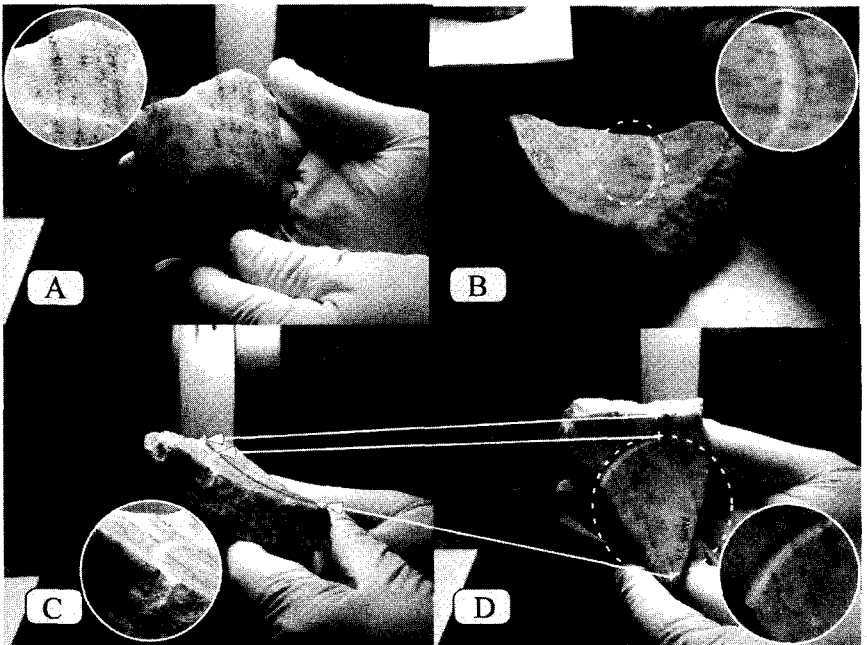

Figure 11.3. Petrie's bowl shard (his 15 D) housed in the Petrie Museum, UC41398, diorite, width 2.7 inches (6.8 centimeters), length 3.8 inches (9.6 centimeters)

is put beyond doubt by the diorite bowls with inscriptions of the fourth dynasty, of which I found fragments at Gizeh; as well as the scratches on polished granite of Ptolemaic age at San. The hieroglyphs are incised, with a very free-cutting point; they are not scraped nor ground out, but are ploughed through the diorite, with rough edges to the line. As the lines are only  $\frac{1}{150}$  inch wide (the figures being about .2 [inch]), it is evident that the cutting point must have been harder than quartz; and tough enough not to splinter when so fine an edge was being employed, probably only  $\frac{1}{200}$  inch wide. Parallel lines are graved only  $\frac{1}{30}$  inch apart from centre to centre.

We therefore need have no hesitation in allowing that the graving out of lines in hard stones by jewel points, was a well known art. And when we find on the surfaces of the saw-cuts in diorite, grooves as deep as  $\frac{1}{100}$  inch, it appears far more likely that such were produced by the jewel points in the saw than by any fortuitous rubbing about of a loose powder. And when, further, it is seen that these deep grooves are almost always regular and uniform in depth, and equidistant, their production by the successive cuts of the jewel teeth of a saw appears to be beyond question. The best examples of equidistance are the specimens of basalt No. 4, (Pl. viii), and of diorite No. 12; in these the fluctuations are no more than such as always occur in the use of a saw by hand-power, whether worked in wood or in soft stone.<sup>7</sup>

Implied in the manufacturing errors in UC41398 (figure 11.3) may be the action of two tools at the same time, one on the outside and one on the inside, which indicate that as the tool created the gouge on the inside of the bowl, it pushed the bowl into a component of the chuck that was holding the bowl until the stone broke under the pressure. I make this observation based on the corresponding start points of the inside gouge and the outside undercut. It is difficult to imagine, however, the multiple grooves on the outside of the dish in the sunken area all being created at the same time it took for the inside groove to travel from start depth to finish depth—but then, there are still many mysteries about

ancient Egyptian technology that are not completely understood, and, in this case, without the machines to explain them, we can only speculate.

As we can see on the dished surface, the groove increases in depth until it meets the broken edge. Reference lines have been drawn on the bowl shard indicating the trueness of the radial groove. The arc describing the spherical dish radius that travels from the outside of the bowl to the center was created from three points, as noted in figure 11.3 C and D. This is drawn not to provide dimension to the piece or assert a degree of precision, but as a visual reference and evidence of the curvature.

Perhaps the most important question to ask when we try to determine how these errors were created is: What kind of power was behind the lathe to allow a single-point tool to cut a gouge so deep into the material that the stone would ultimately fail and break? The forces implied with this simple potsherd are not the forces associated with a potter's wheel or a spindle lathe that is spun via the manual push and pull of a strung bow. If a manually operated lathe met such resistance, it would come to a stop. To argue that only manpower was used in the process of creating this error would be to argue that the operator acquired some sort of lever to rotate the chuck that held the stone and made a conscious decision to drive the tool deeper into the diorite and ruin his or her work.

Petrie's 15 D shows the versatility of the lathe employed to create it. As seen in figure 11.4, the surface is double dish shaped with tantalizing telltale shallow striations on the surface. These striations would not be out of place on a modern artifact created on a lathe when a tool, which had made a cut across the surface, was reversed across the same path it took when it made the cut. The grooves shown just below the cusp indicate that as the bowl turned in the lathe, the tool moved rapidly across the surface. Witnesses to this event are the arcs of the grooves not being concentric with the arc of the cusp and the distance between the grooves. In other words, we can clearly see that the shallow grooves do not follow the same arc as the cusp where the radius changes (see figure 11.5) and are somewhat irregular. If the grooves did have the same arc as the cusp, it would mean that the tool was stationary while the bowl rotated. These grooves are also evidence of the use of a single-point tool to machine the bowl.

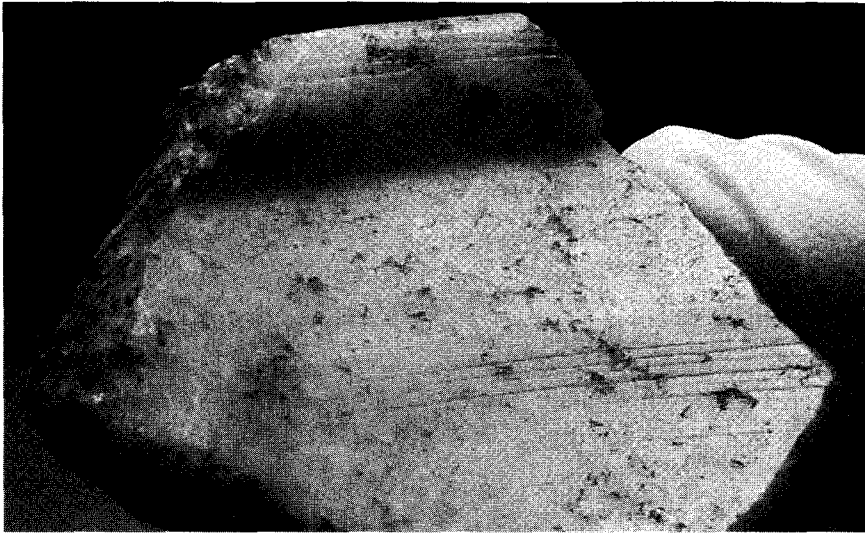

Figure 11.4. Petrie's potsherd (his 15 D), housed in the Petrie Museum, University College London, UC43197, diorite, width 2.5 inches (6.3 centimeters), height 2.3 inches (5.9 centimeters). Note the difference between this piece and figure 11.3: figure 11.4 has a cusp within the dish where two radii intersect and a raised lip around the outside.

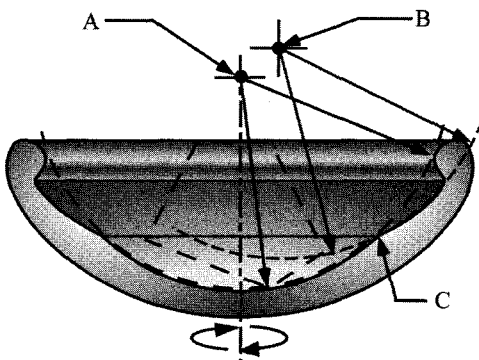

Figure 11.5. Petrie's 15 D with axes of rotation for the sweep of the tool. Point A is the original pivot point of the tool. Point B is the secondary pivot point of the tool and creates the bowl's lip and the cusp (C), where the radii intersect.

When I examined these pieces physically by running a finger across the surface of the dished-out stone, they were smooth, machined surfaces with no dips or high spots. When we take these into consideration

along with the sharp cusp and the scratches in the surface in Petrie's 15 D and the deep groove in his 14 D, the implication is the use of a lathe that was under significant power and that the rotary axis of the bowl and rotation of the tool that cut Petrie's 14 D (see figure 11.3) and the rotary axis of the bowl in Petrie's 15 D (see figures 11.4 and 11.5) were dependent upon precise bearings. This technology pushes the envelope further. It is definitely not discussed in Egyptology books and moves the state of the art of ancient Egypt much higher than where Robert Moores moved it with his drag saw. The use of precise bearings would also be necessary for the proper functioning of megasaws at Abu Roash and at Giza.

Figure 11.6 shows a horizontal lathe that was commonly in use the 1950s through the 1970s. Egyptologists would consider such a lathe beyond the ancient Egyptians' capabilities. Some shops may still have such a lathe on their floor. Progress and inventiveness have seen the lathe evolve tremendously over the last fifty years. Figure 11.7 shows a modern Computer Numerical Control (CNC) vertical lathe. In the span of fifty years, vast improvements have been made to our machines, though we are expected to believe that in ancient Egypt in a span of

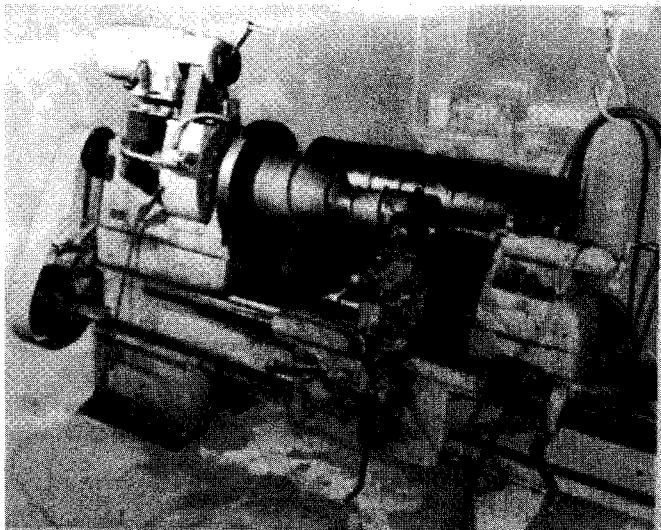

Figure 11.6. Horizontal engine lathe (Courtesy Danville Metal Stamping)

three thousand years, they were still using sticks and stones and copper saws and drills. It seems that the evidence, not to mention human nature, proves otherwise.

Considering that the pyramids were crafted with such precision, is it surprising to find circumstantial evidence that proves that exact and robust machine-tools existed in prehistory? Such machines did not just saw blocks for the pyramids and temples, but they also crafted delicate and precise stonework, such as the Ramses statues and the stone bowl fragments discovered by Petrie. Could we re-create the granite and basalt boxes in the Serapeum without employing some fairly sophisticated machinery? If we did not have the materials to devise such machinery, had not developed an understanding of metrology, and were without an inventory of instruments to measure precisely, how would we achieve these miracles in stone? Is anyone today willing to take on the fabrication of an Apis Bull box?

Petrie not only provides us with a cogent description of the use of lathes in ancient Egypt, a talent that most likely made his ideas controversial, he also describes an artifact that has been the topic of much discussion over the years. I became aware of the discussion in 1995, when I

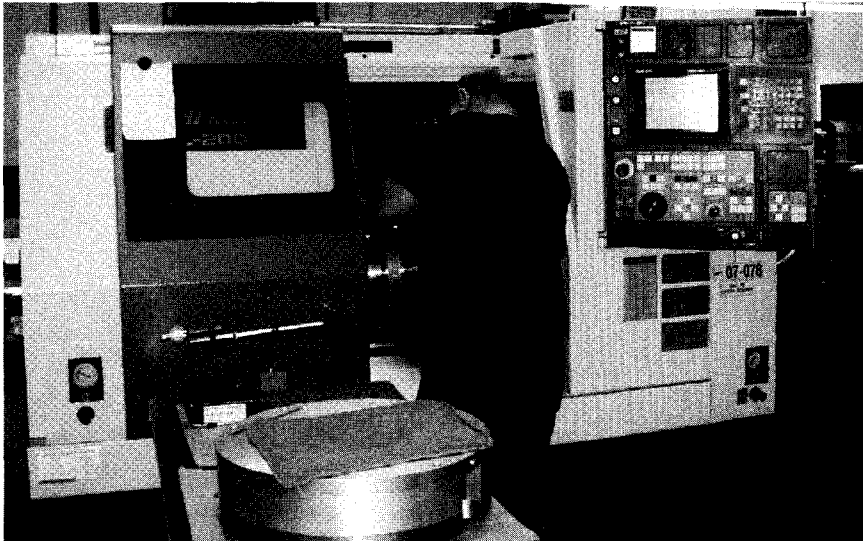

Figure 11.7. Horizontal CNC lathe (Courtesy Danville Metal Stamping)



received an e-mail from a man who had read my 1984 *Analog* magazine article and started the discussion on *dejanews.com*. The original article was subsequently published in other magazine articles, the editors of which were attracted to the controversial content and that perhaps it provided answers to how the ancient Egyptians performed inexplicable feats of stone cutting. The method I had postulated is that ultrasonic machining may explain the characteristics found in a very unique artifact in Petrie's collection.<sup>8</sup> This artifact is described by Petrie as 7 G (see figure 10.13, p. 261; more popularly known as Core 7) and is housed in the Petrie Museum (see figure 11.8). The hypothesis of ultrasonic machining stimulated both positive and negative reactions, with those who opposed the idea offering helpful suggestions on how my mind might be changed.



Figure 11.8. Petrie's Core 7 G, housed in the Petrie Museum, University College London, UC16036, granite, height 4.33 inches (11 centimeters)

Petrie's drawing of Core 7 and his thorough description formed the basis of my analysis. Petrie describes it:

On the granite core, broken from a drill hole (No. 7), other features appear, which can only be explained by the use of fixed jewel points. Firstly, the grooves which run around it form a regular spiral, with no more interruption or waviness than is necessarily produced by the variations in the component crystals; this spiral is truly symmetrical with the axis of the core. In one part a groove can be traced, with scarcely an interruption, for a length of four turns. Secondly, the grooves are as deep in the quartz as in the adjacent feldspar, and even rather deeper. If these were in any way produced by loose powder, they would be shallower in the harder substance—quartz; whereas a fixed jewel point would be compelled to plough to the same depth in all the components; and further, inasmuch as the quartz stands out slightly beyond the feldspar (owing to the latter being worn by general rubbing), the groove was left even less in depth on the feldspar than on the quartz. Thus, even if specimens with similarly deep grooves would be produced by a loose powder, the special features of this core would still show that fixed cutting points were the means here employed.

Next the Egyptians adapted their sawing principle into a circular, instead of a rectilinear form, curving the blade round into a tube, which drilled out a circular groove by its rotation; thus, by breaking away the cores left in the middle of such grooves, they were able to hollow out large holes with minimum of labour. These tubular drills vary from  $\frac{1}{4}$  inch to 5 inches in diameter, and from  $\frac{1}{30}$  to  $\frac{1}{8}$  thick. The smallest hole yet found in granite is 2 inches diameter, all the lesser holes being in limestone or alabaster, which was probably worked merely with tube and sand. A peculiar feature of these cores is that they are always tapered, and the holes are always enlarged towards the top. In the soft stones cut merely with loose powder, such a result would naturally be produced simply by the dead weight on the drill head, which forced it into the stone, not being truly balanced, and

so always pulling the drill over to one side; as it rotates, this would grind off material from the core and the hole. But in the granite core, No. 7, such an explanation is insufficient, since the deep cutting grooves are scored out quite as strongly in the tapered end as elsewhere; and if the taper was merely produced by rubbing of powder, they would have been polished away, and certainly could not be equally deep in quartz as in feldspar. Hence we are driven to the conclusion that auxiliary cutting points were inserted along the side, as well as around the edges of the tube drill; as no granite or diorite cores are known under two inches diameter, there would be no impossibility in setting such stones, working either through a hole in the opposite side of the drill, or by setting a stone in a hole cut through the drill, and leaving it to project both inside and outside the tube. Then a preponderance of the top weight to any side would tilt the drill so as to wear down the groove wider and wider, and thus enable the drill and the dust to be the more easily withdrawn from the groove. The examples of tube drilling on Pl. viii. are as follow:—No. 7, core in granite, found at Gizeh. No. 8, section of cast of a pivot hole in a lintel of the granite temple at Gizeh; here the core being of tough hornblende, could not be entirely broken out, and remains to a length of .8 inch. No. 9, alabaster mortar, broken in course of manufacture, showing the core in place; found at Kom Ahmar (lat. 28° 5'), by Prof. Sayce, who kindly gave it to me to illustrate this subject. No. 10, the smallest core yet known, in alabaster; this I owe to Dr. Grant Bey, who found it with others at Memphis. No. 11, marble eye for inlaying, with two tube-drill holes, one within the other; showing the thickness of the small drills. No. 12, part of the side of a drill-hole in diorite, from Gizeh, remarkable for the depth and regularity of the grooves in it. No. 13, piece of limestone from Gizeh, showing how closely the holes were placed together in removing material by drilling; the angle of junction shows that the groove of one hole just overlapped the groove of another, probably without touching the core of the adjacent hole; thus the minimum of labour was required. The examples of tube drilling on a large

scale are the great granite coffers, which were hollowed out by cutting rows of tube drill-holes just meeting, and then breaking out the cores and intermediate pieces; the traces of this work may be seen in the inside of the Great Pyramid coffer, where two drill-holes have been run too deeply into the sides; and on a fragment of a granite coffer with a similar error of work on it, which I picked up at Gizeh. At El Bersheh (lat. 27° 42') there is still a larger example, where a platform of limestone rock has been dressed down, by cutting it away with tube drills about 18 inches diameter; the circular grooves occasionally intersecting, prove that it was done merely to remove the rock.<sup>9</sup>

The most startling feature of the granite core Petrie describes is the spiral groove around the core indicating a feed rate of 0.100 inch per revolution of the drill. In my article, I stated that this feed rate was five hundred times *faster* than modern diamond drills, which penetrate at only 0.0002 inch per revolution. This has been incorrectly interpreted by some, who have concluded that a hole of the same dimension could be drilled five hundred times faster by the ancient Egyptians than by modern drills. The correct way to describe the feed rate would be to say it was five hundred times *greater* than modern diamond drills, but the rotation of the drill would not have been as *fast* as the modern drill's nine hundred revolutions per minute.

When I read Petrie's description of this drill core, I tried to imagine what kind of process could replicate it. It seemed very clear that the spiral groove that wound down the core like a drunken screw (Petrie's description) could not have been made by any loose grains rubbing on the granite. Petrie notes that the groove cut deeper through the quartz than the feldspar, which in conventional drilling would actually be the reverse, because quartz is the harder material. The taper on the core and the hole were also quite puzzling, because they did not lend to the idea that the groove was cut while a rotating tool was withdrawn from the hole. Yet the action of a tool that reflected a feed rate of 0.100 inch per revolution of the drill was not the work of conventional drilling as

we know it and demanded consideration of other processes in its creation. All of these features were considered without the physical examination of the artifact in question and were considered phenomenal not just by me alone, but also by colleagues with whom I discussed their relevance.

It seemed from the evidence described by Petrie that a sure way to create the spiral groove was to use a process whereby the tool oscillated, like a jack hammer or hammer drill, while it turned. I selected the method to be ultrasonic (see figure 11.10), because with quartz having

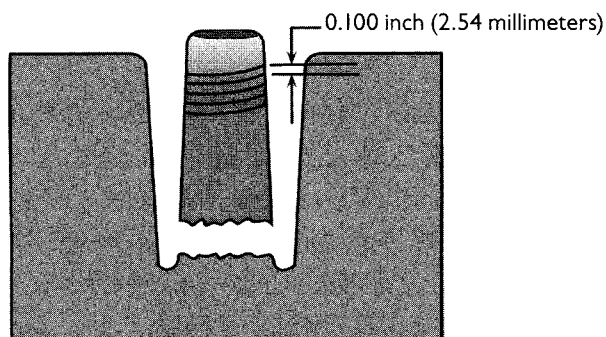

Figure 11.9. Egyptian core drilling hole and Core 7

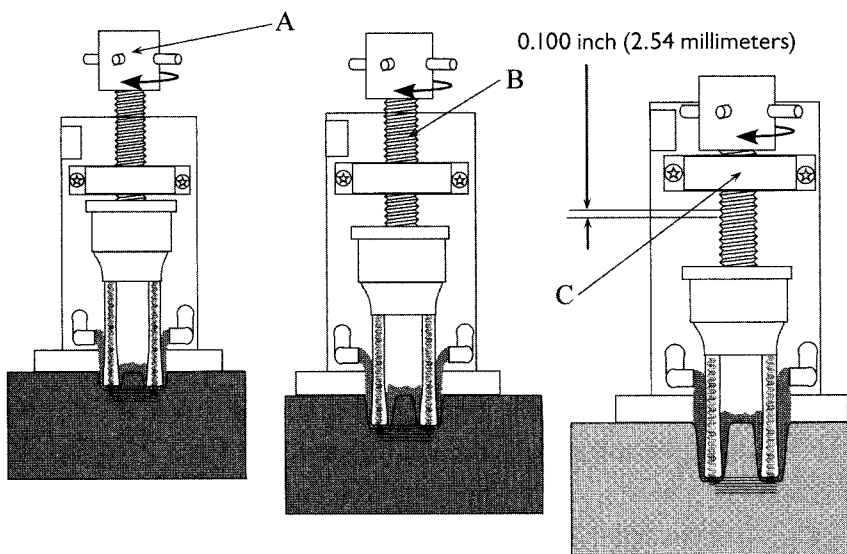

Figure 11.10. Ultrasonic machining of granite

resonant properties, it would respond to the vibration and this might explain the deeper cut through the quartz than the feldspar.

Figure 11.10 shows a basic concept of how the drill worked. The core drill was attached to an assembly that included a horn assembly and transducer and a threaded shaft (figure 11.10 B). While axially oscillating, the assembly was turned by way of a turn knob (figure 11.10 A) through a nut assembly (figure 11.10 C).

This idea, of course, while popular in some circles, was certainly not popular among Egyptologists, one of whom is Denys Stocks, who writes, “Despite this apparent abundance of evidence, many people still argue that these simple tools were not capable of producing the artifacts that survive and, therefore, that there had to be some as yet undiscovered technology that the Egyptians possessed. These supposed technologies include diamond-tipped saws and drills and even the use of sonic waves to cut stone.”<sup>10</sup>

Stocks goes on to claim in his article that he had been able to replicate and demonstrate the efficiencies of the tools we “know” were in the ancient Egyptians’ toolbox. His work is exhaustive and goes to great length in describing every step of his methods, and it includes photographs of bow drills, copper chisels, stone axes, and copper tubes for grinding into diorite using sand as well as an example of a small urn being drilled.

With such a comprehensive and complete study of how simple, primitive tools were applied in prehistory, and with the support of academia behind him, it would seem that the subject of ancient technology was an open-and-shut case. Yet because we have already examined two theories on ancient saws and found them lacking, Stocks’s efforts to prove how the ancient Egyptians drilled granite using core drills must be examined more closely.

Mike Brass, a South African Egyptology student, first advised me of Stocks’s effort to drill granite using a copper tube and sand. I must admit I did not take it seriously, as it conflicted with Petrie’s assertions based on his observations of the core in his possession, and the idea was counter to my own personal experience and knowledge of the capabilities

of drills. Therefore, I did not refer to it when my article was reprinted. I probably should have given it more attention, for it is the simplest method devised because it demands the introduction of the least number of unproven assertions. The materials are already in the archaeological record, and pictorial images can be interpreted as ancient Egyptians using those materials in their working of stone. The experiments by Stocks are lodged firmly in the academic record and are referenced by Deiter Arnold in *Building in Egypt*.<sup>11</sup> This should be enough, we might think, to accept those findings and look no further for answers.

Yet there is that nagging question spiraling around Core 7 in the Petrie Museum. Stocks described the results of a drilling experiment that was conducted in 1999 as part of his involvement with the Lehner/Hopkins *Nova* obelisk experiment. Regarding a core that he ground out of granite using quartz sand and a copper tube attached to a shaft and manually driven by a bow and sand, he writes, "Horizontal striations similar to the ancient ones on rose granite were visible both in the wall of the hole . . . and upon the core."<sup>12, 13</sup>

Stocks's seemingly innocuous statement actually speaks to the heart of the debate regarding the technology used by the ancient Egyptians to drill granite. Horizontal striations, as opposed to helical grooves, would sink the sonic machining theory in a sea of vibrating quartz quicksand, where it will forever rest and, perhaps, be remembered by some as an interesting yet troublesome theory and by others as the product of an overactive imagination. When we look at Core 7 and the drunken crawl of the groove around its circumference, there seems to be a lack of order and certainty to them. Is it possible that Petrie was mistaken or confused when he described this core? Lucas and Harris were not convinced that his evidence supports his conclusion that jewel teeth were set in bronze saws and tubes to create these grooves, but they did not question his observations that the groove was spiral and not horizontal. In *Ancient Egyptian Materials and Industries*, they write:

In my opinion, to suppose the knowledge of cutting these gem stones to form teeth and of setting them in the metal in such a man-

ner that they would bear the strain of hard use, and to do this at the early period assigned to them, would present greater difficulties than those explained by the assumption of their employment. But were there indeed teeth such as postulated by Petrie? The evidence advanced to prove their presence is as follows:\*

- (a) A cylindrical core of granite grooved round and round by a graving point, the grooves being continuous and forming a spiral, within one part a single groove that may be traced five rotations round the core.
- (b) Part of a drill hole in diorite with seventeen equidistant grooves due to the successive rotation of the same cutting point.
- (c) Another piece of diorite with a series of grooves ploughed out to a depth of over one-hundredth of an inch at a single cut.
- (d) Other pieces of diorite showing the regular equidistant grooves of a saw.
- (e) Two pieces of diorite bowls with hieroglyphs incised with a very free-cutting point and neither scraped nor ground out.<sup>14</sup>

Petrie's observations of a helical groove were explained by Stocks to be the result of the random action of quartz sand in the drilling process. This process produces, for the most part, horizontal striations, which he noted in his drilling experiment.<sup>15</sup>

Other experiments were made by Leonard Gorelick and A. John Gwinnet of the School of Dental Medicine S.U.N.Y at Stonybrook, who show the results of drilling using a copper tube and emery grit, a component of which is magnetite and corundum. Corundum has a hardness of Mohs 9. Gorelick and Gwinnet claimed that by using emery, they were successful in grinding out concentric grooves in glass, but indicated that quartz sand would not perform as well.<sup>16</sup>

Seeking to resolve the question of helical versus horizontal grooves, two men set about verifying them by examining the central piece of

---

\*W. M. F. Petrie, *Journ. Royal Anthropol. Inst.*, XIII (1884), pp. 90, 103-4; "Pyramids and Temples of Gizeh," pp. 173-74; "Arts and Crafts," p. 73; "Tools and Weapons," pp. 44-45.



evidence that was located in the Petrie Museum. John Reid, an acoustics engineer who is noted for his work on pyramid acoustics, and Harry Brownlee, an expert stonemason and sculptor, concluded after their inspection of Petrie's Core 7 that the grooves were horizontal, not helical, as described by Petrie.

In their book *Giza the Truth*, Ian Lawton and Chris Ogilvie-Herald write:

They [Reid and Brownlee] make the critical distinction, not effectively made by Dunn, between the *horizontal* striations that are found on all cores—these being separate grooves, which are on close inspection randomly spaced—and *spiral* striations, which are genuinely connected spiral grooves. Petrie reports that he found these latter on only *one* piece, which he examined—our old friend drill core 'No. 7', whereon he described four connected spiral turns. Reid and Brownlee have examined and photographed this core in minute detail, and report that even on this they can detect only *horizontal* striations [see plate 26]; they can only conclude that there may be some confusion in the labeling of the artifact at the museum.<sup>17</sup>

While Lawton and Ogilvie-Herald stress that Petrie found the spiral striations on only one piece, this is not true. As Lucas and Harris state, other examples were found and noted by Petrie: "Another piece is part of a drill hole in diorite. This has been part of a hole 4½" in diameter, or 14" circumference as the seventeen equidistant grooves appear to be due to successive rotations of the same cutting point, we have here a single cut 20 feet in length."<sup>18</sup>

Thanks to the publication of Lawton's and Ogilvie-Herald's book, I now had knowledge of where Core 7 was housed and went to London to examine it myself. I had taken Petrie's word on his observations of a spiral groove and had made assertions based on his observations. Because of the controversial nature of my theory, and the questions raised by Lawton and Ogilvie-Herald, I suspended those assertions subject to my own observations. It should not have been a surprise to me that not

only would I be criticized heavily for my theory of ultrasonic drilling, but also that Petrie's critical observations, which I used to support my conclusions, would also be questioned and ultimately rejected, for if they were to stand as observed by Petrie, then the theory that ancient drill holes were cut using copper and sand would be difficult, if not impossible, to substantiate.

It is noteworthy that Reid and Brownlee are confident in describing horizontal striations. On a truncated cone such as Core 7, it requires more than visual inspection to determine if a groove with a slight pitch, or distance between the start and end point in a 360° turn, is helical or horizontal. Petrie provided dimensions in his analysis, while neither Stocks nor Reid nor Brownlee nor Lawton nor Ogilvie-Herald have produced any measurements to support their assertion that Petrie's observations were incorrect—only that they “had examined the core in minute detail.”<sup>19</sup> Petrie, on the other hand, following his lecture to the Royal Anthropological Institute on April 24, 1883, in which he received comments from several attendees who proposed that his findings were more likely to have been produced using abrasives such as emery powder or corundum, provided a footnote for his article that appeared in the RAI's *Journal* the following year. The footnote provided a further analysis he had made of the core in which he took specific measurements of the groove at 90° angles around its 360° circumference four times.

In consequence of remarks on the granite core I have examined it more carefully. It offers apparently a complete proof that the lines were cut by fixed points, and not by rubbing of a loose powder; for the grooves are cut as deeply in the quartz as in the feldspar. And the feldspar being somewhat rubbed down, by general friction, the lines are actually cut through a greater thickness in the harder quartz which stand above the feldspar. Now no loose power could cut down to exactly the same depth in material of different hardness like quartz and feldspar; still less would it cut more out of the prominent quartz; but a fixed point must cut to the same depth in each material.

PETRIE'S CORE MEASUREMENTS.<sup>21</sup>

Rotation	0°		90°		180°		270°		360°		Pitch	
	in	cm	in	cm	in	cm	in	cm	in	cm	in	cm
Turn 1	3.14	7.98	3.11	7.90	3.07	7.80	3.08	7.82	3.06	7.77	0.08	0.20
Turn 2	3.06	7.77	3.03	7.70	2.99	7.59	2.97	7.54	2.95	7.49	0.11	0.28
Turn 3	2.95	7.49	2.94	7.47	2.91	7.39	2.87	7.29	2.83	7.19	0.12	0.30
Turn 4	2.83	7.19	2.82	7.16	2.80	7.11	2.77	7.04	2.76	7.01	0.07	0.18
Average	2.995	7.607	2.975	7.557	2.942	7.473	2.922	7.422	2.99	7.59	0.095	0.241

The spiral was described as a “drunk screw”; I therefore traced very carefully a normal plane at right angles to its axis and measured off the distances to the spiral: they are thus, at successive quarter turns in inches.\*<sup>20</sup>

Here if there were any “drunk” in the screw it would appear as an irregularity in the order of the means of each quarter; whereas they proceed as regularly as the small variations due to the texture will permit. There is not 1/100” irregularity in the mean spiral, though the pitch is 1/10”.

The spiral could not be produced by the mere withdrawal of the tool as it is too deeply cut to have been made without great force and it is wholly unlikely that a tool should be withdrawn with such regularity. Again as there would be from 1/10” to 2/10” of loose dust between the tool and the tapered end of the core, the cutting points of the crown would not reach it on withdrawal, and if they did so accidentally they would not touch the core in a continuous line all round, but only on one side.

That there are lines on modern drill cores is not the point. These cores are not tapered and hence the lines there can be produced by the crown.

\*Added to Petrie’s table are metric measurements and distance (pitch) between the start point and end point of each turn, which have also been changed from quarter turns to degrees.

On examination, it seems most probably to me that the coning was not due to stones set in different projections, but rather by a row of stones up the side projecting uniformly. Then when the top weight was tilted over to one side, or did not balance truly on the drill head, it would drag the drill over and thus make it enlarge the hole and taper the core as it cut downwards.

An engineer present has remarked to me that the manufacture of hammers good enough to dress down granite on such a very large scale, as in the Great and Third Pyramids, implies almost as much skill as any other method of dressing the stones.<sup>22</sup>

It is easy to be mistaken when we examine Petrie's Core 7 to try to determine if the grooves are spiral or horizontal. It is especially easy to make a mistake if we examine a photograph in which the core is tilted to one side—such as in the photograph pictured in *Giza the Truth*. Before traveling to England to examine the core firsthand, I suspected that their conclusions were in error after I examined their photograph in my graphics program. Plate 25 A shows Core 7 as seen in *Giza the Truth*. Plate 25 B shows Core 7 in a corrected orientation with a vertical central axis. A construction reference frame is provided so that the tilt can be seen, and a horizontal dashed line was added to compare it with the grooves on the granite core. The horizontal dashed line indicates that the grooves appear to be horizontal in plate 25 A and tilted in plate 25 B.

Jon Bodsworth of the UK has also taken a photograph of the granite Core 7, and it is frequently displayed on the internet tilted on a similar angle as the photograph in *Giza the Truth* angle and used to deny Petrie's spiral thread observations. To further explain the problem with analyzing a tapered thread when it is tilted on an angle, see figure 11.11, which is a common 3/4-inch pipe thread with 14 TPI (threads per inch). As you can see on the left, the pipe is tilted on an angle similar to the angle of Core 7 in plate 26 A. The horizontal reference line indicates that the thread is horizontal. The pipe on the right is in the correct orientation, and the reference line shows the thread as it should be—

around 180 degrees of the diameter in view, the line travels from the crown of the thread to the root.

The problem with analyzing a photograph of Core 7 is that, as Petrie pointed out, the groove wanders from side to side from a theoretical perfect helix. He noted that the groove doesn't vary more than  $1/100$  inch (0.010 inch; 0.254 millimeter). Yet with one thread wandering either toward or away from an adjacent thread, the published photographs by Lawton, Ogilvie-Herald, and Bodsworth have served to weaken Petrie's argument.

Notwithstanding my suspicions, I had to travel to London to have a firsthand look at the evidence. I contacted a colleague, Nick Annie, who lives near Cambridge, and he kindly arranged for us to visit the Petrie Museum and assisted me in the examination of the core. I am greatly indebted to him for his generous hospitality and support while I was in England during this period. As I pondered how to measure the groove on the core, I considered a fixture that would rotate it while a stylus traced the groove. This seemed too elaborate, even though it would have provided quantitative measurements. I didn't intend to measure every departure from a true helix that the groove may follow, but instead, I wanted to determine whether, as Petrie measured, it was actually a helix at all. I had only to confirm Petrie's observations that this was not a horizontal groove that began and ended at the same point—regardless of where that point was on the circumference.

The simple and most visual test to demonstrate this would be to wrap a common white cotton thread around the core, making sure it followed

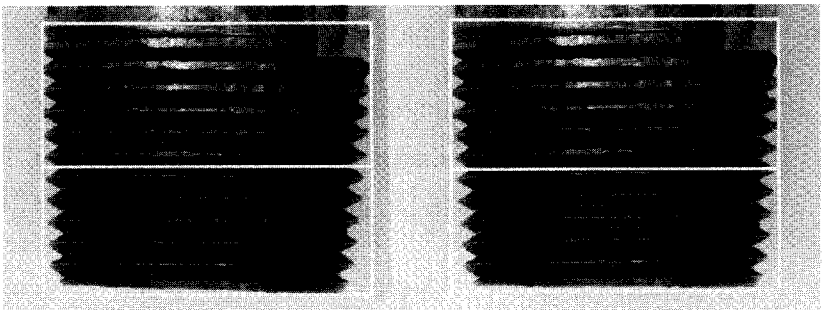

Figure 11.11. Threaded pipe tilted at the orientation of Core 7

the same groove. This test was performed on November 15, 1999, and results were posted at [www.gizapower.com/petrie/petrie1.htm](http://www.gizapower.com/petrie/petrie1.htm). Some readers objected to my observations and continued to accept Reid and Brownlee's observations as factual, even though, unlike Petrie and me, they had not produced anything other than a photograph of a tilted core and an opinion based only on that photograph. After examining the core myself, I was convinced of the correctness of Petrie's observations, but I realized that I had to gather even better evidence to support them.

Gas turbine engine—manufacturing engineers are very familiar with large and small cones that have varying ratios of height to top and bottom diameters. Sheet metal cones start out as a flat blank. They can be rolled either with or without any geometric features machined around the body of the cone. Today, this work is performed with computer software by which an engineer can create a cone, apply geometric features to its surface, and then unwrap it into a flat blank. The special software algorithms provide the geometry as it needs to be machined in the flat blank. With this in mind, and with my own testimony as well as Petrie's dismissed, it became imperative that I obtain a latex impression of the core so that I could present the grooves on a flat blank. This would make the entire surface of the cone visible, dismissing any doubt about the correctness of Petrie's observations and measurements.

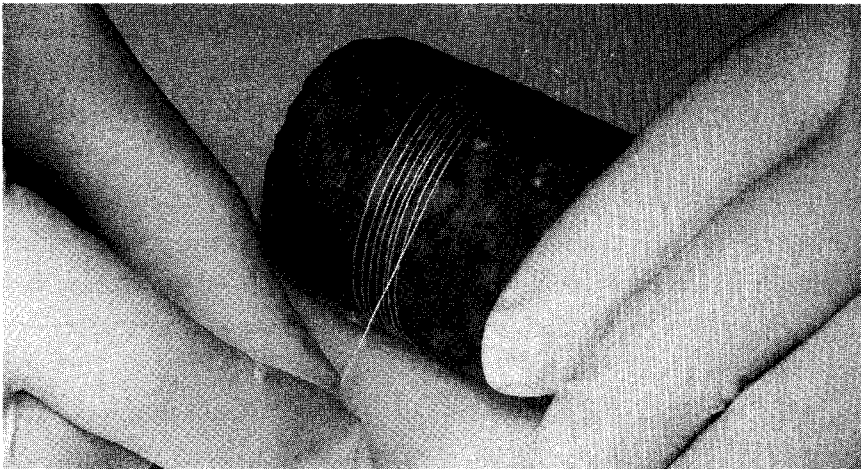

Figure 11.12. Core 7 with white cotton thread wrapped along a spiral groove

Following my first visit to the Petrie Museum, a geologist in England who was also interested in Petrie's Core 7 and had read both Petrie's work and mine contacted me via e-mail. Malcolm McClure had retired from British Petroleum and had a passion for investigating anomalous events from history and the present. McClure had found solutions to most mysteries, he told me, but was still not satisfied with what has been written regarding the grooves on Petrie's Core 7. He was not convinced they were horizontal, but he was also not quite convinced by Petrie or me that they were spiral either. I explained my dilemma to Mr. McClure and explained that I needed to examine the core again and also have a latex impression made of the core so that the grooves could be examined in two dimensions laid out flat. He contacted Dr. Stephen Quirke, the curator of the museum, and I gained permission to perform another analysis.

I arrived in England on March 30, 2003, and enjoyed the generous hospitality of Graham Hancock and his wife Santha Faiia, who provided me with accommodation in their London home. The following day I met Mr. McClure and Nick Annies, who would assist by taking photographs with his digital camera, and after breakfast at the University College London student hall, we headed over to the Petrie Museum.

I performed the same thread wrap around the core with Mr. McClure and Mr. Annies observing closely. After achieving sixteen wraps around the core, I could sense that Mr. McClure was anxious to try it himself, and he eagerly took the core and thread from me and set to work wrapping the thread around the core, being careful to fit it into the groove as he went. After performing several wraps himself, he declared that he was speechless, and pondered whether he, being the observer and knowing of the spiral claim for the core, had affected the outcome. This is because there are discontinuities in the groove, which is why Petrie noted only four continuous turns. Using the thread, and reaching a point in the turn where a discontinuity exists, uncertainty exists as to where the groove picks up again.

After our work was finished, we met with Dr. Stephen Quirke and discussed the possibility of having a latex mold made of the core. Dr. Quirke said he would forward the request to the conservationist, James

Hale. He also indicated that he looked forward to seeing the controversy surrounding this artifact eventually settled. Evidently, he fielded another request from a person who wished to perform an analysis on the core to see if, by rotating it and putting a phonograph needle in the groove it might reveal untold secrets from the past.

The latex peel provides another view of Core 7 and valuable information regarding the spiral groove's regularity and frequency along the length of the core. I received the latex impression in the mail in 2003, but my time and attention shortly thereafter became consumed with personal and family matters, and it sat for several years before I examined it. When I finally began to work with it, the edges had begun to split, so I knew that my intention of mounting it on a tapered mandrel would not work. Instead, I inserted a plastic tube on its interior and cut two square holes along its length near the splits. Then I cut a line between the square holes and continued with the cut to join with the splits at the ends (see figure 11.13).

It was my intention to unfold the latex into a flat blank and examine the grooves with the blank oriented to the notches. If the grooves were horizontal, they would appear as an arc that started and ended at the same point. Orienting the blank by using the notches that were once joined, I could analyze the entire surface. As seen in figure 11.14, points A and B identify the start and end point of an arc that would be horizontal or would have the same start and end point. Points C and

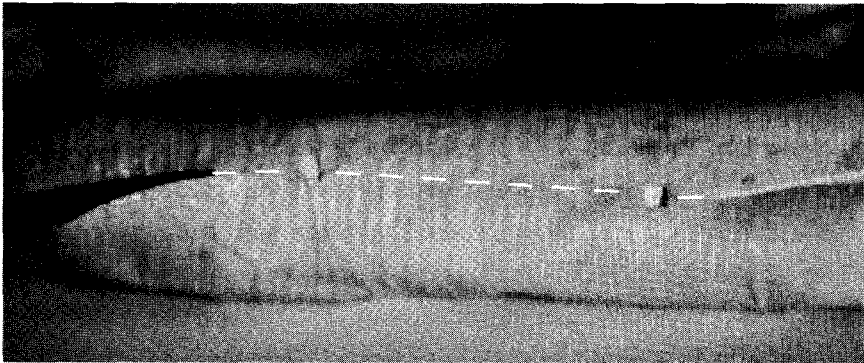

Figure 11.13. A latex impression of Core 7 showing notches and cut lines



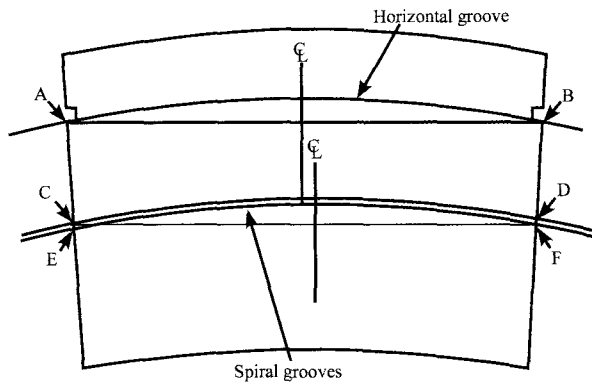

Figure 11.14. Geometry of a spiral groove on the unfolded latex impression of Core 7

D do not have the same start and end point and, therefore, represent a spiral groove. Point C joins with point F, completing one turn of the spiral and starting another.

I then flattened the latex on a piece of white construction board and photographed it using an 8-megapixel camera. Plate 26 has been color enhanced in order to highlight the grooves, and I have applied construction lines and arcs. Readers are welcome to perform their own analysis of these photographs, but my final conclusion based on Malcolm McClure's and my on-site inspection as well as the flat layout of the surface with arcs applied is that the groove around the Petrie Core 7 is a spiral rather than individual horizontal striations as claimed by Reid and Brownlee and others. Moreover, this spiral groove travels the full length of the core, and any discontinuities are due to the ripping out of the mica—a constituent of the granite—with some discontinuities seen as faint lines on the latex peel, but on the granite core they cannot be seen with the naked eye. On the whole, the quartz seemed to be fairly intact, but the extent of the ripping in the mica was extensive.

Taking into consideration Petrie's own account, my inspection in 1999, and Malcolm McClure's and my inspection in 2003, along with analysis of the latex impression of the core, the question as to whether the groove is horizontal or spiral appears to be answered. The groove follows a continuous helical path around the circumference of the core

down its full length, with periodic discontinuities along the way.

As seen in the close-up photographs of the latex impression, the irregularities in the groove cannot be overlooked and seem to argue against the theory that a tool with a precise mechanism for advancement was used. These inaccuracies, along with random movement of material removed from the hole during the process, though, support a strong argument that either a manual or an inaccurate, mechanically controlled tool played some part in performing the work. Upon closer inspection, I find no evidence to support the theory that ultrasonic drilling was employed. In fact, there is an abundance of evidence, when we look closely at the surface of the latex, to argue against this theory.

Petrie's measurement of 0.100 inch (2.54 millimeters) distance between the grooves is not supported by the evidence seen in figure 15. The grooves seen here range from 0.050–0.080 inch (1.27–2.03 millimeters), though they depart at places and are closer to what Petrie measured. Also, the depth of the groove, as seen in figure 11.16 varies

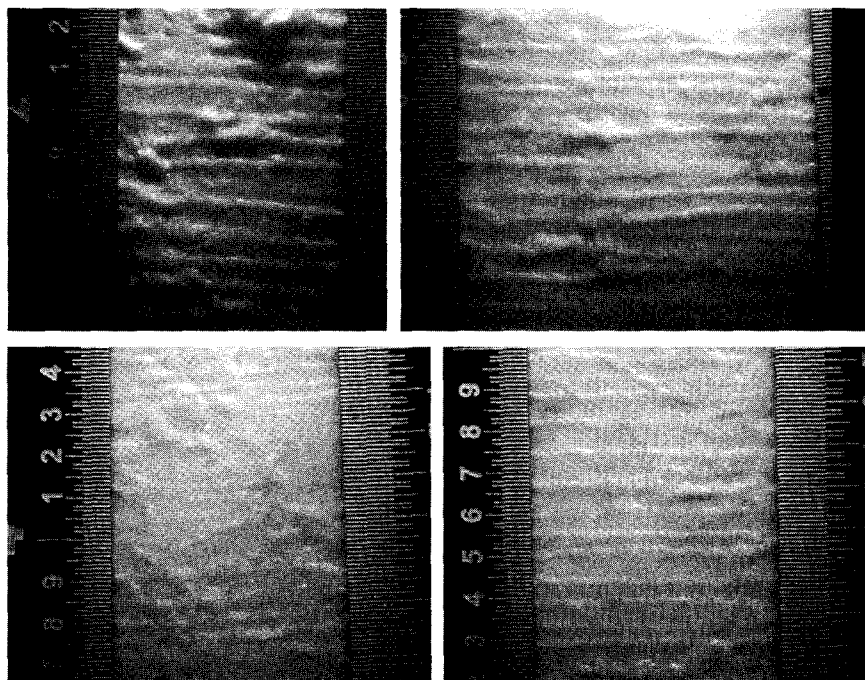

Figure 11.15. Close-up photographs of the latex impression of Core 7 showing random bubbles and diverting runs on the surface

to a maximum depth of 0.0075 inch (0.190 millimeter). Inexplicable features that become more prominent when seen on the magnified surface are the raised areas where, presumably, material was by some means gouged out in the drilling process. They appear like bubbles on the surface. The latex impression also clearly reveals an addition to the grooves, with short grooves (or runs) connecting one groove to the next in a relatively short distance. In some areas, the additional run is almost vertical to the axis of the core. This feature is not clearly evident on the core itself and is not mentioned by Petrie or any other observer that I am aware of.

After failing to obtain a good photograph of Denys Stocks's drilling experiments, other than what was in his published articles and book, I was left wondering whether there can be any reasonable link between the methods he used and those the ancient Egyptians used and impressed upon their granite. Though Mr. Stocks indicated that final twisting of the drill at the conclusion of the drilling created the spiral grooves, it is hard to believe that random scratches from a reciprocating bow drill would organize themselves into a continuous spiral down the

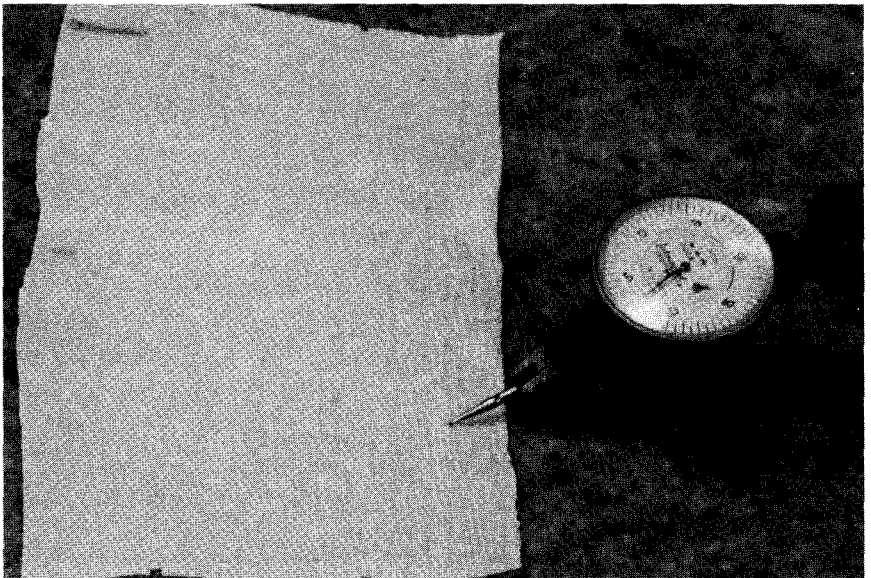

Figure 11.16. Inspecting depth of groove on latex impression

length of the core with a few twists of the drill. Nonetheless, Stocks is the man with the evidence that allowed him to form this opinion, so without access to his evidence, I was left with no option but to drill a piece of granite myself.

I obtained a piece of red granite from a local monument dealer and defined the outside diameter of a 2.125-inch (5.4-centimeter) copper tube on the top of a flat surface of the granite. After chiseling a shallow groove around the marked circle using a carbide-tipped drill point, I then poured silicon carbide 80-mesh grit into the groove. (Silicon carbide has a Mohs hardness of 9.5, whereas quartz sand has a hardness of Mohs 7, the same hardness as the quartz in the granite.) I then began to rotate the drill assembly, which was weighted with 60-pound (27.215-kilogram) lifting weights, clockwise and counterclockwise. At first I tried using a bow strung with leather cord but found it inefficient and awkward, so I equipped the assembly with a common machine handle and rotated it without the bow. I doubt that the granite knew the difference.

After reaching about a 0.25-inch depth, I switched to a diamond hole saw and took the hole to its maximum depth of 1.64 inches (4.165 centimeters). Then I inserted the copper tube again and worked the hole down further. Having my hands in contact with the drill assembly was beneficial, as I was able to feel when fresh grit was needed to be introduced into the slot—it didn't take long for the grit to wear down to nothing but dust, and the difference in the vibration through the drill assembly between fresh grit and dust was substantial.

As I worked the tube deeper into the granite, I consciously wobbled it more than I needed to so that the surfaces of the core and the hole were ground away. After reaching a depth of 2.265 inches (6.73 centimeters), I used a copper wedge-shaped mandrel and attempted to knock the core out of the hole. Stocks does not say what material his chisels were made from, but I assume they were copper as the ancient Egyptians allegedly didn't have steel. If so, he was more successful than I, because my copper wedge wouldn't budge the core and became deformed as the granite resisted the copper's inherently soft characteristics. Ultimately, I resorted to a steel chisel and with one blow the core gave way.

The statistics of the hole, core, and drills are as follows:

Hole	
Diameter at the top	2.18 inches (5.54 centimeters)
Depth	2.265 inches (6.73 centimeters)
Core	
Diameter at the top	1.935 inches (4.914 centimeters)
Diameter at the bottom	2.005 inches (5.09 centimeters)
Copper tube	
Outside diameter	2.125 inches (5.397 centimeters)
Inside Diameter	2.00 inches (5.08 centimeters)

Although I tilted the tube intentionally to the side after using the diamond hole saw, striations made by the diamond were not all ground away. The areas where they exist on the core are evident in figure 11.18. The larger percentage of their marks, however, were removed as the tube ground the hole to depth. The diamond hole saw striations reveal that another method, suggested by Petrie, does not produce the kind of spiral groove evident on Core 7. Similarly, the area worked with abrasive and copper do not produce the striations revealed in ancient Egyptian holes, i.e., figure 11.18 top left and top right, which are reflected on Core 7.

Another feature that was evident as a result of my drilling experiment, and which also serves to dispel both the copper and abrasive *and* the theory of ultrasonic drilling, is the finish on the surface of the hole and core. When using sand, or any other abrasive to remove material, what other finish would we expect other than a sanded finish? Even if I was able to dig deeper grooves into the granite, as I am sure Stocks was able to, the surface finish on the granite using an abrasive method is unlike the surface finish on Core 7 or on the holes that the ancient cores came out of. As we can see in plate 25, Core 7 is not sanded, but appears to have a polish to it.

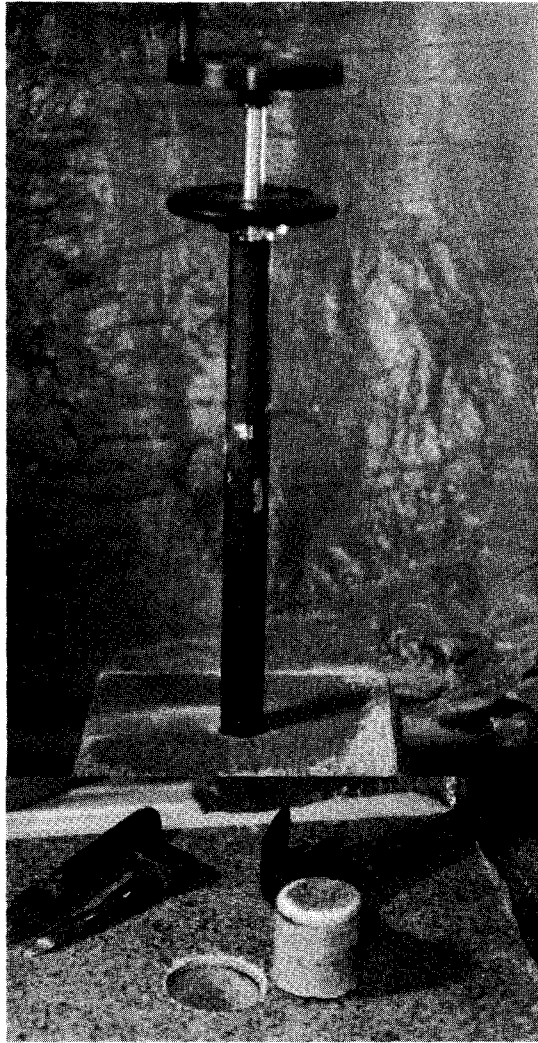

Figure 11.17. Top: Drilling rig.  
Bottom: Hole and core with  
chisel wedge and hammer.

With respect to what methods the ancient Egyptians used to create Core 7, I have no real answers. However, to replicate the core and holes, an experimentalist might consider softening the granite using heat. Does the burnished finish on the surface of Core 7, as well as the random runs between the grooves and the proliferation of depressions where mica is removed, along with the spiral groove itself, indicate that these characteristics might be replicated if the granite was brought close to its melting point?

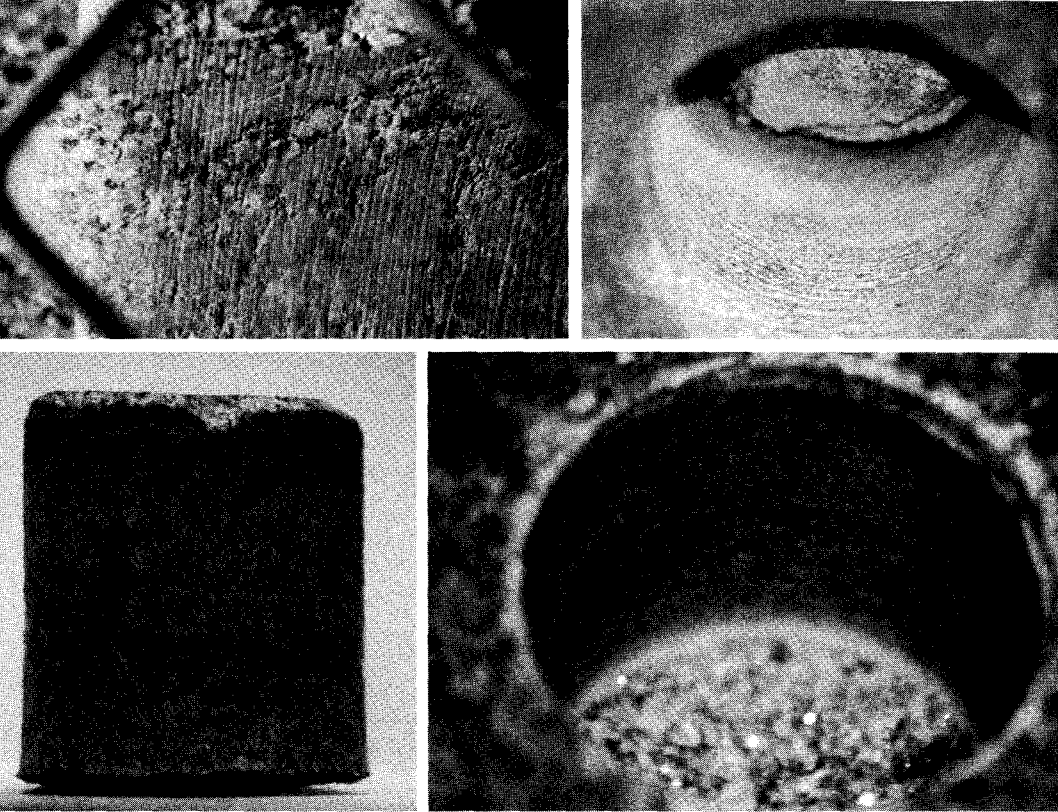

Figure 11.18. Top left: Drilled hole at Abu Ghorab (courtesy Patrice Pooyard). Top right: Close-up of drilled hole in the Valley Temple lintel block. Bottom left and right: Drilled hole and core using a copper tube and silicon carbide 80-mesh abrasive.

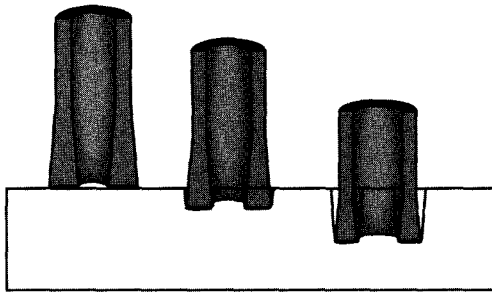

Figure 11.19. Example of wear on the cutting edge of a tubular drill

Such a method may involve using a tool—similar to a thermal lance—that sacrifices its material in the process, as depicted in figure 11.19. Until an answer is found, Petrie's Core 7 will remain in its case at the Petrie Museum as evidence of one of Egypt's mysterious lost technologies.



## 12

# Suspending Disbelief

*Have the wisdom to abandon the values of a time that has passed and pick out the constituents of the future. An environment must be suited to the age and men to their environment.*

PROVERB FROM THE EGYPTIAN INNER TEMPLE,  
IN ISHA SCHWALLER DE LUBICZ,  
*HER-BAK: EGYPTIAN INITIATE*

Here, I have attempted to provide a more complete description of artifacts that Egyptologists seek to explain in their books on ancient Egyptian craftsmanship and engineering. My analysis of the various attributes of the artifacts presented is by no means exhaustive, but it provides us with a better idea of what steps researchers must take in order to say with conviction that they have discovered the means by which the ancient Egyptians built their civilization in stone.

As we come to grips with what has been discussed here, it would help if I arranged—in order of significance, from a manufacturing perspective—the artifacts that I have discussed in this text. I'll assign 1 to the highest level of sophistication and work down to 6, then I'll explain why I have ranked them in this order. Of course, this ordering reflects my own opinions, which are biased toward manufacturing technology. Construction engineers or architects may order them



differently, but this ordering is meant purely to provide a means to understand what could be considered the development of knowledge and the exercise of technological sophistication. My list is ordered by site and the principle artifact at the site that stands out as the most sophisticated expression of industrial art.

1. The Temple at Luxor: the Ramses statues and obelisks
2. The Temple of Denderah: the Great Hypostyle Hall columns
3. The Giza Plateau: the contoured granite blocks and the pyramids
4. The boxes in the Serapeum
5. Abu Roash: the sawed granite block
6. The Petrie Museum and the Unfinished Obelisk

Surprising to many may be my selection of Luxor over the pyramids at Giza—which have been the only surviving members of the Seven



Figure 12.1. When we wish to see, we open our eyes. When we wish to see more clearly, we open our minds.

Wonders of the Ancient World. I believe strongly that Luxor should be included on this list or should grace the top position on the newly drafted Wonders of the World (as recently voted on by people around the world). The finalists of this Internet popularity contest are, without ranking: Chichén Itzá, Mexico; Christ the Redeemer, Brazil; the Colosseum, Italy; the Taj Mahal, India; the Great Wall of China; Petra, Jordan; and Machu Pichu, Peru.

The reordering of the Wonders of the World by popular vote on the Internet was not taken kindly by Egyptian officials. Zahi Hawass would not dignify the populist poll by having the pyramids included in a contest in which the results were based on an emotional connection with a site, rather than on scholarship. In fact, he demanded that the pyramids be excluded from the voting. “Just think about it, could you have put the statue of Christ the Redeemer against the Abu Simbel?” Hawass asked, and argued further that those who have voted may not have even set foot in Luxor, Karnak, or the Valley of the Kings. “Just how could they let people rewrite history? History has been written by scholars who do important works for people to understand and respect, but this new voting is not correct. . . . We only deal with UNESCO, with official bodies and institutions, or respected individuals, but not a small tour company that does not have credibility,”<sup>1</sup> he said.

Hawass’s concerns were heeded by the organizers, and the pyramids were taken off the list for the American Idol–style voting contest. Regarding the pyramids, the organizers of the contest made conciliatory comments on their website:

The Pyramids of Giza, the oldest and only Ancient Wonder still standing, are testimony to perfection in art and design, never subsequently achieved. They were built by planners and engineers purely to serve their earthly rulers—who were also their gods. Philosophy did not exist at this time, and creation was not subject to any questioning. The pyramids are the purest of constructions, built for eternity. After careful consideration, the New7Wonders Foundation designated the Pyramids of Giza—the only remaining of the 7 Ancient

Wonders of the World—as an Honorary New7Wonders Candidate. Therefore, people could not vote for the Pyramids of Giza as part of the New7Wonders campaign. This decision has also taken into account the views of the Supreme Council of Antiquities of Egypt and the Egyptian Ministry of Culture. The Pyramids are a shared world culture and heritage site and deserve their special status as the only Honorary Candidate of the New7Wonders of the World campaign. The New7Wonders of the World were chosen by the people across the globe from the remaining 20 New7Wonders candidates.<sup>2</sup>

The results of the poll are difficult to accept for many people because they are the result of votes cast by people who may have not visited any of the sites or may have only visited one or two. The poll also lacked specific details of each of the sites, as well as instructions on what criteria were to be used in forming an opinion. Nonetheless, it captured the imagination of one hundred million people around the world, each of whom voted for their favorite world heritage site, and I am sure if the pyramids had been included in the worldwide vote, they would surely have been voted 1 on the list.

Picking a “favorite” among the treasures left behind by generations past is a personal matter and one that speaks to the emotional attachment we form with a site. Descriptions and photographs of Machu Pichu have always captured my imagination, but when I visited the site in 2005, I was left without the sense of awe and wonder that I expected. Others who have visited the site claimed that to them it was like coming home, and that they felt a deep connection to the history and culture of the Andean people. Those who feel this way cannot be told that they are wrong and that they have selected the wrong site because an official body of scholars disagrees.

When I visited Egypt in 1986, I was interested only in the pyramids and had no desire to travel south to see the Egyptian temples. A couple I met at the Mena House Hotel near the Giza Plateau, confirmed my view when I ran into them after they had visited the temples and claimed they had seen enough of the temples and had become tired of

them. This all changed after I made my first visit. Subsequently, Luxor became my number one Wonder of the World because of the technological prowess expressed in its temples, statues, and obelisks.

## LUXOR AND THE RAMSES STATUES

To me, the Ramses statues symbolize technology in motion. In his masterful work *The Temple of Man*, Schwaller de Lubicz demonstrates that the Temple of Amun Mut Khonsu was designed to symbolize man in motion. Key architectural characteristics of the temple were associated with different parts of the human body, and in the Ramses Hall, where the walking statues of Ramses are situated, the orientation of the hall allows the legs of the superimposed human to be positioned in a natural walking stance. This brilliant anthropomorphic analogue construction was created to harmonize with the stages of human development as well as its relationship to the universe.<sup>3</sup>

From the perspective of manufacturing evolution, the Ramses statues contain both the attributes of the boxes in the Serapeum (two-dimensional surfaces created from straight-line geometry) and the contoured blocks at Giza (three-dimensional surfaces created from straight-line and circular geometry) and go further in complexity to create surfaces that morph precisely between separate and different composite radial geometric shapes. That the ancient Egyptians accomplished this again and again, and that the information encoded in their statues is still accessible three thousand years after they were created, is a testament to ancient Egypt's engineers and artisans. The Ramses statues provide a legacy of ancient knowledge that has receded into the shadows of history, but like the Great Pyramid at Giza, they are still singing their song for those who wish to hear. When Dr. Zahi Hawass asked how we could compare the statue of Christ the Redeemer in Brazil to Abu Simbel, he posed a relevant question. Both are an expression of power and authority, but from an engineering perspective, they are quite different. Abu Simbel, which is fronted by four seated Ramses figures that are more than 60 feet high each, was carved from native sandstone bedrock while the statue of

Christ the Redeemer, reaching 120 feet (38 meters) in height with its pedestal, was made of reinforced concrete and soapstone. These materials were chosen for the statue's construction because of their ease of use and load capabilities, given the outstretched arms of Christ. Abu Simbel was crafted more than three thousand years ago, and work on Christ the Redeemer began in 1921 and was finished in 1932.

During the New7Wonders campaign, there was a separate campaign in Brazil called *Vote no Cristo* (vote for the Christ), with corporate sponsors donating large sums of money to have the statue voted into the top seven Wonders.

Meanwhile, the number one Wonder of the World according to my vote, given their materials, geometry, precision, mass, and endurance, received no attention at all, except for Dr. Hawass's simple plea to make a proper comparison. Unfortunately, his plea has apparently fallen on deaf ears.

## THE TEMPLE OF DENDERAH

The pyramids at Giza and the Temple of Denderah are distinguished by their complexity. From the sheer amount of stone used in construction, the pyramids would most obviously take the number one spot, and readers of this text may still argue that they should be there. Yet from the perspective of manufacturing and precision assembly, the Temple of Denderah provides a more complex arrangement of geometric elements that required more in the way of three-dimensional surfacing techniques than anything found on the Giza Plateau.

Though the pyramids have rectangular and angular blocks that are cut and fitted with precision, the Temple of Denderah has rectangular blocks that are fitted with precision *and* have also been decorated with stunning three-dimensional reliefs *before* being assembled into the temple. On top of this, the Hathor capitals in the Great Hypostyle Hall have exact, three-dimensional surfaces that, whether cut before or after being assembled, are not only an amazing demonstration of artistry and skill, but also are precisely aligned with each other, from column to column.

## THE GIZA PLATEAU

Depending on what discipline you consider to be Egypt's master craft, the Giza Plateau has sufficient evidence to move it to number one on any list of Wonders. If we consider the pyramids to have been built merely to be used as tombs, they would reside, in my view, at number three on the list. If the sophisticated science that is thought by some to reside within the pyramids' construction is proved to have merit, then they would resist all challenges for prominence among all artifacts anywhere in the world.

For the purposes of this book, however, we are focusing on the artisans' master craft, and on the Giza Plateau, the contoured blocks offer a transition between the simple, flat surface geometry found in the pyramids and the Serapeum and the more complex geometries that were revealed in the statues of Ramses II after ancient tools had plowed out thousands of tons of diorite and granite with apparent efficiency and ease.

## THE BOXES IN THE SERAPEUM

The complexity of a box is not quite that of a statue or even the cornice block near the Valley Temple at Giza. Yet the message from the tunnels of the Serapeum is one of metrology and exactness. While precision is inferred from the geometry and symmetry of the statues, the boxes in the Serapeum let us know quite clearly that the ancient Egyptians were no strangers to such exactness. The lapidary work on the insides of these boxes should invite further studies by Egyptian engineers who can interpret the information that is crafted into the meticulousness with which these giant, enigmatic artifacts were made.

## THE SAWED GRANITE BLOCK AT ABU ROASH

The stone at Abu Roash opens up an entirely different perspective on pyramid building in ancient Egypt. When we ponder how such a massive construction program could be executed with efficiency and precision, we

understand more if we consider that machines existed that were up to the task. The stone at Abu Roash provides an important piece of information for our understanding of how tens of millions of pyramid blocks were cut.

### THE PETRIE MUSEUM AND THE UNFINISHED OBELISK

The Petrie Museum offers evidence to support the need for a reevaluation of the kinds of tools used by the ancient Egyptians to cut their statues and other stone artifacts. Petrie's Core 7 provides an important clue that a more efficient method of hole drilling was used by the ancient Egyptians than those proposed by Egyptologists. The examples of lathe work and the nicks and grooves on statues that were left by tools that could not have been simple chisels or stone balls all contribute to a radically different view of the capabilities of the ancient Egyptians. The Unfinished Obelisk provides information about highly efficient quarrying techniques, whereas the finished obelisks display evidence of the use of tools that were a mere  $\frac{1}{8}$  inch wide and were applied in a controlled way so as to leave sharp edges at the entrance point.

### CHRONOLOGICAL PROGRESSION

Taking my six Wonders of Ancient Egypt in order of importance and applying their historical dates, it would appear that proficiency and skill spanned the entire timeline from the building of the Great Pyramid in the fourth dynasty to the crafting of the boxes in the Serapeum in the eighteenth dynasty, more than two thousand years later. The flat surfaces and square corners measured on the inside of the sarcophagus in Khafre's pyramid, for instance, are no different from the flat surfaces and square corners inside the boxes in the Serapeum. What distinguishes the two kinds of boxes is their size. Nonetheless, the evidence suggests that either the ancient Egyptians had developed a high level of precision early in their history and carried it forward through to the time of the Greeks and Romans or, as discussed in chapter 5, the

provenance of the site is so clouded with confusion that the dating of the granite boxes is affected by evidence left behind by later cultures. These giant boxes, for which there are no dating methods, may have resided in the tunnels for millennia—and without any inscription from the Ptolemaic period describing how the boxes were quarried, moved, and crafted to such a high order of precision; or evidence of tools and metrology instruments that reflect such precision; or machines that must have been used to create them, it is more than likely that they were created close to the same time as the pyramids, which also may have an earlier date of construction.

If I consider all the evidence within the same engineering context without regard to the time each example was built, I am compelled to suggest that the ancient Egyptians had to have used sophisticated machines that cut diorite and granite with little difficulty. The evidence suggests that they had lathes and that the lathes were built with precise bearings that regulated the rotation of the spindle. The contoured blocks on the Giza Plateau suggest that they had machines that cut exact, three-dimensional shapes on three axes.

The telltale marks on a Ramses head at Karnak and the indentation above the eyebrow suggest that a rectangular tool was directed along a precise path while oscillating at high frequency, like a jack hammer, against the surface. When the tool came to the eyebrow, it paused briefly, but the oscillations did not cease, and the tool cut deeper where it rested. Such signs are signatures of machining and are well-known consequences of allowing a tool to rest along its path while the cutting force is still applied. (This could be a lathe, for which the tool movement may stop but the work piece keeps rotating; or it could be a milling machine, for which the axes stop moving but the end mill continues turning.) Any machinist would recognize these marks.

The accidental grooves found in the statue of Amun and Mut in the Luxor Museum are proof of tools that do not exist in the archaeological record. These grooves provide evidence of rotary grinding wheels that were used to cut the fine details on the statues.

How were these tools guided? How was the symmetry of the Ramses



statues created? The tool marks plus the three-dimensional accuracy present clear evidence that only a precisely guided tool could produce these statues, and further, that the human hand cannot guide a tool with such precision. Today, we would use computer numerical controlled (CNC) machines. Fifty years ago, we would have created a model and controlled the movement of the machine with a stylus that followed the contours of the model. What technology was available to the ancient Egyptians?

It is significant to note that, excluding the boxes in the Serapeum and the interiors of the coffers in Kufu's and Khafre's pyramids, some of the precise artifacts I have studied and include in this book were not finished to a high level of polish. Nor do they have the striations caused by a rough abrasive that could have been used to achieve the exact geometries they demonstrate. Creating a surface to precise geometry, whether the geometry is flat-line or circular, if performed by hand work, would require spot finishing—that is, attending to areas that require the discreet removal of material to achieve their final, precise shape. It is surprising, therefore, to find surfaces that are finished to within 0.001 inch (0.0254 millimeter) that do not exhibit any signs of polish at all. Having produced precision surfaces by hand finishing and with machine-guided tools, when I examine surfaces created by the ancient Egyptians, it is clear to me that machines were involved in their creation.

Finally, there is the important question of precision. Chiseling and hand polishing a surface that compares to a surface produced by a modern machine when the object's purpose is to serve as an architectural element above a doorway, for example, does not make sense. It is completely unnecessary for the function it fills. The architectural elements found near the Valley Temple on the Giza Plateau and at the Temple of Denderah and other temples, however, *were* crafted by precise machine tools that produced precise products requiring no secondary finishing.

### WHERE ARE THE MACHINES?

No machines have been found in the archaeological record to support these assertions, but there is an abundance of circumstantial evidence

that leads to such conclusions. Are the machines still intact and lying under the desert sand? Or were they removed completely from the areas? Or could it be that all of this evidence points to an earlier civilization that suffered a cataclysm of such magnitude that much of what existed was destroyed, and what remained was susceptible to erosion, decay, and corrosion, and slowly disappeared over a long period of time? This brings us back to Robert Schoch's evaluation of the erosion pattern on the Sphinx and the Sphinx enclosure. He claimed that the period of time when sufficient rain fell in Egypt to cause this erosion was seven to nine thousand years ago. Is this sufficient time for ancient machines to turn to dust and blow away? It seems incredible to imagine, but there is reason to suspect that this could have happened.

Pushing the history of the pyramids back in time is not a new concept. Stephen Mehler, in his book *Land of Osiris*, refers to his work with Abd'l Hakim Awyan, an Egyptian native who was considered a cultural wisdom keeper and has a lineage that can be traced back to predynastic Egyptians known as Khemitians. (Their homeland was known as Khemit—or KMT, given that ancient Khemitians did not use vowels in their language.) While it is only hearsay passed down through countless generations, the opinions of the elders should be considered, and Hakim's opinion on the age of the pyramids would have it pushed back even further than what Robert Schoch would support, given the geological evidence. Mehler writes: "When I first heard Hakim speak of the Sphinx in November 1992, he calmly asserted that she was over 52,000 years old."<sup>4</sup>

Stories of an older civilization have long been maintained in the traditions of indigenous peoples, who refer to them as a time when gods ruled the earth. This period in Egyptian lore is generally dismissed by Egyptologists as legend, and those who would propose such ideas, such as Schwaller de Lubicz and others, are considered New Age (in some circles a pejorative label) and are ignored. Yet there is mounting evidence and professional opinion that lead us to consider the old legends and take them more seriously. One example is the opinion of architect Dr. Hossam Abulfotouh, who maintains that the so-called workers' village

of Giza could not have been built by the same artisans who built the pyramids. We are left, therefore, to consider the idea of an older culture that was more gifted in architectural design and execution than has been commonly accepted. There is no question that the Great Pyramid is the most sophisticated and precise of all the structures on the Giza Plateau, and, frankly, of all the buildings in the world.

If we follow the idea of an older civilization, therefore, the pyramids would have already been there before the first dynasty of the ancient Egyptians. The Great Pyramid was, most likely, the zenith of construction on the plateau, and the other pyramids were likely built before it was. Yet something happened to the culture that built the pyramids, and when Khufu came on the scene, he naturally chose the most impressive structure—the Great Pyramid—as his own, and his heirs took turns in claiming the rest. What event could have brought death and destruction to this ancient civilization that is referred to in Egyptian lore as being inhabited by gods of the First Time?

As I concluded my research in Egypt, I pondered what might have driven the ancient Egyptians to devote their resources to such enormously difficult tasks, and I wondered how an advanced civilization would react if it had knowledge of impending doom. Perhaps it would turn its genius and industry into leaving a message that would survive the coming cataclysm and provide a technological imprint to say to future generations, “We were here. This is who we are and what we are capable of doing.”

Modern society builds obsolescence into everything it makes. The ancient Egyptians may have spent their last days on earth building for eternity and preparing for the afterlife. They were obsessed with the afterlife. It was all that mattered to them. Is it not all that matters to us too? If so, then why do we wait until we are faced with our own mortality before giving it any attention? It seems that the continuity of generations provides us with a comforting belief in our immortality: a part of us will live on after we die. We are also comfortable leaving things for the next generation to fix or address. Yet if we knew that there would not be another generation, how would we behave? If we knew that a

day was coming when most of life on the planet would cease to exist, what kind of shock would that give our psyche? Earthly matters that normally consume our minds would surely be replaced with thoughts of the afterlife and how we would continue after we die.

Did the ancient Egyptians have knowledge of an impending catastrophe? Their marvelous spires of granite at Karnak were protected by walls, though we don't know if those walls were filled with sand or not. Why was it necessary to build a wall around Hatshepsut's obelisk? Many obelisks were not similarly protected, and some of them had fallen in prehistory. Massive statues, like those of Ramses at the Ramesseum, had toppled over at some time in prehistory. There was an event that devastated this civilization, and there are signs that they knew it was coming.

Mud brick walls were built around some structures. Some smaller statues now exhibited in the Luxor Museum were buried in the temple, and a scene on the ceiling of the Great Hypostyle Hall at Denderah describes the goddess Nut overarching and protecting the solar barques in procession through the heavens as they carry their dead through the Duat. Perhaps the Egyptians used their time left on the planet to cut deep into the hillside in the Valley of the Kings and create an extensive network of tunnels and chambers. Was KV5, the recently explored underground complex credited to Ramses II and his family, with its one hundred twenty-one chambers supposedly created for his sons (did he not have daughters?), actually built as an attempt to survive impending catastrophe and to continue the species?

The purpose of this book is not to answer these questions, but to propose possibilities based on the artifacts that are left. To question the historical account of ancient Egypt is disturbing to some. The responses to my previous writing on the subject have prompted me to present better evidence. I believe I have accomplished this here. Others will no doubt weigh in on the subject, and I am sure some will object to my conclusions.

Though the subject of the kinds of tools used by the ancient Egyptians to cut stone holds a continuing interest for many professionals

and laypeople alike, the debate has to move beyond the question of what cut the stones to an even more crucial question: What guided the tools? The amazing geometry and precision of ancient Egyptian artifacts cannot be lost in the debate about whether a coring tool left its mark as helical or horizontal grooves. Though resolving this question is important, it would not be as important without the massive amount of contemporaneous evidence that demands another thorough examination of our past. When we attempt to answer questions of how the ancient Egyptians created their monuments, the most difficult aspects of the work must be identified and replicated to the same form and precision as the originals.

Why is this important? For many people manufacturing precision is an abstract concept with which they have no personal involvement. Precision manufacturing demands strict adherence to a blueprint or engineering drawing. To replicate an object that is already made, it is necessary to make blueprints describing every characteristic of the object and to make sure that the copy of the original is the same.

We are surrounded by precise objects, which populate and shape our environment, but there was a time in history when this was not the case. In less time than the whole of ancient Egypt's fourth dynasty (2613–2494 BCE), the period of one hundred nineteen years, during which the Great Pyramid was supposedly built, civilization has moved from a predominantly manually intensive agrarian society in which the apprentice was unpaid and beholden to the master to learn his trade to one that trains schoolchildren how to live with technology so sophisticated and rapidly changing that often the children are called upon to teach their parents how to use it.

My background in precision machining has given me an enduring and profound respect for what this dizzying progress of knowledge and technology has brought to our society. Over the years, scores of engineers and craftspeople have contacted me to tell me they share my perspective. One such engineer is Steven Garcia from Chicago, who visited Egypt more than forty years ago. In one of my discussions with him, he complained to me that I was not assertive enough in my treatment of

ancient Egyptian artifacts and that I should be adamant that they could not have been produced without machines. Yet though I may not have been overly assertive in my beliefs on this subject, what I have written in the past has opened the debate. Since I started to publish my thoughts on this subject, I have continued to study the responses to my work as well as the evidence that has been offered to support the academic theories.

Taking into account all the foregoing evidence, I will assert now, unequivocally, that what has been found in the archaeological record and used by experimentalists must be dismissed as grossly inadequate to the task of producing the marvelous artifacts of ancient Egypt. What, however, do we replace them with? How were the Ramses statues crafted? How much time would it take a sculptor to create the 1,000-ton Colossi of Memnon? Or the 1,000-ton Ramses at the Ramesseum? Or the four colossal seated statues at Luxor?

Appearing on the base of the Ramesseum Ramses is a verse by the Greek historian, Diodorus Siculus: "King of Kings am I, Osymandias. If anyone would know how great I am and where I lie, let him surpass one of my works."

The challenge issued by Ramses to Diodorus Siculus in the first century BCE has not been met, but when it is fulfilled, Egypt's true manufacturing genius will be recognized and understood. When we consider a culture that created an array of artifacts that in their variety exhibit incredible size, symmetry, and precision in materials that even today are among the most difficult on earth to shape and move, and we know what could not have produced them, the mystery of ancient Egypt looms before us like a stupendous abyss between that astonishing time in human endeavor and our own. It beckons to us across the ages and demands that we are as exacting and uncompromising in our quest for answers as the Egyptians were in crafting the artifacts that confront us with the questions and the challenge: "What am I? How did I come to exist? Build another just like me."



# Notes

## INTRODUCTION

1. René Descartes, “Discourse on the Method of Rightly Conducting the Reason and Seeking for Truth in the Sciences,” *Great Books of the Western World*, vol 31 (Chicago: William Benton, 1952), 47.

## CHAPTER 1. THE SHADOWS OF LUXOR

1. R. A. Schwaller de Lubicz, *The Temple of Man* (Rochester, Vt.: Inner Traditions, 1998).
2. John Anthony West, *Serpent in the Sky: The High Wisdom of Ancient Egypt* (Wheaton, Ill.: Quest Books, 1993).
3. Edward Malkowski, *The Spiritual Technology of Ancient Egypt* (Rochester, Vt.: Inner Traditions, 2007).
4. See [http://thinkexist.com/quotes/bruno\\_walter/](http://thinkexist.com/quotes/bruno_walter/) (accessed December 26, 2009).
5. R. A. Schwaller de Lubicz, *The Temple of Man*.

## CHAPTER 2. THE SHADOWS OF RAMSES

1. See [http://en.wikipedia.org/wiki/Fibonacci\\_number](http://en.wikipedia.org/wiki/Fibonacci_number) (accessed April 13, 2008).
2. Sixth century CE; See [http://en.wikipedia.org/wiki/Indian\\_mathematics](http://en.wikipedia.org/wiki/Indian_mathematics) (accessed February 4, 2010).
3. R. A. Schwaller de Lubicz, *The Temple of Man*.
4. *Ibid.*, 144.

5. "Why the Pyramids," [www.egyptvoyager.com/aida\\_mainpage.htm](http://www.egyptvoyager.com/aida_mainpage.htm) (accessed February 4, 2010).
6. Michael Schneider, *A Beginner's Guide to Constructing the Universe: The Mathematical Archetypes of Nature, Art, and Science* (New York: Harper Collins, 1994), 241.

### CHAPTER 3. THE RAMSES CHALLENGE

1. Isha Schwaller de Lubicz, *Her-Bak: The Living Face of Ancient Egypt*, quoted in "From the Outer Temple," [www.duboislc.org/html/Proverbs.html](http://www.duboislc.org/html/Proverbs.html) (accessed February 4, 2010).
2. Evan Hadingham, "Unlocking the Mysteries of the Parthenon," *Smithsonian* (February 2008).

### CHAPTER 4. THE SHADOWS OF KARNAK

1. Evan Hadingham, "Unlocking the Mysteries of the Parthenon," 39.
2. Denys A. Stocks, *Experiments in Archaeology: Stoneworking Technology in Ancient Egypt* (London: Routledge, 2003).
3. Nicholas Penny, *The Materials of Sculpture* (New Haven: Yale University Press, 1993), 21.
4. "Preserving Ancient Treasures Using Modern Technologies," [www.world-mysteries.com/sci\\_3dm.htm](http://www.world-mysteries.com/sci_3dm.htm) (accessed December 16, 2009).

### CHAPTER 5. THE SHADOWS OF THE SERAPEUM

1. Mohamed Ibrahim and David Rohl, "Apis and the Serapeum," *Journal of the Ancient Chronology Forum* 2 (1988): 10.
2. Strabo, *Geography*, Book XVII, 23, <http://rbedrosian.com/Classic/Strabo17b.htm> (accessed May 20, 2010).
3. Jimmy Dunn, "The Serapeum of Saqqara," [www.touregypt.net/featurestories/serapeum.htm](http://www.touregypt.net/featurestories/serapeum.htm) (accessed January 16, 2010), quotation of Auguste Mariette's *Le Serapeum de Memphis*.
4. Aidan Dodson, "The Eighteenth-Century Discovery of the Serapeum," *KMT* 11, no. 3 (Fall 2000): 50. (KMT is the ancient spelling for the name Khemit, which is the land that is now Egypt.)
5. *Ibid.*, 52.
6. Mohamed Ibrahim and David Rohl, "Apis and the Serapeum," 14.
7. Personal communication with Eric Leither shortly after returning from Egypt in February 1995.



8. Hossam Abulfotouh, "Giza Plateau Mapping Project," *Newsletter of the UIA Work Program Architecture and Heritage, Region-V* 3, no. 1 (2006).

#### CHAPTER 6. THE SHADOW OF THE SPHINX

1. W. M. Flinders Petrie, *The Pyramids and Temples of Gizeh*, first ed. (London: Field and Tuer; New York: Scribner & Welford, 1883). Republished online at Ronald Birdsall, ed., "The Pyramids and Temples of Gizeh Online," [www.ronaldbirdsall.com/gizeh](http://www.ronaldbirdsall.com/gizeh) (accessed February 4, 2010).
2. Christopher Dunn, "Advanced Machining in Ancient Egypt?" *Analog* (August 1984).
3. See [www.quotes.net/quote/6148](http://www.quotes.net/quote/6148) (accessed January 17, 2009).
4. Ian Lawton and Chris Ogilvie-Herald, *Giza the Truth: The People, Politics & History Behind the World's Most Famous Archaeological Site* (London: Virgin Publishing, 1999).
5. W. M. Flinders Petrie, *The Pyramids and Temples of Gizeh*, first ed. (London: Field and Tuer; New York: Scribner & Welford, 1883).
6. Petrie, *The Pyramids and Temples of Gizeh*, 95
7. "Cutting Granite with Sand," [www.pbs.org/wgbh/nova/lostempires/obelisk/cutting.html](http://www.pbs.org/wgbh/nova/lostempires/obelisk/cutting.html) (accessed February 4, 2010).

#### CHAPTER 7. THE SHADOWS OF DENDERAH

1. Amelia Edwards, *A Thousand Miles up the Nile* (London: George Routledge and Sons, 1889), 120.
2. Mounir Basta, ed., "The Temple of Denderah," in *Simpkins Splendor of Egypt* (Salt Lake City: Simpkins Souvenirs, 1987).
3. Amelia Edwards, *A Thousand Miles up the Nile*, 112.

#### CHAPTER 8. STICKS AND STONES: TOOLS OF THE TRADE

1. I. E. S Edwards, "Pyramids: Building for Eternity," *Ancient Egypt: Discovering Its Splendors*, 73–101.
2. Denys A. Stocks, *Experiments in Archaeology: Stoneworking Technology in Ancient Egypt* (London: Routledge, 2003).

#### CHAPTER 9. IN THE SHADOW OF AN OBELISK

1. Miriam Lichtheim, *Ancient Egyptian Literature, Volume II*, 28.
2. Mark Lehner, et al., *Secrets of Lost Empires: Obelisk*, directed by Michael Barnes, *Nova* (PBS), February 12, 1997. See [www.pbs.org/wgbh/nova/transcripts/2405obelisk.html](http://www.pbs.org/wgbh/nova/transcripts/2405obelisk.html) (accessed December 16, 2009).

3. Ibid.
4. Denys A. Stocks, *Experiments in Archaeology: Stoneworking Technology in Ancient Egypt*, 64, 65.
5. Peter Tyson, *Secrets of Lost Empires: Obelisk*, directed by Michael Barnes, *Nova* (PBS), February 12, 1997, see [www.pbs.org/wgbh/nova/egypt/team/rashwan.html](http://www.pbs.org/wgbh/nova/egypt/team/rashwan.html) (accessed February 4, 2010).
6. Ibid.
7. Reginald Engelbach, *The Problem of the Obelisks* (New York: George H. Doran Company, 1923), 20–21.
8. Ibid., 25.
9. Ibid., 48.
10. Doug Kenyon, *Forbidden History*, 256–62.
11. R. Engelbach, *The Problem of the Obelisks*, 42.
12. Ibid., 104.
13. Ibid., 48.
14. Ibid., 49.

#### CHAPTER 10. IN THE SHADOW OF EGYPTIAN MEGAMACHINES

1. See [http://thinkexist.com/quotes/dante\\_alighieri/2.html](http://thinkexist.com/quotes/dante_alighieri/2.html) (accessed February 4, 2010).
2. Stephen S. Mehler, *The Land of Osiris* (Kempston, Ill.: Adventures Unlimited Press, 2001).
3. Stephen S. Mehler, *From Light into Darkness: The Evolution of Religion in Ancient Egypt* (Kempston, Ill.: Adventures Unlimited Press, 2005).
4. Stephen S. Mehler, *The Land of Osiris*, 125–26.
5. See <http://egyptsites.wordpress.com/2009/02/27/the-pyramid-of-djedefre-at-abu-Roash/> (accessed January 6, 2010).
6. Peter Lu, “Early Precision Compound Machine from Ancient China,” *Science* 304 (June 11, 2004): 1638.
7. William Flinders Petrie, *The Pyramids and Temples of Gizeh* (London: Field & Tuer; New York: Scribner & Welford, 1883), 75.
8. Petrie, *The Pyramids and Temples of Gizeh*, 75, 76.
9. Robert G. Moores Jr., “Evidence for Use of a Stone-Cutting Drag Saw by the Fourth Dynasty Egyptians,” *Journal of the American Research Center in Egypt* 28 (1991): 146.
10. Ibid., 141.
11. Ibid., 143.
12. Ibid.

13. Ibid., 148.
14. Ibid., 147.
15. Ibid., 148.
16. Denys A. Stocks, "Testing Ancient Egyptian Granite-working Methods in Aswan, Upper Egypt," *Antiquity* 75 (2001): 90.
17. Ibid.
18. Ibid.
19. See [www.freepatentsonline.com/7082939.html](http://www.freepatentsonline.com/7082939.html) (accessed April 18, 2009).
20. Robert G. Moores Jr., "Evidence for Use of a Stone-Cutting Drag Saw by the Fourth Dynasty Egyptians," 148.
21. Denys A. Stocks, "Testing Ancient Egyptian Granite-working Methods in Aswan, Upper Egypt," 90.
22. Mark Lehner, *The Complete Pyramids: Solving the Ancient Mysteries*, 120–21.

#### CHAPTER II. WALKING IN THE SHADOW OF WILLIAM F. PETRIE

1. Comment by Mark Lehner at the American Association for the Advancement of Science Convention in Chicago, 1992.
2. Eric P. Uphill, "A Bibliography of Sir William Matthew Flinders Petrie (1853–1942)," *Journal of Near Eastern Studies* 31, no. 4 (Oct., 1972): 356–79, [www.jstor.org/pss/543795](http://www.jstor.org/pss/543795) (accessed February 5, 2010).
3. "Scholars Dispute Claim that Sphinx Is Much Older," *New York Times*, February 9, 1992, [www.nytimes.com/1992/02/09/us/scholars-dispute-claim-that-sphinx-is-much-older.html](http://www.nytimes.com/1992/02/09/us/scholars-dispute-claim-that-sphinx-is-much-older.html) (accessed April 25, 2009).
4. Ibid.
5. Henry Hodges, *Technology in the Ancient World* (New York: Barnes and Noble Books, 1970), 185.
6. William Flinders Petrie, *The Pyramids and Temples of Gizeh*, 77–78.
7. Ibid., 74–75.
8. Christopher Dunn. "Advanced Machining in Ancient Egypt?" *Analog* CIV, no. 8 (August 1984): 67–82.
9. William Flinders Petrie, *The Pyramids and Temples of Gizeh*, 75–77.
10. Denys A. Stocks, "Technology Innovators of Ancient Egypt," *Ancient Egypt* 7, no 3 (December/January 2007).
11. Deiter Arnold, *Building in Egypt: Pharaonic Stone Masonry* (New York: Oxford University Press, 1991), 266, 268, n64.
12. Denys A. Stocks, "Testing Ancient Egyptian Granite-working Methods in Aswan, Upper Egypt," *Antiquity* 75 (2001): 93.

13. Denys A. Stocks, *Experiments in Archaeology: Stoneworking Technology in Ancient Egypt* (London: Routledge, 2003), 135.
14. A. Lucas and J. R. Harris, *Ancient Egyptian Materials and Industries* (New York: Dover Publications, 1999), 70–71.
15. Denys A. Stocks, *Experiments in Archaeology*, 128.
16. Leonard Gorelick and A. John Gwinnet, “Philological and Archaeological Evidence for the Use of Emery in the Bronze Age Near East,” *Journal of Cuneiform Studies* 40, no. 2 (Autumn, 1988): 195–210, [www.jstor.org/stable/1359662](http://www.jstor.org/stable/1359662) (accessed January 11, 2010).
17. Ian Lawton and Chris Ogilvie-Herald, *Giza the Truth: The People, Politics & History Behind the World’s Most Famous Archaeological Site*, 217.
18. W. F. M. Petrie, “On the Mechanical Methods of the Ancient Egyptians,” *Journal of the Anthropological Institute of Great Britain and Ireland* 13 (1884): 90.
19. Ian Lawton and Chris Ogilvie-Herald, *Giza the Truth: The People, Politics & History Behind the World’s Most Famous Archaeological Site*, 217.
20. W. F. M. Petrie, “On the Mechanical Methods of the Ancient Egyptians,” *Journal of the Anthropological Institute of Great Britain and Ireland* 13 (1884): 103, 104.
21. *Ibid.*, 104.
22. *Ibid.*

## CHAPTER 12. SUSPENDING DISBELIEF

1. Chiselwa Kawanda, “Mosi-oa-Tunya: The Smoke that Thunders,” *Sunday Times of Zambia*, [www.times.co.zm/news/viewnews.cgi?category=8&id=1186648182](http://www.times.co.zm/news/viewnews.cgi?category=8&id=1186648182) (accessed February 11, 2010).
2. New 7 Wonders, “The Pyramids of Giza (2600–2500 B.C.), Egypt,” [www.new7wonders.com/classic/en/n7w/finalists/c/PyramidsofGiza/](http://www.new7wonders.com/classic/en/n7w/finalists/c/PyramidsofGiza/) (accessed May 9, 2009).
3. R. A. Schwaller de Lubicz, *The Temple of Man*.
4. Stephen Mehler, *The Land Of Osiris*, 116.



# Selected Bibliography

- Arnold, Dieter. *Building in Egypt*. New York: Oxford University Press, 1991.
- Clarke, Somers, and R. Engelbach. *Ancient Egyptian Construction and Architecture*. New York: Dover Publications, 1990.
- Curran, Brian A., Anthony Grafton, Pamela O. Long, and Benjamin Weiss. *Obelisk: A History*. Cambridge, Mass.: The Burndy Library, 2009.
- de Lubicz, R. A. Schwaller. *The Temple of Man*. Rochester, Vt.: Inner Traditions, 1998.
- . *The Temple of Karnak*. Rochester, Vt.: Inner Traditions, 1999.
- Descartes, René. "Discourse of Rightly Conducting the Reason and Seeking for Truth in the Sciences." *Great Books of the Western World*, vol 31. Chicago: William Benton, Encyclopædia Britannica, 1952.
- Dunn, Christopher. "Advanced Machining in Ancient Egypt?" *Analog CIV*, no. 8 (August 1984): 67–82.
- . *The Giza Power Plant: Technologies of Ancient Egypt*. Rochester, Vt.: Bear and Company, 1998.
- Edwards, Amelia B. *A Thousand Miles up the Nile*. London: George Routledge and Sons, 1889.
- . *Pharaohs, Fellahs and Explorers*. New York: Harper and Brothers, Franklin Square, 1891.
- Edwards, I. E. S. "Pyramids: Building for Eternity." *Ancient Egypt: Discovering Its Splendors*. New York: National Geographic Society, 1978.
- Emerson, Ralph W. *Emerson's Essays, First and Second Series*. New York: Thomas Y. Crowell Company, 1926.
- Engelbach, R. *The Problem of the Obelisks*. New York: George H. Doran Company, 1923.

- Flinders Petrie, Sir William M. "On the Mechanical Methods of the Ancient Egyptians." *Journal of the Anthropological Institute* (1884).
- . *Ten Years Digging in Egypt*. Chicago: Ares Publishers, 1976.
- . *The Pyramids and Temples of Gizeh*. London: Field and Tuer, 1883. Reprinted with an update by Dr. Zahi Hawass. London: Histories and Mysteries of Man LTD., 1990.
- Hadingham, Evan. "Unlocking the Mysteries of the Parthenon." *Smithsonian* (February 2008).
- Hodges, Henry. *Technology in the Ancient World*. New York: Barnes and Noble Books, 1970.
- Kenyon, Doug. *Forbidden History*. Rochester, Vt.: Bear & Company, 2006.
- Lawton, Ian, and Chris Ogilvie-Herald. *Giza the Truth: The People, Politics & History Behind the World's Most Famous Archaeological Site*. London: Virgin Publishing, 1999.
- Lehner, Mark. *The Complete Pyramids: Solving the Ancient Mysteries*. London: Thames and Hudson, 1997.
- Lehner, Mark, et al. *Secrets of Lost Empires: Obelisk*. Directed by Michael Barnes. *Nova*, PBS, February 12, 1997.
- Lehner, Mark, et al. *Secrets of Lost Empires: Pharaoh's Obelisk*. Directed by Michael Barnes. *Nova*, PBS, February 8, 2000.
- Lichtheim, Miriam. *Ancient Egyptian Literature: Volume II, The New Kingdom*. Berkeley: The University of California Press, 1976, 2006.
- Lu, Peter. "Early Precision Compound Machine from Ancient China." *Science* 304 (June 11, 2004): 1638.
- Lucas A., and J. R. Harris. *Ancient Egyptian Materials and Industries*. New York: Dover Publications, 1999.
- Malkowski, Edward. *Spiritual Technology: Sacred Science and the Mystery of Consciousness*. Rochester, Vt.: Inner Traditions, 2007.
- Mehler, Stephen S. *From Light into Darkness: The Evolution of Religion in Ancient Egypt*. Kempton, Ill.: Adventures Unlimited Press, 2005.
- . *The Land of Osiris*. Kempton, Ill.: Adventures Unlimited Press, 2001.
- Mertz, Barbara. *Temples, Tombs & Hieroglyphs: A Popular History of Ancient Egypt*. New York: William Morrow, 2007.
- Moore, Robert G. "Evidence for Use of a Stone-Cutting Saw by the Fourth Dynasty Egyptians." *Journal of the American Research Center in Egypt* 28 (1991): 139–48.
- Noblecourt, Christiane Desroches. *Ramses II*. Paris: Flammarion, 2007.
- Oakes, Lorna, and Lucia Gahlin. *Ancient Egypt: An Illustrated Reference to the*

- Myths, Religions, Pyramids and Temples of the Land of the Pharaohs*. New York: Barnes and Noble Books, 2006.
- Penny, Nicholas. *The Materials of Sculpture*. New Haven: Yale University Press, 1993.
- Schmidt, Stanley. *Analog Essays on Science*. New York: John Wiley and Sons, 1990.
- Schneider, Michael S. *A Beginner's Guide to Constructing the Universe: The Mathematical Archetypes of Nature, Art, and Science*. New York: Harper Collins, 1995.
- "Scholars Dispute Claim That Sphinx Is Much Older." *New York Times*, February 9, 1992, available at [www.nytimes.com/1992/02/09/us/scholars-dispute-claim-that-sphinx-is-much-older.html](http://www.nytimes.com/1992/02/09/us/scholars-dispute-claim-that-sphinx-is-much-older.html).
- Shaw, Ian, ed. *The Oxford History of Ancient Egypt*. New York: Oxford University Press, 2000.
- Stocks, Denys A. *Experiments in Archaeology: Stoneworking Technology in Ancient Egypt*. London: Routledge, 2003.
- . "Technology Innovators of Ancient Egypt." *Ancient Egypt Magazine* 7, no. 3, Issue 39 (2007): 37–43.
- . "Testing Ancient Egyptian Granite-working Methods in Aswan, Upper Egypt." *Antiquity* 75 (2001): 89–94.
- Tompkins, Peter. *The Magic of Obelisks*. New York: Harper and Row, 1981.
- West, John Anthony. *Serpent in the Sky: The High Wisdom of Ancient Egypt*. Wheaton, Ill.: Quest Books, 1993.
- Wilkinson, Richard H. *Reading Egyptian Art: A Hieroglyphic Guide to Ancient Egyptian Painting and Sculpture*. London: Thames and Hudson Ltd., 1992.

# Index

Page numbers in *italics* indicate photographs and illustrations.

- Abulfotouh, Hossam, 335–36
- Abu Roash, pyramid at  
concave granite block artifact, 254–  
56, 257, 259, 331–32, *pl. 19–22*  
description of, 251  
Mehler on, 249–50  
photographs, 252–53  
saw marks and calculations, 276–84  
trench at, 285–87
- Abu Simbel, 329
- Abydos, the Osirian temple at, 62–63
- “Advanced Machining in Ancient  
Egypt,” 4, 141, 295
- afterlife, and the ancient Egyptians,  
285, 286, 336–37
- Aida* (Verdi), 64
- Amenophis III (Amenhotep), 107,  
108, 109, 110
- Amun and Mut statues (Luxor  
Museum), 182–83, 333, *pl. 15*
- Amun-Mut-Khonsu (the Temple of  
Luxor)  
location, 9  
obelisk, 209  
perfection of, 21–22  
Schwaller de Lubicz’ study of, 16,  
65, 329  
symbolism and precision of, 88–91
- Andrews, Arlan, 193–94, 292
- Annie, Nick, 314, 316
- Antikythera Mechanism, 4
- Apis Bull, sacred  
illustration, 125  
precision of boxes for, 133  
and the Serapeum, 118–19, 121,  
123–24, 125, 127
- architecture  
of the ancient Greeks, 71  
classical, at the Temple of Denderah,  
176  
as “frozen music,” 63–66  
Golden Ratio in, 60–62  
as reflection of ideals and skills, 169  
*See also specific architectural locations  
and artifacts*
- art  
as communication and evocation,  
10–11, 40–41



- the Golden Ratio, 60  
 of the Great Hypostyle Hall of Denderah, 174–76  
 Pyramids of Giza, as perfection of, 327–28  
*vs.* precision manufacturing, 29–30  
 Aswan, quarrying at, 119–200, 223–28.  
*See also* Unfinished Obelisk at Aswan  
 Atlantis, 39, 293  
 Awyan, Abd'l Hakim, 335
- basalt pavement of the Giza Plateau, 262–63, 264–65, 266–67, 268, 273–74, 275, 276–84. *See also* Giza Plateau  
 bas relief carving. *See* carving, relief  
 Bastet, carvings of, 193  
 bearings, evidence of, 284, 294, 300, 333  
 boat pits, 285  
 boxes, granite (sarcophagi)  
   in Khafre's pyramid, 147–52, 153  
   at Memphis, 152  
   quarrying of, 134  
   in the Serapeum, 120–21, 126–29, 131–36, 135, 331  
   timeline of their creation, 332–33  
 bush hammering, 99
- CAD/CAM software, 112  
 Cairo Museum, 134, 135, 198, 199–201  
 capitals in the Great Hypostyle Hall.  
   *See* Hathor's capitals  
 Cartesian geometry, 35–36, 56  
 carving, relief, 83, 191–94, 208, 210–16, 294  
 casing stones of the pyramids, 115–16, 130, 140  
 Cayce, Edgar, 293  
 circular saws, theoretical use of, 262, 273–74, 275, 276–89  
 civilizations  
   ancient Egyptian, presumptions about, 41, 292–93, 335–36  
   ancient Egyptian *vs.* modern, 336–37  
   cycles of, 13  
   destruction of, theories, 336–37  
 consumer products, 30–31  
 cornices  
   accuracy of, 158  
   geometry of, 159  
   on the Valley Temple wall, 158, 160, 164, 166–67  
 Cosmic Egg, 41  
 “couch” at the Giza Plateau, 160–64  
 craftsmanship  
   in cutting hard igneous rock, 132  
   precision of ancient Egyptians, 141  
   *See also* precision in manufacturing  
 crowns of upper Egypt, 14–16, 20–22, *pl.* 2. *See also* Hedjet; Pschent
- Denderah, the Temple of. *See* Hathor, Temple of  
 Descartes, René, 3  
 destruction of Egyptian statuary, 178–79  
 Djedefra (son of Khufu) and Abu Roash, 249–50  
 Dodson, Aidan, 124  
 dolerite balls  
   effectiveness of, as tool, 201, 202

- experiments with, 227–29, 231–39,  
*pl. 18*
- Mark Lehner on, 214
- surface area consideration, 233
- used for shaping granite, 151–52,  
219, 220
- See also* granite; quarrying
- doorways, in Egyptian architecture
- examples of, 165, 166
- the Valley Temple cornice, 164,  
166–67
- See also* cornices
- drag saw, proposed by Moores, 269–70
- drilling, ancient
- author's theory and experimentation,  
204, 321–24
- examples of, 324
- tools in the Cairo Museum, 199
- on the Unfinished Obelisk, 226, 227
- See also* Petrie's Core
- ears
- on Hathor statues, 185, 190–91
- human, 110
- on Ramses statues, 46, 47, 48, 54,  
109–11
- Edwards, Amelia, 172–73, 194–95
- Edwards, I. E. S., 197
- Egyptians, ancient
- accomplishments of, *pl. 3*
- civilization of, presumptions about,  
41, 292–93, 335–36
- destruction of, theories, 336–37
- Egyptians, modern, 131, 222
- elliptical geometry
- of Amenophis III statue, 108
- in the Hedjet crowns, 31–35
- in the stone at Abu Roash, 280
- use of, in Hathor's capitals, 186, 188,  
189
- Emerson, Ralph Waldo, 8, 40, 113,  
137
- Engelbach, Reginald, 223–24, 231–32,  
234, 235–39
- engineers, ancient, 5–6, 176. *See also*  
machines in ancient Egypt; tools  
used in Egyptian manufacturing
- engineers, modern, 1, 141. *See also*  
specific engineers
- English Channel, machines used in,  
284
- Fallen, Gail, 129, 130
- false beards of the pharaohs, 82–83
- Fibonacci (Leonardo Pisano), 46
- Fibonacci spiral
- diagram, 47
- and the dimensions of Ramses' head,  
58–60, *pl. 5*
- in Egyptian sculpture, 45, 46
- Flower of Life, 62–63, 66, *pl. 5, pl. 6*
- Froude, James Anthony, 93
- geometric warping for visual effect
- the Parthenon, 71
- Ramses at Memphis, 72, 73
- Ramses bust at the Temple of Luxor,  
69–71
- geometry
- Cartesian, 35–36
- elliptical, in Egyptian crowns, 32,  
33, 34, 35
- Golden Ratio, 60–62
- perfection of, in Egyptian crowns,  
14–15
- sacred geometry, 64

- See also* elliptical geometry;  
 Fibonacci spiral
- Gibran, Kahlil, 168
- Giza Plateau
- the granite “couch,” 160–64
  - precision of artifacts, 154–57, 159–60, 331
  - the trenches at, 287–89, *pl.* 23
  - visiting, 137–39
- See also* basalt pavement of the Giza Plateau
- The Giza Power Plant* (Dunn), 155, 164, 295
- Giza Pyramids, 248, 327–28. *See also* Great Pyramid
- Golden Ratio, 60–62
- Gorelick, Leonard, 309
- granite, 98–99, 306. *See also* dolerite balls; drilling, ancient; Petrie’s Core; quarrying
- Great Hypostyle Hall at Denderah, 171, 172, 173–74, 177–79. *See also* Hathor, Temple of; Hathor’s capitals
- Great Pyramid, 139–40, 287, 327–28, 336
- Great Sphinx, 291–92, 335
- grids, as used by ancient Egyptians, 35–36, 56–58, 59, 60–61, 66, 89, 90, 184
- Gwinnet, A. John, 309
- Hadingham, Evan, 94–95
- harmonic scale of Apollo Zeus harp, 65
- Harris, A. C., 122, 308–9
- Hathor, Temple of, at Denderah
- artistry and precision of, 330
  - assembly of, speculation about, 191–94
  - history and description, 170, 172–74, 176–79
  - photographs, 168, 171, 175, 195, *pl.* 16, *pl.* 17
- See also* Hathor’s capitals
- Hathor’s capitals
- examination of, 183–88
  - geometry of, 188–89
  - Hathor’s ears, 190–91
  - precision features of, 181–82
  - theories of manufacturing, 180, 186–90
- Hatshepsut’s Obelisks, 205, 337
- Hawass, Zahi, 129, 130, 289, 327
- heat, dispersion of, for megasaws, 288–89
- Hedjet (Egyptian crown)
- author’s examination of, 14–15, 17–20, 22–25, 27–29
  - photographs of, 17, 18, 19, 23, 25, 27, 28
  - the White and the Red Crowns, 27–29
- Hoover, Herbert, 1
- Hopkins, Roger, 214, 219–21
- Hypostyle Hall at Denderah
- ceiling of, 173–74, 337
  - columns of, 172, 174, 177–81
  - photographs, 171
- See also* Hathor, Temple of, at Denderah; Hathor’s capitals
- Industrial Revolution, 2, 87
- jewel point cutting, ancient
- evidence of, 296–97, 303

- Karnak, Temple of  
 description of, 98  
 inscription on Hatshepsut's Obelisk, 205  
 Pschent, 27, 28  
 tool marks on Ramses statues, 99–103, 333, *pl. 9, pl. 10*
- Khafre's pyramid, granite boxes of, 147–52, 271, 272
- lathes, ancient Egyptian  
 as described by Petrie, 294–95, 296–97, 301  
 evidence of, 293, 295–96, 297–301, 333
- lathes, modern, 300, 301
- Lawton, Ian, 146, 310
- Leckie, Mike, 217–18
- Lehner, Mark, 214–15, 216–17, 220–21, 290, 291–93
- Leither, Eric, 128
- Lu, Peter, 256–57
- Lucas, Paul, 122–24, 308–9
- Luxor, the city of, 9
- machines and the Industrial Revolution, 2
- machines in ancient Egypt  
 absence of, in archeological record, 334–35  
 controversy over, 102–3  
 evidence of, 107, 160–61, 163, 333–34  
 and the obelisks, 242–46  
*See also* megamachines
- machining, modern  
 example of, *pl. 11*  
 shaper machine tool, 143  
 and tool marks, 107  
*See also* tools, modern
- Machu Pichu, 328
- manufacturing, modern  
 evolution of, 85–88, 338  
 precision in, 30–31
- manufacturing methods of ancient Egypt  
 assumptions about, 6, 39, 56  
 experimentalists' theories, 202–4  
 Hathor's capitals, 186–88  
 technological sophistication of artifacts, 326  
*See also* precision in manufacturing;  
 tools used in Egyptian manufacturing
- Mariette, Auguste, 121–22, 124–25
- mastabas* (burial tombs) discovered by Petrie, 173
- McClure, Malcolm, 316, 318
- megamachines  
 megasaws, 285–89  
 modern, 284  
 in prehistory, 245–46, 284–85, *pl. 24*
- Mehler, Stephen, 249–50, 335
- metals used by ancient Egyptians, 203
- metrology (science of measurement), 21, 48, 132, 134, 301
- Mitchel, Stuart, 64–65
- Mohamed, Adel Hussein, 131
- Moores, Robert G., 266–67, 269–70
- music, the geometry of, 63–66
- Nefertari, 68, 69, 83, 84, 85, 180, *pl. 14*
- Nefertiti (Egyptian queen), 83
- Nemes crown, 82–83
- NURBS (non-uniform rational B splines), 55–56

- obelisks, Egyptian  
 Hatshepsut's, 205, 337  
 photographs, 206, 209, 225  
 pillaging of, 207–8  
 possible machinery used, 242–46  
 relief carving of, 208, 210–13  
*See also* Unfinished Obelisk
- Ogilvie-Herald, Chris, 146, 310
- Parthenon, 71, 94–95
- Peck, Judd, 20
- Pei, I. M., 61–62
- Penny, Nicholas, 98–99
- Petrie, William Flinders  
 box at Khafre's pyramid, 149–51  
 the casing stone of the Great Pyramid, 140  
 cemetery excavations, 173  
 discussion of ancient Egyptian saws, 260–62  
 jewel point cutting and graving, 296–97  
 life and work of, 290–91  
 potsherds, description of, 294–95  
 technology of his time, 197  
 unconventional dress of, 196, 198  
*See also* Petrie's Core
- Petrie Museum, 332
- Petrie's Core  
 analysis of grooves, 313–20  
 his description of, 303–5, 310, 311–13  
 measurements, 312  
 speculation about machinery, 305–7  
 spiral grooves of, 204, 289, 302
- pharaohs, 83, 107–8. *See also specific pharaohs*
- pillaging of Egyptian obelisks, 207–8
- Pisano, Leonardo (Fibonacci), 46
- potsherds in the Petrie Museum, 294–300
- potter's wheels, ancient origins of, 293, 294
- precision in manufacturing  
 of the boxes in the Serapeum, 126–29, 131–36, *pl. 12*  
 in Egyptian craftsmanship, 141, 333–34  
 in Egyptian crowns, 14–15, 22  
 the Hathor capitals, 184–86  
 ignoring the evidence of, 293  
 necessitating precision tools, 301  
 question of the purpose of in Egyptian artifacts, 142  
 the Ramses statues, 89, 91  
 sources of, at the Giza Plateau, 154–57, 159–60  
 understanding and methods of, 30–31  
*vs.* artistic representation, 29–30  
*vs.* technique, 48  
*See also* manufacturing methods of ancient Egypt
- Pschent (Egyptian crown), 14–15, 27, 28
- pyramids  
 building of, speculation about, 201–4  
 Queen Una's casing stone, 115–16  
 as Wonder of the World, 327–28  
*See also* Abu Roash, pyramid at; Great Pyramid
- Pythagoras, 63–64
- Pythagorean triangles, 57, 58, 59
- quarrying  
 at Aswan, 119–200, 223–28

- experiments in, by Stocks, 270–72  
 tool marks, 240–42  
 with tube drills, 304–5  
 and the Unfinished Obelisk, 119,  
 219, 222, 223, 226–28  
*See also* dolerite balls; granite;  
 Petrie's Core
- Ramesseum (mortuary temple of  
 Ramses II)  
 ear of statue, 110  
 geometry and symmetry of, 74,  
 76–77, *pl.* 8  
 smile of Ramses, 70, 71, 77–79, 105  
 verse at base of Ramses statue, 339
- Ramses bust (outside the Temple of  
 Luxor)  
 camera setup, 51  
 drawings, 59, 61, 63  
 ears of, 109  
 geometric warping for visual effect,  
 69–71  
 geometry of, 56–58, 60–62, *pl.* 4  
 photographs, 10, 44, 45, 47, 48, 49,  
 52, 53, 55  
 Ramses' Harp Correlation Table,  
 66  
 smile of, 42–43, 69–71, 79, 80  
 symmetry of, 42–43, 42–44, 52–55  
 tool marks on, 81–82  
*See also* Amun-Mut-Khonsu
- Ramses challenge  
 to Diodorus Siculus, 339  
 minimum requirements to be met,  
 88–89  
 questions to ask, 91, *pl.* 1  
 Ramses' egg, 92  
 as replication, 11, 37
- Ramses Hall at Luxor  
 ear of standing statue, 109  
 engineering considerations of the  
 Ramses statues, 82, 85  
 marriage of art and engineering,  
 9–10, 329, *pl.* 1  
 tool marks, 95–96, 99–103, 104–7  
*See also* Amun-Mut-Khonsu
- Ramses II in Thebes, reconstruction  
 of, 112, 337
- Ramses statue at Memphis, 72, 73, *pl.* 7
- Ramses statues in Egypt  
 assessment of, by a modern sculptor,  
 218  
 ears, mechanical precision of,  
 109–11  
 number of, 107  
 relief carving. *See* carving, relief
- Roman pillaging of Egyptian obelisks,  
 207–8
- sarcophagi. *See* boxes, granite
- saws  
 circular, theoretical use of, 262,  
 273–74, 275, 276–89  
 drag saw, proposed by Moores,  
 269–70  
 jewel teeth of, according to Petrie,  
 297  
 Petrie on, 303
- Schneider, Michael, 65–66
- Schoch, Robert, 291–93, 335
- Schwaller de Lubicz, R. A., 16, 68, 88,  
 325, 329
- Scientific Revolution, 2–3
- Serapeum  
 boxes in, 120–21, 126–29, 131–36,  
 135, 330

- discovery of, 122–25  
 niches in the walls, 116, 118–20  
 photographs, 114, 117, 118, 119, 120  
*See also* Apis Bull
- Shakespeare, 40
- shaping machine tool, 143
- Siculus, Diodorus (Greek historian),  
 339
- Sphinx, Great, 291–92, 335
- statuary, destruction of, 178–79
- Stocks, Denys, 234, 235, 236–37,  
 270–72, 307–8, 320–21
- stones used in Egyptian temples,  
 12–13
- Strabo (Roman geographer), 121
- stylization, as used by ancient Egyptian  
 artisans, 111
- surface plates, 142–44, 145
- symbolism in engineering, 164. *See also*  
 Fibonacci spiral; Golden Ratio;  
 Pythagorean triangles
- symmetry  
 of Egyptian crowns, 16–20, 22–25  
 of Egyptian statues, 111–12  
*See also* precision in manufacturing
- technology of the ancient Egyptians  
 advancement of, 39, 91  
 Engelbach on, 223–24  
*See also* manufacturing methods  
 of ancient Egypt; tools used in  
 Egyptian manufacturing
- Temple of Hathor at Denderah. *See*  
 Hathor, Temple of, at Denderah
- Temple of Karnak. *See* Karnak, Temple  
 of
- Temple of Luxor. *See* Amun-Mut-  
 Khonsu
- temples of ancient Egypt  
 assumptions of how they were built,  
 180, 181  
 uses and purposes of, 169  
*See also specific temples*
- tool marks  
 at Abu Roash, 276–84, 289  
 in aluminum, 243  
 at the basalt pavement of the Giza  
 Plateau, 262–63, 264–65, 266–  
 67, 268, 273–74, 275  
 examples of, 97, 101, 102, 103, *pl. 9*,  
*pl. 10*  
 in Petrie's potsherds, 294–98, 299,  
 300–301  
 quarry marks, 240–42  
 on Ramses statues, 95–96, 99–103,  
*pl. 9*, *pl. 10*  
*See also* Petrie's Core
- tools, modern  
 to analyze ancient artifacts, 122,  
 146, 148, 149, 151  
 engineering, 143–45  
 Petrie's measuring instruments,  
 150  
*See also* machining, modern
- tools used in Egyptian manufacturing  
 archeological record of, 199–202  
 circular saws, theoretical use of, 262,  
 273–74, 275, 276–89  
 conventional archeological  
 assumptions, 95, 213–16, 248  
 drag saw, proposed by Moores,  
 269–70  
 Engelbach on, 223–24  
 evidence of, minus the archeological  
 record, 183  
 on granite boxes, 152–53

- jewel point cutting and graving, 296–97
- modern assumptions about, 198–204
- Petrie on, 260–62
- potter's wheels, 293, 294
- precision and complexity of, 36–38, 338
- questions about, 91
- on Ramses statues, 104–7
- sophistication of, 13
- tomb drawings of artisans, 214–16
- Western assumptions about, 39
- for working granite, 98–100
- See also* dolerite balls; lathes; machines in ancient Egypt; megamachines; saws
- tourism in Egypt
- safety measures, 170
- the Unfinished Obelisk site, 222–23
- trenches at Abu Roash and the Giza Plateau, 285–89
- Tyson, Peter, 219, 221
- ultrasonic machining, hypothesis of, 302, 306–7, 319
- Unfinished Obelisk at Aswan
- as evidence of technology, 223–24, 332
- photographs, 225, 230, *pl.* 18
- quarry marks, 119, 240–42
- theories on abandonment of, 226–27
- use of dolerite pounders, 227–28
- Uphill, Eric P., 290–91
- Walter, Bruno, 30, 48
- West, John Anthony, 16, 178–79, 291
- witness marks. *See* tool marks
- Wonders of Ancient Egypt, 325–34
- Wonders of the World, 21–22, 139–40, 326–29, 327–28
- workers' village of the Giza Plateau, 130
- zodiac, Egyptian, 174



## BOOKS OF RELATED INTEREST

### **The Giza Power Plant**

Technologies of Ancient Egypt  
*Christopher Dunn*

### **Spiritual Technology of Ancient Egypt**

Sacred Science and the Mystery of Consciousness  
*Edward F. Malkowski*

### **The Sphinx Mystery**

The Forgotten Origins of the Sanctuary of Anubis  
*Robert Temple with Olivia Temple*

### **Ancient Egypt 39,000 BCE**

The History, Technology, and Philosophy of Civilization X  
*Edward F. Malkowski*

### **Forbidden History**

Prehistoric Technologies, Extraterrestrial Intervention,  
and the Suppressed Origins of Civilization  
*Edited by J. Douglas Kenyon*

### **Forbidden Science**

From Ancient Technologies to Free Energy  
*Edited by J. Douglas Kenyon*

### **There Were Giants Upon the Earth**

Gods, Demigods, and Human Ancestry: The Evidence of Alien DNA  
*Zecharia Sitchin*

### **Journeys to the Mythical Past**

*Zecharia Sitchin*

INNER TRADITIONS • BEAR & COMPANY

P.O. Box 388

Rochester, VT 05767

1-800-246-8648

Please visit [www.InnerTraditions.com](http://www.InnerTraditions.com) for more books  
about this and many other topics

Or contact your local bookseller

*"This is an extremely important and original book. Christopher Dunn indisputably demonstrates that the ancient Egyptians were much more technologically advanced than the vast majority of modern Egyptologists, archaeologists, and historians ever dared imagine."*

ROBERT M. SCHOCH, PH.D., author of  
*Voyages of the Pyramid Builders and Pyramid Quest*

*"Christopher Dunn makes a stunningly convincing case that the makers of the ancient Egyptian stone monuments and images possessed sophisticated technologies rivaling our own in terms of their precision and capabilities."*

MICHAEL A. CRÉMO, author of *Forbidden Archeology*  
and *Human Devolution*

From the pyramids in the north to the temples in the south, ancient artisans left their marks all over Egypt, unique marks that reveal craftsmanship we would be hard pressed to duplicate today. Drawing together the results of more than 30 years of research and nine field study journeys to Egypt, Christopher Dunn presents a stunning stone-by-stone analysis of key Egyptian monuments, including the statue of Ramses II at Luxor and the fallen crowns that lay at its feet. His modern-day engineering expertise provides a unique view into the sophisticated technology used to create these famous monuments in prehistoric times.

Using digital photography, computer-aided design software, and metrology instruments, Dunn exposes the extreme precision of these monuments and the type of advanced manufacturing expertise necessary to produce them. His computer analysis of the many statues of Ramses II reveals that the left and right sides of the faces are precise mirror images of each other, and his examination of the mysterious underground tunnels of the Serapeum illuminates the finest examples of precision engineering on the planet. Providing never-before-seen evidence in the form of more than 280 photographs, Dunn's research shows that while absent from the archaeological record, highly refined tools, techniques, and even megamachines must have been used in ancient Egypt.

CHRISTOPHER DUNN is a manufacturing engineer with 50 years of experience. He has worked primarily in aerospace with an emphasis on precision and laser application. He has published a dozen articles on his theories about ancient technology and is the author of *The Giza Power Plant*. He lives in Illinois.



BEAR & COMPANY  
ROCHESTER, VERMONT  
[www.BearandCompanyBooks.com](http://www.BearandCompanyBooks.com)

Cover design by Peri Swan  
Cover images courtesy of Jupiter Images

ISBN 978-159143102-2

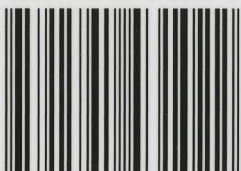

9 781591 431022