



# italian english



OVER 6,000 WORDS  
AND PHRASES

B I L I N G U A L  
D I C T I O N A R Y

ITALIAN  
ENGLISH





Bilingual  
**VISUAL**  
dictionary

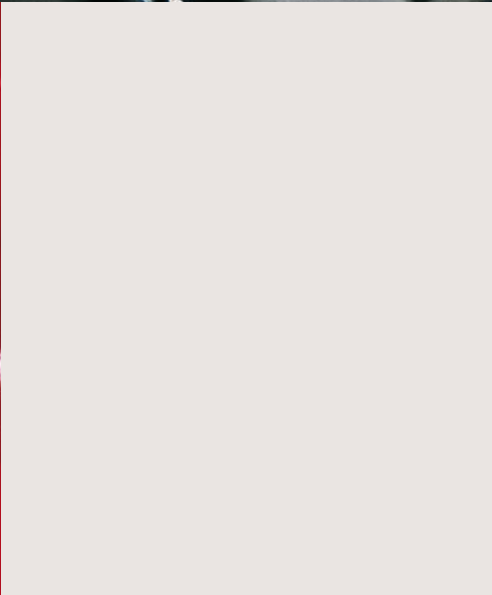
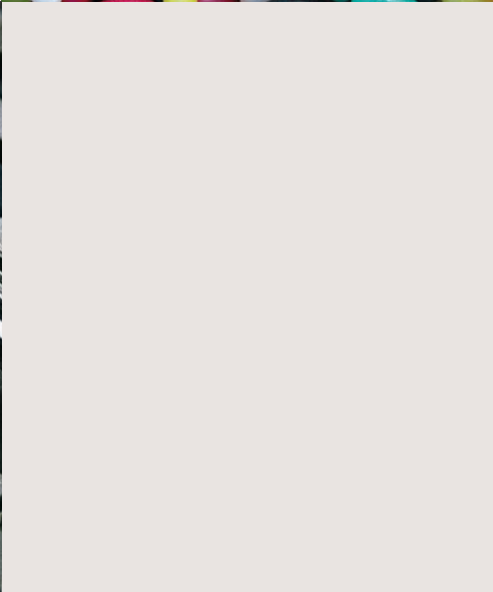
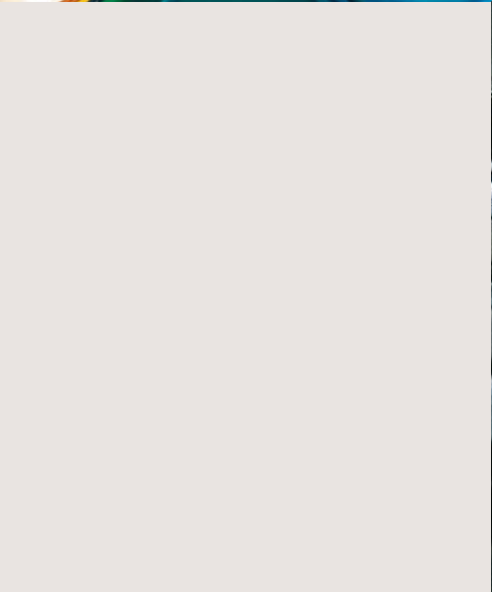

# Bilingual **VISUAL** dictionary

Previously published as part of  
*5-Language Visual Dictionary*





London, New York, Melbourne, Munich, Delhi

Senior Editor Angeles Gavira

Senior Art Editor Ina Stradins

DTP Designers Sunil Sharma, Balwant Singh,  
Harish Aggarwal, John Goldsmid, Ashwani Tyagi

DTP Coordinator Pankaj Sharma

Production Controller Liz Cherry

Picture Researcher Anna Grapes

Managing Editor Liz Wheeler

Managing Art Editor Phil Ormerod

Category Publisher Jonathan Metcalf

Designed for Dorling Kindersley by WaltonCreative.com

Art Editor Colin Walton, assisted by Tracy Musson

Designers Peter Radcliffe, Earl Neish, Ann Cannings

Picture Research Marissa Keating

Language content for Dorling Kindersley by  
g-and-w PUBLISHING

Managed by Jane Wightwick, assisted by Ana Bremón

Translation and editing by Christine Arthur

Additional input by Dr. Arturo Pretel, Martin Prill,  
Frédéric Monteil, Meinrad Prill, Mari Bremón,  
Oscar Bremón, Anunchi Bremón, Leila Gaafar

First American Edition, 2005

Published in the United States by  
DK Publishing, Inc., 375 Hudson Street,  
New York, New York 10014

05 06 07 08 09 10 9 8 7 6 5 4 3 2 1

Copyright © 2005 Dorling Kindersley Limited

All rights reserved under International and  
Pan-American Copyright Conventions. No part of  
this publication may be reproduced, stored in a  
retrieval system, or transmitted in any form or by  
any means, electronic, mechanical, photocopying,  
recording or otherwise, without the prior written  
permission of the copyright owner. Published in  
Great Britain by Dorling Kindersley Limited.

A Cataloging-in-Publication record for this book  
is available from the Library of Congress.

ISBN 0-7566-1296-9

Color reproduction by Colourscan, Singapore  
Printed and bound in Germany by Mohndruck

Discover more at

[www.dk.com](http://www.dk.com)

## sommario contents



42

la salute  
health



146

mangiare fuori  
eating out



252

il tempo libero  
leisure



6

**informazioni sul  
dizionario**  
about the dictionary



8

**come usare questo  
libro**  
how to use this book



10

**le persone**  
people



28

**l'aspetto**  
appearance



56

**la casa**  
home

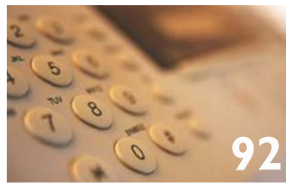

92

**i servizi**  
services



102

**gli acquisti**  
shopping



116

**il cibo**  
food



160

**lo studio**  
study



170

**il lavoro**  
work



192

**i trasporti**  
transportation



218

**gli sport**  
sports



278

**l'ambiente**  
environment



302

**i dati**  
reference



324

**indice**  
index



360

**ringraziamenti**  
acknowledgments

**le persone • people**

il corpo   body	12
la faccia   face	14
la mano   hand	15
il piede   foot	15
i muscoli   muscles	16
lo scheletro   skeleton	17
gli organi interni internal organs	18
gli organi riproduttivi reproductive organs	20
la famiglia   family	22
i rapporti   relationships	24
le emozioni   emotions	25
gli avvenimenti della vita life events	26

**l'aspetto •****appearance**

gli abiti da bambino children's clothing	30
l'abbigliamento da uomo men's clothing	32
l'abbigliamento da donna women's clothing	34
gli accessori   accessories	36
i capelli   hair	38
la bellezza   beauty	40

**la salute • health**

la malattia   illness	44
il medico   doctor	45
la ferita   injury	46
il pronto soccorso first aid	47
l'ospedale   hospital	48
il dentista   dentist	50
l'ottico   optometrist	51

la gravidanza   pregnancy	52
---------------------------	----

il parto   childbirth	53
-----------------------	----

le terapie alternative complementary therapy	54
---	----

**la casa • home**

la casa   house	58
-----------------	----

i sistemi interni internal systems	60
---------------------------------------	----

il salotto   living room	62
--------------------------	----

la sala da pranzo dining room	64
----------------------------------	----

la cucina   kitchen	66
---------------------	----

gli utensili da cucina kitchenware	68
---------------------------------------	----

la camera da letto   bedroom	70
------------------------------	----

la stanza da bagno bathroom	72
--------------------------------	----

la camera dei bambini baby's room	74
--------------------------------------	----

la lavanderia   utility room	76
------------------------------	----

il laboratorio   workshop	78
---------------------------	----

la scatola degli attrezzi toolbox	80
--------------------------------------	----

la decorazione   decorating	82
-----------------------------	----

il giardino   garden	84
----------------------	----

le piante da giardino garden plants	86
--	----

gli attrezzi da giardino garden tools	88
--	----

il giardinaggio   gardening	90
-----------------------------	----

**i servizi • services**

i servizi di emergenza emergency services	94
--	----

la banca   bank	96
-----------------	----

le comunicazioni communications	98
------------------------------------	----

l'albergo   hotel	100
-------------------	-----

**gli acquisti •****shopping**

il centro commerciale shopping center	104
--	-----

il grande magazzino department store	105
---	-----

il supermercato supermarket	106
--------------------------------	-----

la farmacia   pharmacy	108
------------------------	-----

il fioraio   florist	110
----------------------	-----

l'edicola   newsstand	112
-----------------------	-----

il confettiere confectionery	113
---------------------------------	-----

gli altri negozi other shops	114
---------------------------------	-----

**il cibo • food**

la carne   meat	118
-----------------	-----

il pesce   fish	120
-----------------	-----

le verdure   vegetables	122
-------------------------	-----

la frutta   fruit	126
-------------------	-----

le granaglie e i legumi secchi grains and legumes	130
--	-----

le erbe aromatiche e	132
----------------------	-----

le spezie   herbs and spices	
------------------------------	--

i cibi imbottigliati bottled foods	134
---------------------------------------	-----

i latticini dairy produce	136
------------------------------	-----

il pane e le farine breads and flours	138
--	-----

i dolci e i dessert cakes and desserts	140
---	-----

la salumeria   delicatessen	142
-----------------------------	-----

le bevande   drinks	144
---------------------	-----



## mangiare fuori • eating out

il caffè   café	148
il bar   bar	150
il ristorante   restaurant	152
il fast food   fast food	154
la colazione   breakfast	156
la cena   dinner	158

## lo studio • study

la scuola   school	162
la matematica   math	164
la scienza   science	166
l'università   college	168

## il lavoro • work

l'ufficio   office	172
il computer   computer	176
i mass media   media	178
la legge   law	180
la fattoria   farm	182
l'edilizia   construction	186
i mestieri   professions	188

## i trasporti • transportation

le strade   roads	194
l'autobus   bus	196
l'automobile   car	198
la motocicletta   motorcycle	204
la bicicletta   bicycle	206
il treno   train	208
l'aeroplano   aircraft	210
l'aeroporto   airport	212
la nave   ship	214
il porto   port	216

## lo sport • sport

il football americano football	220
il rugby   rugby	221
il calcio   soccer	222
l'hockey   hockey	224
il cricket   cricket	225
la pallacanestro   basketball	226
il baseball   baseball	228
il tennis   tennis	230
il golf   golf	232
l'atletica   track and field	234
gli sport da combattimento combat sports	236
il nuoto   swimming	238
la vela   sailing	240
l'equitazione   horse riding	242
la pesca   fishing	244
lo sci   skiing	246
gli altri sport other sports	248
il fitness   fitness	250

## il tempo libero • leisure

il teatro   theatre	254
l'orchestra   orchestra	256
il concerto   concert	258
il turismo   sightseeing	260
le attività all'aria aperta outdoor activities	262
la spiaggia   beach	264
il campeggio   camping	266
gli intrattenimenti in casa home entertainment	268
la fotografia   photography	270
i giochi   games	272
arte e artigianato arts and crafts	274



## l'ambiente • environment

lo spazio   space	280
la Terra   Earth	282
il paesaggio   landscape	284
il tempo   weather	286
le rocce   rocks	288
i minerali   minerals	289
gli animali   animals	290
le piante   plants	296
la città   town	298
l'architettura architecture	300

## i dati • reference

l'ora   time	304
il calendario   calendar	306
i numeri   numbers	308
i pesi e le misure weights and measures	310
il mappamondo world map	312
particelle e antonimi particles and antonyms	320
frasi utili useful phrases	322

## informazioni sul dizionario

È dimostrato che l'uso di immagini aiuti a capire e memorizzare le informazioni. Applicando tale principio, abbiamo realizzato questo dizionario bilingue, corredato da numerosissime illustrazioni, che presenta un ampio ventaglio di vocaboli utili in due lingue europee.

Il dizionario è diviso in vari argomenti ed esamina dettagliatamente molti aspetti del mondo moderno, dal ristorante alla palestra, dalla casa all'ufficio, dallo spazio al regno animale. L'opera contiene inoltre frasi e vocaboli utili per conversare e per estendere il proprio vocabolario.

È un'opera di consultazione essenziale per tutti gli appassionati delle lingue – pratica, stimolante e facile da usare.

### Indicazioni

Le due lingue vengono presentate sempre nello stesso ordine: italiano e inglese.

In italiano, i sostantivi vengono riportati con il relativo articolo determinativo, che indica il genere (maschile o femminile) e il numero (singolare o plurale), come ad esempio:

<b>il seme</b>	<b>le mandorle</b>
seed	almonds

I verbi sono contraddistinti da una (v) dopo il vocabolo inglese, come ad esempio:

**nuotare** • swim (v)

Alla fine del libro ogni lingua ha inoltre il proprio indice, che consente di cercare un vocabolo in una delle due lingue e di trovare il rimando alla pagina che gli corrisponde. Il genere è indicato dalle seguenti abbreviazioni:

m = maschile  
f = femminile

## about the dictionary

The use of pictures is proven to aid understanding and the retention of information. Working on this principle, this highly illustrated bilingual dictionary presents a large range of useful current vocabulary in two European languages.

The dictionary is divided thematically and covers most aspects of the everyday world in detail, from the restaurant to the gym, the home to the workplace, outer space to the animal kingdom. You will also find additional words and phrases for conversational use and for extending your vocabulary.

This is an essential reference tool for anyone interested in languages—practical, stimulating, and easy to use.

### A few things to note

The two languages are always presented in the same order—Italian and English.

In Italian, nouns are given with their definite articles reflecting the gender (masculine or feminine) and number (singular or plural), for example:

<b>il seme</b>	<b>le mandorle</b>
seed	almonds

Verbs are indicated by a (v) after the English, for example:

**nuotare** • swim (v)

Each language also has its own index at the back of the book. Here you can look up a word in either of the two languages and be referred to the page number(s) where it appears. The gender is shown using the following abbreviations:

m = masculine  
f = feminine



## come usare questo libro

Che stiate imparando una lingua nuova a scopo di lavoro, per diletto o in preparazione per una vacanza all'estero, o desideriate estendere il vostro vocabolario in una lingua che vi è già familiare, questo dizionario è uno strumento di apprendimento prezioso che potete usare in vari modi diversi.

Quando imparate una lingua nuova, cercate le parole affini per origine (che sono quindi simili nelle varie lingue) ma occhio alle false analogie (vocaboli che sembrano uguali ma hanno significati molto diversi). Questo dizionario mostra inoltre come le lingue hanno influito l'una sull'altra. L'inglese, per esempio, ha importato dalle altre lingue europee molti vocaboli relativi agli alimenti ma ne ha esportati molti altri relativi alla tecnologia e alla cultura popolare.

### Attività pratiche di apprendimento

- Girando per casa, in ufficio, a scuola, guardate le pagine relative all'ambiente in cui vi trovate, poi chiudete il libro, guardatevi attorno e cercate di ricordare il nome del maggior numero possibile di oggetti e strutture.
- Provate a scrivere un racconto, una lettera o un dialogo usando il maggior numero possibile dei vocaboli riportati su di una pagina in particolare. Vi aiuterà a memorizzare i vocaboli e a ricordare come si scrivono. Se volete scrivere testi più lunghi, cominciate con delle frasi che comprendano 2 o 3 delle parole.
- Se avete una memoria molto visiva, prendete un foglio di carta e disegnatevi o ricopiatevi le immagini che appaiono nel libro, quindi chiudete il libro e scrivete le parole sotto alle immagini.
- Quando vi sentite più sicuri, scegliete dei vocaboli dall'indice di una lingua straniera e cercate di ricordarne i significati, trovando poi le pagine corrispondenti per verificare che siano giusti.

## how to use this book

Whether you are learning a new language for business, pleasure, or in preparation for an overseas vacation, or are hoping to extend your vocabulary in an already familiar language, this dictionary is a valuable learning tool that you can use in a number of different ways.

When learning a new language, look for cognates (words that are alike in different languages) and “false friends” (words that look alike but carry significantly different meanings). You can also see where the languages have influenced each other. For example, English has imported many terms for food from other European languages but, in turn, exported terms used in technology and popular culture.

### Practical learning activities

- As you move around your home, workplace, or school, try looking at the pages which cover that setting. You could then close the book, look around you and see how many of the objects and features you can name.
- Challenge yourself to write a story, letter, or dialogue using as many of the terms on a particular page as possible. This will help you retain the vocabulary and remember the spelling. If you want to build up to writing a longer text, start with sentences incorporating 2–3 words.
- If you have a very visual memory, try drawing or tracing items from the book onto a piece of paper, then closing the book and filling in the words below the picture.
- Once you are more confident, pick out words in a foreign-language index and see if you know what they mean before turning to the relevant page to see if you were right.







**le persone**  
people

# il corpo • body

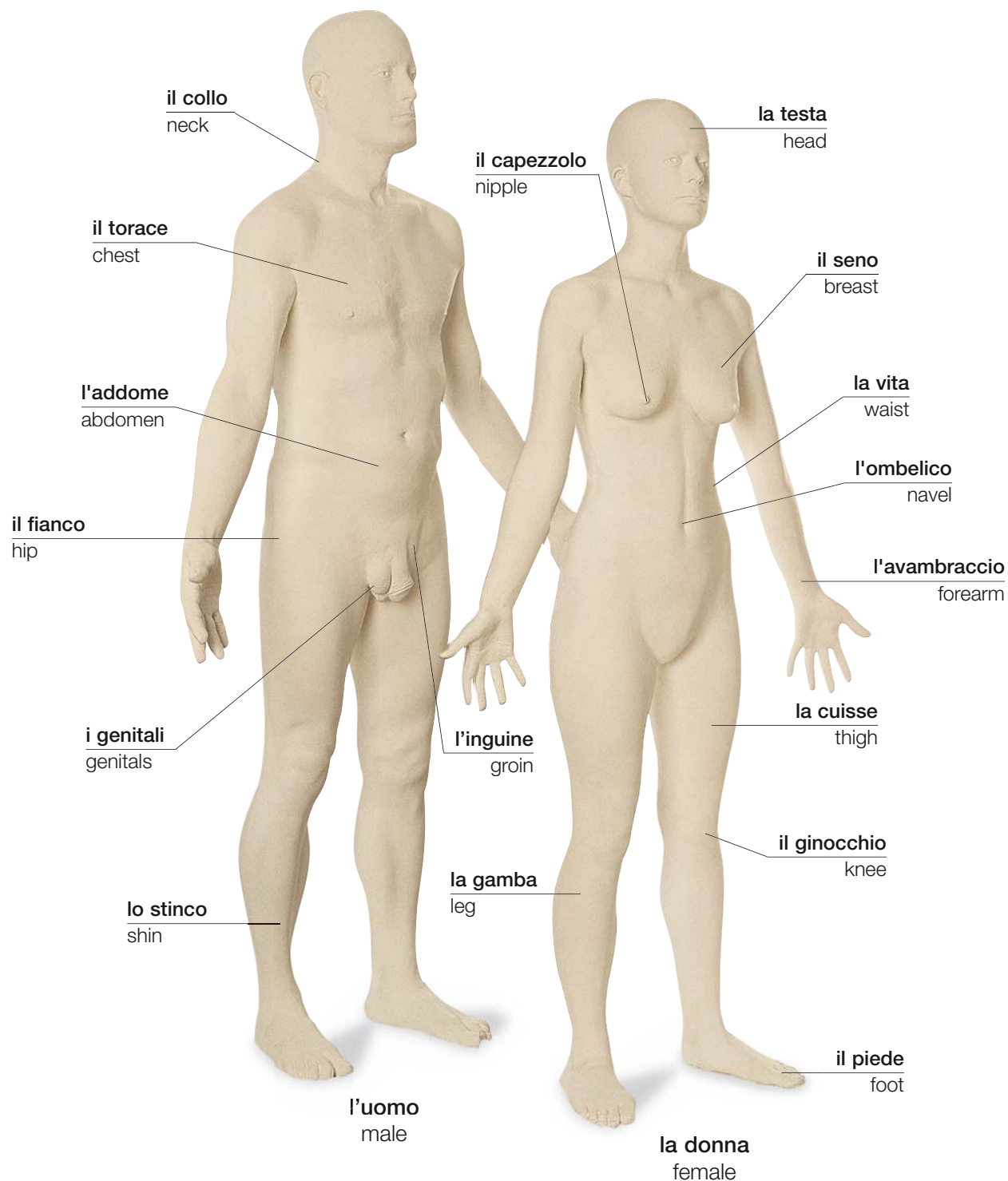

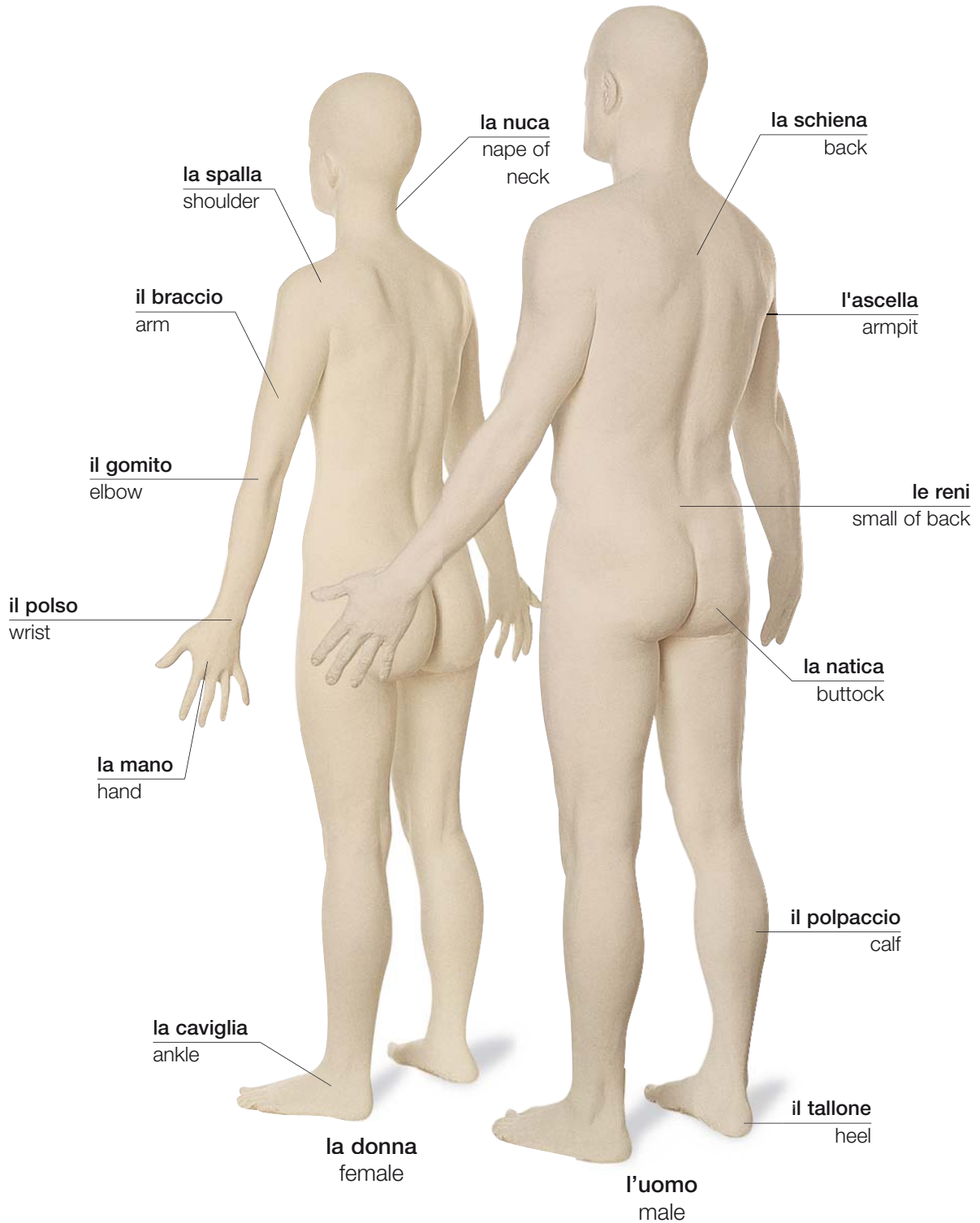

# la faccia • face

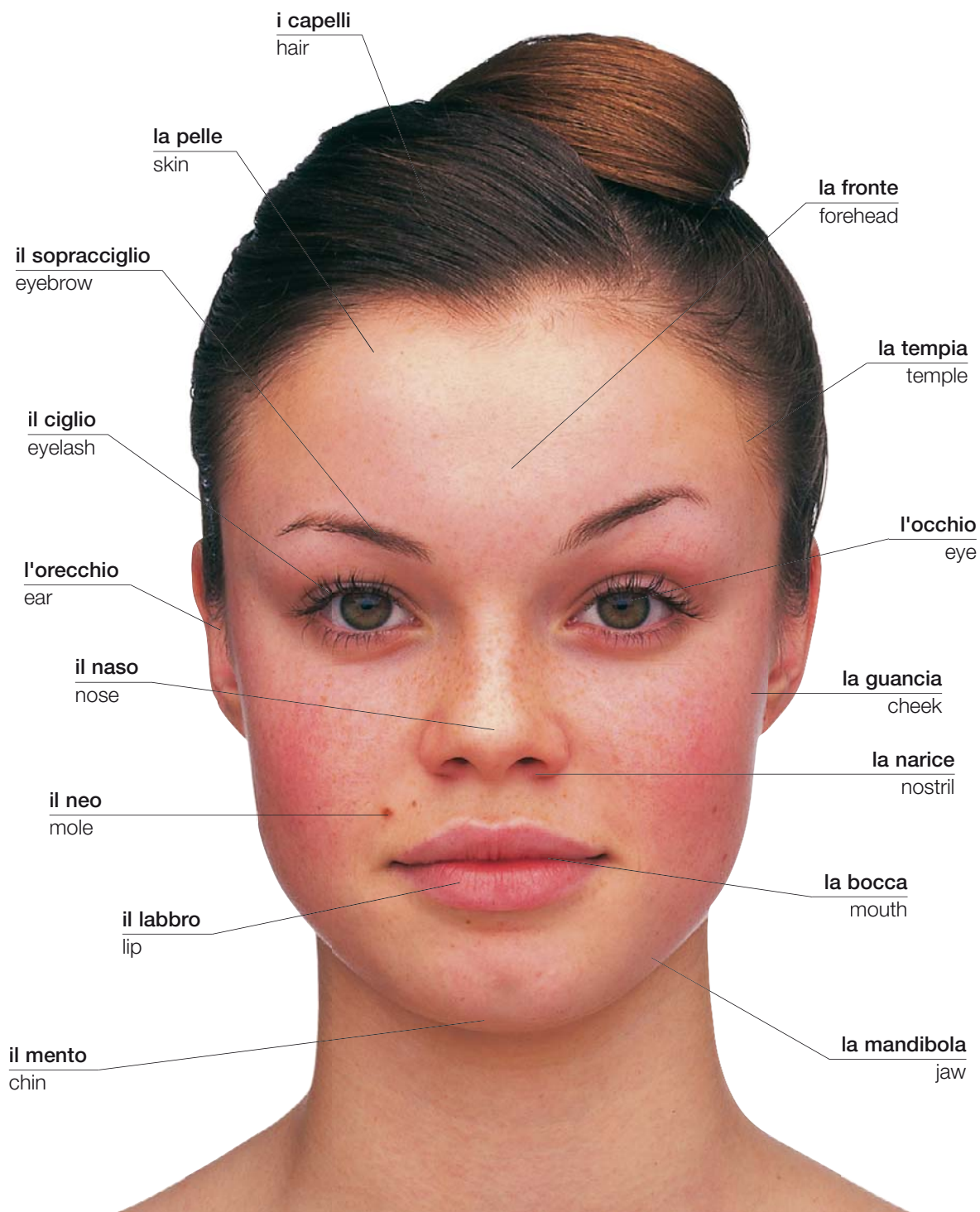





**la ruga**  
wrinkle



**la lentiggine**  
freckle



**il poro**  
pore



**la fossetta**  
dimple

## la mano • hand

**l'anulare**  
ring finger

**il medio**  
middle finger

**l'unghia**  
nail

**il mignolo**  
little finger

**l'indice**  
index finger

**la pellicina**  
cuticle

**il polso**  
wrist

**il palmo**  
palm

**la nocca**  
knuckle

**il pollice**  
thumb

**il pugno**  
fist

## il piede • foot

**il dito del piede**  
toe

**l'avampiede**  
ball

**l'alluce**  
big toe

**l'unghia del piede**  
toenail

**la pianta del piede**  
sole

**il collo del piede**  
instep

**il tallone**  
heel

**il dorso del piede**  
bridge

**il mignolo del piede**  
little toe

**l'arco plantare**  
arch

**la caviglia**  
ankle

# i muscoli • muscles

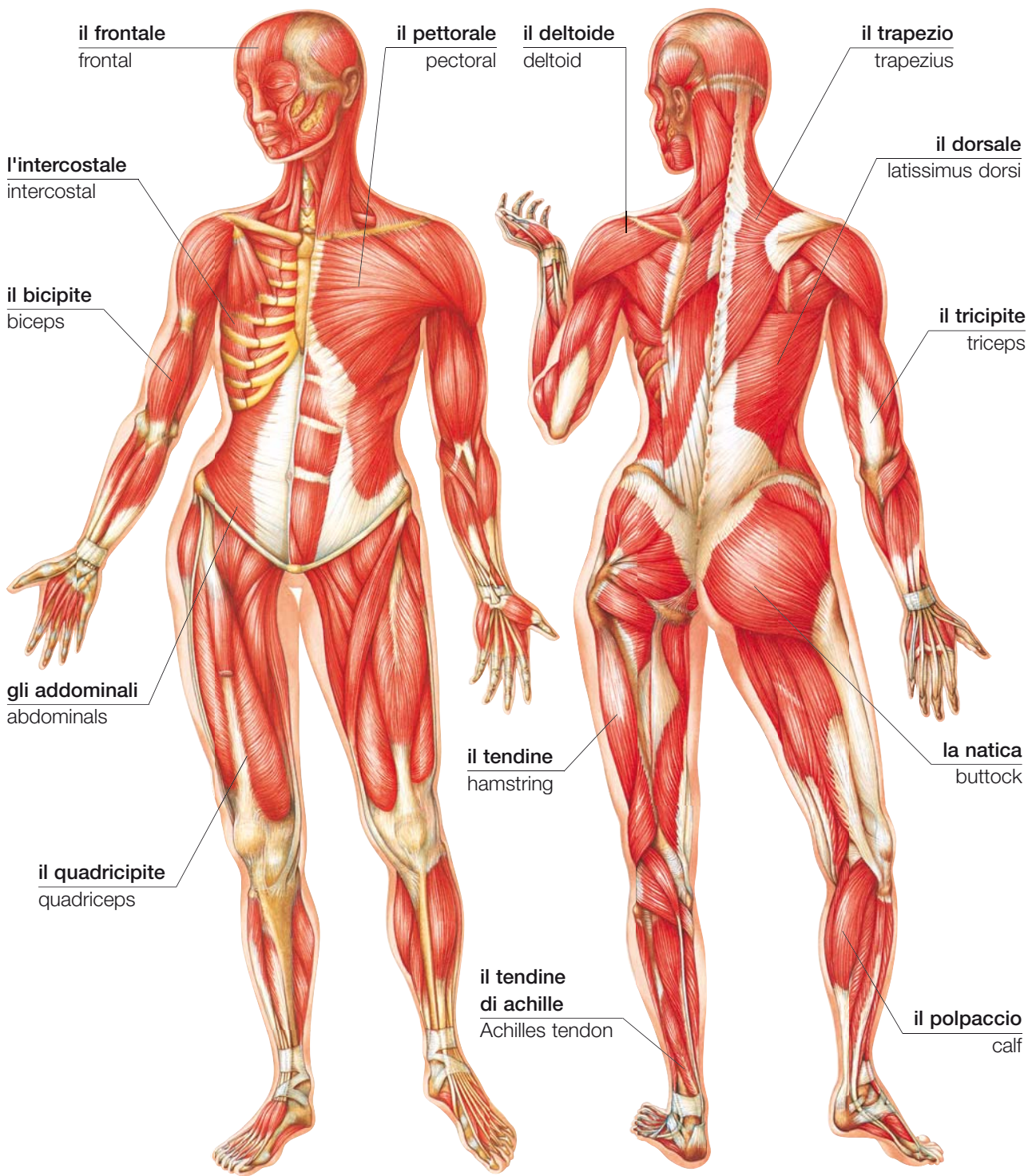

# lo scheletro • skeleton

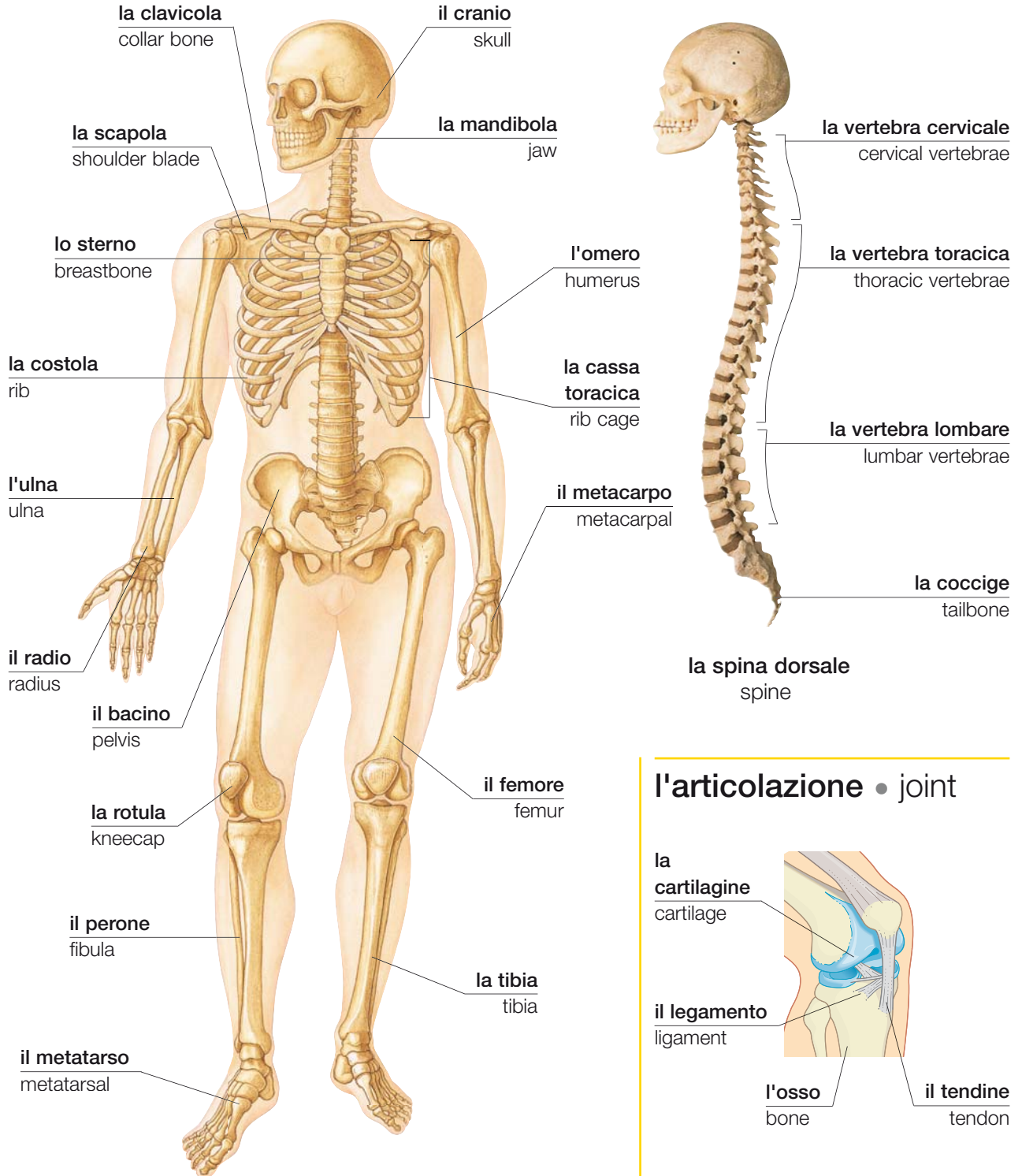

# gli organi interni • internal organs

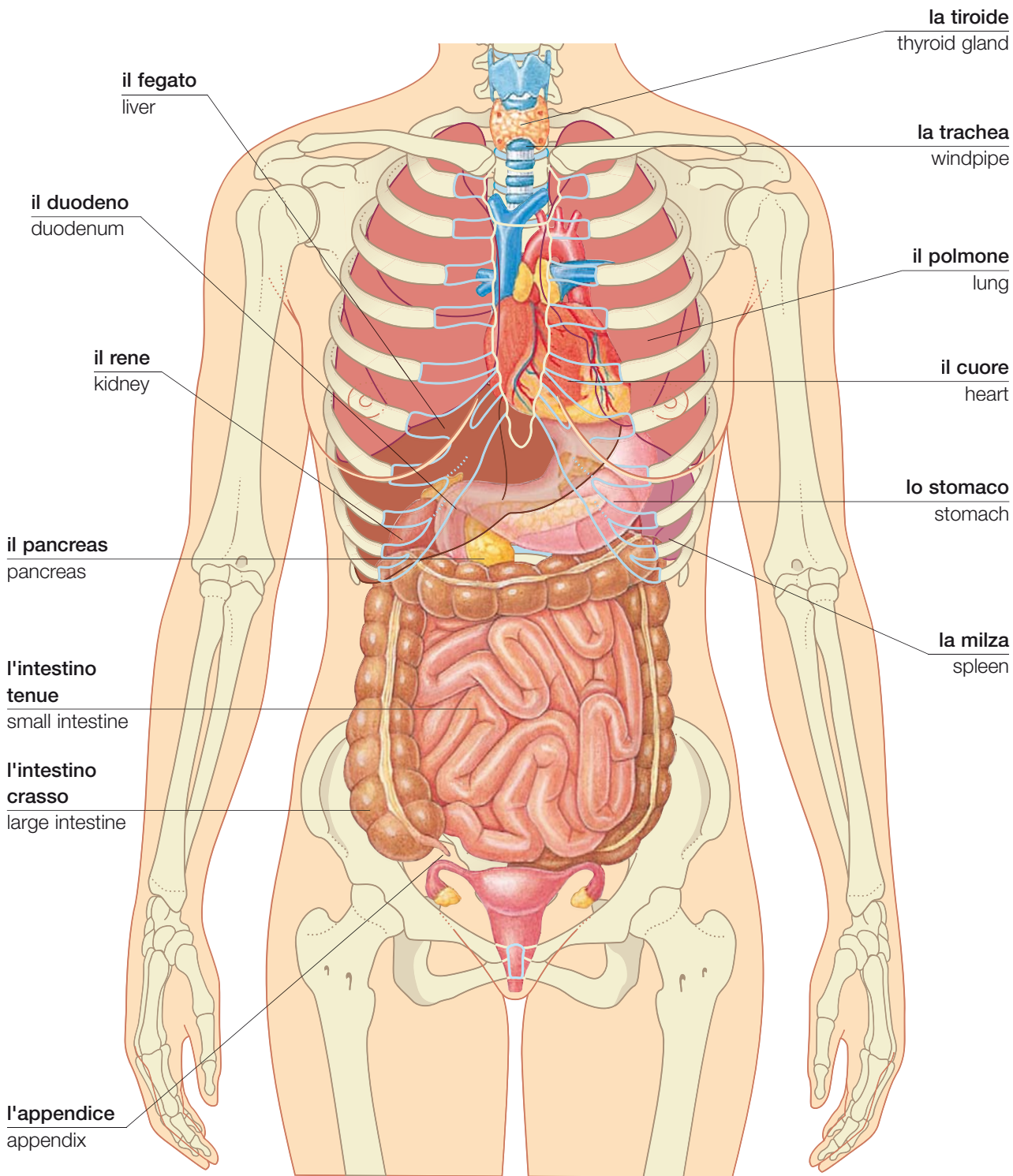

la testa • head

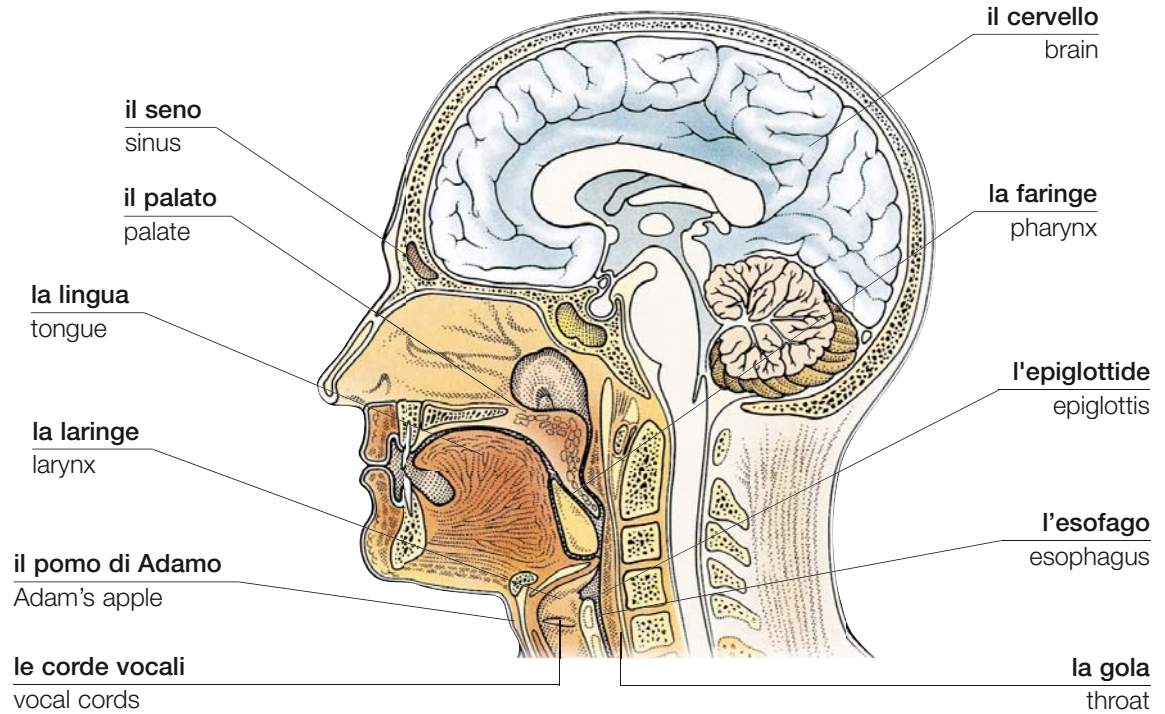

i sistemi corporali • body systems

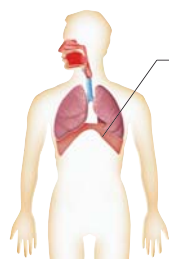

**il diaframma**  
diaphragm

**respiratorio**  
respiratory

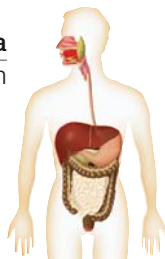

**digestivo**  
digestive

**la vena**  
vein

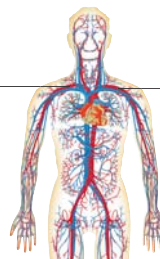

**l'arteria**  
artery

**cardiovascolare**  
cardiovascular

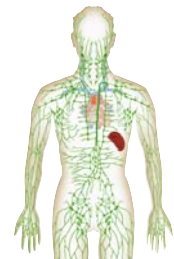

**linfatico**  
lymphatic

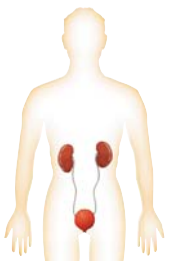

**urinario**  
urinary

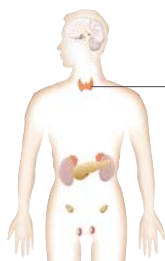

**la ghiandola**  
gland

**endocrino**  
endocrine



**il nervo**  
nerve

**nervoso**  
nervous



**riproduttivo**  
reproductive

# gli organi riproduttivi • reproductive organs

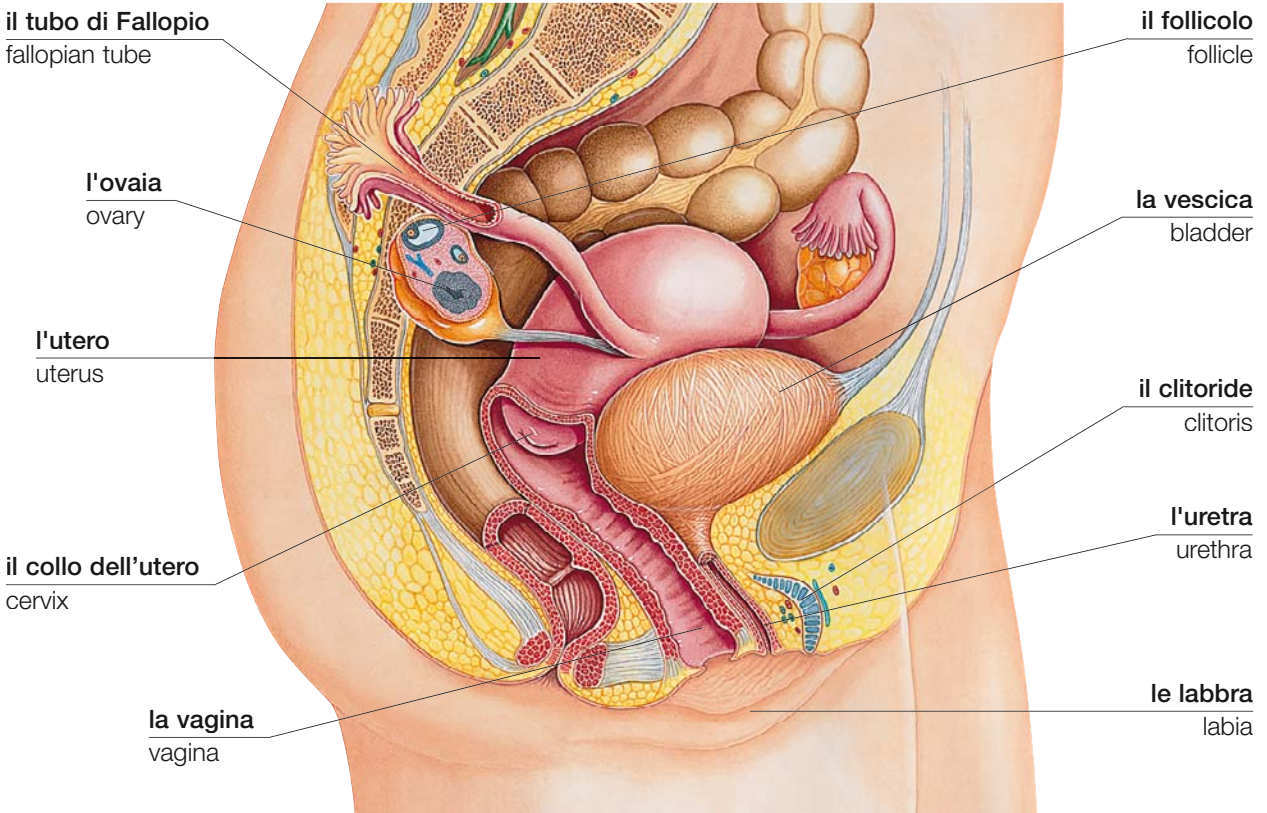

femminili | female

## la riproduzione • reproduction

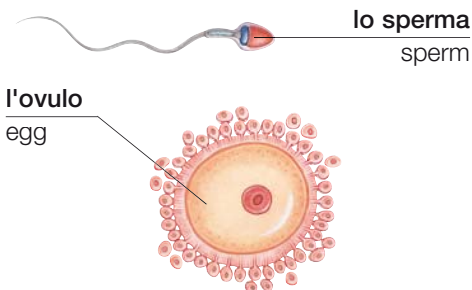

la fecondazione | fertilization

## vocabolario • vocabulary

**l'ormone**  
hormone

**impotente**  
impotent

**la mestruazione**  
menstruation

**l'ovulazione**  
ovulation

**fecondo**  
fertile

**il coito**  
intercourse

**sterile**  
infertile

**concepire**  
conceive

**la malattia trasmissibile per via sessuale**  
sexually transmitted disease

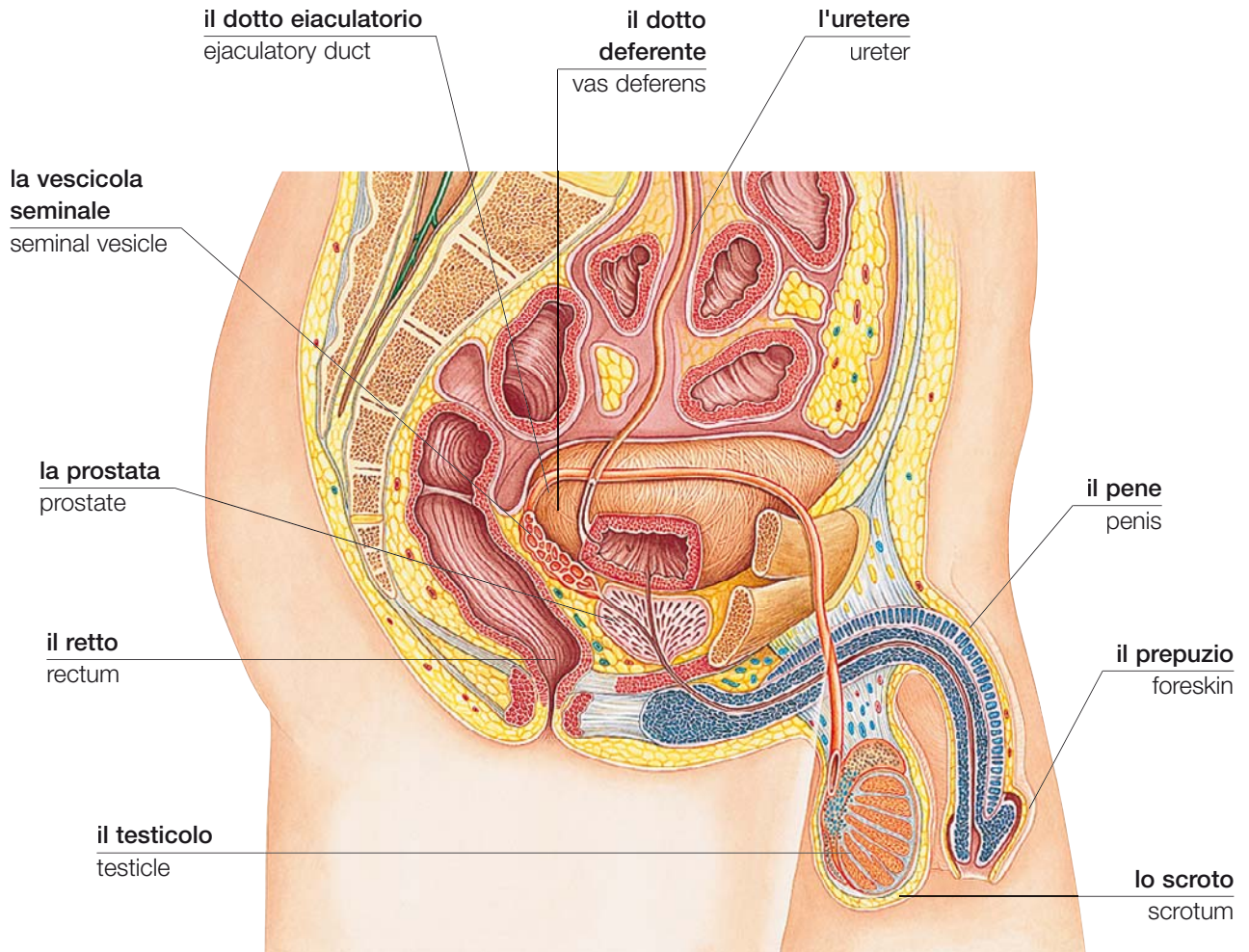

maschili | male

la contraccezione • contraception



# la famiglia • family

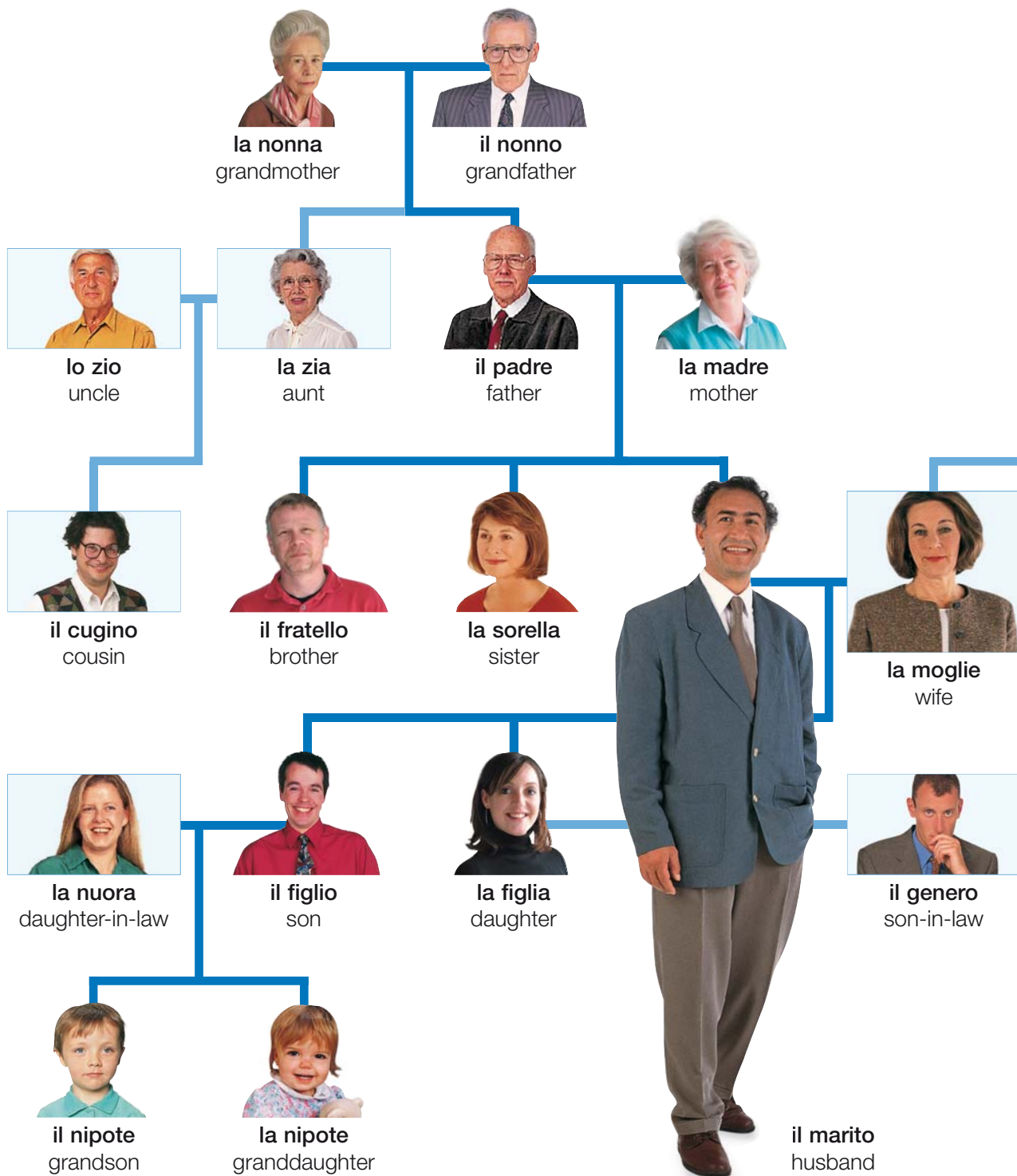



**vocabolario** • vocabulary

<b>i parenti</b> relatives	<b>i genitori</b> parents	<b>i nipoti</b> grandchildren	<b>la matrigna</b> stepmother	<b>il figliastro</b> stepson	<b>la generazione</b> generation
<b>i nonni</b> grandparents	<b>i bambini</b> children	<b>il patrigno</b> stepfather	<b>la figliastra</b> stepdaughter	<b>il/la compagno/-a</b> partner	<b>i gemelli</b> twins



**la suocera**  
mother-in-law

**il suocero**  
father-in-law



**il cognato**  
brother-in-law

**la cognata**  
sister-in-law



**la nipote**  
niece

**il nipote**  
nephew

**Signora**  
Mrs.

**gli appellativi** • titles

**Signorina**  
Miss

**Signore**  
Mr.



**le fasi** • stages



**il bimbo**  
baby



**il bambino**  
child



**il ragazzo**  
boy



**la ragazza**  
girl



**l'adolescente**  
teenager



**l'adulto**  
adult



**l'uomo**  
man



**la donna**  
woman

# i rapporti • relationships

**il capo**  
manager

**l'assistente**  
assistant

**il partner di affari**  
business partner

**il datore di lavoro**  
employer

**l'impiegato**  
employee

**il collega**  
colleague



**l'ufficio | office**



**il vicino**  
neighbor



**l'amico**  
friend



**il conoscente**  
acquaintance



**l'amico di penna**  
pen pal

**il ragazzo**  
boyfriend



**la coppia | couple**

**la ragazza**  
girlfriend

**il fidanzato**  
fiancé



**i fidanzati | engaged couple**

**la fidanzata**  
fiancée

## le emozioni • emotions



il sorriso  
smile

**felice**  
happy



**triste**  
sad



**eccitato**  
excited



**annoiato**  
bored



**sorpreso**  
surprised



**spaventato**  
scared



aggrottare  
le ciglia  
frown

**arrabbiato**  
angry



**confuso**  
confused



**preoccupato**  
worried



**nervoso**  
nervous



**fiero**  
proud



**fiducioso**  
confident



**imbarazzato**  
embarrassed



**timido**  
shy

## vocabolario • vocabulary

**sbadigliare**  
yawn (v)

**ridere**  
laugh (v)

**sospirare**  
sigh (v)

**turbato**  
upset

**gridare**  
shout (v)

**svenire**  
faint (v)

**piangere**  
cry (v)

**scandalizzato**  
shocked

# gli avvenimenti della vita • life events



**nascere**  
be born (v)



**iniziare la scuola**  
start school (v)



**fare amicizia**  
make friends (v)



**laurearsi**  
graduate (v)



**trovare un lavoro**  
get a job (v)



**innamorarsi**  
fall in love (v)



**sposarsi**  
get married (v)



**avere un bambino**  
have a baby (v)



**il matrimonio** | wedding



**il divorzio**  
divorce



**il funerale**  
funeral

## vocabolario • vocabulary

**il battesimo**  
christening

**morire**  
die (v)

**il bar mitzvah**  
bar mitzvah

**fare testamento**  
make a will (v)

**l'anniversario**  
anniversary

**il ricevimento nuziale**  
wedding reception

**emigrare**  
emigrate (v)

**il viaggio di nozze**  
honeymoon

**andare in pensione**  
retire (v)

**il certificato di nascita**  
birth certificate

## le celebrazioni • celebrations

la festa di  
compleanno  
birthday party



il compleanno  
birthday

la cartolina  
card



il regalo  
present



il Natale  
Christmas

## le feste • festivals



la Pasqua ebraica  
Passover



il Capodanno  
New Year



il carnevale  
carnival

la  
processione  
procession



il Ramadan  
Ramadan

il nastro  
ribbon



il giorno del ringraziamento  
Thanksgiving



la Pasqua  
Easter



la vigilia d'Ognissanti  
Halloween



il Diwali  
Diwali





**l'aspetto**  
appearance

# gli abiti da bambino • children's clothing

## il bimbo • baby



a canottiera  
undershirt

la tutina  
coverall

il bottone  
automatico  
snap



il pigiama  
sleeper



la tutina da neve  
snowsuit



la tutina senza  
maniche  
romper



il bavaglino  
bib



i guanti  
mittens



le scarpette  
booties



il pannolino  
di spugna  
cloth diaper



il pannolino  
usa e getta  
disposable diaper



le mutande  
di plastica  
plastic pants

## il bambino piccolo • toddler



il cappello per  
il sole  
sun hat



il grembiolino  
apron



la salopette  
overalls

i pantaloncini  
shorts



la maglietta  
T-shirt

la gonna  
skirt





**il bambino • child**



**l'estate**  
summer

**il vestito**  
dress

**il cappuccio**  
hood

**i sandali**  
sandals



**l'impermeabile**  
raincoat

**i jeans**  
jeans



**l'autunno**  
fall

**lo zaino**  
backpack

**l'olivetta**  
toggle



**il montgomery**  
duffle coat



**la sciarpa**  
scarf

**l'eskimo**  
parka

**le galosce**  
wellington  
boots

**l'inverno**  
winter



**la vestaglia**  
bathrobe

**il distintivo**  
logo

**le scarpe da ginnastica**  
athletic shoes

**la camicia da notte**  
nightgown

**le pantofole**  
slippers

**gli indumenti per la notte**  
nightwear



**la tenuta da calcio**  
soccer uniform



**la tuta**  
jogging suit



**il pantacollant**  
leggings

**vocabolario • vocabulary**

**la fibra naturale**  
natural fiber

**sintetico**  
synthetic

**È lavabile in lavatrice?**  
Is it machine washable?

**È la taglia giusta per un bambino di due anni?**  
Will this fit a two-year-old?

# l'abbigliamento da uomo • men's clothing



## vocabolario • vocabulary

**la camicia**  
shirt

**la tuta da sport**  
jogging suit

**la vestaglia**  
bathrobe

**lungo**  
long

**il cardigan**  
cardigan

**la biancheria intima**  
underwear

**l'impermeabile**  
raincoat

**corto**  
short

**Ha una taglia più grande/più piccola?**  
Do you have this in a larger/smaller size?

**Posso provarmelo?**  
May I try this on?



**il blazer**  
blazer



**la giacca sportiva**  
sport coat



**il gilet**  
waistcoat

**il collo a V**  
V-neck

**il girocollo**  
round neck

**la maglietta**  
T-shirt



**il giaccone**  
parka



**la felpa**  
sweatshirt



**la giacca a vento**  
windbreaker

**i pantaloni di felpa**  
sweatpants



**il maglione**  
sweater



**il pigiama**  
pajamas



**la canottiera**  
vest

**il casual**  
casual wear



**i calzoncini**  
shorts



**lo slip**  
briefs



**i boxer**  
boxer shorts



**i calzini**  
socks

# l'abbigliamento da donna • women's clothing



**l'abito da sera**  
evening dress



**il vestito**  
dress



la biancheria intima • lingerie



**il négligé**  
negligée



**la sottoveste**  
slip



**la spallina**  
strap

**il corpetto**  
camisole



**il reggicalze**  
suspender  
belt

**la guêpière**  
bustier



**le calze**  
stockings



**il collant**  
pantyhose

**la canottiera**  
vest



**lo slip**  
panties



**il reggiseno**  
bra



**la camicia da notte**  
nightgown

il matrimonio • wedding



**il pizzo**  
lace

**il velo**  
veil

**il bouquet**  
bouquet

**lo strascico**  
train

**l'abito da sposa**  
wedding dress

vocabolario • vocabulary

**il busto**  
corset

**la giarrettiera**  
garter

**allacciato dietro il collo**  
halter neck

**il girovita**  
waistband

**la spallina**  
shoulder pad

**attillato**  
tailored

**il reggiseno sportivo**  
sports bra

**con armatura**  
underwired

## gli accessori • accessories



**il berretto**  
cap



**il cappello**  
hat



**il foulard**  
scarf

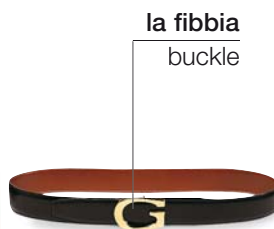

**la fibbia**  
buckle

**la cinta**  
belt



**il manico**  
handle

**la punta**  
tip

**l'ombrello**  
umbrella



**il fazzoletto**  
handkerchief



**la farfalla**  
bow tie



**il fermacravatta**  
tie-pin



**i guanti**  
gloves

## i gioielli • jewelry



**il pendaglio**  
pendant



**la spilla**  
brooch



**il gemello**  
cufflink



**la maglia**  
link

**il bracciale**  
bracelet

**il fermaglio**  
clasp



**la catena**  
chain

**l'orecchino**  
earring

**l'anello**  
ring

**la pietra**  
stone

**la collana**  
necklace

**l'orologio**  
da polso  
watch

**il filo di perle**  
string of pearls



**il cofanetto portagioie** | jewelry box

**le borse • bags**



**il portafoglio**  
wallet



**il portamonete**  
purse



**la borsa a tracolla**  
shoulder bag

la cinghia  
fastening

la bretella  
shoulder strap

i manici  
handles



**la sacca da viaggio**  
duffle bag



**la valigetta**  
briefcase



**la borsetta**  
handbag



**lo zainetto**  
backpack

**le scarpe • shoes**



il laccio  
lace

la lingua  
tongue

l'occhiello  
eyelet

la suola  
sole

il tacco  
heel

**la scarpa con i lacci**  
lace-up



**la scarpa da trekking**  
walking boot



**la scarpa da ginnastica**  
athletic shoe



**la scarpa di cuoio**  
leather shoe



**la ciabatta**  
flip-flop



**la scarpa con il tacco alto**  
high-heeled shoe



**lo zatterone**  
platform shoe



**il sandalo**  
sandal



**il mocassino**  
slip-on



**la scarpa da uomo**  
oxford

# i capelli • hair



il pettine  
comb

pettinare  
comb (v)



la spazzola  
brush

spazzolare | brush (v)



sciacquare  
rinse (v)



la parrucchiera  
hairdresser

il lavandino  
sink

la cliente  
client

lavare | wash (v)



il grembiule  
robe

tagliare  
cut (v)



asciugare con il phon  
blow-dry (v)



mettere in piega  
set (v)

# gli accessori • accessories



l'asciugacapelli  
hairdryer

l'arricciacapelli  
curling iron



lo shampoo  
shampoo



le forbici  
scissors



il balsamo  
conditioner



il cerchietto  
headband



il gel  
gel



i bigodini  
curler



la lacca  
hairspray



la molletta  
hairpin



## le acconciature • styles



**la coda di cavallo**  
ponytail

il nastro  
ribbon



**la treccia**  
braid



**la piega alla francese**  
French braid



**la crocchia**  
bun



**i codini**  
pigtails



**il caschetto**  
bob



**la sfumatura alta**  
crop



**ricci**  
curly



**la permanente**  
perm



**lisci**  
straight



**i colpi di sole**  
highlights

le radici  
roots



**calvo**  
bald



**la parrucca**  
wig

## i colori • colors



**biondo**  
blonde



**bruno**  
brunette



**castano**  
auburn



**rosso**  
red



**nero**  
black



**grigio**  
gray



**bianco**  
white



**tinto**  
dyed

## vocabolario • vocabulary

**l'elastico**  
hairband

**grassi**  
greasy

**spuntare**  
trim (v)

**secchi**  
dry

**il barbiere**  
barber

**normali**  
normal

**le doppie punte**  
split ends

**il cuoio capelluto**  
scalp

**la forfora**  
dandruff

**lisciare**  
straighten (v)

# la bellezza • beauty



la tintura per capelli  
hair dye

l'ombretto  
eyeshadow

il mascara  
mascara

la matita  
per gli occhi  
eyeliner

il fard  
blusher

il fondotinta  
foundation

il rossetto  
lipstick

## il trucco • makeup



la matita per le sopracciglia  
eyebrow pencil



la spazzolina per  
le sopracciglia  
eyebrow brush



le pinzette  
tweezers



lo smalto per  
le labbra  
lip gloss



il pennello per  
le labbra  
lip brush



il marcatore per le labbra  
lip liner



il pennello  
brush



il correttore  
concealer

lo specchio  
mirror



la cipria  
face powder

il piumino  
powder puff



il porta cipria | compact

**i trattamenti di bellezza • beauty treatments**

la maschera di bellezza  
face mask



il trattamento per il viso  
facial



la ceretta  
wax



il lettino solare  
sunbed



esfoliare  
exfoliate (v)



la pedicure  
pedicure

**la manicure • manicure**



la limetta  
nail file

l'acetone  
nail polish remover



lo smalto per unghie  
nail polish

le forbicine per le unghie  
nail scissors



il tagliaunghie  
nail clippers

**gli articoli da toeletta • toiletries**



il latte detergente  
cleanser



la lozione tonificante  
toner



la crema idratante  
moisturizer



la crema autoabbronzante  
self-tanning cream



il profumo  
perfume



l'acqua di colonia  
cologne

**vocabolario • vocabulary**

chiaro fair	grasso oily	l'abbronzatura tan
scuro dark	sensibile sensitive	il tatuaggio tattoo
secco dry	ipoallergenico hypoallergenic	antirughe antiwrinkle
la carnagione complexion	la tonalità shade	i batuffoli di ovatta cotton balls





**la salute**  
health



# la malattia • illness



**il febbre** | fever



**il mal di testa**  
headache



**l'emorragia nasale**  
nosebleed



**la tosse**  
cough

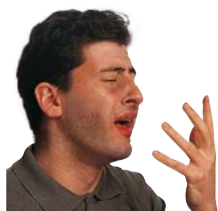

**lo starnuto**  
sneeze



**il raffreddore**  
cold



**l'influenza**  
flu

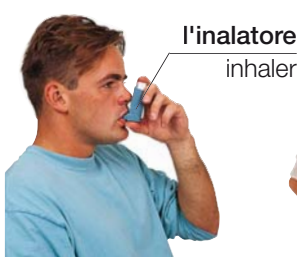

**l'asma**  
asthma



**i crampi**  
cramps



**la nausea**  
nausea



**la varicella**  
chickenpox



**lo sfogo**  
rash

## vocabolario • vocabulary

**l'infarto**  
heart attack

**il diabete**  
diabetes

**l'eczema**  
eczema

**l'infreddatura**  
chill

**vomitare**  
vomit (v)

**la diarrea**  
diarrhea

**l'apoplessia**  
stroke

**l'allergia**  
allergy

**l'infezione**  
infection

**svenire**  
faint (v)

**l'epilessia**  
epilepsy

**il morbillo**  
measles

**la pressione del sangue**  
blood pressure

**la febbre da fieno**  
hayfever

**il virus**  
virus

**il mal di stomaco**  
stomachache

**l'emicrania**  
migraine

**gli orecchioni**  
mumps

**il medico • doctor**

**la visita • consultation**

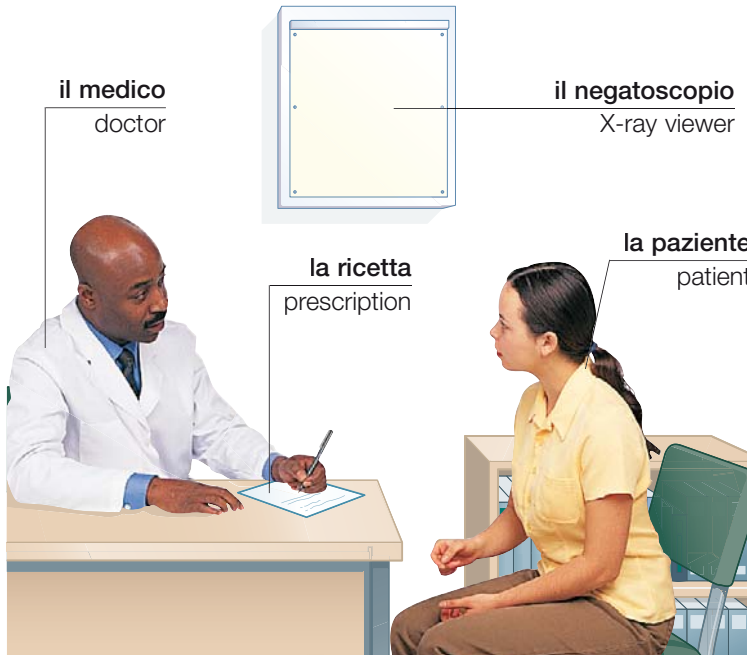

**il medico**  
doctor

**il negatoscopio**  
X-ray viewer

**la ricetta**  
prescription

**la paziente**  
patient

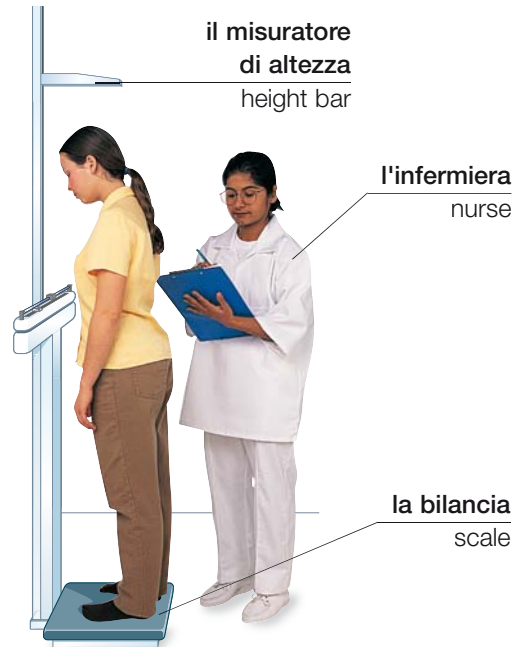

**il misuratore di altezza**  
height bar

**l'infermiera**  
nurse

**la bilancia**  
scale

**il misuratore di pressione**  
blood pressure gauge

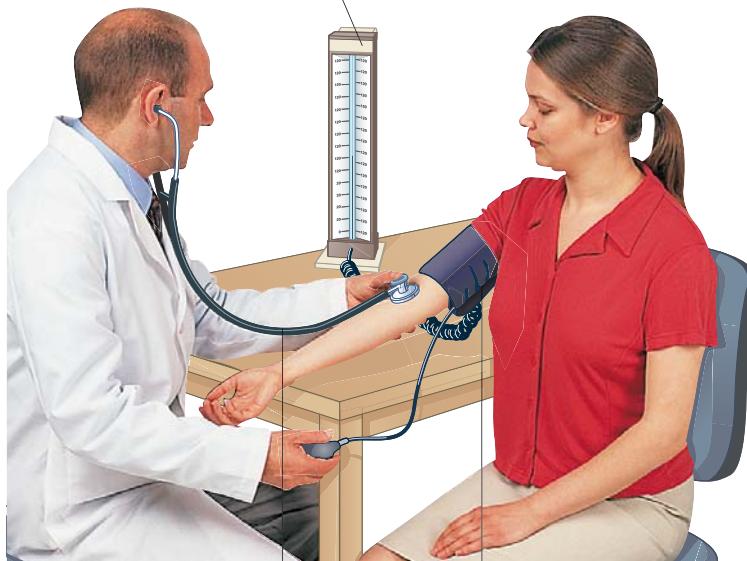

**lo stetoscopio**  
stethoscope

**il manicotto**  
cuff

**vocabolario • vocabulary**

**l'appuntamento**  
appointment

**l'inoculazione**  
vaccination

**l'ambulatorio**  
surgery

**il termometro**  
thermometer

**la sala d'attesa**  
waiting room

**la visita medica**  
medical examination

**Ho bisogno di vedere un medico.**  
I need to see a doctor.

**Ho un dolore qui.**  
It hurts here.

# la ferita • injury



la slogatura | sprain

la fascia  
a tracolla  
sling



la frattura  
fracture

il collare  
neck brace



il colpo di frusta  
whiplash



il taglio  
cut



la sbucciatura  
graze



il livido  
bruise



la scheggia  
splinter



la scottatura  
sunburn



l'ustione  
burn



il morso  
bite



la puntura  
sting

## vocabolario • vocabulary

l'incidente  
accident

l'emorragia  
hemorrhage

la commozione  
concussion

Si rimetterà?  
Will he/she be all right?

l'emergenza  
emergency

la vescica  
blister

la ferita alla testa  
head injury

Chiami un'ambulanza, per favore.  
Please call an ambulance.

la ferita  
wound

l'avvelenamento  
poisoning

la scossa elettrica  
electric shock

Dove le fa male?  
Where does it hurt?



# il pronto soccorso • first aid

**la pomata**  
ointment

**il cerotto**  
adhesive  
bandage

**la spilla da balia**  
safety pin

**la benda**  
bandage

**gli antidolorifici**  
painkillers



**la salvietta  
antisettica**  
antiseptic wipe

**le pinzette**  
tweezers

**le forbici**  
scissors

**il disinfettante**  
antiseptic

la cassetta di pronto soccorso | first aid box

**la garza**  
gauze



la bendatura  
dressing



la stecca | splint



il nastro  
adesivo  
adhesive tape



la rianimazione  
resuscitation

## vocabolario • vocabulary

**lo shock**  
shock

**sterile**  
sterile

**soffocare**  
choke (v)

**Può aiutarmi?**  
Can you help?

**privo di  
sensi**  
unconscious

**la  
respirazione**  
breathing

**le  
pulsazioni**  
pulse

**Sa dare pronto soccorso?**  
Do you know first aid?

# l'ospedale • hospital



**l'analisi del sangue**  
blood test



**l'iniezione**  
injection



**la radiografia**  
X-ray



**la sala emergenze**  
emergency room



**il reparto**  
ward



**la sedia a rotelle**  
wheelchair

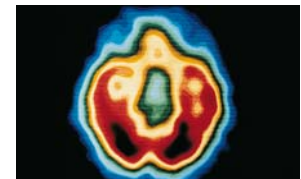

**l'ecografia**  
scan

## vocabolario • vocabulary

**l'operazione**  
operation

**dimesso**  
discharged

**l'orario delle visite**  
visiting hours

**il reparto maternità**  
maternity ward

**il paziente esterno**  
outpatient

**ricoverato**  
admitted

**la clinica**  
clinic

**il reparto pediatrico**  
children's ward

**la camera privata**  
private room

**il reparto di cura intensiva**  
intensive care unit

**i reparti • departments**



**l'otorinolaringologia**  
ENT (otolaryngology)



**la cardiologia**  
cardiology



**l'ortopedia**  
orthopedics



**la ginecologia**  
gynecology



**la fisioterapia**  
physiotherapy



**la dermatologia**  
dermatology



**la pediatria**  
pediatrics



**la radiologia**  
radiology



**la chirurgia**  
surgery



**la maternità**  
maternity



**la psichiatria**  
psychiatry



**l'oftalmologia**  
ophthalmology

**vocabolario • vocabulary**

**la neurologia**  
neurology

**l'urologia**  
urology

**l'analisi**  
test

**la patologia**  
pathology

**il risultato**  
result

**l'oncologia**  
oncology

**l'endocrinologia**  
endocrinology

**lo specialista**  
specialist

**la chirurgia plastica**  
plastic surgery

**mandare da  
uno specialista**  
referral

# il dentista • dentist

## il dente • tooth

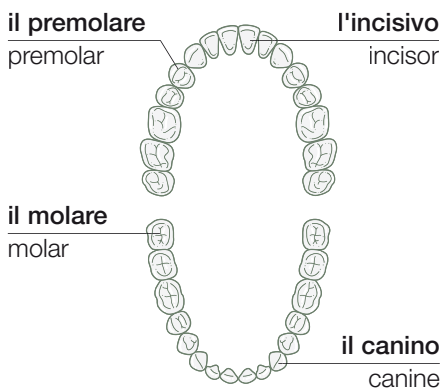
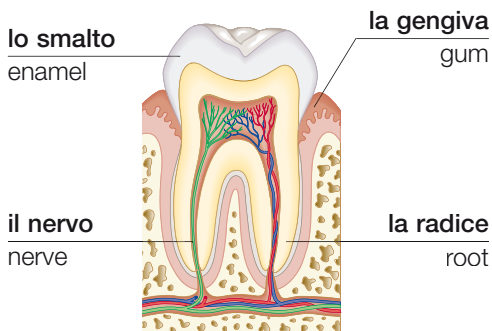

## il controllo • checkup



### vocabolario • vocabulary

<b>il mal di denti</b> toothache	<b>il trapano</b> drill
<b>la placca</b> plaque	<b>il filo dentale</b> dental floss
<b>la carie</b> decay	<b>l'estrazione</b> extraction
<b>l'otturazione</b> filling	<b>la corona</b> crown



**usare il filo dentale**  
floss (v)



**spazzolare**  
brush



**l'apparecchio correttore**  
brace



**la radiografia dentale**  
dental X-ray



**la pellicola radiografica**  
X-ray film



**la dentiera**  
dentures

# l'ottico • optometrist



l'esame della vista | eye test

la custodia  
case



gli occhiali  
glasses

la lente  
lens



gli occhiali da sole  
sunglasses

la montatura  
frame

la soluzione per la pulizia  
cleaning fluid



la soluzione  
disinfettante  
disinfectant solution



la custodia  
per le lenti  
lens case

le lenti a contatto | contact lenses

# l'occhio • eye

il sopracciglio  
eyebrow

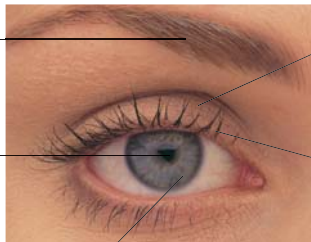

la palpebra  
eyelid

la pupilla  
pupil

il ciglio  
eyelash

l'iride  
iris

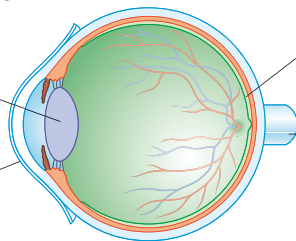

la retina  
retina

la lente  
lens

il nervo ottico  
optic nerve

la cornea  
cornea

# vocabolario • vocabulary

la vista  
vision

l'astigmatismo  
astigmatism

la diottria  
diopter

la presbiopia  
farsightedness

la lacrima  
tear

la miopia  
nearsightedness

la cataratta  
cataract

bifocale  
bifocal

# la gravidanza • pregnancy

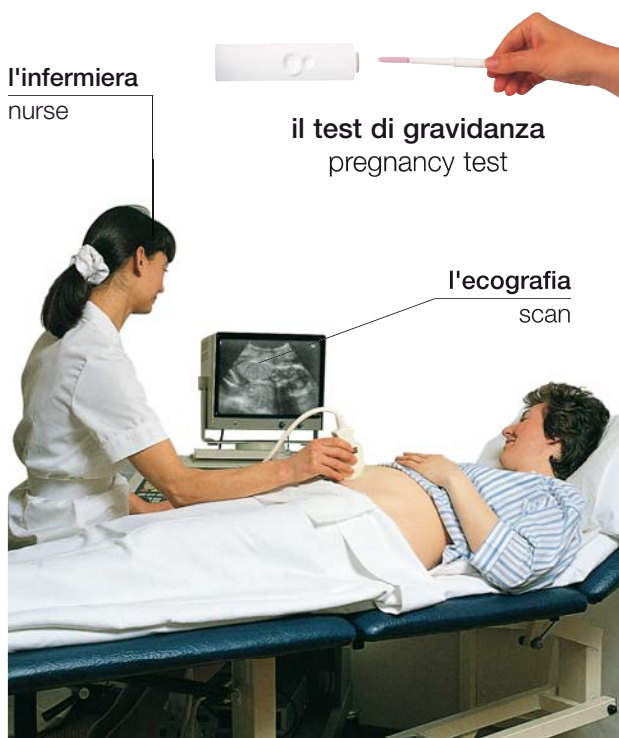

**l'infermiera**  
nurse

**il test di gravidanza**  
pregnancy test

**l'ecografia**  
scan

**l'ultrasuono** | ultrasound

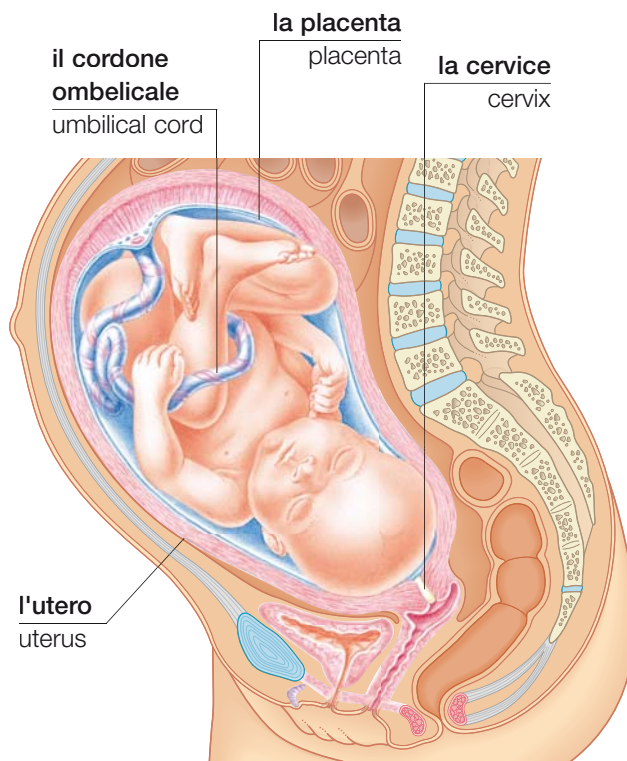

**il cordone ombelicale**  
umbilical cord

**la placenta**  
placenta

**la cervice**  
cervix

**l'utero**  
uterus

**il feto** | fetus

## vocabolario • vocabulary

**l'ovulazione**  
ovulation

**prenatale**  
prenatal

**il grembo**  
womb

**la dilatazione**  
dilation

**i punti**  
stitches

**podalico**  
breech

**la concezione**  
conception

**il trimestre**  
trimester

**l'amniocentesi**  
amniocentesis

**l'epidurale**  
epidural

**il parto**  
delivery

**premature**  
premature

**incinta**  
pregnant

**l'embrione**  
embryo

**la contrazione**  
contraction

**l'episiotomia**  
episiotomy

**la nascita**  
birth

**il ginecologo**  
gynecologist

**in stato interessante**  
expecting

**il liquido amniotico**  
amniotic fluid

**rompere le acque**  
break water (v)

**il taglio cesareo**  
cesarean section

**l'aborto spontaneo**  
miscarriage

**l'ostetrico**  
obstetrician

# il parto • childbirth

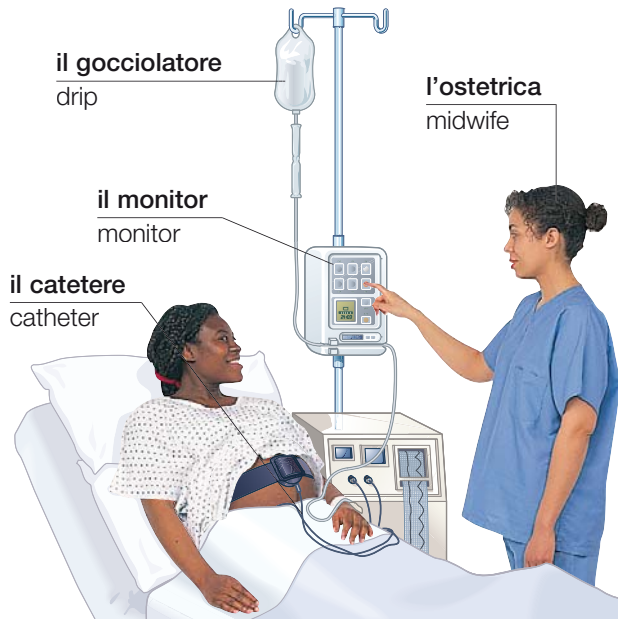

**il gocciolatore**  
drip

**l'ostetrica**  
midwife

**il monitor**  
monitor

**il catetere**  
catheter

**il travaglio indotto**  
induce labor (v)



**l'incubatrice** | incubator



**la bilancia**  
scale

**il peso alla nascita** | birth weight

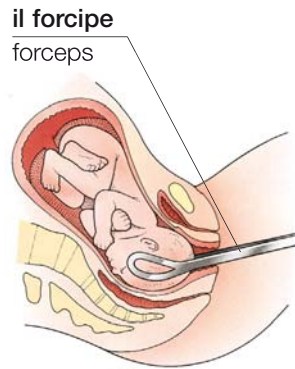

**il forcipe**  
forceps

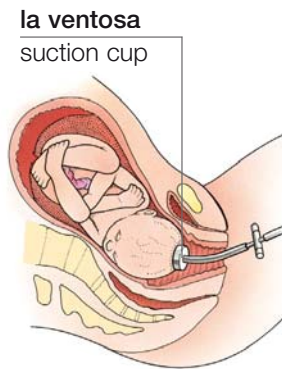

**la ventosa**  
suction cup

**il parto assistito**  
assisted delivery

**la targhetta d'identità**  
identity tag



**il neonato**  
newborn baby

# l'allattamento • nursing



**la pompa da seno**  
breast pump



**il reggiseno da allattamento**  
nursing bra



**allattare al seno**  
breastfeed (v)



**le coppe**  
pads

# le terapie alternative • complementary therapy

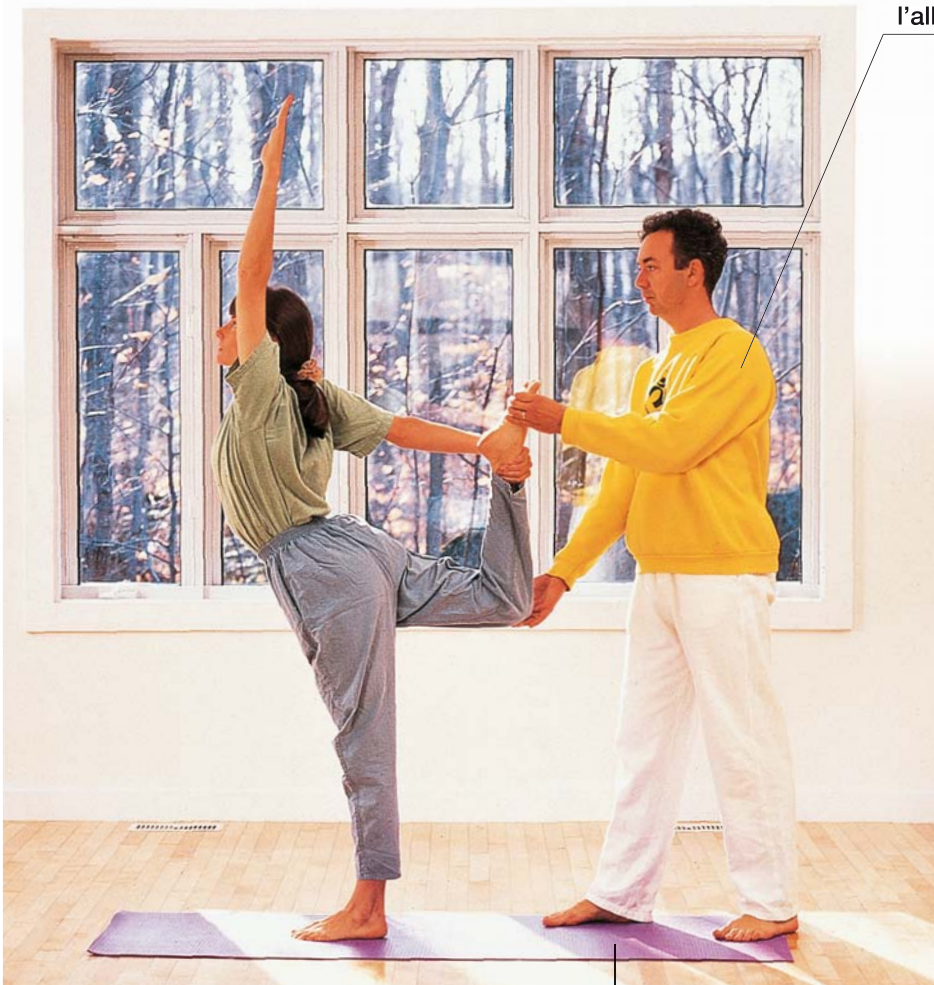

lo yoga | yoga

il tappetino  
mat

l'allenatore  
teacher



il massaggio  
massage



lo shiatsu  
shiatsu



la meditazione  
meditation



la chiropratica  
chiropractic

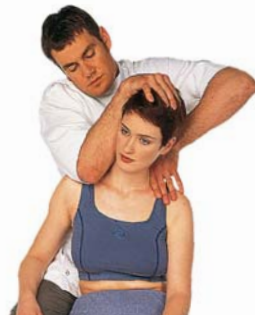

l'osteopatia  
osteopathy



la riflessologia  
reflexology



**l'assistente socio-  
psicologico**  
counselor



**la terapia di gruppo**  
group therapy

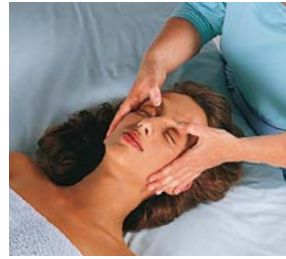

**il reiki**  
reiki



**l'agopuntura**  
acupuncture



**la medicina aiurvedica**  
ayurveda



**l'ipnositerapia**  
hypnotherapy

**gli oli essenziali**  
essential oils



**l'erbalismo**  
herbalism



**l'aromaterapia**  
aromatherapy



**l'omeopatia**  
homeopathy



**l'agopressione**  
acupressure

**la terapeuta**  
therapist



**la psicoterapia**  
psychotherapy

**vocabolario** • vocabulary

**la cristalloterapia**  
crystal healing

**la naturopatia**  
naturopathy

**il rilassamento**  
relaxation

**l'erba**  
herb

**l'idroterapia**  
hydrotherapy

**il feng shui**  
feng shui

**lo stress**  
stress

**l'integratore**  
supplement





**la casa**  
home

# la casa • house

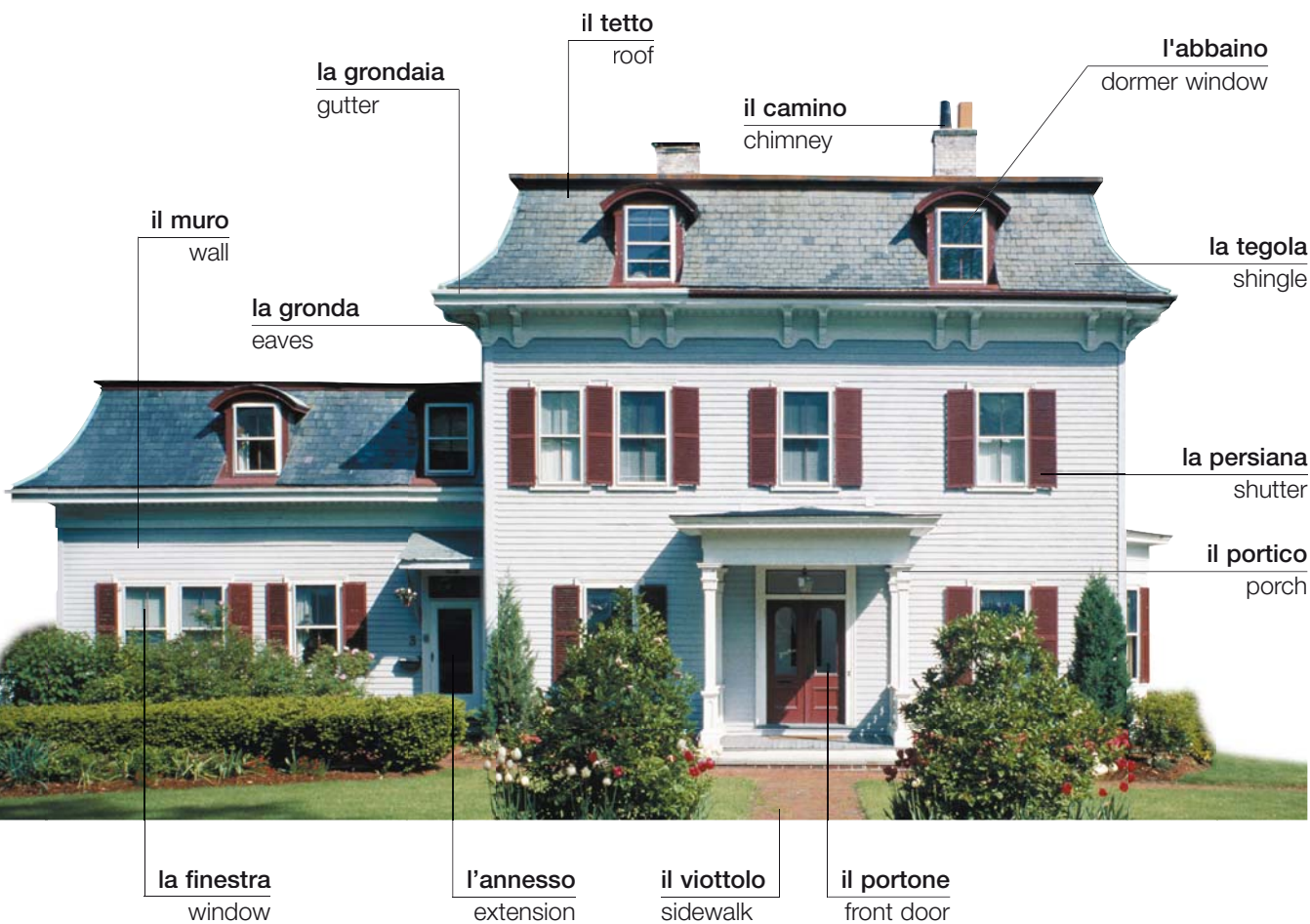

## vocabolario • vocabulary

**unifamiliare**  
single-family

**la casa di città**  
townhouse

**il garage**  
garage

**il piano**  
floor

**il seminterrato**  
basement

**affittare**  
rent (v)

**bifamiliare**  
duplex

**il villino**  
ranch house

**l'attico**  
attic

**il cortile**  
courtyard

**la stanza**  
room

**l'affitto**  
rent

**a schiera**  
row house

**l'allarme  
antifurto**  
burglar alarm

**la cassetta  
per le lettere**  
mailbox

**la luce del  
portico**  
porch light

**il padrone  
di casa**  
landlord

**l'inquilino**  
tenant

**l'ingresso • entrance**

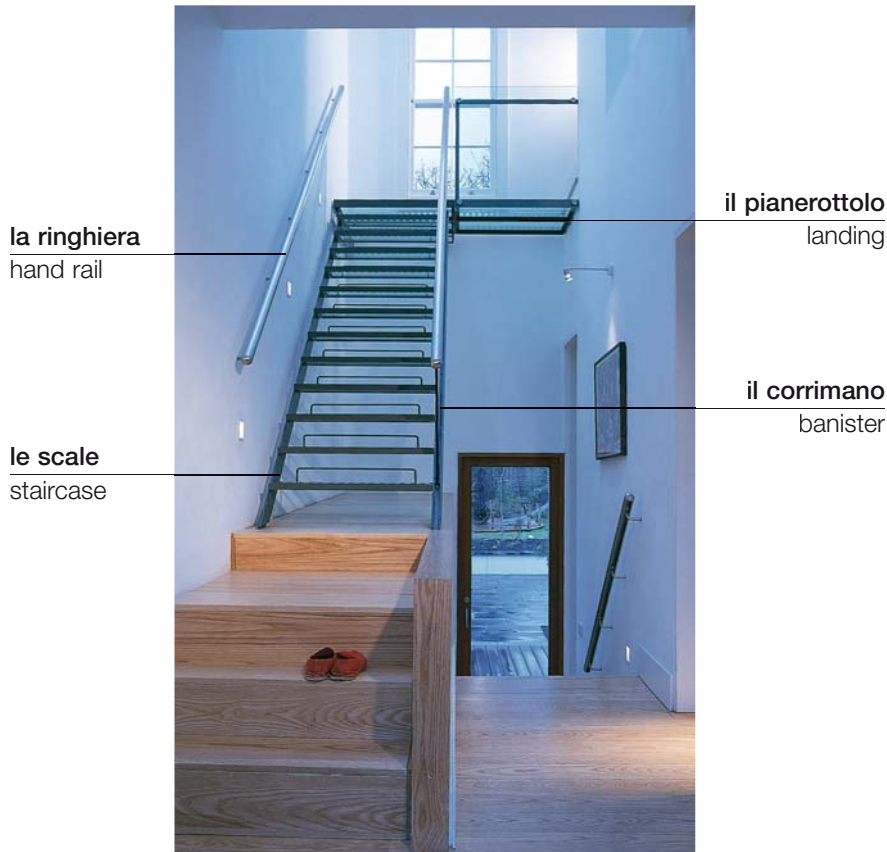

**la ringhiera**  
hand rail

**le scale**  
staircase

**il pianerottolo**  
landing

**il corrimano**  
banister

**l'entrata**  
foyer



**il campanello**  
doorbell



**lo zerbino**  
doormat



**il battente**  
door knocker



**la catenella**  
door chain



**la chiave**  
key



**la serratura**  
lock



**il chiavistello**  
bolt

**l'appartamento • apartment**



**il balcone**  
balcony

**il caseggiato**  
apartment building



**il citofono**  
intercom



**l'ascensore**  
elevator

## i sistemi interni • internal systems



**il calorifero**  
radiator



**la stufa**  
space heater



**la pala**  
blade

**il ventilatore**  
fan



**la stufa a convezione**  
convector heater

## l'elettricità • electricity



**il filamento**  
filament

**l'attacco a baionetta**  
base

**la lampadina**  
light bulb

**la messa a terra**  
ground



**la spina**  
plug

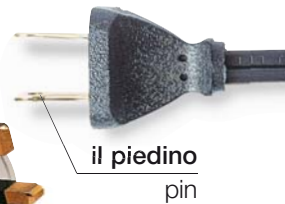

**il piedino**  
pin

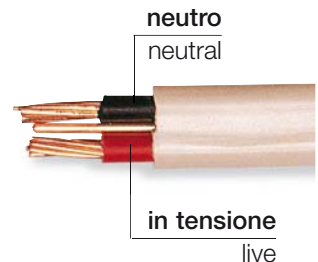

**neutro**  
neutral

**in tensione**  
live

**i fili**  
wires

## vocabolario • vocabulary

**la tensione**  
voltage

**il fusibile**  
fuse

**la presa**  
outlet

**il generatore**  
generator

**il trasformatore**  
transformer

**l'ampere**  
amp

**la valvoliera**  
fuse box

**l'interruttore**  
switch

**l'elettricità**  
power

**l'alimentazione di rete**  
household current

**l'interruzione di corrente**  
power outage

**la corrente continua**  
direct current

**la corrente alternata**  
alternating current

**il contatore di corrente**  
electric meter

# l'impianto idraulico • plumbing

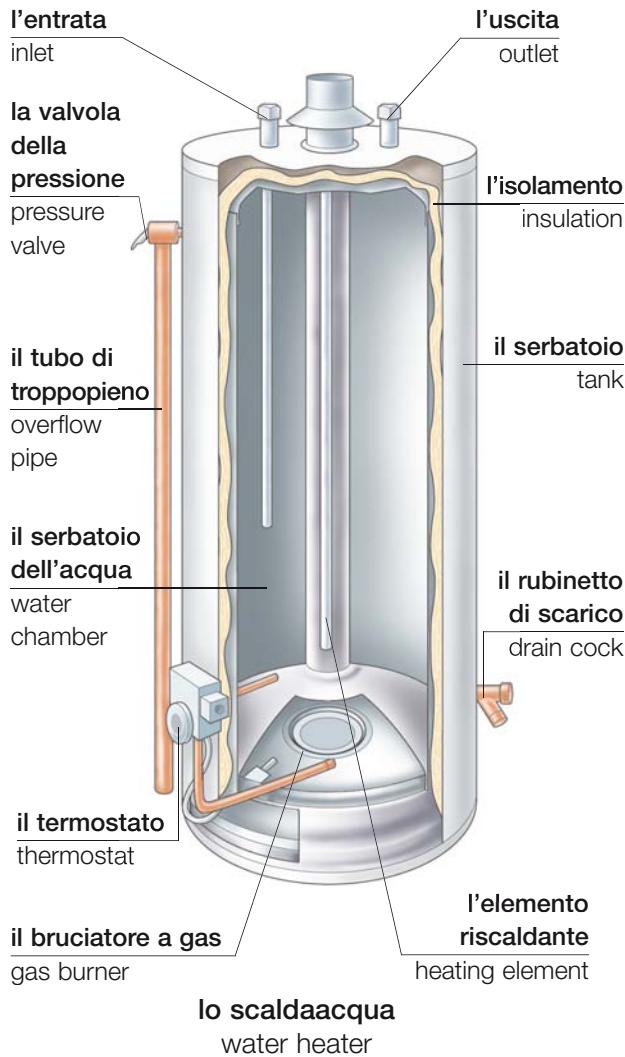

## l'acquaio • sink

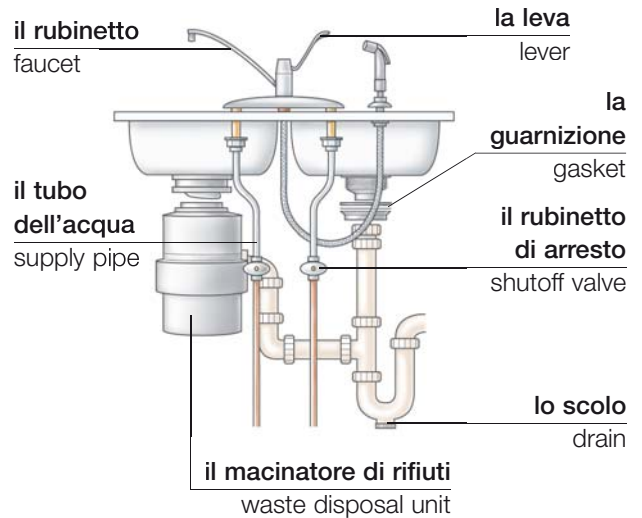

## il water • toilet

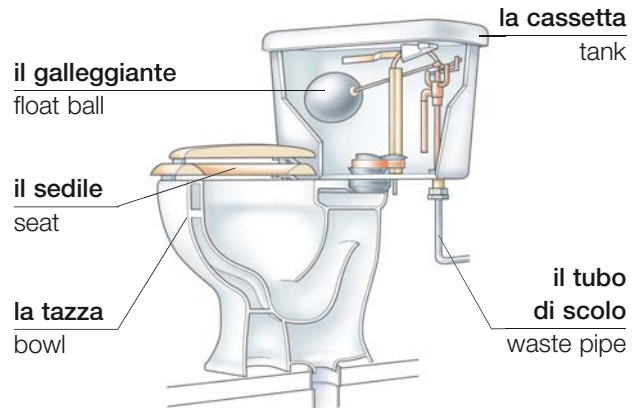

## lo smaltimento dei rifiuti • waste disposal



# il salotto • living room

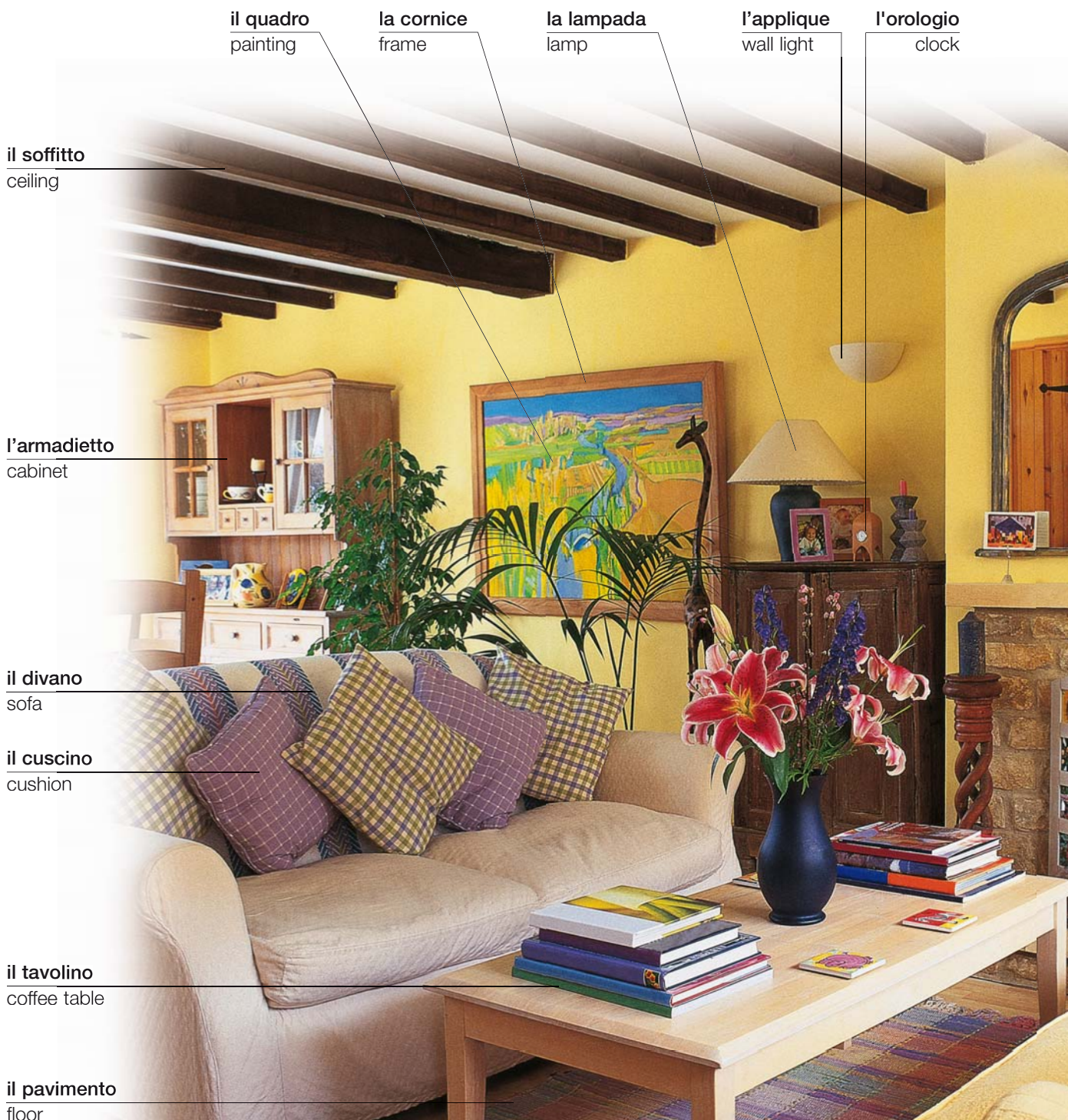

il quadro  
painting

la cornice  
frame

la lampada  
lamp

l'applique  
wall light

l'orologio  
clock

il soffitto  
ceiling

l'armadietto  
cabinet

il divano  
sofa

il cuscino  
cushion

il tavolino  
coffee table

il pavimento  
floor



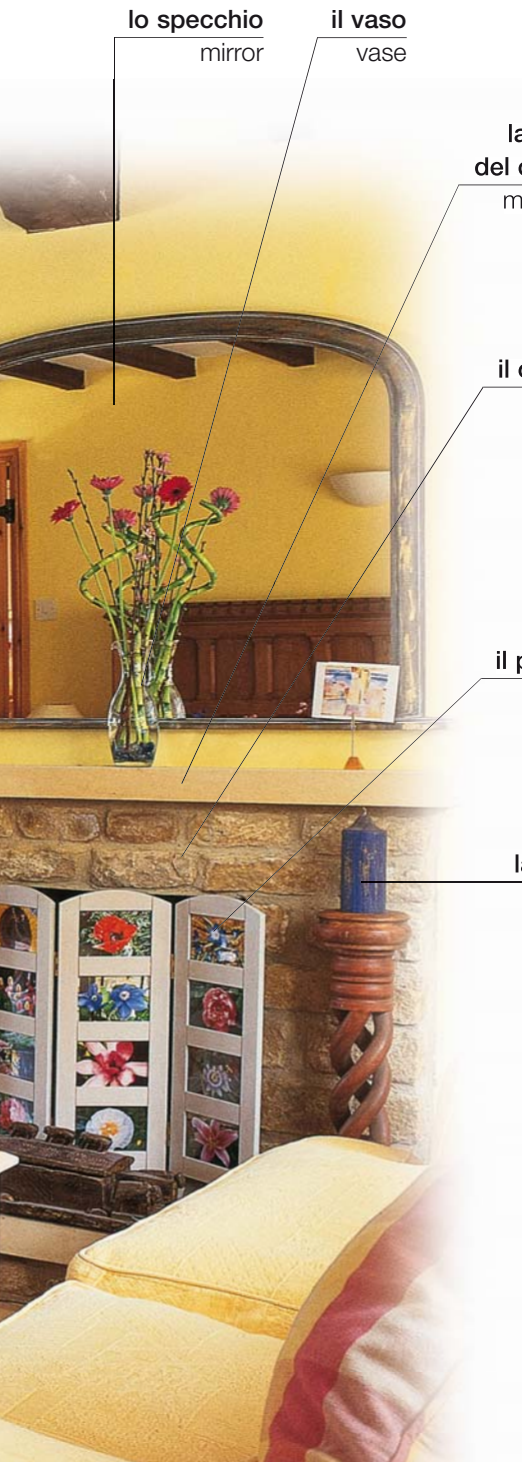

**lo specchio**  
mirror

**il vaso**  
vase

**la mensola  
del caminetto**  
mantelpiece

**il caminetto**  
fireplace

**il parafuoco**  
screen

**la candela**  
candle

**la libreria**  
bookshelf

**il divano letto**  
sofabed

**il tappeto**  
rug



**la tenda**  
curtain



**la tendina**  
net curtain



**la veneziana**  
venetian blind



**l'avvolgibile**  
roller shade

**la cornice**  
molding

**la poltrona**  
armchair



**lo studio** | study

# la sala da pranzo • dining room



## vocabolario • vocabulary

**servire**  
serve (v)

**la colazione**  
breakfast

**il pranzo**  
lunch

**sazio**  
full

**affamato**  
hungry

**mangiare**  
eat (v)

**la tovaglia**  
tablecloth

**la cena**  
dinner

**il pasto**  
meal

**l'ospite**  
guest

**apparecchiare**  
set the table (v)

**la tovaglia  
individuale**  
placemat

**la  
porzione**  
portion

**il  
padrone  
di casa**  
host

**la padrona  
di casa**  
hostess

**Posso averne ancora,  
per favore?**  
Can I have some more, please?

**Ne ho avuto abbastanza,  
grazie.**  
I've had enough, thank you.

**Era squisito.**  
That was delicious.

# le stoviglie e le posate • crockery and cutlery



**la tazza**  
mug



**la tazzina da caffè**  
coffee cup



**la tazza da té**  
teacup

**il cucchiaino**  
teaspoon



**il piatto**  
plate



**la ciotola**  
bowl



**la caffettiera**  
cafetière



**la teiera**  
teapot



**la brocca**  
jug



**il portauovo**  
egg cup

**il calice da vino**  
wine glass



**il bicchiere**  
tumbler

**la cristalleria**  
glassware

**il portatovagliolo**  
napkin ring

**il piattino**  
side plate

**il piatto piano**  
dinner plate

**la scodella**  
soup bowl

**il cucchiaino da minestra**  
soup spoon



**il tovagliolo**  
napkin



**la forchetta**  
fork



**il coperto**  
place setting



**il cucchiaino**  
spoon

**il coltello**  
knife

# la cucina • kitchen



## gli elettrodomestici • appliances



**il forno a microonde**  
microwave oven



**il bollitore**  
electric kettle



**il tostapane**  
toaster

**il recipiente**  
mixing bowl

**la lama**  
blade

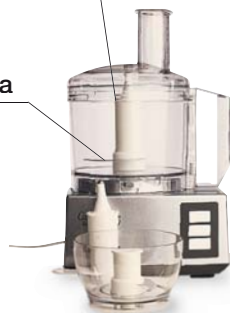

**il miscelatore**  
food processor

**il coperchio**  
lid



**il frullatore**  
blender



**la lavastoviglie**  
dishwasher

**il fabbrica-  
ghiaccio**

icemaker

**il  
congelatore**

freezer



**la mensola**  
shelf

**il cassetto  
per la verdura**  
crisper

**il frigocongelatore** | refrigerator

**vocabolario** • vocabulary

**la piastra**  
range

**congelare**  
freeze (v)

**il gocciolatoio**  
draining board

**scongelerare**  
defrost (v)

**il fornello**  
burner

**cuocere al  
vapore**  
steam (v)

**la pattumiera**  
garbage can

**saltare in  
padella**  
sauté (v)

**cucinare** • cooking



**sbucciare**  
peel (v)



**affettare**  
slice (v)



**grattugiare**  
grate (v)



**versare**  
pour (v)



**mescolare**  
mix (v)



**sbattere**  
whisk (v)



**bollire**  
boil (v)



**friggere**  
fry (v)



**spianare**  
roll (v)



**rimestare**  
stir (v)



**cuocere a  
fuoco lento**  
simmer (v)



**affogare**  
poach (v)



**cuocere al forno**  
bake (v)



**arrostire**  
roast (v)



**cuocere alla  
griglia**  
broil (v)

# gli utensili da cucina • kitchenware



**il tagliere**  
cutting board

**il coltello da pane**  
bread knife



**il coltello da cucina**  
kitchen knife



**la mannaia**  
cleaver



**l'affilacoltelli**  
knife sharpener



**il martello**  
meat tenderizer



**lo spiedino**  
skewer



**la grattugia**  
grater



**il pestello**  
pestle

**il mortaio**  
mortar



**lo schiacciapate**  
masher



**il pelapatate**  
vegetable peeler



**il cavatorsoli**  
apple corer



**l'apriscatole**  
can opener



**l'apribottiglie**  
bottle opener



**lo spremiaglio**  
garlic press



**il cucchiaino da portata**  
serving spoon



**la paletta forata**  
slotted spatula



**lo scolapasta**  
colander



**la spatola**  
spatula



**il cucchiaino di legno**  
wooden spoon



**il cucchiaino perforato**  
slotted spoon



**il mestolo**  
ladle



**il forchettone**  
carving fork



**il cucchiaino dosatore**  
ice-cream scoop



**la frusta**  
whisk



**il colino**  
sieve



**la cottura dei dolci • baking cakes**



# la camera da letto • bedroom

**l'armadio**  
wardrobe

**la lampadina**  
bedside lamp

**la testata**  
headboard

**il comodino**  
nightstand

**il cassetto**  
chest of drawers



**il cassetto**  
drawer

**il letto**  
bed

**il materasso**  
mattress

**il copriletto**  
bedspread

**il guanciaie**  
pillow



**la borsa calda**  
hot-water bottle



**la radiosveglia**  
clock radio



**la sveglia**  
alarm clock



**la scatola di fazzolettini**  
box of tissues



**la gruccia**  
coat hanger



la biancheria da letto • bed linen



lo specchio  
mirror

la toeletta  
dressing  
table

il pavimento  
floor



la federa  
pillowcase

il lenzuolo  
sheet

il volant  
dust ruffle

la coperta  
imbottita  
comfoter

la trapunta  
quilt

la coperta  
blanket



vocabolario • vocabulary

la termocoperta  
electric blanket

la molla  
spring

l'insonnia  
insomnia

svegliarsi  
wake up (v)

mettere la sveglia  
set the alarm (v)

il letto singolo  
twin bed

il tappeto  
carpet

andare a letto  
go to bed (v)

alzarsi  
get up (v)

russare  
snore (v)

il letto  
matrimoniale  
full bed

la pedana  
del letto  
footboard

addormentarsi  
go to sleep (v)

fare il letto  
make the bed (v)

l'armadio a muro  
built-in wardrobe

# la stanza da bagno • bathroom

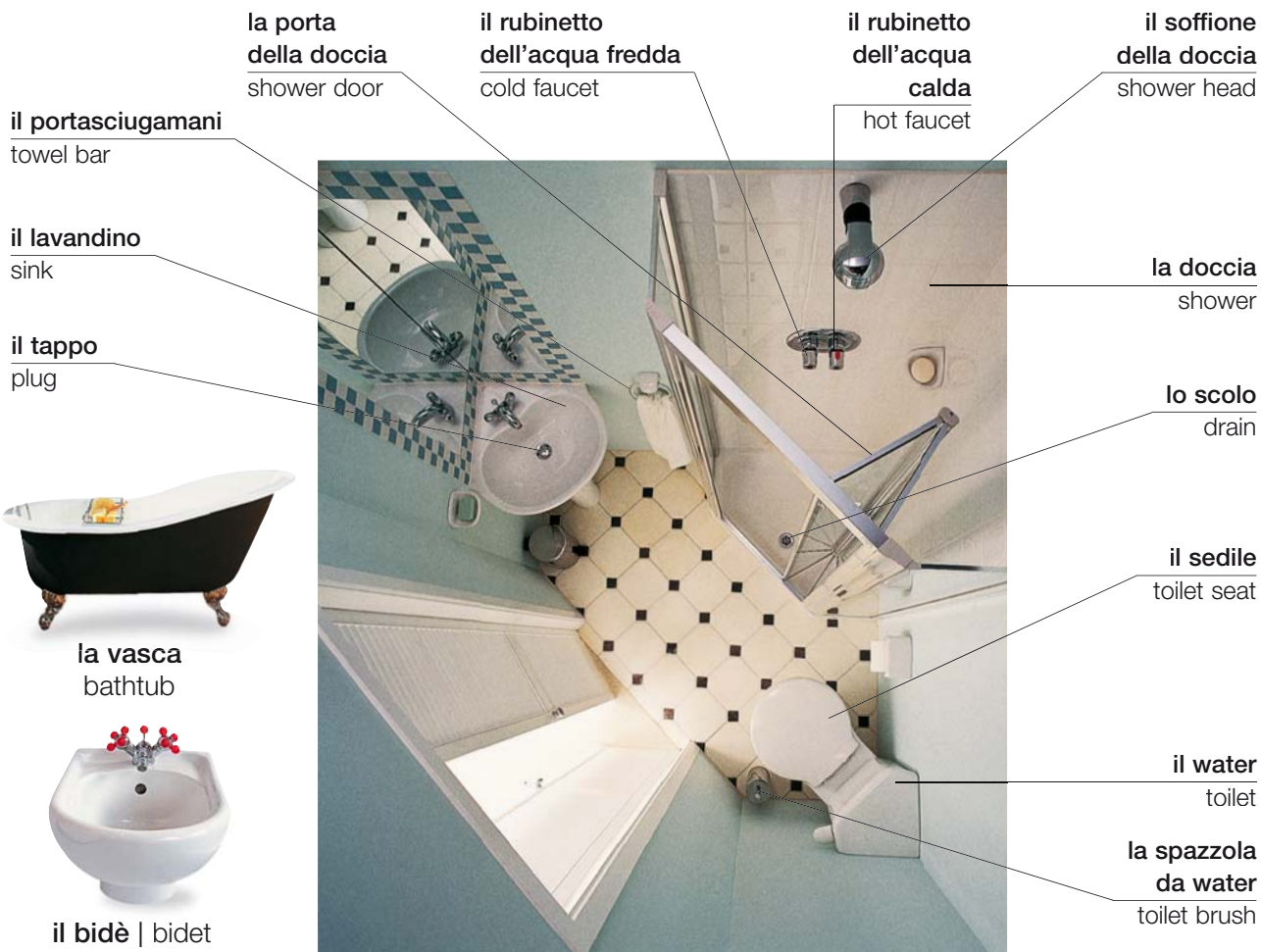

## vocabolario • vocabulary

**la carta igienica**  
toilet paper

**lo scendibagno**  
bath mat

**l'armadietto dei medicinali**  
medicine cabinet

**la tenda da doccia**  
shower curtain

**farsi la doccia**  
take a shower (v)

**farsi il bagno**  
take a bath (v)

## l'igiene dentale • dental hygiene

  
**lo spazzolino da denti**  
toothbrush

**il filo interdentale**  
dental floss

  
**il dentifricio**  
toothpaste

  
**il collutorio**  
mouthwash



la luffa  
loofah

la spugna  
sponge



la pomice  
pumice stone



la spazzola  
back brush



il deodorante  
deodorant

il portasapone  
soap dish



il sapone  
soap

la docciaschiuma  
shower gel



la crema per il viso  
face cream



il bagnoschiuma  
bubble bath



l'accappatoio  
bathrobe

l'asciugamano  
piccolo  
hand towel



gli asciugamani  
towels

l'asciugamano  
grande  
bath towel



la lozione per il corpo  
body lotion



il talco  
talcum powder

## la rasatura • shaving

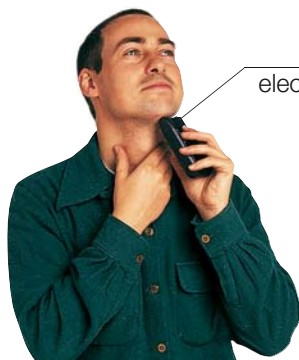

il rasoio  
elettrico  
electric razor



la schiuma da barba  
shaving foam



il rasoio monouso  
disposable razor



la lametta  
razor blade



il dopobarba  
aftershave

# la camera dei bambini • baby's room

## l'igiene del neonato • baby care



la spugna  
sponge

la pomata  
antirossore  
diaper rash cream



la salviettina  
umidificata  
wet wipe

il vasino  
potty



il materassino  
changing mat

la vaschetta  
baby bath

## la dormita • sleeping



il mobile  
mobile

le sbarre  
bars

il paracolpi  
bumper

il materasso  
mattress

il lettino | crib

il lenzuolo  
sheet

la coperta  
blanket

la felpa  
fleece

la biancheria da letto  
bedding



il sonaglio  
rattle



il portabebè  
bassinet

**il gioco • playing**



la bambola  
doll

il giocattolo di pezza  
soft toy



la casa delle bambole  
dollhouse



la casa da gioco  
playhouse

**la sicurezza • safety**

il fermo di sicurezza  
child lock



la trasmittente  
baby monitor



l'orsacchiotto  
teddy bear

il giocattolo  
toy

il cesto dei giocattoli  
toy basket



la palla  
ball

il box  
playpen



lo sbarramento  
stair gate

**il pasto • eating**



il seggiolone  
high chair



la tettarella  
nipple

la tazza  
per bere  
drinking cup

il biberon  
bottle

**la passeggiata • going out**



il passeggino  
stroller



la capote  
hood

la carrozzina  
baby carriage



la culla portatile  
carrier



il pannolino  
diaper

la borsa dei ricambi  
diaper bag



il marsupio  
baby sling

# la lavanderia • utility room

## il bucato • laundry

**i panni  
sporchi**  
dirty laundry



**il cesto della  
biancheria da lavare**  
laundry basket



**la lavatrice**  
washing machine



**il lavasciuga**  
washer-dryer



**l'asciugabiancheria**  
tumble-dryer

**i vestiti puliti**  
clean clothes



**il cesto della  
biancheria pulita**  
linen basket



**la molletta**  
clothespin

**asciugare**  
dry (v)



**la corda  
per bucato**  
clothesline

**l'asse da stiro** | ironing board



**il ferro da stiro**  
iron

### vocabolario • vocabulary

**caricare**  
load (v)

**centrifugare**  
spin (v)

**stirare**  
iron (v)

**Come funziona la lavatrice?**  
How do I operate the washing machine?

**sciacquare**  
rinse (v)

**la centrifuga**  
spin-dryer

**l'ammorbidente**  
fabric softener

**Qual è il programma per i tessuti colorati/bianchi?**  
What is the setting for colors/whites?

gli accessori per la pulizia • cleaning equipment



le attività • activities



# il laboratorio • workshop



**la sega da traforo**  
jigsaw



**la batteria**  
battery pack

**il trapano ricaricabile**  
cordless drill



**il mandrino**  
chuck

**il trapano elettrico**  
electric drill



**la punta**  
drill bit



**la pistola per colla**  
glue gun



**la morsa**  
vise

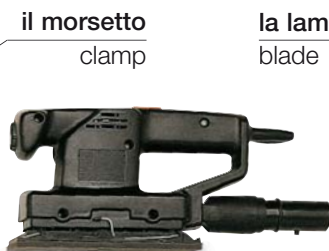

**il morsetto**  
clamp

**la levigatrice**  
sander

**la lama**  
blade

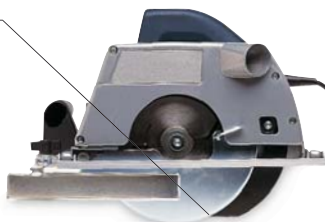

**la sega circolare**  
circular saw



**il banco da lavoro**  
workbench

**la colla da legno**  
wood glue

**la contornitrice**  
router

**i trucioli**  
wood shavings



**la rastrelliera per gli arnesi**  
tool rack

**il girabacchino**  
bit brace

**la prolunga**  
extension cord



## le tecniche • techniques



**tagliare**  
cut (v)



**segare**  
saw (v)



**forare**  
drill (v)



**martellare**  
hammer (v)



**piallare**  
plane (v)

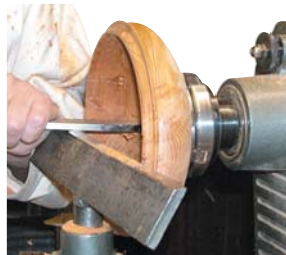

**tornire**  
turn (v)



**la lega per saldatura**  
solder

**incidere**  
carve (v)

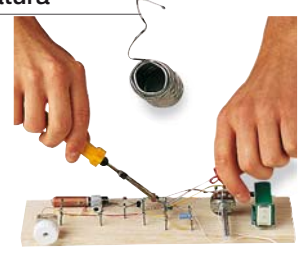

**saldare**  
solder (v)

## i materiali • materials

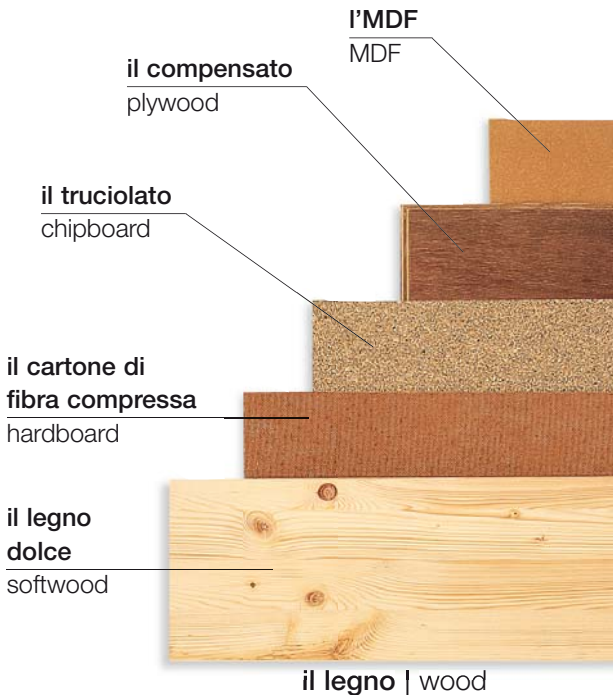

# la scatola degli attrezzi • toolbox

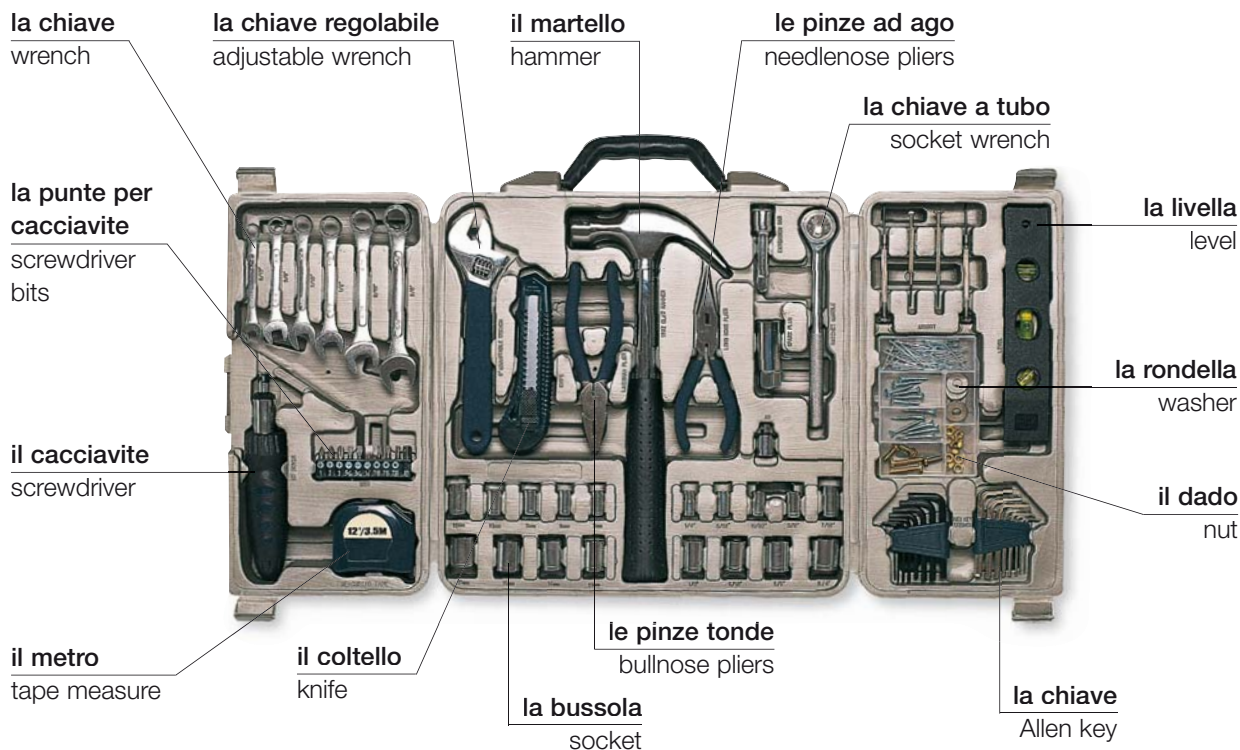

## le punte • drill bits

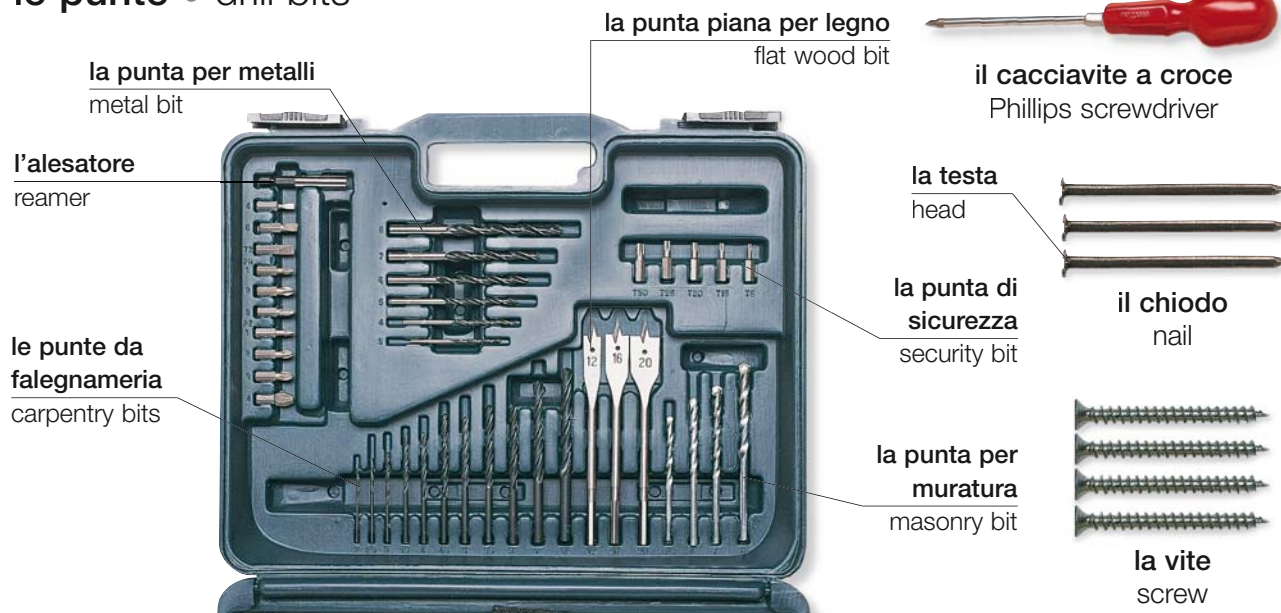

la pinza spelafilo  
wire strippers

la pinza tagliafilo  
wire cutters

il saldatoio  
soldering iron

il nastro  
isolante  
insulating  
tape

le lega per  
saldatura  
solder

il bisturi  
scalpel

la sega da traforo  
fretsaw

la sega per tenoni | tenon saw

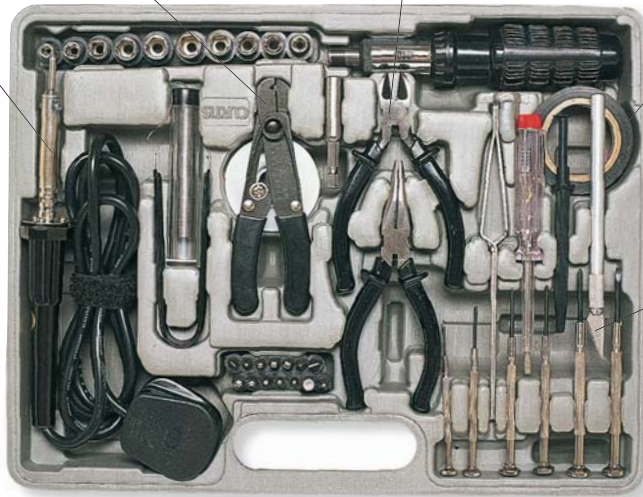

gli occhiali  
protettivi  
safety goggles



la pialla  
plane



il seghetto  
handsaw

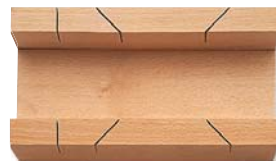

la cassetta guidalama  
per ugnature  
miter block



il seghetto per metalli  
hacksaw



il trapano  
manuale  
hand drill



la lana d'acciaio  
steel wool



la carta vetrata  
sandpaper

la chiave inglese  
wrench



lo scalpello  
chisel



l'affilatore  
whetstone

lo sturalavandini  
plunger



la lima  
file



il tagliatubi | pipe cutter



# la decorazione • decorating



**le forbici**  
scissors



**il coltello da pacchi**  
utility knife



**il filo a piombo**  
plumb line



**il raschietto**  
scraper

**il decoratore**  
decorator

**la carta da parati**  
wallpaper

**la scala a pioli**  
stepladder



**la spazzola**  
wallpaper brush

**il tavolo da lavoro**  
pasting table

**il pennello da colla**  
pasting brush

**la colla da parati**  
wallpaper paste

**il secchio**  
pail

**tappezzare** | wallpaper (v)



**staccare**  
strip (v)



**otturare**  
fill (v)



**scartavetrare**  
sand (v)



**intonacare** | plaster (v)



**incollare** | hang (v)



**piastrellare** | tile (v)



**dipingere**  
paint (v)

**il rullo**  
roller



**la vaschetta per la vernice**  
paint tray



**la vernice**  
paint

**il pennello**  
brush

**il barattolo di vernice**  
paint can



**la spugna**  
sponge



**il nastro adesivo coprente**  
masking tape



**la carta vetrata**  
sandpaper

**la tuta**  
overalls

**il telo di protezione**  
dust sheet



**lo stucco**  
filler

**la trementina**  
turpentine



**l'acquaragia**  
mineral spirits



**vocabolario** • vocabulary

**l'intonaco**  
plaster

**lucido**  
gloss

**la carta a rilievo**  
embossed paper

**la mano di fondo**  
undercoat

**il sigillante**  
sealant

**la vernice trasparente**  
varnish

**opaco**  
mat

**la carta di fondo**  
lining paper

**la mano finale**  
topcoat

**il solvente**  
solvent

**la pittura**  
latex paint

**lo stampino**  
stencil

**la vernice di base**  
primer

**il conservante**  
preservative

**la malta**  
grout

# il giardino • garden

## i tipi di giardino • garden styles



**il giardino a patio**  
patio garden



**il giardino all'italiana** | formal garden



**il giardino all'inglese**  
cottage garden



**il giardino di erbe**  
herb garden



**il giardino pensile**  
roof garden



**il giardino di pietra**  
rock garden



**il cortile**  
courtyard



**il giardino acquatico**  
water garden

## gli ornamenti per giardini • garden features



**il cesto sospeso**  
hanging basket



**il graticcio**  
trellis



**la pergola**  
pergola

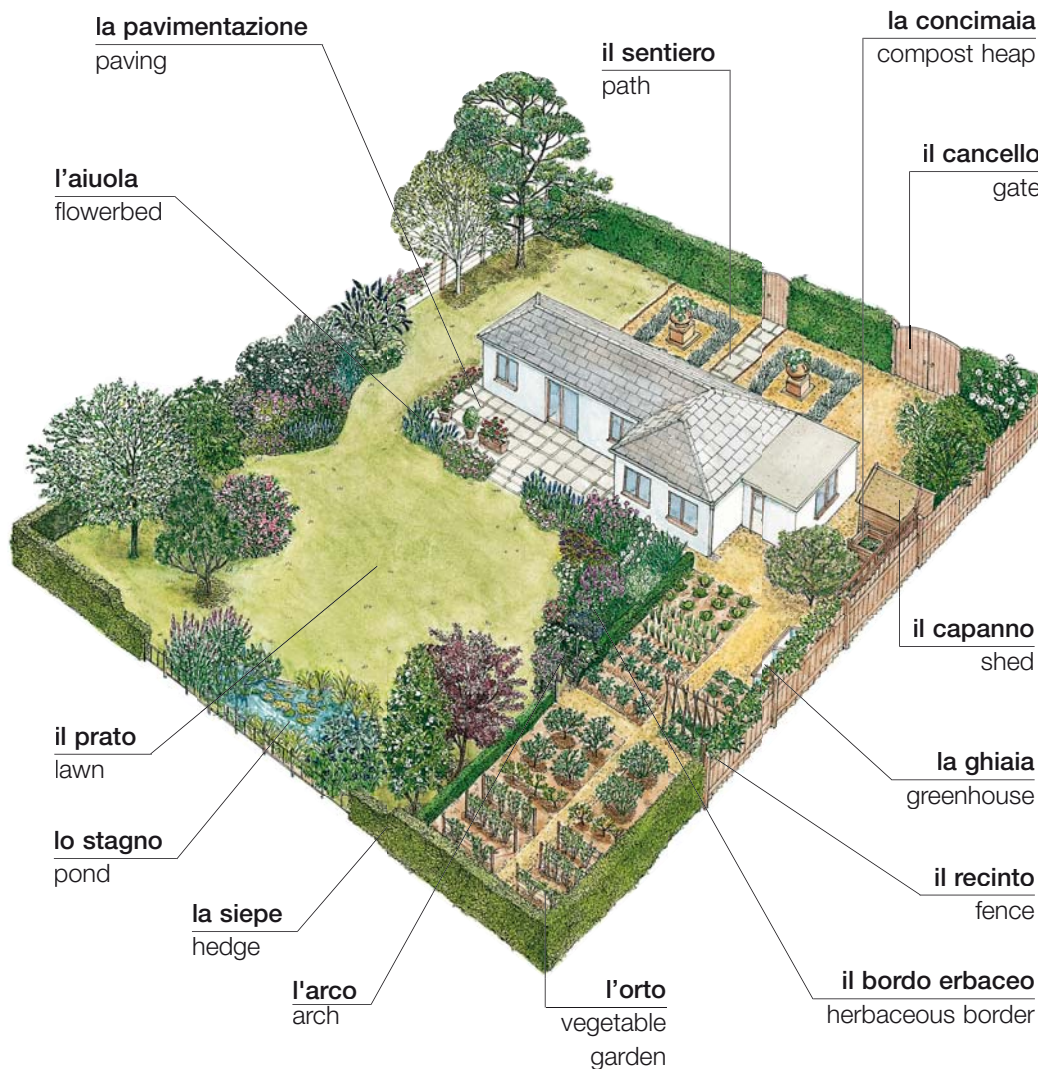

## il terreno • soil



**lo strato superficiale**  
topsoil



**la sabbia**  
sand



**il gesso**  
chalk



**il limo**  
silt



**l'argilla**  
clay



**il patio in legno**  
decking



**la fontana** | fountain

# le piante da giardino • garden plants

## i tipi di piante • types of plants

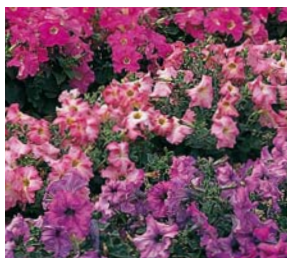

**annuale**  
annual



**biennale**  
biennial



**perenne**  
perennial



**il bulbo**  
bulb

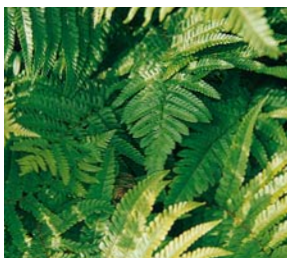

**la felce**  
fern



**il giunco**  
rush



**il bambù**  
bamboo



**le erbacce**  
weeds



**l'erba aromatica**  
herb



**la pianta acquatica**  
water plant



**l'albero**  
tree



**a foglie caduche**  
deciduous



**la palma**  
palm



**la conifera**  
conifer



**sempreverde**  
evergreen





**l'arte topiaria**  
topiary



**le piante da roccia**  
alpine



**la pianta grassa**  
succulent



**il cactus**  
cactus

**la pianta da vaso**  
potted plant

**la pianta d'ombra**  
shade plant

**la pianta rampicante**  
climber

**la pianta da fiore**  
flowering shrub

**la pianta copriterreno**  
ground cover



**la pianta rampicante**  
creeper

**ornamentale**  
ornamental

**l'erba**  
grass

# gli attrezzi da giardino • garden tools



**la vanga**  
spade



**il forcone**  
fork



**le forbici tagliabordi**  
long-handled shears



**la scopa di ferro**  
lawn rake



**il rastrello**  
rake



**la zappa**  
hoe



**il terriccio**  
compost



**i semi**  
seeds



**la farina di ossa**  
bone meal



**la ghiaia**  
gravel



**il raccoglierba**  
grass bag

**il motore**  
motor

**il manico**  
handle

**la protezione**  
shield

**il tagliabordi**  
trimmer

**il tosaerba**  
lawnmower



**il cestello**  
trug



**il sostegno**  
stand

**la carriola**  
wheelbarrow



**il forcone**  
hand fork



**la cesoia**  
pruners

**i guanti da giardinaggio**  
gardening gloves



**la paletta**  
trowel



**il semenzaio**  
seed tray

**il fil di ferro**  
twine

**le etichette**  
labels

**la lama**  
blade

**le fettucce**  
twist ties



**le forbici da giardino**  
shears



**il pesticida**  
pesticide



**le canne**  
canes

**gli anelli**  
ring ties



**la sega**  
hand saw



**il setaccio**  
sieve



**il vaso da fiori**  
plant pot



**le galosce**  
rubber boots

## l'annaffiatura • watering



**il diffusore**  
spray bottle



**l'irrigatore**  
sprinkler

**il becco**  
nozzle

**l'annaffiatoio**  
watering can

**la pompa da giardino**  
hose

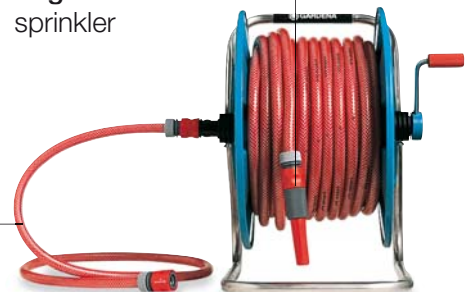

**l'avvolgitubo** | hose reel

**la rosa**  
rose

# il giardinaggio • gardening

**il prato**  
lawn

**l'aiuola**  
flowerbed

**il tosaerba**  
lawnmower



**la siepe**  
hedge

**il bastoncino**  
stake

**tagliare l'erba | mow (v)**

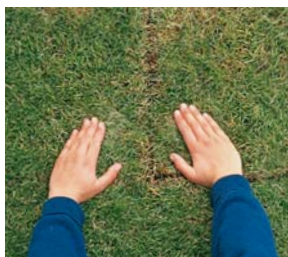

**ricoprire di  
zolle erbose**  
turf (v)



**inforcare**  
spike (v)



**rastrellare**  
rake (v)



**spuntare**  
trim (v)



**scavare**  
dig (v)



**seminare**  
sow (v)



**concimare a  
spandimento**  
topdress (v)



**annaffiare**  
water (v)



**far crescere**  
train (v)



**togliere i fiori appassiti**  
deadhead (v)

**spruzzare**  
spray (v)



**legare a un bastoncino**  
stake (v)



**innestare**  
graft (v)

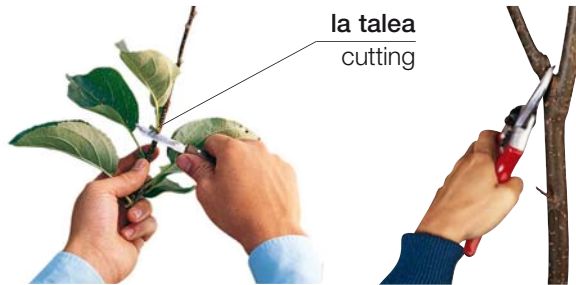

**propagare**  
propagate (v)

**potare**  
prune (v)



**trapiantare**  
transplant (v)



**sradicare le erbacce**  
weed (v)



**concimare**  
mulch (v)



**raccogliere**  
harvest (v)

**vocabolario • vocabulary**

<b>coltivare</b> cultivate (v)	<b>architettare</b> landscape (v)	<b>concimare</b> fertilize (v)	<b>setacciare</b> sift (v)	<b>biologico</b> organic	<b>il semenzale</b> seedling	<b>il sottosuolo</b> subsoil
<b>curare</b> tend (v)	<b>invasare</b> pot (v)	<b>cogliere</b> pick (v)	<b>aerare</b> aerate (v)	<b>lo scolo</b> drainage	<b>il concime</b> fertilizer	<b>il diserbante</b> weedkiller



2

JKL

5

TUV

7

8

SYMBA

0

A close-up, slightly blurred photograph of a person's face, showing a warm smile. The image is split horizontally by a white band. The top half shows the upper part of the face, including the eyes and forehead, while the bottom half shows the lower part, including the mouth and chin. The overall color palette is warm, with various shades of brown and beige.

**i servizi**  
services

# i servizi di emergenza • emergency services

## l'ambulanza • ambulance



**l'ambulanza**  
ambulance



**la barella**  
stretcher

**il paramedico**  
paramedic

## la polizia • police

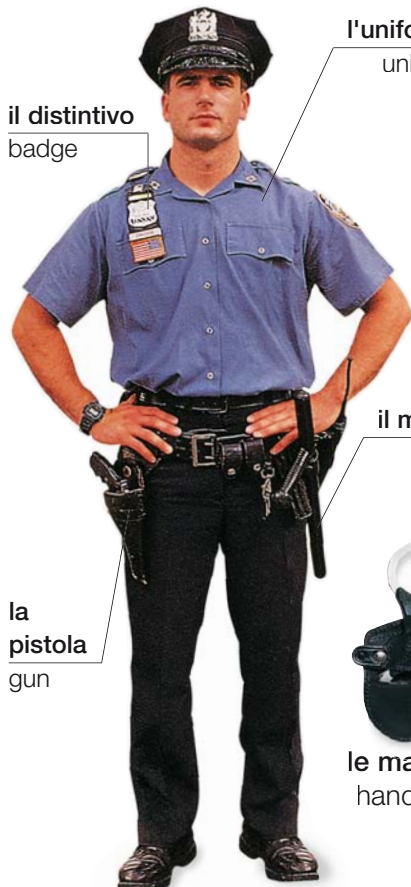

**il distintivo**  
badge

**l'uniforme**  
uniform

**la sirena**  
siren

**le luci**  
lights

**la pistola**  
gun

**il manganello**  
nightstick



**l'auto della polizia**  
police car



**la stazione di polizia**  
police station

**l'agente**  
police officer

### vocabolario • vocabulary

**il commissario**  
inspector

**il furto**  
burglary

**la denuncia**  
complaint

**l'arresto**  
arrest

**l'investigatore**  
detective

**l'aggressione**  
assault

**l'indagine**  
investigation

**la cella**  
cell

**il reato**  
crime

**l'impronta digitale**  
fingerprint

**il sospetto**  
suspect

**l'accusa**  
charge



i vigili del fuoco • fire department



l'incendio | fire

il fumo  
smoke

l'idrante  
hose

la gabbia  
basket

il getto  
d'acqua  
water jet

il braccio  
boom

la scala  
ladder

la cabina  
cab

il casco  
helmet

i vigili del fuoco  
firefighters



la caserma dei  
vigili del fuoco  
fire station



la scala di sicurezza  
fire escape



l'autopompa  
fire engine



l'allarme antifumo  
smoke alarm



l'allarme  
antincendio  
fire alarm



l'ascia  
ax



l'estintore  
fire extinguisher



l'idrante  
hydrant

Ho bisogno della polizia/dei  
vigili del fuoco/di un'ambulanza.  
I need the police/fire  
department/ambulance.

C'è un incendio a...  
There's a fire at...

C'è stato un incidente.  
There's been an  
accident.

Chiamate  
la polizia!  
Call the police!

# la banca • bank

il cliente  
customer

lo sportello  
window

il cassiere  
teller



i dépliant  
brochures

il banco  
counter

i moduli di versamento  
deposit slips



il direttore  
bank manager

la carta di debito  
debit card



la carta di credito  
credit card

la matrice  
stub

il numero di conto  
account number

la firma  
signature

l'importo  
amount



il libretto degli assegni  
checkbook

l'assegno  
check

## vocabolario • vocabulary

i risparmi  
savings

l'ipoteca  
mortgage

il pagamento  
payment

versare  
deposit (v)

il conto corrente  
checking account

l'imposta  
tax

lo scoperto  
overdraft

il prestito  
loan

il pin  
PIN

il conto di risparmio  
savings account

l'addebito diretto  
automatic payment

il tasso d'interesse  
interest rate

il modulo di prelievo  
withdrawal slip

la commissione bancaria  
bank charge

il bonifico bancario  
electronic transfer

la moneta

coin



la banconota

bill

il denaro

money

lo schermo

screen

la tastiera

key pad



la fessura

per la carta

card slot

la cassa automatica

ATM

la valuta estera • foreign currency



l'ufficio di cambio

bureau de change



il travel cheque

traveler's check



il tasso di cambio

exchange rate

vocabolario • vocabulary

incassare

cash (v)

le azioni

shares

la denominazione

denomination

i dividendi

dividends

la commissione

commission

il contabile

accountant

l'investimento

investment

il portafoglio

portfolio

i titoli

stocks

il capitale netto

equity

Posso cambiare questo?

Can I change this, please?

Qual è il tasso di cambio oggi?

What's today's exchange rate?

la finanza • finance

il corso per azione

share price

il broker

stockbroker



la consulente  
finanziaria

financial advisor



la borsa valori | stock exchange

# le comunicazioni • communications

**l'impiegato  
delle poste**  
postal worker

**lo sportello**  
window

**la bilancia**  
scale

**il banco**  
counter



**l'ufficio postale** | post office



**il postino**  
mail carrier

**il timbro postale**  
postmark

**il francobollo**  
stamp

**l'indirizzo**  
address

**il codice di  
avviamento postale**  
ZIP code



**la busta** | envelope

## vocabolario • vocabulary

**la lettera**  
letter

**il mittente**  
return address

**la consegna**  
delivery

**fragile**  
fragile

**non piegare**  
do not bend (v)

**posta aerea**  
by airmail

**la firma**  
signature

**l'affrancatura**  
postage

**il sacco postale**  
mailbag

**alto**  
this way up

**la posta  
raccomandata**  
registered mail

**la raccolta**  
pickup

**il vaglia postale**  
money order

**il telegramma**  
telegram

**il fax**  
fax



**la buca delle lettere**  
mailbox



**la cassetta delle lettere**  
letter slot



**il pacco**  
package



**il corriere**  
courier

## il telefono • telephone

**il ricevitore**  
handset



**la segreteria telefonica**  
answering machine



**il videotelefono**  
video phone



**la cabina telefonica**  
telephone booth

**la base**  
base station

**il telefono senza fili**  
cordless phone



**la tastiera**  
keypad

**il ricevitore**  
receiver



**il telefono a monete**  
coin phone



**il telefono a scheda**  
card phone

**le monete non utilizzate**  
coin return

**il telefonino**  
cell phone

## vocabolario • vocabulary

**comporre**  
dial (v)

**rispondere**  
answer (v)

**l'operatore**  
operator

**Può darmi il numero per...?**  
Can you give me the number for...?

**staccato**  
disconnected

**il messaggio vocale**  
voice message

**occupato**  
busy

**Qual è il prefisso per...?**  
What is the area code for...?

**la chiamata a carico del destinatario**  
collect call

**il messaggio di testo**  
text message

**le informazioni telefoniche**  
directory assistance

# l'albergo • hotel

## l'ingresso • lobby



**l'ospite**  
guest

**la chiave della camera**  
room key

**i messaggi**  
messages

**la casella**  
pigeonhole

**l'addetta  
alla ricezione**  
receptionist

**il registro**  
register

**il banco**  
counter

**la ricezione** | reception



**il bagaglio**  
luggage

**il carrello**  
cart

**il facchino**  
porter



**l'ascensore**  
elevator



**il numero della camera**  
room number

## le camere • rooms



**la camera singola**  
single room



**la camera doppia**  
double room



**la camera a due letti**  
twin room



**il bagno privato**  
private bathroom

i servizi • services



**il servizio di pulizia**  
maid service



**il servizio di lavanderia**  
laundry service



**il servizio in camera** | room service



**il minibar**  
mini bar



**il ristorante**  
restaurant



**la palestra**  
gym

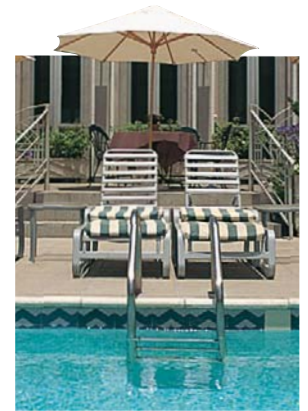

**la piscina**  
swimming pool

**vocabolario** • vocabulary

**la pensione completa**  
full board

**Avete una camera libera?**  
Do you have any vacancies?

**Vorrei una camera per tre notti.**  
I'd like a room for three nights.

**la mezza pensione**  
half-board

**Ho una prenotazione**  
I have a reservation.

**Quanto costa la camera a notte?**  
What is the charge per night?

**la pensione con colazione**  
bed and breakfast

**Vorrei una camera singola**  
I'd like a single room.

**Quando devo lasciare la stanza?**  
When do I have to check out?







gli acquisti  
shopping

# il centro commerciale • shopping center

**l'atrio**  
atrium

**l'insegna**  
sign

**l'ascensore**  
elevator



**il secondo piano**  
third floor

**il primo piano**  
second floor

**la scala mobile**  
escalator

**il piano terra**  
ground floor

**il cliente**  
customer

## vocabolario • vocabulary

**il reparto bambini**  
children's department

**il commesso**  
store clerk

**i camerini**  
changing rooms

**Quanto costa questo?**  
How much is this?

**il reparto bagagli**  
luggage department

**la guida al negozio**  
store directory

**le toilettes**  
restrooms

**Posso cambiare questo?**  
May I exchange this?

**il reparto calzature**  
shoe department

**l'assistenza ai clienti**  
customer services

**la stanza di cambio pannolini**  
baby-changing facilities

il grande magazzino • department store



**l'abbigliamento da uomo**  
menwear



**l'abbigliamento da donna**  
women's clothing



**la biancheria intima**  
lingerie



**la profumeria**  
perfume



**la bellezza**  
beauty



**la biancheria**  
linen



**l'arredamento per la casa**  
home furnishings



**la merceria**  
notions



**gli articoli da cucina**  
kitchenware



**la porcellana**  
china



**gli articoli elettronici**  
electrical goods



**l'illuminazione**  
lighting



**gli articoli sportivi**  
sports



**i giocattoli**  
toys



**la cancelleria**  
stationery



**il reparto alimentari**  
food

# il supermercato • supermarket

la corsia  
aisle

lo scaffale  
shelf

il nastro convogliatore  
conveyor belt

il cassiere  
checker

le offerte  
specials



la cassa | checkout

il cliente  
customer

la cassa  
cash  
register

la busta della spesa  
shopping bag



il carrello  
cart

la spesa  
groceries

il manico  
handle



il cestino  
basket



il codice a barre  
bar code



il lettore ottico  
scanner



**la panetteria**  
bakery



**i latticini**  
dairy



**i cereali da colazione**  
breakfast cereals



**lo scatolame**  
canned food



**i dolci**  
confectionery



**le verdure**  
vegetables



**la frutta**  
fruit

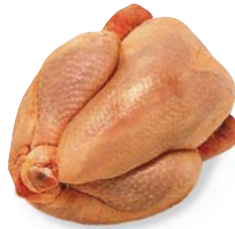

**la carne e il pollame**  
meat and poultry

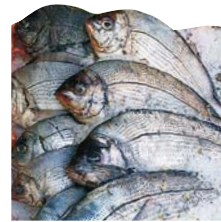

**il pesce**  
fish



**la salumeria**  
deli



**i surgelati**  
frozen food



**i cibi cotti**  
convenience food



**le bibite**  
drinks



**i casalinghi**  
household products



**i prodotti per il bagno**  
toiletries



**i prodotti per bambini**  
baby products



**gli elettrodomestici**  
electrical goods



**il cibo per animali**  
pet food



**le riviste | magazines**

# la farmacia • pharmacy

**i prodotti per i denti**  
dental care

**l'igiene femminile**  
feminine hygiene

**i deodoranti**  
deodorants

**le vitamine**  
vitamins

**il dispensario**  
pharmacy

**il farmacista**  
pharmacist

**la medicina per la tosse**  
cough medicine

**i rimedi alle erbe**  
herbal remedies

**i prodotti per la pelle**  
skin care



**il doposole**  
aftersun

**la crema schermo**  
sunscreen



**la crema schermo totale**  
sunblock



**l'insetticigo**  
insect repellent



**la salvietta umidificata**  
wet wipe



**il fazzolettino**  
tissue



**l'assorbente**  
sanitary napkin



**il tampone**  
tampon



**il salvaslip**  
panty liner



**la pasticca**  
capsule



**la pillola**  
pill

**il cucchiaino  
misuratore**  
measuring spoon



**lo sciroppo**  
syrup

**le istruzioni**  
instructions



**l'inalatore**  
inhaler



**la crema**  
cream



**l'unguento**  
ointment



**il gel**  
gel



**la supposta**  
suppository



**le gocce**  
drops

**il contagocce**  
dropper



**la siringa**  
syringe

**l'ago**  
needle



**lo spray**  
spray



**la polvere**  
powder

**vocabolario** • vocabulary

**il ferro**  
iron

**la multivitamina**  
multivitamins

**monouso**  
disposable

**la medicina**  
medicine

**l'antidolorifico**  
painkiller

**il calcio**  
calcium

**gli effetti collaterali**  
side-effects

**solubile**  
soluble

**il lassativo**  
laxative

**il sedativo**  
sedative

**il magnesio**  
magnesium

**la data di scadenza**  
expiration date

**il dosaggio**  
dosage

**la diarrea**  
diarrhea

**il sonnifero**  
sleeping pill

**l'insulina**  
insulin

**le pasticche  
antinausea**  
travel-sickness pills

**il medicamento**  
medication

**la pasticca per  
la gola**  
cough drop

**l'antinfiammatorio**  
anti-inflammatory

# il fioraio • florist

**i fiori**  
flowers

**il giglio**  
lily

**l'acacia**  
acacia

**il garofano**  
carnation

**la pianta  
da vaso**  
potted plant



**il gladiolo**  
gladiolus

**l'iris**  
iris

**la margherita**  
daisy

**il crisantemo**  
chrysanthemum

**la gipsofila**  
gypsophila



**la violacciocca**  
stocks



**la gerbera**  
gerbera



**il fogliame**  
foliage



**la rosa**  
rose



**la fnesia**  
freesia



gli arrangiamenti • arrangements

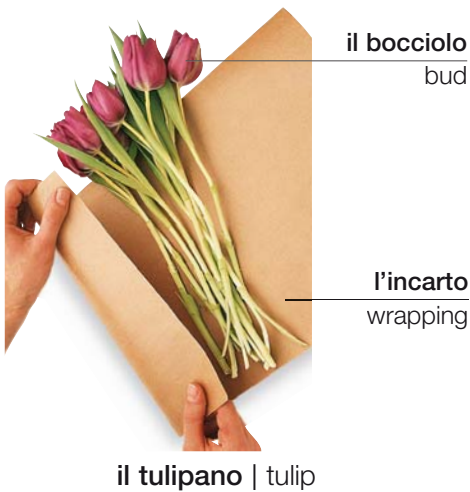
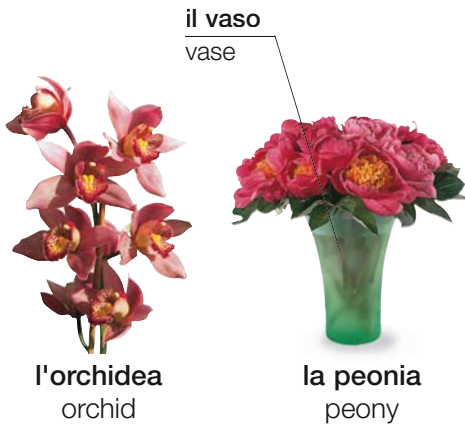

**Mi dà un mazzo di...  
per favore?**

Can I have a bunch of...  
please.

**Me li può incartare?**

Can I have them wrapped?

**Posso allegare un  
messaggio?**

Can I attach a message?

**Quanto dureranno?**

How long will these last?

**Sono profumati?**

Are they fragrant?

**Li può mandare a...?**

Can you send them to....?

# l'edicola • newsstand



le sigarette  
cigarettes

il pacchetto di sigarette  
pack of cigarettes

i fiammiferi  
matches

i biglietti della lotteria  
lottery tickets

i francobolli  
stamps



la cartolina  
postcard



il giornalino a fumetti  
comic



la rivista  
magazine



il giornale  
newspaper

## fumare • smoking



il tabacco  
tobacco



l'accendino  
lighter



il fornello  
bowl

la cannuccia  
stem

la pipa  
pipe



il sigaro  
cigar

## il confettiere • confectionery

la scatola di  
cioccolatini  
box of chocolates

la tavoletta  
spuntino  
snack bar

le patatine  
chips



il negozio di dolci | candy store

### vocabolario • vocabulary

il caramello  
caramel

il biscotto  
cookie

il tartufo  
truffle

le caramelle  
hard candy

il cioccolato  
al latte  
milk chocolate

il cioccolato  
bianco  
white chocolate

il cioccolato  
amaro  
semisweet  
chocolate

la caramelle  
assortite  
pick-and-mix

## i dolci • confectionery



il cioccolatino  
chocolate



la tavoletta di  
cioccolata  
chocolate bar



le caramelle  
candy



la lecca lecca  
lollipop



la caramella mou  
toffee



il torrone  
nougat



la caramella  
gommosa  
marshmallow



la mentina  
mint



la gomma  
da masticare  
chewing gum



la caramella  
di gelatina  
jellybean



la caramella  
alla frutta  
gumdrop



la liquirizia  
licorice

## gli altri negozi • other stores



**il panificio**  
bread shop



**la pasticceria**  
bakery



**la macelleria**  
butcher shop



**la pescheria**  
fish counter



**il fruttivendolo**  
produce stand



**la drogheria**  
grocery store



**il negozio di calzature**  
shoe store



**il negozio di ferramenta**  
hardware store



**il negozio di antiquariato**  
antique shop



**il negozio di articoli da regalo**  
gift shop



**l'agenzia di viaggi**  
travel agency



**la gioielleria**  
jewelry store



**la libreria**  
bookstore



**il negozio di dischi**  
record store



**il negozio di liquori**  
liquor store



**il negozio di animali**  
pet store



**il negozio di mobili**  
furniture store



**la boutique**  
boutique



**la sartoria**  
tailor shop



**il parrucchiere**  
beauty salon

**vocabolario** • vocabulary

<b>l'agenzia immobiliare</b> real estate office	<b>il negozio di articoli fotografici</b> camera store
<b>il vivaio</b> garden center	<b>la lavanderia</b> laundromat
<b>il lavasecco</b> dry-cleaner	<b>il negozio di alimenti biologici</b> health-food store
<b>il negozio dell'usato</b> second-hand store	<b>il negozio di articoli per l'arte</b> art store



**il mercato** | market





**il cibo**  
food

# la carne • meat



## vocabolario • vocabulary

**il maiale**  
pork

**il cervo**  
venison

**le frattaglie**  
offal

**ruspante**  
free-range

**la carne rossa**  
red meat

**il manzo**  
beef

**il coniglio**  
rabbit

**trattato**  
cured

**biologico**  
organic

**la carne magra**  
lean meat

**il vitello**  
veal

**la lingua**  
tongue

**affumicato**  
smoked

**la carne bianca**  
white meat

**la carne cotta**  
cooked meat



**i tagli • cuts**

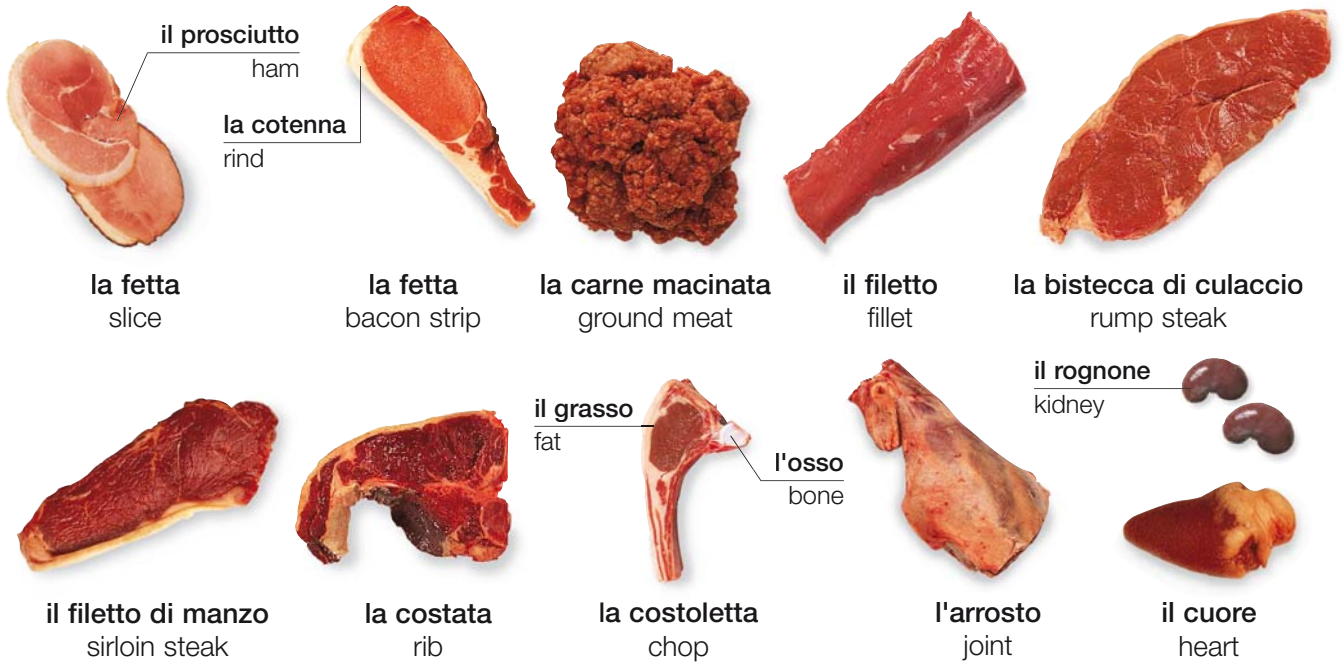

**il pollo • poultry**

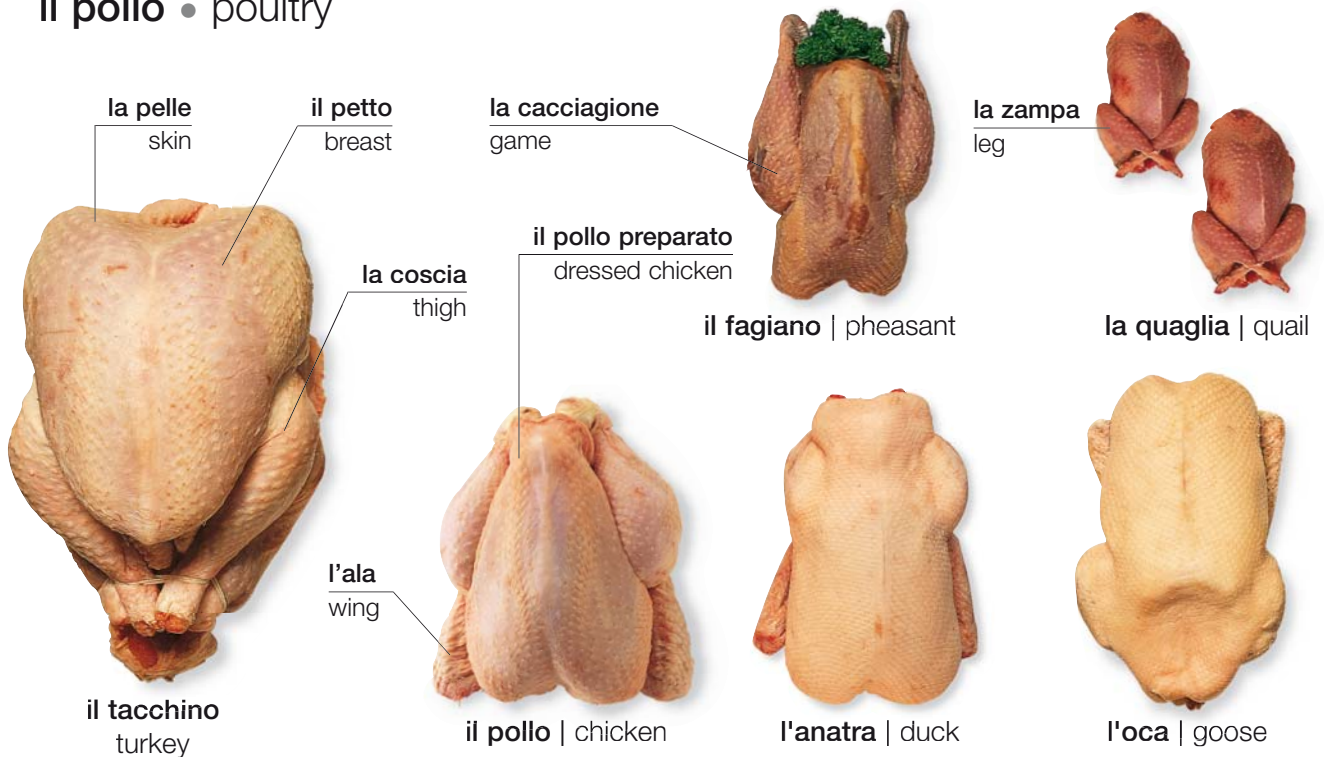

# il pesce • fish

**i gamberi  
sgusciati**  
peeled shrimp

**il ghiaccio**  
ice

**la triglia**  
red mullet

**i filetti di  
ippoglosso**  
halibut fillets

**la trota**  
rainbow trout

**le pinne  
di razza**  
skate wings



**la pescheria**  
fish counter



**la rana pescatrice**  
monkfish



**lo sgombro**  
mackerel



**la trota**  
trout



**il pesce spada**  
swordfish



**la sogliola**  
Dover sole



**la sogliola limanda**  
lemon sole



**l'eglefino**  
haddock



**la sardina**  
sardine



**la razza**  
skate



**il merlango**  
whiting



**la spigola**  
sea bass



**il salmone** | salmon



**il merluzzo**  
cod



**l'abramide**  
sea bream



**il tonno**  
tuna

**i frutti di mare • seafood**

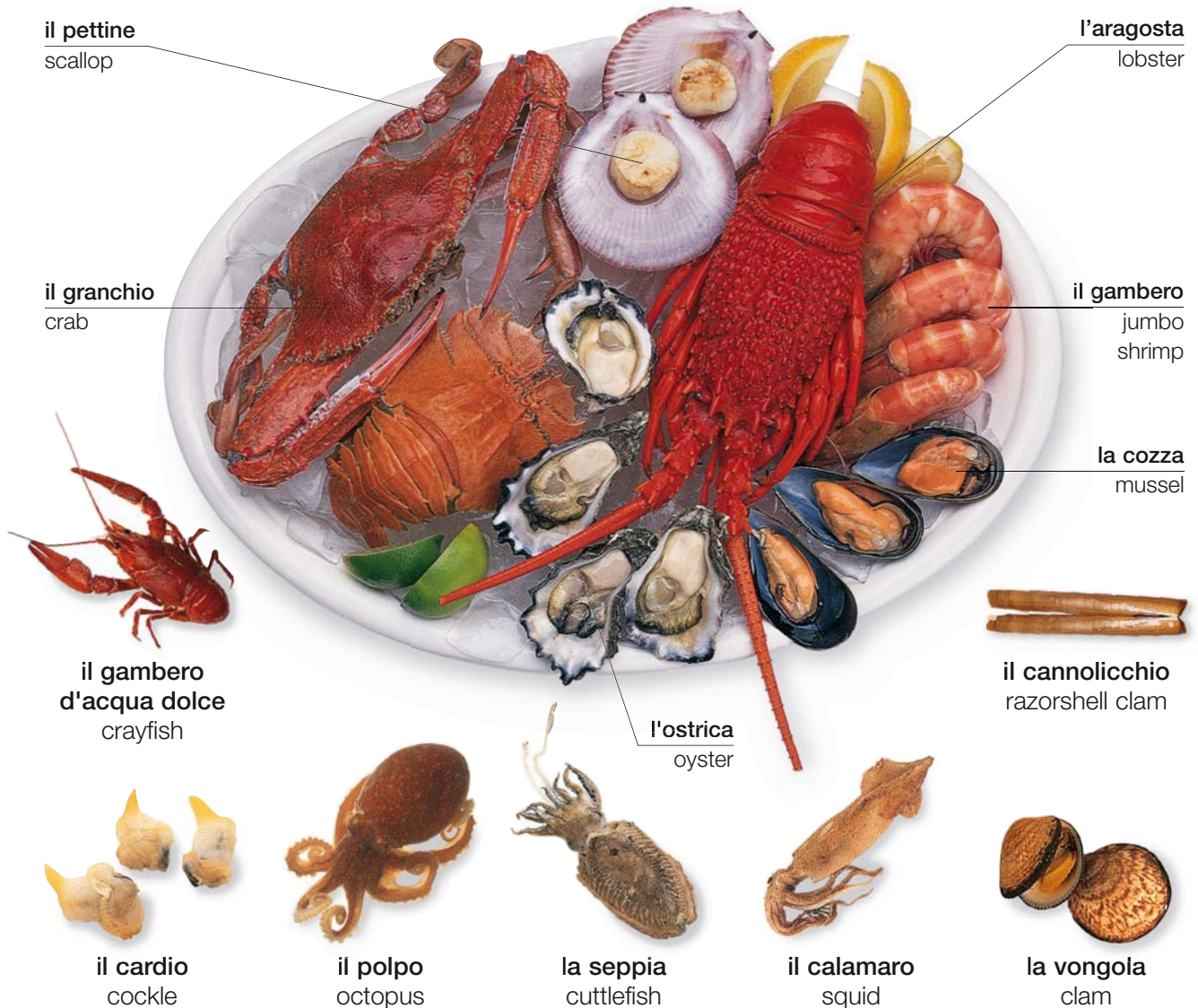

**vocabolario • vocabulary**

<b>congelato</b> frozen	<b>pulito</b> cleaned	<b>affumicato</b> smoked	<b>desquamato</b> descaled	<b>a filetti</b> filleted	<b>il lombo</b> loin	<b>la coda</b> tail	<b>la spina</b> bone	<b>la squama</b> scale
<b>fresco</b> fresh	<b>salato</b> salted	<b>spellato</b> skinned	<b>spinato</b> boned	<b>il filetto</b> fillet	<b>la trancia</b> steak	<b>Me lo pulisce?</b> Will you clean it for me?		

# la verdura 1 • vegetables 1

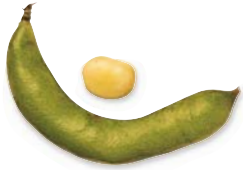

**la fava**  
fava bean



**il fagiolino**  
green bean



**il fagiolino**  
French bean



**il pisello**  
garden pea



**il granturco**  
corn



**il germoglio  
di soia**  
bean sprout



**il bambù**  
bamboo

**il baccello**  
pod



**l'okra**  
okra



**il sedano**  
celery



**la cicoria**  
chicory



**il finocchio**  
fennel



**i cuori di palma**  
palm hearts

## vocabolario • vocabulary

**la foglia**  
leaf

**il germoglio**  
foret

**la punta**  
tip

**biologico**  
organic

**Vendete verdure biologiche?**  
Do you sell organic vegetables?

**lo stelo**  
stalk

**il nocciolo**  
kernel

**il cuore**  
heart

**la busta di plastica**  
plastic bag

**Queste sono della zona?**  
Are these grown locally?



**la rucola**  
arugula



**il crescione**  
watercress



**il radicchio**  
radicchio



**il cavolino di Bruxelles**  
Brussels sprout



**la bietola**  
Swiss chard



**il cavolo verde**  
kale



**l'acetosa**  
sorrel



**l'indivia**  
endive



**il dente di leone**  
dandelion



**gli spinaci**  
spinach



**il cavolo rapa**  
kohlrabi



**la bieta**  
pak-choi



**la lattuga**  
lettuce



**il broccolo**  
broccoli



**il cavolo**  
cabbage



**la verza**  
spring greens

# le verdure 2 • vegetables 2

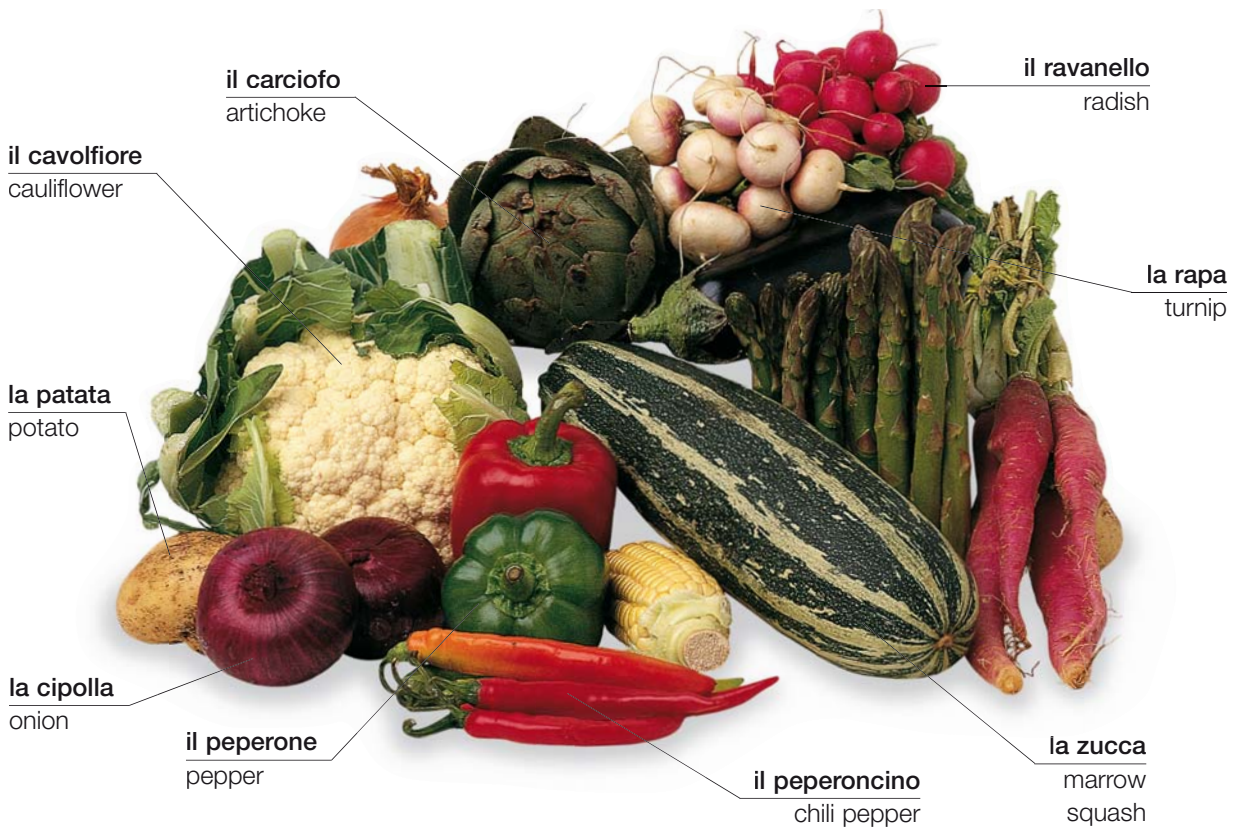

## vocabolario • vocabulary

**il pomodorino**  
cherry tomato

**il sedano rapa**  
celeriac

**congelato**  
frozen

**amaro**  
bitter

**Mi dà un chilo di patate per favore?**

Can I have one kilo of potatoes, please?

**la carota**  
carrot

**la cassava**  
cassava

**crudo**  
raw

**sodo**  
firm

**Quanto costa al chilo?**

What's the price per kilo?

**la patata novella**  
new potato

**la radice di taro**  
taro root

**piccante**  
hot (spicy)

**la polpa**  
flesh

**Quelli come si chiamano?**

What are those called?

**il frutto dell'albero del pane**  
breadfruit

**la castagna d'acqua**  
water chestnut

**dolce**  
sweet

**la radice**  
root



**la patata dolce**  
sweet potato



**l'igname**  
yam



**la barbabietola**  
beet



**la rapa svedese**  
rutabaga



**il topinambur**  
Jerusalem  
artichoke



**il rafano**  
horseradish



**la pastinaca**  
parsnip



**lo zenzero**  
ginger



**la melanzana**  
eggplant



**il pomodoro**  
tomato



**la cipollina**  
green onion

**il porro**  
leek



**lo scalogno**  
shallot



**l'aglio**  
garlic

**lo spicchio**  
clove



**il tartufo**  
truffle

**il fungo**  
mushroom

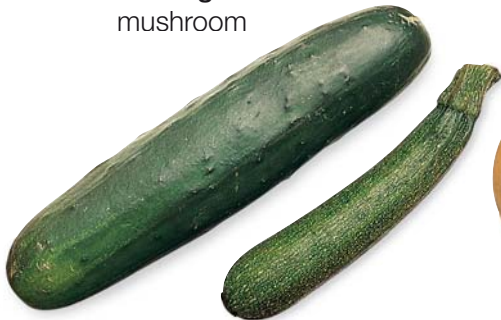

**il cetriolo**  
cucumber

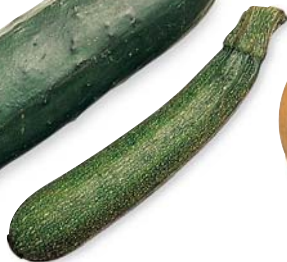

**la zucchini**  
zucchini



**la zucca**  
butternut squash



**la zucca a ghianda**  
acorn squash



**la zucca**  
pumpkin

# la frutta 1 • fruit 1

gli agrumi • citrus fruit



**l'arancio**  
orange



**la clementina**  
clementine

la scorza  
interna  
pith



**il mapo**  
ugli fruit

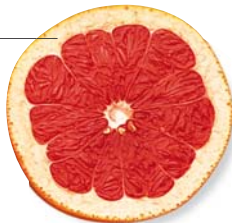

**il pompelmo**  
grapefruit

lo spicchio  
segment



**il satsuma**  
satsuma



**il mandarino**  
tangerine



la buccia  
zest

**la limetta**  
lime



**il limone**  
lemon



**l'arancino cinese**  
kumquat

# les fruits à noyau • stone fruit



**la pesca**  
peach



**la pesca noce**  
nectarine



**l'albicocca**  
apricot



**la prugna**  
plum



**la ciliegia**  
cherry

la pera  
pear

la mela  
apple



**il cestino di frutta** | basket of fruit



i frutti di bosco e i meloni • berries and melons



la fragola  
strawberry



il lampone  
raspberry



il melone  
melon



l'uva  
grapes



la mora  
blackberry



il ribes rosso  
red currant



il ribes nero  
black currant



l'ossicocco  
cranberry

la buccia  
rind



il mirtillo  
blueberry



il ribes bianco  
white currant

il seme  
seed

la polpa  
flesh

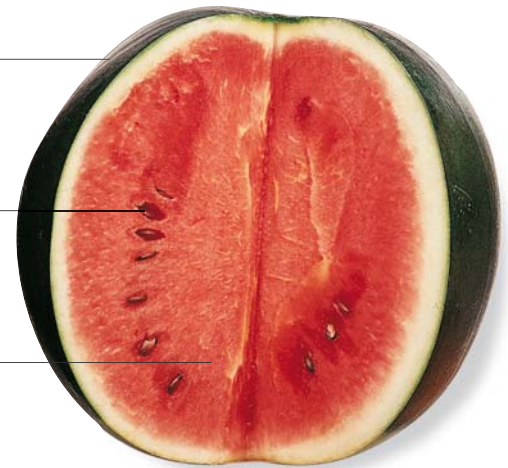

l'anguria  
watermelon



la mora-lampone  
loganberry



l'uva spina  
gooseberry

vocabolario • vocabulary

il rabarbaro amaro croccante senza semi  
rhubarb sour crisp seedless

la fibra fresco marcio il succo  
fiber fresh rotten juice

dolce sugoso la polpa il torsolo  
sweet juicy pulp core

Sono maturi?  
Are they ripe?

Posso assaggiarne uno?  
Can I try one?

Per quanto tempo si mantengono?  
How long will they keep?

# la frutta 2 • fruit 2

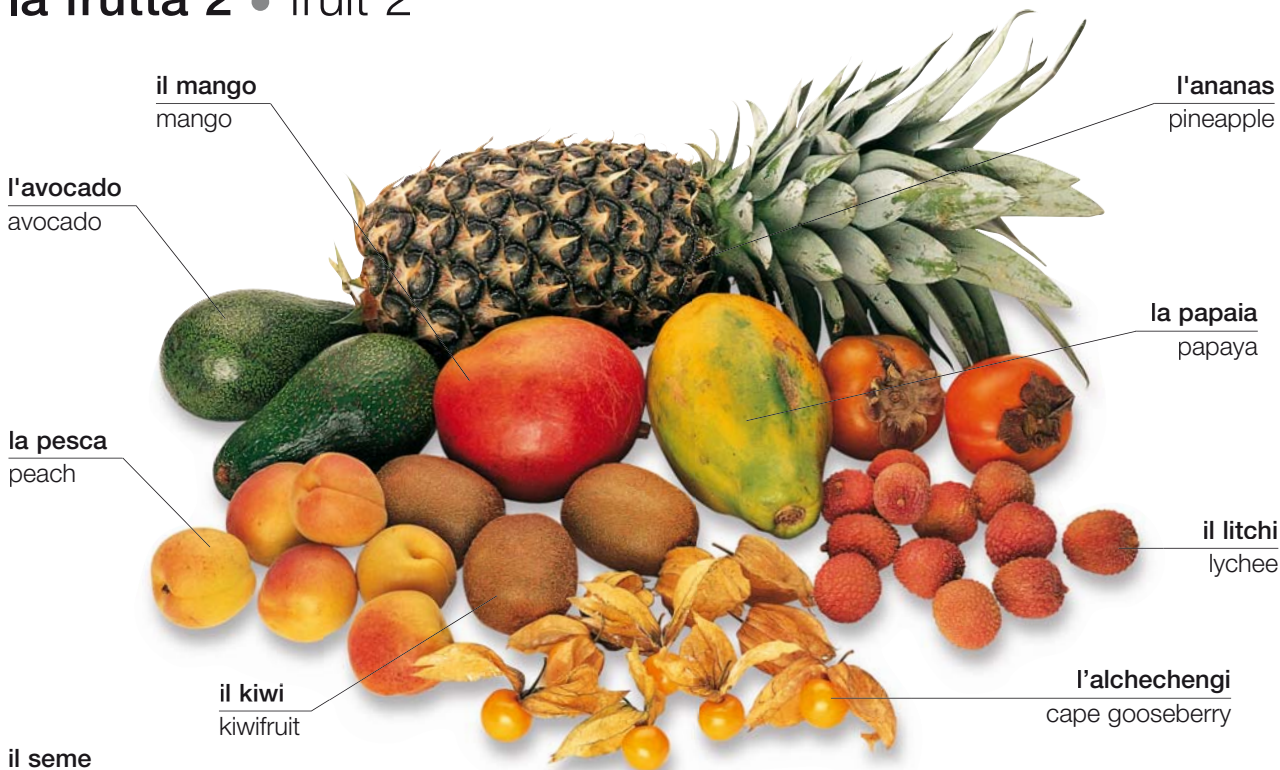

**il seme**  
seed



**la mela cotogna**  
quince



**il frutto della passione**  
passion fruit

**la buccia**  
skin



**la banana**  
banana



**la guaiava**  
guava



**il melograno**  
pomegranate



**il cachi**  
persimmon



**il feijoa**  
feijoa



**il fico d'india**  
prickly pear



**la carambola**  
starfruit



**la mangostina**  
mangosteen

le noci e la frutta secca • nuts and dried fruit



il pinolo  
pine nut



il pistacchio  
pistachio



l'anacardio  
cashew



l'arachide  
peanut



la nocciola  
hazelnut



la mandorla  
brasiliana  
Brazil nut



il pecan  
pecan



la mandorla  
almond



la noce  
walnut



la castagna  
chestnut



la macadamia  
macadamia



il fico  
fig



il dattero  
date



la prugna secca  
prune

il guscio  
shell



l'uva sultanina  
sultana raisin



l'uvetta  
raisin



l'uva passa  
currant

la polpa  
flesh

la noce di cocco  
coconut



vocabolario • vocabulary

verde  
green

duro  
hard

il nocciolo  
kernel

salato  
salted

arrostito  
roasted

la frutta tropicale  
tropical fruit

sgusciato  
shelled

maturo  
ripe

morbido  
soft

essiccato  
desiccated

crudo  
raw

stagionale  
seasonal

la frutta candita  
candied fruit

intero  
whole

# le granaglie e i legumi secchi • grains and legumes

## le granaglie • grains



**il grano**  
wheat



**l'avena**  
oats



**l'orzo**  
barley



**il miglio**  
millet



**il mais**  
corn



**la quinoa**  
quinoa

### vocabolario • vocabulary

**il seme** fresco **cottura facile**  
seed fresh easy-cook

**la pula** profumato **integrale**  
husk fragranced whole-grain

**il seme** il cereale **a chicco lungo**  
kernel cereal long-grain

**secco** mettere a **a chicco corto**  
dry bagno soak (v) short-grain

## il riso • rice



**il riso bianco**  
white rice



**il riso integrale**  
brown rice



**il riso selvatico**  
wild rice



**il riso da budino**  
pudding rice

## i cereali trattati • processed grains



**il cuscus**  
couscous



**il grano spezzato**  
cracked wheat



**la semola**  
semolina



**la crusca**  
bran

**i fagioli e i piselli • beans and peas**



**i fagioli cannellini**  
butter beans



**i fagioli bianchi**  
haricot beans



**i fagioli di Spagna**  
red kidney beans



**i fagioli aduki**  
aduki beans



**le fave**  
fava beans



**i semi di soia**  
soybeans



**i fagioli dall'occhio nero**  
black-eyed beans



**i fagioli borlotti**  
pinto beans



**i fagioli mung**  
mung beans



**i fagioli nani**  
flageolet beans



**le lenticchie marroni**  
brown lentils



**le lenticchie rosse**  
red lentils



**i piselli**  
green peas



**i ceci**  
garbanzos



**i piselli spaccati**  
split peas

**i semi • seeds**



**il seme di zucca**  
pumpkin seed



**il seme di mostarda**  
mustard seed



**il seme di carvi**  
caraway



**il seme di sesamo**  
sesame seed

**il seme di girasole**  
sunflower seed



# le erbe aromatiche e le spezie • herbs and spices

## le spezie • spices



**la vaniglia**  
vanilla



**la noce moscata**  
nutmeg



**il macis**  
mace



**la curcuma**  
turmeric



**il cumino**  
cumin



**il mazzetto  
odoroso**  
bouquet garni



**il pepe della  
Giamaica**  
allspice



**il grano di pepe**  
peppercorn



**il fieno greco**  
fenugreek



**il peperoncino  
rosso**  
chili powder

intero  
whole

tritato  
crushed



**lo zafferano**  
saffron



**il cardamomo**  
cardamom



**la polvere di  
curry**  
curry powder



macinato  
ground



**la paprica**  
paprika

a scaglie  
flakes



**l'aglio**  
garlic

le erbe aromatiche • herbs

**i bastoncini**  
sticks



**la cannella**  
cinnamon



**la citronella**  
lemon grass



**i chiodi di garofano**  
cloves



**l'anice stellato**  
star anise



**lo zenzero**  
ginger



**il finocchio**  
fennel

**i semi di finocchio**  
fennel seeds



**l'erba cipollina**  
chives



**la menta**  
mint



**il dragoncello**  
tarragon



**la maggiorana**  
marjoram



**l'origano**  
oregano



**il coriandolo**  
cilantro



**l'alloro**  
bay leaf



**il timo**  
thyme



**il basilico**  
basil



**l'aneto**  
dill



**il prezzemolo**  
parsley



**la salvia**  
sage



**il rosmarino**  
rosemary

## i cibi imbottigliati • bottled foods



## le confetture • sweet spreads





**condimenti e cibi da spalmare •**  
condiments and spreads



**la maionese**  
mayonnaise



**il chutney**  
chutney



**l'aceto di malto**  
malt vinegar



**l'aceto balsamico**  
balsamic vinegar



**l'aceto di vino**  
wine vinegar

**l'aceto**  
vinegar

**la bottiglia**  
bottle



**il ketchup**  
ketchup



**la salsa**  
sauce



**la senape**  
English mustard



**la mostarda**  
French mustard



**la mostarda con semi**  
whole-grain mustard

**il barattolo a chiusura ermetica**  
sealed jar



**il burro di arachidi**  
peanut butter



**la cioccolata spalmabile**  
chocolate spread



**la conserva di frutta**  
preserved fruit

**vocabolario • vocabulary**

**l'olio vegetale**  
vegetable oil

**l'olio di colza**  
canola oil

**l'olio di mais**  
corn oil

**l'olio spremuto a freddo**  
cold-pressed oil

**l'olio di arachide**  
peanut oil

# i latticini • dairy produce

## il formaggio • cheese

la crosta  
rind

il formaggio  
semiduro  
semi-hard cheese

il formaggio  
grattugiato  
grated cheese



il formaggio duro  
hard cheese

il formaggio  
semimorbido  
semi-soft cheese

il formaggio  
molle fresco  
cottage cheese

il formaggio  
tipo gorgonzola  
blue cheese

il formaggio morbido  
soft cheese

il formaggio  
cremoso  
cream cheese



il formaggio fresco | fresh cheese

## il latte • milk

il latte  
intero  
whole milk

il latte parzialmente  
scremato  
reduced-fat milk

il latte scremato  
skim milk



il cartone di latte  
milk carton



il latte di  
capra  
goat's milk



il latte  
condensato  
condensed milk

il latte di mucca | cow's milk



**il burro**  
butter



**la margarina**  
margarine



**la panna**  
cream



**la panna liquida**  
light cream



**la panna densa**  
heavy cream



**la panna montata**  
whipped cream



**la panna acida**  
sour cream



**lo yogurt**  
yogurt



**il gelato**  
ice cream

## le uova • eggs



## vocabolario • vocabulary

**pastorizzato**  
pasteurized

**senza grassi**  
fat-free

**salato**  
salted

**il siero di latte**  
buttermilk

**il lattosio**  
lactose

**il frullato**  
milkshake

**non pastorizzato**  
unpasteurized

**il latte in polvere**  
powdered milk

**senza sale**  
unsalted

**il latte di pecora**  
sheep's milk

**omogeneizzato**  
homogenized

**lo yogurt gelato**  
frozen yogurt

# il pane e le farine • breads and flours

il pane affettato  
sliced bread

i semi di papavero  
poppy seeds

il pane di segale  
rye bread

il filone  
baguette



il panificio | bakery

## fare il pane • making bread



la farina bianca  
white flour



la farina integrale  
brown flour



la farina integrale  
whole-wheat flour



il lievito  
yeast



setacciare | sift (v)



mescolare | mix (v)

la pasta  
dough



impastare | knead (v)



cuocere al forno | bake (v)



la crosta  
crust

il pane bianco  
white bread



il filone  
loaf

il pane nero  
brown bread



il pane integrale  
whole-wheat bread

la fetta  
slice



il pane di granaio  
multigrain bread



il pane di mais  
cornbread



il pane lievitato con  
bicarbonato di sodio  
soda bread



il pane aspro  
sourdough bread



la schiacciata  
flatbread



la ciambella  
bagel



il panino  
bun



il filoncino  
roll



il pane alla frutta  
fruit bread



il pane con semi  
seeded bread



il naan  
naan bread



la pita  
pita bread



i crackers  
crispbread

**vocabolario** • vocabulary

la farina autolievitante  
self-rising flour

la farina semplice  
all-purpose flour

lievitare  
prove (v)

le briciole  
breadcrumbs

l'affettatrice  
slicer

la farina per il pane  
bread flour

crescere  
rise (v)

glassare  
glaze (v)

il filoncino  
flute

il panettiere  
baker

# i dolci e i dessert • cakes and desserts



**il bigné**  
éclair

**il bigné**  
choux pastry

**la panna**  
cream

**la pasta sfoglia**  
puff pastry

**il ripieno**  
filling

**la pasta filo**  
phyllo pastry



**il dolce alla frutta**  
fruit cake

**ricoperto di cioccolato**  
chocolate-coated

**la crostatina**  
fruit tart

**il muffin**  
muffin

**la meringa**  
meringue

**il pan di Spagna**  
sponge cake

i dolci | cakes

## vocabolario • vocabulary

**la crema pasticcera**  
crème patisserie

**la focaccina**  
bun

**la pasta**  
pastry

**il budino di riso**  
rice pudding

**Posso avere una fetta?**  
May I have a slice, please?

**la torta al cioccolato**  
chocolate cake

**la crema**  
custard

**la fetta**  
slice

**la festa**  
celebration

**il biscotto con scaglie di cioccolato**  
chocolate chip



**i savoiardi**  
lady fingers



**il biscotto alle noci**  
florentine

**la zuppa inglese**  
trifle

**i biscotti | cookies**



**il mousse**  
mousse



**il sorbetto**  
sherbet



**la torta alla crema**  
cream pie



**il crème caramel**  
crème caramel

## le torte per celebrazioni • celebration cakes

**il piano superiore**  
top tier

**il nastro**  
ribbon

**il piano inferiore**  
bottom tier

**la glassa**  
icing

**il marzapane**  
marzipan



**la torta nuziale | wedding cake**

**la decorazione**  
decoration

**le candeline**  
birthday candles

**soffiare**  
blow out (v)



**la torta di compleanno | birthday cake**

# la salumeria • delicatessen

**la salsiccia  
piccante**  
spicy sausage

**l'olio**  
oil



**il salame**  
salami

**il salame piccante**  
pepperoni

**los formato**  
quiche

**l'aceto**  
vinegar

**la carne cruda**  
uncooked meat

**il banco**  
counter

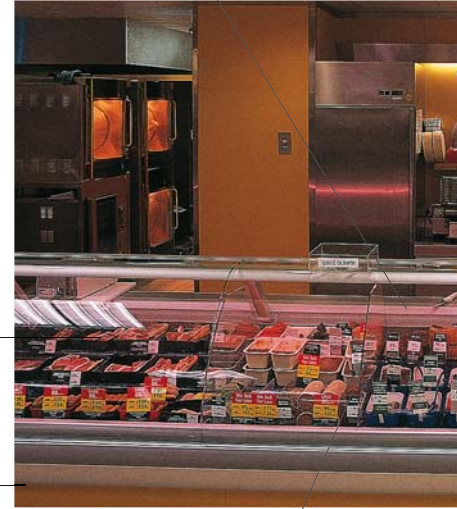

**il pâté**  
pâté



**la mozzarella**  
mozzarella



**il brie**  
brie



**il formaggio di capra**  
goat's cheese



**il cheddar**  
cheddar



**il parmigiano**  
parmesan



**il camembert**  
camembert

**la scorza**  
rind



**l'edam**  
edam



**il manchego**  
manchego



**i pasticci di carne**  
meat pies

**l'oliva nera**  
black olive

**il peperoncino**  
chili pepper

**la salsa**  
sauce



**il panino**  
bread roll

**la carne cotta**  
cooked meat



**l'oliva verde**  
green olive

**il prosciutto**  
ham

**la paninoteca**  
sandwich counter



**il pesce affumicato**  
smoked fish



**i capperi**  
capers

**vocabolario** • vocabulary

**sott'olio**  
in oil

**marinato**  
marinated

**affumicato**  
smoked

**in salamoia**  
in brine

**salato**  
salted

**trattato**  
cured

**Prenda un numero, per favore.**  
Take a number, please.

**Posso assaggiare un po' di quello, per favore?**  
Can I try some of that, please?

**Mi dà sei fette di quello, per favore?**  
May I have six slices of that, please?



**il chorizo**  
chorizo

**il prosciutto crudo**  
prosciutto



**le olive ripiene**  
stuffed olive

## le bevande • drinks

### l'acqua • water



### le bevande calde • hot drinks



### le bibite • soft drinks



le bevande alcoliche • alcoholic drinks



il gin  
gin



la birra  
beer

la lattina  
can



le cidre  
cider



la birra amara  
bitter



la birra scura  
stout



la vodka  
vodka



il whisky  
whiskey



il rum  
rum



il brandy  
brandy



il porto  
port



lo sherry  
sherry

sec  
dry



il campari  
campari

rosé  
rosé

bianco  
white

rosso  
red



il liquore  
liqueur



la tequila  
tequila



lo champagne  
champagne



il vino  
wine



il vino  
wine



il vino  
wine



**mangiare fuori**  
eating out

# il caffè • café



il menù  
menu

la tenda  
awning

il bar all'aperto | sidewalk café



l'ombrellone  
umbrella

il bar con terrazza  
terrace café

il  
cameriere  
waiter

la macchina  
del caffè  
coffee machine

il tavolo  
table



lo snack bar | snack bar

# il caffè • coffee

il caffè  
macchiato  
coffee with  
milk

il caffè nero  
black coffee

la polvere  
di cacao  
cocoa powder

la schiuma  
froth



il caffè filtrato  
filter coffee

l'espresso  
espresso

il cappuccino  
cappuccino

il caffè freddo  
iced coffee

**il tè • tea**

il tè alle erbe  
herbal tea



il tè con latte  
tea with milk

il tè nero  
black tea



la camomilla  
chamomile tea



il tè al limone  
tea with lemon



il tè verde  
green tea



il tè alla menta  
mint tea



il tè freddo  
iced tea

**le spremute e i frappé • juices and milkshakes**



il succo  
d'arancia  
orange juice



il succo di  
mela  
apple juice



il succo  
d'ananas  
pineapple juice



il succo di  
pomodoro  
tomato juice

il frappé al cioccolato  
chocolate milkshake

il frappé alle fragole  
strawberry milkshake

il frappé al caffè  
coffee milkshake



**il cibo • food**

il pane integrale  
whole-wheat  
bread



il tramezzino tostato  
toasted sandwich



l'insalata  
salad



il gelato  
ice cream

la pallina  
scoop



la pasta  
pastry

# il bar • bar



**i bicchieri**  
glasses

**il misurino**  
optic

**la cassa**  
cash register

**il barista**  
bartender

**lo spillatore di birra**  
beer tap

**la macchina da caffè**  
coffee machine

**il portagiaccio**  
ice bucket

**lo sgabello**  
bar stool

**il posacenere**  
ashtray

**il sottobicchiere**  
coaster

**il banco**  
bar counter

**l'apribottiglie**  
bottle opener



**la leva**  
lever

**il cavatappi** | corkscrew

**le pinze**  
tongs



**il miscelatore**  
stirrer

**il misurino**  
measure

**lo shaker** | cocktail shaker





**il gin tonic**  
gin and tonic

**la brocca**  
pitcher



**il whisky con acqua**  
scotch and water



**il cubetto  
di ghiaccio**  
ice cube

**il rum con coca cola**  
rum and cola



**la vodka all'arancia**  
screwdriver



**il martini**  
martini



**il cocktail**  
cocktail



**il vino**  
wine



**la birra** | beer



**un bicchiere**  
shot

**singolo**  
single



**la misura**  
measure

**doppio**  
double



**liscio**  
without ice

**con ghiaccio e limone**  
ice and lemon



**con ghiaccio**  
with ice

## gli stuzzichini • bar snacks



**le patatine** | chips

**le mandorle**  
almonds



**le noccioline** | nuts

**gli anacardi**  
cashews

**le noccioline  
americane**  
peanuts



**le olive** | olives

# il ristorante • restaurant

**zona non fumatori**  
nonsmoking section

**il tovagliolo**  
napkin

**l'aiuto cuoco**  
commis chef



**il coperto**  
table setting

**il cuoco**  
chef

**il bicchiere**  
glass

**il vassoio**  
tray

**la cucina**  
kitchen

**il cameriere**  
waiter

## vocabolario • vocabulary

**la lista dei vini**  
wine list

**il buffet**  
buffet

**il prezzo**  
price

**la mancia**  
tip

**il bar**  
bar

**il sale**  
salt

**il menù del pranzo**  
lunch menu

**a la carte**  
à la carte

**il conto**  
check

**servizio compreso**  
service included

**il cliente**  
customer

**il pepe**  
pepper

**il menù della cena**  
evening menu

**il carrello dei dolci**  
dessert cart

**la ricevuta**  
receipt

**servizio non compreso**  
service not included

**la zona fumatori**  
smoking section

**i piatti del giorno**  
specials



il menù  
menu



il menù per bambini  
child's meal



ordinare  
order (v)



pagare  
pay (v)

le portate • courses



l'aperitivo  
apéritif



l'antipasto  
appetizer



la minestra  
soup



il piatto principale  
entrée



il contorno  
side order

la forchetta  
fork



il dessert | dessert

il cucchiaino  
da caffè  
coffee spoon



il caffè | coffee

**Un tavolo per due, per favore.**  
A table for two, please.

**Posso vedere il menù\la lista dei vini, per favore?**

Can I see the menu/winelist, please?

**C'è un menù a prezzo fisso ?**  
Is there a fixed-price menu?

**Avete dei piatti vegetariani ?**

Do you have any vegetarian dishes?

**Posso avere il conto\una ricevuta per favore?**

Could I have the check/a receipt please?

**Possiamo pagare separatamente?**

Can we pay separately?

**Dove sono i bagni per favore?**

Where are the restrooms, please?

# il fast food • fast food

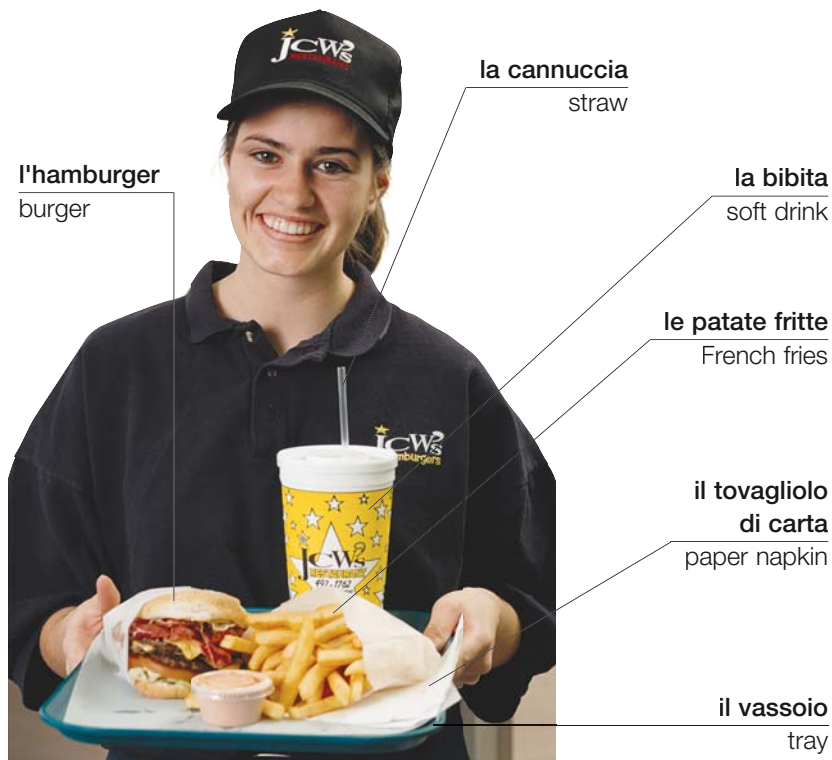

**l'hamburger**  
burger

**la cannuccia**  
straw

**la bibita**  
soft drink

**le patate fritte**  
French fries

**il tovagliolo  
di carta**  
paper napkin

**il vassoio**  
tray

**il pasto con hamburger**  
burger meal

**la pizza**  
pizza

**il listino**  
price list

**la bibita in lattina**  
canned drink



**la consegna a domicilio**  
home delivery



**il venditore ambulante**  
street vendor

**vocabolario •**  
vocabulary

**la pizzeria**  
pizzeria

**il fastfood**  
burger bar

**il menù**  
menu

**mangiare sul posto**  
for here

**da portar via**  
to go

**riscaldare**  
reheat (v)

**la salsa di pomodoro**  
ketchup

**Me lo dà da portar via?**  
Can I have that to go,  
please?

**Consegnate a domicilio?**  
Do you deliver?



**l'hamburger**  
hamburger



**l'hamburger di pollo**  
chicken burger



**l'hamburger vegetariano**  
veggie burger

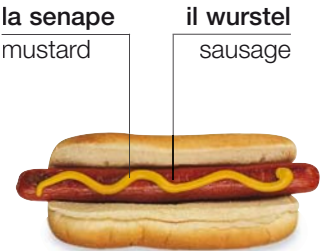

**l'hot dog**  
hot dog

**il panino**  
bun

**la senape**  
mustard

**il wurstel**  
sausage



**il tramezzino**  
sandwich



**il tramezzino a strati**  
club sandwich



**il tramezzino aperto**  
open-face sandwich

**il ripieno**  
filling



**la piadina**  
wrap



**il kebab**  
kebab

**la salsa**  
sauce



**i bocconcini di pollo**  
chicken nuggets

**salato**  
savory



**le crêpes** | crêpes



**dolce**  
sweet

**il condimento**  
topping



**il pesce con patatine**  
fish and chips



**le costolette**  
ribs



**il pollo fritto**  
fried chicken



**la pizza**  
pizza

# la colazione • breakfast



il latte  
milk

il cereale  
cereal

la marmellata  
jam

la frutta  
secca  
dried fruit

il prosciutto  
ham

il formaggio  
cheese

il pane  
biscottato  
crispbread

il buffet della colazione  
breakfast buffet

la marmellata  
di agrumi  
marmalade

il pâté  
pâté

il burro  
butter

il succo  
di frutta  
fruit juice

il caffè  
coffee



il tavolo della colazione | breakfast table

la cioccolata calda  
hot chocolate

il cornetto  
croissant



il tè  
tea

le bevande | drinks



**la brioche**  
brioche



**il pane**  
bread

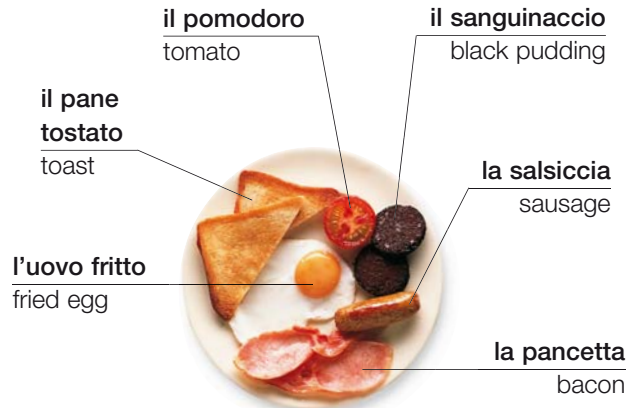

**il pomodoro**  
tomato

**il sanguinaccio**  
black pudding

**il pane tostato**  
toast

**la salsiccia**  
sausage

**l'uovo fritto**  
fried egg

**la pancetta**  
bacon

**la colazione all'inglese**  
English breakfast



**le aringhe affumicate**  
kippers

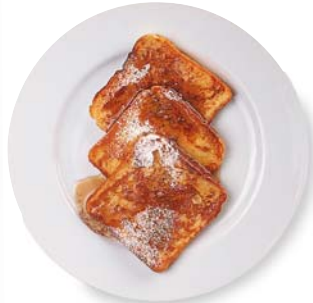

**il pane fritto all'uovo**  
French toast

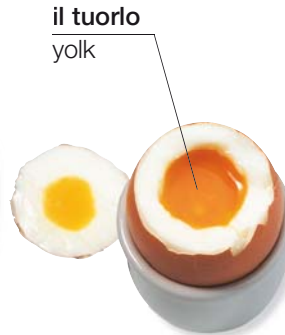

**il tuorlo**  
yolk

**l'uovo alla coque**  
boiled egg

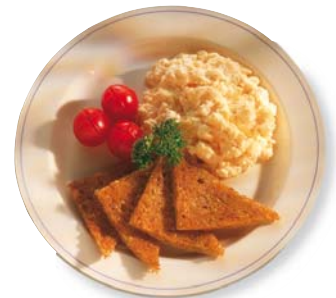

**le uova strapazzate**  
scrambled eggs



**le crêpes**  
crêpes

**la panna**  
cream



**i waffle**  
waffles

**lo yogurt alla frutta**  
fruit yogurt



**il porridge**  
oatmeal



**la frutta fresca**  
fresh fruit

# la cena • dinner



**la minestra** | soup



**la zuppa** | broth



**lo stufato** | stew



**il curry** | curry



**l'arrosto**  
roast



**il pasticcio**  
pie



**il soufflé**  
soufflé



**lo spiedino**  
kebab



**le polpette**  
meatballs



**la frittata**  
omelet



**la frittura** | stir-fry



**i taglierini**  
noodles



**la pasta** | pasta



**il riso**  
rice



**l'insalata mista**  
tossed salad



**l'insalata verde**  
green salad



**il condimento**  
dressing

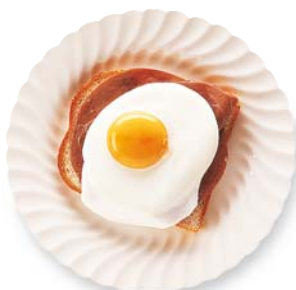

## i metodi • techniques

**imbottito** | stuffed**al sugo** | in sauce**alla griglia** | grilled**marinato** | marinated**affogato** | poached**schacciato** | mashed**cotto al forno** | baked**fritto in padella** | pan-fried**fritto**  
fried**sottaceto**  
pickled**affumicato**  
smoked**fritto in olio abbondante**  
deep-fried**allo sciroppo**  
in syrup**condito**  
dressed**al vapore**  
steamed**seccato**  
cured





**lo studio**  
study

# la scuola • school

**l'insegnante**  
teacher

**la lavagna**  
blackboard



**l'aula** | classroom



**lo scolaro**  
schoolboy

**l'alunno**  
student

**la divisa scolastica**  
school uniform

**il banco**  
desk

**la cartella**  
schoolbag

**il gesso**  
chalk



**la scolara**  
schoolgirl

## vocabolario • vocabulary

**la storia**  
history

**l'arte**  
art

**la fisica**  
physics

**la letteratura**  
literature

**la musica**  
music

**la chimica**  
chemistry

**le lingue**  
languages

**la matematica**  
math

**la biologia**  
biology

**la geografia**  
geography

**la scienza**  
science

**l'educazione fisica**  
physical education

## le attività • activities



**leggere** | read (v)



**scrivere** | write (v)



**scandire**  
spell (v)



**disegnare**  
draw (v)



**la lavagna luminosa**  
overhead projector



**la penna**  
pen



**la matita**  
pencil

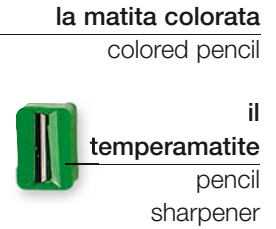

**la matita colorata**  
colored pencil

**il temperamatite**  
pencil sharpener

**la gomma**  
eraser

**il quaderno**  
notebook



**il libro di testo** | textbook



**l'astuccio**  
pencil case



**il righello**  
ruler



**domandare**  
question (v)



**rispondere**  
answer (v)



**discutere**  
discuss (v)



**imparare**  
learn (v)

**vocabolario** • vocabulary

**il preside**  
principal

**la risposta**  
answer

**il livello**  
grade

**la lezione**  
lesson

**i compiti**  
homework

**la classe**  
year

**la domanda**  
question

**il tema**  
essay

**il dizionario**  
dictionary

**prendere appunti**  
take notes (v)

**l'esame**  
test

**l'enciclopedia**  
encyclopedia

# la matematica • math

## le forme • shapes

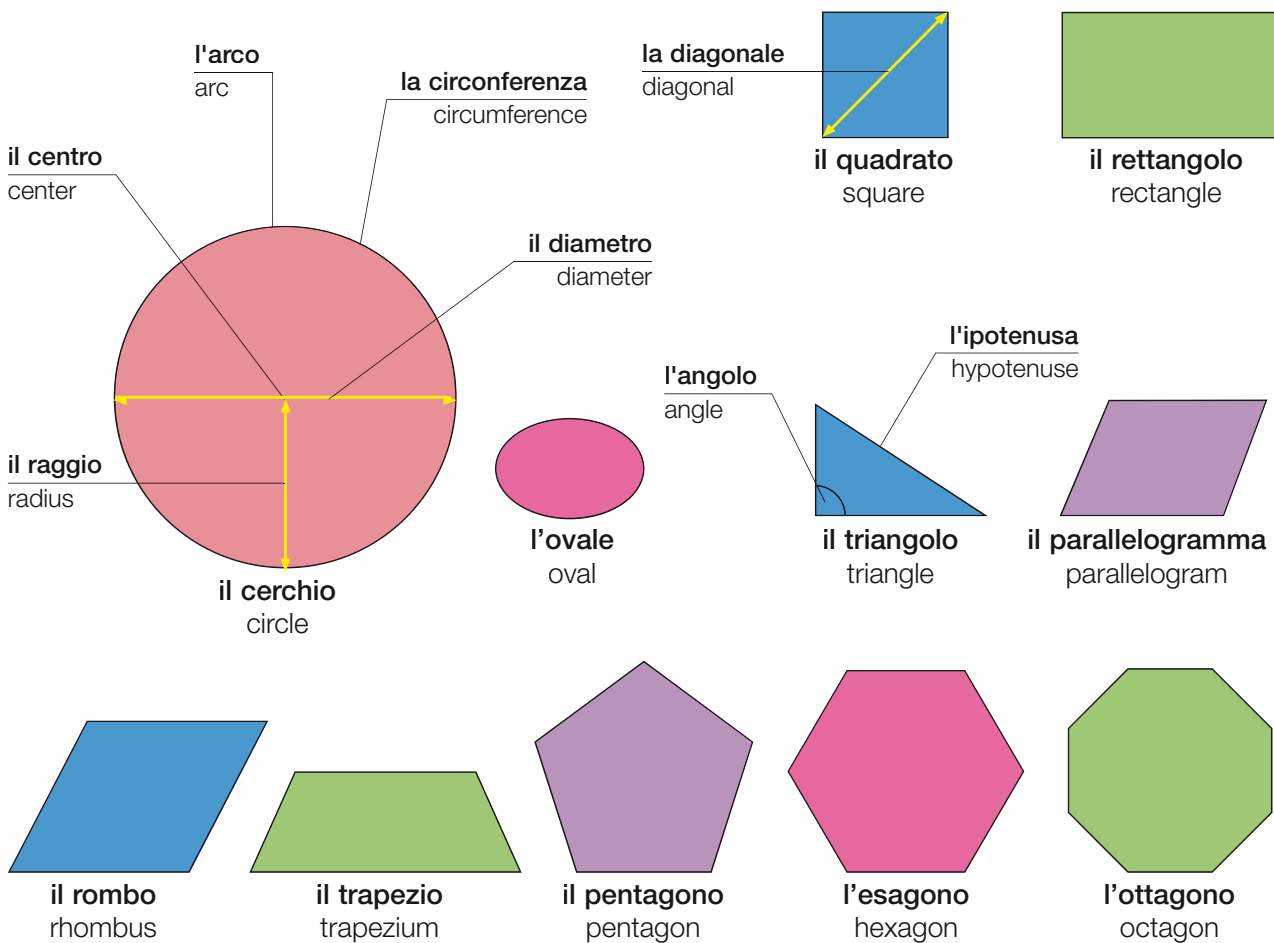

## i solidi • solids

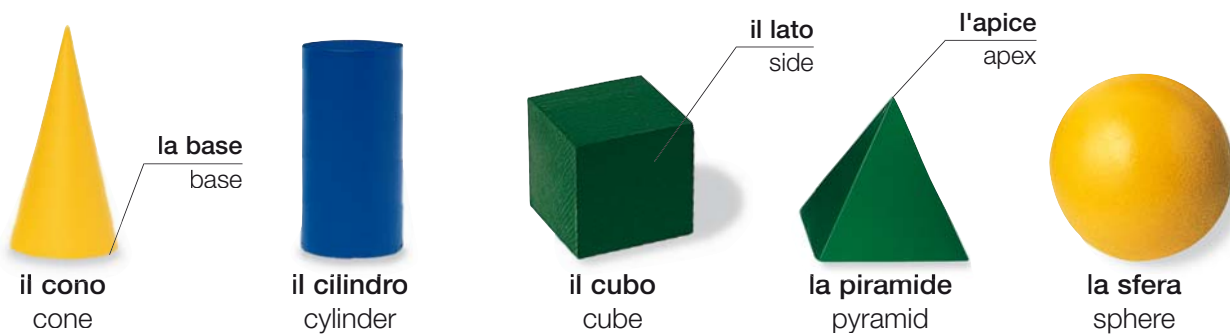

**le linee • lines**



**dritto**  
straight

**parallelo**  
parallel

**perpendicolare**  
perpendicular

**curvo**  
curved

**le misure • measurements**



**il volume**  
volume

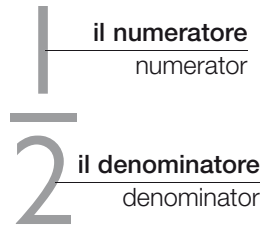

**la frazione**  
fraction

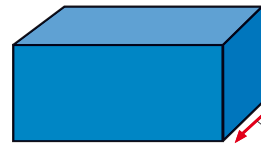

**le dimensioni**  
dimensions

**la larghezza**  
width

**l'altezza**  
height

**la profondità**  
depth

**la lunghezza**  
length



**la superficie**  
area

**l'attrezzatura • equipment**



**la squadra**  
square



**il goniometro**  
protractor



**il righello**  
ruler



**il compasso**  
compass



**la calcolatrice**  
calculator

**vocabolario • vocabulary**

<b>la geometria</b> geometry	<b>più</b> plus	<b>contare</b> count (v)	<b>uguale</b> equals	<b>sommare</b> add (v)	<b>moltiplicare</b> multiply (v)	<b>l'equazione</b> equation
<b>l'aritmetica</b> arithmetic	<b>meno</b> minus	<b>diviso per</b> divided by	<b>moltiplicato per</b> times	<b>sottrarre</b> subtract (v)	<b>dividere</b> divide (v)	<b>la percentuale</b> percentage

# la scienza • science



**il laboratorio**  
laboratory



**la bilancia**  
scales



**la bilancia a molla**  
spring balance

**il crogiolo**  
crucible



**il becco Bunsen**  
bunsen burner

**il treppiede**  
tripod



**la bottiglia di vetro**  
glass bottle

**l'imbuto**  
funnel

**l'ampolla**  
flask

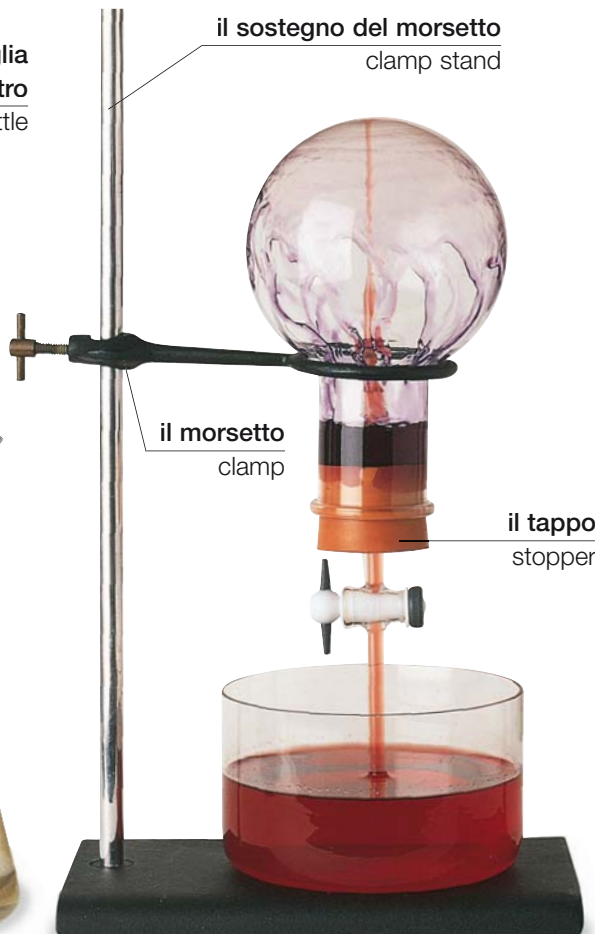

**il sostegno del morsetto**  
clamp stand

**il morsetto**  
clamp

**il tappo**  
stopper

**l'esperimento | experiment**

**la provetta**  
test tube



**la rastrelliera**  
rack



**il cronometro**  
timer



**la capsula di Petri**  
petri dish





**il termometro**  
thermometer



**la siringa**  
syringe



**le pinzette**  
tweezers



**il bisturi**  
scalpel



**il contagocce**  
dropper



**il forcipe | forceps**



**le tenaglie**  
tongs



**la spatola**  
spatula

**il pestello**  
pestle



**il mortaio**  
mortar



**il filtro di carta**  
filter paper



**gli occhiali protettivi**  
safety goggles

**l'oculare**  
eyepiece

**la manopola di messa a fuoco**  
focusing knob



**l'obiettivo**  
objective lens

**il ripiano**  
stage

**la lastrina**  
slide

**lo specchio**  
mirror

**il microscopio | microscope**



**la bacchetta di vetro**  
glass stirrer



**il becher**  
beaker

**la pipetta**  
pipette



**la calamita**  
magnet



**il morsetto**  
alligator clip

**l'elettrodo negativo**  
negative electrode



**l'elettrodo positivo**  
positive electrode

**la batteria | battery**

# l'università • college

**l'ufficio iscrizioni**  
admissions office

**il refettorio**  
cafeteria

**l'ambulatorio**  
clinic



**il campo sportivo**  
sports field

**la casa dello studente**  
residence hall

**il catalogo**  
card catalog

**il campus** | campus

**la bibliotecaria**  
librarian



**il banco prestiti**  
circulation desk

**lo scaffale**  
bookshelf

**il periodico**  
periodical

**la rivista**  
journal



**la biblioteca** | library

## vocabolario • vocabulary

**il tesserino**  
library card

**il prestito**  
loan

**il libro**  
book

**la corsia**  
aisle

**rinnovare**  
renew (v)

**il titolo**  
title

**la lista dei libri**  
reading list

**prendere in prestito**  
borrow (v)

**la sala di lettura**  
reading room

**il banco informazioni**  
helpdesk

**prenotare**  
reserve (v)

**la data di restituzione**  
due date

**lo studente  
universitario**  
undergraduate

**il docente**  
professor



**l'aula**  
lecture hall

**la laureata**  
graduate

**la toga**  
gown



**la consegna delle lauree**  
graduation ceremony

## le scuole • schools



**la modella**  
model

**la scuola d'arte**  
art college



**il conservatorio**  
music school



**l'accademia di danza**  
dance academy

## vocabolario • vocabulary

**la borsa di studio**  
scholarship

**la ricerca**  
research

**la dissertazione**  
dissertation

**la medicina**  
medicine

**l'economia**  
economics

**il diploma**  
diploma

**il master**  
master's

**il dipartimento**  
department

**la zoologia**  
zoology

**la politica**  
politics

**la laurea**  
degree

**il dottorato**  
doctorate

**il diritto**  
law

**la fisica**  
physics

**la letteratura**  
literature

**di perfezionamento**  
postgraduate

**la tesi**  
thesis

**l'ingegneria**  
engineering

**la filosofia**  
philosophy

**la storia  
dell'arte**  
art history

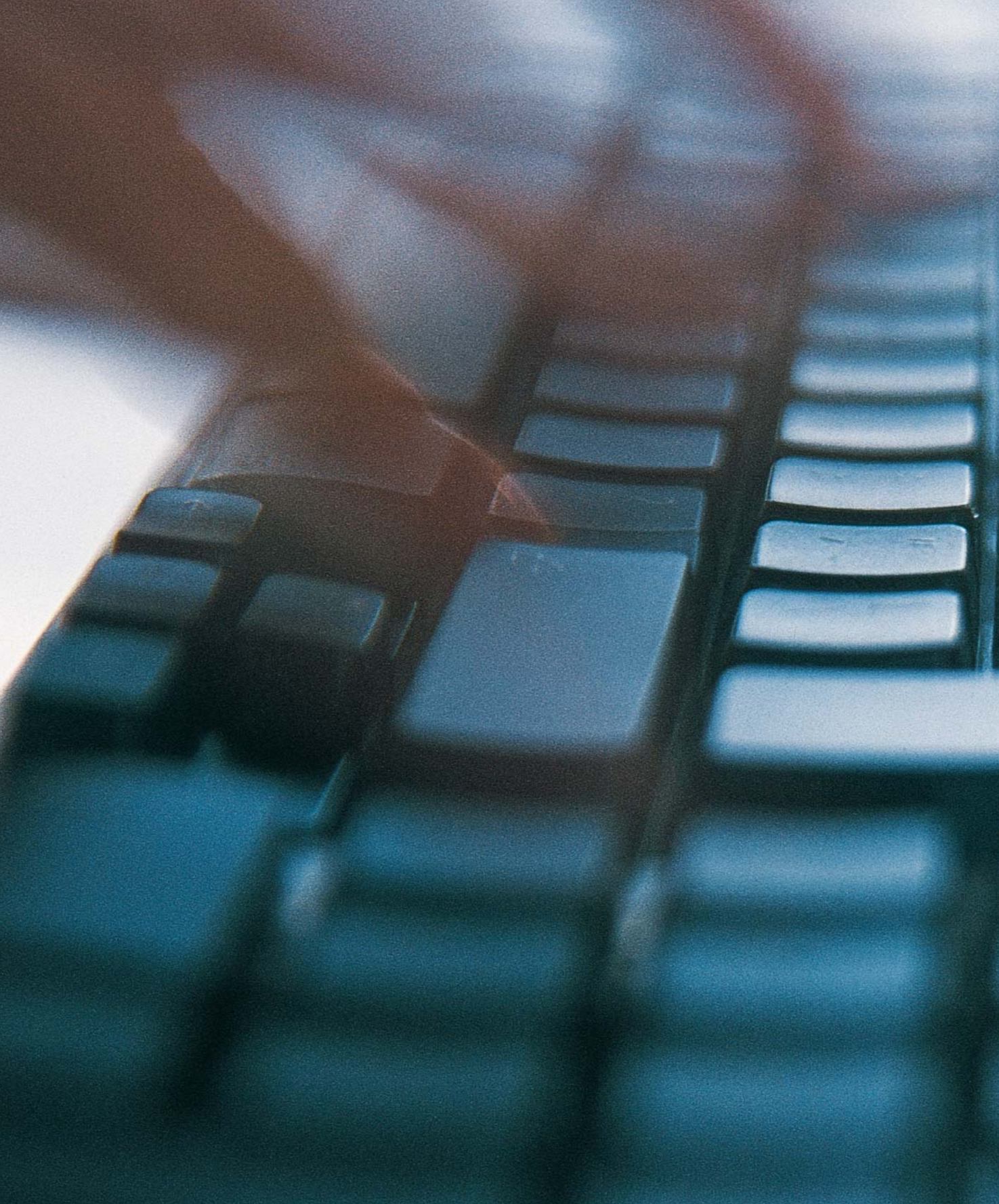



**il lavoro**  
work

# l'ufficio 1 • office 1

## l'ufficio • office



## l'apparecchiature da ufficio • office equipment

**la contenitore per la carta**  
paper tray



**la stampante** | printer

**la guida**  
paper guide

**il fax**  
fax



**il fax** | fax machine

### vocabolario • vocabulary

**stampare**  
print (v)

**ingrandire**  
enlarge (v)

**copiare**  
copy (v)

**ridurre**  
reduce (v)

**Devo fare delle copie.**  
I need to make some copies.

gli articoli di cancelleria • office supplies



la carta intestata  
stationery

il foglietto di  
omaggio  
notecard



la busta  
envelope

la scatola  
d'archivio  
box file



il portablocco  
con fermaglio  
clipboard



il blocco per  
appunti  
note pad

l'etichetta  
tab



la cartella  
sospesa  
hanging file

il divisore  
divider



il portacarte a  
fisarmonica  
expanding file

il raccogliatore  
a leva  
ring binder



l'agenda  
personal organizer

i punti  
staples



la cucitrice  
stapler

il nastro adesivo  
tape



il dispenser  
tape dispenser



il perforatore  
hole punch

il tampone  
di inchiostro  
ink pad



il timbro umido  
rubber stamp



l'elastico  
rubber band



la molletta  
bulldog clip



la grappetta  
paper clip

la puntina  
thumbtack



il tabellone | notice board

# l'ufficio 2 • office 2

**il poster scorrevole**

flipchart

**il verbale**

minutes

**il cavalletto**

easel

**la relazione**

report

**il direttore**

manager

**la proposta**

proposal

**il**

**dirigente**

executive

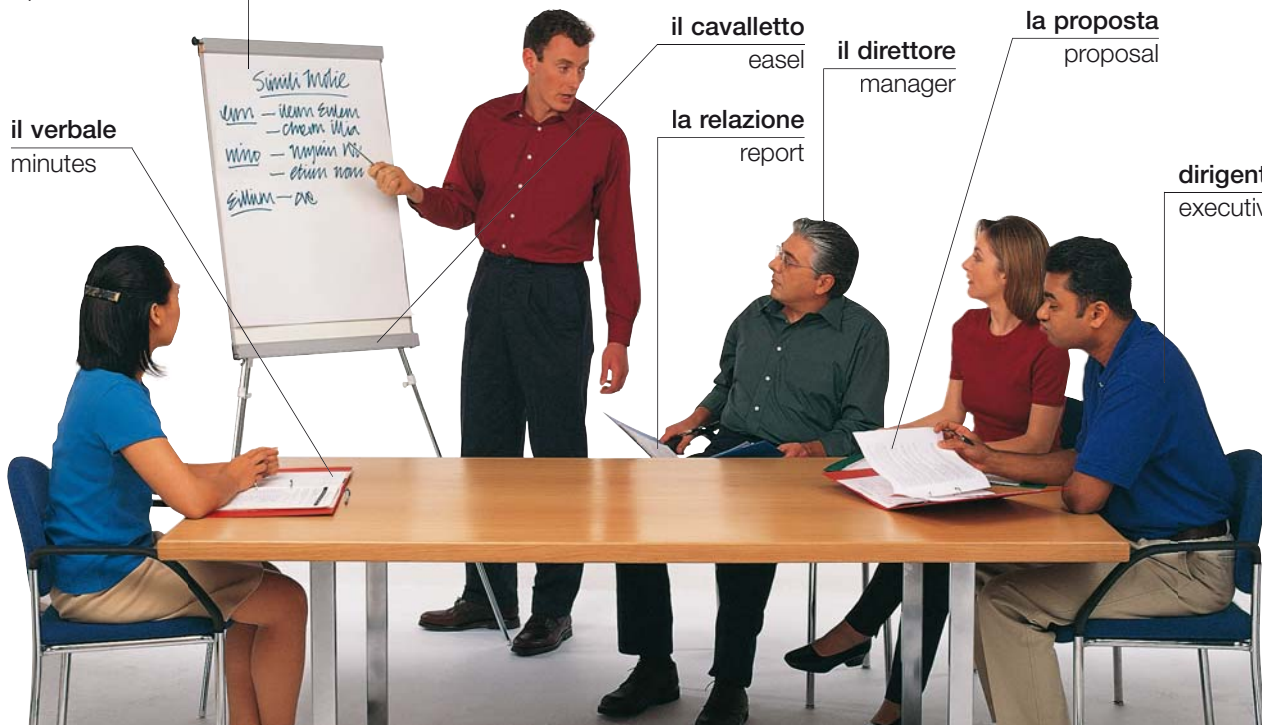

la riunione | meeting

## vocabolario • vocabulary

**la sala da riunione**

meeting room

**partecipare**

attend (v)

**l'ordine del giorno**

agenda

**presiedere**

chair (v)

**A che ora è la riunione?**

What time is the meeting?

**Qual è il vostro orario di lavoro?**

What are your office hours?

**la lavagna**

**luminosa**

projector

**il relatore**

speaker



la presentazione | presentation



gli affari • business

il laptop  
laptop

gli appunti  
notes

l'uomo di affari  
businessman

la donna di affari  
businesswoman



il pranzo di affari  
business lunch



il viaggio di affari  
business trip



l'agenda | organizer

il cliente  
client

l'appuntamento  
appointment

il palmtop  
palmtop



l'accordo di affari  
business deal

l'amministratore  
delegato  
CEO

vocabolario • vocabulary

la società  
company

il personale  
staff

l'ufficio contabilità  
accounts department

l'ufficio legale  
legal department

la sede  
headquarters

il libro paga  
payroll

l'ufficio marketing  
marketing department

l'ufficio di assistenza al cliente  
customer service department

la succursale  
regional office

lo stipendio  
salary

l'ufficio vendite  
sales department

l'ufficio del personale  
human resources department

# il computer • computer

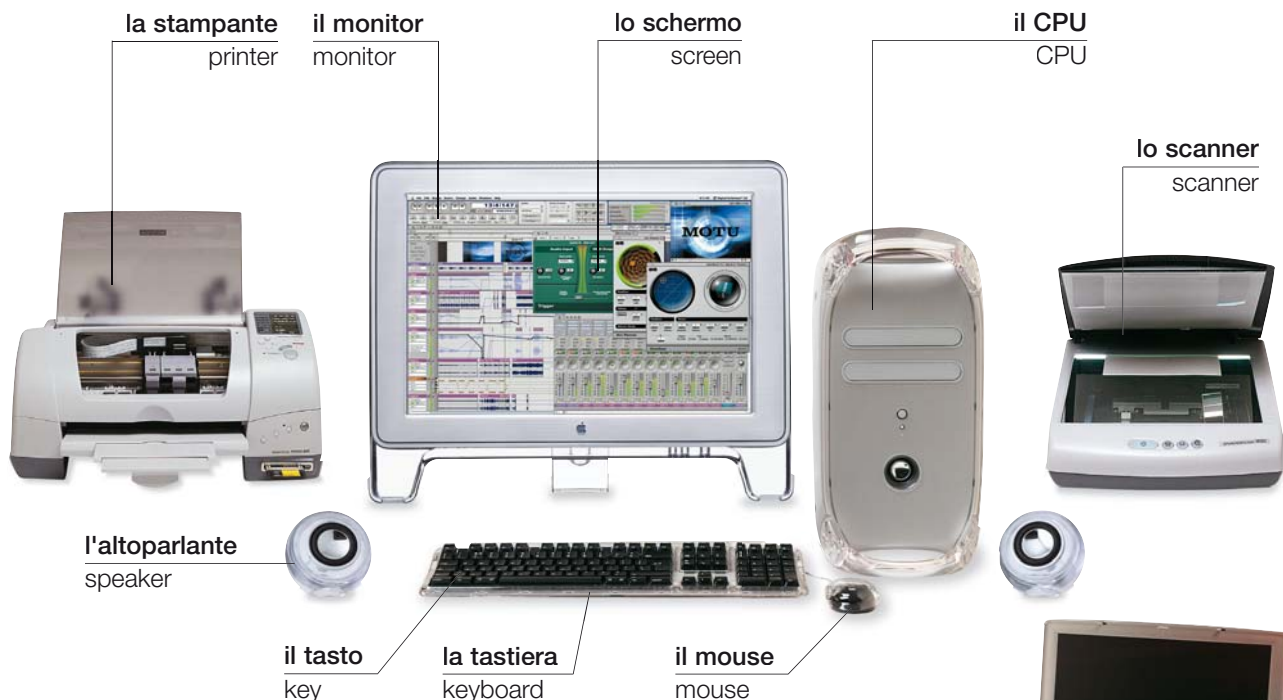

**l'hardware**  
hardware



**il dischetto**  
disk



**il computer portatile**  
laptop

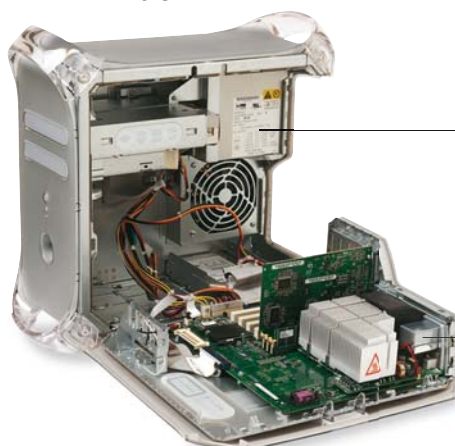

**l'hard drive**  
hard drive

**il modem**  
modem

## vocabolario • vocabulary

**la memoria**  
memory

**il software**  
software

**il server**  
server

**la RAM**  
RAM

**l'applicazione**  
application

**la porta**  
port

**i byte**  
bytes

**il programma**  
program

**il processore**  
processor

**il sistema**  
system

**la rete**  
network

**il cavo di alimentazione**  
power cord

## il desktop • desktop

la barra del menu  
menu bar

la barra degli strumenti  
toolbar

lo sfondo  
wallpaper

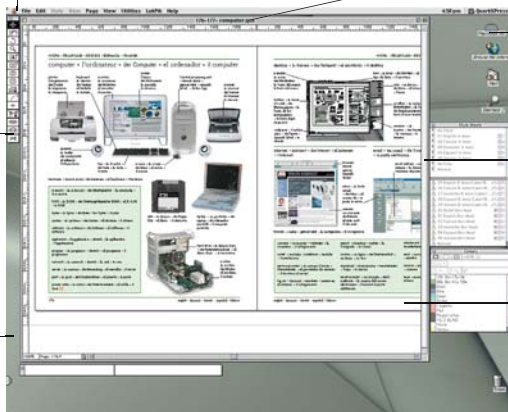

il carattere  
font

l'icona  
icon

la barra di scorrimento  
scrollbar

la finestra  
window



**AFO08.psd**

il file  
file



**AFO08**

la cartella  
folder



**Trash**

il cestino  
trash

## Internet • internet



il browser  
browser

la posta  
in arrivo  
inbox

il sito web  
website

la navigazione  
browse (v)

## la posta elettronica • email

l'indirizzo di posta  
elettronica  
email address

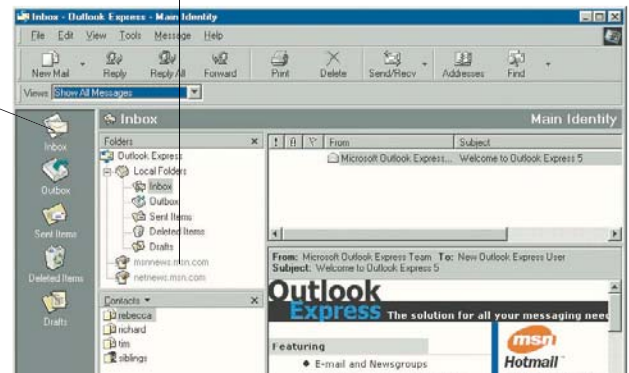

### vocabolario • vocabulary

**collegare**  
connect (v)

**il fornitore di servizi**  
service provider

**collegarsi**  
log on (v)

**scaricare**  
download (v)

**spedire**  
send (v)

**salvare**  
save (v)

**installare**  
install (v)

**l'account di posta elettronica**  
email account

**in rete**  
on-line

**l'allegato**  
attachment

**ricevere**  
receive (v)

**cercare**  
search (v)

# i mass media • media

## lo studio televisivo • television studio

**il presentatore**  
presenter

**la lampada**  
light

**il set**  
set



**la telecamera**  
camera

**il carrello della telecamera**  
camera crane

**il cameraman**  
cameraman

### vocabolario • vocabulary

**il canale**  
channel

**il documentario**  
documentary

**la stampa**  
press

**la telenovela**  
soap opera

**in differita**  
pre-recorded

**in diretta**  
live

**la programmazione**  
programming

**il telegiornale**  
news

**le serie televisive**  
television series

**il gioco a premi**  
game show

**il cartone animato**  
cartoon

**trasmettere**  
broadcast (v)



**l'intervistatore**  
interviewer



**la cronista**  
reporter



**il gobbo**  
teleprompter



**l'annunciatrice**  
newscaster



**gli attori**  
actors



**la giraffa**  
sound boom



**il ciac**  
clapper board



**il set**  
movie set

## la radio • radio

**il piano di mixaggio**  
mixing desk

**il microfono**  
microphone

**il tecnico del suono**  
sound technician



**lo studio di registrazione** | recording studio

## vocabolario • vocabulary

**sintonizzare**  
tune (v)

**l'onda corta**  
short wave

**il DJ**  
DJ

**l'onda media**  
medium wave

**la trasmissione**  
broadcast

**la frequenza**  
frequency

**la lunghezza d'onda**  
wavelength

**il canale radiofonico**  
radio station

**l'onda lunga**  
long wave

**il volume**  
volume

# la legge • law

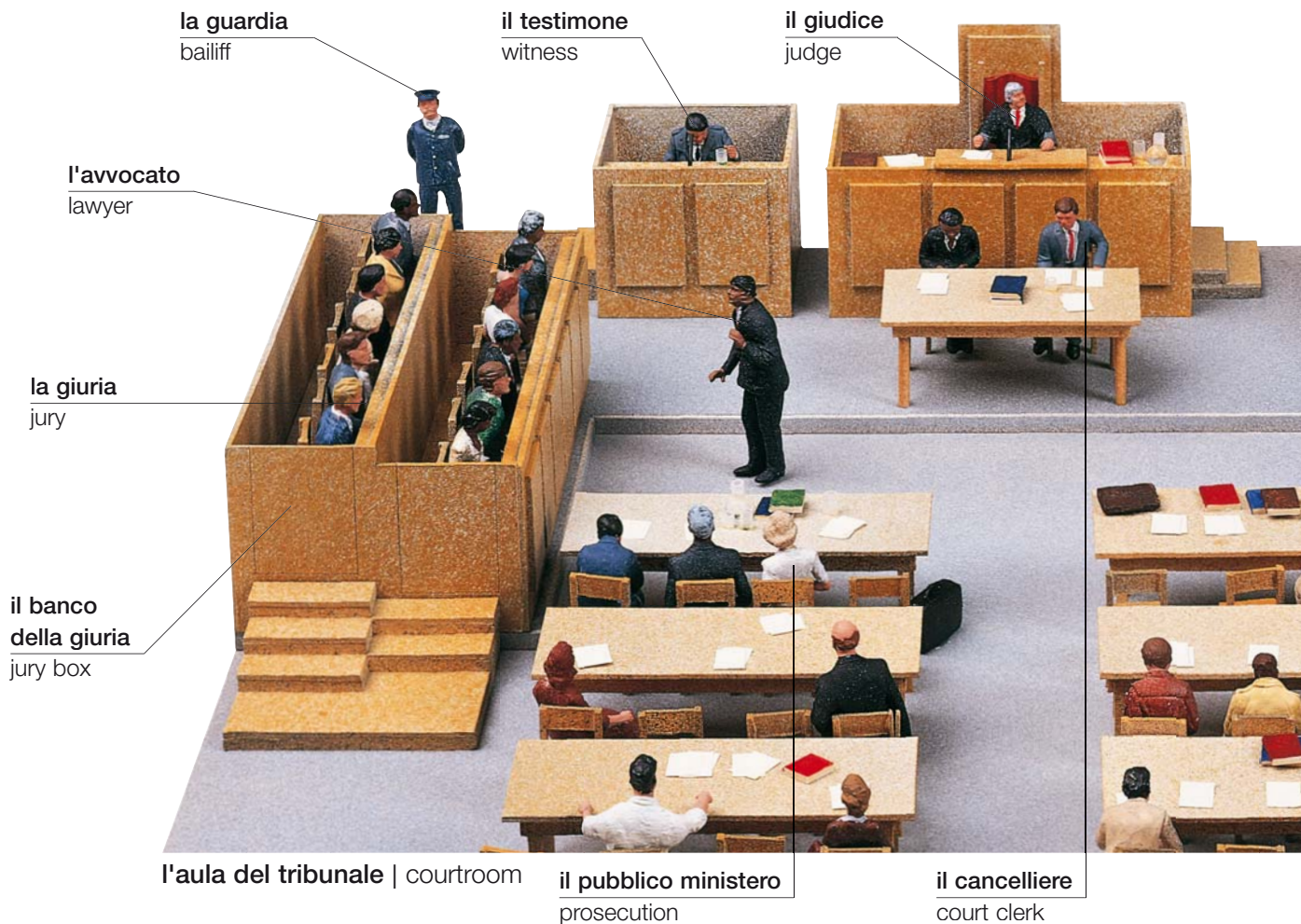

## vocabolario • vocabulary

**il cliente**  
client

**la citazione**  
summons

**l'ordine**  
writ

**il procedimento**  
court case

**la consulenza legale**  
legal advice

**la dichiarazione**  
statement

**l'accusato**  
accused

**l'imputazione**  
charge

**lo studio dell'avvocato**  
lawyer's office

**il mandato**  
warrant

**la petizione**  
plea

**la data di comparizione**  
court date

**lo stenografo**  
stenographer

**la persona sospetta**  
suspect

**l'imputato**  
defendant

**la difesa**  
defense

**la guardia carceraria**  
prison guard



**il fotofit**  
composite

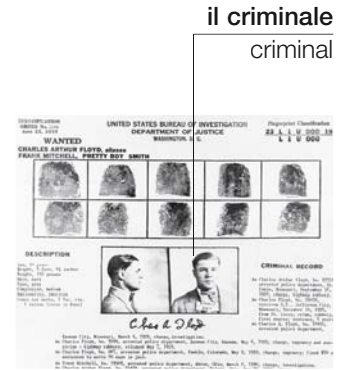

**la fedina penale**  
criminal record



**la cella**  
cell



**il carcere**  
prison

**vocabolario** • vocabulary

**la prova**  
evidence

**colpevole**  
guilty

**la cauzione**  
bail

**Voglio vedere un avvocato.**  
I want to see a lawyer.

**il verdetto**  
verdict

**assolto**  
acquitted

**il ricorso**  
appeal

**Dov'è il palazzo di giustizia?**  
Where is the courthouse?

**innocente**  
innocent

**la sentenza**  
sentence

**la libertà per buona condotta**  
parole

**Posso versare una cauzione?**  
Can I post bail?

# la fattoria 1 • farm 1



**l'agricoltore**  
farmer

**l'orto**  
vegetable  
garden

**il terreno agricolo**  
farmland

**l'aia**  
farmyard

**il capanno**  
outbuilding

**il casolare**  
farmhouse



**il campo**  
field

**il granaio**  
barn

**la siepe**  
hedge

**il cancello**  
gate

**il recinto**  
fence

**il pascolo**  
pasture

**il bestiame**  
livestock



**il trattore** | tractor

**l'aratro**  
cultivator



**la mietitrebbia** | combine



## i tipi di fattoria • types of farm

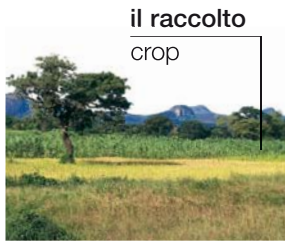

il raccolto  
crop

**l'azienda agricola**  
crop farm



**il caseificio**  
dairy farm



il gregge  
flock

**l'allevamento di pecore**  
sheep farm



**l'azienda avicola**  
poultry farm



**l'allevamento di maiali**  
pig farm



**il vivaio ittico**  
fish farm



**l'azienda ortofrutticola**  
fruit farm

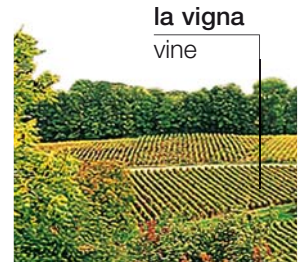

la vigna  
vine

**il vigneto**  
vineyard

## le attività • actions



il solco  
furrow

**arare**  
plow (v)



**seminare**  
sow (v)



**mungere**  
milk (v)

**dar da mangiare**  
feed (v)



**irrigare** | water (v)



**raccogliere** | harvest (v)

### vocabolario • vocabulary

**l'erbicida**  
herbicide

**la mandria**  
herd

**la mangiatoia**  
trough

**il pesticida**  
pesticide

**il silos**  
silo

**piantare**  
plant (v)

# la fattoria 2 • farm 2

## le colture • crops



**il grano**  
wheat



**il granturco**  
corn



**l'orzo**  
barley



**la colza**  
rapeseed



**il girasole**  
sunflower



**la balla**  
bale

**il fieno**  
hay



**l'alfalfa**  
alfalfa



**il tabacco**  
tobacco



**il riso**  
rice



**il tè**  
tea



**il caffè**  
coffee



**il lino**  
flax



**la canna da zucchero**  
sugarcane



**il cotone**  
cotton



**lo spaventapasseri**  
scarecrow

**il bestiame • livestock**

**il maialino**  
piglet



**il maiale**  
pig

**il vitello**  
calf



**la mucca**  
cow



**il toro**  
bull



**la pecora**  
sheep

**il capretto**  
kid



**l'agnello**  
lamb

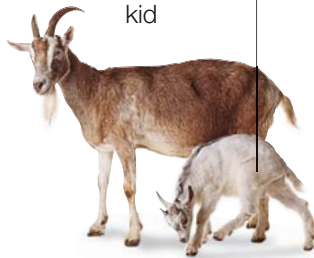

**la capra**  
goat

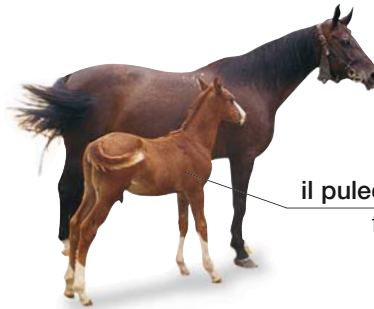

**il puledro**  
foal

**il cavallo**  
horse



**l'asino**  
donkey

**il pulcino**  
chick

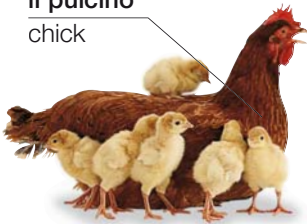

**la gallina**  
chicken



**il gallo**  
rooster



**il tacchino**  
turkey

**l'anatroccolo**  
duckling



**l'anatra**  
duck



**la stalla**  
stable



**il recinto**  
pen



**il pollaio**  
chicken coop



**il porcile**  
pigsty

# l'edilizia • construction

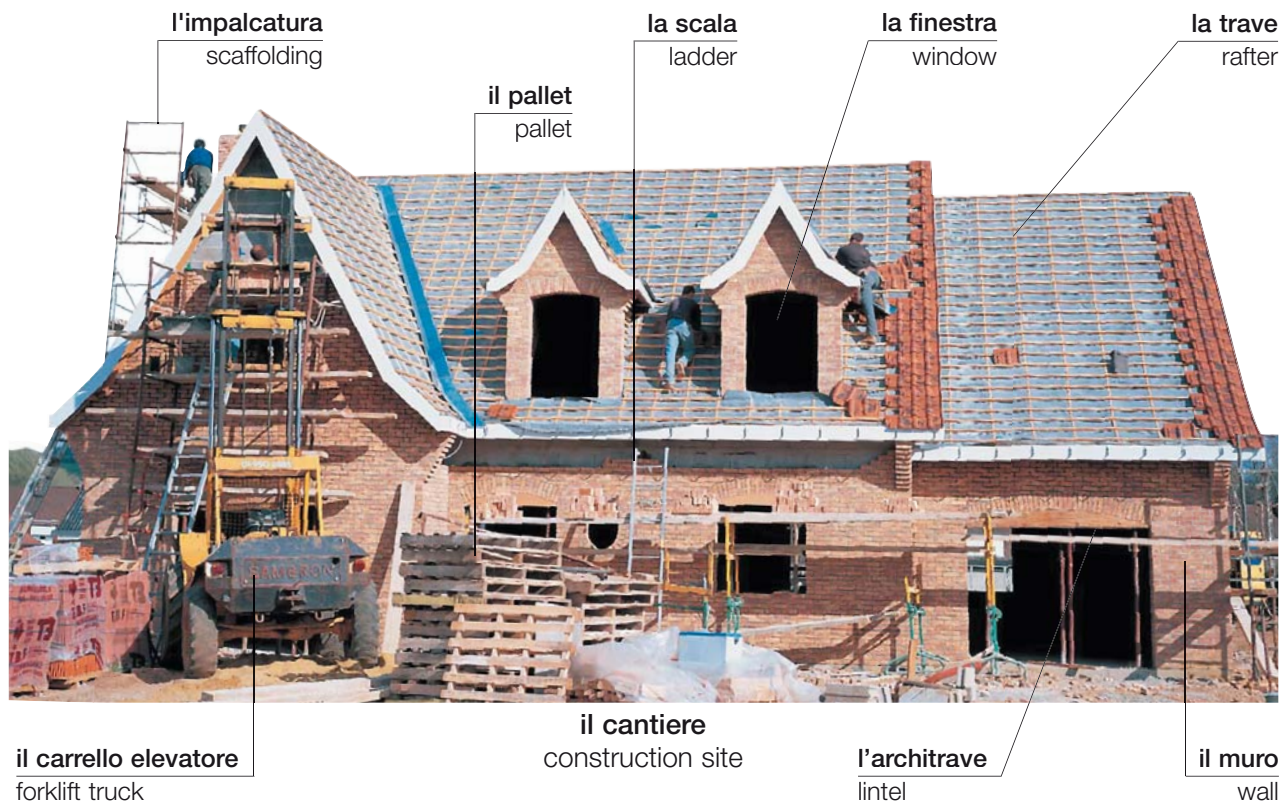

**costruire**  
build (v)



**il muratore**  
carpenter



**la betoniera**  
cement mixer

## i materiali • materials



**il mattone**  
brick



**il legno**  
lumber



**la tegola**  
roof tile



**il blocco di calcestruzzo**  
concrete block

## gli attrezzi • tools

**la malta**  
mortar



**la cazzuola**  
trowel



**la livella**  
level



**la mazza**  
sledgehammer



**il manico**  
handle

**il piccone**  
pickax



**la pala**  
shovel

## i macchinari • machinery



**il rullo compressore**  
roller



**il camion con cassone ribaltabile**  
dump truck



**il gancio**  
hook

**la gru** | crane

**il supporto**  
support

## i lavori stradali • roadworks

**il catrame**  
asphalt



**il martello pneumatico**  
jackhammer

**il birillo**  
cone



**la riasfaltatura**  
resurfacing

**l'escavatrice meccanica**  
excavator

# i mestieri 1 • occupations 1



**il falegname**  
carpenter



**l'elettricista**  
electrician



**l'idraulico**  
plumber



**il muratore**  
construction worker



**il giardiniere**  
gardener

**l'aspirapolvere**  
vacuum cleaner



**l'addetto alle pulizie**  
cleaner



**il meccanico**  
mechanic



**il macellaio**  
butcher

**le forbici**  
scissors



**il parrucchiere**  
hairdresser



**la pescivendola**  
fish seller



**il fruttivendolo**  
produce seller



**la fioraia**  
florist



**il barbiere**  
barber



**il gioielliere**  
jeweler



**la commessa**  
store clerk



**l'agente immobiliare**  
realtor



**l'ottico**  
optometrist



**la dentista**  
dentist

la  
**mascherina**  
mask



**il medico**  
doctor



**la farmacista**  
pharmacist



**l'infermiera**  
nurse



**la veterinaria**  
veterinarian



**l'agricoltore**  
farmer



**il pescatore**  
fisherman

la mitragliatrice  
machine-gun



**il soldato**  
soldier



**il poliziotto**  
police officer

il distintivo  
badge



**la guardia di sicurezza**  
security guard

la divisa  
uniform



**il marinaio**  
sailor



**il vigile del fuoco**  
firefighter

# i mestieri 2 • occupations 2



**l'avvocato**  
lawyer



**il commercialista**  
accountant

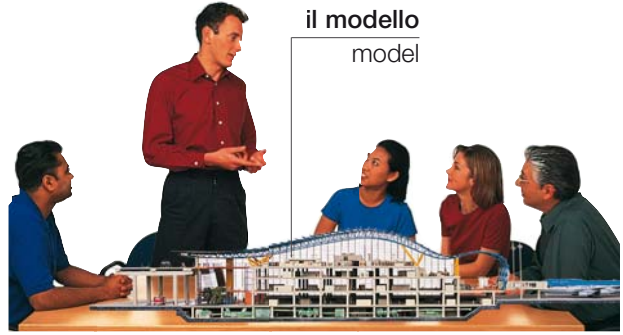

**il modello**  
model

**l'architetto**  
architect



**lo scienziato**  
scientist



**l'insegnante**  
teacher



**il bibliotecario**  
librarian



**l'addetta alla ricezione**  
receptionist



**la**  
**borsa**  
mailbag

**il postino**  
mail carrier



**l'autista**  
bus driver



**il camionista**  
truck driver



**il tassista**  
cab driver



**il pilota**  
pilot



**l'assistente di volo**  
flight attendant



**l'agente di viaggio**  
travel agent



**il cappello**  
chef's hat

**il cuoco**  
chef





**il musicista**  
musician



il tutù  
tutu

**la ballerina**  
dancer



**l'attore**  
actor



**la cantante**  
singer



**la cameriera**  
waitress



**il barista**  
bartender



**l'atleta**  
sportsman



**lo scultore**  
sculptor



**la pittrice**  
painter



**il fotografo**  
photographer



**l'annunciatore**  
newscaster



les notes  
notes

**il giornalista**  
journalist



**la redattrice**  
editor



**la disegnatrice**  
designer



**la costumista**  
seamstress



**il sarto**  
tailor





**i trasporti**  
transportation

# le strade • roads

**l'autostrada**  
freeway

**il casello**  
toll booth

**la segnaletica  
orizzontale**  
road markings

**la rampa  
di accesso**  
frontage  
road

**a senso unico**  
one-way

**la linea divisoria**  
divider

**lo svincolo**  
interchange

**il semaforo**  
traffic light



**il camion**  
truck

**la banchina  
spartitraffico**  
median strip

**la corsia interna**  
right lane

**la corsia  
centrale**  
center lane

**la corsia  
esterna**  
left lane

**la rampa di uscita**  
exit ramp

**il traffico**  
traffic

**il cavalcavia**  
overpass

**la corsia  
d'emergenza**  
shoulder

**il sottopassaggio**  
underpass

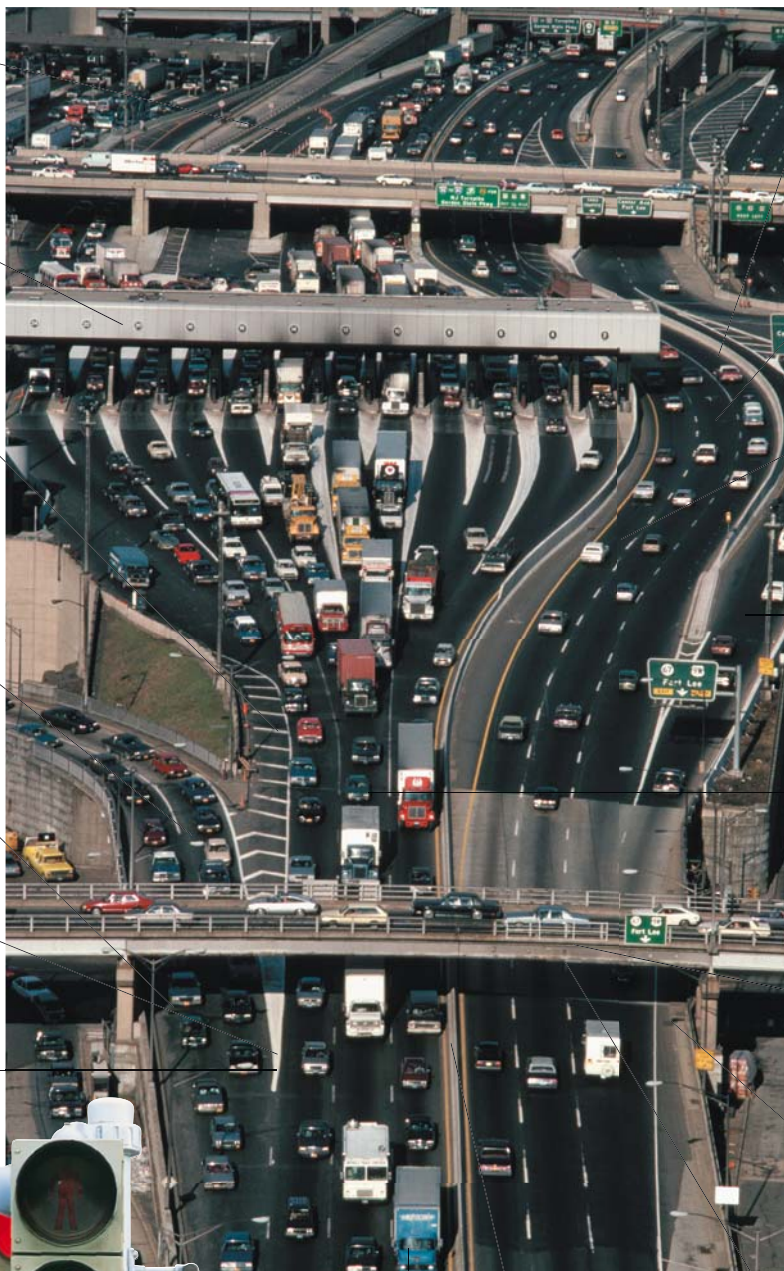



**il passaggio pedonale**  
crosswalk



**il telefono per emergenze**  
emergency phone



**il parcheggio per disabili**  
disabled parking



**l'ingorgo**  
traffic jam

la  
mappa  
map



**il parchimetro**  
parking meter



**il vigile urbano**  
traffic policeman



**vocabolario • vocabulary**

**la rotonda**  
roundabout

**sorpassare**  
pass (v)

**i lavori stradali**  
road construction

**la deviazione**  
detour

**parcheggiare**  
park (v)

**la carreggiata doppia**  
divided highway

**il guardrail**  
guardrail

**rimorchiare**  
tow away (v)

**È questa la strada per ...?**  
Is this the road to...?

**fare marcia indietro**  
back up (v)

**guidare**  
drive (v)

**Dove posso parcheggiare?**  
Where can I park?

**i cartelli stradali • road signs**



**ingresso vietato**  
do not enter



**il limite di velocità**  
speed limit



**pericolo**  
hazard



**sosta vietata**  
no stopping



**svolta a destra vietata**  
no right turn

# l'autobus • bus

il sedile  
dell'autista  
driver's seat

la maniglia  
handrail

la porta a soffietto  
automatic door

la ruota  
anteriore  
front wheel

il bagagliaio  
luggage hold



la porta | door



il pullman | long-distance bus

## i tipi di autobus • types of buses

il numero  
del percorso  
route number

l'autista  
driver



l'autobus a due piani  
double-decker bus



il tram  
tram



il filobus  
trolley bus



lo scuolabus | school bus



la ruota  
posteriore  
rear wheel

il finestrino  
window



il biglietto  
bus ticket

il pulsante  
di chiamata  
stop button



il campanello  
bell



l'autostazione  
bus station



la fermata  
dell'autobus  
bus stop

**vocabolario • vocabulary**

la tariffa  
fare

la pensilina  
bus shelter

l'orario  
schedule

l'accesso per sedie a rotelle  
wheelchair access

Ferma a...?  
Do you stop at...?

Qual è l'autobus per...?  
Which bus goes to...?



il pulmino  
minibus



il pullman turistico | tour bus



la navetta | shuttle bus

# l'automobile 1 • car 1

## l'esterno • exterior



il portabagagli  
roof rack



il portellone  
tailgate



la cintura di sicurezza  
seat belt



il seggiolino per  
bambino  
car seat



i tipi • types



**l'auto piccola**  
compact car



**l'auto a cinque porte**  
hatchback



**la berlina**  
sedan



**l'auto familiare**  
station wagon



**l'auto decapottabile**  
convertible



**l'auto sportiva**  
sports car



**la monovolume**  
minivan



**il fuoristrada**  
four-wheel drive



**l'auto d'epoca**  
vintage



**la limousine**  
limousine

la stazione di servizio • gas station

la pompa  
di benzina  
gas pump

il prezzo  
price



l'area di stazionamento  
forecourt

il distributore di  
aria compressa  
air supply

vocabolario • vocabulary

l'olio  
oil

piombata  
leaded

l'autolavaggio  
car wash

la benzina  
gaoline

il diesel  
diesel

l'antigelo  
antifreeze

senza  
piombo  
unleaded

il garage  
garage

il detegente  
per vetri  
screenwash

**Il pieno per favore.**  
Fill it up, please.

# l'automobile 2 • car 2

## l'interno • interior



### vocabolario • vocabulary

**a due porte**  
two-door

**a quattro porte**  
four-door

**automatico**  
automatic

**il freno**  
brake

**l'acceleratore**  
accelerator

**a tre porte**  
hatchback

**manuale**  
manual

**l'accensione**  
ignition

**la frizione**  
clutch

**l'aria condizionata**  
air conditioning

**Può indicarmi la strada per...?**  
Can you tell me the way to...?

**Dov'è il parcheggio?**  
Where is the parking lot?

**Posso parcheggiare qui?**  
Can I park here?

## i comandi • controls

**il volante**  
steering  
wheel

**il clacson**  
horn

**il cruscotto**  
dashboard

**le luci intermittenti**  
hazard lights

**la navigazione via satellite**  
satellite navigation



la guida a sinistra | left-hand drive

**la spia della temperatura**  
temperature gauge

**il contagiri**  
tachometer

**il contachilometri**  
speedometer

**la spia del carburante**  
fuel gauge

**l'autoradio**  
car stereo

**l'interruttore per le luci**  
light switch

**i comandi per il riscaldamento**  
heater controls

**l'odometro**  
odometer

**la leva del cambio**  
gearstick

**l'airbag**  
air bag



la guida a destra | right-hand drive

# l'automobile 3 • car 3

## la meccanica • mechanics

il serbatoio del  
liquido lavavetri  
screen wash reservoir

l'indicatore di  
livello dell'olio  
dipstick

il filtro  
dell'aria  
air filter

il serbatoio del  
liquido per i freni  
brake fluid reservoir

la batteria  
battery

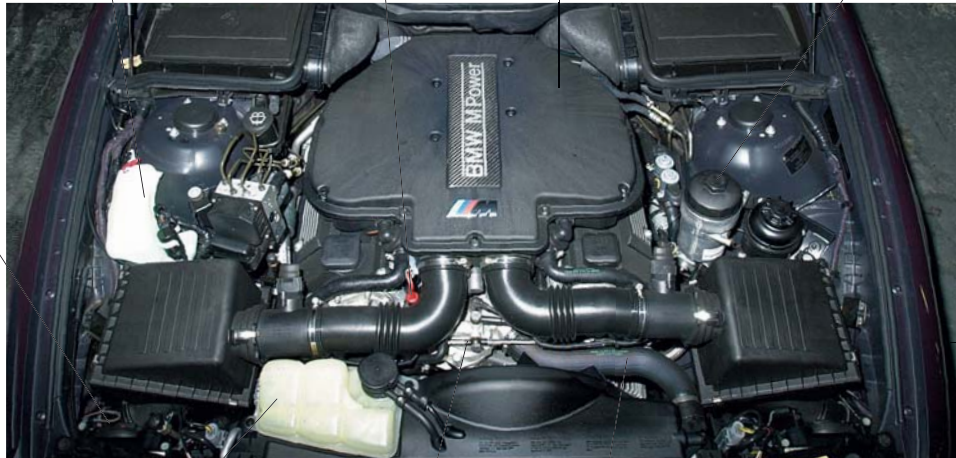

la  
carrozzeria  
bodywork

il serbatoio per il  
liquido refrigerante  
coolant reservoir

la testa  
del cilindro  
cylinder head

il tubo  
pipe

il tettuccio  
sunroof

il radiatore  
radiator

il ventilatore  
fan

il motore  
engine

il coprimozzo  
hubcap

la scatola  
del cambio  
gearbox

la trasmissione  
transmission

l'albero di  
trasmissione  
driveshaft

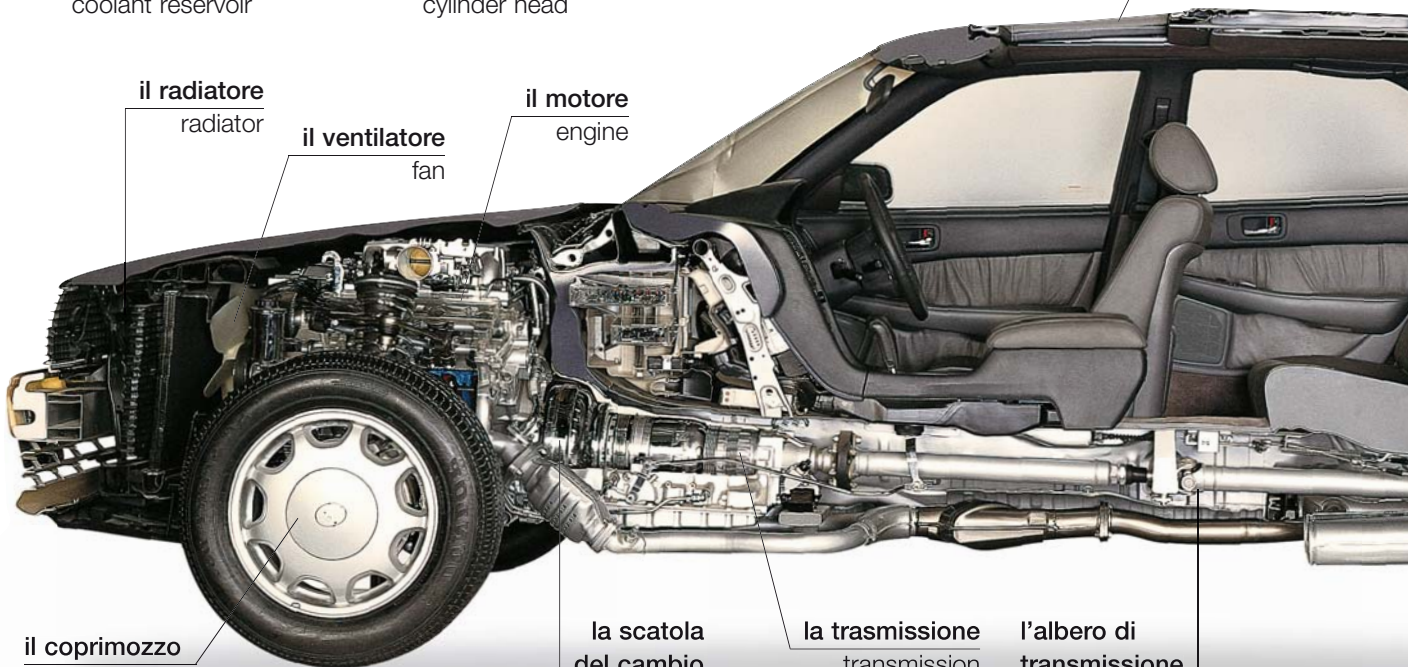

## la foratura • flat tire

la ruota di scorta  
spare tire

la chiave  
tire iron

i bulloni della ruota  
wheel nuts

il cric  
jack

cambiare una ruota  
change a tire (v)

il tetto  
roof

la sospensione  
suspension

il silenziatore  
muffler

il tubo di scappamento  
exhaust pipe

## vocabolario • vocabulary

l'incidente stradale  
car accident

il turbocompressore  
turbocharger

la panne  
breakdown

il distributore  
distributor

l'assicurazione  
insurance

la messa in fase  
timing

il carro attrezzi  
tow truck

il telaio  
chassis

il meccanico  
mechanic

il freno a mano  
parking brake

la candela  
spark plug

l'alternatore  
alternator

la scatola dei  
fusibili  
fuse box

la cinghia della  
camma  
cam belt

la pressione dei  
pneumatici  
tire pressure

Sono in panne.  
My car has broken  
down.

la cinghia della  
ventola  
fan belt

La mia macchina  
non parte.  
My car won't start.

il serbatoio della  
benzina  
gas tank

# la motocicletta • motorcycle

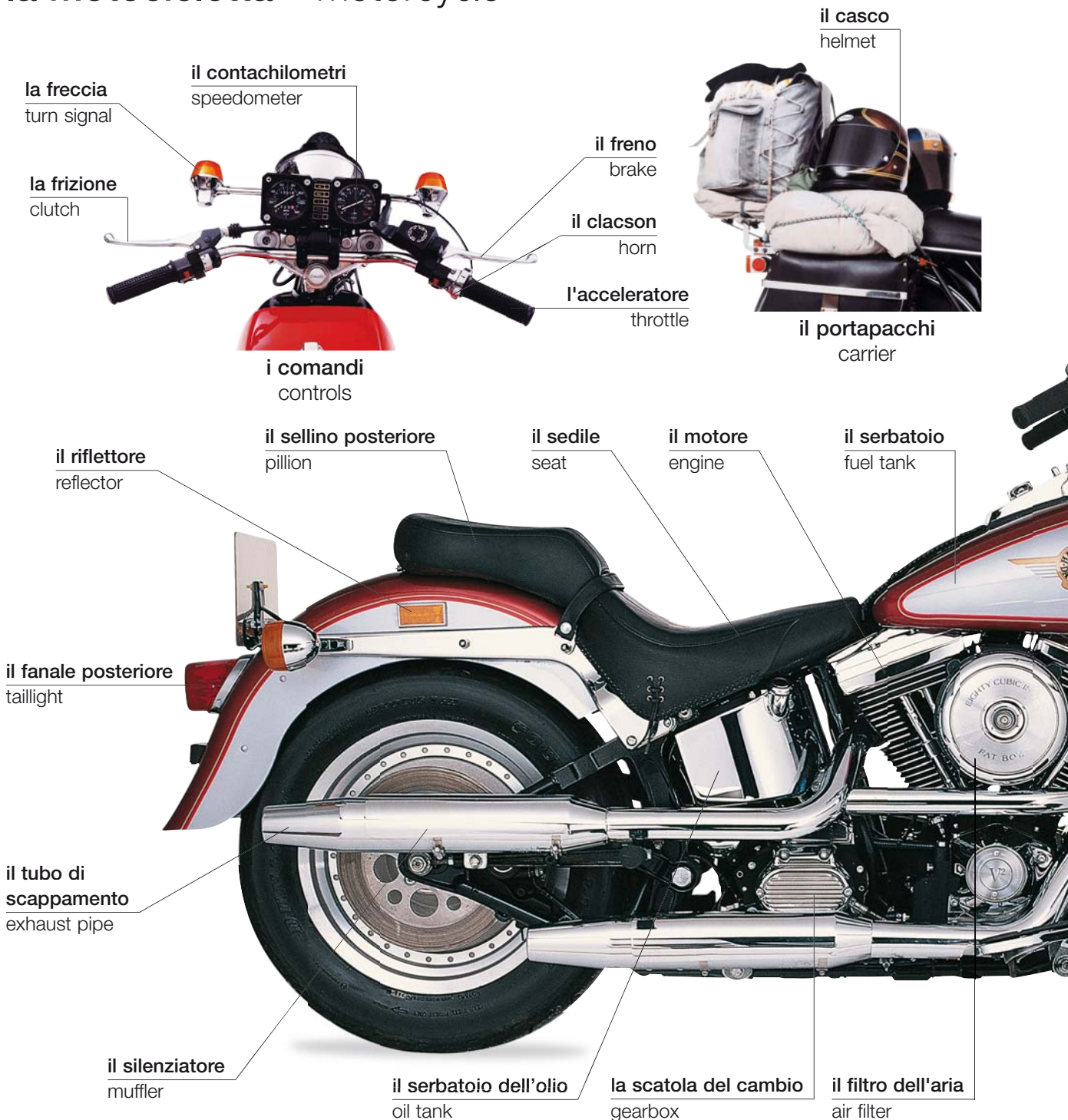

i tipi • types



la visiera  
visor

la tuta di pelle  
leathers

la fascia  
rifrangente  
reflector strap

il paraginocchio  
knee pad

l'abbigliamento | clothing

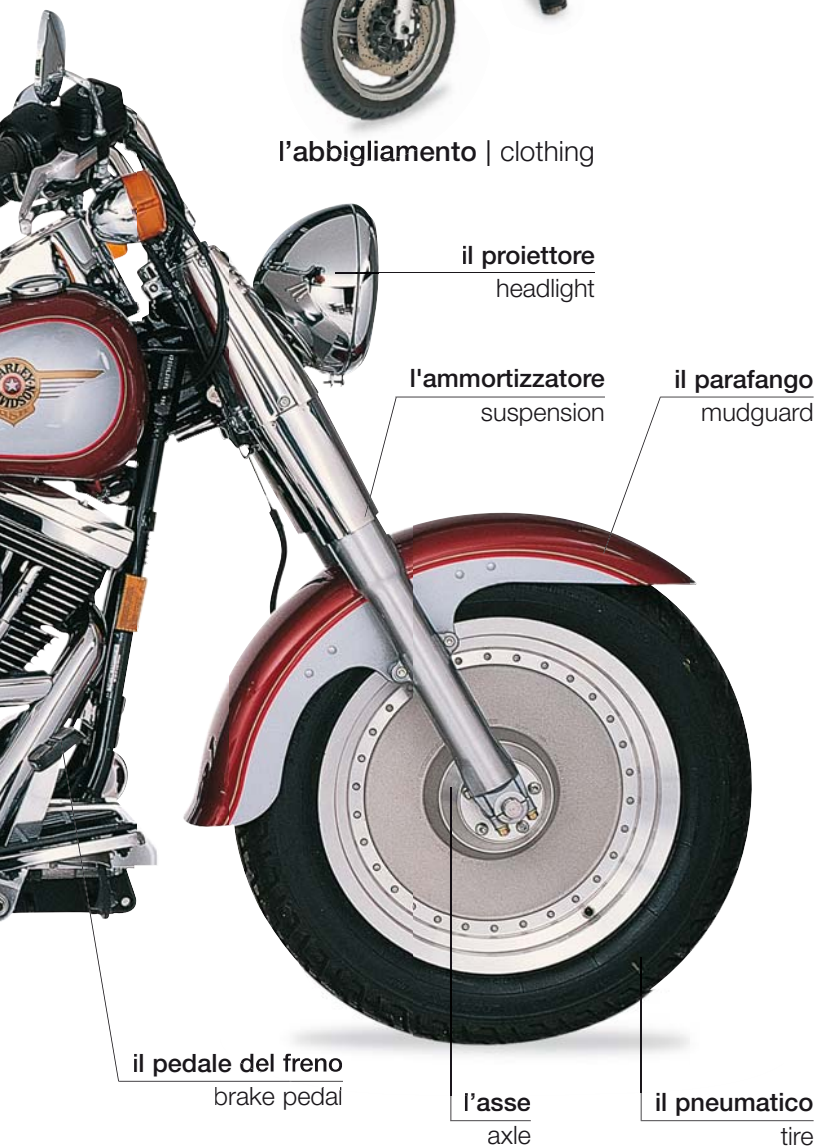

il proiettore  
headlight

l'ammortizzatore  
suspension

il parafango  
mudguard

il pedale del freno  
brake pedal

l'asse  
axle

il pneumatico  
tire



la moto da corsa | racing bike

il parabrezza  
windshield



la moto da turismo | tourer



la moto da cross | dirt bike

il cavalletto  
stand



la vespa | scooter

# la bicicletta • bicycle



**il tandem**  
tandem



**la bicicletta da corsa**  
racing bike



**la mountain bike**  
mountain bike



**la bicicletta da turismo**  
touring bike



**la bicicletta da strada**  
road bike

**il sellino**  
saddle

**il tubo reggisella**  
seat post

**la borraccia**  
water bottle

**il telaio**  
frame

**il freno**  
brake

**il mozzo**  
hub

**le marce**  
gears

**il cerchione**  
rim

**il pneumatico**  
tire

**la catena**  
chain

**il pedale**  
pedal

**la ruota dentata**  
cog

**le casque**  
helmet



**la pista ciclabile | cycle lane**





**vocabolario • vocabulary**

<b>il dente</b> sprocket	<b>il cavalletto</b> kickstand	<b>il blocca freni</b> brake block	<b>il cestello</b> basket	<b>il fermapiedi</b> toe clip	<b>cambiare marcia</b> change gears (v)
<b>il fanale</b> headlight	<b>le rotelle</b> training wheels	<b>il cavo</b> cable	<b>la dinamo</b> dynamo	<b>il cinghietto</b> toe strap	<b>frenare</b> brake (v)
<b>il fanale posteriore</b> rear light	<b>il posteggio per bici</b> bike rack	<b>il catarifrangente</b> reflector	<b>la foratura</b> flat tire	<b>pedalare</b> pedal (v)	<b>andare in bici</b> cycle (v)

# il treno • train

il vagone  
car

il binario  
platform

il carrello  
car



il numero del  
binario  
platform number

il pendolare  
commuter

la stazione ferroviaria | train station

## i tipi di treno • types of train



il treno a vapore  
steam train

la locomotiva  
engine



il treno diesel | diesel train

la cabina del  
conducente  
engineer's cab

la rotaia  
rail



il treno elettrico  
electric train



il treno ad alta velocità  
high-speed train



la monorotaia  
monorail



la metropolitana  
subway



il tram  
tram



il treno merci  
freight train



**lo scompartimento**  
compartment

**il sistema di altoparlanti**  
public address system

**l'orario**  
schedule

**il portabagagli**  
luggage rack

**il finestrino**  
window

**la porta**  
door

**il binario**  
track

**il sedile**  
seat



**la barriera**  
ticket gate



**il biglietto**  
ticket



**il vagone ristorante | dining car**



**l'atrio | concourse**



**lo scompartimento a cuccette**  
sleeping compartment

**vocabolario • vocabulary**

**la rete ferroviaria**  
rail network

**il ritardo**  
delay

**la biglietteria**  
ticket office

**il binario elettrificato**  
live rail

**il treno intercity**  
express train

**la tariffa**  
fare

**il controllore**  
ticket inspector

**il segnale**  
signal

**l'ora di punta**  
rush hour

**la mappa della metropolitana**  
subway map

**cambiare**  
change (v)

**la leva di emergenza**  
emergency lever

# l'aeroplano • aircraft

## l'aereo di linea • airliner



## la cabina • cabin





**la mongolfiera**  
hot-air balloon



**l'aereo biposto**  
ultralight



**l'aliante**  
glider



**il biplano**  
biplane

**l'elica**  
propeller



**l'aereo da diporto**  
light aircraft



**l'idrovolante**  
sea plane



**l'aereo privato**  
private jet

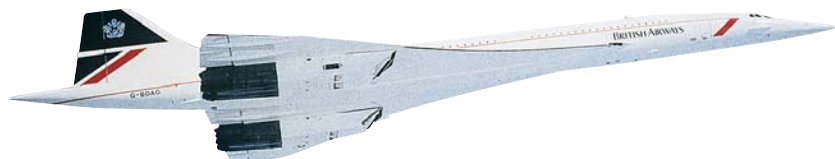

**l'aereo supersonico**  
supersonic jet

**la lama rotante**  
rotor blade



**l'elicottero**  
helicopter



**il bombardiere**  
bomber



**l'aereo da caccia**  
fighter plane

**il missile**  
missile

**vocabolario** • vocabulary

**il pilota**  
pilot

**decollare**  
take off (v)

**atterrare**  
land (v)

**la classe economica**  
economy class

**il bagaglio a mano**  
carry-on luggage

**il copilota**  
copilot

**volare**  
fly (v)

**la quota**  
altitude

**la business class**  
business class

**la cintura di sicurezza**  
seat belt

# l'aeroporto • airport



l'area di stazionamento  
apron

il carrello portabagagli  
baggage trailer

il terminale  
terminal

il veicolo di servizio  
service vehicle

il passaggio pedonale  
walkway

l'aereo di linea | airliner

## vocabolario • vocabulary

la pista  
runway

il numero del volo  
flight number

il nastro trasportatore  
carousel

la vacanza  
vacation

la coincidenza  
connection

il controllo passaporti  
immigration

la sicurezza  
security

prenotare un volo  
book a flight (v)

il volo nazionale  
domestic flight

la dogana  
customs

l'apparecchio a raggi x  
X-ray machine

fare il check-in  
check in (v)

il volo  
internazionale  
international flight

il bagaglio in  
eccedenza  
excess baggage

l'opuscolo vacanze  
travel brochure

la torre di controllo  
control tower

il bagaglio  
a mano  
carry-on  
luggage

il bagaglio  
luggage

il carrello  
cart



il banco accettazione  
check-in desk



il passaporto | passport

il visto  
visa

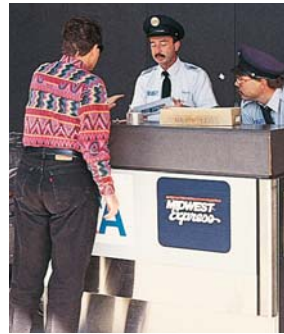

il controllo passaporti  
passport control

la carta  
d'imbarco  
boarding pass



il biglietto  
ticket



la sala delle partenze  
departure lounge

il numero  
dell'uscita  
gate number

le partenze  
departures



il pannello degli orari  
information screen

la  
destinazione  
destination

gli arrivi  
arrivals

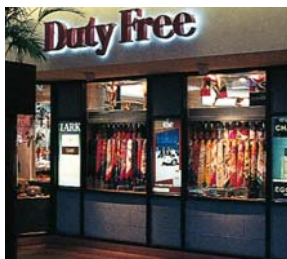

il negozio duty free  
duty-free shop

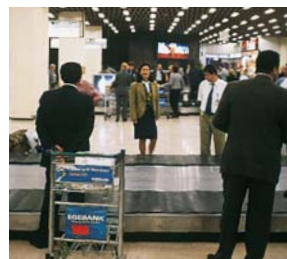

il ricupero bagagli  
baggage claim



il posteggio dei taxi  
taxi stand



l'autonoleggio  
car rental

# la nave • ship

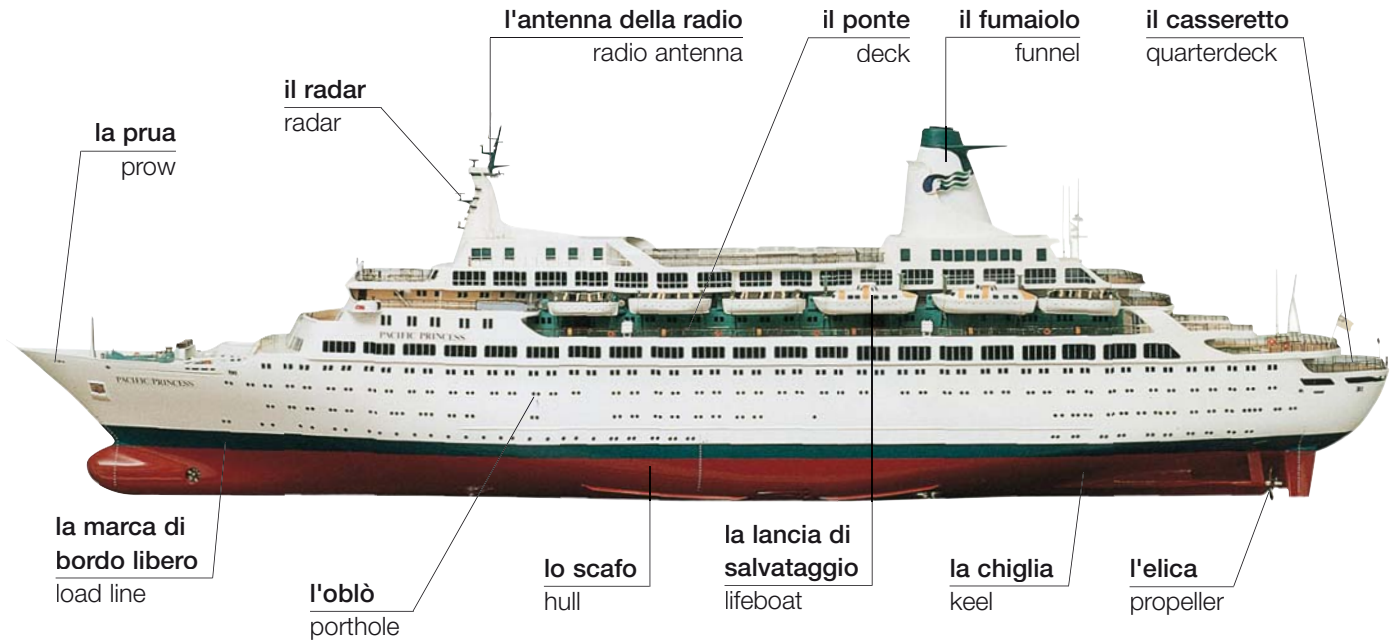

**la nave da crociera**  
ocean liner



**il ponte di comando**  
bridge



**la sala macchine**  
engine room



**la cabina**  
cabin

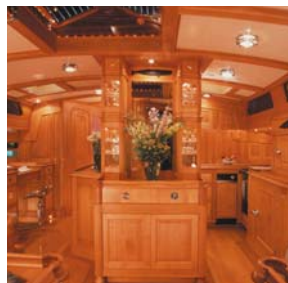

**la cucina di bordo**  
galley

## vocabolario • vocabulary

**il bacino**  
dock

**il mulinello**  
windlass

**il porto**  
port

**il capitano**  
captain

**la passerella**  
gangway

**il motoscafo**  
speedboat

**l'ancora**  
anchor

**la barca a remi**  
rowboat

**la colonna d'ormeggio**  
bollard

**la canoa**  
canoe



altre imbarcazioni • other ships



**il traghetto**  
ferry

**il motore fuoribordo**  
outboard motor



**il gommone**  
inflatable dinghy



**l'aliscafo**  
hydrofoil



**lo yacht**  
yacht



**il catamarano**  
catamaran



**il rimorchiatore**  
tugboat



**l'hovercraft**  
hovercraft



**la nave porta container**  
container ship

**il sartame**  
rigging



**la barca a vela**  
sailboat

**la stiva**  
hold



**la nave da trasporto**  
freighter



**la petroliera**  
oil tanker



**la portaerei**  
aircraft carrier



**la nave da guerra**  
battleship

**la torretta di comando**  
conning tower



**il sottomarino**  
submarine

# il porto • port

**il magazzino**  
warehouse

**la gru**  
crane

**il carrello elevatore**  
forklift truck

**la strada di accesso**  
access road

**l'ufficio della dogana**  
customs house



**il bacino**  
dock

**il container**  
container

**la banchina**  
dock

**il carico**  
cargo



**il porto per container** | container port

**il terminale dei traghetti**  
ferry terminal

**il traghetto**  
ferry

**la biglietteria**  
ticket office

**il passeggero**  
passenger

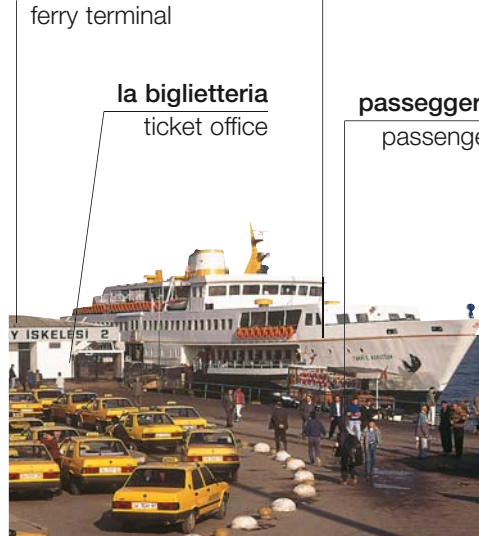

**il porto per passeggeri** | passenger port

la rete  
net

la barca da pesca  
fishing boat

l'ormeggio  
mooring



il porto turistico  
marina



il porto  
harbor

il porto da pesca  
fishing port



il pontile  
pier



il molo  
jetty



il cantiere navale  
shipyard



il faro  
lighthouse

la luce  
lamp



la boa  
buoy

**vocabolario • vocabulary**

**il guardacoste**  
coastguard

**mollare l'ancora**  
drop anchor (v)

**imbarcare**  
board (v)

**il capitano di porto**  
harbor master

**ormeggiare**  
moor (v)

**sbarcare**  
disembark (v)

**il bacino di carenaggio**  
dry dock

**entrare in bacino**  
dock (v)

**salpare**  
set sail (v)



PRESSION

ULTRA  
3

DUNLOP  
DHD III  
4

ULTRA  
3

DUNLOP

TOUR  
EDITION  
1

ProStaff  
4

CANYON SPRINGS  
GOLF CLUB

ProStaff  
4

TOP-FLITE  
HOT XL  
4

RAM TOUR  
1

MAX FLI  
3

DISTANCE

TOP-FLITE  
STRATA  
3

ProStaff



gli sport  
sports

# il football americano • football

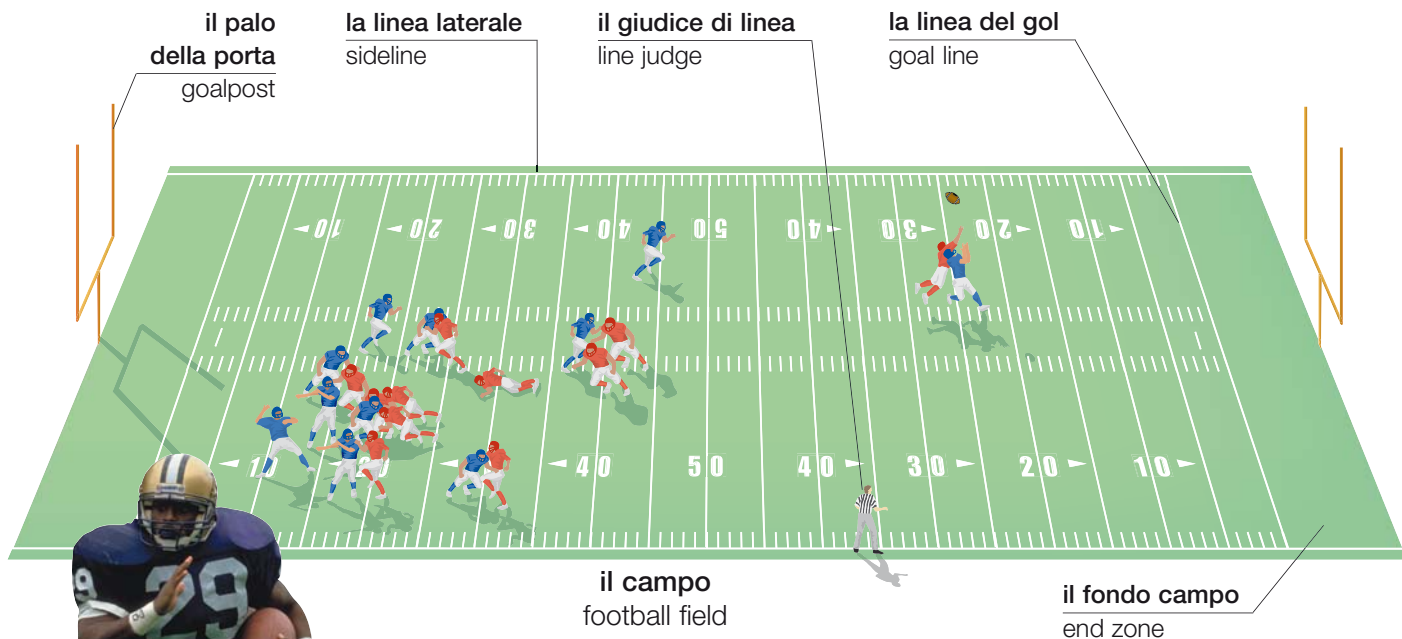

**il pallone**  
football

**le ginocchiere**  
pads

**il casco**  
helmet

**lo scarpino**  
shoe



**placcare**  
tackle (v)



**passare**  
pass (v)



**prendere**  
catch (v)

**il giocatore**  
football player

## vocabolario • vocabulary

**il time-out**  
time out

**la squadra**  
team

**la difesa**  
defense

**la cheerleader**  
cheerleader

**A quanto stanno?**  
What is the score?

**il fumble**  
fumble

**l'attacco**  
attack

**il punteggio**  
score

**il touch-down**  
touchdown

**Chi vince?**  
Who is winning?

# il rugby • rugby

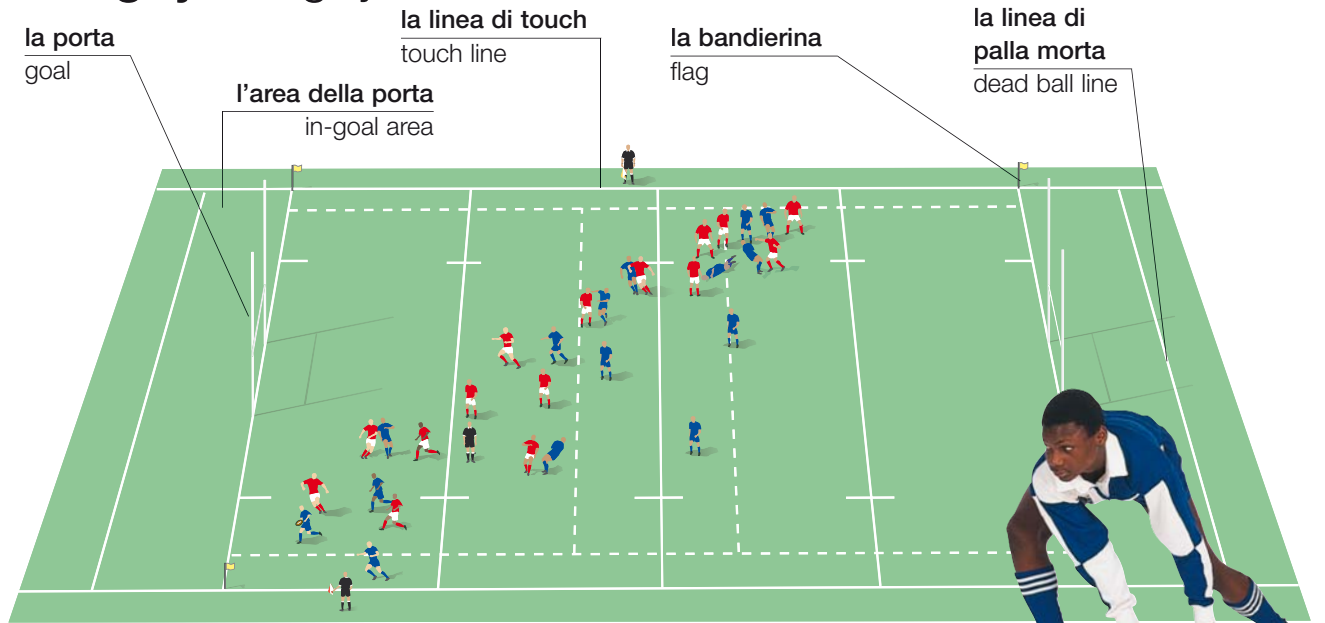

il campo | rugby field



tirare  
throw (v)

il pallone  
ball



calciare  
kick (v)

la camicetta  
da rugby  
rugby uniform



passare  
pass (v)



placcare  
tackle (v)



la meta  
try

il giocatore  
player



il ruck | ruck



la mischia | scrum

# il calcio • SOCCER



il pallone  
soccer ball

la divisa  
soccer  
uniform

il calciatore  
soccer player

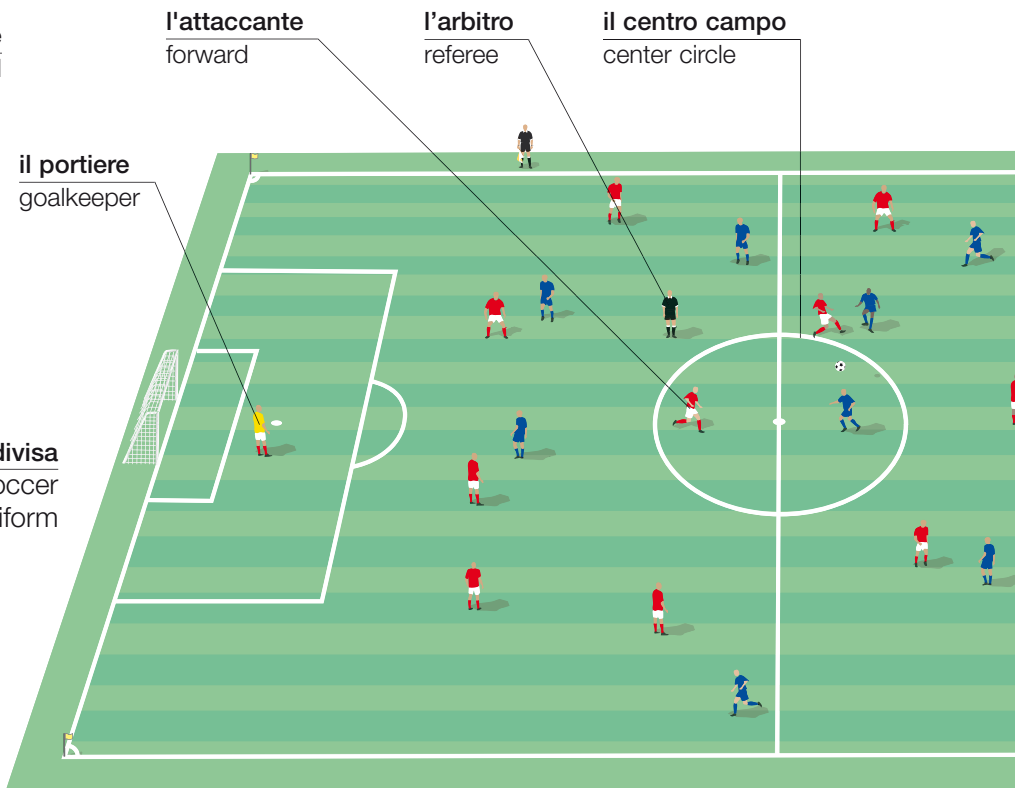

l'attaccante  
forward

l'arbitro  
referee

il centro campo  
center circle

il portiere  
goalkeeper



il palo  
goalpost

la rete  
net

la traversa  
crossbar

il gol | goal



il campo di calcio  
soccer field

palleggiare | dribble (v)

colpire di testa  
head (v)



il muro  
wall

il calcio di punizione | free kick



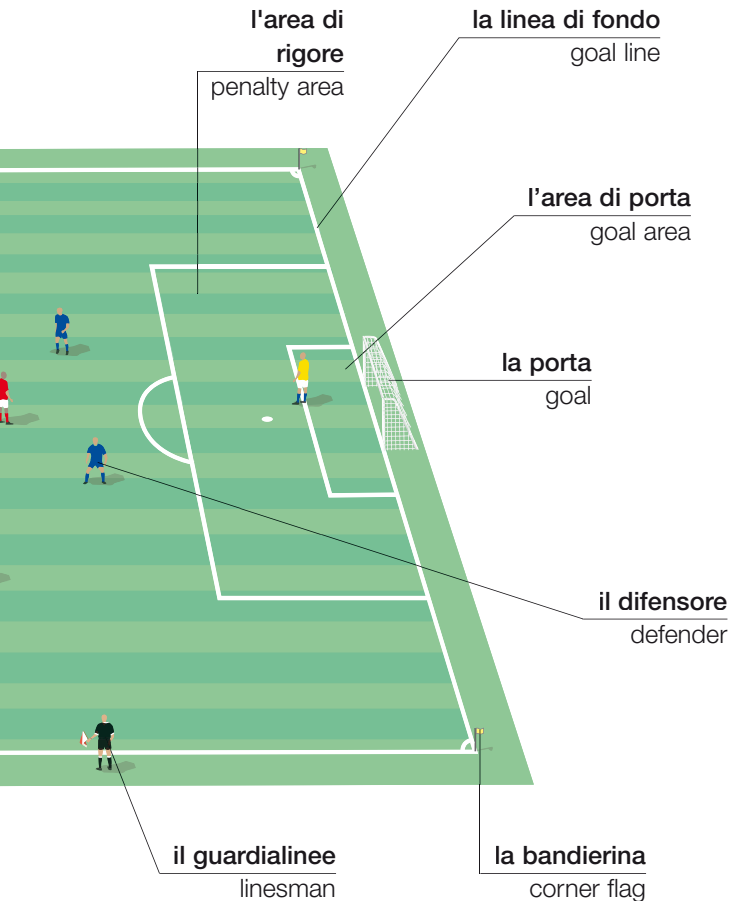

**la rimessa in gioco**  
throw-in



**calciare**  
kick (v)



**passare**  
pass (v)



**tirare | shoot** (v)



**parare**  
save (v)



**contrastare**  
tackle (v)

**vocabolario** • vocabulary

**lo stadio**  
stadium

**il fallo**  
foul

**il cartellino giallo**  
yellow card

**il campionato**  
league

**il sostituto**  
substitute

**segnare**  
score a goal (v)

**il calcio d'angolo**  
corner

**il fuorigioco**  
off-side

**il pareggio**  
tie

**la sostituzione**  
substitution

**il rigore**  
penalty

**il cartellino rosso**  
red card

**l'espulsione**  
send off

**l'intervallo**  
half time

**il tempo  
supplementare**  
extra time

# I'hockey • hockey

## I'hockey su ghiaccio • ice hockey



## I'hockey sull'erba • field hockey

la mazza da hockey  
hockey stick



il dischetto  
puck

il giocatore di hockey su ghiaccio  
ice hockey player

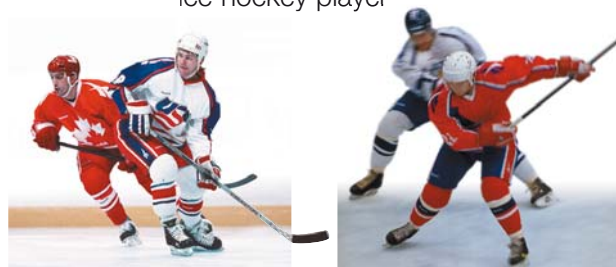

pattinare  
skate (v)

colpire  
hit (v)

# il cricket • cricket

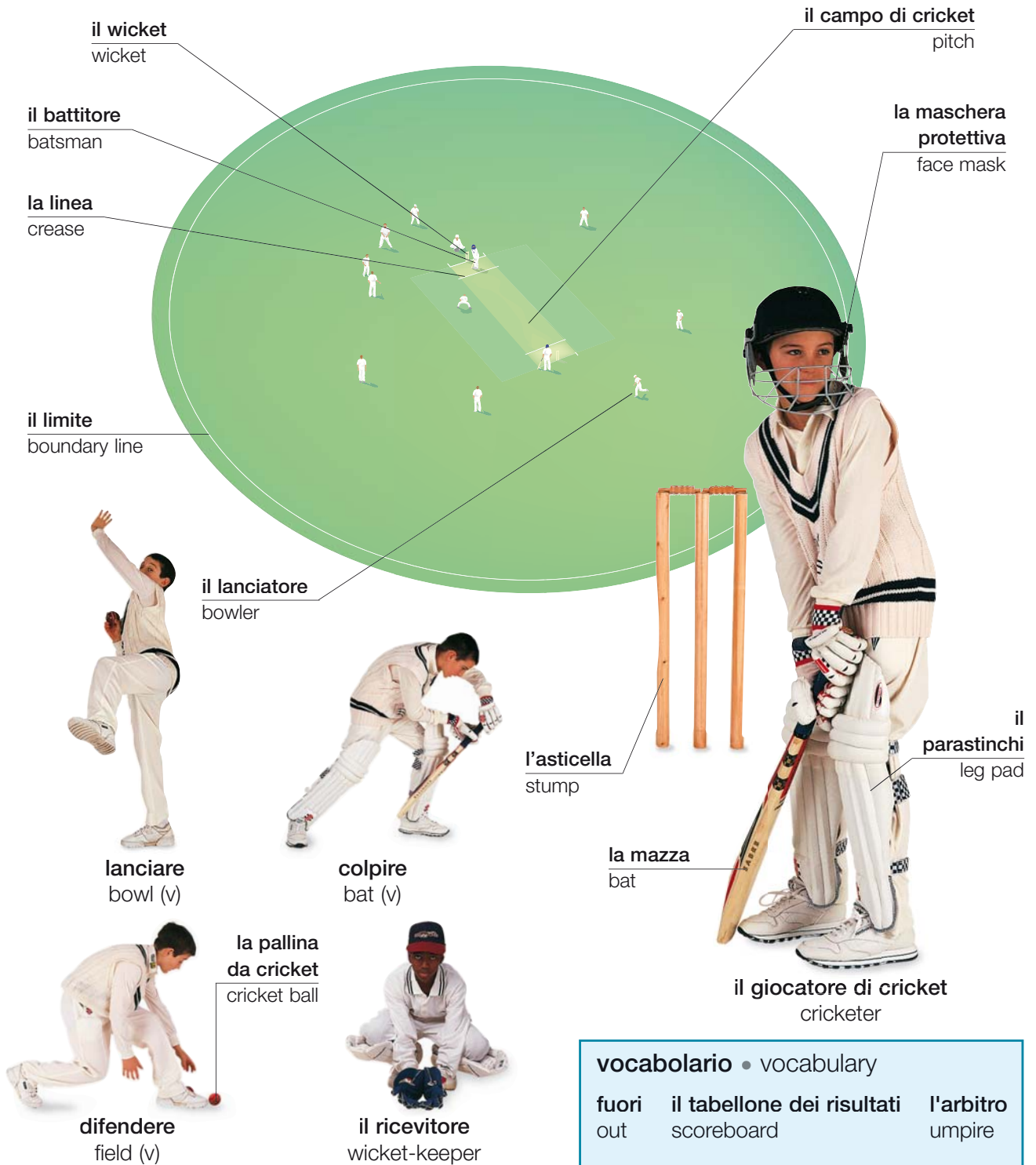

vocabolario • vocabulary		
<b>fuori</b> out	<b>il tabellone dei risultati</b> scoreboard	<b>l'arbitro</b> umpire

# la pallacanestro • basketball

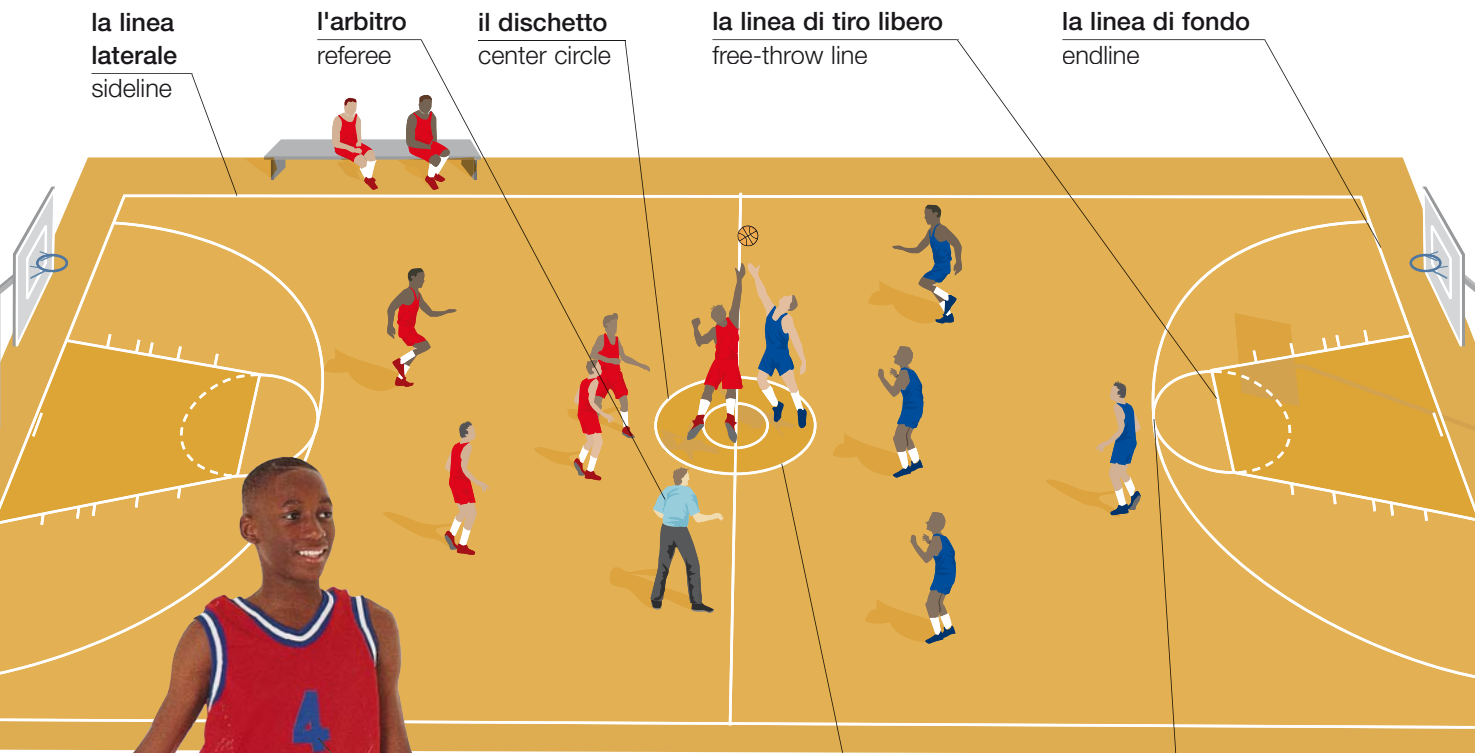

**il campo**  
court

**la linea di centro**  
centerline

**la linea dei tre punti**  
three-point line

**il numero**  
number

**il tabellone**  
backboard

**il pallone**  
ball

**l'anello**  
hoop

**la rete**  
net

**il canestro**  
basket

<b>vocabolario •</b> vocabulary	
<b>il fallo</b> foul	<b>la rimessa</b> throw-in
<b>il rimbalzo</b> rebound	<b>fuori campo</b> out of bounds
<b>il passaggio</b> pass	<b>il tiro in sospensione</b> jump ball

**il giocatore di pallacanestro** | basketball player

le azioni • actions



**tirare**  
throw (v)



**acchiappare**  
catch (v)



**tirare**  
shoot (v)



**saltare**  
jump (v)



**segnare**  
dunk (v)



**marcare**  
mark (v)



**bloccare**  
block (v)



**rimbalzare**  
dribble (v)



**segnare**  
dunk (v)

la pallavolo • volleyball

**contrastare**  
block (v)

**la rete**  
net

**difendere**  
dig (v)

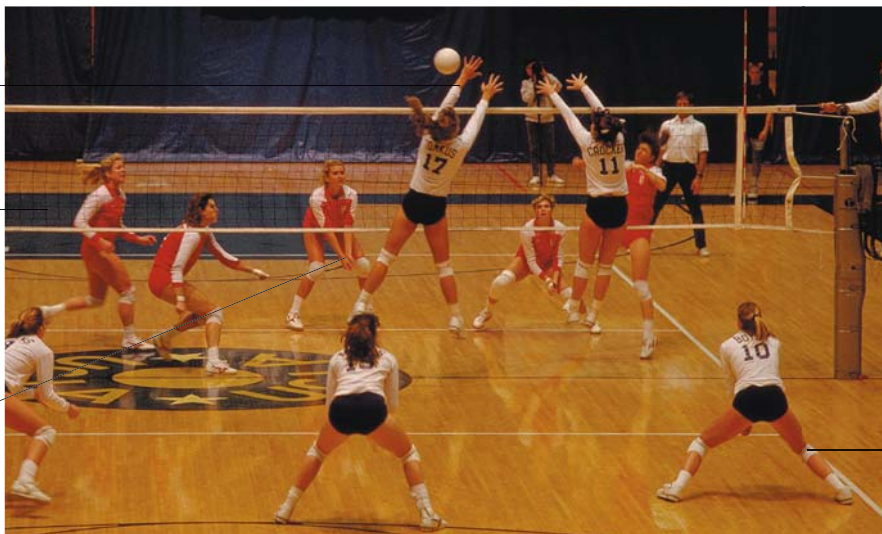

**l'arbitro**  
referee

**la ginocchiera**  
knee support

**il campo** | court

# il baseball • baseball

## il campo • field

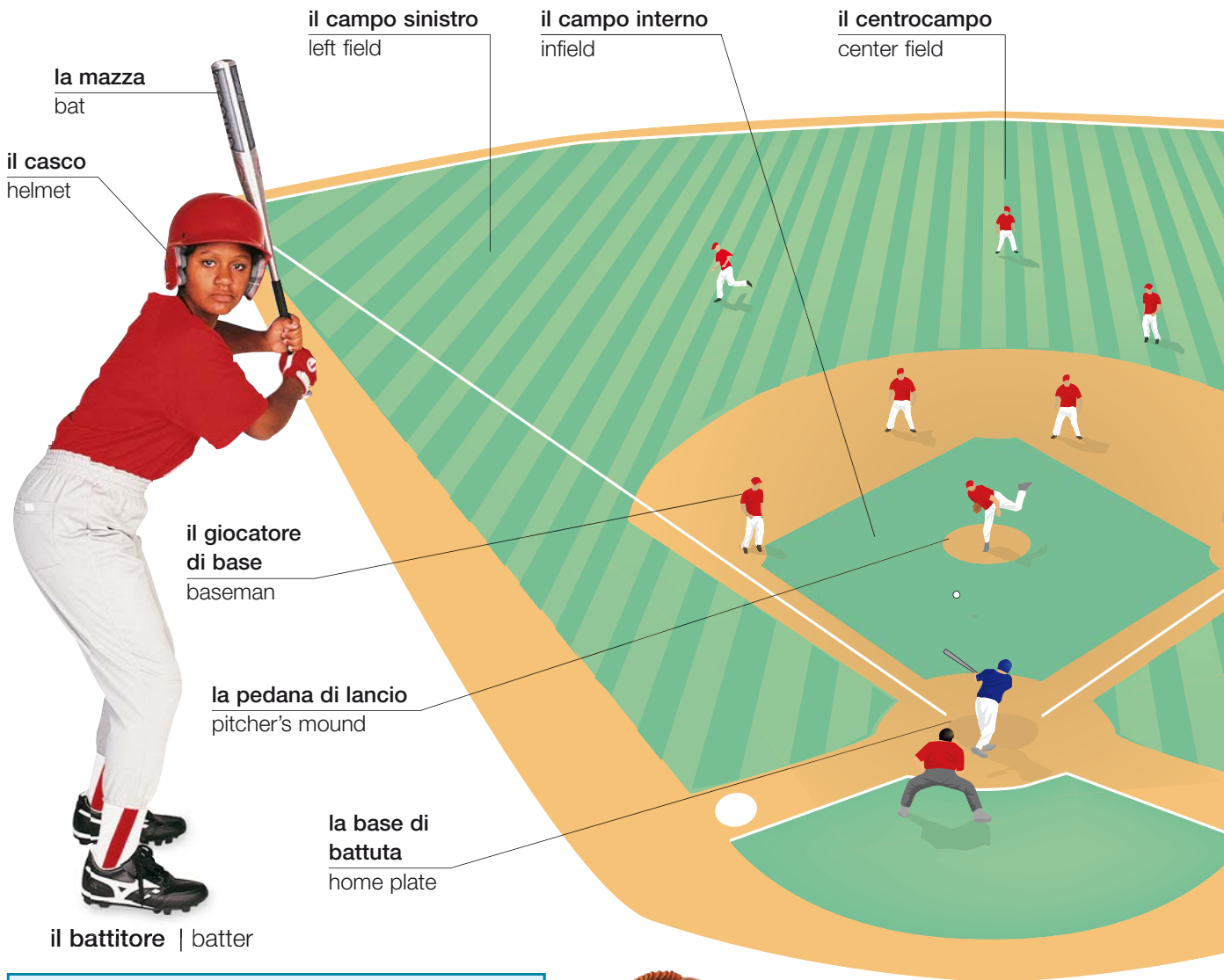

### vocabolario • vocabulary

**il turno di battuta**  
inning

**salvo**  
safe

**lo strike**  
strike

**il giro**  
run

**fuori**  
out

**il fallo**  
foul ball



**il guantone**  
mitt

**la palla**  
ball



**la maschera**  
mask

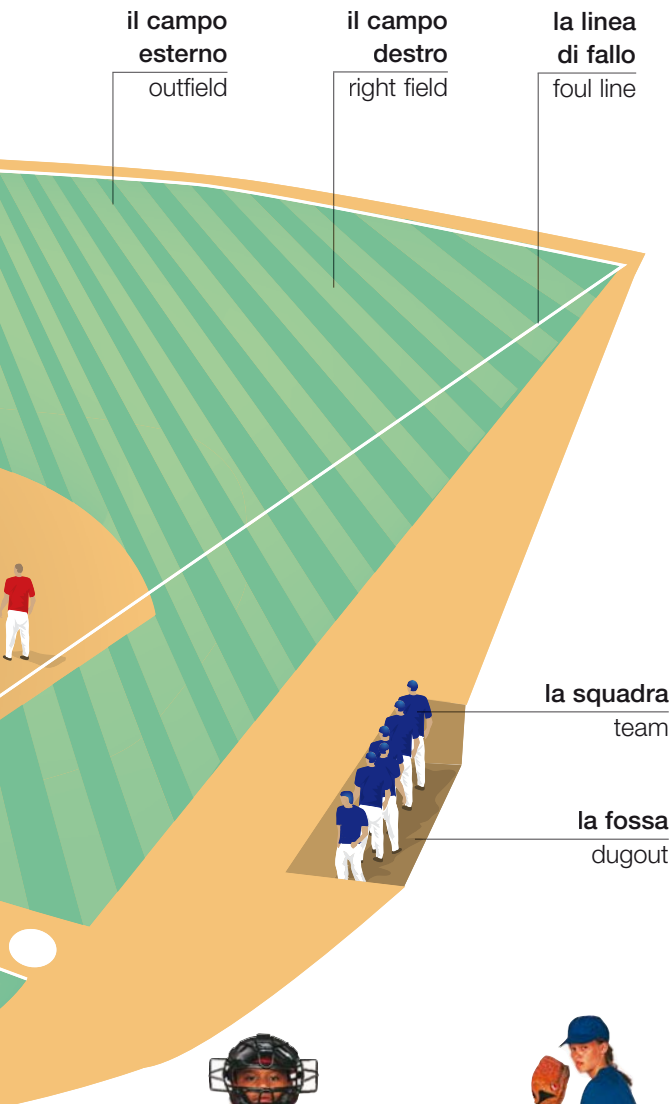

il ricevitore  
catcher



il pitcher  
pitcher

## le azioni • actions



lanciare | throw (v)



acchiappare | catch (v)



correre  
run (v)



difendere  
field (v)



scivolare  
slide (v)

inseguire  
tag (v)

servire  
pitch (v)

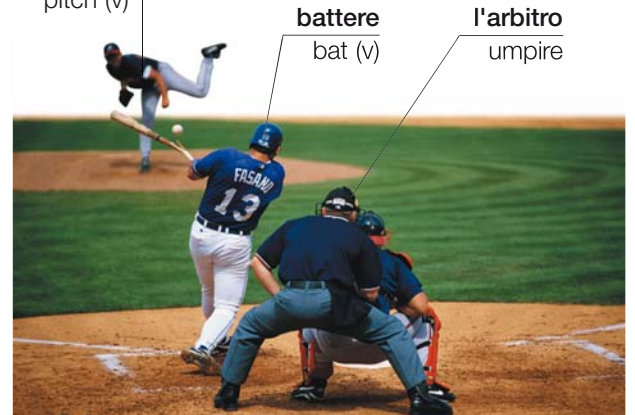

battere  
bat (v)

l'arbitro  
umpire

giocare | play (v)

# il tennis • tennis

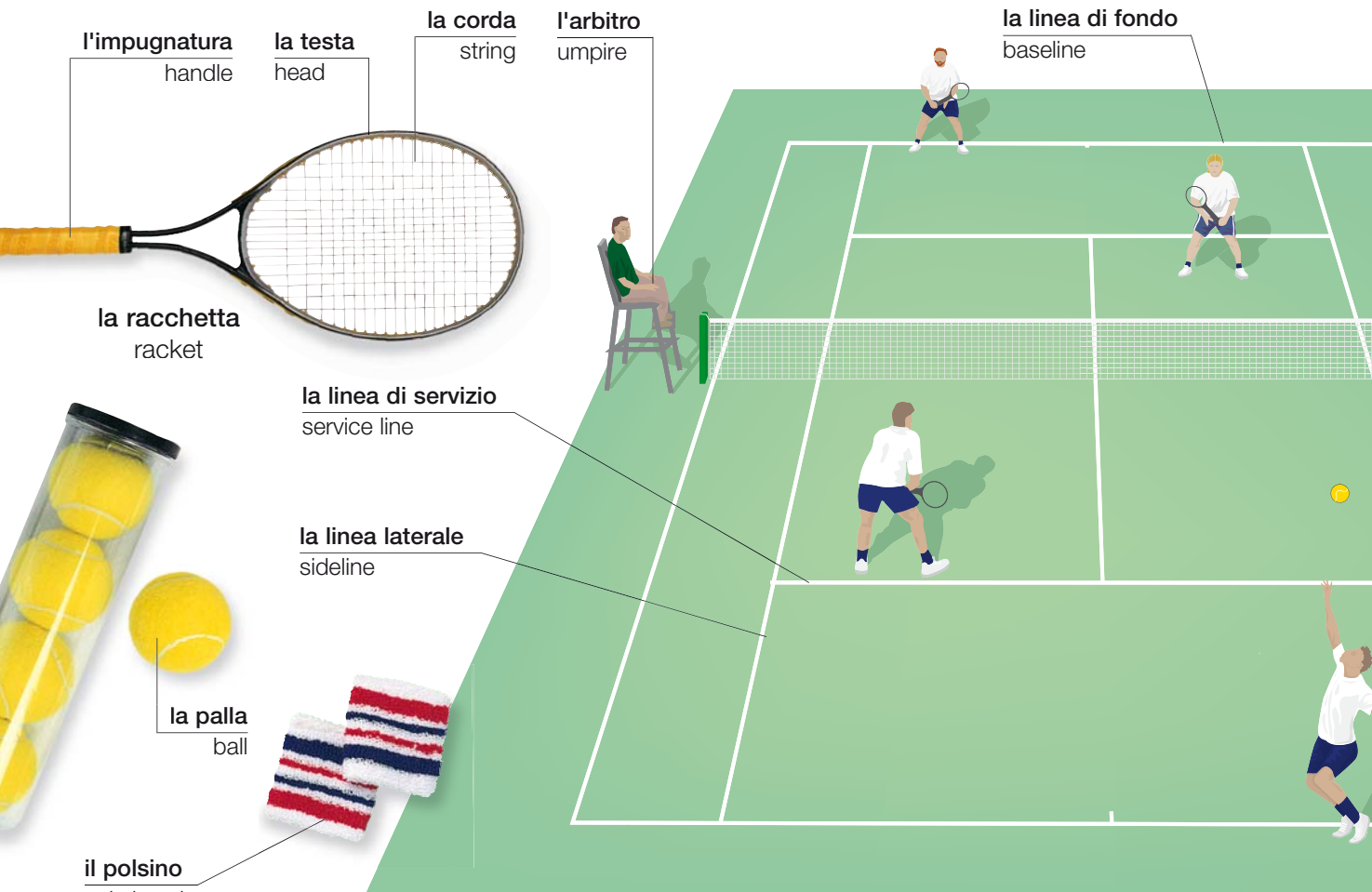

il campo | tennis court

## vocabolario • vocabulary

**il singolare**  
singles

**il set**  
set

**il deuce**  
deuce

**il fallo**  
fault

**il taglio**  
slice

**l'avvitamento**  
spin

**il doppio**  
doubles

**la partita**  
match

**il vantaggio**  
advantage

**l'asso**  
ace

**il palleggio**  
rally

**il campionato**  
championship

**il gioco**  
game

**il tiebreak**  
tiebreaker

**a zero**  
love

**la smorzata**  
dropshot

**colpo nullo!**  
let!

**il giudice di  
linea**  
linesman



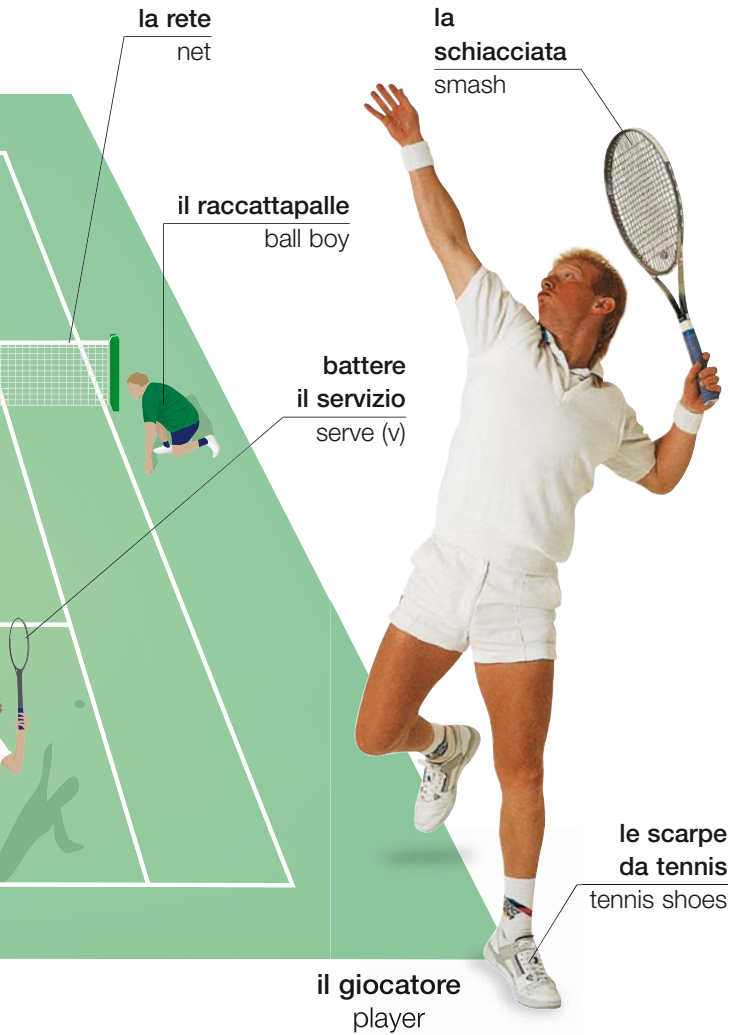

**i colpi • strokes**

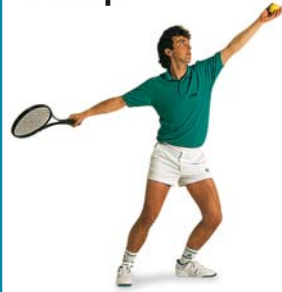

**il servizio**  
serve



**il palleggio**  
volley



**il ritorno**  
return



**la schiacciata**  
lob



**il dritto**  
forehand



**il rovescio**  
backhand

**i giochi con la racchetta • racket games**



**il badminton**  
badminton

**il volano**  
shuttlecock



**il ping pong**  
table tennis

**la racchetta**  
paddle



**lo squash**  
squash



**il racquetball**  
racquetball

# il golf • golf



la buca  
hole

il teeing-ground  
teeing ground

il green  
green

il bunker  
bunker

la bandierina  
flag

fare lo swing  
swing (v)

il fairway  
fairway

il rough  
rough

lo stagno  
water hazard

il campo di golf  
golf course

il buggy  
golf cart

la posizione  
stance

il golfista | golfer

la sede del circolo | clubhouse

## le attrezzature • equipment



## le mazze da golf • golf clubs



## le azioni • actions



## vocabolario • vocabulary

il par  
par

l'overpar  
over par

l'handicap  
handicap

il caddy  
caddy

il colpo  
stroke

il back-swing  
backswing

l'underpar  
under par

la buca in uno  
hole in one

il torneo  
tournament

gli spettatori  
spectators

lo swing di pratica  
practice swing

la linea di gioco  
line of play

# l'atletica • track and field

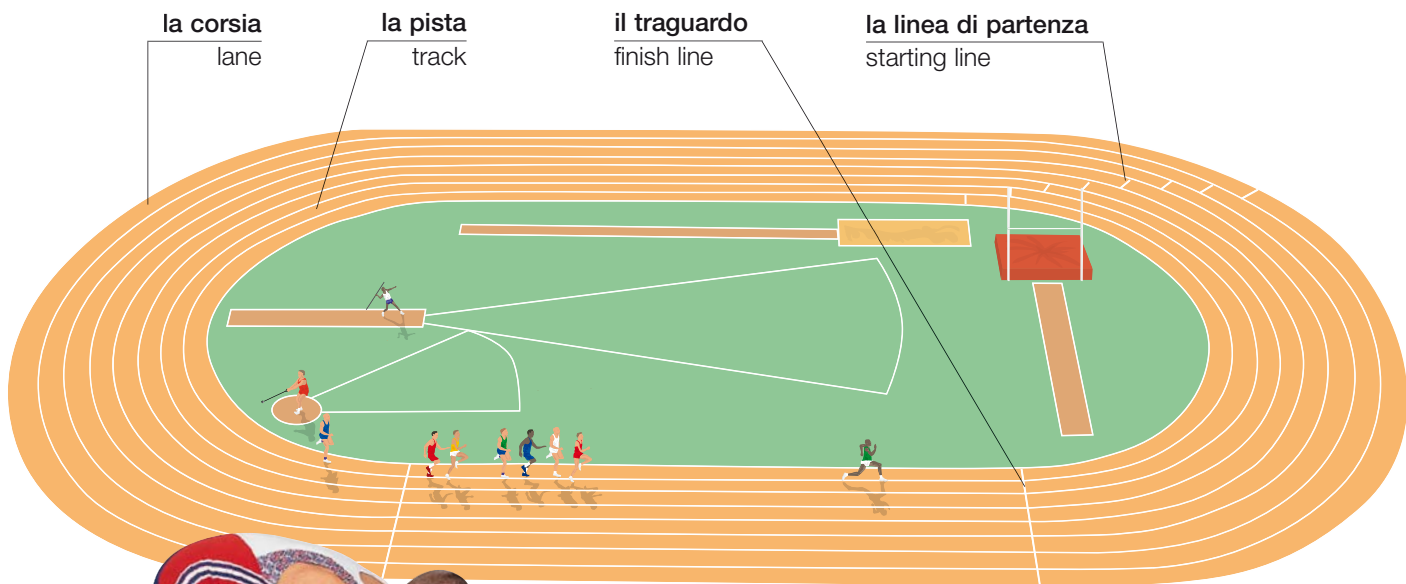

la pedana  
di partenza  
starting  
blocks

il velocista  
sprinter



il lancio del disco  
discus

l'atleta  
athlete



il lancio del peso  
shotput



il lancio del giavellotto  
javelin

il campo  
field

## vocabolario • vocabulary

la gara  
race

il primato  
record

il fotofinish  
photo finish

il salto con l'asta  
pole vault

il tempo  
time

battere un  
primato  
break a record (v)

la maratona  
marathon

il primato  
personale  
personal best



il cronometro  
stopwatch

**il testimone**  
baton



**la staffetta**  
relay race

**la sbarra**  
crossbar



**il salto in alto**  
high jump



**il salto in lungo**  
long jump



**la corsa a ostacoli**  
hurdles

## la ginnastica • gymnastics



**il cavallo**  
horse

**il salto**  
vault

**la pedana elastica**  
springboard



**la capriola**  
somersault



**la pedana**  
mat

**la ginnastica a corpo libero**  
floor exercises

**la ginnasta**  
gymnast



**la trave**  
beam

**il nastro**  
ribbon



**la ruota**  
tumble

**la ginnastica ritmica**  
rhythmic gymnastics

## vocabolario • vocabulary

**la sbarra**  
horizontal bar

**le sbarre asimmetriche**  
asymmetric bars

**gli anelli**  
rings

**le medaglie**  
medals

**l'argento**  
silver

**le parallele**  
parallel bars

**il cavallo**  
pommel horse

**il podio**  
podium

**l'oro**  
gold

**il bronzo**  
bronze

# gli sport da combattimento • combat sports

**l'avversario**  
opponent

**il guanto**  
glove

**il casco**  
guard

**la cintura**  
belt



**il tae kwondo**  
tae kwon do



**il karate**  
karate



**il judo**  
judo



**l'aikido**  
aikido

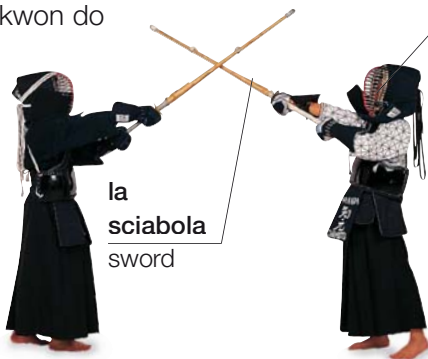

**la sciabola**  
sword

**il kendo**  
kendo

**la maschera**  
mask



**il kung fu**  
kung fu



**il kickboxing**  
kickboxing

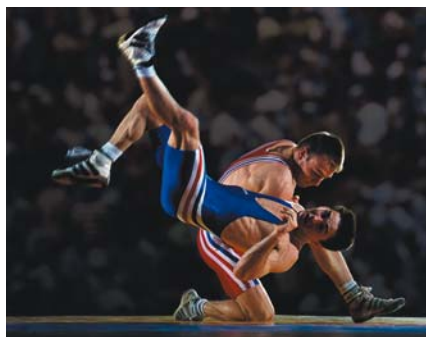

**la lotta greco-romana**  
wrestling



**il pugilato**  
boxing

## le mosse • actions



la scivolata  
fall



la presa  
hold



la proiezione  
throw



la caduta  
pin



il calcio  
kick



il pugno  
punch



il colpo  
strike



il colpo di taglio  
chop



il salto  
jump



la parata  
block

## vocabolario • vocabulary

**il ring**  
boxing ring

**il round**  
round

**il pugno**  
fist

**la cintura nera**  
black belt

**la capoeira**  
capoeira

**i guanti**  
boxing gloves

**l'incontro**  
bout

**il k.o.**  
knockout

**l'autodifesa**  
self-defense

**il sumo**  
sumo wrestling

**il paradenti**  
mouth guard

**l'allenamento**  
sparring

**il sacco**  
punching  
bag

**le arti marziali**  
martial arts

**il tai-chi**  
tai chi

# il nuoto • swimming

## l'attrezzatura • equipment



il bracciolo  
armband



gli occhiali  
goggles

la molletta  
per il naso  
nose clip



la tavoletta  
kickboard



il costume da bagno  
swimsuit

la corsia  
lane

l'acqua  
water

il podio di  
partenza  
starting block



la piscina  
swimming pool

la cuffia  
cap

il costume  
da bagno  
trunks



il nuotatore | swimmer

il trampolino  
springboard

il tuffatore  
diver



tuffarsi | dive (v)



nuotare | swim (v)



la giravolta | turn



gli stili • styles



**lo stile libero**  
front crawl



**la rana**  
breaststroke



**il dorso** | backstroke

**la bracciata**  
stroke



**la gambata**  
kick

**la farfalla** | butterfly

il nuoto subacqueo • scuba diving



vocabolario • vocabulary

<b>il tuffo</b> dive	<b>il tuffo alto</b> high dive	<b>gli armadietti</b> lockers	<b>la pallanuoto</b> water polo	<b>la parte bassa</b> shallow end	<b>il crampo</b> cramp
<b>il tuffo di rincorsa</b> racing dive	<b>tenersi a galla</b> tread water (v)	<b>il bagnino</b> lifeguard	<b>la parte profonda</b> deep end	<b>il nuoto sincronizzato</b> synchronized swimming	<b>annegare</b> drown (v)

# la vela • sailing



la bussola  
compass



l'ancora  
anchor



l'albero  
mast

il sartiame  
rigging

la vela di maestra  
mainsail

il boma  
boom

la poppa  
stern

la vela di prua  
headsail

la prua  
bow

la barra  
tiller

lo scafo  
hull

il ponte laterale  
sidedeck

la galloccia  
cleat



navigare | navigate (v)

lo yacht | yacht

# la sicurezza • safety



il razzo illuminante  
flare



il salvagente  
life preserver



il giubbotto di salvataggio  
life jacket



la zattera di salvataggio  
life raft

## gli sport acquatici • watersports

il rematore  
rower



remare | row (v)

il remo  
oar

il kayak  
kayak



il canottaggio  
canoeing

la pagaia  
paddle

la vela  
sail

il windsurf  
windsurfer

la tavola  
board



il windsurfing | windsurfing

il surf  
surfboard



il surfing  
surfing

lo sci  
ski



lo sci d'acqua  
waterskiing



la corsa in motoscafo  
speed-boating

la presa  
per il piede  
footstrap



rafting  
rafting



l'acquascooter  
jet skiing

### vocabolario • vocabulary

il surfista  
surfer

l'equipaggio  
crew

il vento  
wind

le rapide  
rapids

la scotta  
sheet

bordeggiare  
tack (v)

lo sciatore  
d'acqua  
waterskier

il centro  
della tavola  
centerboard

l'onda  
wave

la cresta  
dell'onda  
surf

il timone  
rudder

capovolgersi  
capsize (v)

# l'equitazione • horse riding

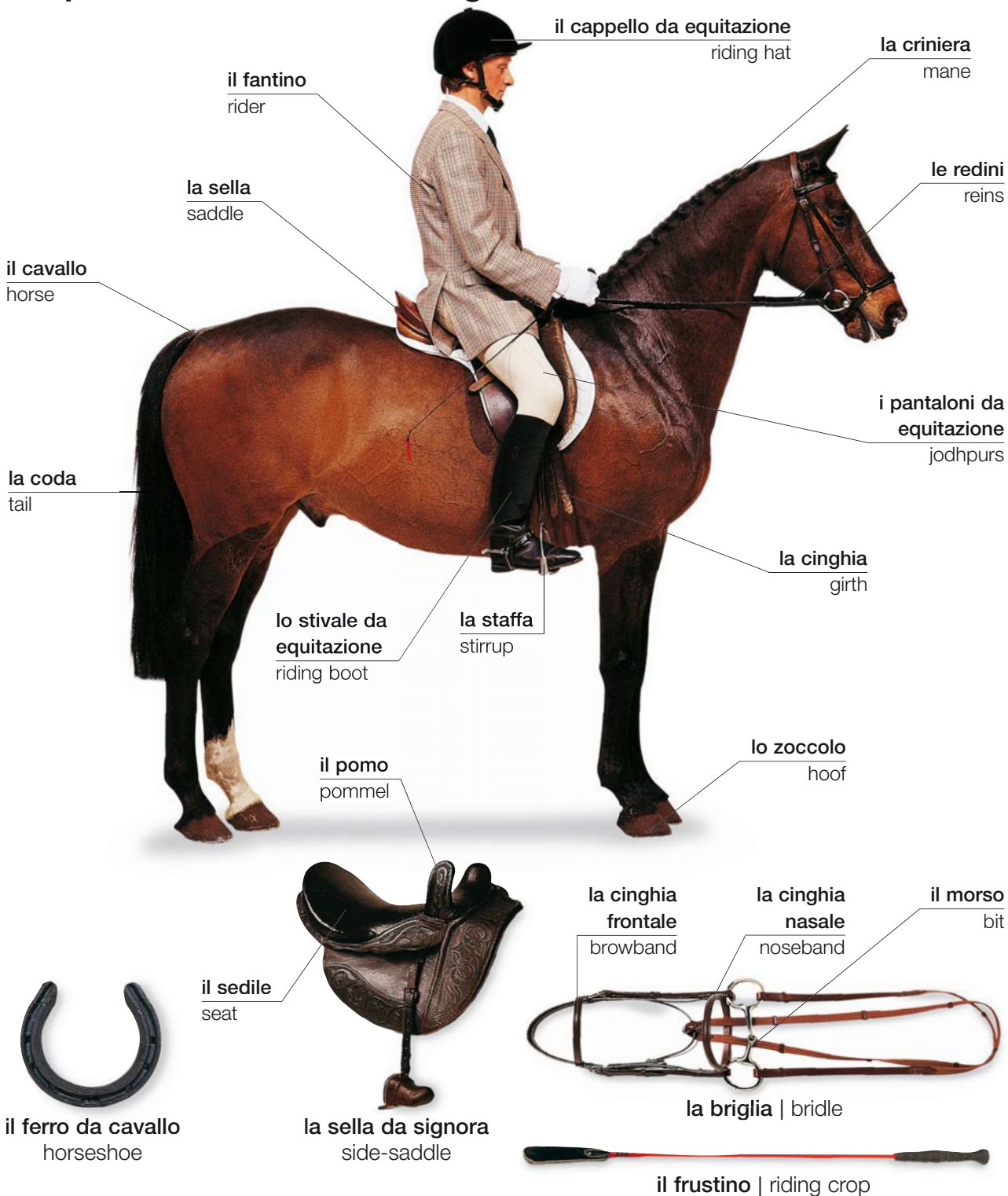

le corse • events

il cavallo da corsa  
racehorse



la corsa di cavalli  
horse race

l'ostacolo  
fence

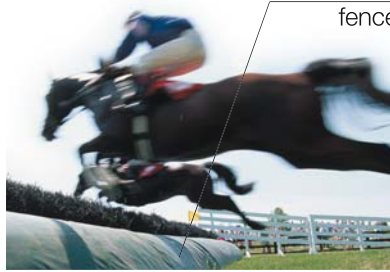

la corsa a ostacoli  
steeplechase



la corsa di calessi  
harness race



il rodeo  
rodeo



il concorso di salto a ostacoli  
showjumping



la corsa di carrozze  
carriage race



l'escursione a cavallo  
trail riding



il dressage  
dressage



il polo  
polo

vocabolario • vocabulary

il passo  
walk

il galoppo  
gallop

il salto  
jump

la cavezza  
halter

il recinto  
paddock

l'ippodromo  
racecourse

il trotto  
trot

il piccolo  
galoppo  
canter

il palafreniere  
groom

la stalla  
stable

l'arena  
arena

la corsa in  
piano  
flat race

# la pesca • fishing



il peso | sinker

l'uncino  
barb

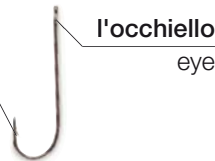

l'amo  
fishhook



l'esca | bait



il galleggiante  
float



l'esca  
lure



la mosca  
fly



la retina  
landing net



la scatola degli attrezzi  
tackle box



la rete da pesca  
keep net

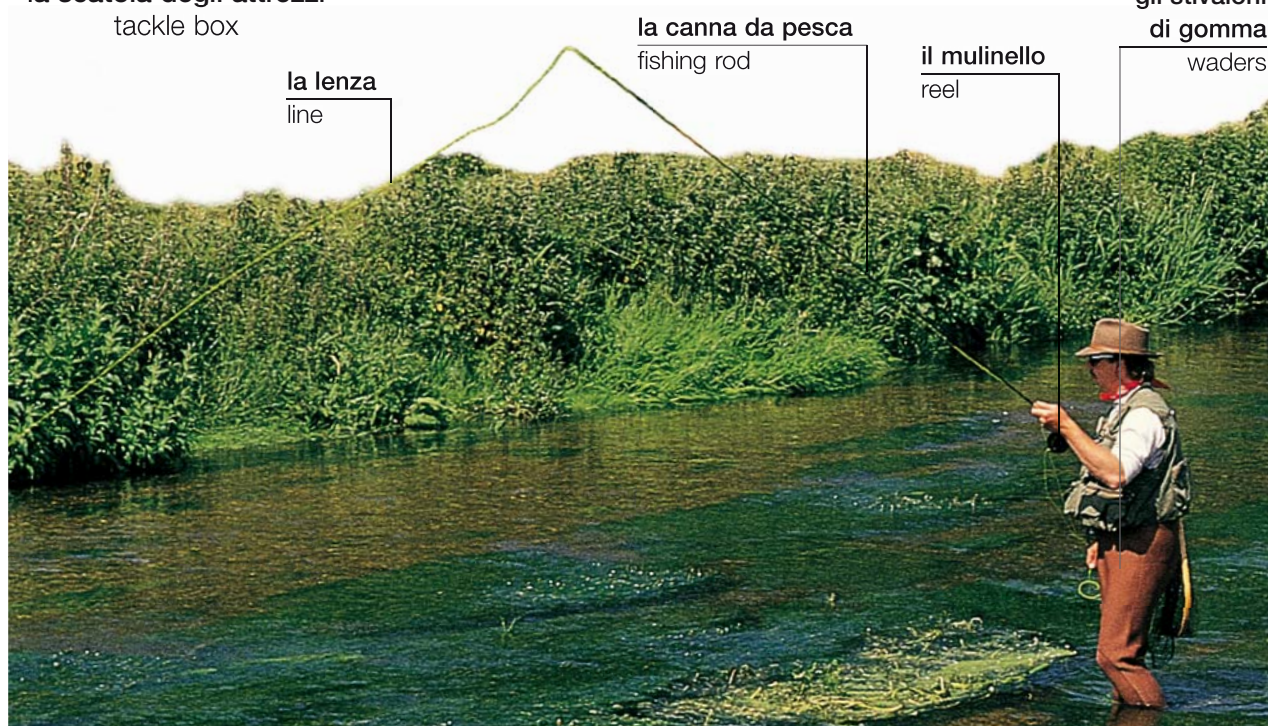

la lenza  
line

la canna da pesca  
fishing rod

il mulinello  
reel

gli stivaloni  
di gomma  
waders

il pescatore | angler

## i tipi di pesca • types of fishing



la pesca in acqua dolce  
freshwater fishing



la pesca con la mosca  
fly fishing



la pesca dalla riva  
surfcasting



la pesca sportiva  
sport fishing



la pesca in alto mare  
deep sea fishing

## le attività • activities



lanciare  
cast (v)



prendere  
catch (v)



tirare con il  
mulinello  
reel in (v)



pescare con  
la rete  
net (v)



rilasciare  
release (v)

## vocabolario • vocabulary

fornire di esca  
bait (v)

l'attrezzatura  
tackle

l'impermeabile  
waterproofs

la licenza di pesca  
fishing permit

la nassa  
creel

abboccare  
bite (v)

la bobina  
spool

il palo  
pole

la pesca in mare  
marine fishing

la pesca con  
la fiocina  
spearfishing

# lo sci • skiing

la pista da sci  
ski slope

la seggiovia  
chairlift

la funivia  
cable car

la tuta da sci  
ski suit

il bastone  
da sci  
ski pole

il guanto  
glove

la pista da sci  
ski run

lo scarpone da sci  
ski boot

la transenna di  
sicurezza  
safety barrier

lo sci  
ski

la lama  
edge

la sciatrice  
skier

la punta  
tip





le gare • events



**la discesa**  
downhill skiing



**la porta**  
gate  
**lo slalom**  
slalom



**il salto**  
ski jump



**lo sci di fondo**  
cross-country skiing

gli sport invernali • winter sports



**l'arrampicata su ghiaccio**  
ice climbing



**il pattinaggio su ghiaccio**  
ice-skating



**il pattinaggio artistico**  
figure skating

**gli occhiali**  
goggles



**lo snowboard**  
snowboarding



**il bob**  
bobsled



**lo slittino**  
luge



**la motoslitta**  
snowmobile



**la corsa su slitta**  
sledding

vocabolario • vocabulary

**la valanga**  
avalanche

**fuoripista**  
off-piste

**lo sci alpino**  
alpine skiing

**il curling**  
curling

**lo slalom gigante**  
giant slalom

**il biathlon**  
biathlon

**la corsa su slitta**  
trainata da cani  
dog-sledding

**il pattinaggio di velocità**  
speed skating

# gli altri sport • other sports



l'aliante  
glider

il deltaplano  
hang-glider

il volo senza motore  
gliding



il volo in deltaplano  
hang-glider



la corda  
rope

l'alpinismo in parete  
rock-climbing



il paracadute  
parachute

il paracadutismo  
parachuting



il parapendio  
paragliding



il paracadutismo libero  
skydiving



la cordata  
rappelling

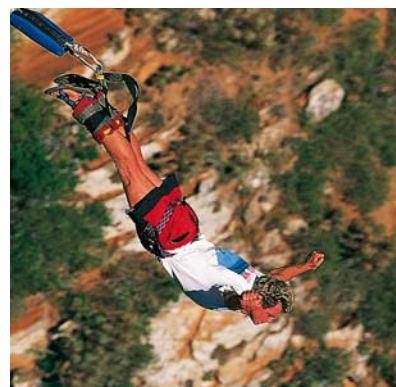

il bungee jumping  
bungee jumping



**il rally**  
rally driving



**il pilota da corsa**  
racing driver  
**l'automobilismo**  
auto racing



**il motocross**  
motocross



**il motociclismo**  
motorcycle racing



**lo skate board**  
skateboarding

**la tavola da skateboard**  
skateboard

**il pattino a rotelle**  
rollerskate



**il pattinaggio a rotelle**  
rollerskating



**la mazza**  
stick  
**il lacrosse**  
lacrosse

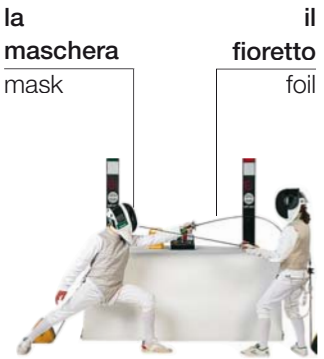

**la maschera**  
mask  
**il fioretto**  
foil  
**la scherma**  
fencing



**il birillo**  
pin

**la freccia**  
arrow

**la faretra**  
quiver

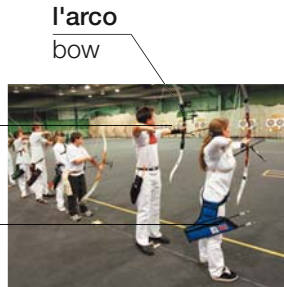

**l'arco**  
bow

**il tiro con l'arco**  
archery



**il bersaglio**  
target

**il tiro al bersaglio**  
target shooting



**la palla da bowling**  
bowling ball

**il bowling**  
bowling



**il biliardo**  
pool



**lo snooker**  
snooker

# il fitness • fitness

la cyclette  
exercise bike

i manubri  
free weights

la sbarra  
bar

la macchina per esercizi  
gym machine

la panca  
bench



il vogatore  
rowing machine

la palestra  
gym



il treadmill  
treadmill



il cross trainer  
cross-trainer



l'istruttore individuale  
personal trainer



la macchina per step  
step machine

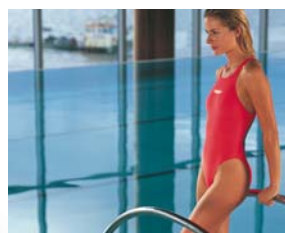

la piscina  
swimming pool



la sauna  
sauna

gli esercizi • exercises



lo stretching  
stretch



lo stiramento  
lunge

il collant  
tights



le flessioni  
pushup



lo squat  
squat



gli addominali  
situp



le alzate con  
il manubrio  
biceps curl

il manubrio  
dumbbell



la pressa per le  
gambe  
leg press



la pressa per pettorali  
chest press



gli  
scarponcini  
athletic  
shoes

il  
bilanciere  
weight bar

l'addestramento  
ai pesi  
weight training



il footing  
jogging

la  
maglietta  
vest

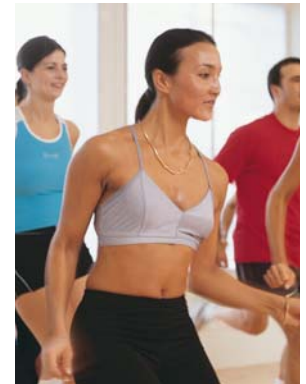

la ginnastica  
aerobica  
aerobics

vocabolario • vocabulary

**allenarsi**  
train (v)

**correre sul posto**  
jog in place (v)

**stendere**  
extend (v)

**il pilates**  
Pilates

**l'allenamento a circuito**  
circuit training

**riscaldarsi**  
warm up (v)

**flettere**  
flex (v)

**sollevare**  
pull up (v)

**la ginnastica  
prepugilistica**  
boxercise

**saltare con la corda**  
jumping rope



**il tempo libero**  
leisure

# il teatro • theater



**il sipario**  
curtain

**le quinte**  
wings

**la scenografia**  
set

**il pubblico**  
audience

**l'orchestra**  
orchestra

**il palcoscenico** | stage

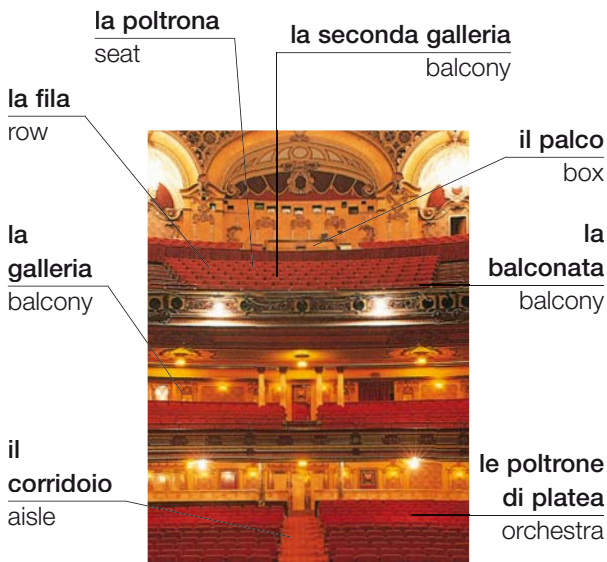

**la poltrona**  
seat

**la seconda galleria**  
balcony

**la fila**  
row

**il palco**  
box

**la galleria**  
balcony

**la balconata**  
balcony

**il corridoio**  
aisle

**le poltrone di platea**  
orchestra

**le poltrone** | seating

## vocabolario • vocabulary

**l'attrice**  
actress

**il regista**  
director

**la prima**  
opening night

**il cast**  
cast

**il produttore**  
producer

**l'intervallo**  
intermission

**l'attore**  
actor

**il copione**  
script

**il programma**  
program

**l'opera teatrale**  
play

**il fondale**  
backdrop

**il golfo mistico**  
orchestra pit





**il concerto**  
concert



**il musical**  
musical

**il costume**  
costume



**il balletto**  
ballet



**l'opera**  
opera

**vocabolario • vocabulary**

**la maschera**  
usher

**la colonna sonora**  
soundtrack

**Vorrei due biglietti per lo spettacolo di stasera.**  
I'd like two tickets for tonight's performance.

**la musica classica**  
classical music

**applaudire**  
applaud (v)

**A che ora inizia?**  
What time does it start?

**la partitura musicale**  
musical score

**il bis**  
encore

**il cinema • cinema**

**il popcorn**  
popcorn



**la biglietteria**  
box office

**l'atrio**  
lobby

**il poster**  
poster



**il cinema**  
movie theater



**lo schermo**  
screen

**vocabolario • vocabulary**

**la commedia**  
comedy

**il film d'amore**  
romance

**il thriller**  
thriller

**il film di fantascienza**  
science fiction movie

**il film di orrore**  
horror movie

**il film di avventura**  
adventure

**il western**  
western

**il film di animazione**  
animated film

# l'orchestra • orchestra

## le corde • strings



**il pianoforte** | piano

**lo spartito**  
score

**la chiave di basso**  
bass clef

**la chiave di sol**  
treble clef

**la nota**  
note

**il pentagramma**  
staff



**l'annotazione** | notation

### vocabolario • vocabulary

**l'ouverture**  
overture

**la sonata**  
sonata

**la pausa**  
rest

**il diesis**  
sharp

**naturale**  
natural

**la scala**  
scale

**la sinfonia**  
symphony

**gli strumenti**  
instruments

**il tono**  
pitch

**il bemolle**  
flat

**la battuta**  
bar

**la bacchetta**  
baton

gli strumenti a fiato • woodwind



il piffero  
piccolo



il flauto  
flute



l'oboe  
oboe



il corno inglese  
cor anglais



il sassofono  
saxophone



il clarinetto  
clarinet



il clarinetto basso  
bass clarinet



il fagotto  
bassoon



il controfagotto  
double bassoon

la percussione • percussion



il timpano  
kettledrum



il gong  
gong



i bongo  
bongos



il tamburo  
militare  
snare drum



i cembali  
cymbals



il tamburino  
tambourine



il vibrafono  
vibraphone



il triangolo  
triangle



i maracas  
maracas

gli ottoni • brass



la tromba  
trumpet



il trombone  
trombone



il corno  
French horn



la tuba  
tuba

# il concerto • concert

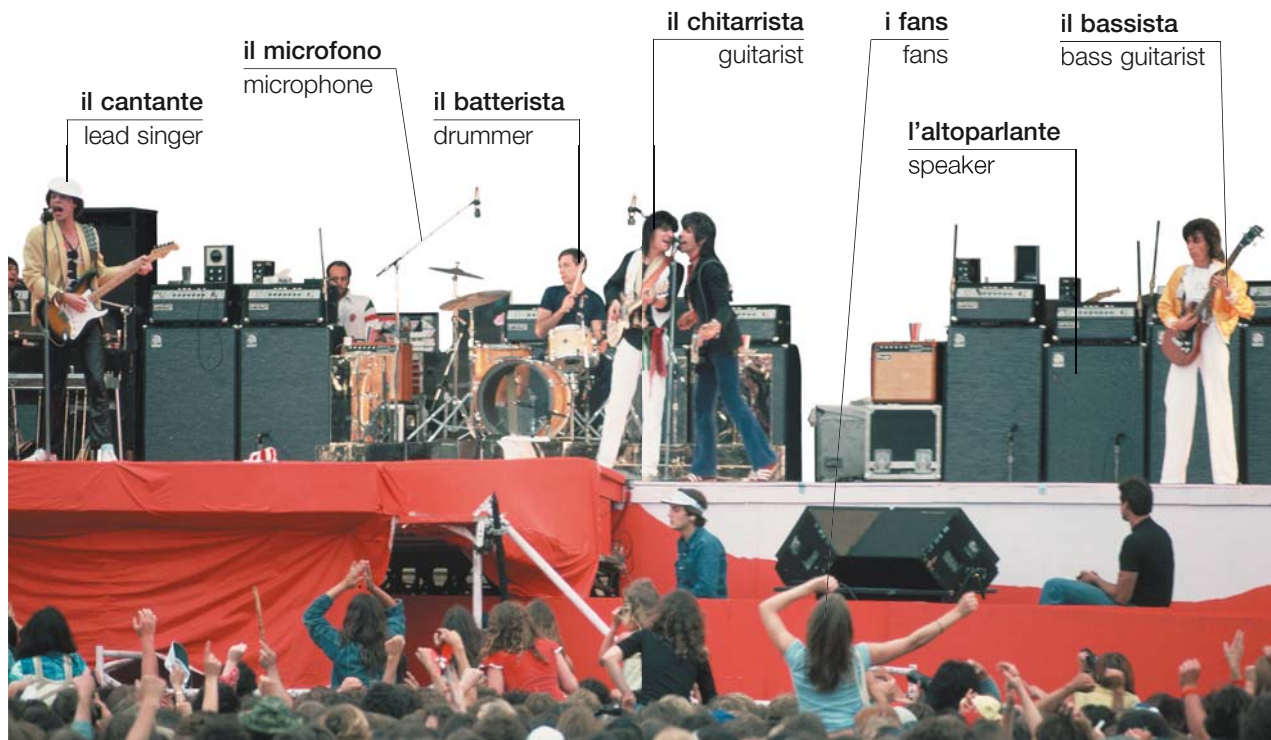

il concerto rock | rock concert

# gli strumenti • instruments



gli stili musicali • musical styles



**il jazz**  
jazz



**il blues**  
blues



**il punk**  
punk



**la musica folk**  
folk music



**il pop**  
pop



**la musica da ballo**  
dance



**il rap**  
rap



**l'heavy metal**  
heavy metal



**la musica classica**  
classical music

**vocabolario** • vocabulary

**la canzone**  
song

**il testo**  
lyrics

**la melodia**  
melody

**il ritmo**  
beat

**il reggae**  
reggae

**il country**  
country

**il proiettore**  
spotlight

# il turismo • sightseeing



il turista  
tourist

il luogo d'interesse turistico | tourist attraction



l'itinerario  
itinerary

scoperto  
open-top

il pullman turistico | tour bus

la guida  
turistica  
tour guide



la visita guidata  
guided tour

la statua  
figurine



i ricordi  
souvenirs

## vocabolario • vocabulary

**aperto**  
open

**la guida**  
guidebook

**le indicazioni**  
directions

**a sinistra**  
left

**Dov'è...?**  
Where is...?

**chiuso**  
closed

**la pellicola**  
film

**la videocamera**  
camcorder

**a destra**  
right

**Mi sono perso.**  
I'm lost.

**la tariffa  
d'ingresso**  
admission  
charge

**le batterie**  
batteries

**la macchina  
fotografica**  
camera

**dritto**  
straight  
ahead

**Mi può dire come si arriva a...?**  
Can you tell me the way to...?

## i luoghi d'interesse • attractions

il quadro  
painting



la galleria d'arte  
art gallery

l'oggetto  
exhibit



il monumento  
monument

l'esposizione  
exhibition

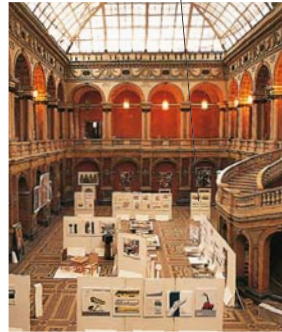

il museo  
museum

la rovina  
famosa  
famous ruin



l'edificio storico  
historic building



il casinò  
casino



i giardini  
gardens



il parco nazionale  
national park

## l'informazione • information

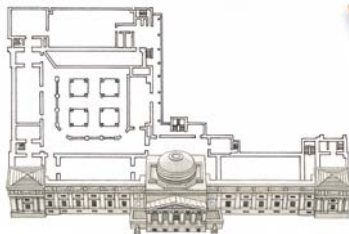

la pianta del piano  
floor plan



la mappa  
map

gli orari  
times



l'orario  
schedule



l'ufficio informazioni  
turistiche  
tourist information

# le attività all'aria aperta • outdoor activities

**il sentiero**  
footpath

**la meridiana**  
sundial

**il caffè**  
café

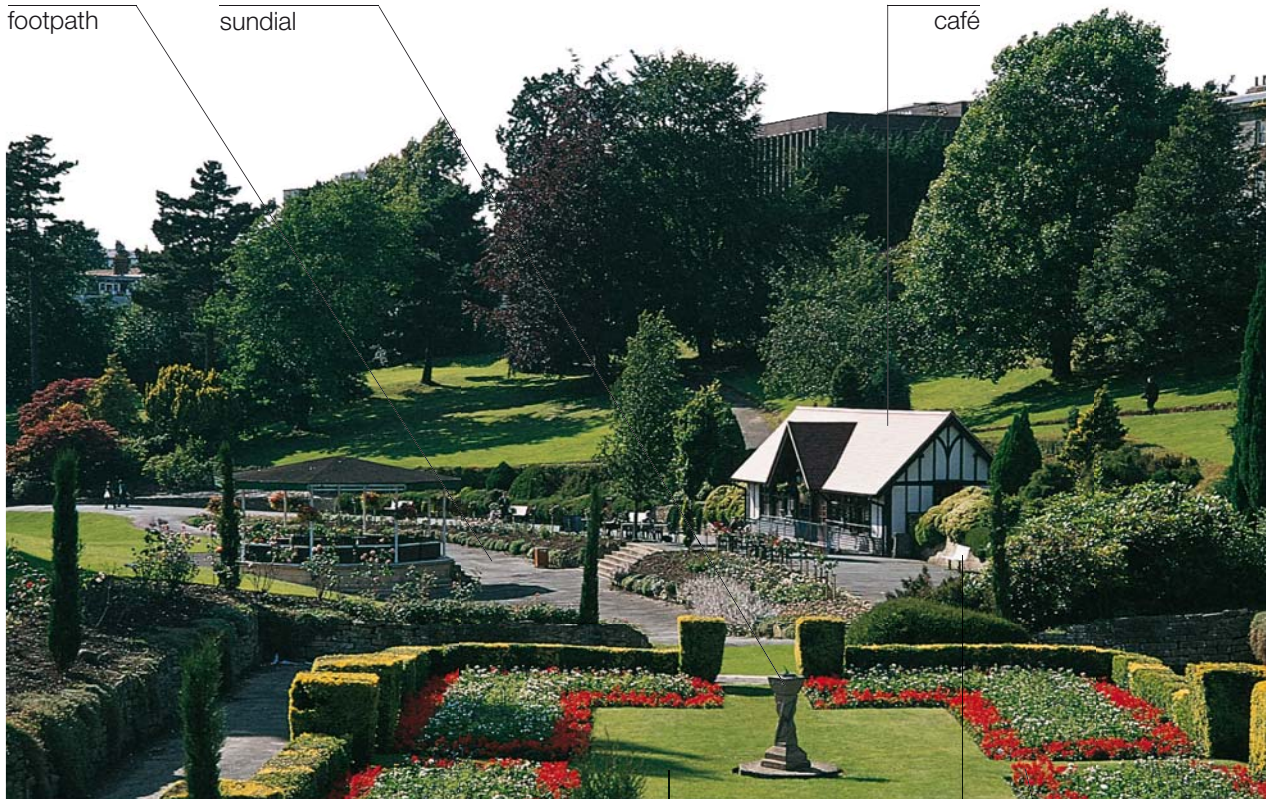

**il parco** | park

**il prato**  
grass

**la panchina**  
bench

**il giardino  
all'italiana**  
formal gardens

**le montagne russe**  
roller coaster



**il luna park**  
fairground



**il parco a tema**  
theme park



**lo zoosafari**  
safari park



**lo zoo**  
zoo



**le attività • activities**



**il ciclismo**  
cycling



**il footing**  
jogging



**lo skateboard**  
skateboarding



**il pattinaggio**  
rollerblading

**il sentiero per cavalli**  
bridle path



**l'ornitologia**  
bird-watching



**l'equitazione**  
horseback riding



**l'escursionismo**  
hiking

**la cesta**  
hamper



**il picnic**  
picnic

**il parco giochi • playground**



**la fossa di sabbia**  
sandbox



**la piscina gonfiabile**  
wading pool



**l'altalena**  
swings



**la struttura per arrampicarsi**  
climbing frame



**il bilanciere** | seesaw



**lo scivolo**  
slide

# la spiaggia • beach

**l'albergo**  
hotel

**l'ombrellone**  
beach umbrella

**la cabina**  
beach hut

**la sabbia**  
sand

**l'onda**  
wave

**il mare**  
sea



**la borsa da spiaggia**  
beach bag

**il bikini**  
bikini



**prendere il sole | sunbathe (v)**



il bagnino  
lifeguard

la torre di sorveglianza  
lifeguard tower



il paravento  
windbreak



il lungomare  
boardwalk



la sedia a sdraio  
deck chair



gli occhiali da sole  
sunglasses



il cappello da spiaggia  
sun hat



la crema abbronzante  
suntan lotion



la crema protettiva  
sunblock



il pallone da spiaggia  
beach ball



la ciambella  
inflatable ring

il costume da bagno  
swimsuit

la paletta  
shovel

il secchiello  
pail

il castello di sabbia  
sandcastle

la conchiglia  
shell



l'asciugamano da spiaggia  
beach towel

# il campeggio • camping



## vocabolario • vocabulary

**campeggiare**  
camp (v)

**il posteggio**  
site

**la tavola da picnic**  
picnic bench

**la carbonella**  
charcoal

**l'ufficio del direttore**  
site manager's office

**piantare una tenda**  
pitch a tent (v)

**l'amaca**  
hammock

**l'esca per il fuoco**  
firelighter

**le piazzole disponibili**  
sites available

**il palo**  
tent pole

**il camper**  
camper van

**accendere un fuoco**  
light a fire (v)

**completo**  
full

**il lettino da campeggio**  
camp bed

**il rimorchio**  
trailer

**il fuoco**  
campfire



la struttura  
frame

il telo isolante  
groundsheet

lo zaino  
backpack

il thermos  
vacuum flask

la borraccia  
water bottle

la tenda  
tent



il repellente per  
insetti  
insect repellent



la torcia  
flashlight

la zanzariera  
mosquito net

gli indumenti  
termici  
thermals



le scarpe da  
escursionismo  
walking boots



gli indumenti  
impermeabili  
rain gear



il sacco a pelo  
sleeping bag



il fornello da campeggio  
camping stove



la griglia per barbecue  
barbecue grill

il materassino  
sleeping mat



il materassino ad aria | air mattress

# gli intrattenimenti in casa • home entertainment



**il lettore di CD  
portatile**  
personal CD player



**il lettore di  
mini disk**  
mini disc recorder



**il lettore di MP3**  
MP3 player

**il disco DVD**  
DVD



**il lettore di DVD**  
DVD player

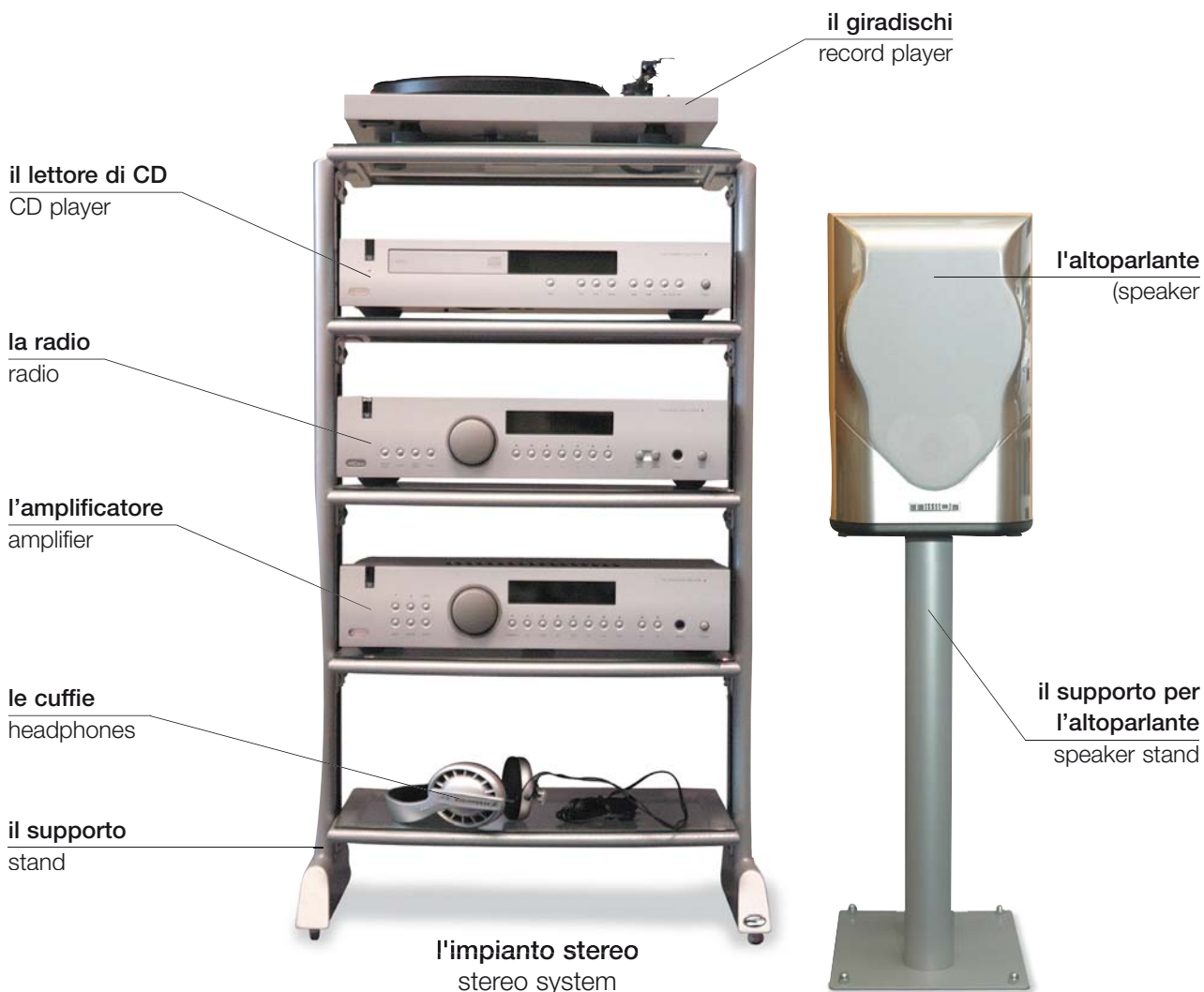



la videocassetta  
videotape

il videoregistratore  
video recorder



lo schermo  
screen

la videocamera  
camcorder

l'oculare  
eyecup



l'antenna parabolica  
satellite dish



il televisore a  
schermo largo  
widescreen television

il comando  
controller



il videogioco | video game

la console  
console

l'avanzamento  
veloce  
fast-forward

la pausa  
pause

la registrazione  
record



il volume  
volume

il riavvolgimento  
rewind

il play  
play

lo stop  
stop

il telecomando  
remote control

**vocabolario • vocabulary**

**il compact disc**  
CD

**il lungometraggio**  
feature film

**accendere la televisione**  
turn on the television (v)

**stereo**  
stereo

**l'audiocassetta**  
cassette tape

**la televisione via cavo**  
cable television

**guardare la televisione**  
watch television (v)

**digitale**  
digital

**il mangianastri**  
cassette player

**il canale a pagamento**  
pay-per-view channel

**spegnere la televisione**  
turn off the television (v)

**il programma**  
program

**la pubblicità**  
advertisement

**cambiare canale**  
change channels (v)

**sintonizzare la radio**  
tune the radio (v)

# la fotografia • photography



il lampeggiatore  
flash gun



l'esposimetro  
light meter



lo zoom  
zoom lens



il treppiede  
tripod

## i tipi di macchina fotografica • types of camera



la macchina fotografica digitale  
digital camera



la macchina fotografica APS  
APS camera



la macchina fotografica istantanea  
instant camera



la macchina fotografica usa e getta  
disposable camera



**fotografare** • photograph (v)

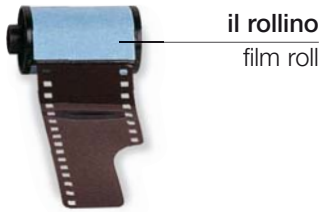

**la pellicola**  
film



**mettere a fuoco**  
focus (v)



**sviluppare**  
develop (v)



**il negativo**  
negative

**orizzontale**  
landscape



**la fotografia** | photograph

**verticale**  
portrait



**l'album fotografico**  
photo album



**la cornice**  
picture frame

**i difetti** • problems



**sottoesposto**  
underexposed



**sovraesposto**  
overexposed



**sfocato**  
out of focus



**l'occhio rosso**  
red eye

**vocabolario** • vocabulary

**il mirino**  
viewfinder

**opaco**  
mat

**l'astuccio**  
camera case

**lucido**  
gloss

**l'esposizione**  
exposure

**l'ingrandimento**  
enlargement

**la camera oscura**  
darkroom

**la fotografia (sviluppata)**  
print

**Vorrei far sviluppare questo rollino.**  
I'd like this film processed

# i giochi • games



**la dama**  
checkers

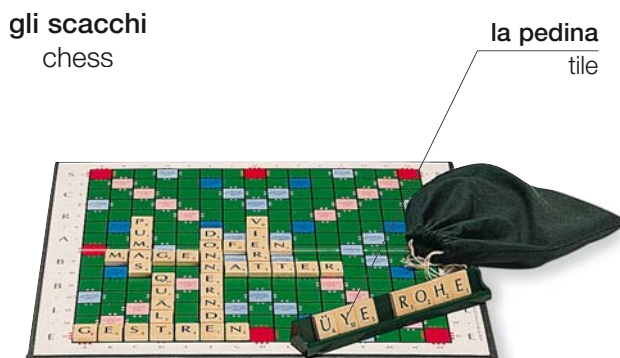

**lo scrabble**  
Scrabble

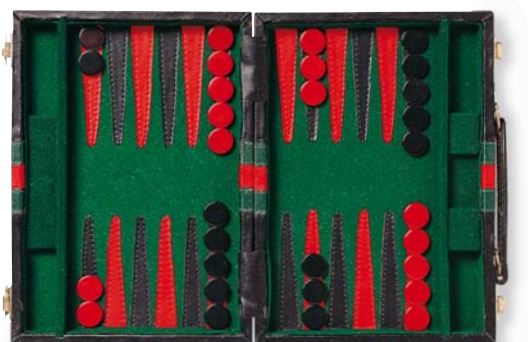

**il tric trac (la tavola reale) | backgammon**



**i giochi da tavolo | board games**



**la filatelia**  
stamp collecting



**il puzzle**  
jigsaw puzzle



**il domino**  
dominoes

**il bersaglio**  
dartboard

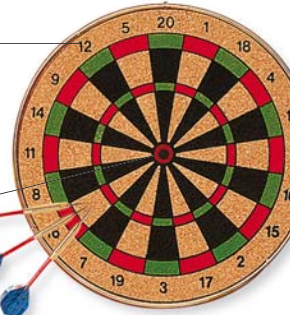

**il centro**  
bullseye

**le freccette**  
darts

**il jolly**  
joker

**il fante**  
jack

**la regina**  
queen

**il re**  
king

**l'asso**  
ace



**le carte**  
cards

**il quadro**  
diamond

**la picca**  
spade

**il cuore**  
heart

**il fiore**  
club



**mescolare** | shuffle (v)



**distribuire** | deal (v)

**vocabolario** • vocabulary

**la mossa**  
move

**vincere**  
win (v)

**il perdente**  
loser

**il punto**  
point

**il bridge**  
bridge

**A chi tocca?**  
Whose turn is it?

**giocare**  
play (v)

**il vincitore**  
winner

**il gioco**  
game

**il punteggio**  
score

**il colore**  
suit

**Tocca a te.**  
It's your move.

**il giocatore**  
player

**perdere**  
lose (v)

**la scommessa**  
bet

**il poker**  
poker

**il mazzo di  
carte**  
deck of cards

**Tira i dadi.**  
Roll the dice.

# arte e artigianato 1 • arts and crafts 1



l'artista  
artist

il quadro  
painting

il cavalletto  
easel

la tela  
canvas

il pennello  
brush

la  
tavolozza  
palette

la pittura | painting

## i colori • colours



rosso  
red



blu  
blue



giallo  
yellow



verde  
green



arancione  
orange



viola  
purple



bianco  
white



nero  
black



grigio  
gray



rosa  
pink



marrone  
brown



indaco  
indigo

## la vernice • paints



i colori ad olio  
oil paints



gli acquarelli  
watercolor paint



i pastellii  
pastels



i colori acrilici  
acrylic paint



la tempera  
poster paint

altri lavori artigianali • other crafts

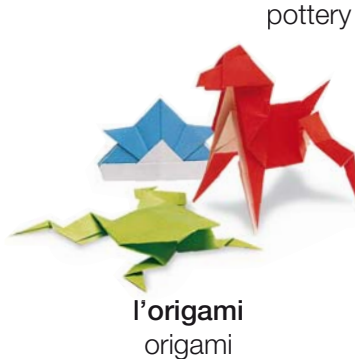

# arte e artigianato 2 • arts and crafts 2



la macchina da cucire | sewing machine



**le forbici**  
scissors



**il modello**  
pattern



**il metro**  
tape measure



**la stoffa**  
material



la cesta del cucito | sewing basket

**il puntaspilli**  
pincushion

**lo spillo**  
pin



**la bobina**  
bobbin



**il filo**  
thread



**l'occhiello**  
eye



**il gancio**  
hook



**il ditale**  
thimble



**il gesso**  
tailor's chalk



**il manichino**  
tailor's dummy

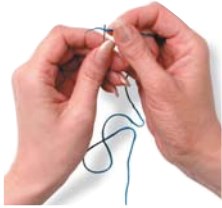

**infilare**  
thread (v)



**cucire**  
sew (v)



**rammendare**  
darn (v)



**imbastire**  
tack (v)



**tagliare**  
cut (v)



**la punta dell'ago**  
needlepoint



**il ricamo**  
embroidery

**l'uncinetto**  
crochet hook



**l'uncinetto**  
crochet



**il macramè**  
macramé

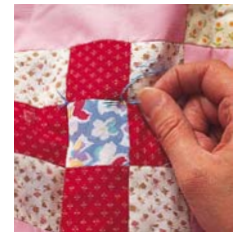

**il patchwork**  
patchwork



**il trapunto**  
quilting

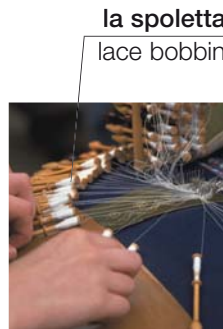

**la fabbricazione  
dei merletti**  
lace-making

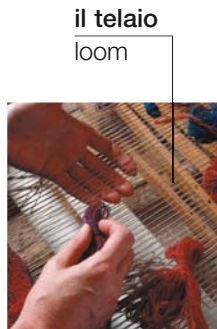

**la tessitura**  
weaving



**il lavoro a maglia** | knitting

**il ferro da calza**  
knitting needle



**la matassa** | skein

**la lana**  
wool

**vocabolario** • vocabulary

**scucire**  
unpick (v)

**il nailon**  
nylon

**la tela**  
fabric

**la seta**  
silk

**il cotone**  
cotton

**lo stilista**  
designer

**il lino**  
linen

**la moda**  
fashion

**il poliester**  
polyester

**la chiusura  
lampo**  
zipper







**l'ambiente**  
environment



# lo spazio • space

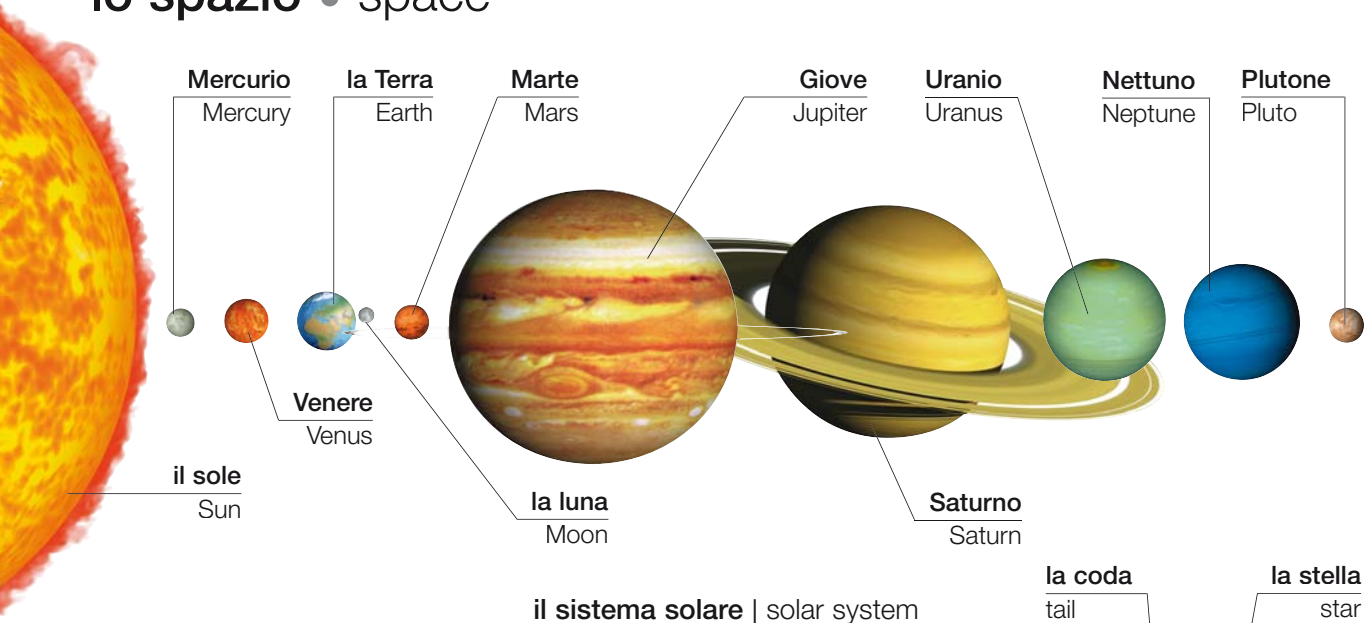

la galassia  
galaxy



la nebulosa  
nebula



l'asteroide  
asteroid



la cometa  
comet

la coda  
tail

la stella  
star

## vocabolario • vocabulary

l'universo  
universe

il buco nero  
black hole

la luna piena  
full moon

l'orbita  
orbit

il pianeta  
planet

la luna nuova  
new moon

la gravità  
gravity

la meteora  
meteor

la mezzaluna  
crescent moon



l'eclisse | eclipse

## l'esplorazione dello spazio • space exploration

**lo shuttle**  
space shuttle

**il lanciarazzi**  
booster



**il lancio**  
launch

**la tuta spaziale**  
space suit



**l'astronauta** | astronaut

**il reattore**  
thruster

**il radar**  
radar

**lo sportello dell'equipaggio**  
crew hatch

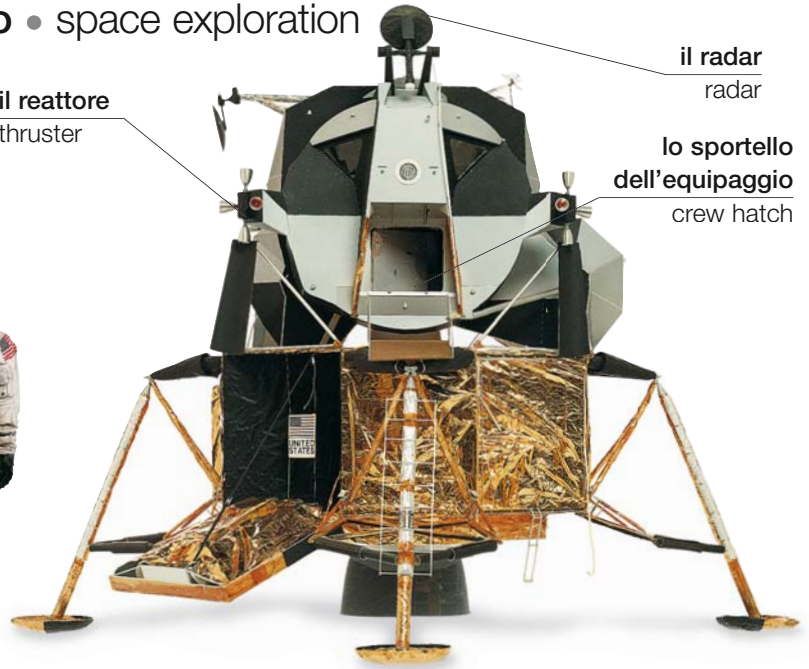

**il modulo lunare** | lunar module

**la rampa di lancio**  
launch pad



**il satellite**  
satellite



**la stazione spaziale**  
space station

## l'astronomia • astronomy



**la costellazione**  
constellation



**il binocolo**  
binoculars

**il telescopio**  
telescope

**il treppiede**  
tripod

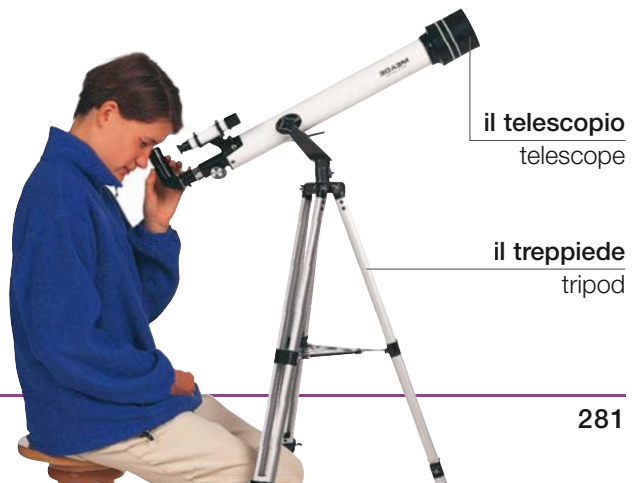

# la Terra • Earth

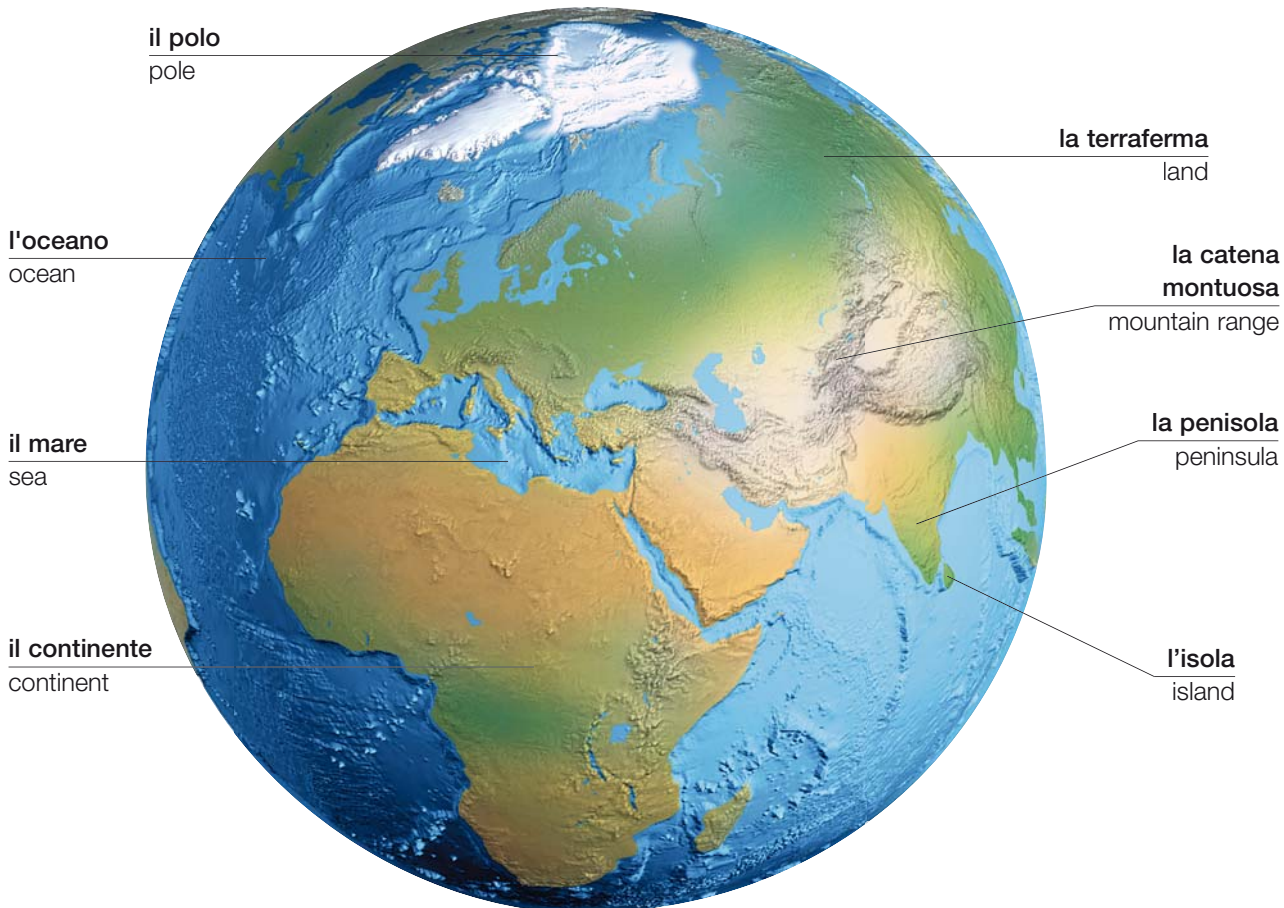

**il pianeta** | planet

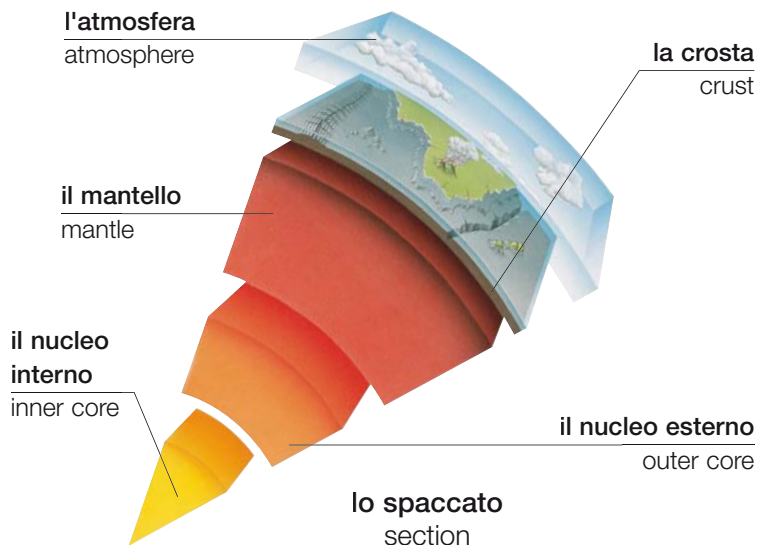

**il circolo polare artico**

Arctic circle

**il tropico del cancro**

tropic of Cancer

**i tropici**

tropics

**il tropico del capricorno**

tropic of Capricorn

**il Polo Nord**

North Pole

**l'emisfero settentrionale**

Northern Hemisphere

**la longitudine**

longitude

**la latitudine**

latitude

**l'emisfero meridionale**

Southern Hemisphere

**l'equatore**

equator

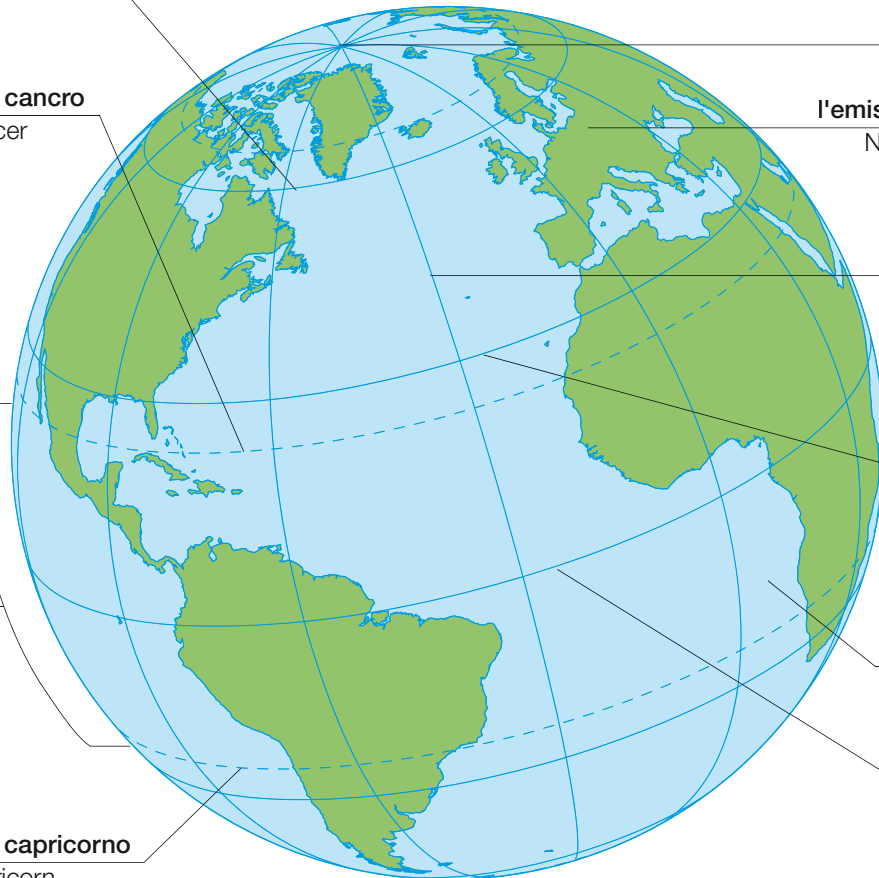

**le zone | zones**

**la lava**

lava

**la fessura**

vent

**la cenere**

ash

**la camera**

chamber

**il magma**

magma

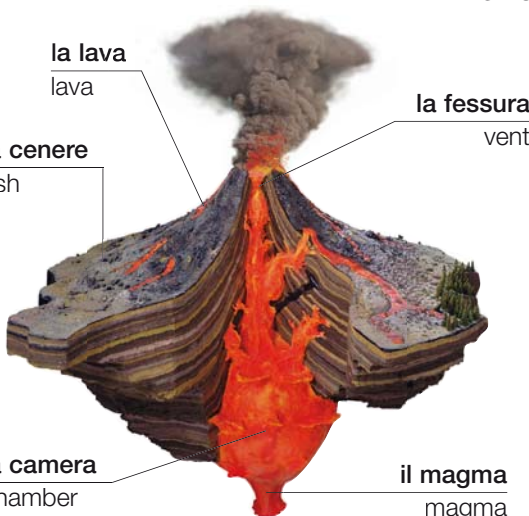

**il vulcano | volcano**



**il cratere | crater**

**vocabolario**

• vocabulary

**il terremoto**

earthquake

**la zolla**

plate

**eruttare**

erupt (v)

**il tremore**

tremor

# il paesaggio • landscape

la montagna  
mountain

la pendice  
slope

la riva  
bank

il fiume  
river

le rapide  
rapids

le rocce  
rocks

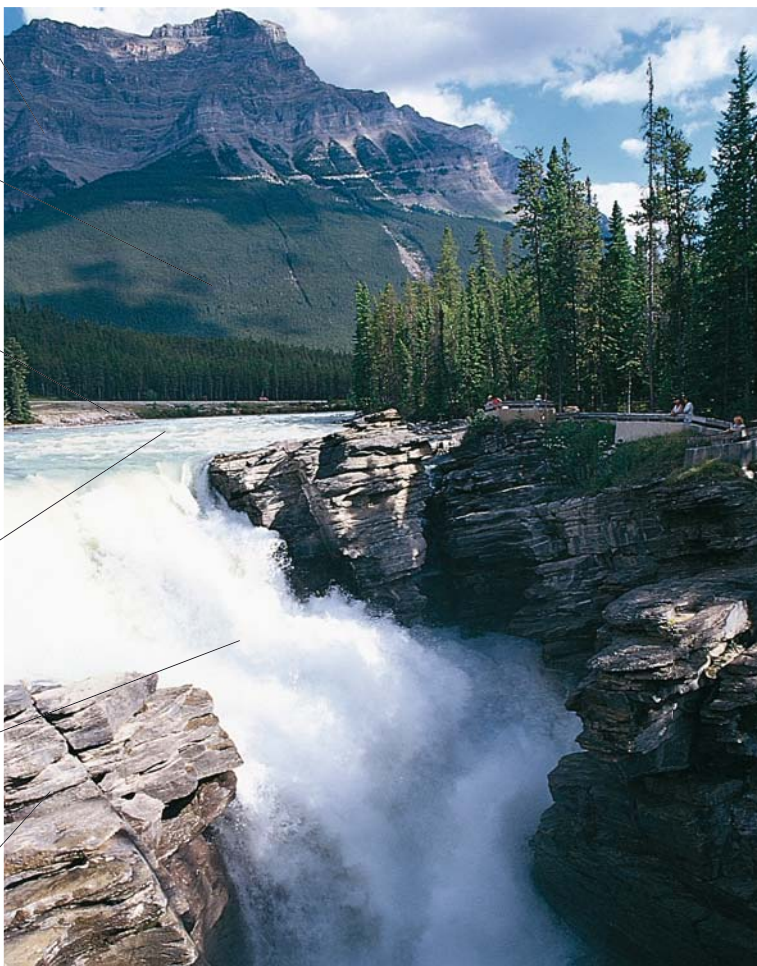

il ghiacciaio  
glacier



la valle | valley



la collina  
hill



l'altipiano  
plateau



la gola  
gorge

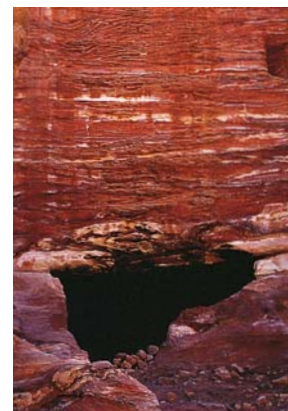

la caverna  
cave



la pianura | plain



il deserto | desert



la foresta | forest



il bosco | wood



la foresta pluviale  
rainforest



la palude  
swamp



il pascolo  
meadow



la prateria  
grassland



la cascata  
waterfall



il torrente  
stream



il lago  
lake



il geyser  
geyser



la costa  
coast



la scogliera  
cliff



la barriera corallina  
coral reef

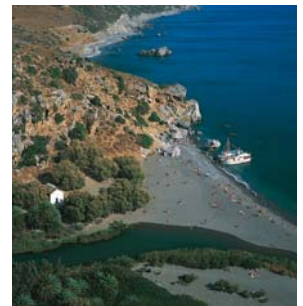

l'estuario  
estuary

# il tempo • weather

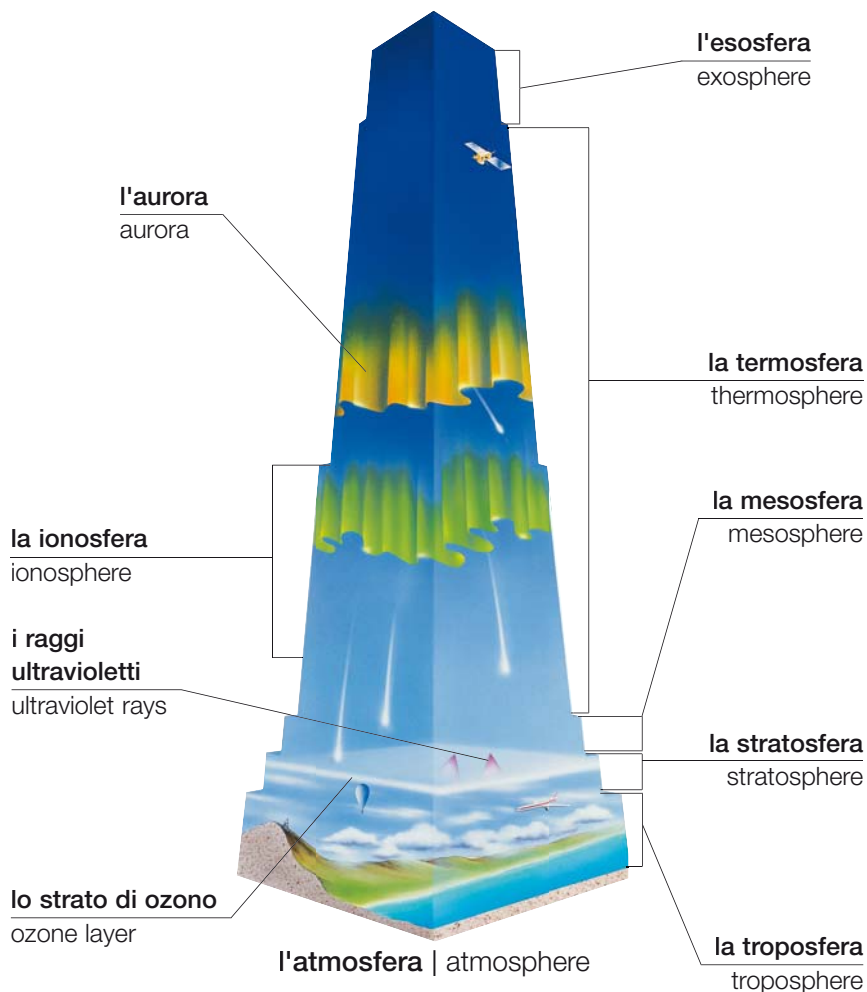

la luce del sole  
sunshine



il vento  
wind

## vocabolario • vocabulary

**il nevischio**  
sleet

**il rovescio**  
shower

**caldo**  
hot

**secco**  
dry

**ventoso**  
windy

**Ho caldo/freddo.**  
I'm hot/cold.

**la grandine**  
hail

**soleggiato**  
sunny

**freddo**  
cold

**piovoso**  
wet

**la bufera**  
gale

**Sta piovendo.**  
It's raining.

**il tuono**  
thunder

**nuvoloso**  
cloudy

**tiepido**  
warm

**umido**  
humid

**la temperatura**  
temperature

**Fa ... gradi.**  
It's ... degrees.



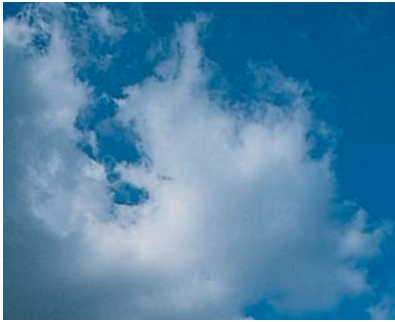

**la nuvola**  
cloud



**la pioggia**  
rain



**il fulmine**  
lightning

**la tempesta**  
storm



**la foschia**  
mist



**la nebbia**  
fog



**l'arcobaleno**  
rainbow



**la neve**  
snow



**il gelo**  
frost



**il ghiaccio**  
ice



**il ghiacciolo**  
icicle

**la gelata**  
freeze



**l'uragano**  
hurricane



**il tornado**  
tornado



**il monsone**  
monsoon



**l'inondazione**  
flood

# le rocce • rocks

## igneo • igneous



**il granito**  
granite



**l'ossidiana**  
obsidian



**il basalto**  
basalt



**la pomice**  
pumice

## sedimentario • sedimentary



**l'arenaria**  
sandstone



**il calcare**  
limestone



**il gesso**  
chalk



**la selce**  
flint



**il conglomerato**  
conglomerate



**il carbone**  
coal

## metamorfico • metamorphic



**l'ardesia**  
slate



**lo scisto**  
schist



**lo gneiss**  
gneiss



**il marmo**  
marble

## le gemme • gems

**il rubino**  
ruby



**l'ametista**  
amethyst



**il giacinto**  
jet



**l'opale**  
opal



**la lunaria**  
moonstone



**il granato**  
garnet



**il diamante**  
diamond



**il topazio**  
topaz



**l'acquamarina**  
aquamarine



**la giada**  
jade



**lo smeraldo**  
emerald



**lo zaffiro**  
sapphire



**la tormalina**  
tourmaline



## i minerali • minerals



**il quarzo**  
quartz



**la mica**  
mica



**lo zolfo**  
sulfur



**l'ematite**  
hematite



**la calcite**  
calcite



**la malachite**  
malachite



**il turchese**  
turquoise



**l'onice**  
onyx

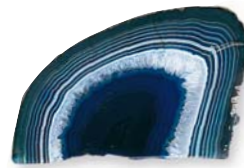

**l'agate**  
agate



**la grafite**  
graphite

## i metalli • metals



**l'oro**  
gold



**l'argento**  
silver



**il platino**  
platinum



**il nichel**  
nickel



**il ferro**  
iron



**il rame**  
copper



**lo stagno**  
tin



**l'alluminio**  
aluminum



**il mercurio**  
mercury



**lo zinco**  
zinc

# gli animali 1 • animals 1

## i mammiferi • mammals



**il coniglio**  
rabbit

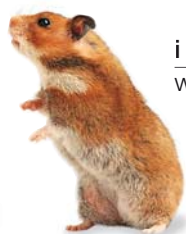

**il criceto**  
hamster

**i baffi**  
whiskers



**il topo**  
mouse

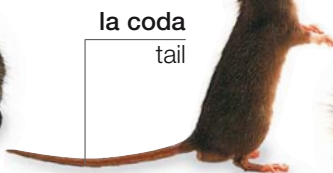

**la coda**  
tail

**il ratto**  
rat



**il riccio**  
hedgehog



**lo scoiattolo**  
squirrel



**il pipistrello**  
bat



**il procione**  
raccoon



**la volpe**  
fox



**il lupo**  
wolf

**il cucciolo**  
puppy



**il cane**  
dog

**il gattino**  
kitten



**il gatto**  
cat

**il cucciolo**  
pup



**la lontra**  
otter



**la foca**  
seal



**il leone marino**  
sea lion

**la pinna**  
flipper

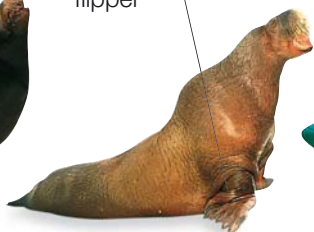

**il tricheco**  
walrus

**lo sfiatoio**  
blowhole

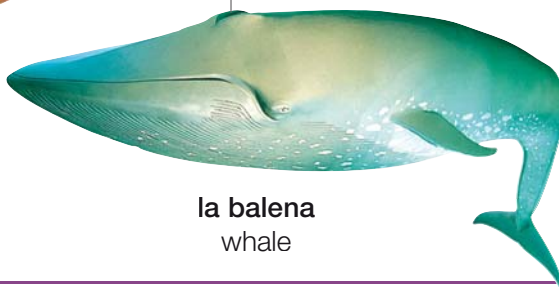

**la balena**  
whale



**il delfino**  
dolphin



le corna  
antler

il cervo  
deer

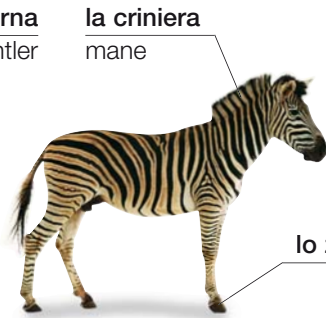

la criniera  
mane

lo zoccolo  
hoof

la zebra  
zebra



la giraffa  
giraffe



la gobba  
hump

il cammello  
camel



l'ippopotamo  
hippopotamus

la proboscide  
trunk

la zanna  
tusk

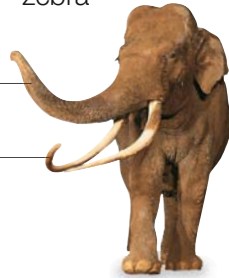

l'elefante  
elephant

il corno  
horn



il rinoceronte  
rhinoceros



la tigre  
tiger



il leone  
lion

la criniera  
mane



la scimmia  
monkey



il gorilla  
gorilla



il koala  
koala



il marsupio  
pouch

il canguro  
kangaroo



l'orso  
bear

l'artiglio  
claw



l'orso polare  
polar bear



il panda  
panda

# gli animali 2 • animals 2

## gli uccelli • birds



**il canarino**  
canary



**il passero**  
sparrow



**il colibrì**  
hummingbird

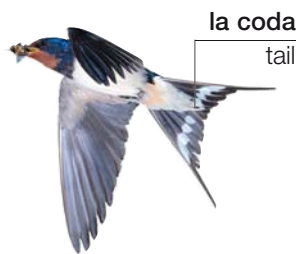

**la rondine**  
swallow



**la cornacchia**  
crow



**il piccione**  
pigeon



**il picchio**  
woodpecker



**il falco**  
falcon



**il gufo**  
owl



**il gabbiano**  
gull

**l'aquila**  
eagle



**il pellicano**  
pelican



**il fenicottero**  
flamingo



**la cicogna**  
stork



**la gru**  
crane



**il pinguino**  
penguin



**lo struzzo**  
ostrich



l'oca | goose



il cigno  
swan

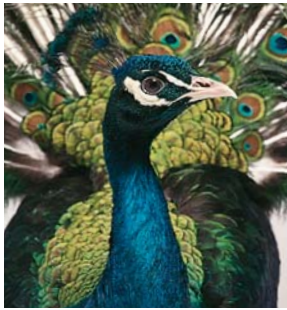

il pavone  
peacock



il fagiano  
pheasant



il tacchino  
turkey



la cacatoa  
cockatoo

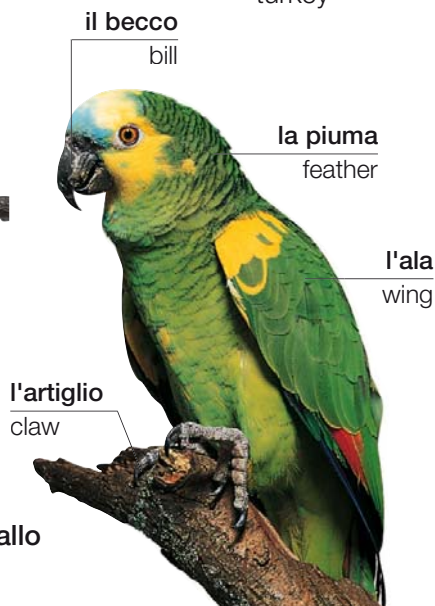

il pappagallo  
parrot

**i rettili • reptiles**

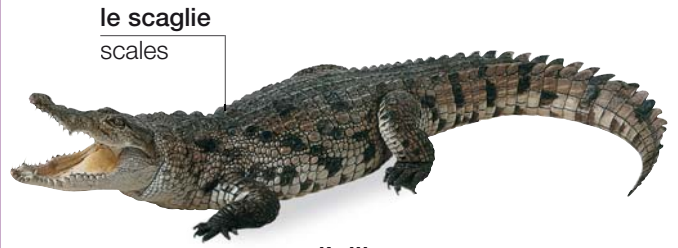

le scaglie  
scales

l'alligatore  
alligator



la lucertola  
lizard

l'iguana  
iguana



il guscio  
shell

la testuggine  
turtle

la tartaruga  
tortoise



il serpente  
snake



il muso  
snout

il coccodrillo  
crocodile

# gli animali 3 • animals 3

## gli anfibi • amphibians



la rana  
frog



il rospo  
toad



il girino  
tadpole



la salamandra  
salamander

## i pesci • fish



l'anguilla  
eel

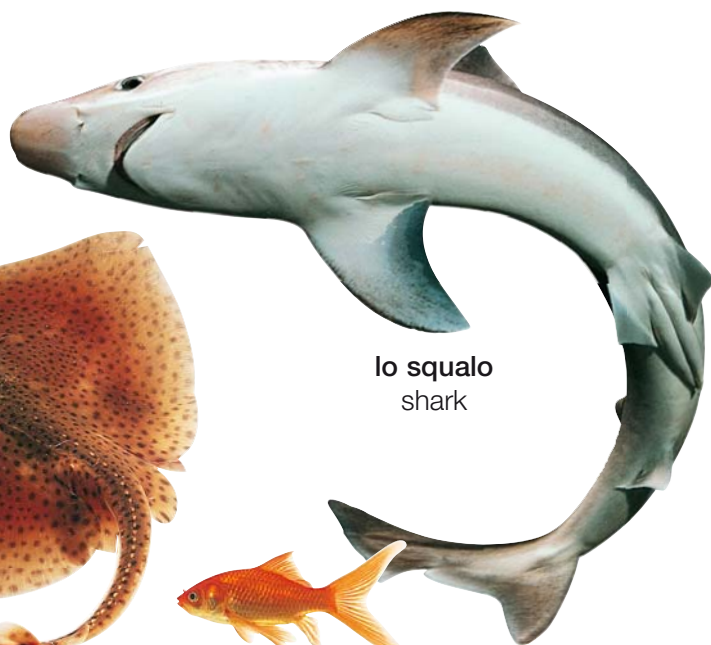

lo squalo  
shark



il cavalluccio  
marino  
sea horse



la razza  
skate

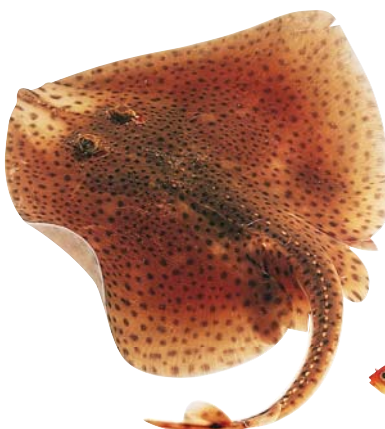

la razza  
ray



il pesce rosso  
goldfish

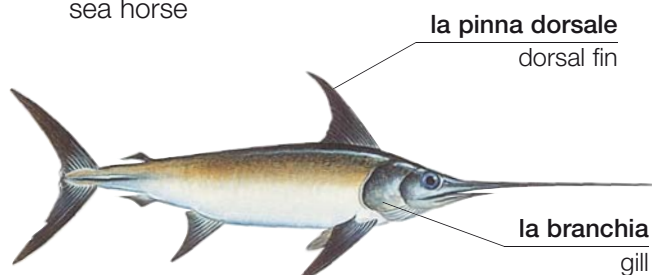

il pesce spada  
swordfish

la pinna dorsale  
dorsal fin

la branchia  
gill

la pinna pettorale  
pectoral fin

la coda  
tail

la scaglia  
scale

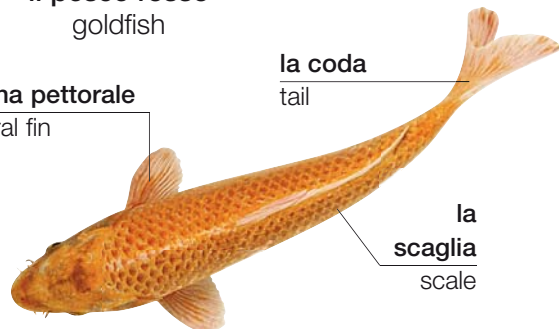

la carpa koi  
koi carp



# gli invertebrati • invertebrates



la formica  
ant



la termite  
termite



l'ape  
bee



la vespa  
wasp



il coleottero  
beetle



lo scarafaggio  
cockroach



la falena  
moth



la farfalla  
butterfly

l'antenna  
antenna



il bozzolo  
cocoon



il bruco  
caterpillar



il grillo  
cricket



la cavalletta  
grasshopper



la mantide religiosa  
praying mantis



lo scorpione  
scorpion

il pungiglione  
sting



il millepiedi  
centipede



la libellula  
dragonfly



la mosca  
fly



la zanzara  
mosquito



la coccinella  
ladybug



il ragno  
spider



la lumaca  
slug



la chiocciola  
snail



il verme  
worm



la stella di mare  
starfish



la cozza  
mussel



il granchio  
crab



l'aragosta  
lobster



la piovra  
octopus



il calamaro  
squid



la medusa  
jellyfish

# le piante • plants

## l'albero • tree

il ramo  
branch

la radice  
root



il larice  
larch



l'acero  
maple



la quercia  
oak



il faggio  
beech



l'olmo  
elm



la betulla  
birch



il tiglio  
lime

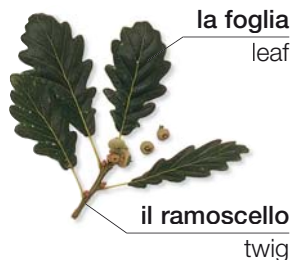

la foglia  
leaf

il ramoscello  
twig

la corteccia  
bark

il tronco  
trunk



il pioppo  
poplar



il pino  
pine



l'agrifoglio  
holly



il salice  
willow



l'eucalipto  
eucalyptus



il cedro  
cedar



la bacca  
berry

la palma  
palm

la pianta da fiori • flowering plant

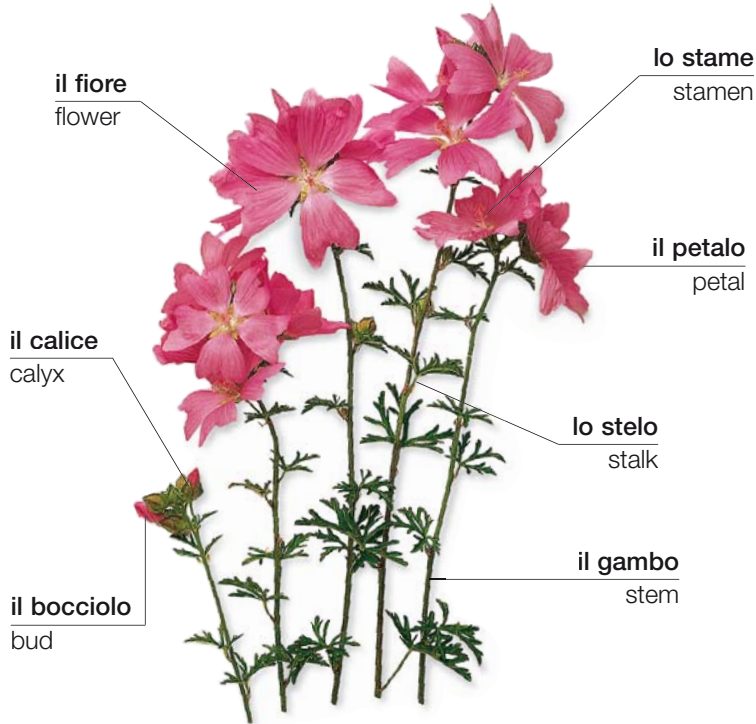

**il ranuncolo**  
buttercup

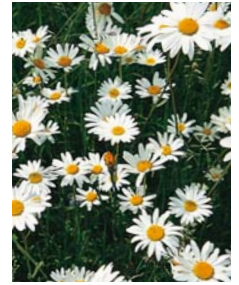

**la margherita**  
daisy



**il cardo**  
thistle



**il dente di leone**  
dandelion



**l'erica**  
heather



**il papavero**  
poppy



**la digitale**  
foxglove



**il caprifoglio**  
honeysuckle



**il girasole**  
sunflower



**il trifoglio**  
clover



**i giacinti di bosco**  
bluebells



**la primula**  
primrose



**i lupini**  
lupines

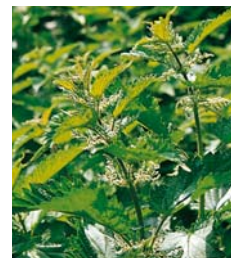

**l'ortica**  
nettle

# la città • town

la strada  
street

il ciglio  
curb

l'angolo della strada  
street corner

il negozio  
shop

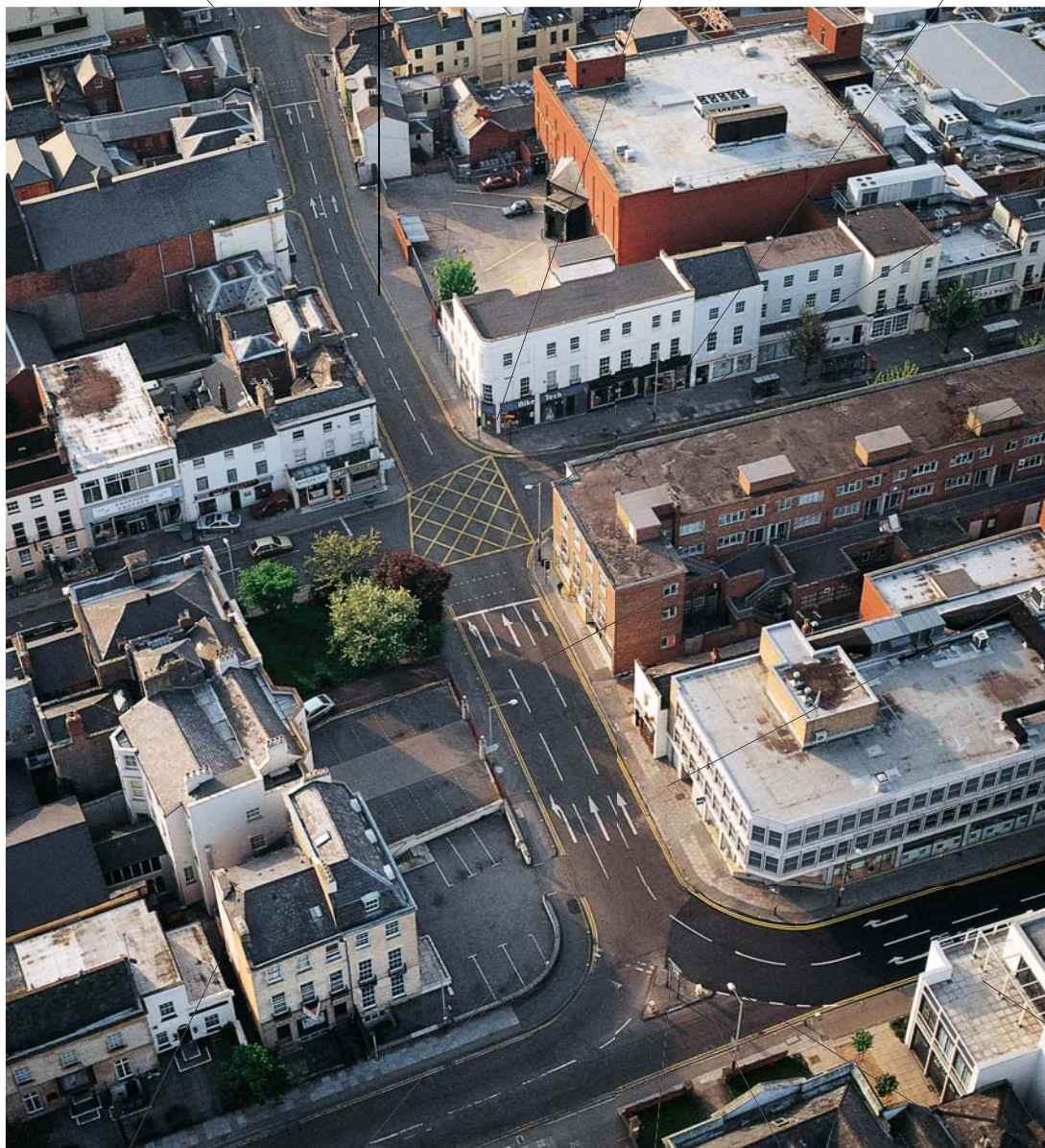

il crocevia  
intersection

il senso  
unico  
one-way  
system

il  
marciapiede  
sidewalk

il complesso  
di uffici  
office building

il  
caseggiato  
apartment  
building

il vicolo  
alley

il parcheggio  
parking lot

il segnale stradale  
street sign

la colonnina  
barrier

il lampione  
street light

gli edifici • buildings



**il municipio**  
town hall



**la biblioteca**  
library



**il cinema**  
movie theater



**il teatro**  
theater



**l'università**  
university



**il grattacielo**  
skyscraper

le zone • areas



**la zona industriale**  
industrial park



**la città**  
city



**la scuola**  
school



**la periferia**  
suburb



**il villaggio**  
village

vocabolario • vocabulary

**la zona pedonale**  
pedestrian zone

**la via laterale**  
side street

**il tombino**  
utility cover

**la cunetta**  
gutter

**la chiesa**  
church

**il viale**  
avenue

**la piazza**  
square

**la fermata  
dell'autobus**  
bus stop

**la fabbrica**  
factory

**il canale  
di scolo**  
drain

# l'architettura • architecture

## edifici e strutture • buildings and structures



**il grattacielo**  
skyscraper



**il castello**  
castle



**la chiesa**  
church

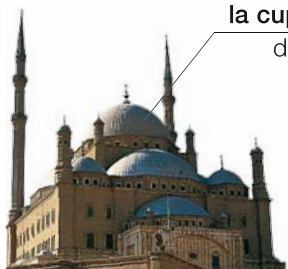

**la moschea**  
mosque



**il tempio**  
temple



**la sinagoga**  
synagogue



**la diga**  
dam



**il ponte**  
bridge



**il pinnacolo**  
finial

**la torre**  
turret

**la spira**  
spire

**il fossato**  
moat

**il frontone**  
gable

**la cupola**  
dome

**la torretta**  
tower

**la volta**  
vault

**il cornicione**  
cornice

**la colonna**  
pillar

**la cattedrale** | cathedral

gli stili • styles



gotico  
gothic

l'architrave  
architrave



rinascimentale  
Renaissance



barocco  
baroque



l'arco  
arch

il fregio  
frieze

il contrafforte  
buttress

il coro  
choir



rococò  
rococo

il frontone  
pediment



neoclassico  
neoclassical

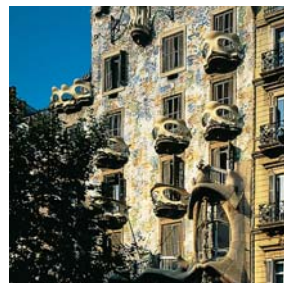

l'art nouveau  
Art Nouveau



art déco  
Art Deco

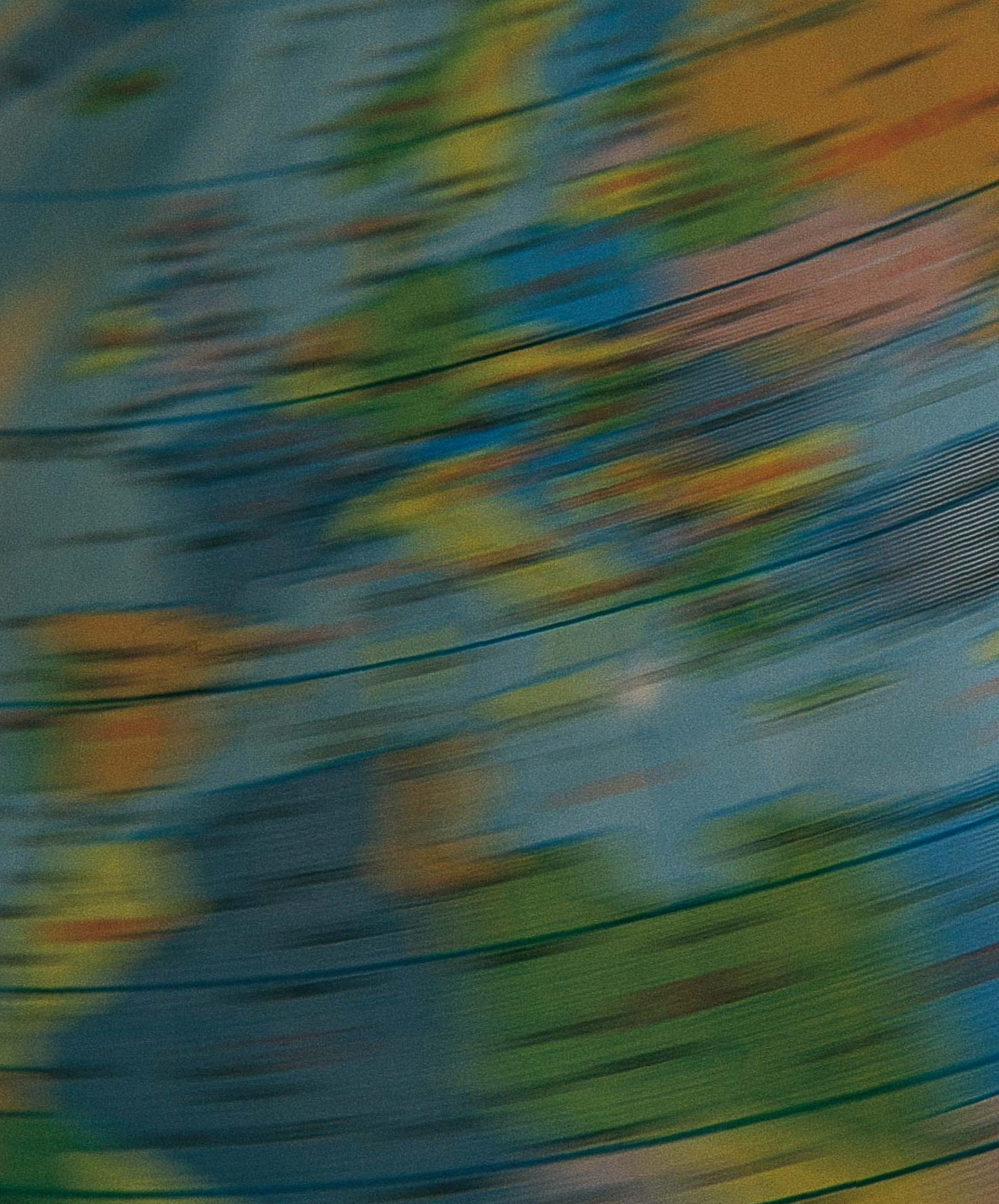





**i dati**  
reference

# l'ora • time

la lancetta dei minuti  
minute hand

la lancetta delle ore  
hour hand



l'orologio  
clock

## vocabolario • vocabulary

<b>il secondo</b> second	<b>adesso</b> now	<b>un quarto d'ora</b> a quarter of an hour
<b>il minuto</b> minute	<b>più tardi</b> later	<b>venti minuti</b> twenty minutes
<b>l'ora</b> hour	<b>una mezzora</b> half an hour	<b>quaranta minuti</b> forty minutes

**Che ore sono?**  
What time is it?

**Sono le tre.**  
It's three o'clock.



**l'una e cinque**  
five after one



**l'una e dieci**  
ten after one



**l'una e un quarto**  
quarter after one



**l'una e venti**  
twenty after one



la lancetta  
dei secondi  
second hand

**l'una e venticinque**  
twenty-five after one



**l'una e trenta**  
one thirty



**le due meno venticinque**  
twenty-five to two



**le due meno venti**  
twenty to two



**le due meno un quarto**  
quarter to two



**le due meno dieci**  
ten to two



**le due meno cinque**  
five to two



**le due**  
two o'clock

# la notte e il giorno • night and day



**la mezzanotte**  
midnight



**il sorgere del sole**  
sunrise



**l'alba**  
dawn



**il mattino**  
morning



**il tramonto**  
sunset



**il mezzogiorno**  
noon



**l'imbrunire**  
dusk



**la sera**  
evening



**il pomeriggio**  
afternoon

## vocabolario • vocabulary

**presto**  
early

**Sei in anticipo.**  
You're early.

**Per favore, vieni in orario.**  
Please be on time.

**A che ora finisce?**  
What time does it end?

**in orario**  
on time

**Sei in ritardo.**  
You're late.

**A più tardi.**  
I'll see you later.

**Quanto durerà?**  
How long will it last?

**tardi**  
late

**Arrivo subito.**  
I'll be there soon.

**A che ora inizia?**  
What time does it start?

**Si sta facendo tardi.**  
It's getting late.

# il calendario • calendar

il mese  
month

l'anno  
year

**gennaio**  
January

2010



il giorno  
day

**lunedì**   **martedì**   **mercoledì**   **giovedì**   **venerdì**   **sabato**   **domenica**  
Monday   Tuesday   Wednesday   Thursday   Friday   Saturday   Sunday

il giorno feriale  
work day

1   2   3   4   5   6   7

la settimana  
week

8   9   10   11   12   13   14

la data  
date

15   16   17   18   19   20   21

**ieri**  
yesterday

**oggi**  
today

**domani**  
tomorrow

**il fine settimana**  
weekend

## vocabolario • vocabulary

**gennaio**  
January

**marzo**  
March

**maggio**  
May

**luglio**  
July

**settembre**  
September

**novembre**  
November

**febbraio**  
February

**aprile**  
April

**giugno**  
June

**agosto**  
August

**ottobre**  
October

**dicembre**  
December

## gli anni • years

**1900** millenovecento • nineteen hundred

**1901** millenovecentouno • nineteen hundred and one

**1910** millenovecentodieci • nineteen ten

**2000** duemila • two thousand

**2001** duemilauno • two thousand and one

## le stagioni • seasons



**la primavera**  
spring



**l'estate**  
summer



**l'autunno**  
fall

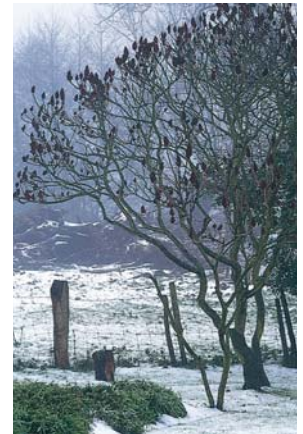

**l'inverno**  
winter

## vocabolario • vocabulary

**il secolo**  
century

**la decade**  
decade

**il millennio**  
millennium

**questa settimana**  
this week

**scorsa**  
last week

**la settimana prossima**  
next week

**l'altroieri**  
the day before yesterday

**il dopodomani**  
the day after tomorrow

**settimanale**  
weekly

**mensile**  
monthly

**annuo**  
annual

**Oggi che giorno è?**  
What's the date today?

**È il sette febbraio, duemiladue.**  
It's February seventh, two thousand and two.

## i numeri • numbers

0	zero • zero	20	venti • twenty
1	uno • one	21	ventuno • twenty-one
2	due • two	22	ventidue • twenty-two
3	tre • three	30	trenta • thirty
4	quattro • four	40	quaranta • forty
5	cinque • five	50	cinquanta • fifty
6	sei • six	60	sessanta • sixty
7	sette • seven	70	settanta • seventy
8	otto • eight	80	ottanta • eighty
9	nove • nine	90	novanta • ninety
10	dieci • ten	100	cento • one hundred
11	undici • eleven	110	centodieci • one hundred and ten
12	dodici • twelve	200	duecento • two hundred
13	tredici • thirteen	300	trecento • three hundred
14	quattordici • fourteen	400	quattrocento • four hundred
15	quindici • fifteen	500	cinquecento • five hundred
16	sedici • sixteen	600	seicento • six hundred
17	diciassette • seventeen	700	settecento • seven hundred
18	diciotto • eighteen	800	ottocento • eight hundred
19	diciannove • nineteen	900	novecento • nine hundred

1000	<b>mille</b> • one thousand
10,000	<b>diecimila</b> • ten thousand
20,000	<b>ventimila</b> • twenty thousand
50,000	<b>cinquantamila</b> • fifty thousand
55,500	<b>cinquantacinquemilacinquecento</b> • fifty-five thousand five hundred
100,000	<b>centomila</b> • one hundred thousand
1,000,000	<b>un milione</b> • one million
1,000,000,000	<b>un miliardo</b> • one billion

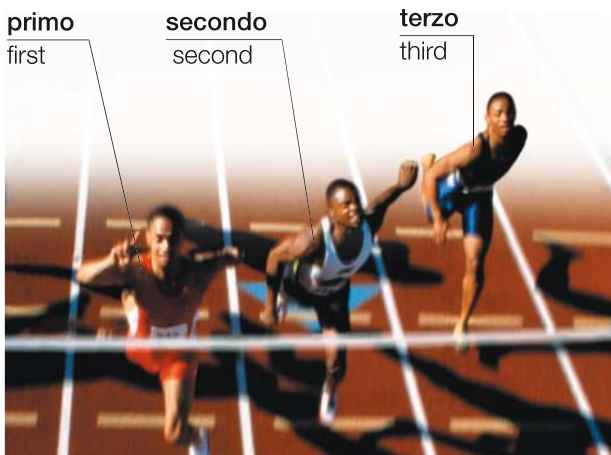

<b>quarto</b> • fourth	<b>decimo</b> • tenth
<b>quinto</b> • fifth	<b>undicesimo</b> • eleventh
<b>sesto</b> • sixth	<b>dodicesimo</b> • twelfth
<b>settimo</b> • seventh	<b>treddicesimo</b> • thirteenth
<b>ottavo</b> • eighth	<b>quattordicesimo</b> • fourteenth
<b>nono</b> • ninth	<b>quindicesimo</b> • fifteenth

**sedicesimo**  
• sixteenth

**diciassettesimo**  
• seventeenth

**diciottesimo**  
• eighteenth

**diciannovesimo**  
• nineteenth

**ventesimo**  
• twentieth

**ventunesimo**  
• twenty-first

**ventiduesimo**  
• twenty-second

**ventitreesimo**  
• twenty-third

**trentesimo** • thirtieth

**quarantesimo**  
• fortieth

**cinquantesimo**  
• fiftieth

**sessantesimo**  
• sixtieth

**settantesimo**  
• seventieth

**ottantesimo**  
• eightieth

**novantesimo**  
• ninetieth

**centesimo**  
• hundredth

# i pesi e le misure • weights and measures

## la superficie • area

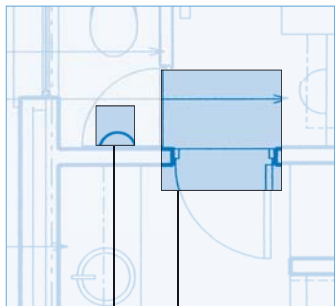

il piede  
quadro  
square  
foot

il metro  
quadro  
square meter

## la distanza • distance

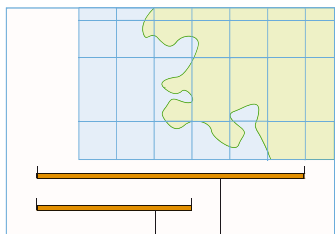

il chilometro  
kilometer

il miglio  
mile

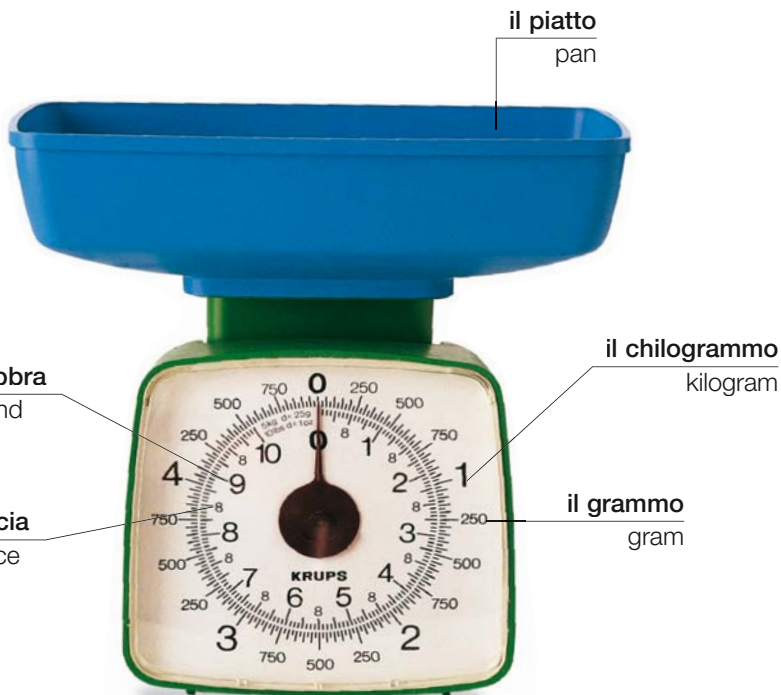

il piatto  
pan

la libbra  
pound

l'oncia  
ounce

il chilogrammo  
kilogram

il grammo  
gram

la bilancia | scale

## vocabolario • vocabulary

la iarda  
yard

la tonnellata  
ton

misurare  
measure (v)

il metro  
meter

il milligrammo  
milligram

pesare  
weigh (v)

## la lunghezza • length

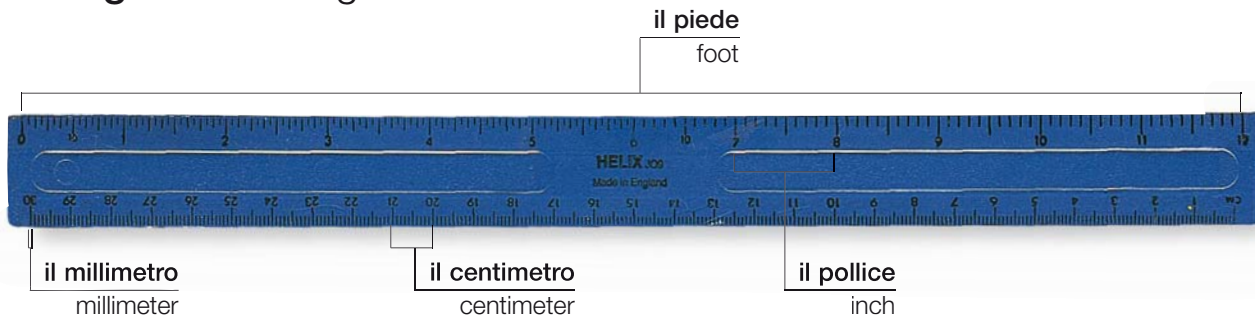

il piede  
foot

il millimetro  
millimeter

il centimetro  
centimeter

il pollice  
inch



la capacità • capacity

il mezzo litro  
half-liter

la pinta  
pint

il volume  
volume

il millilitro  
milliliter



la brocca graduata  
measuring cup



la misura di liquido  
liquid measure

vocabolario •  
vocabulary

il gallone  
gallon

il quarto di  
gallone  
quart

il litro  
liter

il contenitore • container



il cartone  
carton



il pacchetto  
packet



il bottiglia  
bottle



il sacchetto  
bag



la vaschetta | tub



il barattolo | jar



la lattina  
can

la scatoletta | tin



il nebulizzatore  
spray bottle

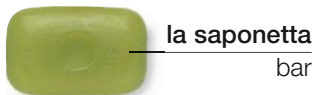

la saponetta  
bar



il tubetto  
tube



il rotolo  
roll



il pacchetto  
pack



la bomboletta spray  
spray can

# il mappamondo • world map

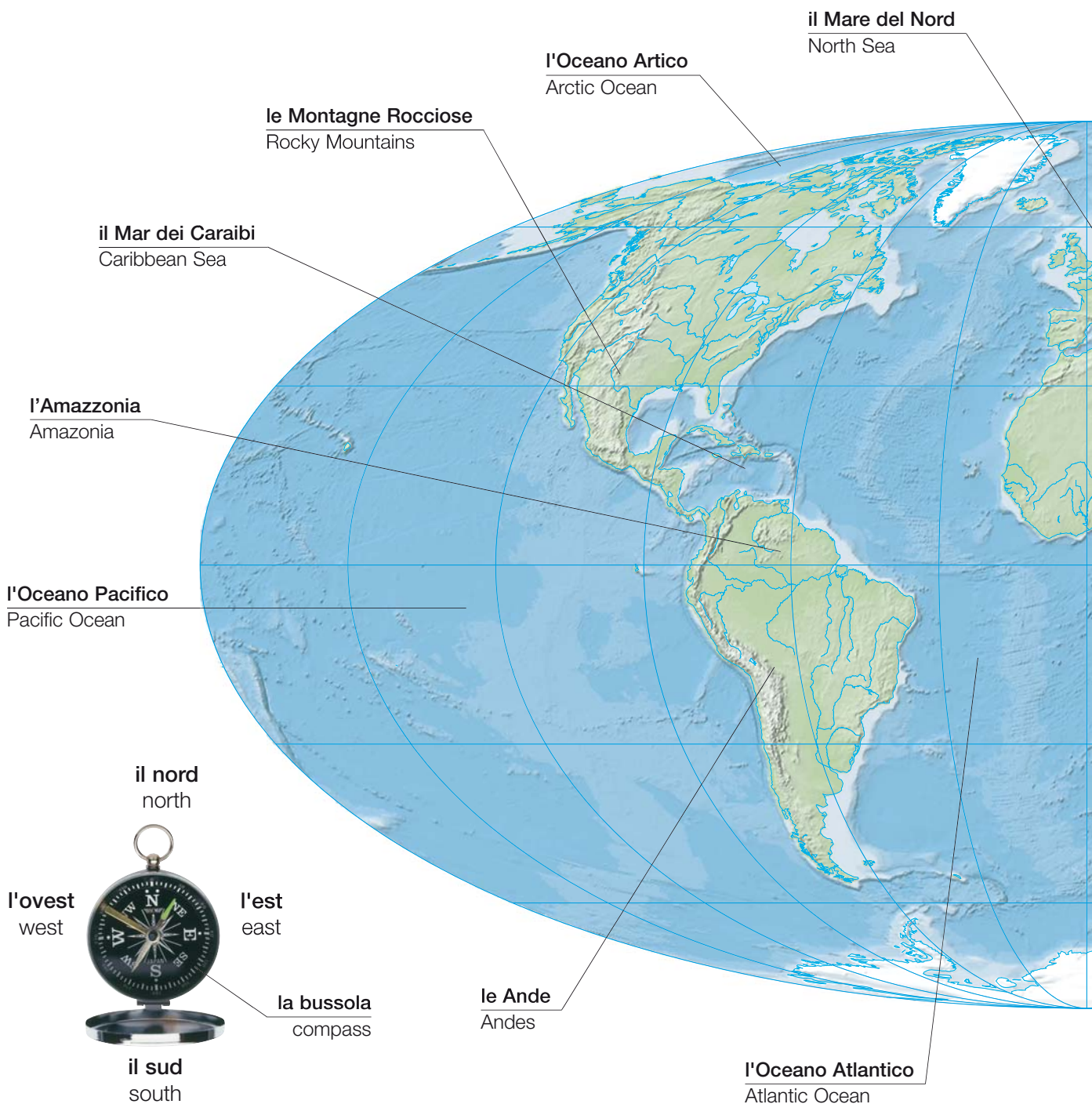

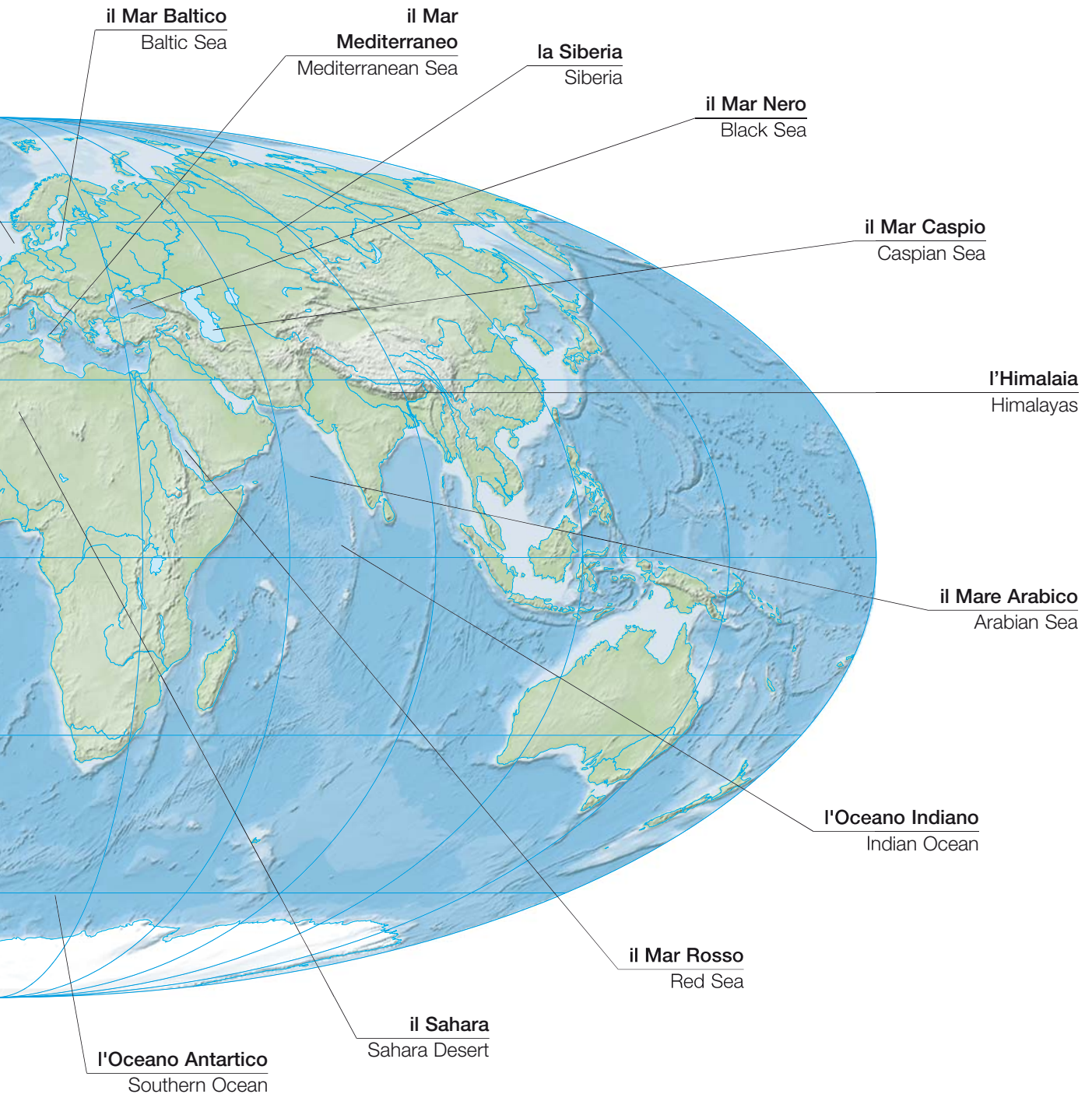

# I'America del Nord e Centrale • North and Central America



- 1 **l'Alaska** • Alaska
- 2 **il Canada** • Canada
- 3 **la Groenlandia** • Greenland
- 4 **gli Stati Uniti d'America**  
• United States of America
- 5 **il Messico** • Mexico
- 6 **il Guatemala** • Guatemala
- 7 **il Belize** • Belize
- 8 **l'El Salvador** • El Salvador
- 9 **l'Honduras** • Honduras
- 10 **il Nicaragua** • Nicaragua
- 11 **il Costa Rica** • Costa Rica
- 12 **il Panama** • Panama
- 13 **Cuba** • Cuba
- 14 **le Bahamas** • Bahamas
- 15 **la Giamaica** • Jamaica
- 16 **Haiti** • Haiti
- 17 **la Repubblica Dominicana**  
• Dominican Republic
- 18 **Puerto Rico** • Puerto Rico
- 19 **Barbados** • Barbados
- 20 **Trinidad e Tobago** • Trinidad and Tobago
- 21 **Saint Kitts-Nevis** • St. Kitts and Nevis
- 22 **Antigua e Barbuda** • Antigua and Barbuda
- 23 **Dominica** • Dominica
- 24 **Saint Lucia** • St. Lucia
- 25 **Saint Vincent e Grenadine**  
• St. Vincent and The Grenadines
- 26 **Grenada** • Grenada

# I'America del Sud • South America



- 1 **il Venezuela** • Venezuela
- 2 **la Colombia** • Colombia
- 3 **l'Ecuador** • Ecuador
- 4 **il Perù** • Peru
- 5 **le Isole Galapagos**
  - Galapagos Islands
- 6 **la Guyana** • Guyana
- 7 **il Suriname** • Suriname
- 8 **la Guyana Francese**
  - French Guiana
- 9 **il Brasile** • Brazil
- 10 **la Bolivia** • Bolivia
- 11 **il Cile** • Chile
- 12 **l'Argentina** • Argentina
- 13 **il Paraguay** • Paraguay
- 14 **l'Uruguay** • Uruguay
- 15 **le Isola Falkland** • Falkland Islands

## vocabolario • vocabulary

<b>il continente</b>	<b>la provincia</b>	<b>il distretto</b>
country	province	district

<b>il paese</b>	<b>il territorio</b>	<b>la zona</b>
nation	territory	zone

<b>la nazione</b>	<b>la colonia</b>	<b>la regione</b>
state	principality	region

<b>lo stato</b>	<b>il principato</b>	<b>la capitale</b>
continent	colony	capital

# I'Europa • Europe

- 1 **I' Irlanda** • Ireland
- 2 **il Regno Unito**
  - United Kingdom
- 3 **il Portogallo** • Portugal
- 4 **la Spagna** • Spain
- 5 **le Isole Baleari**
  - Balearic Islands
- 6 **Andorra** • Andorra
- 7 **la Francia** • France
- 8 **il Belgio** • Belgium
- 9 **i Paesi Bassi** • Netherlands
- 10 **il Lussemburgo**
  - Luxembourg
- 11 **la Germania** • Germany
- 12 **la Danimarca** • Denmark
- 13 **la Norvegia** • Norway
- 14 **la Svezia** • Sweden
- 15 **la Finlandia** • Finland
- 16 **l'Estonia** • Estonia
- 17 **la Lettonia** • Latvia
- 18 **la Lituania** • Lithuania
- 19 **Kaliningrad** • Kaliningrad
- 20 **la Polonia** • Poland
- 21 **la Repubblica Ceca**
  - Czech Republic
- 22 **l'Austria** • Austria
- 23 **il Liechtenstein**
  - Liechtenstein
- 24 **la Svizzera**
  - Switzerland
- 25 **l'Italia** • Italy
- 26 **Monaco**
  - Monaco
- 27 **la Corsica**
  - Corsica
- 28 **la Sardegna**
  - Sardinia
- 29 **San Marino** • San Marino

- 30 **la Città del Vaticano**
  - Vatican City
- 31 **la Sicilia** • Sicily
- 32 **Malta** • Malta
- 33 **la Slovenia** • Slovenia
- 34 **la Croazia** • Croatia
- 35 **l'Ungheria** • Hungary
- 36 **la Slovacchia** • Slovakia
- 37 **l'Ucraina** • Ukraine
- 38 **la Bielorussia** • Belarus
- 39 **la Moldavia** • Moldova

- 40 **la Romania** • Romania
- 41 **la Jugoslavia** • Yugoslavia
- 42 **la Bosnia ed Erzegovina**
  - Bosnia and Herzegovina
- 43 **l'Albania** • Albania
- 44 **la Macedonia** • Macedonia
- 45 **la Bulgaria** • Bulgaria
- 46 **la Grecia** • Greece
- 47 **la Turchia** • Turkey
- 48 **Cipro** • Cyprus

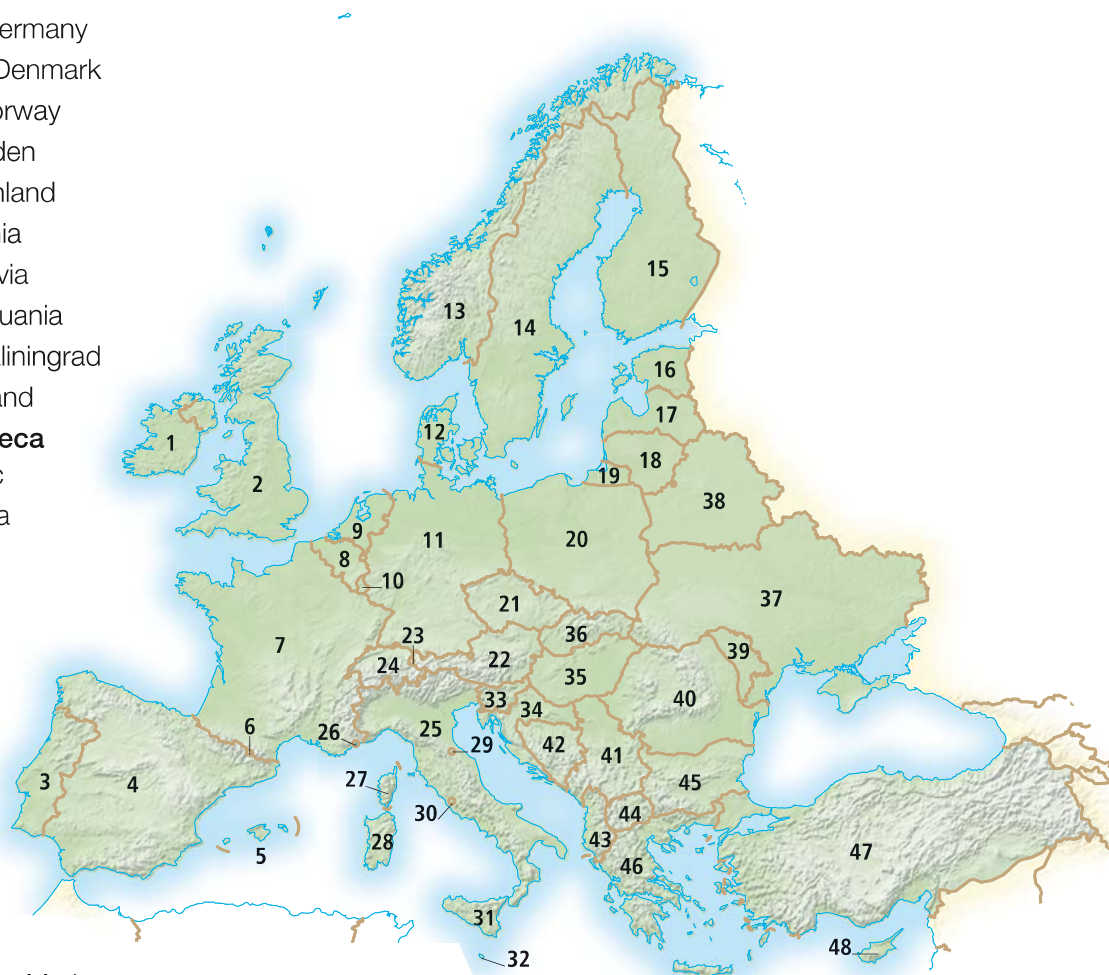

# l'Africa • Africa

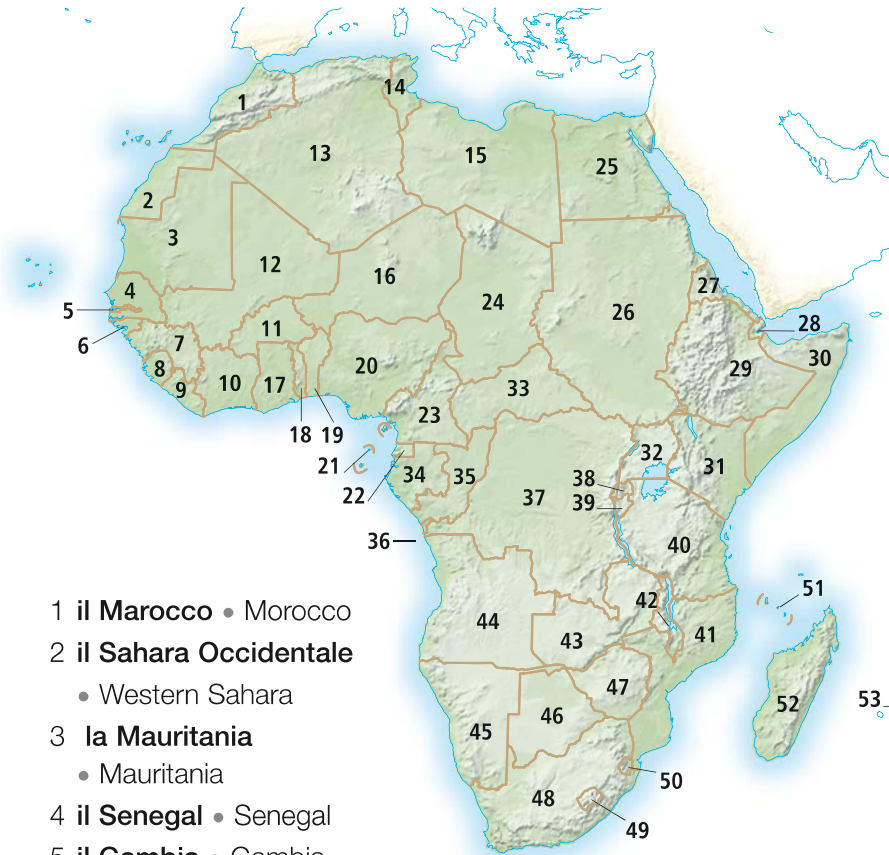

- 1 **il Marocco** • Morocco
- 2 **il Sahara Occidentale**
  - Western Sahara
- 3 **la Mauritania**
  - Mauritania
- 4 **il Senegal** • Senegal
- 5 **il Gambia** • Gambia
- 6 **la Guinea-Bissau**
  - Guinea-Bissau
- 7 **la Guinea** • Guinea
- 8 **Sierra Leone**
  - Sierra Leone
- 9 **la Liberia** • Liberia
- 10 **la Costa d'Avorio**
  - Ivory Coast
- 11 **il Burkina Faso**
  - Burkina Faso
- 12 **il Mali** • Mali
- 13 **l'Algeria** • Algeria
- 14 **la Tunisia** • Tunisia
- 15 **la Libia** • Libya
- 16 **il Niger** • Niger
- 17 **il Ghana** • Ghana

- 18 **il Togo** • Togo
- 19 **il Benin** • Benin
- 20 **la Nigeria** • Nigeria
- 21 **São Tomé e Príncipe**
  - São Tomé and Príncipe
- 22 **la Guinea Equatoriale**
  - Equatorial Guinea
- 23 **il Camerun** • Cameroon
- 24 **il Ciad** • Chad
- 25 **l'Egitto** • Egypt
- 26 **il Sudan** • Sudan
- 27 **l'Eritrea** • Eritrea
- 28 **Gibuti** • Djibouti
- 29 **l'Etiopia** • Ethiopia
- 30 **la Somalia** • Somalia

- 31 **il Kenya** • Kenya
- 32 **l'Uganda** • Uganda
- 33 **la Repubblica Centrafricana**
  - Central African Republic
- 34 **il Gabon** • Gabon
- 35 **il Congo** • Congo
- 36 **Cabinda** • Cabinda
- 37 **la Repubblica Democratica del Congo** • Democratic Republic of the Congo
- 38 **il Ruanda** • Rwanda
- 39 **il Burundi** • Burundi
- 40 **la Tanzania** • Tanzania
- 41 **il Mozambico** • Mozambique
- 42 **il Malawi** • Malawi
- 43 **lo Zambia** • Zambia
- 44 **l'Angola** • Angola
- 45 **la Namibia** • Namibia
- 46 **il Botswana** • Botswana
- 47 **lo Zimbabwe** • Zimbabwe
- 48 **il Sud Africa** • South Africa
- 49 **il Lesotho** • Lesotho
- 50 **lo Swaziland** • Swaziland
- 51 **le Comore** • Comoros
- 52 **il Madagascar** • Madagascar
- 53 **la Mauritania** • Mauritius

# I'Asia • Asia

- 1 **la Federazione Russa**
  - Russian Federation
- 2 **la Georgia** • Georgia
- 3 **l'Armenia** • Armenia
- 4 **l'Azerbaijan** • Azerbaijan
- 5 **l'Iran** • Iran
- 6 **l'Iraq** • Iraq
- 7 **la Siria** • Syria
- 8 **il Libano** • Lebanon
- 9 **l'Israele** • Israel
- 10 **la Giordania** • Jordan
- 11 **l'Arabia Saudita**
  - Saudi Arabia
- 12 **il Kuwait** • Kuwait
- 13 **il Qatar** • Qatar
- 14 **gli Emirati Arabi Uniti**
  - United Arab Emirates
- 15 **l'Oman** • Oman
- 16 **lo Yemen** • Yemen
- 17 **il Kazakistan** • Kazakhstan
- 18 **l'Uzbekistan** • Uzbekistan
- 19 **il Turkmenistan** • Turkmenistan
- 20 **l'Afghanistan** • Afghanistan
- 21 **il Tagikistan** • Tajikistan
- 22 **il Kirghizistan** • Kyrgyzstan
- 23 **il Pakistan** • Pakistan
- 24 **l'India** • India
- 25 **le Maldive** • Maldives
- 26 **lo Sri Lanka** • Sri Lanka
- 27 **la Cina** • China
- 28 **la Mongolia** • Mongolia
- 29 **la Corea del Nord** • North Korea
- 30 **la Corea del Sud** • South Korea
- 31 **il Giappone** • Japan
- 32 **il Nepal** • Nepal
- 33 **il Bhutan** • Bhutan
- 34 **il Bangladesh** • Bangladesh



- 35 **la Birmania**  
(il Myanmar)
  - Burma (Myanmar)
- 36 **la Thailandia** • Thailand
- 37 **il Laos** • Laos
- 38 **il Vietnam** • Vietnam
- 39 **la Cambogia** • Cambodia
- 40 **la Malaysia** • Malaysia





## l'Oceania • Australasia



- 1 **l'Australia** • Australia
- 2 **la Tasmania** • Tasmania
- 3 **la Nuova Zelanda** • New Zealand

- 41 **Singapore** • Singapore
- 42 **l'Indonesia** • Indonesia
- 43 **Brunei** • Brunei
- 44 **le Filippine** • Philippines
- 45 **Taiwan** • Taiwan
- 46 **Timor Est** • East Timor
- 47 **la Papua Nuova Guinea**  
• Papua New Guinea
- 48 **le Isole Salomone** • Solomon Islands
- 49 **Vanuatu** • Vanuatu
- 50 **Fiji** • Fiji

# particelle e antonimi • particles and antonyms

<b>a</b> to	<b>da</b> from	<b>per</b> for	<b>verso</b> toward
<b>sopra</b> over	<b>sotto</b> under	<b>lungo</b> along	<b>attraverso</b> across
<b>davanti</b> in front of	<b>dietro</b> behind	<b>con</b> with	<b>senza</b> without
<b>sopra</b> onto	<b>dentro</b> into	<b>prima</b> before	<b>dopo</b> after
<b>dentro</b> in	<b>fuori</b> out	<b>entro</b> by	<b>fino</b> until
<b>sopra</b> above	<b>sotto</b> below	<b>di buon'ora</b> early	<b>in ritardo</b> late
<b>all'interno</b> inside	<b>all'esterno</b> outside	<b>adesso</b> now	<b>più tardi</b> later
<b>su</b> up	<b>giù</b> down	<b>sempre</b> always	<b>non mai</b> never
<b>a</b> at	<b>oltre</b> beyond	<b>sovente</b> often	<b>raramente</b> rarely
<b>attraverso</b> through	<b>attorno</b> around	<b>ieri</b> yesterday	<b>domani</b> tomorrow
<b>in cima</b> on top of	<b>accanto</b> beside	<b>primo</b> first	<b>ultimo</b> last
<b>tra</b> between	<b>di fronte</b> opposite	<b>tutti</b> every	<b>alcuni</b> some
<b>vicino</b> near	<b>lontano</b> far	<b>circa</b> about	<b>esattamente</b> exactly
<b>qui</b> here	<b>là</b> there	<b>un poco</b> a little	<b>molto</b> a lot

<b>grande</b> large	<b>piccolo</b> small	<b>caldo</b> hot	<b>freddo</b> cold
<b>largo</b> wide	<b>stretto</b> narrow	<b>aperto</b> open	<b>chiuso</b> closed
<b>alto</b> tall	<b>basso</b> short	<b>pieno</b> full	<b>vuoto</b> empty
<b>alto</b> high	<b>basso</b> low	<b>nuovo</b> new	<b>vecchio</b> old
<b>spesso</b> thick	<b>sottile</b> thin	<b>chiaro</b> light	<b>scuro</b> dark
<b>leggero</b> light	<b>pesante</b> heavy	<b>facile</b> easy	<b>difficile</b> difficult
<b>duro</b> hard	<b>morbido</b> soft	<b>libero</b> free	<b>occupato</b> occupied
<b>bagnato</b> wet	<b>asciutto</b> dry	<b>forte</b> strong	<b>debole</b> weak
<b>buono</b> good	<b>cattivo</b> bad	<b>grasso</b> fat	<b>magro</b> thin
<b>veloce</b> fast	<b>lento</b> slow	<b>giovane</b> young	<b>vecchio</b> old
<b>sbagliato</b> correct	<b>giusto</b> wrong	<b>migliore</b> better	<b>peggiore</b> worse
<b>pulito</b> clean	<b>sporco</b> dirty	<b>nero</b> black	<b>bianco</b> white
<b>bellissimo</b> beautiful	<b>brutto</b> ugly	<b>interessante</b> interesting	<b>noioso</b> boring
<b>caro</b> expensive	<b>a buon prezzo</b> cheap	<b>malato</b> sick	<b>bene</b> well
<b>silenzioso</b> quiet	<b>rumoroso</b> noisy	<b>l'inizio</b> beginning	<b>la fine</b> end

## frasi utili • useful phrases

## frasi essenziali

• essential phrases

**Sì**

Yes

**No**

No

**Forse**

Maybe

**Per favore**

Please

**Grazie**

Thank you

**Prego**

You're welcome

**Permesso**

Excuse me

**Mi dispiace**

I'm sorry

**No**

Don't

**D'accordo**

OK

**Vabbene**

That's fine

**È giusto**

That's correct

**È sbagliato**

That's wrong

## saluti

• greetings

**Buongiorno**

Hello

**Arrivederci**

Goodbye

**Buongiorno**

Good morning

**Buon pomeriggio**

Good afternoon

**Buona sera**

Good evening

**Buona notte**

Good night

**Come sta?**

How are you?

**Mi chiamo...**

My name is...

**Come si chiama?**

What is your name?

**Come si chiama lui/lei?**

What is his/her name?

**Le presento...**

May I introduce...

**Questo è...**

This is...

**Piacere di conoscerla**

Pleased to meet you

## A più tardi

See you later

## insegne • signs

**Ufficio informazioni turistiche**

Tourist information

**Entrata**

Entrance

**Uscita**

Exit

**Uscita di emergenza**

Emergency exit

**Spingere**

Push

**Pericolo**

Danger

**Vietato fumare**

No smoking

**Guasto**

Out of order

**Orario di apertura**

Opening times

**Ingresso libero**

Free admission

**Ridotto**

Reduced

**Saldi**

Sale

**Bussare prima di entrare**

Knock before entering

**Non calpestare l'erba**

Keep off the grass

**aiuto • help**

**Mi può aiutare?**

Can you help me?

**Non capisco**

I don't understand

**Non lo so**

I don't know

**Parla inglese, francese...?**

Do you speak English, French...?

**Parlo inglese, spagnolo...**

I speak English, Spanish...

**Parli più lentamente**

Please speak more slowly

**Me lo scriva, per favore**

Please write it down for me

**Ho perso...**

I have lost...

**indicazione •**  
directions

**Mi sono perso/a**  
I am lost

**Dov'è il/la...?**  
Where is the...?

**Dov'è il/la ... più vicino/a?**  
Where is the nearest...?

**Dov'è il bagno?**  
Where are the restrooms?

**Come si arriva a...?**  
How do I get to...?

**A destra**  
To the right

**A sinistra**  
To the left

**Sempre dritto**  
Straight ahead

**Quant'è lontano...?**  
How far is...?

**i cartelli stradali**  
• road signs

**Pedaggio**  
Toll

**Attenzione**  
Caution

**Ingresso vietato**  
No entry

**Rallentare**  
Slow down

**Deviazione**  
Detour

**Giri a destra**  
Turn right

**Autostrada**  
Freeway

**Sosta vietata**  
No parking

**Divieto di transito**  
No through road

**Senso unico**  
One-way street

**Escluso residenti**  
Residents only

**Lavori in corso**  
Road construction

**Incrocio pericoloso**  
Dangerous intersection

**alloggio**  
• accommodation

**Ho una prenotazione**  
I have a reservation

**A che ora è la colazione?**  
What time is breakfast?

**Dov'è la sala da pranzo?**  
Where is the dining room?

**Il mio numero di stanza è ...**  
My room number is ...

**Tornerò alle ...**  
I'll be back at ... o'clock

**Parto domani**  
I'm leaving tomorrow

**cibo e bevande**  
• eating and drinking

**Salute!**  
Cheers!

**È buonissimo/disgustoso**  
It's delicious/awful

**Non bevo/fumo**  
I don't drink/smoke

**Non mangio la carne**  
I don't eat meat

**Per me basta, grazie**  
No more for me, thank you

**Posso prenderne ancora?**  
May I have some more?

**Il conto, per favore.**  
May we have the bill/check?

**Mi dà una ricevuta?**  
Can I have a receipt?

**Area riservata ai non fumatori**  
No-smoking area

**la salute**  
• health

**Non mi sento bene**  
I don't feel well

**Ho la nausea**  
I feel sick

**Mi fa male ...**  
I have a pain in ...

**Dove posso trovare un medico?**  
Where can I find a doctor?

**Starà bene?**  
Will he/she be all right?

**Mi fa male qui**  
It hurts here

**Ho la febbre**  
I have a fever

**Sono incinta di ... mesi**  
I'm ... months pregnant

**Avrei bisogno di una ricetta per ...**  
I need a prescription for ...

**Generalmente prendo ...**  
I normally take ...

**Sono allergico a ...**  
I'm allergic to ...

# indice italiano • Italian index

- A**  
 a 320  
 a chicco corto 130  
 a chicco lungo 130  
 a due porte 200  
 a foglie caduche 86  
 a la carte 152  
 a quattro porte 200  
 a schiera 58  
 a tre porte 200  
 a zero 230  
 abbaino *m* 58  
 abbigliamento *m* 205  
 abbigliamento da  
   donna *m* 105, 34  
 abbigliamento da uomo *m*  
   105, 32  
 abboccare 245  
 abbronzatura *f* 41  
 abiti da bambino *m* 30  
 abito *m* 32  
 abito da sera *m* 34  
 abito da sposa *m* 35  
 aborto spontaneo *m* 52  
 abramide *f* 120  
 acacia *f* 110  
 accademia di danza *f*  
   169  
 accanto 320  
 accappatoio *m* 73  
 acceleratore *m* 200, 204  
 accendere la televisione  
   269  
 accendere un fuoco  
   266  
 accendino *m* 112  
 accensione *f* 200  
 accesso per sedie a  
   rotelle *m* 197  
 accessori *m* 36, 38  
 accessori per la pulizia *m*  
   77  
 acchiappare 227, 229  
 acciaio inossidabile *m* 79  
 acconciature *f* 39  
 accordo di affari *m* 175  
 account di posta  
   elettronica *m* 177  
 accusa *m* 94  
 accusato *m* 180  
 acerbo 129  
 acero *m* 296  
 aceto *m* 135, 142  
 aceto balsamico *m* 135  
 aceto di malto *m* 135  
 aceto di sidro *m* 135  
 aceto di vino *m* 135  
 acetone *m* 41  
 acetosa *f* 123  
 acqua *f* 144, 238  
 acqua dal rubinetto *f*  
   144  
 acqua di colonia *f* 41  
 acqua in bottiglia *f* 144  
 acqua liscia *f* 144  
 acqua minerale *m* 144  
 acqua tonica *f* 144  
 acquaio *m* 61  
 acquamarina *f* 288  
 acquaragia *f* 83  
 acquarello *m* 274  
 acquascooter *m* 241  
 acquisti *m* 104  
 addebito diretto *m* 96  
 addetta alla ricezione *f*  
   100, 190  
 addetto alle pulizie *m*  
   188  
 addome *m* 12  
 addominali *m* 16  
 addormentarsi 71  
 adesso 304  
 adolescente *m* 23  
 adulto *m* 23  
 aerare 91  
 aereo biposto *m* 211  
 aereo da caccia *m* 211  
 aereo da diporto *m* 211  
 aereo di linea *m* 210,  
   212  
 aereo privato *m* 211  
 aereo supersonico *m*  
   211  
 aeroplano *m* 210  
 aeroporto *m* 212  
 affamato 64  
 affari *m* 175  
 affettare 67  
 affettatrice *f* 139  
 affilacoltelli *m* 68, 118  
 affilatore *m* 81  
 affittare 58  
 affitto *m* 58  
 affogare 67  
 affogato 159  
 affrancatura *f* 98  
 affumicato 118, 121,  
   143, 159  
 Afghanistan 318  
 Africa 317  
 agate *m* 289  
 agenda *f* 173, 175  
 agente *m* 94  
 agente di viaggio *m* 190  
 agente immobiliare *f* 189  
 agenzia di viaggi *f* 114  
 agenzia immobiliare *f*  
   115  
 aggressione *f* 94  
 aggrottare le ciglia 25  
 aglio *m* 125, 132  
 agnello *m* 118, 185  
 ago *m* 109, 276  
 agopressione *f* 55  
 agopuntura *f* 55  
 agosto 306  
 agricoltore *m* 182, 189  
 agrifoglio *m* 296  
 agrumi *m* 126  
 aia *f* 182  
 aikido *m* 236  
 airbag *m* 201  
 aiuola *f* 85, 90  
 aiuto cuoco *m* 152  
 al ginocchio 34  
 al sugo 159  
 al vapore 159  
 ala *f* 119, 210, 293  
 Alaska 314  
 alba *f* 305  
 Albania 316  
 albergo *m* 100, 264  
 albero *m* 86, 240, 296  
 albero di trasmissione *m*  
   202  
 albicocca *f* 126  
 album fotografico *m* 271  
 alchecengi *m* 128  
 alesatore *m* 80  
 aletta *f* 210  
 alettone *m* 210  
 alfalfa *m* 184  
 alfiere *m* 272  
 Algeria 317  
 aliante *m* 211, 248  
 alimentazione di rete *f* 60  
 aliscafo *m* 215  
 all'esterno 320  
 all'interno 320  
 alla caviglia 34  
 alla griglia 159  
 allacciato dietro il collo  
   35  
 allarme antifumo *m* 95  
 allarme antifurto *m* 58  
 allarme antincendio *m*  
   95  
 allattamento *m* 53  
 allattamento al seno *m*  
   53  
 allegato *m* 177  
 allenamento *m* 237  
 allenamento a circuito *m*  
   251  
 allenamento con i pesi *m*  
   251  
 allenarsi 251  
 allenatore *m* 54  
 allergia *f* 44  
 allevamento di maiali *m*  
   183  
 allevamento di pecore *m*  
   183  
 alligatore *m* 293  
 allisciare 39  
 allo sciroppo 159  
 alloro *m* 133  
 alluce *m* 15  
 alluminio *m* 289  
 alpinismo in parete *m*  
   248  
 altalena *f* 263  
 alternatore *m* 203  
 altezza *f* 165  
 altipiano *m* 284  
 alto 98, 321  
 altoparlante *m* 176, 258,  
   268  
 altre imbarcazioni *f* 215  
 altri lavori artigianali 275  
 altri negozi *m* 114  
 altri sport *m* 248  
 altroieri *m* 307  
 alunno *m* 162  
 alzarsi 71  
 alzarsi a sedere 251  
 alzate con il manubrio *f*  
   251  
 amaca *f* 266  
 amaro 124, 127  
 Amazzonia *f* 312  
 ambiente *m* 280  
 ambulanza *f* 94  
 ambulatorio *m* 45, 168  
 America Centrale 314  
 America del Nord 314  
 America del Sud 315  
 ametista *f* 288  
 amico *m* 24  
 amico di penna *m* 24  
 amministratore  
   delegato *m* 175  
 ammorbidente *m* 76  
 ammortizzatore *m* 205  
 amniocentesi *f* 52  
 amo *m* 244  
 amperes *m* 60  
 amplificatore *m* 268  
 ampolla *f* 166  
 anacardi *m* 151  
 anacardio *m* 129  
 analisi *f* 49  
 analisi del sangue *f* 48  
 ananas *m* 128  
 anatra *f* 119, 185  
 anatroccolo *m* 185  
 ancora *f* 214, 240  
 andare a letto 71  
 andare in bici 207  
 andare in pensione 26  
 Ande *f* 312  
 Andorra 316  
 anelli *m* 89, 235  
 anello *m* 36, 226  
 anestetista *m* 48  
 aneto *m* 133  
 anfibi *m* 294  
 Angola 317  
 angolo *m* 164, 223  
 angolo della strada *m*  
   298  
 anguilla *f* 294  
 anguria *f* 127  
 anice stellato *m* 133  
 animale *m* 292  
 animali *m* 292, 294  
 animazione *f* 255  
 annaffiare 90  
 annaffiatoio *m* 89  
 annaffiatura *f* 89  
 annegare 239  
 annesso *m* 58  
 anniversario *m* 26  
 anno *m* 306  
 annoiato 25  
 annotazione *f* 256  
 annuale 86  
 annunciatore *m* 191  
 annunciatrice *f* 179  
 annuo 307  
 antenna *f* 295  
 antenna della radio *f* 214  
 antenna parabolica *f*  
   269  
 antiaderente 69  
 antidolorifici *m* 47  
 antidolorifico *m* 109  
 antigelo *m* 199, 203  
 Antigua e Barbuda 314  
 antinfiammatorio *m* 109  
 antipasto *m* 153  
 antirughe 41  
 annullare *m* 15  
 ape *f* 295  
 aperitivo *m* 153  
 aperto 260, 321  
 apice *m* 165  
 apoplessia *f* 44  
 apparecchiare 64  
 apparecchiature da  
   ufficio *f* 172  
 apparecchio a raggi x *m*  
   212  
 apparecchio correttore *m*  
   50  
 appartamento *m* 59, 298  
 appellativi *m* 23  
 appendice *f* 18  
 applaudire 255  
 applicazione *f* 176  
 applique *f* 62  
 appuntamento *m* 45,  
   175  
 appunti *m* 175, 191  
 apribottiglie *m* 68, 150  
 aprile 306  
 apriscatole *m* 68  
 aquila *f* 292  
 Arabia Saudita 318  
 arachide *f* 129  
 aragosta *f* 121, 295  
 arancino cinese *m* 126  
 arancino *m* 126  
 arancione 274  
 arare 183  
 aratro *m* 182

- arbitro *m* 222, 225, 226, 229, 230  
 architettare 91  
 architetto *m* 190  
 architettura *f* 300  
 architrave *m* 186, 301  
 arco *m* 85, 164, 249, 301  
 arco plantare *m* 15  
 arcobaleno *m* 287  
 ardesia *f* 288  
 area della porta *f* 221, 223  
 area di attacco *f* 224  
 area di difesa *f* 224  
 area di rigore *f* 223  
 area di stazionamento *f* 199, 212  
 area neutrale *f* 224  
 arena *f* 243  
 arenaria *f* 288  
 Argentina 315  
 argento *m* 289  
 argento *f* 235  
 argilla *f* 85, 275  
 aria condizionata *f* 200  
 aringhe affumicate *f* 157  
 aritmetica *f* 165  
 armadietti *m* 239  
 armadietto *m* 66  
 armadietto dei medicinali *m* 72  
 armadio *m* 70  
 armadio a muro *m* 71  
 Armenia 318  
 aromaterapia *f* 55  
 arpa *f* 256  
 arrabbiato 25  
 arrampicata su ghiaccio *f* 247  
 arrangiamenti *m* 111  
 arredamento per casa *m* 105  
 arresto *m* 94  
 arricciacapelli *m* 38  
 arrivederci 322  
 arrivi *m* 213  
 arrostire 67  
 arrostito 129  
 arrosto *m* 119, 158  
 art déco 301  
 art nouveau 301  
 arte *f* 162  
 arte e artigianato 274  
 arte topiaria *f* 87  
 arteria *f* 19  
 arti marziali *f* 237  
 articolazione *f* 17  
 articoli da cucina *m* 105  
 articoli da toeletta *m* 41  
 articoli di cancelleria *m* 173  
 articoli elettronici *m* 105  
 articoli sportivi *m* 105  
 artigianato *m* 276  
 artiglio *m* 291  
 artista *f* 274  
 ascella *f* 13  
 ascensore *m* 59, 100, 104  
 ascia *f* 95  
 asciugabiancheria *f* 76  
 asciugacapelli *m* 38  
 asciugamani *m* 73  
 asciugamano da spiaggia *m* 265  
 asciugamano grande *m* 73  
 asciugamano piccolo *m* 73  
 asciugare 76, 77  
 asciugare con il phon 38  
 asciutto 321  
 Asia 318  
 asino *m* 185  
 asma *f* 44  
 asola *f* 32  
 aspetto *m* 30  
 aspirapolvere *m* 188  
 aspirapolvere *m* 77  
 assaggiare 139  
 asse *m* 205  
 asse da stiro *f* 76  
 assegno *m* 96  
 assicurazione *f* 203  
 assistente *m/f* 24  
 assistente di volo *f* 190, 210  
 assistente sociopsicologico *m* 55  
 assistenza ai clienti *f* 104  
 asso *m* 230, 273  
 assolto 181  
 assorbenti *f* 108  
 asteroide *m* 280  
 asticella *f* 225  
 astigmatismo *m* 51  
 astronauta *m* 281  
 astronomia *f* 281  
 astuccio *m* 163, 271  
 atleta *m* 191, 234  
 atletica *f* 234  
 atmosfera *f* 282, 286  
 atrio *m* 104, 209, 255  
 attaccante *m* 222  
 attacco *m* 220  
 attacco a baionetta *m* 60  
 atterrare 211  
 attico *m* 58  
 attillato 35  
 attività *f* 77, 162, 183, 245, 263  
 attività all'aria aperta *f* 262  
 attore *m* 191, 254  
 attori *m* 179  
 attorno 320  
 attraverso 320  
 attrezzatura *f* 165, 238, 245  
 attrezzature *f* 233  
 attrezzi *m* 187  
 attrezzi da giardino *m* 88  
 attrezzo per modellare *m* 275  
 attrice *f* 254  
 audiocassetta *f* 269  
 aula *f* 162, 169  
 aula del tribunale *f* 180  
 aurora *m* 286  
 Australia 319  
 Austria 316  
 autista *m* 190, 196  
 auto a tre/cinque porte *f* 199  
 auto decappottabile *f* 199  
 auto della polizia *f* 94  
 auto d'epoca *f* 199  
 auto familiare *f* 199  
 auto piccola *f* 199  
 auto sportiva *f* 198  
 autobus *m* 196  
 autobus a due piani *m* 196  
 autodifesa *f* 237  
 autolavaggio *m* 198  
 automatico 200  
 automobile *f* 198, 200  
 autonoleggio *m* 213  
 autopompa *f* 95  
 autoradio *f* 201  
 autostazione *f* 197  
 autostrada *f* 194  
 autunno *m* 31, 307  
 avambraccio *m* 12  
 avampiede *m* 15  
 avanzamento veloce *m* 269  
 avena *f* 130  
 avere un bambino 26  
 avocado *m* 128  
 avvelenamento *m* 46  
 avvenimenti della vita *m* 26  
 avventura *f* 255  
 avversario *m* 236  
 avvistamento *m* 230  
 avvocato *m* 180, 190  
 avvolgibile *m* 63  
 avvolgitubo *m* 89  
 Azerbaigian 318  
 azienda agricola *f* 183  
 azienda ortofrutticola *f* 183  
 azioni *f* 97, 227, 233, 229  
**B**  
 bacca *f* 296  
 baccello *m* 122  
 bacchetta *f* 256  
 bacchetta di vetro *f* 167  
 bacino *m* 17, 214  
 bacino per riparazioni *m* 217  
 back-swing *m* 233  
 badminton *m* 231  
 baffi *m* 290  
 bagagli *m* 198  
 bagagliaio *m* 196, 198  
 bagaglio *m* 100, 213  
 bagaglio a mano *m* 211, 213  
 bagaglio in eccedenza *m* 212  
 bagnato 321  
 bagni *m* 266  
 bagnino *m* 239, 265  
 bagno privato *m* 100  
 bagnoschiuina *m* 73  
 Bahamas 314  
 balconata *f* 254  
 balcone *m* 59  
 balena *f* 290  
 balla *f* 184  
 ballerina *f* 191  
 balletto *m* 255  
 balsamo *m* 38  
 bambini *m* 23  
 bambino *m* 23, 31  
 bambino piccolo *m* 30  
 bambola *f* 75  
 bambù *m* 86, 122  
 banana *f* 128  
 banca *f* 96  
 banchina *f* 216  
 banchina spartitraffico *f* 194  
 banco *m* 96, 98, 100, 142, 150, 162, 216  
 banco accettazione *m* 213  
 banco da lavoro *m* 78  
 banco della giuria *m* 180  
 banco informazioni *m* 168  
 banco prestiti *m* 168  
 banconote *f* 97  
 bandierina *f* 221, 223, 232  
 Bangladesh 318  
 bar *m* 150, 152  
 bar all'aperto *m* 148  
 bar con terrazza *m* 148  
 bar mitzvah *m* 26  
 barattolo *m* 134, 311  
 barattolo a chiusura ermetica *m* 135  
 barattolo di vernice *m* 83  
 barbabetola *f* 125  
 Barbados 314  
 barbiere *m* 39, 188  
 barca a remi *f* 214  
 barca a vela *f* 215  
 barca da pesca *f* 217  
 barella *f* 94  
 barista *m* 150, 191  
 barocco 301  
 barra *f* 240  
 barra degli strumenti *f* 177  
 barra del menu *f* 177  
 barra di scorrimento *f* 177  
 barriera *f* 209  
 barriera corallina *f* 285  
 basalto *m* 288  
 base *f* 99, 164, 229  
 base di battuta *f* 228  
 baseball *m* 228  
 basilico *m* 133  
 bassista *m* 258  
 basso 321  
 bastoncini *m* 133  
 bastoncino *m* 90, 91  
 bastone da sci *m* 246  
 battente *m* 59  
 battere 225, 229  
 battere un primato 234  
 batteria *f* 78, 167, 202, 260, 258  
 batterista *m* 258  
 battesimo *m* 26  
 battistrada *m* 207  
 battitore *m* 225, 228  
 battuta *f* 256  
 batuffoli di ovatta *m* 41  
 bavaglino *m* 30, 50  
 becco *m* 89, 293  
 becco Bunsen *m* 166  
 becher *m* 167  
 Belgio 316  
 Belize 314  
 bellezza *f* 40, 105  
 bemolle 256  
 benda *f* 47  
 bendatura *f* 47  
 Benin 317  
 benzina *f* 199  
 berlina *f* 199  
 berretto *m* 36  
 bersaglio *m* 249, 273  
 bestiame *m* 183, 185  
 betoniera *f* 186  
 betulla *f* 296  
 bevanda al malto *f* 144  
 bevande *f* 144, 156  
 bevande alcoliche *f* 145  
 bevande calde *f* 144  
 Bhutan 318  
 biancheria *f* 105  
 biancheria da letto *f* 71, 74  
 biancheria intima *f* 32, 35, 105  
 biancheria termica *f* 35  
 bianchi 39  
 bianco 145, 272, 274  
 biathlon *m* 247  
 biberon *m* 75  
 bibita *f* 154  
 bibita in lattina *f* 154  
 bibite *f* 107, 144  
 biblioteca *f* 168, 299  
 bibliotecaria *f* 168  
 bibliotecario *m* 190  
 bicchiere *m* 65, 151, 152  
 bicchieri *m* 150  
 bicicletta *f* 206  
 bicicletta da corsa *f* 206  
 bicicletta da strada *f* 206  
 bicicletta da turismo *f* 206  
 bicipite *m* 16  
 bidè *m* 72  
 Bielorussia 316  
 biennale 86

- bieta *f* 123  
 bietola *f* 123  
 bifamiliare 58  
 bifocale 51  
 biglietteria *f* 209, 216, 255  
 biglietti della lotteria *m* 112  
 biglietto *m* 197, 213, 209  
 bigné *m* 140  
 bigné al cioccolato *m* 140  
 bigodini *m* 38  
 bikini *m* 264  
 bilancia *f* 45, 53, 69, 98, 118, 166, 212, 310  
 bilancia a molla *f* 166  
 bilanciaria *m* 251, 263  
 biliardo *m* 249  
 bimbo *m* 23, 30  
 binario *m* 208  
 binario elettrificato *m* 209  
 binocolo *m* 281  
 biologia *f* 162  
 biologico 91, 118, 122  
 biondo 39  
 biplano *m* 211  
 birillo *m* 187, 249  
 Birmania 318  
 birra *f* 145, 151  
 birra amara *f* 145  
 birra scura *f* 145  
 bis *m* 255  
 biscotti *m* 141  
 biscotto *m* 113  
 biscotto alle noci *m* 141  
 biscotto con scaglie di cioccolato 141  
 bistecca di culaccio *f* 119  
 bisturi *m* 81, 167  
 blazer *m* 33  
 blocca freni *m* 207  
 bloccare 227  
 blocco *m* 172  
 blocco di partenza *m* 234  
 blocco per appunti *m* 173  
 blocco per schizzi *m* 275  
 blu 274  
 blues *m* 259  
 boa *f* 217  
 bob *m* 247  
 bobina *f* 245, 276  
 bocca *f* 14  
 boccaglio *m* 239  
 bocciole *m* 111, 297  
 bocconcini di pollo *m* 155  
 Bolivia 315  
 bollire 67  
 bollitore *m* 66  
 boma *m* 240  
 bombardiere *m* 211  
 bombola *f* 239
- bottoletta spray *f* 311  
 bongo *m* 257  
 bonifico bancario *m* 96  
 bordegiare 241  
 bordo *m* 230  
 bordo erbaceo *m* 85  
 borraccia *f* 206, 267  
 borsa *f* 190  
 borsa a tracolla *f* 37  
 borsa calda *f* 70  
 borsa da spiaggia *f* 264  
 borsa dei ricambi *f* 75  
 borsa di studio *f* 169  
 borsa valori *f* 97  
 borse *f* 37  
 borsetta *f* 37  
 bosco *m* 285  
 Bosnia ed Erzegovina 316  
 Botswana 317  
 bottiglia *f* 61, 135, 311  
 bottiglia di vetro *f* 166  
 bottone *m* 32  
 bottone automatico *m* 30  
 bouquet *m* 35  
 boutique *f* 115  
 bowling *m* 249  
 box *m* 75  
 boxer *m* 33  
 bozzolo *m* 295  
 bracciale *m* 36  
 bracciata *f* 239  
 braccio *m* 13, 95  
 bracciole *m* 200, 210, 238  
 branchia *f* 294  
 brandy *m* 145  
 Brasile 315  
 bretella *f* 37  
 bricco misuratore *m* 69  
 briciole *f* 139  
 bridge *m* 273  
 brie *m* 142  
 briglia *f* 242  
 brioches *f* 157  
 brocca *f* 65, 151  
 brocca graduata *f* 311  
 broccolo *m* 123  
 broker *m* 97  
 bronzo *m* 235  
 browser *m* 177  
 bruciatore a gas *m* 61  
 brucu *m* 295  
 Brunei 319  
 buca *f* 232  
 buca delle lettere *f* 99  
 buca in uno *f* 233  
 buccia *f* 126, 127, 128  
 buco nero *m* 280  
 budino di riso *m* 140  
 bufera *f* 286  
 buffet *m* 152  
 buffet della colazione *m* 156  
 buggy *m* 232  
 bulbo *m* 86  
 Bulgaria 316
- bulloni della ruota *m* 203  
 bungee jumping *m* 248  
 bunker *m* 232  
 buongiorno 322  
 buono 321  
 Burkina Faso 317  
 burro *m* 137, 156  
 burro di arachidi *m* 135  
 Burundi 317  
 business class *f* 211  
 bussola *f* 80, 240, 312  
 busta *f* 98, 173  
 busta della spesa *f* 106  
 busta di plastica *f* 122  
 bustina di tè *f* 144  
 byte *m* 176
- C**  
 cabina *f* 95, 210, 214, 264  
 cabina del conducente *f* 208  
 cabina di pilotaggio *f* 210  
 cabina telefonica *f* 99  
 Cabinda 317  
 cacatua *f* 293  
 cacciagione *f* 119  
 cacciavite *m* 80  
 cacciavite a croce *m* 81  
 cachi *m* 128  
 cactus *m* 87  
 caddy *m* 233  
 caduta *f* 237  
 caffè *m* 144, 148, 153, 156, 184, 262  
 caffè filtrato *m* 148  
 caffè freddo *m* 148  
 caffè macchiato *m* 148  
 caffè nero *m* 148  
 caffettiera *f* 65  
 calamaro *m* 121, 295  
 calamita *f* 167  
 calcare *m* 288  
 calcestruzzo *m* 187  
 calciatore 223  
 calciatore *m* 222  
 calcio *m* 109, 221, 222, 237  
 calcio di punizione *m* 222  
 calcite *f* 289  
 calcolatrice *f* 165  
 caldo 286, 321  
 calendario *m* 306  
 calice *m* 297  
 calice da vino *m* 65  
 calorifero *m* 60  
 calvo 39  
 calze *f* 35  
 calzini *m* 33  
 calzoncini *m* 33  
 cambiare 209  
 cambiare canale 269  
 cambiare marcia 207  
 cambiare una ruota 203  
 Cambogia 318  
 camembert *m* 142
- camera *f* 283  
 camera a due letti *f* 100  
 camera da letto *f* 70  
 camera d'aria *f* 207  
 camera dei bambini *f* 74  
 camera doppia *f* 100  
 camera oscura *f* 271  
 camera privata *f* 48  
 camera singola *f* 100  
 cameraman *m* 178  
 camere *f* 100  
 cameriera *f* 191  
 cameriere *m* 148, 152  
 camerino *m* 104  
 Camerun 317  
 camicetta *f* 34  
 camicetta da rugby *f* 221  
 camicia *f* 32  
 camicia da notte *f* 31, 35  
 caminetto *m* 63  
 canino *m* 58  
 camion *m* 194  
 camion con cassone ribaltabile *m* 187  
 camionista *m* 190  
 cammello *m* 291  
 camomilla *f* 149  
 campanello *m* 59, 197  
 Campari *m* 145  
 campeggiare 266  
 campeggio *m* 266  
 camper *m* 266  
 campionato *m* 223, 230  
 campo *m* 182, 220, 222, 226, 228, 230, 234  
 campo da golf *m* 232  
 campo destro *m* 229  
 campo di cricket *m* 225  
 campo di rugby *m* 221  
 campo esterno *m* 229  
 campo sinistro *m* 228  
 campo sportivo *m* 168  
 campus *m* 168  
 Canada 314  
 canale *m* 178, 269  
 canale a pagamento *m* 269  
 canale di scolo *m* 299  
 canale radiofonico *m* 179  
 canarino *m* 292  
 cancelleria *f* 105  
 cancello *m* 85, 182  
 candela *f* 63, 203  
 candeline *f* 141  
 cane *m* 290  
 canestro *m* 226  
 canguro *m* 291  
 canino *m* 50  
 canna *f* 91, 207  
 canna da pesca *f* 244  
 canna da zucchero *f* 184  
 canne *f* 89  
 cannella *f* 133  
 cannolicchio *m* 121
- cannuccia *f* 112, 144, 154  
 canoa *f* 214  
 canottaggio *m* 241  
 canottiera *f* 33, 35  
 cantante *m* 258  
 cantante *f* 191  
 cantiere *m* 186  
 cantiere navale *m* 217  
 canzone *f* 259  
 capacità *f* 311  
 capanno *m* 182  
 capelli *m* 14, 38  
 capezzolo *m* 12  
 capitale *f* 315  
 capitale netto *m* 97  
 capitaneria di porto *f* 217  
 capitano *m* 214  
 capitano di porto *m* 217  
 capo *m* 24  
 Capodanno *m* 27  
 capoeira *f* 237  
 capote *f* 75  
 capovolgere 241  
 cappa *f* 66  
 cappello *m* 36, 190  
 cappello da equitazione *m* 242  
 cappello da spiaggia *m* 265  
 cappello per il sole *m* 30  
 capperi *m* 143  
 cappotto *m* 32  
 cappuccino *m* 148  
 cappuccio *m* 31  
 cappuccio cervicale *m* 21  
 capra *f* 185  
 capretto *m* 185  
 caprifoglio *m* 297  
 capriola *f* 235  
 capsula di Petri *f* 166  
 carambola *f* 128  
 caramella alla frutta *f* 113  
 caramella di gelatina *f* 113  
 caramella gommosa *f* 113  
 caramella mou *f* 113  
 caramelle *f* 113  
 caramelle assortite *f* 113  
 caramello *m* 113  
 carattere *m* 177  
 carboncino *m* 275  
 carbone *m* 288  
 carbonella *f* 266  
 carcere *m* 181  
 carciofo *m* 124  
 cardamomo *m* 132  
 cardio *m* 121  
 cardiologia *f* 49  
 cardiovascolare 19  
 cardo *m* 297  
 caricare 76  
 carico *m* 216  
 carie *f* 50



- carnagione *f* 41  
 carne *f* 119  
 carne bianca *f* 118  
 carne cotta *f* 118, 143  
 carne cruda *f* 142  
 carne e pollame *f/m* 106  
 carne macinata *f* 119  
 carne magra *f* 118  
 carne rossa *f* 118  
 carnevale *m* 27  
 carota *f* 124  
 carpa koi *f* 294  
 carrellino *m* 233  
 carrello *m* 106, 208, 213  
 carrello d'atterraggio *m* 210  
 carrello dei dolci *m* 152  
 carrello della telecamera *m* 178  
 carrello elevatore *m* 186, 216  
 carrello portabagagli *m* 212  
 carriola *f* 88  
 carro attrezzi *m* 203  
 carrozzeria *f* 202  
 carrozzina *f* 75  
 carta a rilievo *f* 83  
 carta da parati *f* 82  
 carta di credito *f* 96  
 carta di debito *f* 96  
 carta di fondo *f* 83  
 carta d'imbarco *f* 213  
 carta igienica *f* 72  
 carta intestata *f* 173  
 carta vetrata *f* 81, 83  
 cartapesta *f* 275  
 carte *f* 273  
 cartella *f* 162, 177  
 cartella sospesa *f* 173  
 cartellina *m* 172  
 cartellino giallo *m* 223  
 cartellino rosso *m* 223  
 cartello stradale *m* 195  
 cartilagine *f* 17  
 cartolina *f* 27  
 cartoline *f* 112  
 cartone *m* 275, 311  
 cartone animato *m* 178  
 cartone di fibra compressa *m* 79  
 cartone di latte *m* 136  
 casa *f* 58  
 casa da gioco *f* 75  
 casa delle bambole *f* 75  
 casa dello studente *f* 168  
 casa di città *f* 58  
 casalinghi *m* 107  
 cascata *f* 285  
 caschetto 39  
 casco *m* 95, 186, 204, 206, 220, 228, 236  
 caseggiato *m* 59  
 caseificio *m* 183  
 casella *f* 100, 272  
 casello *m* 194  
 caserma dei vigili del fuoco *f* 95  
 casinò *m* 261  
 casolare *m* 182  
 cassa *f* 106, 150  
 cassa automatica *f* 97  
 cassa toracica *f* 17  
 cassava *f* 124  
 casseretto *m* 214  
 casseruola *f* 69  
 casseruola di terracotta *f* 69  
 cassetta *f* 61  
 cassetta delle lettere *f* 99  
 cassetta di pronto soccorso *f* 47  
 cassetta guidalama per ugnature *f* 81  
 cassetta per le lettere *f* 58  
 cassettera *f* 172  
 cassetto *m* 66, 70, 172  
 cassetto per la verdura *m* 67  
 cassettone *m* 70  
 cassiere *m* 96, 106  
 cast *m* 254  
 castagna *f* 129  
 castagna d'acqua *f* 124  
 castano 39  
 castello *m* 300  
 castello di sabbia *m* 265  
 casual *m* 33, 34  
 catalogo *m* 168  
 catamarano *m* 215  
 cataratta *f* 51  
 catarifrangente *m* 207  
 catena *f* 36, 206  
 catena montuosa *f* 282  
 catenella *f* 59  
 catetere *m* 53  
 catrame *m* 187  
 cattedrale *f* 300  
 cattivo 321  
 cauzione *f* 181  
 cavalcavia *m* 194  
 cavalletta *f* 295  
 cavalletto *m* 174, 205, 207, 274  
 cavallo *m* 185, 235, 242, 272  
 cavallo da corsa *m* 243  
 cavalluccio marino *m* 294  
 cavatappi *m* 150  
 cavoratori *m* 68  
 caverna *f* 284  
 cavezza *f* 243  
 caviglia *f* 13, 15  
 cavo *m* 79, 207  
 cavo di alimentazione *m* 176  
 cavolfiore *m* 124  
 cavolino di Bruxelles *m* 122  
 cavolo *m* 123  
 cavolo rapa *m* 123  
 cavolo verde *m* 123  
 cazzuola *f* 187  
 ceci *m* 131  
 cedro *m* 296  
 celebrazioni *f* 27  
 cella *f* 94, 181  
 cembali *m* 257  
 cemento *m* 186  
 cena *f* 64, 158  
 cenere *f* 283  
 centesimo 309  
 centimetro *m* 310  
 cento 308  
 centodieci 308  
 centomila 308  
 centrifuga *f* 76  
 centrifugare 76  
 centro *m* 164, 273  
 centro campo *m* 222  
 centro commerciale *m* 104  
 centro della tavola *m* 241  
 centrocampo *m* 228  
 cera *f* 77  
 ceramica *f* 275  
 cercare 177  
 cerchietto *m* 38  
 cerchio *m* 165, 277  
 cerchio centrale *m* 224  
 cerchione *m* 206  
 cereale *m* 130, 156  
 cereali da colazione *m* 107  
 cereali trattati *m* 130  
 ceretta *f* 41  
 cerotto *m* 47  
 certificato di nascita *m* 26  
 cervello *m* 19  
 cervice *f* 52  
 cervo *m* 118, 291  
 cesoie *f* 89  
 cesta *f* 263  
 cesta dei giocattoli *f* 75  
 cesta del cucito *f* 276  
 cestello *m* 88, 207  
 cestino *m* 106, 172, 177  
 cestino di frutta *m* 126  
 cesto della biancheria da lavare *m* 76  
 cesto della biancheria pulita *m* 76  
 cesto sospeso *m* 84  
 cetriolo *m* 125  
 champagne *m* 145  
 cheddar *m* 142  
 cheerleader *f* 220  
 chiamata a carico del destinatario *f* 99  
 chiara *f* 137  
 chiaro 41, 321  
 chiave *f* 59, 80, 203, 207  
 chiave a tubo *f* 80  
 chiave della camera *f* 100  
 chiave di basso *f* 256  
 chiave di sol *f* 256  
 chiave inglese *f* 81  
 chiave regolabile *f* 80  
 chiavistello *m* 59  
 chicchi *m* 144  
 chiesa *f* 298, 300  
 chiglia *f* 214  
 chilogrammo *m* 310  
 chilometro *m* 310  
 chimica *f* 162  
 chiocciola *f* 295  
 chiodi *m* 233  
 chiodi di garofano *m* 133  
 chiodo *m* 80  
 chiropratica *f* 54  
 chirurgia *f* 48  
 chirurgia plastica *f* 49  
 chirurgo *m* 48  
 chitarra elettrica *f* 258  
 chitarrista *m* 258  
 chiuso 260, 321  
 chiusura lampo *f* 277  
 chorizo *m* 143  
 chutney *m* 134  
 ciabatta *f* 37  
 ciac *m* 179  
 Ciad 317  
 ciambella *f* 139, 265  
 cibi cotti *m* 107  
 cibi imbottigliati *m* 134  
 cibo *m* 118, 130, 149  
 cibo per animali *m* 107  
 ciclismo *m* 263  
 cicogna *f* 292  
 cicoria *f* 122  
 ciglio *m* 14, 51, 298  
 cigno *m* 293  
 Cile 315  
 ciliegia *f* 126  
 cilindro *m* 164  
 Cina 318  
 cinema *m* 255, 299  
 cinghia *f* 37, 242  
 cinghia della camma *f* 203  
 cinghia della ventola *f* 203  
 cinghia frontale *f* 242  
 cinghia nasale *f* 242  
 cinghietto *m* 207  
 cinquanta 308  
 cinquantacinquemilacinquecento 309  
 cinquantamila 309  
 cinquantesimo 309  
 cinque 308  
 cinquecento 308  
 cinta *f* 36  
 cinta per gli attrezzi *f* 186  
 cintura *f* 32, 236  
 cintura dei pesi *f* 239  
 cintura di sicurezza *f* 198, 211  
 cintura nera *f* 237  
 cioccolata calda *f* 156  
 cioccolata spalmabile *f* 135  
 cioccolato *m* 113  
 cioccolato al latte *m* 113  
 cioccolato amaro *m* 113  
 cioccolato bianco *m* 113  
 cioccolato caldo *m* 144  
 ciotola *f* 65  
 cipolla *f* 124  
 cipollina *f* 125  
 cipria *f* 40  
 Cipro 316  
 circolo di confronto *m* 224  
 circolo polare artico *m* 283  
 circonferenza *f* 164  
 citazione *f* 180  
 citofono *m* 59  
 citronella *f* 133  
 città *f* 298, 299  
 Città del Vaticano *f* 316  
 clacson *m* 201, 204  
 clarinetto *m* 257  
 clarinetto basso *m* 257  
 classe *f* 163  
 classe economica *f* 211  
 clavicola *f* 17  
 clementina *f* 126  
 cliente *m* 38, 96, 104, 106, 152, 175, 180  
 clinica *f* 48  
 clitoride *m* 20  
 coca *f* 144  
 coccige *f* 17  
 coccinella *f* 295  
 cocodrillo *m* 293  
 cocktail *m* 151  
 coda *f* 121, 210, 242, 280, 290, 294  
 coda di cavallo *f* 39  
 codice a barre *m* 106  
 codice di avviamento postale *m* 98  
 codini *m* 39  
 cofanetto portagioie *m* 36  
 cofano *m* 198  
 cogliere 91  
 cognata *f* 23  
 cognato *m* 23  
 coincidenza *f* 212  
 coito *m* 20  
 colazione *f* 64, 156  
 colazione all'inglese *f* 157  
 coleottero *m* 295  
 colibri *m* 292  
 colino *m* 68  
 colla *f* 275  
 colla da legno *f* 78  
 colla da parati *f* 82  
 collage *m* 275  
 collana *f* 36  
 collant *m* 35, 251  
 collare *m* 46  
 collega *m/f* 24  
 collegare 177  
 collegarsi 177  
 colletto *m* 32  
 collina *f* 284  
 collo *m* 12

- collo a V *m* 33  
collo del piede *m* 15  
collo dell'utero *m* 20  
collutorio *m* 72  
Colombia 315  
colonia *f* 315  
colonna *f* 300  
colonna d'ormeggio *f* 214  
colonna sonora *f* 255  
colonnina *f* 298  
colore *m* 273  
colori *m* 39, 274  
colori acrilici *m* 274  
colori ad olio *m* 274  
colpi *m* 231  
colpi di sole *m* 39  
colpire 224  
colpire a distanza *f* 233  
colpire da vicino 233  
colpire di testa 222  
colpire leggermente 233  
colpo *m* 233, 237  
colpo di frusta *m* 46  
colpo di taglio *m* 237  
colpo nullo! 231  
coltello *m* 65, 80  
coltello da cucina *m* 68  
coltello da pacchi *m* 82  
coltello da pane *m* 68  
coltivare 91  
colture *m* 184  
colza *f* 184  
comandi *m* 201, 204  
comandi per il riscaldamento *m* 201  
comando *m* 269  
cometa *f* 280  
cominciare la partita 233  
commedia *f* 255  
commercialista *m* 190  
commissa *f* 188  
commesso *m* 104  
commissario *m* 94  
commissione *f* 97  
commissione bancaria *f* 96  
commozione *f* 46  
comodino *m* 70  
Comore 317  
compact disc *m* 269  
compagno/-a *m/f* 23  
compartimento portabagagli *m* 210  
compasso *m* 165  
compensato *m* 79  
compiti *m* 163  
compleanno *m* 27  
complesso di uffici *m* 298  
completo 266  
comporre 99  
computer *m* 172, 176  
computer portatile *m* 176  
comunicazioni *f* 98  
con 320
- con armatura 35  
concepire 20  
concerto *m* 255, 258  
concerto rock *m* 258  
concezione *f* 52  
conchiglia *f* 265  
concimaia *f* 85  
concimare 91  
concimare a spandimento 90  
concime *m* 91  
concorso di salto a ostacoli *m* 243  
condimento *m* 155, 158  
condito 159  
confetiere *m* 113  
confetture *f* 134  
confuso 25  
congelare 67  
congelato 121, 124  
congelatore *m* 67  
conglomerato *m* 288  
Congo 317  
conifera *f* 86  
coniglio *m* 118, 290  
cono *m* 164  
conoscente *m* 24  
consegna *f* 98  
consegna a domicilio *f* 154  
consegna delle lauree *f* 169  
conserva di frutta *f* 134  
conservante *m* 83  
conservatorio *m* 169  
console *f* 269  
consulente finanziaria *m* 97  
consulenza legale *f* 180  
contabile *m* 97  
contachilometri *m* 201, 204  
contafotogrammi *m* 270  
contagiri *m* 201  
contagocce *m* 109, 167  
container *m* 216  
contante *m* 97  
contare 165  
contatore di corrente *m* 60  
contenitore *m* 311  
contenitore per la carta *m* 172  
continente *m* 282, 315  
conto *m* 152  
conto corrente *m* 96  
conto di risparmio *m* 97  
contornitrice *f* 78  
contorno *m* 153  
contrabbasso *m* 256  
contraccezione *f* 21, 52  
contrafforte *m* 301  
contrastare 223  
contrazione *f* 52  
controfagotto 257  
controllo *m* 50  
controllo passaporti *m* 212, 213
- controllore *m* 209  
coperchio *m* 61, 66  
coperta *f* 71, 74  
coperta imbottita *f* 71  
coperto *m* 65  
copiare 172  
copilota *m* 211  
copione *m* 254  
coppe *f* 53  
coppia *f* 24  
coprietto *m* 70  
concorso *m* 202  
copriobiettivo *m* 270  
corda *f* 230, 248, 266  
corda per bucato *f* 76  
cordata *f* 248  
corde *f* 256  
corde vocali *f* 19  
cordone ombelicale *m* 52  
Corea del Nord 318  
Corea del Sud 318  
coriandolo *m* 133  
corna *f* 291  
cornacchia *f* 292  
cornea *f* 51  
cornetto *m* 156  
cornice *f* 62, 63, 271  
cornicione *m* 300  
corno *m* 257, 291  
corno inglese *m* 257  
coro *m* 301  
corona *f* 50, 111  
corpetto *m* 35  
corpo *m* 12  
corrente alternata *f* 60  
corrente continua *f* 60  
correre 228  
correttore *m* 40  
corridoio *m* 210, 254  
corriere *m* 99  
corrimano *m* 59  
corsa a ostacoli *f* 235, 243  
corsa automobilistica *f* 249  
corsa di calessi *f* 243  
corsa di carrozze *f* 243  
corsa di cavalli *f* 243  
corsa in motoscafo *f* 241  
corsa in piano 243  
corsa su slitta *f* 247  
corsa su slitta trainata da cani *f* 247  
corsa sul posto *f* 251  
corse *f* 243  
corsetto *m* 35  
corsia *f* 106, 168, 234, 238  
corsia centrale *f* 194  
corsia d'emergenza *f* 194  
corsia esterna *f* 194  
corsia interna *f* 194  
Corsica 316  
corso per azione *m* 97  
corteccia *f* 296  
cortile *m* 58, 84
- corto 32  
coscia *f* 12, 119  
costa *f* 285  
Costa d'Avorio 317  
Costa Rica 314  
costata *f* 119  
costellazione *f* 281  
costola *f* 17  
costoletta *f* 119  
costolette *f* 155  
costruire 186  
costume *m* 255  
costume da bagno *m* 238, 265  
costumista *f* 191  
cotenna *f* 119  
cotone *m* 184, 277  
cotto al forno 159  
cottura dei dolci *f* 69  
cottura facile 130  
country *f* 259  
cozza *f* 121, 295  
CPU *m* 176  
crampi *m* 44  
crampo *m* 239  
cranio *m* 17  
cratere *m* 283  
cravatta *f* 32  
crema *f* 109, 140  
crema abbronzante *f* 265  
crema al limone *f* 134  
crema autoabbronzante *f* 41  
crema idratante *f* 41  
crema pasticcera *f* 140  
crema per il viso *f* 73  
crema protettiva *f* 265  
crema schermo totale *f* 108  
crema solare *f* 108  
crêpe *f* 155, 157  
crêpes *f* 157  
crescere 139  
crescione *m* 123  
cresta dell'onda *f* 241  
cric *m* 203  
criceto *m* 290  
cricket *m* 225  
criminale *m* 180  
criniera *f* 242, 291  
crisantemo *m* 110  
cristalleria *f* 64  
cristalloterapia *f* 55  
Croazia 316  
croccante 127  
crocchia *f* 39  
crocevia *m* 298  
crogiolo *m* 166  
cronista *f* 179  
cronometro *m* 166, 234  
cross trainer *m* 250  
crosta *f* 136, 139, 282  
crostatina *f* 140  
crudo 124, 129  
crusca *f* 130  
cruscotto *m* 201  
Cuba 314
- cubetto di ghiaccio *m* 151  
cubo *m* 164  
cucchiaio *m* 65  
cucchiaio da caffè *m* 153  
cucchiaio *m* 65  
cucchiaio da minestra *m* 65  
cucchiaio da portata *m* 68  
cucchiaio di legno *m* 68  
cucchiaio dosatore *m* 68  
cucchiaio misuratore *m* 109  
cucchiaio perforato *m* 68  
cucciolo *m* 290  
cucina *f* 66, 152  
cucina di bordo *f* 214  
cucinare 67  
cucire 277  
cucitrice *f* 173  
cucitura *f* 34  
cuffia *f* 238  
cuffie *f* 268  
cugino *m* 22  
culla portatile *f* 75  
cumino *m* 132  
cunetta *f* 299  
cuocere a fuoco lento 67  
cuocere al forno 67, 138  
cuocere al vapore 67  
cuocere alla griglia 67  
cuoco *m* 152, 190  
cuoio capelluto *m* 39  
cuore *m* 18, 119, 122, 273  
cuori di palma *m* 122  
cupola *f* 300  
curare 91  
curcuma *f* 132  
curling *m* 247  
curry *m* 158  
curvo 165  
cuscino *m* 62  
cuscus *m* 130  
custodia *f* 51  
custodia degli occhiali *f* 51  
cyclette *f* 250

**D**

- d'accordo 322  
da 320  
da portar via 154  
dado *m* 80, 272  
dama *f* 272  
Danimarca 316  
dar da mangiare 183  
data *f* 306  
data di comparizione *f* 180  
data di restituzione *f* 168  
data di scadenza *f* 109  
datore di lavoro *m* 24  
dattero *m* 129  
davanti 320  
debole 321

- decade *f* 307  
 decimale *m* 165  
 decimo 309  
 decollare 211  
 decoratore *m* 82  
 decorazione *f* 82, 141  
 delfino *m* 290  
 deltaplano *m* 248  
 deltoide *m* 16  
 denominatore *m* 165  
 denominazione *f* 97  
 dente *m* 50, 207  
 dente di leone *m* 123, 297  
 dentiera *f* 50  
 dentifricio *m* 72  
 dentista *f* 189  
 dentista *m* 50  
 dentro 320  
 denuncia *f* 94  
 deodorante *m* 73  
 deodoranti *m* 108  
 dépliants *m* 96  
 dermatologia *f* 49  
 deserto *m* 285  
 desktop *m* 177  
 desquamato 121  
 dessert *m* 140, 153  
 destinazione *f* 213  
 destra 260  
 detergente *m* 77  
 detergente per vetri *m* 199  
 deuce *m* 230  
 deviazione *f* 195  
 di fronte 320  
 di vetro 69  
 diabete *m* 44  
 diaframma *m* 19, 21  
 diagonale *f* 164  
 diamante *m* 288  
 diametro *m* 164  
 diarrea *f* 44, 109  
 dicembre 306  
 dichiarazione *f* 180  
 diciannove 308  
 diciannovesimo 309  
 diciassette 308  
 diciassettesimo 309  
 diciottesimo 309  
 diciotto 308  
 dieci 308  
 diecimila 309  
 diesel *m* 199  
 diesis *m* 256  
 dietro 320  
 difendere 225, 227, 229  
 difensore *m* 223  
 difesa *f* 181, 220  
 difetti *m* 271  
 difficile 321  
 diffusore *m* 89  
 diga *f* 300  
 digestivo 19  
 digitale 269  
 digitali *m* 297  
 dilatazione *f* 52  
 dimensioni *f* 165
- dimesso 48  
 dinamo *f* 207  
 diottria *f* 51  
 dipartimento *m* 169  
 diploma *m* 169  
 direttore *m* 96, 174  
 direttore di orchestra *m* 256  
 dirigente *m* 174  
 diritto *m* 169  
 discesa *f* 247  
 dischetto *m* 176, 224, 226  
 disco DVD *m* 269  
 discutere 163  
 disegnare 162  
 disegnatrice *f* 191  
 disegno *m* 275  
 diserbante *m* 91  
 disinfettante *m* 47  
 dispensario *m* 108  
 dispenser *m* 173  
 dispositivo intrauterino *m* 21  
 dissertazione *f* 169  
 distanza *f* 310  
 distintivo *m* 31, 94, 189  
 distretto *m* 315  
 distribuire 273  
 distributore *m* 203  
 distributore di aria compressa *m* 199  
 ditale *m* 276  
 dito del piede *m* 15  
 Divali *m* 27  
 divano *m* 62  
 divano letto *m* 63  
 dividendi *m* 97  
 dividere 165  
 divisa *f* 189, 222  
 divisa scolastica *f* 162  
 diviso per 165  
 divisore *m* 173  
 divorzio *m* 26  
 dizionario *m* 163  
 DJ *m* 179  
 docce *f* 266  
 doccia *f* 72  
 docciaschiama *f* 73  
 docente *m* 169  
 documentario *m* 178  
 dodicesimo 309  
 dodici 308  
 dogana *f* 212  
 dolce 124, 127, 155  
 dolce di frutta *m* 140  
 dolci *m* 107, 140  
 dolciumi *m* 113  
 domanda *f* 163  
 domandare 163  
 domani 306  
 domenica 306  
 Dominica 314  
 domino *m* 273  
 donna *f* 12, 23  
 donna di affari *f* 175  
 dopo 320  
 dopobarba *m* 73
- dopodomani *m* 307  
 doposole *m* 108  
 doppia carreggiata *f* 195  
 doppie punte *f* 39  
 doppio *m* 230  
 doppio 151  
 dormita *f* 74  
 dorsale *m* 16  
 dorso *m* 239  
 dorso del piede *m* 15  
 dosaggio *m* 109  
 dotto deferente *m* 21  
 dotto eiaculatorio *m* 21  
 dottorato *m* 169  
 dragoncello *m* 133  
 dressage *m* 243  
 dritto 165, 260  
 dritto *m* 231  
 drogheria *f* 114  
 due 308  
 duecento 308  
 duemila 307  
 duemilauno 307  
 duodeno *m* 18  
 duro 129, 321
- E**  
 eccitato 25  
 eclisse *f* 280  
 ecografia *f* 48, 52  
 economia *f* 169  
 Ecuador 315  
 eczema *m* 44  
 edam *m* 142  
 edicola *f* 112  
 edifici *m* 299  
 edificio storico *m* 261  
 edilizia *f* 186  
 educazione fisica *f* 162  
 effetti collaterali *m* 109  
 Egitto 317  
 eglefino *m* 120  
 El Salvador 314  
 elastico *m* 39, 173  
 elefante *m* 291  
 elegante 34  
 elemento riscaldante *m* 61  
 elettricista *m* 188  
 elettricità *f* 60  
 elettrodo negativo *m* 167  
 elettrodo positivo *m* 167  
 elettrodomestici *m* 107  
 elica *f* 211, 214  
 elicottero *m* 211  
 ematite *f* 289  
 embrione *m* 52  
 emergenza *f* 46  
 emicrania *f* 44  
 emigrare 26  
 Emirati Arabi Uniti 318  
 emisfero meridionale *m* 283  
 emisfero settentrionale *m* 283  
 emorragia *f* 46  
 emorragia nasale *f* 44  
 emozioni *f* 25
- enciclopedia *f* 163  
 endocrino 19  
 endocrinologia *f* 49  
 entrare in bacino 217  
 entrata *f* 59, 61  
 entro 320  
 epidurale *f* 52  
 epiglottide *m* 19  
 epilessia *f* 44  
 episiotomia *f* 52  
 equatore *m* 283  
 equazione *f* 165  
 equipaggio *m* 241  
 equitazione *f* 263, 242  
 erba *f* 55, 86  
 erba aromatica *f* 86  
 erba cipollina *f* 133  
 erbacce *f* 86  
 erbalismo *f* 55  
 erbe *f* 133  
 erbe aromatiche *f* 134  
 erbe e le spezie *f* 132  
 erbicida *f* 183  
 erica *f* 297  
 Eritrea 317  
 eruttare 283  
 esagono *m* 164  
 esame *m* 163  
 esame della vista *m* 51  
 esca *f* 244  
 esca per il fuoco *f* 266  
 escavatrice meccanica *f* 187  
 escursione a cavallo *f* 243  
 escursionismo *m* 263  
 esercizi *m* 251  
 esfoliare 41  
 eskimo *m* 31  
 esofago *m* 19  
 esosfera *f* 286  
 esperimento *m* 166  
 esplorazione dello spazio *f* 281  
 esposimetro *m* 270  
 esposizione *f* 261, 271  
 espresso *m* 148  
 espulsione *f* 223  
 essiccato 129  
 est *m* 312  
 estate *f* 31, 307  
 esterno *m* 198  
 estintore *m* 95  
 Estonia 316  
 estrazione *f* 50  
 estuario *m* 285  
 etichetta *f* 172, 173  
 etichette *f* 89  
 Etiopia 317  
 eucalipto *m* 296  
 Europa *f* 316
- F**  
 fabbrica *f* 299  
 fabbrica-ghiaccio *m* 67  
 fabbricazione dei merletti *f* 277  
 facchino *m* 100
- faccia *f* 14  
 facile 321  
 faggio *m* 296  
 fagiano *m* 119, 293  
 fagioli *m* 131  
 fagioli aduki *m* 131  
 fagioli bianchi *m* 131  
 fagioli borlotti *m* 131  
 fagioli cannellini *m* 131  
 fagioli dall'occhio nero *m* 131  
 fagioli di Spagna *m* 131  
 fagioli mung *m* 131  
 fagioli nani *m* 131  
 fagiolino *m* 122  
 fagotto *m* 257  
 fairway *m* 232  
 falco *m* 292  
 falegname *m* 188  
 falegnameria *f* 275  
 falena *f* 295  
 fallo *m* 222, 226, 228, 230  
 famiglia *f* 22  
 fanale *m* 207  
 fanale posteriore *m* 204, 207  
 fans *m* 258  
 fante *m* 273  
 fantino *m* 242  
 far crescere 91  
 fard *m* 40  
 fare amicizia 26  
 fare il check-in 212  
 fare il letto 71  
 fare il pane 138  
 fare lo swing 232  
 fare marcia indietro 195  
 fare testamento 26  
 faretra *f* 249  
 farfalla *f* 36, 239, 295  
 farina autolievitante *f* 139  
 farina bianca *f* 138  
 farina di ossa *f* 88  
 farina integrale *f* 138  
 farina per il pane *f* 139  
 farina semplice *f* 139  
 farine *f* 138  
 faringe *f* 19  
 farmacia *f* 108  
 farmacista *m* 108, 189  
 faro *m* 198, 217  
 farsi il bagno 72  
 farsi la doccia 72  
 fascia a tracolla *f* 46  
 fascia rifrangente *f* 205  
 fasi *f* 23  
 fast food *m* 154  
 fattoria *f* 182, 184  
 fava *f* 122  
 fave *f* 131  
 favo *m* 135  
 fax *m* 98, 172  
 fazzolettino *m* 108  
 fazzoletto *m* 36  
 febbraio 306  
 febbre *f* 44  
 febbre da fieno *f* 44

- federa *f* 71  
 Federazione Russa 318  
 fedina penale *f* 181  
 fegato *m* 18, 118  
 feijoa *f* 128  
 felce *f* 86  
 felice 25  
 felpa *f* 33, 74  
 femminili 20  
 femore *m* 17  
 feng shui *m* 55  
 fenicottero *m* 292  
 ferita *f* 46  
 ferita alla testa *f* 46  
 fermacravatta *m* 36  
 fermaglio *m* 36  
 fermapiedi *m* 207  
 fermata dell'autobus *f* 197, 299  
 fermo di sicurezza *m* 75  
 ferro *m* 109, 289  
 ferro da calza *m* 277  
 ferro da cavallo *m* 242  
 ferro da stiro *m* 76  
 fertilizzazione *f* 20  
 fessura *f* 283  
 festa *f* 140  
 festa di compleanno *f* 27  
 feste *f* 27  
 feto *m* 52  
 fetta *f* 119, 139, 140  
 fettucce *f* 89  
 fiammiferi *m* 112  
 fianco *m* 12  
 fibbia *f* 36  
 fibra *f* 127  
 fibra naturale *f* 31  
 fico *m* 129  
 fico d'india *m* 128  
 fidanzata *f* 24  
 fidanzati *m* 24  
 fidanzato *m* 24  
 fiducioso 25  
 fieno *m* 184  
 fieno greco *m* 132  
 fiero 25  
 Figi 319  
 figlia *f* 22  
 figliastra *f* 23  
 figliastro *m* 23  
 figlio *m* 22  
 fil di ferro *m* 79, 89  
 fila *f* 210, 254  
 filamento *m* 60  
 filatelia *f* 273  
 file *m* 177  
 filetti 121  
 filetto *m* 119, 121  
 filetto di manzo *m* 119  
 fili *m* 60  
 Filippine 319  
 film d'amore *m* 255  
 film di fantascienza *m* 255  
 film di orrore *m* 255  
 filo *m* 276  
 filo a piombo *m* 82  
 filo dentale *m* 50  
 filo di perle *m* 36  
 filo interdentale *m* 72  
 filobus *m* 196  
 filoncino *m* 139  
 filone *m* 138, 139  
 filosofia *f* 169  
 filtro *m* 270  
 filtro dell'aria *m* 202, 204  
 filtro di carta *m* 167  
 finanza *f* 97  
 fine *m* 321  
 fine settimana *m* 306  
 finestra *f* 58, 177, 186  
 finestrino *m* 197, 209, 210  
 Finlandia 316  
 fino 320  
 finocchio *m* 122, 133  
 fioraia *f* 188  
 fioraio *m* 110  
 fiore *m* 273, 297  
 fioretto *m* 249  
 fiori *m* 110  
 fiori secchi *m* 111  
 firma *f* 96, 98  
 fisica *f* 162, 169  
 fisioterapia *f* 49  
 fitness *m* 250  
 fiume *m* 284  
 flan *m* 141  
 flash *m* 270  
 flauto *m* 257  
 flessioni *f* 251  
 flettere 251  
 foca *f* 290  
 focaccina *f* 140  
 fodera *f* 32  
 foglia *f* 122, 296  
 fogliame *m* 110  
 foglietto di omaggio *m* 173  
 follicolo *m* 20  
 fondale *m* 254  
 fondo campo *m* 220  
 fondotinta *m* 40  
 fontana *f* 85  
 football americano *m* 220  
 footing *m* 251, 263  
 foratura *f* 203, 207  
 forbici *f* 38, 47, 82, 188, 276  
 forbici da giardino *f* 89  
 forbici tagliabordi *f* 88  
 forcibice per le unghie *f* 41  
 forcilla *f* 207  
 forchetta *f* 65, 153  
 forchettone *m* 68  
 forcipe *m* 53, 167  
 forcone *m* 88, 89  
 foresta *f* 285  
 foresta pluviale *f* 285  
 forfora *f* 39  
 formaggio *m* 136, 156  
 formaggio cremoso *m* 136  
 formaggio di capra *m* 142  
 formaggio duro *m* 136  
 formaggio fresco *m* 136  
 formaggio grattugiato *m* 136  
 formaggio molle fresco *m* 136  
 formaggio morbido *m* 136  
 formaggio semiduro *m* 136  
 formaggio semimorbido *m* 136  
 formaggio tipo gorgonzola *m* 136  
 forme *f* 164  
 formica *f* 295  
 fornello da campeggio *m* 267  
 fornello *m* 67, 112  
 fornello di ceramica *m* 66  
 fornire di esca 245  
 fornitore di servizi *m* 177  
 forno *m* 66  
 forno a microonde *m* 66  
 forse 322  
 forte 321  
 foschia *f* 287  
 fossa *f* 229  
 fossa di sabbia *f* 263  
 fossato *m* 300  
 fossetta *f* 15  
 fotofinish *m* 234  
 fotofit *m* 181  
 fotografare 271  
 fotografia *f* 270, 271  
 fotografo *m* 191  
 foulard *m* 36  
 fragile 98  
 fragola *f* 127, 149  
 Francia 316  
 francobolli *m* 112  
 francobollo *m* 98  
 frappé al caffè 149  
 fratello *m* 22  
 frattaglie *f* 118  
 frattura *f* 46  
 frazione *f* 165  
 freccette *f* 273  
 freccia *f* 198, 204, 249  
 freddo 286, 321  
 fregare 77  
 fregio *m* 301  
 frenare 207  
 freno *m* 200, 204, 206  
 freno a mano *m* 203  
 frequenza *f* 179  
 fresco 121, 127, 130  
 fresia *f* 110  
 friggere 67  
 frigocongelatore *m* 67  
 frigorifero *m* 67  
 frittata *f* 158  
 fritto 159  
 fritto in olio abbondante 159  
 fritto in padella 159  
 frittura *f* 158  
 frizione *f* 200, 204  
 frizzante 144  
 frontale *m* 16  
 fronte *f* 14  
 frontone *m* 300, 301  
 frullato *m* 137  
 frullatore *m* 66  
 frusta *f* 68  
 frustino *m* 242  
 frutta *f* 107, 126, 128  
 frutta candita *f* 129  
 frutta fresca *f* 157  
 frutta secca *f* 129, 156  
 frutta snocciolata *f* 126  
 frutta tropicale *f* 128  
 frutti di mare *m* 121  
 fruttivendolo *m* 114, 188  
 frutto della passione *m* 128  
 frutto dell'albero del pane *m* 124  
 fulmine *m* 287  
 fumaiolo *m* 214  
 fumare 112  
 fumble *m* 220  
 fumo *m* 95  
 funerale *m* 26  
 fungo *m* 125  
 funivia *f* 246  
 fuoco *m* 266  
 fuori 225, 228, 320  
 fuori campo 226  
 fuorigioco *m* 223  
 fuoripista 247  
 fuoristrada *m* 199  
 furto *m* 94  
 fusibile *m* 60  
 fusoliera *f* 210  
**G**  
 gabbia *f* 95  
 gabbiano *m* 292  
 Gabon 317  
 galassia *f* 280  
 galleggiante *m* 61, 244  
 galleria *f* 254  
 galleria d'arte *f* 261  
 gallina *f* 185  
 gallo *m* 185  
 galloccia *f* 240  
 gallone *m* 311  
 galoppo *m* 243  
 galosce *f* 31, 89  
 gamba *f* 12, 64  
 gambata *f* 239  
 gamberi sgusciati *m* 120  
 gambero *m* 121  
 gambero d'acqua dolce *m* 121  
 Gambia 317  
 gambo *m* 297  
 gancio *m* 118, 187, 276  
 gara *f* 234  
 garage *m* 58, 199, 203  
 gare *f* 247  
 garofano *m* 110  
 garza *f* 47  
 gattino *m* 290  
 gatto *m* 290  
 gel *m* 38, 109  
 gelata *f* 287  
 gelato *m* 137, 149  
 gelo *m* 287  
 gemelli *m* 23  
 gemello *m* 36  
 gemme *f* 288  
 generatore *m* 60  
 generazione *f* 23  
 genere *m* 22  
 gengiva *f* 50  
 genitali *m* 12  
 genitori *m* 23  
 gennaio 306  
 geografia *f* 162  
 geometria *f* 165  
 Georgia 318  
 gerbera *f* 110  
 Germania 316  
 germoglio *m* 122  
 germoglio di soia *m* 122  
 gesso *m* 85, 162, 276, 288  
 getto d'acqua *m* 95  
 geyser *m* 285  
 Ghana 317  
 ghiacciaio *m* 284  
 ghiaccio *m* 120, 287  
 ghiaccio e limone 151  
 ghiacciolo *m* 287  
 ghiacciaia *f* 85, 88  
 ghiandola *f* 19  
 ghirolanda *f* 111  
 giacca *f* 32, 34  
 giacca a vento *f* 33  
 giaccone *m* 33  
 giacinti di bosco *m* 297  
 giada *f* 288  
 gaietto *m* 288  
 giallo 274  
 Giamaica 314  
 Giappone 318  
 galassia *f* 280  
 galleggiante *m* 61, 244  
 galleria *f* 254  
 galleria d'arte *f* 261  
 gallina *f* 185  
 gallo *m* 185  
 galloccia *f* 240  
 gallone *m* 311  
 galoppo *m* 243  
 galosce *f* 31, 89  
 gamba *f* 12, 64  
 gambata *f* 239  
 gamberi sgusciati *m* 120  
 gambero *m* 121  
 gambero d'acqua dolce *m* 121  
 Gambia 317  
 gambo *m* 297  
 gancio *m* 118, 187, 276  
 gara *f* 234  
 garage *m* 58, 199, 203  
 gare *f* 247  
 garofano *m* 110

- ginnastica aerobica *f* 251  
 ginnastica prepugilistica *f* 251  
 ginnastica ritmica *f* 235  
 ginocchiera *f* 227  
 ginocchiere *f* 220  
 ginocchio *m* 12  
 giocare 229, 273  
 giocatore *m* 220, 221, 231, 273  
 giocatore di base *m* 228  
 giocatore di cricket *m* 225  
 giocatore di hockey su ghiaccio *m* 224  
 giocatore di pallacanestro *m* 226  
 giocattoli *m* 105  
 giocattolo *m* 75  
 giocattolo di pezza *m* 75  
 giochi *m* 272  
 giochi con la racchetta *m* 231  
 giochi da tavolo *m* 272  
 gioco *m* 75, 230, 273  
 gioco a premi *m* 178  
 gioielleria *f* 114  
 gioielli *m* 36  
 gioielliere *m* 188  
 Giordania 318  
 giornale *m* 112  
 giornalino a fumetti *m* 112  
 giornalista *m* 190  
 giorno *m* 306  
 giorno del ringraziamento *m* 27  
 giorno feriale *m* 306  
 Giove 280  
 giovedì 306  
 gipsifila *f* 110  
 girabacchino *m* 78  
 giradischi *m* 268  
 giraffa *f* 179, 291  
 girasole *m* 184, 297  
 giravolta *f* 238  
 girino *m* 294  
 giro *m* 228  
 girocollo *m* 33  
 girovita *m* 35  
 giù 320  
 giubbotto da sport *m* 33  
 giubbotto di salvataggio *m* 240  
 giudice *m* 181  
 giudice di linea *m* 220, 230  
 giugno 306  
 giunco *m* 86  
 giuria *f* 180  
 gladiolo *m* 110  
 glassare 139  
 glassatura *f* 141  
 gluteo *m* 16  
 gneiss *m* 288  
 gobba *f* 291  
 gobbo *m* 179  
 gocce *f* 109  
 gocciolatoio *m* 67  
 gocciolatore *m* 53  
 gola *f* 19, 284  
 golf *m* 32, 232  
 golfista *m* 232  
 golfo mistico *m* 254  
 gomito *m* 13  
 gomma *f* 163  
 gomma da masticare *f* 113  
 gommone *m* 215  
 gong *m* 257  
 goniometro *m* 165  
 gonna *f* 30, 34  
 gorilla *m* 291  
 gotico 301  
 grafite *f* 289  
 grammo *m* 310  
 granaglie *f* 130  
 granaio *m* 182  
 granato *m* 288  
 granchio *m* 121, 295  
 grande 321  
 grande magazzino *m* 105  
 grandine *f* 286  
 granito *m* 288  
 grano *m* 130, 184  
 grano di pepe *m* 132  
 grano spezzato *m* 130  
 granturco *m* 122, 130, 184  
 grappetta *f* 173  
 grassi 39  
 grasso 41, 321  
 grasso *m* 119  
 gratella *f* 69  
 graticcio *m* 84  
 grattacielo *m* 299, 300  
 grattugia *f* 68  
 grattugiare 67  
 gravidanza *f* 52  
 gravità *f* 280  
 grazie 322  
 Grecia 316  
 green *m* 232  
 gregge *m* 183  
 grembiule *m* 38, 69  
 grembiolino *m* 30  
 grengo *m* 52  
 Grenada 314  
 gridare 25  
 grigi 39  
 grigio 274  
 griglia per barbecue *f* 267  
 grillo *m* 295  
 Groenlandia 314  
 gronda *f* 58  
 grondaia *f* 58  
 gru *f* 187, 216, 292  
 gruccia *f* 70  
 guaiava *f* 128  
 guancia *f* 14  
 guanciaie *m* 70  
 guanti *m* 30, 36, 237  
 guanti da giardinaggio *m* 89  
 guanto *m* 224, 233, 236, 246  
 guanto da forno *m* 69  
 quantone *m* 228  
 guardare la televisione 269  
 guardia *f* 180  
 guardia carceraria *f* 181  
 guardia di sicurezza *f* 189  
 guardialinee *m* 223  
 guardrail *m* 195  
 guarnizione *f* 61  
 Guatemala 314  
 guèpière *f* 35  
 gufo *m* 292  
 guida *f* 172, 260  
 guida a destra *f* 201  
 guida a sinistra *f* 201  
 guida al negozio *f* 104  
 guida turistica *f* 260  
 guidafile *m* 276  
 guidare 195  
 Guinea 317  
 Guinea Bissau 317  
 Guinea Equatoriale 317  
 guscio *m* 129, 137, 293  
 Guyana 315  
 Guyana Francese 315
- H**  
 Haiti 314  
 hamburger *m* 154  
 hamburger di pollo *m* 155  
 hamburger vegetariano *m* 155  
 handicap *m* 233  
 hard drive *m* 176  
 hardware *m* 176  
 Hawaii 314  
 heavy metal *m* 259  
 Himalaia *m* 313  
 hockey *m* 224  
 hockey su ghiaccio *m* 224  
 hockey sull'erba *m* 224  
 Honduras 314  
 hot dog *m* 155  
 hovercraft *m* 215
- I**  
 iarda *f* 310  
 icona *f* 177  
 idrante *m* 95  
 idraulico *m* 188  
 idroterapia *f* 55  
 idrovolante *m* 211  
 ieri 306  
 igiene del neonato *f* 74  
 igiene dentale *f* 72  
 igiene femminile *m* 108  
 igrone *m* 125  
 igneo 288  
 iguana *f* 293  
 illuminazione *f* 105  
 imbarazzato 25  
 imbarcare 217  
 imbarcazioni *f* 215  
 imbastire 277  
 imbottito 159  
 imbrunire *m* 304  
 imbuto *m* 166  
 impalcatura *f* 186  
 imparare 163  
 impastare 138  
 impermeabile *m* 31, 32, 245  
 impianto idraulico *m* 61  
 impianto stereo *m* 268  
 impiegato *m* 24  
 impiegato delle poste *m* 98  
 importo *m* 96  
 imposta *f* 96  
 impotente 20  
 impronta digitale *f* 94  
 impugnatura *f* 230  
 imputato *m* 181  
 imputazione *f* 180  
 in cima 320  
 in differita 178  
 in diretta 178  
 in orario 305  
 in polvere 77  
 in rete 177  
 in salamoia 143  
 in stato interessante 52  
 in tensione 60  
 inalatore *m* 44, 109  
 incarto *m* 111  
 incassare 97  
 incendio *m* 95  
 inchiestro *m* 275  
 incidente *m* 46  
 incidente stradale *m* 203  
 incidere 79  
 incinta 52  
 incisione *f* 275  
 incisivo *m* 50  
 incollare 82  
 incontro *m* 237  
 incubatrice *f* 53  
 indaco 274  
 indagine *f* 94  
 India 318  
 indicatore di livello dell'olio *m* 202  
 indicazioni *f* 260  
 indice *m* 15  
 indirizzo *m* 98  
 indirizzo di posta elettronica *m* 177  
 indivia *f* 123  
 Indonesia 319  
 indumenti impermeabili *m* 267  
 indumenti per la notte *m* 31  
 indumenti termici *m* 267  
 infarto *m* 44  
 infermiera *f* 45, 48, 52, 189  
 infezione *f* 44  
 inflare 277  
 influenza *f* 44  
 inforcare 90  
 informazione *f* 261  
 informazione turistica *f* 261  
 informazioni telefoniche *f* 99  
 infreddatura *f* 44  
 ingegneria *f* 169  
 ingorgo *m* 195  
 ingrandimento *m* 271  
 ingrandire 172  
 ingresso *m* 59, 100  
 ingresso vietato *m* 195  
 inguine *m* 12  
 iniezione *f* 48  
 iniziare la scuola 26  
 inizio *m* 321  
 innamorarsi 26  
 innestare 91  
 innocente 181  
 inoculazione *f* 45  
 inondazione *f* 287  
 inquilino *m* 58  
 insalata *f* 149  
 insalata mista *f* 158  
 insalata verde *f* 158  
 insegna *f* 104  
 insegnante *m* 191  
 insegnante m/f 162  
 inseguire 229  
 insettifuogo *m* 108  
 insonnia *f* 71  
 installazione *f* 177  
 insulina *f* 109  
 integrale 131  
 integratore *m* 55  
 intercostale *m* 16  
 Internet 177  
 interno *m* 200  
 intero 129, 132  
 interruttore *m* 60  
 interruttore per le luci *m* 201  
 interruzione di corrente *f* 60  
 intervallo *m* 223, 254  
 intervistatore *m* 179  
 intestino crasso *m* 18  
 intestino tenue *m* 18  
 intonacare 83  
 intonaco *m* 82  
 intrattenimenti in casa *m* 268  
 invasare 91  
 inverno *m* 31, 307  
 invertebrati *m* 295  
 investigatore *m* 94  
 investimento *m* 97  
 ionosfera *f* 286  
 ipositerapia *f* 55  
 ipoallergenico 41  
 ipoteca *f* 96  
 ipotenusa *f* 164  
 ippodromo *m* 243  
 ippoglossio *m* 120  
 ippopotamo *m* 291  
 Iran 318  
 Iraq 318

iride *f* 51  
iris *m* 110  
Irlanda 316  
irrigare 183  
irrigatore *m* 89  
isola *f* 282  
Isola Falkland 315  
Isole Galapagos 315  
isolamento *m* 61  
Isole Baleari 316  
Isole Salomone 319  
Israele 318  
istruttore individuale *m* 250  
istruzioni *f* 109  
Italia 316  
itinerario *m* 260

**J**  
jazz *m* 259  
jeans *m* 31  
jolly *m* 273  
judo *m* 236  
Jugoslavia 316

**K**  
k.o. *m* 237  
Kaliningrad 316  
karate *m* 236  
kayak *m* 241  
Kazakistan 318  
kendo *m* 236  
Kenya 317  
ketchup *m* 135  
kickboxing *m* 236  
Kirghizistan 318  
kit per riparazioni *m* 207  
kiwi *m* 128  
koala *m* 291  
kung-fu *m* 236  
Kuwait 318

**L**  
labbra *f* 20  
labbro *m* 14  
laboratorio *m* 78, 166  
lacca *f* 38, 79  
laccio *m* 37  
lacrima *f* 51  
lacrosse *m* 249  
lago *m* 285  
lama *f* 60, 66, 78, 89, 246  
lama rotante *f* 211  
lametta *f* 73  
lampada *f* 50, 62, 178  
lampadina *f* 60, 70  
lampeggiatore *m* 270  
lampone *m* 127  
lana *f* 277  
lana d'acciaio *f* 81  
lancetta dei minuti *f* 304  
lancetta dei secondi *f* 304  
lancetta delle ore *f* 304  
lancia di salvataggio *f* 214  
lanciarazzi *m* 281

lanciare 225, 229, 245  
lanciatore *m* 225  
lancio *m* 281  
lancio del disco *m* 234  
lancio del giavellotto *m* 234  
lancio del peso *m* 234  
Laos 318  
laptop *m* 175  
larghezza *f* 165  
largo 321  
larice *m* 296  
laringe *f* 19  
lassativo *m* 109  
lastrina *f* 167  
latitudine *f* 283  
lato *m* 164  
latte *m* 136, 156  
latte condensato *m* 136  
latte detergente *m* 41  
latte di capra *m* 136  
latte di mucca *m* 136  
latte di pecora *m* 137  
latte in polvere *m* 137  
latte intero *m* 136  
latte parzialmente scremato *m* 136  
latte scremato *m* 136  
latticini *m* 107, 136  
lattina *f* 145, 311  
lattosio *m* 137  
lattuga *f* 123  
laurea *f* 169  
laurearsi 26  
laureata *f* 169  
lava *f* 283  
lavagna *f* 162  
lavagna luminosa *f* 163, 174  
lavanderia *f* 76, 115  
lavandino *m* 38, 66, 72  
lavare 38, 77  
lavasciuga *m* 76  
lavasecco *m* 115  
lavastoviglie *f* 66  
lavatrice *f* 76  
lavori stradali *m* 187, 195  
lavoro *m* 172  
lavoro a maglia *m* 277  
lecca lecca *m* 113  
lega per saldatura *f* 79, 81  
legamento *m* 17  
legge *f* 180  
leggere 162  
leggero 321  
legno *m* 79, 187, 275  
legno dolce *m* 79  
legno duro *m* 79  
legumi secchi *m* 130  
lente *f* 51  
lenti a contatto *f* 51  
lenticchie marroni *f* 131  
lenticchie rosse *f* 131  
lentiggine *f* 15  
lento 321  
lenza *f* 244  
lenzuolo *m* 71, 74  
leone *m* 291

leone marino *m* 290  
Lesotho 317  
lettera *f* 98, 272  
lettera per posta aerea *f* 98  
letteratura *f* 162, 169  
lettiga *f* 48  
lettino *m* 74  
lettino da campeggio *m* 266  
lettino solare *m* 41  
letto *m* 70  
letto matrimoniale *m* 71  
letto singolo *m* 71  
Lettonia 316  
lettore di cd *m* 268  
lettore di cd portatile *m* 269  
lettore di dvd *m* 268  
lettore di mini disk *m* 268  
lettore di MP3 *m* 268  
lettore ottico *m* 106  
leva *f* 61, 150  
leva del cambio *f* 201, 207  
leva del freno *f* 207  
leva di emergenza *f* 209  
leva per il pneumatico *f* 207  
lezione *f* 163  
Libano 318  
libbra *f* 310  
libellula *f* 295  
Liberia 317  
libero 321  
libertà per buona condotta *f* 181  
Libia 317  
libreria *f* 63, 115  
libretto degli assegni *m* 96  
libro *m* 168  
libro di testo *m* 163  
libro paga *m* 175  
licenza di pesca *f* 245  
Liechtenstein 316  
lievito *m* 138  
lima *f* 81  
limetta *f* 41, 126  
limite *m* 225  
limite di velocità *m* 195  
limo *m* 85  
limonata *f* 144  
limone *m* 126  
limousine *f* 199  
linea *f* 225  
linea dei tre punti *f* 226  
linea del gol *f* 220  
linea della porta *f* 224  
linea di centro *f* 226  
linea di fallo *f* 229  
linea di fondo *f* 223, 226, 230  
linea di gioco *f* 233  
linea di palla morta *f* 221  
linea di partenza *f* 234  
linea di servizio *f* 230  
linea di tiro libero *f* 226  
linea di touch *f* 221

linea divisoria *f* 194  
linea laterale *f* 220, 226, 230  
linee *f* 165  
linfatico 19  
lingua *f* 19, 37, 118, 162  
lino *m* 184, 277  
liquido 77  
liquido amniotico *m* 52  
liquirizia *f* 113  
liquore *m* 145  
lisci 39  
lista dei libri *f* 168  
lista dei vini *f* 152  
listino *m* 154  
litchi *m* 128  
litro *m* 311  
Lituania 316  
livella *f* 80, 187  
livello *m* 163  
livido *m* 46  
locomotiva *f* 208  
lombo *m* 121  
longitudine *f* 283  
lontano 320  
lontra *f* 290  
lotta greco-romana *f* 236  
lozione *f* 109  
lozione per il corpo *f* 73  
lozione tonificante *f* 41  
lucchetto *m* 207  
luce *f* 217  
luce del portico *f* 58  
luce del sole *f* 286  
luce di lettura *f* 210  
lucertola *f* 293  
luci *f* 94  
luci intermittenti *f* 201  
lucidare 77  
lucidatore *m* 78  
lucido 83, 271  
luffa *f* 73  
luglio 306  
lumaca *f* 295  
luna *f* 280  
luna nuova *f* 280  
luna park *m* 262  
luna piena *f* 280  
lunaria *f* 288  
lunedì 306  
lunghezza *f* 165, 310  
lunghezza d'onda *f* 179  
lungo 32, 320  
lungomare *m* 265  
lungometraggio *m* 269  
luoghi d'interesse *m* 261  
luogo d'interesse turistico *m* 260  
lupini *m* 297  
lupo *m* 290  
Lussemburgo 316

**M**  
macadamia *f* 129  
macchina da caffè *f* 150  
macchina da cucire *f* 276  
macchina del caffè *f* 148

macchina fotografica *f* 260  
macchina fotografica APS *f* 270  
macchina fotografica digitale *f* 270  
macchina fotografica istantanea *f* 270  
macchina fotografica usa e getta *f* 270  
macchina per esercizi *f* 250  
macchina per step *f* 250  
macchinari *m* 187  
Macedonia 316  
macellaio *m* 118, 188  
macelleria *f* 114  
macinato 132, 144  
macinatore di rifiuti *m* 61  
macis *m* 132  
macramè *m* 277  
Madagascar 317  
madre *f* 22  
magazzino *m* 216  
maggio 306  
maggiorana *f* 133  
maglia *f* 36  
maglietta *f* 30, 33, 251  
maglione *m* 33  
magma *f* 283  
magnesio *m* 109  
magro 321  
maiale *m* 118, 185  
maialino *m* 185  
maionese *f* 135  
mal di denti *m* 50  
mal di stomaco *m* 44  
mal di testa *m* 44  
malachite *f* 288  
malattia *f* 44  
malattia trasmissibile per via sessuale *f* 20  
Malawi 317  
Malaysia 318  
Maldivi 318  
Mali 317  
Malta 316  
malta *f* 83, 187  
mammiferi *m* 290  
manchego *m* 142  
mandare da uno specialista 49  
mandarino *m* 126  
mandato *m* 180  
mandibola *f* 14, 17  
mandorla *f* 129  
mandorla brasiliana *f* 129  
mandorle *f* 151  
mandria *f* 183  
mandrino *m* 78  
manette *f* 94  
manganello *m* 94  
mangianastri *m* 268, 269  
mangiare 64  
mangiare sul posto 154  
mangiatoia *f* 183  
mango *m* 128

- mangostina *f* 128  
 manica *f* 34  
 manichino *m* 276  
 manici *m* 37  
 manico *m* 36, 88, 106, 187, 258  
 manicotto *m* 45  
 manicure *f* 41  
 maniglia *f* 196, 200  
 mannaia *f* 68  
 mano *f* 13, 15  
 mano di fondo *f* 83  
 mano finale *f* 83  
 manopola di messa a fuoco *f* 167  
 mantello *m* 282  
 mantide religiosa *f* 295  
 manuale 200  
 manubri *m* 250  
 manubrio *m* 207, 251  
 manzo *m* 118  
 mapo *m* 126  
 mappa *f* 195, 261  
 mappa della metropolitana *f* 209  
 mappamondo *m* 312  
 Mar Baltico *m* 313  
 Mar Caspio *m* 313  
 Mar dei Caraibi *m* 312  
 Mar Mediterraneo *m* 313  
 Mar Nero *m* 313  
 Mar Rosso *m* 313  
 maracas *m* 257  
 maratona *f* 234  
 marca di bordo libero *f* 214  
 marcare 227  
 marcatore per le labbra *m* 40  
 marce *f* 206  
 marciapiede *m* 298  
 marcio 127  
 mare *m* 264, 282  
 Mare Arabico *m* 313  
 Mare del Nord *m* 312  
 margarina *f* 137  
 margherita *f* 110, 297  
 marinaio *m* 189  
 marinato 143, 159  
 marito *m* 22  
 marmellata *f* 134, 156  
 marmellata agli agrumi *f* 156  
 marmellata di agrumi *f* 134  
 marmellata di lamponi *f* 134  
 marmo *m* 288  
 Marocco 317  
 marrone 274  
 marsupio *m* 75, 291  
 Marte 280  
 martedì 306  
 martelletto *m* 181  
 martello *m* 68, 79, 80, 275  
 martello pneumatico *m* 187  
 martini *m* 151  
 marzapane *m* 141  
 marzo 306  
 mascara *m* 40  
 maschera *f* 228, 236, 239, 249, 255  
 maschera di bellezza *f* 41  
 maschera protettiva *f* 225  
 mascherina *f* 189  
 maschili 21  
 mass media *m* 178  
 massaggio *m* 54  
 masters *m* 169  
 matassa *f* 277  
 matematica *f* 162, 164  
 materassino *m* 74, 267  
 materassino ad aria *m* 267  
 materasso *m* 70, 74  
 materiali *m* 79, 187  
 maternità *f* 49  
 matita *f* 163, 275  
 matita colorata *f* 163  
 matita per gli occhi *f* 40  
 matita per le sopracciglia *f* 40  
 matrice *f* 96  
 matrigna *f* 23  
 matrimonio *m* 26, 35  
 mattarello *m* 69  
 mattino *m* 305  
 mattone *m* 187  
 maturo 129  
 Mauritania 317  
 Maurizio 317  
 mazza *f* 187, 224, 225, 228, 249  
 mazza da hockey *f* 224  
 mazza di ferro *f* 233  
 mazza di legno *f* 233  
 mazza ricurva *f* 233  
 mazze da golf *f* 233  
 mazzetto *m* 111  
 mazzetto odoroso *m* 132  
 mazzo di carte *m* 273  
 mazzo di fiori *m* 111  
 mazzuolo *m* 78  
 MDF *m* 79  
 meccanica *f* 202  
 meccanico *m* 188, 203  
 medaglie *f* 235  
 medicamento *m* 109  
 medicina *f* 109, 169  
 medicina aiurvedica *f* 55  
 medicina per la tosse *f* 108  
 medico *m* 45, 189  
 medio *m* 15  
 meditazione *f* 54  
 medusa *f* 295  
 mela *f* 126  
 mela cotogna *f* 128  
 melanzana *f* 125  
 melodia *f* 259  
 melograno *m* 128  
 melone *m* 127  
 memoria *f* 176  
 meno 165  
 mensile 307  
 mensola *f* 67  
 mensola del caminetto *f* 63  
 mensole *f* 66  
 menta *f* 133  
 mentina *f* 113  
 mento *m* 14  
 menù *m* 148, 153, 154  
 menù del pranzo *m* 152  
 menù della cena *m* 152  
 menù per bambini *m* 153  
 mercato *m* 97, 115  
 merceria *f* 105  
 mercoledì 306  
 mercurio *m* 289  
 Mercurio 280  
 meridiana *f* 262  
 meringa *f* 140  
 merlango *m* 120  
 merluzzo *m* 120  
 mescolare 138, 273  
 mese *m* 306  
 mesosfera *f* 286  
 messa a terra *f* 60  
 messa in fase *f* 203  
 messaggi *m* 100  
 messaggio di testo *m* 99  
 messaggio vocale *m* 99  
 Messico 314  
 mestieri *m* 188, 190  
 mestolo *m* 68  
 mestruazione *f* 20  
 meta *f* 221  
 metacarpo *m* 17  
 metalli *m* 289  
 metallo *m* 79  
 metamorfico 288  
 metatarso *m* 17  
 meteora *f* 280  
 metodi *m* 159  
 metro *m* 80, 276, 310  
 metro quadro *m* 310  
 metropolitana *f* 209  
 mettere a bagno 130  
 mettere a fuoco 271  
 mettere in piega 38  
 mettere la sveglia 71  
 mezza pensione *f* 101  
 mezzaluna *f* 280  
 mezzanotte *f* 305  
 mezzo litro *m* 311  
 mezzogiorno *m* 305  
 mica *f* 289  
 microfono *m* 179, 258  
 microscopio *m* 167  
 miele condensato *m* 134  
 miele sciolto *m* 134  
 mietitrebbia *f* 182  
 miglio *m* 130, 310  
 mignolo *m* 15  
 mignolo del piede *m* 15  
 miliardo 309  
 milione *m* 309  
 mille 309  
 millennio *m* 307  
 millenovecento 307  
 millenovecentodieci 307  
 millenovecentouno 307  
 millepiedi *m* 295  
 milligrammo *m* 310  
 millilitro *m* 311  
 millimetro *m* 310  
 milza *f* 18  
 minerali *m* 289  
 minestra *f* 153, 158  
 minibar *m* 101  
 minigonna *f* 34  
 minuto *m* 304  
 miopia *f* 51  
 mirino *m* 271  
 mirtillo *m* 127  
 miscelatore *m* 66, 150  
 mischia *f* 221  
 missile *m* 211  
 misura *f* 151  
 misura di liquido *f* 311  
 misurare 310  
 misuratore di altezza *m* 45  
 misuratore di pressione *m* 45  
 misure *f* 165  
 misurino *m* 150  
 mitragliatrice *f* 189  
 mittente *m* 98  
 mobile *m* 74  
 mocassino *m* 37  
 moda *f* 277  
 modella *f* 169  
 modellismo *m* 275  
 modello *m* 190, 276  
 modem *m* 176  
 modulo di prelievo *m* 96  
 modulo di versamento *m* 96  
 modulo lunare *m* 281  
 moglie *f* 22  
 molare *m* 50  
 Moldavia 316  
 mollare l'ancora *f* 217  
 molletta *f* 38, 76, 173  
 molletta per il naso *f* 238  
 molo *m* 217  
 moltiplicare 165  
 moltiplicato per 165  
 Monaco 316  
 monete *f* 97  
 monete non utilizzate *f* 99  
 mongolfiera *f* 211  
 Mongolia 318  
 monitor *m* 53, 172, 176  
 monopoly *m* 272  
 monorotaia *f* 208  
 monouso 109  
 monovolume *f* 199  
 monsoni *m* 287  
 montagna *f* 284  
 Montagne Rocciose *f* 312  
 montagne russe *m* 262  
 montatura *f* 51  
 montgomery *m* 31  
 monumento *m* 261  
 mora *f* 127  
 mora-lampone *f* 127  
 morbido 129, 321  
 morbillo *m* 44  
 mordente per legno *m* 79  
 morire 26  
 morsa *f* 78  
 morsetto *m* 78, 166, 167  
 morso *m* 46, 78, 242  
 mortaio *m* 68, 167  
 mosca *f* 244, 295  
 moschea *f* 300  
 mossa *f* 273  
 mosse *f* 237  
 mostarda *f* 135  
 mostarda con semi *f* 135  
 moto da corsa *f* 205  
 moto da cross *f* 205  
 moto da turismo *f* 205  
 motocicletta *f* 204  
 motociclismo *m* 249  
 motocross *m* 249  
 motore *m* 88, 202, 204, 210  
 motore fuoribordo *m* 215  
 motoscafo *m* 214  
 motoslitte *f* 247  
 mountain bike *f* 206  
 mouse *m* 176  
 mousse *m* 141  
 Mozambico 317  
 mozzarella *f* 142  
 mozzo *m* 206  
 mucca *f* 185  
 muffin *m* 140  
 mulinello *m* 214, 244  
 multivitaminata *f* 109  
 mungere 183  
 municipio *m* 299  
 muratore *m* 186, 188  
 muro *m* 58, 186, 222  
 muscoli *m* 16  
 museo *m* 261  
 musica *f* 162  
 musica classica *f* 255, 259  
 musica da ballo *f* 259  
 musica folk *f* 259  
 musical *m* 255  
 musicista *m* 191  
 muso *m* 210, 293  
 mutande di plastica *f* 30  
 mutandine *f* 35  
 Myanmar 318  
**N**  
 naan *m* 139  
 nailon *m* 277  
 Namibia 317  
 narciso *m* 111  
 narice *f* 14  
 nascere 26  
 nascita *f* 52

- naso *m* 14  
 nassa *f* 245  
 nastro *m* 27, 39, 111, 141, 235  
 nastro adesivo *m* 47, 173  
 nastro adesivo coprente *m* 83  
 nastro convogliatore *m* 106  
 nastro isolante *m* 81  
 nastro trasportatore *m* 212  
 Natale *m* 27  
 natica *f* 13  
 naturale 256  
 naturopatia *f* 55  
 nausea *f* 44  
 nave *f* 214  
 nave da crociera *f* 215  
 nave da guerra *f* 215  
 nave da trasporto *f* 215  
 nave porta container *f* 215  
 navetta *f* 197  
 navigare 240  
 navigazione *f* 177  
 navigazione via satellite *f* 201  
 nazione *f* 315  
 nebbia *f* 287  
 nebulizzatore *m* 311  
 nebulosa *f* 280  
 negativo *m* 271  
 negatoscopio *m* 45  
 négligé *m* 35  
 negozio *m* 298  
 negozio dell'usato *m* 115  
 negozio di alimenti biologici *m* 115  
 negozio di animali *m* 115  
 negozio di antiquariato *m* 114  
 negozio di articoli da regalo *m* 114  
 negozio di articoli fotografici *m* 115  
 negozio di articoli per l'arte *m* 115  
 negozio di calzature *m* 114  
 negozio di dischi *m* 115  
 negozio di dolciumi *m* 113  
 negozio di ferramenta *m* 114  
 negozio di liquori *m* 115  
 negozio di mobili *m* 115  
 negozio duty free *m* 213  
 neo *m* 14  
 neoclassico 301  
 neonato *m* 53  
 Nepal 318  
 nero 39, 272, 274  
 nervo *m* 19, 50  
 nervo ottico *m* 51  
 nervoso 19, 25  
 Nettuno 280  
 neurologia *f* 49
- neutro 60  
 neve *f* 287  
 nevischio *m* 286  
 Nicaragua 314  
 nichel *m* 289  
 Niger 317  
 Nigeria 317  
 nipote *f* 22, 23  
 nipote *m* 22, 23  
 nipoti *m* 23  
 no 322  
 nocca *f* 15  
 nocciola *f* 129  
 noccioline *f* 151  
 noccioline americane *f* 151  
 nocciolo *m* 122, 129  
 noce *f* 129  
 noce di cocco *f* 129  
 noce moscata *f* 132  
 non pastorizzato 137  
 non piegare 98  
 nonna *f* 22  
 nonni *m* 23  
 nonno *m* 22  
 nono 309  
 nord *m* 312  
 normale 39  
 Norvegia 316  
 nota *f* 256  
 notte *f* 305  
 novanta 308  
 novantesimo 309  
 nove 308  
 novecento 308  
 novembre 306  
 nuca *f* 13  
 nucleo esterno *m* 282  
 nucleo interno *m* 282  
 numeratore *m* 165  
 numeri *m* 308  
 numero *m* 226  
 numero del binario *m* 208  
 numero del percorso *m* 196  
 numero del volo *m* 213  
 numero della camera *m* 100  
 numero dell'uscita *m* 213  
 numero di conto *m* 96  
 nuora *f* 22  
 nuotare 238  
 nuotatore *m* 238  
 nuoto *m* 238  
 nuoto sincronizzato *m* 239  
 nuoto subacqueo *m* 239  
 Nuova Zelanda 319
- nuvola *f* 287  
 nuvoloso 286
- O**  
 obiettivo *m* 167, 270  
 obìo *m* 214  
 oboe *m* 257  
 oca *f* 119, 293
- occhialetti *m* 238  
 occhiali *m* 51, 247  
 occhiali da sole *m* 51, 265  
 occhiali protettivi *m* 81, 167  
 occhio *m* 37, 244, 276  
 occhio *m* 14, 51  
 occhio rosso *m* 271  
 occupato 99, 321  
 Oceania 319  
 oceano *m* 282  
 Oceano Antartico *m* 313  
 Oceano Artico *m* 312  
 Oceano Atlantico *m* 312  
 Oceano Indiano *m* 312  
 Oceano Pacifico *m* 312  
 oculare *m* 167, 269  
 odometro *m* 201  
 offerte *f* 106  
 oftalmologia *f* 49  
 oggetto *m* 261  
 oggi 306  
 okra *f* 122  
 oli *m* 134  
 oli essenziali *m* 55  
 olio *m* 142, 199  
 olio aromatizzato *m* 134  
 olio di colza *m* 135  
 olio di mais *m* 135  
 olio di mandorla *m* 134  
 olio di noccioline *m* 134  
 olio di noce *m* 134  
 olio di semi di arachide *m* 135  
 olio di semi di girasole *m* 134  
 olio di semi di sesamo *m* 134  
 olio di semi d'uva *m* 134  
 olio d'oliva *m* 134  
 olio spremuto a freddo *m* 135  
 olio vegetale *m* 135  
 oliva nera *f* 143  
 oliva ripiena *f* 143  
 oliva verde *f* 143  
 olive *f* 151  
 olivetta *f* 31  
 olmo *m* 296  
 oltre 320  
 Oman 318  
 ombelico *m* 12  
 ombrello *m* 36, 233  
 ombrellone *m* 264  
 ombretto *m* 40  
 omeopatia *f* 55  
 omero *m* 17  
 omogeneizzato 137  
 oncia *f* 310  
 oncologia *f* 49  
 onda *f* 241, 264  
 onda corta *f* 179  
 onda lunga *f* 179  
 onda media *f* 179  
 onice *f* 289  
 opaco 83, 271  
 opale *m* 288
- opera *f* 255  
 opera teatrale *f* 254  
 operatore *m* 99  
 operazione *f* 48  
 opuscolo *m* 175  
 opuscolo vacanza *m* 212  
 ora *f* 304, 304  
 ora di punta *f* 209  
 orari *m* 261  
 orario *m* 197, 209, 261  
 orario delle visite *m* 48  
 orbita *f* 280  
 orchestra *f* 254, 256  
 orchidea *f* 111  
 ordinare 153  
 ordine *m* 180  
 ordine del giorno *m* 174  
 orecchino *m* 36  
 orecchio *m* 14  
 orecchioni *m* 44  
 oreficeria *f* 275  
 organi riproduttivi *m* 20  
 origami *m* 275  
 origano *m* 133  
 orizzontale 271  
 orlo *m* 34  
 ormeggiare 217  
 ormeggio *m* 217  
 ormone *m* 20  
 ornamentale 87  
 ornamenti oggetti per giardini *m* 84  
 ornitologia *f* 263  
 oro *m* 289  
 oro *f* 235  
 orologio *m* 62, 304  
 orologio da polso *m* 36  
 orsacchiotto *m* 75  
 orso *m* 291  
 orso polare *m* 291  
 ortica *f* 297  
 orto *m* 85, 182  
 ortopedia *f* 49  
 orzo *m* 130, 184  
 ospedale *m* 48  
 ospite *m* 64, 100  
 ossicocco *m* 127  
 ossidiana *f* 288  
 osso *m* 17, 119  
 ostacolo *m* 243  
 osteopatia *f* 54  
 ostetrica *f* 53  
 ostetrico *m* 52  
 ostrica *f* 121  
 otorinolaringologia *f* 49  
 ottagono *m* 164  
 ottanta 308  
 ottantesimo 309  
 ottavo 309  
 ottico *m* 51, 189  
 otto 308  
 ottobre 306  
 ottocento 308  
 ottoni *m* 256  
 otturare 82  
 otturazione *f* 50  
 ouverture *f* 256
- ovaja *f* 20  
 ovale *m* 164  
 overpar *m* 233  
 ovest *m* 312  
 ovulazione *f* 20, 52  
 ovulo *m* 20
- P**  
 pacchetto *m* 311  
 pacchetto di sigarette *m* 112  
 pacco *m* 99  
 padella *f* 69  
 padella per grigliare *f* 69  
 padre *m* 22  
 padrona di casa *f* 64  
 padrone di casa *m* 58, 64  
 paesaggio *m* 284  
 paese *m* 315  
 Paesi Bassi 316  
 pagaia *f* 241  
 pagamento *m* 96  
 pagare 153  
 Pakistan 318  
 pala *f* 187  
 palafreniere *m* 243  
 palato *m* 19  
 palco *m* 254  
 palcoscenico *m* 254  
 palestra *f* 101, 250  
 paletta *f* 77, 89, 265  
 paletta forata *f* 68  
 palla *f* 75, 228, 230  
 palla da bowling *f* 249  
 pallacanestro *f* 226  
 pallanuoto *f* 239  
 pallavolo *f* 227  
 palleggiare 223  
 palleggio *m* 230, 231  
 pallet *m* 186  
 pallina *f* 149, 224  
 pallina da cricket *f* 225  
 pallina da golf *f* 233  
 pallone *m* 220, 221, 222, 226  
 pallone da spiaggia *m* 265  
 palma *f* 86, 296  
 palmo *m* 15  
 palmtop *m* 175  
 palo *m* 222, 245, 266  
 palo della porta *m* 220  
 palpebra *f* 51  
 palude *f* 285  
 pan di Spagna *m* 140  
 Panama 314  
 panca *f* 250  
 pancetta *f* 118, 157  
 panchina *f* 262  
 pancreas *m* 18  
 panda *m* 291  
 pane *m* 157  
 pane affettato *m* 138  
 pane alla frutta *m* 139  
 pane bianco *m* 139  
 pane biscottato *m* 139, 156



- pane con lievito naturale *m* 139  
 pane con semi *m* 139  
 pane di granaio *m* 139  
 pane di mais *m* 139  
 pane di segale *m* 138  
 pane e le farine *m* 138  
 pane fritto all'uovo *m* 157  
 pane integrale *m* 139, 149  
 pane lievitato con bicarbonato di sodio *m* 139  
 pane tostato *m* 157  
 panetteria *f* 107  
 panettiere *m* 139  
 panificio *m* 114, 138  
 panino *m* 139, 143, 155  
 paninoteca *f* 143  
 panna *f* 137, 140, 157  
 panna acida *f* 137  
 panna densa *f* 137  
 panna fresca *f* 137  
 panna liquida *f* 137  
 panna montata *f* 137  
 panne *f* 203  
 pannello degli orari *m* 213  
 pannello di protezione *m* 66  
 panni sporchi *m* 76  
 pannolino *m* 75  
 pannolino di spugna *m* 30  
 pannolino usa e getta *m* 30  
 pantacollant *m* 31  
 pantaloncini *m* 30  
 pantaloni *m* 32, 34  
 pantaloni da equitazione *m* 242  
 pantaloni di felpa *m* 33  
 pantofole *f* 31  
 papaia *f* 128  
 papavero *m* 297  
 pappagallo *m* 293  
 paprica *f* 132  
 Papua Nuova Guinea 319  
 par *m* 233  
 parabrezza *m* 198, 205  
 paracadute *m* 248  
 paracadutismo *m* 248  
 paracadutismo libero *m* 248  
 paracolpi *m* 74  
 paradenti *m* 237  
 parafrangente *m* 205  
 parafrangente *m* 63  
 paraginocchio *m* 205  
 Paraguay 315  
 parallelo 165  
 parallelogramma *m* 164  
 paramedico *m* 94  
 parapendio *m* 248  
 parere 223  
 parastinchi *m* 224, 225  
 parata *f* 237  
 paraurti *m* 198  
 paravento *m* 265  
 parcheggiare 195  
 parcheggio *m* 298  
 parcheggio per disabili *m* 195  
 parchimetro *m* 195  
 parco *m* 262  
 parco a tema *m* 262  
 parco giochi *m* 263  
 parco nazionale *m* 261  
 pareggio *m* 223  
 parenti *m* 23  
 parmigiano *m* 142  
 parrucca *f* 39  
 parrucchiere *m* 38, 115, 188  
 parte bassa *f* 239  
 parte profonda *f* 239  
 partecipare 174  
 partenze *f* 213  
 partita *f* 230  
 partitura musicale *f* 255  
 partner di affari *m/f* 24  
 parto *m* 52, 53  
 parto assistito *m* 53  
 pascolo *m* 182, 285  
 Pasqua *f* 27  
 Pasqua ebraica *f* 27  
 passaggio *m* 226  
 passaggio pedonale *m* 195, 212  
 passaporto *m* 213  
 passare 220, 223  
 passeggero *m* 216  
 passeggiata *f* 75  
 passeggino *m* 75  
 passerella *f* 214  
 passerone *m* 292  
 passo *m* 243  
 pasta *f* 138, 140, 149, 158  
 pasta filo *f* 140  
 pasta sfoglia *f* 140  
 pastelli *m* 274  
 pasticca *f* 109  
 pasticca per la gola *f* 109  
 pasticceria *f* 114  
 pasticche antinausea *f* 109  
 pasticci di carne *m* 143  
 pasticcio *m* 158  
 pastinaca *f* 125  
 pasto *m* 64, 75  
 pasto con hamburger *m* 154  
 pastorizzato 137  
 patata *f* 124  
 patata dolce *f* 125  
 patata novella *f* 124  
 patate fritte *f* 154  
 patatine *f* 113, 151  
 patchwork *m* 277  
 pâté *m* 142, 156  
 patio *m* 85  
 patio in legno *m* 85  
 patologia *f* 49  
 patigno *m* 23  
 pattinaggio *m* 263  
 pattinaggio a rotelle *m* 249  
 pattinaggio artistico *m* 247  
 pattinaggio di velocità *m* 247  
 pattinaggio su ghiaccio *m* 247  
 pattinare 224  
 pattino *m* 224, 247  
 pattino a rotelle *m* 249  
 pattumiera *f* 61, 67  
 pausa *f* 256, 269  
 pavimentazione *f* 85  
 pavimento *m* 62, 71  
 pavone *m* 293  
 paziente *m* 45  
 paziente esterno *m* 48  
 pecan *m* 129  
 pecora *f* 185  
 pedalare 207  
 pedale *m* 61, 206  
 pedale del freno *m* 205  
 pedana *f* 235  
 pedana del letto *f* 71  
 pedana di lancio *f* 228  
 pedana elastica *f* 235  
 pediatria *f* 49  
 pedicure *f* 41  
 pedina *f* 272  
 pedone *m* 272  
 pelapatate *m* 68  
 pelle *f* 14, 119  
 pellicano *m* 292  
 pellicina *f* 15  
 pellicola *f* 260, 271  
 pellicola radiografica *f* 50  
 pendaglio *m* 36  
 pendice *f* 284  
 pendolare *m* 208  
 pene *m* 21  
 penisola *f* 282  
 penna *f* 163  
 pennello *m* 40, 83, 274  
 pennello da colla *m* 82  
 pennello da cucina *m* 69  
 pennello per le labbra *m* 40  
 pensilina *f* 197  
 pensione completa *f* 101  
 pensione con colazione *f* 101  
 pentagono *m* 164  
 pentagramma *m* 256  
 pentola *f* 69  
 peonia *f* 111  
 pepe *m* 64, 152  
 pepe della Giamaica *m* 132  
 peperoncino *m* 124, 132, 143  
 peperone *m* 124  
 per 320  
 per favore 322  
 pera *f* 127  
 percentuale *f* 165  
 percussione *f* 257  
 perdente *m* 273  
 perdere 273  
 perenne 86  
 perfezionamento *m* 169  
 perforatore *m* 173  
 pergola *f* 84  
 pericolo *m* 195  
 periferia *f* 299  
 periodico *m* 168  
 permanente *f* 39  
 permesso 322  
 perone *m* 17  
 perpendicolare 165  
 persiana *f* 58  
 persona sospetta *f* 181  
 personale *m* 175  
 persone *f* 12, 16  
 Perù 315  
 pesante 321  
 pesare 310  
 pesca *f* 126, 128, 244, 245  
 pesca con la fiocina *f* 245  
 pesca con la mosca *f* 245  
 pesca dalla riva *f* 245  
 pesca in acqua dolce *f* 245  
 pesca in alto mare *f* 245  
 pesca in mare *f* 245  
 pesca noce *f* 126  
 pesca sportiva *f* 245  
 pescare con la rete 245  
 pescatore *m* 189, 244  
 pesce *m* 107, 120  
 pesce affumicato *m* 143  
 pesce con patatine *m* 155  
 pesce rosso *m* 294  
 pesce spada *m* 120, 294  
 pescheria *f* 114, 120  
 pesci *m* 294  
 pescivendola *f* 188  
 peso *m* 166, 244  
 peso alla nascita *m* 53  
 pestello *m* 68, 167  
 pesticida *m* 89, 183  
 petalo *m* 297  
 petizione *f* 180  
 petroliera *f* 215  
 pettinare 38  
 pettine *m* 38, 121  
 petto *m* 119  
 pettorale *m* 16  
 piadina *f* 155  
 pialla *f* 81  
 piallare 79  
 pianerottolo *m* 59  
 pianeta *m* 280, 282  
 piangere 25  
 piano *m* 58  
 piano di lavoro *m* 66  
 piano di mixaggio *m* 179  
 piano inferiore *m* 141  
 piano superiore *m* 141  
 piano terra *m* 104  
 pianoforte *m* 256  
 pianta acquatica *f* 86  
 pianta adatta all'ombra *f* 87  
 pianta copriterreno *f* 87  
 pianta da fiore *f* 87  
 pianta da fiori *f* 297  
 pianta da vaso *f* 87, 110  
 pianta del piano *f* 261  
 pianta del piede *f* 15  
 pianta grassa *f* 87  
 piantare 183  
 piantare una tenda 266  
 piante *f* 86, 296  
 piante da giardino *f* 86  
 piante da roccia *f* 87  
 pianura *f* 285  
 piastra *f* 67  
 piastrellare 82  
 piastrella dell'ago *f* 276  
 piatti *m* 64  
 piatti del giorno *m* 152  
 piattino *m* 65  
 piatto *m* 65, 310  
 piatto da gratin *m* 69  
 piatto piano *m* 65  
 piatto principale *m* 153  
 piazza *f* 299  
 piazzole disponibili *f* 266  
 picca *f* 273  
 piccante 124  
 picchio *m* 292  
 piccione *m* 292  
 piccolo 321  
 piccolo galoppo *m* 243  
 piccone *m* 187  
 picnic *m* 263  
 piede *m* 12, 15, 310  
 piede quadro *m* 310  
 piedino *m* 60, 276  
 piega alla francese *f* 39  
 pieno 321  
 pietra *f* 36  
 piffero *m* 257  
 pigiama *m* 33  
 pigiama *m* 30  
 pilates *m* 251  
 pillola *f* 21, 109  
 pilota *m* 190, 211  
 pilota da corsa *m* 249  
 pin *m* 96  
 ping pong *m* 231  
 pinguino *m* 292  
 pinna *f* 239, 292  
 pinna dorsale *f* 294  
 pinna pettorale *f* 294  
 pinnacolo *m* 300  
 pinne di razza *f* 120  
 pino *m* 296  
 pinolo *m* 129  
 pinta *f* 311  
 pinza spelafilo *f* 81  
 pinza tagliafilo *f* 80  
 pinze *f* 150  
 pinze tonde *f* 80  
 pinzette *f* 40, 47, 167

- pioggia *f* 287  
 piolo *m* 266  
 piombata 199  
 pioppo *m* 296  
 piovoso 286  
 piovra *f* 295  
 pipa *f* 112  
 pipetta *f* 167  
 pipistrello *m* 290  
 piramide *f* 164  
 pirofilo 69  
 pirolo *m* 258  
 piscina *f* 101, 238, 250  
 piscina gonfiabile *f* 263  
 piselli *m* 131  
 piselli spaccati *m* 131  
 pisello *m* 122  
 pista *f* 212, 234  
 pista ciclabile *f* 206  
 pista da hockey su ghiaccio *f* 224  
 pista da sci *f* 246  
 pistacchio *m* 129  
 pistola *f* 94  
 pistola per colla *f* 78  
 pita *f* 139  
 pitcher *m* 229  
 pittrice *f* 191  
 pittura *f* 83, 274  
 più 165  
 più tardi 304  
 piuma *f* 293  
 piumino *m* 40  
 pizza *f* 154  
 pizzeria *f* 154  
 pizzo *m* 35  
 placca *f* 50  
 placca da forno *f* 69  
 placcare 220  
 placenta *f* 52  
 platino *m* 289  
 play *m* 269  
 Plutone 280  
 pneumatico *m* 198, 205, 206  
 podalico 52  
 podio *m* 235, 256  
 podio di partenza *m* 238  
 poggiatesta *m* 200  
 poker *m* 273  
 poli *m* 282  
 poliestere *m* 277  
 politica *f* 169  
 polizia *f* 94  
 poliziotto *m* 189  
 pollaio *m* 185  
 pollame *m* 119  
 pollice *m* 15, 310  
 pollo *m* 119  
 pollo fritto *m* 155  
 pollo preparato *m* 119  
 polmone *m* 18  
 polo *m* 243  
 Polo Nord *m* 283  
 Polonia 316  
 polpa *f* 124, 127, 129  
 polpaccio *m* 13, 16  
 polpette *f* 158  
 polpo *m* 121  
 polsino *m* 32, 230  
 polso *m* 13, 15  
 poltrona *f* 63, 254  
 poltrona da dentista *f* 50  
 poltrone *f* 254  
 poltrone di platea *f* 254  
 polvere *f* 109  
 polvere di cacao *f* 148  
 polvere di curry *f* 132  
 pomata *f* 47  
 pomata antiossore *f* 74  
 pomello *m* 59  
 pomeriggio *m* 305  
 pomice *f* 73, 288  
 pomo *m* 242  
 pomo di Adamo *m* 19  
 pomodoro *m* 124  
 pomodoro *m* 125, 149, 157  
 pompa *f* 207  
 pompa da seno *f* 53  
 pompa di benzina *f* 199  
 pompelmo *m* 126  
 ponte *m* 214, 258, 300  
 ponte di comando *m* 214  
 ponte laterale *m* 240  
 pontile *m* 217  
 pop *m* 259  
 popcorn *m* 255  
 poppa *f* 240  
 porcellana *f* 105  
 porcile *m* 185  
 poro *m* 15  
 porridge *m* 157  
 porro *m* 125  
 porta *f* 176, 196, 209, 221, 223, 224, 247  
 porta a soffietto *f* 196  
 porta cipria *m* 40  
 porta della doccia *f* 72  
 porta esterna *f* 59  
 porta uovo *m* 137  
 portabagagli *m* 198, 209  
 portabebè *m* 74  
 portablocco con fermaglio *m* 173  
 portacarte a fisarmonica *m* 173  
 portaerei *f* 215  
 portafoglio *m* 37, 97  
 portaghiaccio *m* 150  
 portamonete *m* 37  
 portaombrelli *m* 59  
 portapacchi *m* 204  
 portapenne *m* 172  
 portasapone *m* 73  
 portasciugamani *m* 72  
 portate *f* 153  
 portatovagliolo *m* 65  
 portauovo *m* 65  
 portellone *m* 198  
 portico *m* 58  
 portiere *m* 222, 224  
 porto *m* 145, 214, 216, 217  
 porto da pesca *m* 217  
 porto per container *m* 216  
 porto per passeggeri *m* 216  
 Portogallo 316  
 portone *m* 58  
 porzione *f* 64  
 posaceneri *m* 150  
 posate *f* 64  
 posizione *f* 232  
 posta aerea 98  
 posta elettronica *f* 98, 177  
 posta in arrivo *f* 177  
 posteggio *m* 266  
 posteggio dei taxi *m* 213  
 posteggio per bici *m* 207  
 poster *m* 255  
 poster scorrevole *m* 174  
 postino *m* 98, 190  
 potare 91  
 pot turistico *m* 217  
 pot-pourri *m* 111  
 pranzo *m* 64  
 pranzo di affari *m* 175  
 prateria *f* 285  
 prato *m* 85, 90, 262  
 prego 322  
 prematuro 52  
 premolare *m* 50  
 prenatale 52  
 prendere 220, 245  
 prendere appunti 163  
 prendere il sole 264  
 prendere in prestito 168  
 prenotare 168  
 prenotare un volo 212  
 preoccupato 25  
 prepuzio *m* 21  
 presa *f* 60, 237  
 presa di corrente *f* 266  
 presa per il piede *f* 241  
 presbiopia *f* 51  
 presentatore *m* 178  
 presentazione *f* 174  
 preservativo *m* 21  
 preside *f* 163  
 presiedere 174  
 pressa per le gambe *f* 251  
 pressa per pettorali *f* 251  
 pressione dei pneumatici *f* 203  
 pressione del sangue *f* 44  
 prestito *m* 96, 168  
 presto 305  
 prezzemolo *m* 133  
 prezzo *m* 152, 199  
 prima 320  
 prima *f* 254  
 primato *m* 234  
 primato personale *m* 234  
 primavera *f* 307  
 primo 309  
 primo piano *m* 104  
 primula *f* 297  
 principato *m* 315  
 privo di sensi 47  
 proboscide *f* 291  
 procedimento *m* 180  
 processione *f* 27  
 processore *m* 176  
 procione *m* 290  
 prodotti per bambini *m* 107  
 prodotti per i denti *m* 108  
 prodotti per il bagno *m* 107  
 prodotti per la pelle *m* 108  
 produttore *m* 254  
 profondità *f* 165  
 profumato 130  
 profumeria *f* 105  
 profumo *m* 41  
 programma *m* 176, 254, 269  
 programmazione *f* 178  
 proiettore *m* 205, 259  
 proiezione *f* 237  
 prolunga *f* 78  
 pronto soccorso *m* 47  
 propagare 91  
 proposta *f* 174  
 prosciutto *m* 119, 143, 156  
 prosciutto crudo *m* 143  
 prostata *f* 21  
 protezione *f* 88  
 prova *f* 181  
 provetta *f* 166  
 provincia *f* 315  
 prua *f* 215, 240  
 prugna *f* 126  
 prugna secca *f* 129  
 psichiatria *f* 49  
 psicoterapia *f* 55  
 pubblicità *f* 269  
 pubblico *m* 254  
 pubblico ministero *m* 180  
 Puerto Rico 314  
 pugilato *m* 236  
 pugno *m* 15, 237  
 pula *f* 130  
 pulcino *m* 185  
 puledro *m* 185  
 pulire 77  
 pulito 121  
 pullman *m* 196  
 pullman turistico *m* 197, 260  
 pulmino *m* 197  
 pulsante di chiamata *m* 48, 197  
 pulsante di scatto *m* 270  
 pulsazioni *f* 47  
 pungiglione *m* 295  
 punta *f* 36, 78, 122, 163, 246  
 punta dell'ago *f* 277  
 punta di sicurezza *f* 80  
 punta per metalli *f* 80  
 punta per muratura *f* 80  
 punta piana per legno *f* 80  
 puntaspilli *m* 276  
 punte *m* 80  
 punte da falegnameria *f* 80  
 punte per cacciavite *f* 80  
 punteggio *m* 220, 273  
 punti *m* 52, 173  
 puntina *f* 173  
 punto *m* 273, 277  
 puntura *f* 46  
 punze ad ago *f* 80  
 pupilla *f* 51  
 putter *m* 233  
 puzzle *m* 273  
**Q**  
 Qatar 318  
 quaderno *m* 163  
 quadrato *m* 164  
 quadricipite *m* 16  
 quadro *m* 62, 261, 273, 274  
 quaglia *f* 119  
 quaranta 308  
 quaranta minuti 304  
 quarantesimo 309  
 quarto 309  
 quarto di gallone *m* 311  
 quarzo *m* 289  
 quattordicesimo 309  
 quattordici 308  
 quattro 308  
 quattrocento 308  
 quercia *f* 296  
 questa settimana 307  
 quindicesima 309  
 quindici 308  
 quindici giorni 307  
 quinoa *f* 130  
 quinte *f* 254  
 quinto 309  
 quota *f* 211  
**R**  
 rabarbaro *m* 127  
 raccattapalle *m* 231  
 racchetta *f* 230, 231  
 raccogliherba *m* 88  
 raccogliere 91, 183, 229  
 raccogliitore a leva *m* 173  
 raccolta *f* 98  
 raccolto *m* 183  
 raccomandata *f* 98  
 racquetball *m* 231  
 radar *m* 214, 281  
 radiatore *m* 202  
 radicchio *m* 123  
 radice *f* 50, 124, 296  
 radice di taro *f* 124  
 radici *f* 39  
 radio *m* 17  
 radio *f* 179, 268  
 radiografia *f* 48  
 radiografia dentale *f* 50

- radiologia *f* 49  
 radiosveglia *f* 70  
 rafano *m* 125  
 raffreddore *m* 44  
 rafting *m* 241  
 ragazza *f* 23, 24  
 ragazzo *m* 23, 24  
 raggi ultravioletti *m* 286  
 raggio *m* 164, 207  
 ragno *m* 295  
 rally *m* 249  
 RAM *f* 176  
 Ramadan *m* 26  
 rame *m* 289  
 raccomandare 277  
 ramo *m* 296  
 ramoscello *m* 296  
 rampa di accesso *f* 194  
 rampa di lancio *f* 281  
 rampa di uscita *f* 194  
 rampicante *m* 87  
 rana *f* 239, 294  
 rana pescatrice *f* 120  
 ranuncolo *m* 297  
 rap *m* 259  
 rapa *f* 124  
 rapa svedese *f* 125  
 rapide *f* 284  
 rapide *m* 240  
 rapporti *m* 24  
 rasatura *f* 73  
 raschiare 77  
 raschietto *m* 82  
 rasoio elettrico *m* 73  
 rasoio usa e getta *m* 73  
 rastrellare 90  
 rastrelliera *f* 166  
 rastrelliera per gli arnesi *f* 78  
 rastrello *m* 88  
 ratto *m* 290  
 ravanello *m* 124  
 razza *f* 120, 294  
 razzo illuminante *m* 240  
 re *m* 272, 273  
 reato *m* 94  
 reattore *m* 281  
 recinto *m* 85, 182, 185, 242  
 recipiente *m* 66  
 redattrice *f* 191  
 redini *f* 242  
 refettorio *m* 168  
 regalo *m* 27  
 reggae *m* 259  
 reggicalze *m* 35  
 reggiseno *m* 35  
 reggiseno da allattamento *m* 53  
 regina *f* 272, 273  
 regione *f* 315  
 regista *m* 254  
 registrazione *f* 269  
 registro *m* 100  
 Regno Unito *m* 316  
 regolatore *m* 239  
 regolatore di esposizione *m* 270  
 regolatore del tempo di esposizione *m* 270  
 reiki *m* 55  
 relatore *m* 174  
 relazione *f* 174  
 remare 241  
 rematore *m* 241  
 remo *m* 241  
 rene *m* 18  
 reni *f* 13  
 reparti *m* 49  
 reparto *m* 48  
 reparto alimentari *m* 105  
 reparto bagagli *m* 104  
 reparto calzini *m* 104  
 reparto calzature *m* 104  
 reparto di cura intensiva *m* 48  
 reparto maternità *m* 48  
 reparto pediatrico *m* 48  
 repellente per insetti *m* 267  
 Repubblica Ceca 316  
 Repubblica Centrafricana 317  
 Repubblica Democratica del Congo 317  
 Repubblica Dominicana 314  
 respiratorio 19  
 respirazione *f* 47  
 rete *f* 176, 217, 222, 226, 227, 231  
 rete da pesca *f* 244  
 rete del letto *f* 71  
 rete ferroviaria *f* 209  
 reticella *f* 167  
 retina *f* 51, 244  
 rettangolo *m* 164  
 rettili *m* 293  
 retto *m* 21  
 rianimazione *f* 47  
 riasfaltatura *f* 187  
 riavvolgimento *m* 269  
 ribes bianco *m* 127  
 ribes nero *m* 127  
 ricamo *m* 277  
 ricci 39  
 riccio *m* 290  
 ricerca *f* 169  
 ricetta *f* 45  
 ricevere 177  
 ricevimento nuziale *m* 26  
 ricevitore *m* 99, 225, 229  
 ricevuta *f* 152  
 ricezione *f* 100  
 ricoperto di cioccolato 140  
 ricoprire di zolle erbose 90  
 ricordi *m* 260  
 ricorso *m* 181  
 ricoverato 48  
 ricupero bagagli *m* 213  
 ridere 25  
 ridurre 172  
 rifiuti *m* 266  
 rifiuti organici *m* 61  
 riflessologia *f* 54  
 righello *m* 163, 165  
 rigore *m* 222  
 rilasciare 245  
 rilassamento *m* 55  
 rimbalzare 227  
 rimedi alle erbe *m* 108  
 rimessa *f* 226  
 rimessa in gioco *f* 223  
 rimestare 67  
 rimorchiare 195  
 rimorchiatore *m* 215  
 rimorchio *m* 266  
 rinascimentale 301  
 ring *m* 237  
 ringhiera *f* 59  
 rinnovare 168  
 rinoceronte *m* 291  
 ripiano *m* 167  
 ripieno *m* 140, 155  
 riproduttivo 19  
 riproduttore acustico *m* 258  
 riproduzione *f* 20  
 riscaldare 154  
 riscaldarsi 251  
 riso *m* 130, 158, 184  
 riso bianco *m* 130  
 riso da budino *m* 130  
 riso integrale *m* 130  
 riso selvatico *m* 130  
 risparmi *m* 96  
 rispondere 99, 163  
 risposta *f* 163  
 ristorante *m* 101, 152  
 risultato *m* 49  
 risolto *m* 32  
 ritardo *m* 209  
 ritmo *m* 259  
 ritorno *m* 231  
 riunione *f* 174  
 riva *f* 284  
 rivista *f* 112, 168  
 riviste *f* 107  
 rocce *f* 284, 288  
 rocchetto del filo *m* 276  
 roccò 301  
 rodeo *m* 243  
 rognone *m* 119  
 rollino *m* 271  
 Romania 316  
 rombo *m* 164  
 rompere le acque 52  
 rondella *f* 80  
 rondine *f* 292  
 rosa 274  
 rosa *f* 89, 110  
 rosé 145  
 rosmarino *m* 133  
 rospo *m* 294  
 rossetto *m* 40  
 rossi 39  
 rosso 145, 274  
 rotaia *f* 208  
 rotatoria *f* 195  
 rotelle *f* 207  
 rotolo *m* 311  
 rotula *f* 17  
 rough *m* 232  
 roulette *f* 266  
 round *m* 237  
 rovescio *m* 231, 286  
 rovina famosa *f* 261  
 Ruanda 317  
 rubinetto *m* 61, 66  
 rubinetto dell'acqua calda *m* 72  
 rubinetto dell'acqua fredda *m* 72  
 rubinetto di arresto *m* 61  
 rubinetto di scarico *m* 61  
 rubino *m* 288  
 ruck *m* 221  
 rucola *f* 123  
 ruga *f* 15  
 rugby *m* 221  
 rullo *m* 83  
 rullo compressore *m* 187  
 rum *m* 145  
 rum con coca cola *m* 151  
 ruota *f* 198, 207, 235, 276  
 ruota anteriore *f* 196, 210  
 ruota dentata *f* 206  
 ruota di scorta *f* 203  
 ruota posteriore *f* 197  
 ruspante 118  
 russare 71  
**S**  
 sabato 306  
 sabbia *f* 85, 264  
 sacca *f* 37  
 sacca da golf *f* 233  
 sacchetto *m* 311  
 sacco *m* 237  
 sacco a pelo *m* 267  
 sacco postale *m* 98  
 Sahara *m* 313  
 Sahara Occidentale 317  
 Saint Kitts-Nevis 314  
 Saint Lucia 314  
 Saint Vincent e Grenadine 314  
 sala da pranzo *f* 64  
 sala da riunione *f* 174  
 sala d'attesa *f* 45  
 sala delle partenze *f* 213  
 sala di lettura *f* 168  
 sala emergenze *f* 48  
 sala macchine *f* 214  
 sala operatoria *f* 48  
 salamandra *f* 294  
 salame *m* 142  
 salame piccante *m* 142  
 salato 121, 129, 137, 143, 155  
 saldare 79  
 saldatore *m* 80  
 sale *m* 64, 152  
 salice *m* 296  
 salmone *m* 120  
 salopette *f* 30  
 salotto *m* 62  
 salpare 217  
 salsa *f* 134, 143, 155  
 salsa di pomodoro *f* 154  
 salsiccia *f* 118, 157  
 salsiccia piccante *f* 142  
 saltare 227  
 saltare con la corda 251  
 saltare in padella 67  
 salto *m* 235, 237, 243, 247  
 salto con l'asta *m* 234  
 salto in alto *m* 235  
 salto in lungo *m* 235  
 salumeria *f* 107, 142  
 salumi *f* 107  
 salute *f* 44  
 salvagente *m* 240  
 salvare 177  
 salvaslip *m* 108  
 salvia *f* 133  
 salvietta antisettica *f* 47  
 salviettina umidificata *f* 75, 108  
 San Marino 316  
 sandali *m* 31  
 sandalo *m* 37  
 sanguinaccio *m* 157  
 São Tomé e Príncipe 317  
 sapone *m* 73  
 saponetta *f* 311  
 Sagedna 316  
 sardina *f* 120  
 sarta *f* 277  
 sartiere *m* 215, 240  
 sarto *m* 191  
 sartoria *f* 115  
 sassofono *m* 257  
 satellite *m* 281  
 satsuma *m* 126  
 Saturno 280  
 sauna *f* 250  
 savoiardi *m* 141  
 sazio 64  
 sbadigliare 25  
 sbarcare 217  
 sbarra *f* 235, 250  
 sbarramento *m* 75  
 sbarre *f* 74  
 sbarre asimmetriche *f* 235  
 sbarre parallele *f* 235  
 sbattere 67  
 sbucciare 67  
 sbucciatura *f* 46  
 scacchi *m* 272  
 scacchiera *f* 272  
 scaffale *m* 106, 168  
 scafo *m* 214, 240  
 scaglia *f* 294  
 scaglie *f* 132, 293  
 scala *f* 95, 186, 256  
 scala a pioli *f* 82  
 scala di sicurezza *f* 95  
 scala mobile *f* 104  
 scaldacqua *m* 61  
 scale *f* 59

- scalogno *m* 125  
 scalpello *m* 81, 275  
 scandalizzato 25  
 scandire 162  
 scanner *m* 176  
 scapola *f* 17  
 scarafaggio *m* 295  
 scarcerazione sulla parola *f* 180  
 scaricare 177  
 scarpa con i lacci *f* 37  
 scarpa con tacco alto *f* 37  
 scarpa da ginnastica *f* 37  
 scarpa da golf *f* 233  
 scarpa da trekking *f* 37  
 scarpa da uomo *f* 37  
 scarpa di cuoio *f* 37  
 scarpe *f* 34, 37  
 scarpe da escursionismo *f* 267  
 scarpe da ginnastica *f* 31  
 scarpe da tennis *f* 231  
 scarpe di cuoio *f* 32  
 scarpette *f* 30  
 scarpino *m* 220, 223  
 scarponcini *m* 251  
 scarpone da sci *m* 246  
 scartavetrare 82  
 scatola d'archivio *f* 173  
 scatola degli attrezzi *f* 80, 244  
 scatola dei fusibili *f* 203  
 scatola del cambio *f* 202, 204  
 scatola di cioccolatini *f* 113  
 scatola di fazzolettini *f* 70  
 scatolame *m* 107  
 scatoletta *f* 311  
 scavare 90  
 scendibagno *m* 72  
 scenografia *f* 254  
 scheda del paziente *f* 48  
 schedario *m* 172  
 scheggia *f* 46  
 scheletro *m* 17  
 scherma *f* 249  
 schermo *m* 97, 176, 255, 267  
 schiacciapate *m* 68  
 schiacciata *f* 139, 231  
 schiacciato 159  
 schiena *f* 13  
 schienale *m* 64, 210  
 schiuma *f* 148  
 schiuma da barba *f* 73  
 schizzo *m* 275  
 sci *m* 241, 246  
 sci alpino *m* 247  
 sci d'acqua *m* 241  
 sci di fondo *m* 247  
 sciabola *f* 236  
 sciacquare 38, 76  
 sciarpa *f* 31  
 sciatore d'acqua *m* 241  
 sciatrice *m* 246  
 scienza *f* 162, 166  
 scienziato *m* 190  
 scimmia *f* 291  
 scioppo *m* 109  
 scioppo d'acero *m* 134  
 scisto *m* 288  
 scivolare 229  
 scivolata *f* 237  
 scivolo *m* 263  
 scodella *f* 65  
 scogliera *f* 285  
 scoiattolo *m* 290  
 scolapasta *m* 68  
 scolaria *f* 162  
 scolaro *m* 162  
 scollatura *f* 34  
 scolo *m* 61, 72, 91  
 scommessa *f* 273  
 scompartimento *m* 209  
 scompartimento a cuccette *m* 209  
 scongelare 67  
 scopa *f* 77  
 scopa di spugna *f* 77  
 scoperto 260  
 scoperto *m* 96  
 scorpione *m* 295  
 scorza *f* 142  
 scorza interna *f* 126  
 scossa elettrica *f* 46  
 scotta *f* 241  
 scottatura *f* 46  
 scrabble *m* 272  
 scrivania *f* 172  
 scrivere 162  
 scroto *m* 21  
 scucire 277  
 scultore *m* 191  
 scultura *f* 275  
 scuola *f* 162, 299  
 scuola d'arte *f* 169  
 scuolabus *m* 196  
 scuole *f* 169  
 scuro 41, 321  
 seccato 159  
 secchi 39  
 secchiello *m* 265  
 secchio *m* 77, 82  
 secchio di riciclaggio *m* 61  
 secco 41, 130, 145, 286  
 secolo *m* 307  
 seconda galleria *f* 254  
 secondo *m* 304  
 secondo 309  
 secondo piano *m* 104  
 sedano *m* 122  
 sedano rapa *m* 124  
 sedativo *m* 109  
 sede *f* 175  
 sede del circolo *f* 232  
 sedia *f* 64  
 sedia a rotelle *f* 48  
 sedia a sdraio *f* 265  
 sedia girevole *f* 172  
 sedicesimo 309  
 sedici 308  
 sedile *m* 61, 64, 204, 209, 210, 242  
 sedile del water *m* 72  
 sedile dell'autista *m* 196  
 sedile posteriore *m* 200  
 sedimentario 288  
 sega *f* 89  
 sega circolare *f* 78  
 sega da traforo *f* 78, 81  
 sega manuale *f* 80  
 sega per tenoni *f* 81  
 segare 79  
 seggiolino per bambini *m* 207  
 seggiolino per bambino *m* 198  
 seggiolone *m* 75  
 seggiovia *f* 246  
 seghetto per metalli *m* 81  
 segnale *m* 209  
 segnale stradale *m* 298  
 segnaletica orizzontale *f* 194  
 segnare 223, 227  
 segreteria telefonica *f* 99  
 sei 308  
 seicento 308  
 selce *f* 288  
 selezionatore dei punti *m* 276  
 sella *f* 242  
 sella da signora *f* 242  
 sellino *m* 206  
 sellino posteriore *m* 204  
 semaforo *m* 194, 298  
 seme *m* 122, 127, 128, 130  
 seme di girasole *m* 131  
 seme di sesamo *m* 131  
 seme di zucca *m* 131  
 semenzaio *m* 89  
 semenzale *m* 91  
 semi *m* 88, 131  
 semi di carvi *m* 131  
 semi di finocchio *m* 133  
 semi di mostarda *m* 131  
 semi di papavero *m* 138  
 semi di soia *m* 131  
 seminare 90, 183  
 seminterato *m* 58  
 semola *f* 130  
 sempreverde 86  
 senape *f* 135, 155  
 Senegal 317  
 seno *m* 12, 19  
 sensibile 41  
 senso unico *m* 194, 298  
 sentenza *f* 181  
 sentiero *m* 85, 262  
 sentiero per cavalli *m* 263  
 senza 320  
 senza grassi 137  
 senza maniche 34  
 senza piombo 199  
 senza sale 137  
 senza semi 127  
 senza spilline 34  
 seppia *f* 121  
 sera *f* 305  
 serbatoio *m* 61, 204  
 serbatoio del liquido lavavetri *m* 202  
 serbatoio del liquido per i freni *m* 202  
 serbatoio della benzina *m* 203  
 serbatoio dell'acqua *m* 61  
 serbatoio dell'olio *m* 204  
 serbatoio per il liquido refrigerante *m* 202  
 serie *f* 179  
 serie televisiva *f* 178  
 serpente *m* 293  
 serratura *f* 59  
 server *m* 176  
 servire 64, 229  
 servizi di emergenza *m* 94  
 servizio *m* 231, 231  
 servizio compreso 152  
 servizio di lavanderia *m* 101  
 servizio di pulizia *m* 101  
 servizio in camera *m* 101  
 servizio non compreso 152  
 sessanta 308  
 sessantesimo 309  
 sesto 309  
 set *m* 178, 179, 230  
 seta *f* 277  
 setacciare 91, 138  
 setaccio *m* 89  
 settanta 308  
 settantesimo 309  
 sette 308  
 settecento 308  
 settembre 306  
 settimana *f* 306  
 settimana prossima *f* 306  
 settimana scorsa *f* 307  
 settimanale 307  
 settimo 309  
 sfera *f* 164  
 sfciatoio *m* 290  
 sfocato 271  
 sfogo *m* 44  
 sfondo *m* 177  
 sformato *m* 142  
 sfumatura alta *f* 39  
 sgabello *m* 150  
 sgombro *m* 120  
 sgusciato 129  
 shaker *m* 150  
 shampoo *m* 38  
 sherry *m* 145  
 shiatsu *m* 54  
 shock *m* 47  
 shuttle *m* 281  
 si 322  
 Siberia *f* 313  
 Sicilia 316  
 sicura *f* 200  
 sicurezza *f* 75, 212, 240  
 sicuro 228  
 sidro *m* 145  
 siepe *f* 85, 90, 182  
 siero di latte *m* 137  
 Sierra Leone 317  
 sigarette *f* 112  
 sigaro *m* 112  
 sigillante *m* 83  
 Signora *f* 23  
 Signore *m* 23  
 Signorina *f* 23  
 silenziatore *m* 203, 204  
 silos *m* 183  
 sinagoga *f* 300  
 sinfonia *f* 256  
 Singapore 319  
 singolo *m* 230  
 singolo 151  
 sinistra 260  
 sintetico 31  
 sintonizzare 179  
 sintonizzare la radio 269  
 sipario *m* 254  
 sirena *f* 94  
 Siria 318  
 siringa *f* 109, 167  
 sistema *m* 176  
 sistema di altoparlanti *m* 209  
 sistema solare *m* 280  
 sistemi corporali *m* 19  
 sistemi interni *m* 60  
 sito web *m* 177  
 skateboard *m* 249, 263  
 slalom *m* 247  
 slalom gigante *f* 247  
 slip *m* 33, 35  
 slittino *m* 247  
 slogatura *f* 46  
 Slovacchia 316  
 Slovenia 316  
 smaltimento dei rifiuti *m* 61  
 smalto *m* 50  
 smalto per le labbra *m* 40  
 smalto per unghie *m* 41  
 smeraldo *m* 288  
 smorzata *f* 230  
 snack bar *m* 148  
 snooker *m* 249  
 snowboard *m* 247  
 società *f* 175  
 soda *f* 144  
 sodo 124  
 soffiare 141  
 soffione della doccia *m* 72  
 soffitto *m* 62  
 soffocare 47  
 software *m* 176  
 sogliola *f* 120  
 sogliola limanda *f* 120  
 solco *m* 183  
 soldato *m* 189

- sole *m* 280  
 soleggiato 286  
 solidi *m* 164  
 sollevare 251  
 solubile 109  
 soluzione disinfettante *f* 51  
 soluzione per la pulizia *f* 51  
 solvente *m* 83  
 Somalia 317  
 sommare 165  
 sonaglio *m* 74  
 sonata *f* 256  
 sonda *f* 50  
 sonnifero *m* 109  
 sopra 320  
 sopracciglio *m* 14, 51  
 sorbetto *m* 141  
 sorella *f* 22  
 sorgere del sole *m* 305  
 sorpassare 195  
 sorpreso 25  
 sorriso *m* 25  
 sospensione *f* 203  
 sospetto *m* 94  
 sospirare 25  
 sosta vietata 195  
 sostegno *m* 88  
 sostegno del morsetto *m* 166  
 sostituto *m* 223  
 sostituzione *f* 223  
 sottaceto 159  
 sottile 321  
 sotto 320  
 sottobicchiere *m* 150  
 sottospeso 271  
 sott'olio 143  
 sottomarino *m* 215  
 sottopassaggio *m* 194  
 sottosuolo *m* 91  
 sottoveste *f* 35  
 sottrarre 165  
 soufflé *m* 158  
 sovraesposto 271  
 spaccato *m* 282  
 Spagna 316  
 spalla *f* 13  
 spallina *f* 35  
 spartito *m* 256  
 spatola *f* 68, 167  
 spaventapasseri *m* 184  
 spaventato 25  
 spazio *m* 280  
 spazzare 77  
 spazzola *f* 38, 77, 82  
 spazzola da water *m* 72  
 spazzola per la schiena *f* 73  
 spazzolare 38  
 spazzolina per le sopracciglia *f* 40  
 spazzolino *m* 50  
 spazzolino da denti *m* 72  
 specchietto laterale *m* 198  
 specchietto retrovisore *m* 198  
 specchio *m* 40, 63, 71, 167  
 specialista *m* 49  
 spedire 177  
 spegnere la televisione 269  
 spellato 121  
 sperma *m* 20  
 spesa *f* 106  
 spesso 321  
 spettatori *m* 233  
 spezie *f* 132  
 spia del carburante *f* 201  
 spia della temperatura *f* 201  
 spiaggia *f* 264  
 spianare 67  
 spicchio *m* 125, 126  
 spiedino *m* 68, 155, 158  
 spigola *f* 120  
 spilla *f* 36  
 spilla da balia *f* 47  
 spillatore di birra *m* 150  
 spillo *m* 276  
 spina *f* 60, 121  
 spina dorsale *f* 17  
 spinaci *m* 123  
 spinato 121  
 spioncino *m* 59  
 spira *f* 300  
 spoletta *f* 277  
 spolverare 77  
 spolverino *m* 77  
 sport *m* 220  
 sport acquatici *m* 241  
 sport da combattimento *m* 236  
 sport e il tempo libero *m* 236  
 sport invernali *m* 247  
 sportello *m* 96, 98, 198  
 sportello dell'equipaggio *m* 281  
 sposarsi 26  
 spray *m* 109  
 spremiaglio *m* 68  
 spremuta d'arancia *f* 144  
 spremute e i frappé *f/m* 149  
 spruzzare 91  
 spugna *f* 73, 74, 83  
 spuntare 39, 90  
 sputacchiera *f* 50  
 squadra *f* 165, 220, 229  
 squalo *m* 294  
 squama *f* 121  
 squash *m* 231  
 squat *m* 251  
 sradicare le erbacce 91  
 Sri Lanka 318  
 stabilizzatore *m* 210  
 staccare 82  
 staccato 99  
 stadio *m* 223  
 staffa *f* 242  
 staffetta *f* 235  
 stagionale 129  
 stagioni *f* 306  
 stagno *m* 85, 232, 289  
 stalla *f* 185, 243  
 stame *m* 297  
 stampa *f* 178, 275  
 stampante *f* 172, 176  
 stampare 172  
 stampino *m* 83  
 stampo *m* 69  
 stampo per dolci *m* 69  
 stampo per flan *m* 69  
 stampo per soufflé *m* 69  
 stampo per torte *m* 69  
 stanza *f* 58  
 stanza da bagno *f* 72  
 stanza di cambio pannolini *f* 104  
 starnuto *m* 44  
 Stati Uniti d'America 314  
 stato *m* 315  
 statua *f* 260  
 stazione di polizia *f* 94  
 stazione di servizio *f* 199  
 stazione ferroviaria *f* 208  
 stazione spaziale *f* 281  
 stecca *f* 47  
 stella *f* 280  
 stella di mare *f* 295  
 stelo *m* 111, 122, 297  
 stendere 251  
 stenografo *m* 181  
 stereo 269  
 sterile 20, 47  
 sterno *m* 17  
 stetoscopio *m* 45  
 stile libero *m* 239  
 stili *m* 239, 301  
 stili musicali *m* 259  
 stilista *m* 277  
 stinco *m* 12  
 stipendio *m* 175  
 stiramento *m* 251  
 stirare 76  
 stiva *f* 215  
 stivale da equitazione *m* 242  
 stivaloni di gomma *m* 244  
 stoffa *f* 276  
 stomaco *m* 18  
 stop *m* 269  
 storia *f* 162  
 storia dell'arte *f* 169  
 stoviglie e posate *f* 65  
 strada *f* 298  
 strada di accesso *f* 216  
 strade *f* 194  
 strascico *m* 35  
 strato di ozono *m* 286  
 strato superficiale *m* 85  
 stratosfera *f* 286  
 stress *m* 55  
 stretching *m* 251  
 stretto 321  
 strike *m* 228  
 strumenti *m* 256, 258  
 strumenti a fiato *m* 257  
 struttura *f* 267  
 struttura per arrampicarsi *f* 263  
 struzzo *m* 292  
 stucco *m* 83  
 studente universitario *m* 169  
 studio *m* 63, 162  
 studio dell'avvocato *m* 180  
 studio di registrazione *m* 179  
 studio televisivo *m* 178  
 stufa *f* 60  
 stufa a convezione *f* 60  
 stufato *m* 158  
 sturalavandini *m* 81  
 stuzzichini *m* 151  
 su 320  
 succo *m* 127  
 succo d'ananas *m* 149  
 succo d'arancia *m* 148  
 succo di frutta *m* 156  
 succo di mela *m* 149  
 succo di pomodoro *m* 144  
 succo d'uva *m* 144  
 succursale *f* 175  
 sud *m* 312  
 Sud Africa 317  
 Sudan 317  
 sugoso 127  
 sumo *m* 237  
 suocera *f* 23  
 suocero *m* 23  
 suola *f* 37  
 superficie *f* 165, 310  
 supermercato *m* 106  
 supplemento *m* 55  
 supporto *m* 187, 268  
 supporto per l'altoparlante *m* 268  
 supposta *f* 109  
 surf *m* 241  
 surfing *m* 241  
 surfista *m* 241  
 surgelati *m* 107  
 Suriname 315  
 sveglia *f* 70  
 svegliarsi 71  
 svenire 25, 44  
 Svezia 316  
 sviluppare 271  
 svincolo *m* 194  
 Svizzera *f* 316  
 svolta a destra vietata 195  
 Swaziland 317  
 swing di pratica *m* 233
- T**  
 tabacco *m* 112, 184  
 tabellone *m* 173, 226  
 tabellone dei risultati *m* 225  
 tacchino *m* 119, 185, 293  
 tacco *m* 37  
 tae kwondo *m* 236  
 Tagikistan 318  
 tagli *m* 119  
 tagliabordi *m* 88  
 tagliare 38, 79, 277  
 tagliatubi *m* 81  
 tagliaunghie *m* 41  
 tagliere *m* 68  
 tagliolini *m* 158  
 taglio *m* 46, 230  
 taglio cesareo *m* 52  
 tai-chi *m* 236  
 Tailandia 318  
 Taiwan 319  
 talco *m* 73  
 talea *f* 91  
 tallone *m* 13, 15  
 tamburino *m* 257  
 tamburo militare *m* 257  
 tampone di inchiostro *m* 173  
 tamponi *m* 108  
 tandem *m* 206  
 Tanzania *f* 317  
 tappetino *m* 54  
 tappeto *m* 63, 71  
 tappezzare 82  
 tappo *m* 72, 134, 166  
 tardi 305  
 targa *f* 198  
 targhetta d'identità *f* 53  
 tariffa *f* 197, 209  
 tariffa d'ingresso *f* 260  
 tartaruga *f* 293  
 tartufo *m* 113, 125  
 tasca *f* 32  
 tasca da pasticciere *f* 69  
 Tasmania 319  
 tassista *m* 190  
 tasso di cambio *m* 97  
 tasso d'interesse *m* 96  
 tastiera *f* 97, 99, 172, 176, 258  
 tasto *m* 176, 258  
 tatuaggio *m* 41  
 tavola *f* 241  
 tavola da skateboard *f* 249  
 tavoletta *f* 238  
 tavoletta di cioccolata *f* 113  
 tavoletta spuntino *f* 113  
 tavolino *m* 62  
 tavolo *m* 64, 148  
 tavolo da lavoro *m* 82  
 tavolo da picnic *m* 266  
 tavolo della colazione *m* 156  
 tavolozza *f* 274  
 tazza *f* 61, 65  
 tazza da té *f* 65  
 tazza per bere *f* 75  
 tazzina da caffè *f* 65  
 tè *m* 144, 149, 184  
 tè al limone *m* 149  
 tè alla menta *m* 149  
 tè alle erbe *m* 149  
 tè con latte *m* 149

- tè freddo *m* 149  
 tè nero *m* 149  
 tè sciolto *m* 144  
 tè verde *m* 149  
 teatro *m* 254, 299  
 tecniche *f* 79  
 tecnico del suono *m* 179  
 tee *m* 233  
 teeing-ground *m* 232  
 teglia *f* 69  
 teglia per pasticcini *f* 69  
 tegola *f* 58, 187  
 teiera *f* 65  
 tela *f* 274  
 telaio *m* 203, 206, 277  
 telecamera *m* 178  
 telecomando *m* 269  
 telefonino *m* 99  
 telefono *m* 99, 172  
 telefono a monete *m* 99  
 telefono a scheda *m* 99  
 telefono per emergenze *m* 195  
 telefono senza fili *m* 99  
 telegiornale *m* 178  
 telegramma *m* 98  
 telenovela *f* 178  
 telescopio *m* 281  
 televisione via cavo *f* 269  
 televisore *m* 268  
 televisore a schermo largo *m* 269  
 telo di protezione *m* 83  
 telo isolante *m* 267  
 telo protettivo *m* 266  
 tema *m* 163  
 tempera *f* 274  
 temperamatite *m* 163  
 temperatura *f* 286  
 tempesta *f* 287  
 tempia *f* 14  
 tempio *m* 300  
 tempo *m* 234, 286  
 tempo libero *m* 254, 258, 264  
 tempo supplementare *m* 223  
 tenaglie *f* 167  
 tenda *f* 63, 148, 267  
 tenda da doccia *f* 72  
 tendina *f* 63  
 tendine *m* 16, 17  
 tendine di achille *m* 16  
 tenersi a galla 239  
 tennis *m* 230  
 tensione *f* 60  
 tenuta da calcio *f* 31  
 tequila *f* 145  
 terapia di gruppo *f* 55  
 terapie alternative *f* 54  
 terapista *f* 55  
 tercristallo *m* 198  
 terminale *m* 212  
 terminale di carenaggio *m* 216  
 termite *f* 295  
 termocoperta *f* 71  
 termometro *m* 45, 167
- termosfera *f* 286  
 termostato *m* 61  
 terra *f* 282  
 Terra *f* 280  
 terraferma *f* 282  
 terremoto *m* 283  
 terreno *m* 85  
 terreno agricolo *m* 182  
 terriccio *m* 88  
 terrina *f* 69  
 territorio *m* 315  
 terzo 309  
 tesi *f* 169  
 tesserino *m* 168  
 tessitura *f* 277  
 tessuto *m* 277  
 test di gravidanza *m* 52  
 testa *f* 12, 19, 81, 230  
 testa del cilindro *f* 202  
 testata *f* 70  
 testicolo *m* 21  
 testimone *m* 180, 235  
 testo *m* 259  
 testuggine *f* 293  
 tettarella *f* 75  
 tetto *m* 58, 203  
 tettuccio *m* 202  
 thermos *m* 267  
 thriller *m* 255  
 tibia *f* 17  
 tiebreak *m* 230  
 tiepido 286  
 tiglio *m* 296  
 tigre *f* 291  
 timbro a umido *m* 173  
 timbro postale *m* 98  
 timido 25  
 timo *m* 133  
 timone *m* 210, 241  
 Timor Est 319  
 timpano *m* 257  
 tinti 39  
 tintura per capelli *f* 40  
 tipi *m* 199, 205  
 tipi di autobus *m* 196  
 tipi di fattoria *m* 183  
 tipi di giardino *m* 84  
 tipi di macchina fotografica *m* 270  
 tipi di pesca *m* 245  
 tipi di piante 86  
 tipi di treno *m* 208  
 tirare 221, 223, 227  
 tirare con il mulinello 245  
 tiro al bersaglio *m* 249  
 tiro alto *m* 230  
 tiro con l'arco *m* 249  
 tiro insospensione *m* 226  
 tiroide *f* 18  
 titoli *m* 97  
 titolo *m* 168  
 toaletta *f* 71  
 toga *f* 169  
 togliere i fiori appassiti 91  
 Togo *m* 317  
 toilettes *f* 104
- tombino *m* 299  
 tonalità 41  
 tonnellata *f* 310  
 tonno *m* 120  
 tono *m* 256  
 topazio *m* 288  
 topinambur *m* 125  
 topo *m* 290  
 toppa *f* 207  
 torace *m* 12  
 torcia *f* 267  
 tormalina *f* 288  
 tornado *m* 287  
 torneo *m* 233  
 tornio da vasaio *m* 275  
 tornire 79  
 toro *m* 185  
 torre *f* 272, 300  
 torre di controllo *f* 212  
 torre di sorveglianza *f* 265  
 torrente *m* 285  
 torretta *f* 300  
 torretta di comando *f* 215  
 torrone *m* 113  
 torsolo *m* 127  
 torta al cioccolato *f* 140  
 torta alla crema *f* 141  
 torta di compleanno *f* 141  
 torta nuziale *f* 141  
 torte per celebrazioni *f* 141  
 tosaerba *m* 88, 90  
 tosare l'erba 90  
 tosse *f* 44  
 tostapane *m* 66  
 touch-down *m* 220  
 tovaglia *f* 64  
 tovaglia individuale *f* 64  
 tovagliolo *m* 65, 152  
 tovagliolo di carta *m* 154  
 tra 320  
 trachea *f* 18  
 traffico *m* 194  
 traghetto *m* 215, 216  
 traguardo *m* 234  
 tram *m* 196, 208  
 tramezzino *m* 155  
 tramezzino a strati *m* 155  
 tramezzino aperto *m* 155  
 tramezzino tostato *m* 149  
 tramonto *m* 305  
 trampolino *m* 238  
 trancia *f* 121  
 transenna di sicurezza *f* 246  
 trapanare 79  
 trapano *m* 50  
 trapano elettrico *m* 78  
 trapano manuale *m* 81  
 trapano ricaricabile *m* 78  
 trapezio *m* 16, 164  
 trapiantare 91  
 trapunta *f* 71
- trapunto *m* 277  
 trasferta *f* 223  
 trasformatore *m* 60  
 trasmettere 178, 179  
 trasmissione *f* 202  
 trasmittente *f* 75  
 trasporti *m* 194  
 trattamenti di bellezza *m* 41  
 trattamento per il viso *m* 41  
 trattato 118, 143  
 trattore *m* 182  
 travaglio indotto *m* 53  
 trave *f* 186, 235  
 travel cheque *m* 97  
 traversa *f* 222  
 tre 308  
 treadmill *m* 250  
 treccia *f* 39  
 trecento 308  
 tredicesimo 309  
 tredici 308  
 trentina *f* 83  
 tremore *m* 283  
 treno *m* 208  
 treno a vapore *m* 208  
 treno ad alta velocità *m* 208  
 treno diesel *m* 208  
 treno elettrico *m* 208  
 treno interciti *m* 209  
 treno merci *m* 208  
 trenta 308  
 trentesimo 309  
 treppiede *m* 166, 270, 281  
 triangolo *m* 164, 257  
 tric trac (la tavola reale) *m* 272  
 tricheco *m* 290  
 tricpite *m* 16  
 trifoglio *m* 297  
 triglia *f* 120  
 trimestre *m* 52  
 Trinidad e Tobago 314  
 triste 25  
 tritanto 132  
 tromba *f* 257  
 trombone *m* 257  
 tronco *m* 296  
 tropici *m* 283  
 tropico del cancro *m* 283  
 tropico del capricorno *m* 283  
 troposfera *f* 286  
 trota *f* 120  
 trotto *m* 243  
 trovare un lavoro 26  
 trucco *m* 40  
 truciolo *m* 79  
 trucioli *m* 78  
 tuba *f* 257  
 tubetto *m* 311  
 tubo *m* 89, 202  
 tubo dell'acqua *m* 61  
 tubo di aspirazione *m* 77
- tubo di Fallopio *m* 20  
 tubo di scappamento *m* 203, 204  
 tubo di scolo *m* 61  
 tubo di troppopieno *m* 61  
 tubo reggisella *m* 206  
 tuffarsi 238, 239  
 tuffatore *m* 238  
 tuffo alto *m* 239  
 tuffo di rincorsa *m* 239  
 tulipano *m* 111  
 Tunisia *f* 317  
 tuono *m* 286  
 tuorlo *m* 137, 157  
 turbato 25  
 turbocompressore *m* 203  
 turchese *m* 289  
 Turchia *f* 316  
 turismo *m* 260  
 turista *m* 260  
 Turkmenistan 318  
 turno di battuta *m* 228  
 tuta *f* 31, 82  
 tuta da sport *f* 32  
 tuta da sci *f* 246  
 tuta di pelle *f* 205  
 tuta spaziale *f* 281  
 tuta subacquea *f* 239  
 tutina *f* 30  
 tutina da neve *f* 30  
 tutina senza maniche *f* 30  
 tutù *m* 191
- U**  
 uccelli *m* 292  
 Ucraina *f* 316  
 ufficio *m* 24, 172, 174  
 ufficio contabilità *m* 175  
 ufficio del direttore *m* 266  
 ufficio del personale *m* 175  
 ufficio della dogana *m* 216  
 ufficio di assistenza al cliente *m* 175  
 ufficio di cambio *m* 97  
 ufficio iscrizioni *m* 168  
 ufficio legale *m* 175  
 ufficio marketing *m* 175  
 ufficio postale *m* 98  
 ufficio vendite *m* 175  
 Uganda *m* 317  
 uguale 165  
 ulna *f* 17  
 ultrasuono *m* 52  
 un quarto d'ora 304  
 una mezzora 304  
 uncinetto *m* 277  
 uncino *m* 244  
 underpar *m* 233  
 undicesimo 309  
 undici 308  
 Ungheria 316  
 unghia *f* 15

- unghia del piede *f* 15  
 unguento *m* 109  
 unifamiliare 58  
 uniforme *f* 94  
 unità di smistamento *f* 61  
 università *f* 168, 299  
 universo *m* 280  
 uno 308  
 uomo *m* 12, 23  
 uomo di affari *m* 175  
 uova *f* 137  
 uova strappazzate *f* 157  
 uovo alla coque *m* 137, 157  
 uovo di anatra *m* 137  
 uovo di gallina *m* 137  
 uovo di quaglia *m* 137  
 uovo d'oca *m* 137  
 uovo fritto *m* 157  
 uragano *m* 287  
 Uranio 280  
 uretere *m* 21  
 uretra *f* 20  
 urinario 19  
 urologia *f* 49  
 Uruguay 315  
 uscita *f* 61, 210  
 uscita di emergenza *f* 210  
 ustione *f* 46  
 utensili *m* 66  
 utensili da cucina *m* 68  
 utero *m* 20, 52  
 uva passa *f* 129  
 uva spina *f* 127  
 uva sultanina *f* 129  
 uvetta *f* 129  
 Uzbekistan 318
- V**
- vacanza *f* 212  
 vagina *f* 20  
 vaglia postale *m* 98  
 vagone *m* 208  
 vagone ristorante *m* 209  
 valanga *f* 247  
 valigetta *f* 37  
 valle *f* 284  
 valuta estera *f* 97  
 valvola *f* 207  
 valvola della pressione *f* 61
- valvoliera *f* 60  
 vanga *f* 88  
 vaniglia *f* 132  
 vano della pellicola *m* 270  
 vantaggio *m* 230  
 Vanuatu 319  
 varechina *f* 77  
 varicella *f* 44  
 vasca *f* 72  
 vaschetta *f* 74, 311  
 vaschetta per la vernice *f* 83  
 vasino *m* 74  
 vaso *m* 63, 111  
 vaso da fiori *m* 89  
 vassoio *m* 152, 154, 210  
 vassoio della colazione *m* 101  
 vassoio in arrivo *f* 172  
 vassoio in partenza *m* 172  
 vecchio 321  
 veicolo di servizio *m* 212  
 vela *f* 240, 241  
 vela di maestra *f* 240  
 vela di prua *f* 240  
 velo *m* 35  
 veloce 321  
 velocista *m* 234  
 vena *f* 19  
 venditore ambulante *m* 154  
 venerdì 306  
 Venere 280  
 veneziana *f* 63  
 Venezuela 315  
 ventesimo 309  
 venti 308  
 venti minuti 304  
 ventidue 308  
 ventiduesimo 309  
 ventilatore *m* 60  
 ventimila 309  
 ventitreesimo 309  
 vento *m* 241, 286  
 ventola *f* 202  
 ventola per l'aria *f* 210  
 ventosa *f* 53  
 ventoso 286  
 ventunesimo 309
- ventuno 308  
 verbale *m* 174  
 verde 274  
 verdetto *m* 181  
 verdura *f* 122  
 verdure *f* 107, 124  
 verme *m* 295  
 vernice di base *f* 83  
 vernice trasparente *f* 83  
 verniciare 83  
 versare 67, 96  
 verso 320  
 vertebra cervicale *f* 17  
 vertebra lombare *f* 17  
 vertebra toracica *f* 17  
 verticale 271  
 verza *f* 123  
 vescica *f* 20, 46  
 vescicola seminale *f* 21  
 vespa *f* 205, 295  
 vestaglia *f* 31, 32  
 vestiti puliti *m* 76  
 vestito *m* 31, 34  
 veterinaria *f* 189  
 via laterale *f* 299  
 viaggio di affari *m* 175  
 viaggio di nozze *m* 26  
 viale *m* 299  
 vibrafono *m* 257  
 vicino 320  
 vicino *m* 24  
 vicolo *m* 298  
 videocamera *f* 260, 269  
 videocassetta *f* 269  
 videogioco *m* 269  
 videoregistratore *m* 269  
 videotelefono *m* 99  
 Vietnam 318  
 vigile del fuoco *m* 189  
 vigile urbano *m* 195  
 vigili del fuoco *m* 95  
 vigilia di Ognissanti *f* 27  
 vigna *f* 183  
 vigneto *m* 183  
 villaggio *m* 299  
 villino *m* 58  
 vincere 273  
 vincitore *m* 273  
 vino 145, 151  
 viola 274  
 viola *f* 256
- violacciocca *f* 110  
 violino *m* 256  
 violoncello *m* 256  
 viottolo *m* 58  
 virus *m* 44  
 visiera *f* 205  
 visita *f* 45  
 visita guidata *f* 260  
 visita medica *f* 45  
 vista *f* 51  
 visto *m* 213  
 vita *f* 12  
 vitamine *f* 108  
 vite *f* 80  
 vitello *m* 118, 185  
 vivaio *m* 84, 115  
 vivaio ittico *m* 183  
 vodka *f* 145  
 vodka all'arancia *f* 151  
 vogatore *m* 250  
 volano *m* 231  
 volant *m* 71  
 volante *m* 201  
 volare 211  
 volo in deltaplano *m* 248  
 volo internazionale *m* 212  
 volo nazionale *m* 212  
 volo senza motore *m* 248  
 volpe *f* 290  
 volta *f* 300  
 volume *m* 165, 179, 269, 311  
 vomitare 44  
 vongola *f* 121  
 vulcano *m* 283  
 vuoto 321
- W**
- waffle *m* 157  
 water *m* 61, 72  
 western *m* 255  
 whisky *m* 145  
 whisky con acqua *m* 151  
 wicket *m* 225  
 windsurf *m* 241  
 wok *m* 69  
 wurstel *m* 155
- Y**
- yacht *m* 215, 240  
 Yemen 318  
 yoga *m* 54  
 yogurt *m* 137  
 yogurt alla frutta *m* 157  
 yogurt gelato *m* 137
- Z**
- zafferano *m* 132  
 zaffiro *m* 288  
 zainetto *m* 37  
 zaino *m* 31, 267  
 Zambia *m* 317  
 zampa *f* 119  
 zanna *f* 291  
 zanzara *f* 295  
 zanzariera *f* 267  
 zappa *f* 88  
 zattera di salvataggio *f* 240  
 zatterone *m* 37  
 zebra *f* 291  
 zenzero *m* 125, 133  
 zerbino *m* 59  
 zero 308  
 zia *f* 22  
 Zimbabwe *m* 317  
 zincato 79  
 zinco *m* 289  
 zio *m* 22  
 zoccolo *m* 242, 291  
 zolfo *m* 289  
 zolla *f* 283  
 zona *f* 315  
 zona fumatori *f* 152  
 zona industriale *f* 299  
 zona non fumatori *f* 152  
 zona pedonale *f* 299  
 zone *f* 283, 299  
 zoo *m* 262  
 zoologia 169  
 zoom *m* 270  
 zoosafari *m* 262  
 zucca *f* 124, 125  
 zucca a ghianda *f* 125  
 zucca butternut *f* 125  
 zuccina *f* 125  
 zuppa *f* 158  
 zuppa inglese *f* 14

# indice inglese • English index

## A

à la carte 152  
 abdomen 12  
 abdominals 16  
 above 320  
 acacia 110  
 accelerator 200  
 accessories 36, 38  
 accident 46  
 account number 96  
 accountant 97, 190  
 accounts department 175  
 accused 180  
 ace 230, 273  
 Achilles tendon 16  
 acorn squash 125  
 acquaintance 24  
 acquitted 181  
 across 320  
 acrylic paints 274  
 actions 237, 229, 227, 233, 183  
 activities 263, 245, 162, 77  
 actor 254, 191  
 actors 179  
 actress 254  
 acupressure 55  
 acupuncture 55  
 Adam's apple 19  
 add v 165  
 address 98  
 adhesive tape 47  
 adjustable wrench 80  
 admission charge 260  
 admissions office 168  
 admitted 48  
 aduki beans 131  
 adult 23  
 advantage 230  
 adventure 255  
 advertisement 269  
 aerate v 91  
 aerobics 251  
 Afghanistan 318  
 Africa 317  
 after 320  
 afternoon 305  
 aftershave 73  
 after-sun 108  
 agate 289  
 agenda 174  
 aikido 236  
 aileron 210  
 air bag 201  
 air conditioning 200  
 air cylinder 239  
 air filter 202, 204  
 air letter 98  
 air mattress 267

air supply 199  
 air vent 210  
 aircraft 210  
 aircraft carrier 215  
 airliner 210, 212  
 airport 212  
 aisle 106, 168, 210, 254  
 alarm clock 70  
 Alaska 314  
 Albania 316  
 alcoholic drinks 145  
 alfalfa 184  
 Algeria 317  
 all-purpose flour 139  
 allergy 44  
 alley 298  
 alligator 293  
 alligator clip 167  
 allspice 132  
 almond 129  
 almond oil 134  
 almonds 151  
 along 320  
 alpine 87  
 alpine skiing 247  
 alternating current 60  
 alternative therapy 54  
 alternator 203  
 altitude 211  
 aluminum 289  
 Amazonia 312  
 ambulance 94  
 amethyst 288  
 amniocentesis 52  
 amniotic fluid 52  
 amount 96  
 amp 60  
 amphibians 294  
 amplifier 268  
 anchor 214, 240  
 Andes 312  
 Andorra 316  
 anesthesiologist 48  
 angle 164  
 angler 244  
 Angola 317  
 angry 25  
 animals 292, 294  
 animated film 255  
 ankle 13, 15  
 ankle-length 34  
 anniversary 26  
 annual 86, 307  
 answer 163  
 answer v 99, 163  
 answering machine 99  
 ant 295  
 antenna 295  
 antifreeze 199, 203  
 Antigua and Barbuda 314

anti-inflammatory 109  
 antique shop 114  
 antiseptic 47  
 antiseptic wipe 47  
 anti-wrinkle 41  
 antler 291  
 apartment building 298  
 apéritif 153  
 aperture dial 270  
 apex 165  
 appeal 181  
 appearance 30  
 appendix 18  
 applaud v 255  
 apple 126  
 apple corer 68  
 apple juice 149  
 appliances 66  
 application 176  
 appointment 45, 175  
 apricot 126  
 April 306  
 apron 30, 50, 69, 212  
 APS camera 270  
 aquamarine 288  
 Arabian Sea 313  
 arc 164  
 arch 15, 85, 301  
 archery 249  
 architect 190  
 architecture 300  
 architrave 301  
 Arctic Circle 283  
 Arctic Ocean 312  
 area 165, 310  
 areas 299  
 arena 243  
 Argentina 315  
 arithmetic 165  
 arm 13  
 armband 238  
 armchair 63  
 Armenia 318  
 armpit 13  
 armrest 200, 210  
 aromatherapy 55  
 around 320  
 arrangements 111  
 arrest 94  
 arrivals 213  
 arrow 249  
 art 162  
 art college 169  
 Art Deco 301  
 art gallery 261  
 art history 169  
 Art Nouveau 301  
 art shop 115  
 artery 19  
 artichoke 124  
 artist 274

arts and crafts 274, 276  
 ash 283  
 ashtray 150  
 Asia 318  
 asphalt 187  
 assault 94  
 assistant 24  
 assisted delivery 53  
 asteroid 280  
 asthma 44  
 astigmatism 51  
 astronaut 281  
 astronomy 281  
 asymmetric bars 235  
 at 320  
 athlete 234  
 athletic shoes 31, 251  
 Atlantic Ocean 312  
 ATM 97  
 atmosphere 282, 286  
 atrium 104  
 attachment 177  
 attack 220  
 attack zone 224  
 attend v 174  
 attic 58  
 attractions 261  
 auburn 39  
 audience 254  
 August 306  
 aunt 22  
 aurora 286  
 Australasia 319  
 Australia 319  
 Austria 316  
 automatic 200  
 automatic door 196  
 automatic payment 96  
 avalanche 247  
 avenue 299  
 avocado 128  
 awning 148  
 ax 95  
 axle 205  
 ayurveda 55  
 Azerbaijan 318

## B

baby 23, 30  
 baby bath 74  
 baby care 74  
 baby changing facilities 104  
 baby monitor 75  
 baby products 107  
 baby sling 75  
 back 13  
 back brush 73  
 back seat 200  
 back up v 195  
 backboard 226  
 backdrop 254  
 backgammon 272  
 backhand 231  
 backpack 31, 37, 267  
 backsplash 66  
 backstroke 239  
 backswing 233  
 bacon 118, 119, 157  
 bad 321  
 badge 94, 189  
 badminton 231  
 bag 311  
 bagel 139  
 baggage claim 213  
 baggage trailer 212  
 bags 37  
 baguette 138  
 Bahamas 314  
 bail 181  
 bailiff 180  
 bait 244  
 bait v 245  
 bake v 67, 138  
 baked 159  
 baker 139  
 baker's 114  
 bakery 107, 114, 138  
 baking 69  
 baking sheet 69  
 balance wheel 276  
 balcony 59, 254  
 bald 39  
 bale 184  
 Balearic Islands 316  
 ball 15, 75, 221, 224, 226, 228, 230  
 ball boy 231  
 ballet 255  
 balsamic vinegar 135  
 Baltic Sea 313  
 bamboo 86, 122  
 banana 128  
 bandage 47  
 Bangladesh 318  
 banister 59  
 bank 96, 284  
 bank charge 96  
 bank manager 96  
 bank transfer 96  
 bar 150, 152, 250, 256, 311  
 bar code 106  
 bar counter 150  
 bar mitzvah 26  
 bar snacks 151  
 bar stool 150  
 barb 244  
 Barbados 314  
 barbecue 267  
 barber 39, 188  
 bark 296



- barley 130, 184  
 barn 182  
 baroque 301  
 bars 74  
 bartender 150, 191  
 basalt 288  
 base 164, 229  
 base station 99  
 baseball 228  
 baseline 230  
 baseman 228  
 basement 58  
 basil 133  
 basket 106, 207, 226  
 basket of fruit 126  
 basketball 226  
 basketball player 226  
 basque 35  
 bass clarinet 257  
 bass clef 256  
 bass guitar 258  
 bass guitarist 258  
 bassinet 74  
 bassoon 257  
 bat 225, 228, 231, 290  
 bat v 225, 229  
 bath mat 72  
 bath towel 73  
 bathrobe 31, 32, 73  
 bathroom 72  
 bathtub 72  
 baton 235, 256  
 batsman 225  
 batter 228  
 batteries 260  
 battery 167, 202  
 battery pack 78  
 battleship 215  
 bay leaf 133  
 be born v 26  
 beach 264  
 beach bag 264  
 beach ball 265  
 beach hut 264  
 beach towel 265  
 beach umbrella 264  
 beaker 167  
 beam 186, 235  
 bean sprout 122  
 beans 131, 144  
 bear 291  
 beat 259  
 beauty 40, 105  
 beauty treatments 41  
 bed 70  
 bed and breakfast 101  
 bed linen 71  
 bedding 74  
 bedroom 70  
 bedside lamp 70  
 bedspread 70  
 bee 295  
 beech 296  
 beef 118  
 beer 145, 151  
 beer tap 150  
 beetle 295  
 beet 125  
 before 320  
 beginning 321  
 behind 320  
 Belarus 316  
 Belgium 316  
 Belize 314  
 bell 197  
 below 320  
 belt 32, 36, 236  
 bench 250, 262  
 Benin 317  
 berry 296  
 beside 320  
 bet 273  
 between 320  
 beyond 320  
 Bhutan 318  
 biathlon 247  
 bib 30  
 biceps curl 251  
 biceps 16  
 bicycle 206  
 bidet 72  
 biennial 86  
 bifocal 51  
 big toe 15  
 bike rack 207  
 bikini 264  
 bill 152, 293  
 binoculars 281  
 biology 162  
 biplane 211  
 birch 296  
 bird-watching 263  
 birds 292  
 birth 52  
 birth weight 53  
 birth certificate 26  
 birthday 27  
 birthday cake 141  
 birthday candles 141  
 birthday party 27  
 bishop 272  
 bit 242  
 bit brace 78  
 bite 46  
 bite v 245  
 bitter 124, 145  
 black 39, 272, 274  
 black belt 237  
 black coffee 148  
 black currant 127  
 black hole 280  
 black olive 143  
 black pudding 157  
 Black Sea 313  
 black tea 149  
 blackberry 127  
 blackboard 162  
 black-eyed beans 131  
 bladder 20  
 blade 60, 66, 78, 89  
 blanket 71, 74  
 blazer 33  
 bleach 77  
 blender 66  
 blister 46  
 block 237  
 block v 227  
 blonde 39  
 blood pressure 44  
 blood pressure gauge 45  
 blood test 48  
 blouse 34  
 blow-dry v 38  
 blow out v 141  
 blowhole 290  
 blue 274  
 blue cheese 136  
 bluebells 297  
 blueberry 127  
 blues 259  
 blusher 40  
 board 241  
 board v 217  
 board games 272  
 boarding pass 213  
 boardwalk 265  
 bob 39  
 bobbin 276  
 bobsled 247  
 body 12  
 body lotion 73  
 body systems 19  
 bodywork 202  
 boil v 67  
 boiled egg 137, 157  
 Bolivia 315  
 bollard 214, 298  
 bolt 59  
 bomber 211  
 bone 17, 119, 121  
 bone meal 88  
 boned 121  
 bongos 257  
 book 168  
 bookstore 115  
 bookshelf 63, 168  
 boom 95, 240  
 booster 281  
 booties 30  
 bored 25  
 borrow v 168  
 Bosnia and Herzegovina 316  
 Botswana 317  
 bottle 61, 75, 135, 311  
 bottle opener 68, 150  
 bottled foods 134  
 bottled water 144  
 bottom tier 141  
 boundary line 225  
 bouquet 35, 111  
 bouquet garni 132  
 bout 237  
 boutique 115  
 bow 240, 249  
 bow tie 36  
 bowl 61, 65, 112  
 bowl v 225  
 bowler 225  
 bowling 249  
 bowling ball 249  
 box 254  
 box file 173  
 box of chocolates 113  
 box of tissues 70  
 box office 255  
 boxer shorts 33  
 boxercise 251  
 boxing 236  
 boxing gloves 237  
 boxing ring 237  
 boy 23  
 boyfriend 24  
 bra 35  
 braces 50  
 bracelet 36  
 braid 39  
 brain 19  
 brake 200, 204, 206  
 brake v 207  
 brake block 207  
 brake fluid reservoir 202  
 brake lever 207  
 brake pedal 205  
 bran 130  
 branch 296  
 brandy 145  
 brass 256  
 Brazil 315  
 Brazil nut 129  
 bread 157  
 bread flour 139  
 bread knife 68  
 bread roll 143  
 breadcrumbs 139  
 breadfruit 124  
 breads 138  
 break a record v 234  
 break water v 52  
 breakdown 203  
 breakfast 64, 156  
 breakfast buffet 156  
 breakfast cereals 107  
 breakfast table 156  
 breakfast tray 101  
 breast 12, 119  
 breast pump 53  
 breastbone 17  
 breastfeed v 53  
 breaststroke 239  
 breathing 47  
 breech 52  
 brick 187  
 bridge 15, 214, 258, 273, 300  
 bridle 242  
 bridle path 263  
 brie 142  
 briefcase 37  
 briefs 33, 35  
 brioche 157  
 broadcast 179  
 broadcast v 178  
 broccoli 123  
 brochure 96, 175  
 brogue 37  
 broil v 67  
 bronze 235  
 brooch 36  
 broom 77  
 broth 158  
 brother 22  
 brother-in-law 23  
 browband 242  
 brown 274  
 brown bread 139, 149  
 brown flour 138  
 brown lentils 131  
 brown rice 130  
 browse v 177  
 browser 177  
 bruise 46  
 Brunei 319  
 brunette 39  
 brush 38, 40, 77, 83, 274  
 brush v 38, 50  
 Brussels sprout 122  
 bubble bath 73  
 buckle 36  
 bud 111, 297  
 buffet 152  
 build v 186  
 building site 186  
 buildings 299  
 built-in wardrobe 71  
 bulb 86  
 Bulgaria 316  
 bull 185  
 bulldog clip 173  
 bullnose pliers 80  
 bullseye 273  
 bumper 74, 198  
 bun 39, 140, 139, 155  
 bunch 111  
 bungalow 58  
 bungee jumping 248  
 bunker 232  
 bunsen burner 166  
 buoy 217  
 bureau de change 97  
 burger 154  
 burger bar 154  
 burger meal 154  
 burglar alarm 58  
 burglary 94  
 Burkina Faso 317  
 Burma (Myanmar) 318  
 burn 46  
 burner 67

Burundi 317  
 bus 196  
 bus driver 190  
 bus stop 197  
 bus station 197  
 bus stop 197, 299  
 bus ticket 197  
 buses 196  
 business 175  
 business class 211  
 business deal 175  
 business lunch 175  
 business partner 24  
 business suit 32  
 business trip 175  
 businessman 175  
 businesswoman 175  
 busy 99  
 butcher 118, 188  
 butcher shop 114  
 butter 137, 156  
 butter beans 131  
 buttercup 297  
 butterfly 239, 295  
 buttermilk 137  
 butternut squash 125  
 buttock 13, 16  
 button 32  
 buttonhole 32  
 buttress 301  
 by 320  
 by airmail 98  
 bytes 176

**C**  
 cab 95  
 cab driver 190  
 cabbage 123  
 cabin 210, 214  
 Cabinda 317  
 cabinet 66  
 cable 79, 207  
 cable car 246  
 cable television 269  
 cactus 87  
 caddy 233  
 cesarean section 52  
 café 148, 262  
 cafeteria 168  
 cafetière 65  
 cake pan 69  
 cakes 140  
 calcite 289  
 calcium 109  
 calculator 165  
 calendar 306  
 calf 13, 16, 185  
 call button 48  
 calyx 297  
 cam belt 203  
 Cambodia 318  
 camcorder 260, 269  
 camel 291  
 camembert 142

camera 178, 260, 270  
 camera case 271  
 camera crane 178  
 camera shop 115  
 cameraman 178  
 Cameroon 317  
 camisole 35  
 camp v 266  
 camp bed 266  
 campari 145  
 camper van 266  
 campfire 266  
 camping 266  
 camping stove 267  
 campground 266  
 campus 168  
 can 145, 289, 311  
 can opener 68  
 Canada 314  
 canary 292  
 candied fruit 129  
 candle 63  
 candy 113  
 candy store 113  
 cane 91  
 canes 89  
 canine 50  
 canned drink 154  
 canned food 107  
 canoe 214  
 canoeing 241  
 canola oil 135  
 canter 243  
 canvas 274  
 cap 21, 36, 238  
 capacity 311  
 cape gooseberry 128  
 capers 143  
 capital 315  
 capoeira 237  
 cappuccino 148  
 capsie v 241  
 capsule 109  
 captain 214  
 car 198, 200  
 car accident 203  
 car rental 213  
 car seat 198, 207  
 car stereo 201  
 car wash 198  
 caramel 113  
 caraway 131  
 card 27  
 card phone 99  
 card slot 97  
 cardamom 132  
 cardboard 275  
 cardigan 32  
 cardiology 49  
 cardiovascular 19  
 cards 273  
 cargo 216  
 Caribbean Sea 312  
 carnation 110

carnival 27  
 carousel 212  
 carpenter 188  
 carpentry bits 80  
 carpet 71  
 carriage race 243  
 carrier 75, 204  
 carrot 124  
 carry-on luggage 211, 213  
 cart 48, 100, 106, 208, 213  
 cartilage 17  
 carton 311  
 cartoon 178  
 carve v 79  
 carving fork 68  
 case 51  
 cash v 97  
 cashew 129  
 cashews 151  
 cashier 96, 106  
 casino 261  
 Caspian Sea 313  
 cassava 124  
 casserole dish 69  
 cassette player 269  
 cassette tape 269  
 cast 254  
 cast v 245  
 castle 300  
 casual 34  
 casual wear 33  
 cat 290  
 catalog 168  
 catamaran 215  
 cataract 51  
 catch v 220, 227, 229, 245  
 catcher 229  
 caterpillar 295  
 cathedral 300  
 catheter 53  
 cauliflower 124  
 cave 284  
 CD 269  
 CD player 268  
 cedar 296  
 ceiling 62  
 celebration 140  
 celebration cakes 141  
 celebrations 27  
 celeriac 124  
 celery 122  
 cell 94, 181  
 cell phone 99  
 cello 256  
 cement 186  
 cement mixer 186  
 centimeter 310  
 centipede 295  
 Central African Republic 317  
 central reservation 194

center 164  
 center circle 222, 224, 226  
 center field 228  
 center line 226  
 centerboard 241  
 century 307  
 CEO 175  
 ceramic range 66  
 cereal 130, 156  
 cervical vertebrae 17  
 cervix 20, 52  
 Chad 317  
 chain 36, 206  
 chair 64  
 chair v 174  
 chairlift 246  
 chalk 85, 162, 288  
 chamber 283  
 chamomile tea 149  
 champagne 145  
 championship 230  
 change v 209  
 change a tire v 203  
 change channels v 269  
 change gears v 207  
 changing mat 74  
 changing room 104  
 channel 178  
 charcoal 266, 275  
 charge 94, 180  
 chart 48  
 chassis 203  
 check 96  
 checkbook 96  
 checkers 272  
 check-in v 212  
 check-in desk 213  
 checking account 96  
 checkout 106  
 checkup 50  
 cheddar 142  
 cheek 14  
 cheerleader 220  
 cheese 136, 156  
 chef 152, 190  
 chef's hat 190  
 chemistry 162  
 cherry 126  
 cherry tomato 124  
 chess 272  
 chessboard 272  
 chest 12  
 chest of drawers 70  
 chest press 251  
 chestnut 129  
 chewing gum 113  
 chick 185  
 chicken 119, 185  
 chicken burger 155  
 chicken coop 185  
 chicken nuggets 155  
 chicken pox 44  
 chicory 122

child 23, 31  
 child lock 75  
 childbirth 53  
 children 23  
 children's clothing 30  
 children's department 104  
 children's meal 153  
 children's ward 48  
 Chile 315  
 chili pepper 124, 132, 143  
 chill 44  
 chimney 58  
 chin 14  
 China 318  
 china 105  
 chip v 233  
 chips 113, 151  
 chipboard 79  
 chiropractic 54  
 chisel 81, 275  
 chives 133  
 chocolate 113  
 chocolate bar 113  
 chocolate cake 140  
 chocolate chip 141  
 chocolate-coated 140  
 chocolate milkshake 149  
 chocolate spread 135  
 choir 301  
 choke v 47  
 chop 119, 237  
 chorizo 143  
 choux pastry 140  
 christening 26  
 Christmas 27  
 chrysanthemum 110  
 chuck 78  
 church 298, 300  
 chutney 134  
 cider 145  
 cider vinegar 135  
 cigar 112  
 cigarettes 112  
 cilantro 133  
 cinnamon 133  
 circle 165, 254  
 circular saw 78  
 circuit training 251  
 circulation desk 168  
 circumference 164  
 citrus fruit 126  
 city 299  
 clam 121  
 clamp 78, 166  
 clamp stand 166  
 clapper board 179  
 clarinet 257  
 clasp 36  
 classical music 255, 259  
 classroom 162  
 claw 291

- clay 85, 275  
 clean *v* 77  
 clean clothes 76  
 cleaned 121  
 cleaner 188  
 cleaning equipment 77  
 cleaning fluid 51  
 cleanser 41  
 clear honey 134  
 cleat 240  
 cleaver 68  
 clementine 126  
 client 38, 175, 180  
 cliff 285  
 climber 87  
 climbing frame 263  
 clinic 48, 168  
 clipboard 173  
 clitoris 20  
 clock 62  
 clock radio 70  
 closed 260, 321  
 cloth diaper 30  
 clothesline 76  
 clothespin 76  
 clothing 205  
 cloud 287  
 cloudy 286  
 clove 125  
 clover 297  
 cloves 133  
 club 273  
 club sandwich 155  
 clubhouse 232  
 clutch 200, 204  
 coach 196  
 coal 288  
 coast 285  
 coaster 150  
 coastguard 217  
 coat 32  
 coat hanger 70  
 cockatoo 293  
 cockle 121  
 cockpit 210  
 cockroach 295  
 cocktail 151  
 cocktail shaker 150  
 cocoa powder 148  
 coconut 129  
 cocoon 295  
 cod 120  
 coffee 144, 148, 153, 156, 184  
 coffee cup 65  
 coffee machine 148, 150  
 coffee milkshake 149  
 coffee spoon 153  
 coffee table 62  
 cog 206  
 coin 97  
 coin phone 99  
 coin return 99  
 cola 144  
 colander 68  
 cold 44, 286, 321  
 cold faucet 72  
 cold-pressed oil 135  
 collage 275  
 collar 32  
 collarbone 17  
 colleague 24  
 collect call 99  
 collection 98  
 college 168  
 cologne 41  
 Colombia 315  
 colony 315  
 colored pencil 163  
 colors 39, 274  
 comb 38  
 comb *v* 38  
 combat sports 236  
 combine 182  
 comedy 255  
 comforter 71  
 comet 280  
 comic 112  
 commis chef 152  
 commission 97  
 communications 98  
 commuter 208  
 Comoros 317  
 compact 40  
 compact car 199  
 company 175  
 compartment 209  
 compass 165, 312, 240  
 complaint 94  
 complexion 41  
 composite 181  
 compost 88  
 compost pile 85  
 computer 172, 176  
 concealer 40  
 conceive *v* 20  
 conception 52  
 concert 255, 258  
 concourse 209  
 concrete block 187  
 concussion 46  
 condensed milk 136  
 conditioner 38  
 condom 21  
 conductor 256  
 cone 164, 187  
 confectionery 107, 113  
 confident 25  
 confused 25  
 conglomerate 288  
 Congo 317  
 conifer 86  
 connect *v* 177  
 connection 212  
 conning tower 215  
 console 269  
 constellation 281  
 construction 186  
 construction worker 186, 188  
 consultant 49  
 consultation 45  
 contact lenses 51  
 container 216, 311  
 container port 216  
 container ship 215  
 continent 282, 315  
 contraception 21, 52  
 contraction 52  
 control tower 212  
 controller 269  
 controls 201, 204  
 convenience food 107  
 convertible 199  
 conveyer belt 106  
 cooked meat 118, 143  
 cookies 113, 141  
 cooking 67  
 coolant reservoir 202  
 cooling rack 69  
 co-pilot 211  
 copper 289  
 copy *v* 172  
 cor anglais 257  
 coral reef 285  
 cordless drill 78  
 cordless phone 99  
 core 127  
 cork 134  
 corkscrew 150  
 corn 122, 130, 184  
 corn bread 139  
 corn oil 135  
 cornea 51  
 corner 223  
 corner flag 223  
 cornice 300  
 corset 35  
 Corsica 316  
 Costa Rica 314  
 costume 255  
 cottage cheese 136  
 cottage garden 84  
 cotton 184, 277  
 cotton balls 41  
 cough 44  
 cough drop 109  
 cough medicine 108  
 counselor 55  
 count *v* 165  
 counter 96, 98, 100, 142, 272  
 countertop 66  
 country 259, 315  
 couple 24  
 courier 99  
 courses 153  
 court 226  
 court case 180  
 court clerk 180  
 court date 180  
 courtroom 180  
 courtyard 58, 84  
 couscous 130  
 cousin 22  
 coverall 30  
 cow 185  
 cow's milk 136  
 CPU 176  
 crab 121, 295  
 cracked wheat 130  
 cradle 95  
 craft knife 82  
 crafts 275  
 cramp 239  
 cramps 44  
 cranberry 127  
 crane 187, 216, 292  
 crater 283  
 crayfish 121  
 cream 109, 137, 140, 157  
 cream cheese 136  
 cream pie 141  
 crease 225  
 credit card 96  
 creel 245  
 creeper 87  
 crème caramel 141  
 crème pâtisserie 140  
 crêpe 155, 157  
 crescent moon 280  
 crew 241  
 crew hatch 281  
 crib 74  
 cricket 225, 295  
 cricket ball 225  
 cricketer 225  
 crime 94  
 criminal 181  
 criminal record 181  
 crisp 127  
 crispbread 139, 156  
 crisper 67  
 Croatia 316  
 crochet 277  
 crochet hook 277  
 crockery 64  
 crockery and cutlery 65  
 crocodile 293  
 croissant 156  
 crop 39, 183  
 crop farm 183  
 crops 184  
 crossbar 207, 222, 235  
 cross-country skiing 247  
 cross-trainer 250  
 crosswalk 195  
 crow 292  
 crown 50  
 crucible 166  
 crushed 132  
 crust 139, 282  
 cry *v* 25  
 crystal healing 55  
 Cuba 314  
 cube 164  
 cucumber 125  
 cuff 32, 45  
 cufflink 36  
 cultivate *v* 91  
 cultivator 182  
 cumin 132  
 curb 298  
 cured 118, 159, 143  
 curler 38  
 curling 247  
 curling iron 38  
 curly 39  
 currant 129  
 curry 158  
 curry powder 132  
 curtain 63, 254  
 curved 165  
 cushion 62  
 custard 140  
 customer 96, 104, 106, 152  
 customer service department 175  
 customer services 104  
 customs 212  
 customs house 216  
 cut 46  
 cut *v* 38, 79, 277  
 cuticle 15  
 cutlery 64  
 cuts 119  
 cutting 91  
 cutting board 68  
 cuttlefish 121  
 cycle *v* 207  
 cycle lane 206  
 cycling 263  
 cylinder 164  
 cylinder head 202  
 cymbals 257  
 Cyprus 316  
 Czech Republic 316

**D**

- daffodil 111  
 dairy 107  
 dairy farm 183  
 dairy produce 136  
 daisy 110, 297  
 dam 300  
 dance 259  
 dance academy 169  
 dancer 191  
 dandelion 123, 297  
 dandruff 39  
 dark 41, 321  
 darkroom 271  
 darn *v* 277  
 dartboard 273  
 darts 273  
 dashboard 201  
 date 129, 306  
 daughter 22

- daughter-in-law 22  
dawn 305  
day 305, 306  
day after tomorrow 307  
day before yesterday 307  
dead ball line 221  
deadhead *v* 91  
deal *v* 273  
debit card 96  
decade 307  
decay 50  
December 306  
deciduous 86  
decimal 165  
deck 214  
deck chair 265  
deck of cards 273  
decking 85  
decorating 82  
decoration 141  
decorator 82  
deep end 239  
deep-fried 159  
deep-sea fishing 245  
deer 291  
defense 181, 220  
defendant 181  
defender 223  
defending zone 224  
defrost *v* 67  
degree 169  
delay 209  
deli 107  
delicatessen 142  
delivery 52, 98  
deltoid 16  
Democratic Republic of the Congo 317  
Denmark 316  
denomination 97  
denominator 165  
dental care 108  
dental floss 50, 72  
dental hygiene 72  
dental X-ray 50  
dentist 50, 189  
dentist's chair 50  
dentures 50  
deodorant 73, 108  
department 169  
department store 105  
departments 49  
departure lounge 213  
departures 213  
deposit *v* 96  
deposit slips 96  
depth 165  
dermatology 49  
descaled 121  
desert 285  
desiccated 129  
designer 191, 277  
desk 162, 172  
desktop 177  
dessert 153  
desserts 140  
dessert cart 152  
destination 213  
detached 58  
detective 94  
detergent 77  
detour 195  
deuce 230  
develop *v* 271  
diabetes 44  
diagonal 164  
dial *v* 99  
diameter 164  
diamond 273, 288  
diaper 75  
diaper bag 75  
diaper rash cream 74  
diaphragm 19, 21  
diarrhea 44, 109  
dice 272  
dictionary 163  
die *v* 26  
diesel 199  
diesel train 208  
difficult 321  
dig *v* 90, 227  
digestive 19  
digital 269  
digital camera 270  
dilation 52  
dill 133  
dimensions 165  
dimple 15  
dining car 209  
dining room 64  
dinner 64, 158  
dinner plate 65  
dioptr 51  
diploma 169  
dipstick 202  
direct current 60  
directions 260  
director 254  
directory assistance 99  
dirt bike 205  
dirty laundry 76  
disabled parking 195  
discharged 48  
disconnected 99  
discus 234  
discuss *v* 163  
disembark *v* 217  
dishwasher 66  
disinfectant solution 51  
disk 176  
disposable 109  
disposable camera 270  
disposable diaper 30  
disposable razor 73  
dissertation 169  
distance 310  
distributor 203  
district 315  
dive 239  
dive *v* 238  
diver 238  
divide *v* 165  
divided by 165  
divided highway 195  
dividends 97  
divider 173, 194  
divorce 26  
Diwali 27  
DJ 179  
Djibouti 317  
do not bend *v* 98  
dock 214, 216  
dock *v* 217  
doctor 45, 189  
doctorate 169  
documentary 178  
dog 290  
dog-sledding 247  
doll 75  
dollhouse 75  
dolphin 290  
dome 300  
domestic flight 212  
Dominica 314  
Dominican Republic 314  
dominoes 273  
donkey 185  
door 196, 198, 209  
door chain 59  
door knob 59  
door knocker 59  
door lock 200  
doorbell 59  
doormat 59  
dormer 58  
dorsal fin 294  
dosage 109  
double 151  
double bass 256  
double bassoon 257  
double bed 71  
double room 100  
double-decker bus 196  
doubles 230  
dough 138  
Dover sole 120  
down 320  
downhill skiing 247  
download *v* 177  
dragonfly 295  
drain 61, 72, 299  
drain cock 61  
drainage 91  
draining board 67  
draw 223  
draw *v* 162  
drawer 66, 70, 172  
drawer unit 172  
drawing 275  
dress 31, 34  
dressage 243  
dressed 159  
dressed chicken 119  
dressing 47, 158  
dressing table 71  
dribble *v* 223, 227  
dried flowers 111  
dried fruit 156  
drill 50  
drill *v* 79  
drill bit 78  
drill bits 80  
drinking cup 75  
drinking fountain 262  
drinks 107, 144, 156  
drip 53  
drive *v* 195, 233  
driver 196  
driver's seat 196  
driveshaft 202  
drop anchor *v* 217  
dropper 109, 167  
drops 109  
dropshot 230  
drown *v* 239  
drum 258  
drum kit 258  
drummer 258  
dry 39, 41, 130, 145, 286, 321  
dry *v* 76  
dry-cleaner 115  
dry dock 217  
duck 119, 185  
duck egg 137  
duckling 185  
duffle bag 37  
duffle coat 31  
dugout 229  
dumb bell 251  
dumper truck 187  
dunk *v* 227  
duodenum 18  
duplex 58  
dusk 305  
dust *v* 77  
dustpan 77  
duster 77  
dust sheet 83  
duty-free shop 213  
DVD 269  
DVD player 268  
dyed 39  
dynamo 207  
**E**  
eagle 292  
ear 14  
early  
earring 36  
Earth 280, 282  
earthenware dish 69  
earthquake 283  
easel 174, 274  
east 312  
East Timor 319  
Easter 27  
easy 321  
easy cook 130  
eat *v* 64  
eat-in 154  
eating 75  
eaves 58  
éclair 140  
eclipse 280  
economics 169  
economy class 211  
Ecuador 315  
eczema 44  
edam 142  
edge 246  
editor 191  
eel 294  
egg 20  
egg cup 65, 137  
egg white 137  
eggplant 125  
eggs 137  
Egypt 317  
eight 308  
eight hundred 308  
eighteen 308  
eighteenth 309  
eighth 309  
eightieth 309  
eighty 308  
ejaculatory duct 21  
El Salvador 314  
elbow 13  
electric blanket 71  
electric drill 78  
electric guitar 258  
electric meter 60  
electric razor 73  
electric shock 46  
electric train 208  
electrical goods 105, 107  
electrician 188  
electricity 60  
elephant 291  
elevator 59, 100, 104  
eleven 308  
eleventh 309  
elm 296  
email 98, 177  
email account 177  
email address 177  
embarrassed 25  
embossed paper 83  
embroidery 277  
embryo 52  
emerald 288  
emergency 46  
emergency exit 210  
emergency lever 209  
emergency phone 195  
emergency room 48  
emergency services 94

- emigrate *v* 26  
 emotions 25  
 employee 24  
 employer 24  
 empty 321  
 enamel 50  
 encore 255  
 encyclopedia 163  
 end 321  
 end zone 220  
 endive 123  
 endline 226  
 endocrine 19  
 endocrinology 49  
 engaged couple 24  
 engine 202, 204, 208, 210  
 engine room 214  
 engineering 169  
 English breakfast 157  
 English mustard 135  
 engraving 275  
 enlarge *v* 172  
 enlargement 271  
 ENT (otolaryngology) 49  
 entrance 59  
 entrée 153  
 envelope 98, 173  
 environment 280  
 epidural 52  
 epiglottis 19  
 epilepsy 44  
 episiotomy 52  
 equals 165  
 equation 165  
 equator 283  
 equipment 233, 238  
 equipment 165  
 Equatorial Guinea 317  
 equity 97  
 eraser 163  
 Eritrea 317  
 erupt *v* 283  
 escalator 104  
 esophagus 19  
 espresso 148  
 essay 163  
 essential oils 55  
 estate 199  
 Estonia 316  
 estuary 285  
 Ethiopia 317  
 eucalyptus 296  
 Europe 316  
 evening 305  
 evening dress 34  
 evening menu 152  
 events 243, 247  
 evergreen 86  
 evidence 181  
 excavator 187  
 excess baggage 212  
 exchange rate 97  
 excited 25
- excuse me 322  
 executive 174  
 exercise bike 250  
 exercises 251  
 exfoliate *v* 41  
 exhaust pipe 203, 204  
 exhibit *v* 261  
 exhibition 261  
 exit 210  
 exit ramp 194  
 exosphere 286  
 expanding file 173  
 expectant 52  
 experiment 166  
 expiration date 109  
 exposure 271  
 express train 209  
 extend *v* 251  
 extension 58  
 extension cord 78  
 exterior 198  
 extra time 223  
 extraction 50  
 extractor 66  
 eye 14, 51, 244, 276  
 eye shadow 40  
 eye test 51  
 eyebrow 14, 51  
 eyebrow brush 40  
 eyebrow pencil 40  
 eyecup 269  
 eyelash 14, 51  
 eyelet 37  
 eyelid 51  
 eyeliner 40  
 eyepiece 167
- F**  
 fabric 277  
 fabric conditioner 76  
 face 14  
 face cream 73  
 face mask 225  
 face pack 41  
 face powder 40  
 faceoff circle 224  
 facial 41  
 factory 299  
 faint *v* 25, 44  
 fair 41  
 fairground 262  
 fairway 232  
 falcon 292  
 Falkland Islands 315  
 fall 237  
 fall (autumn) 31, 307  
 fall in love *v* 26  
 fallopian tube 20  
 family 22  
 famous ruin 261  
 fan 60, 202  
 fan belt 203  
 fans 258  
 far 320
- fare 197, 209  
 farm 182, 183, 184  
 farmer 182, 189  
 farmhouse 182  
 farmland 182  
 farmyard 182  
 farsightedness 51  
 fashion 277  
 fast 321  
 fast food 154  
 fast-forward 269  
 fastening 37  
 fat 119, 321  
 fat-free 137  
 father 22  
 father-in-law 23  
 fault 230  
 extend *v* 251  
 fava beans 122, 131  
 fax 98, 172  
 fax machine 172  
 feather 293  
 feature film 269  
 February 306  
 feed *v* 183  
 feijoa 128  
 female 12, 20  
 feminine hygiene 108  
 femur 17  
 fence 85, 182, 243  
 fencing 249  
 feng shui 55  
 fennel 122, 133  
 fennel seeds 133  
 fenugreek 132  
 fern 86  
 ferry 215, 216  
 ferry terminal 216  
 fertilization 20  
 fertilize *v* 91  
 fertilizer 91  
 festivals 27  
 fetus 52  
 fever 44  
 fiancé 24  
 fiancée 24  
 fiber 127  
 fibula 17  
 field 182, 222, 225, 228, 234, 258, 266  
 field *v* 225, 229  
 field hockey 224  
 fifteen 308  
 fifteenth 309  
 fifth 309  
 fiftieth 309  
 fifty 308  
 fifty five thousand, five hundred 309  
 fifty thousand 309  
 fig 129  
 fighter plane 211  
 figure skating 247  
 figurine 260  
 Fiji 319
- filament 60  
 file 81, 172, 177  
 filing cabinet 172  
 fill *v* 82  
 filler 83  
 fillet 119, 121  
 filleted 121  
 filling 50, 140, 155  
 film chamber 270  
 film spool 271  
 filter 270  
 filter coffee 148  
 filter paper 167  
 fin 210  
 finance 97  
 financial advisor 97  
 fingerprint 94  
 final 300  
 finish line 234  
 Finland 316  
 fire 95  
 fire alarm 95  
 fire department 95  
 fire engine 95  
 fire escape 95  
 fire extinguisher 95  
 fire station 95  
 firefighter 95, 189  
 firelighter 266  
 fireplace 63  
 firm 124  
 first 309  
 first aid 47  
 first-aid box 47  
 first night 254  
 fish 107, 120, 294  
 fish and chips 155  
 fish farm 183  
 fisherman 189  
 fishhook 244  
 fishing 244, 245  
 fishing boat 217  
 fishing permit 245  
 fishing port 217  
 fishing rod 244  
 fish-seller 114, 120, 188  
 fist 15, 237  
 fitness 250  
 five 308  
 five hundred 308  
 flag 221, 232  
 flageolet beans 131  
 flakes 132  
 flamingo 292  
 flan 142  
 flare 240  
 flash 270  
 flash gun 270  
 flashlight 267  
 flask 166  
 flat 59, 256  
 flatbread 139  
 flat race 243  
 flat tire 203, 207
- flat wood bit 80  
 flavored oil 134  
 flax 184  
 fleece 74  
 flesh 124, 127, 129  
 flex *v* 251  
 flight attendant 190, 210  
 flight number 213  
 flint 288  
 flipchart 174  
 flip-flop 37  
 flipper 239, 290  
 float 238, 244  
 float ball 61  
 flock 183  
 flood 287  
 floor 58, 62, 71  
 floor exercises 235  
 floor plan 261  
 florentine 141  
 floret 122  
 florist 110, 188  
 floss *v* 50  
 flours 138  
 flower 297  
 flowerbed 85, 90  
 flowering plant 297  
 flowering shrub 87  
 flowers 110  
 flu 44  
 flute 139, 257  
 fly 244, 295  
 fly *v* 211  
 fly-fishing 245  
 flysheet 266  
 foal 185  
 focus *v* 271  
 focusing knob 167  
 fog 287  
 foil 249  
 folder 177  
 foliage 110  
 folk music 259  
 follicle 20  
 font 177  
 food 118, 130, 149  
 food hall 105  
 food processor 66  
 foot 12, 15, 310  
 football 220  
 footboard 71  
 footpath 262  
 footstrap 241  
 for 320  
 forceps 53, 167  
 forearm 12  
 forecourt 199  
 forehead 231  
 forehead 14  
 foreign currency 97  
 foreskin 21  
 forest 285  
 fork 65, 88, 153, 207  
 forklift truck 186, 216

- formal 34  
 formal garden 84, 262  
 fortieth 309  
 forty 308  
 forty minutes  
 forward 222  
 foul 222, 226  
 foul ball 228  
 foul line 229  
 foundation 40  
 fountain 85  
 four 308  
 four hundred 308  
 four-door 200  
 fourteen 308  
 fourteenth 309  
 fourth 309  
 four-wheel drive 199  
 fox 290  
 foxglove 297  
 foyer 59  
 fraction 165  
 fracture 46  
 fragile 98  
 fragranced 130  
 frame 51, 62, 206, 230, 269  
 frame counter 270  
 France 316  
 freckle 15  
 free 321  
 free kick 222  
 free-range 118  
 free weights 250  
 freesia 110  
 free-throw line 226  
 freeway 194  
 freeze 287  
 freeze *v* 67  
 freezer 67  
 freight train 208  
 freighter 215  
 French bean 122  
 French braid 39  
 french fries 154  
 French Guiana 315  
 French horn 257  
 French mustard 135  
 French toast 157  
 frequency 179  
 fresh 121, 127, 130  
 fresh cheese 136  
 fresh fruit 157  
 freshwater fishing 245  
 fret 258  
 fretsaw 81  
 Friday 306  
 fried 159  
 fried chicken 155  
 fried egg 157  
 friend 24  
 frieze 301  
 frog 294  
 from 320  
 front crawl 239  
 front door 58  
 front wheel 196  
 frontage road 194, 216  
 frontal 16  
 frost 287  
 froth 148  
 frown 25  
 frozen 121, 124  
 frozen food 107  
 frozen yogurt 137  
 fruit 107, 126, 128  
 fruit bread 139  
 fruit cake 140  
 fruit farm 183  
 fruit juice 127, 156  
 fruit tart 140  
 fruit yogurt 157  
 fry *v* 67  
 frying pan 69  
 fuel gauge 201  
 fuel tank 204  
 full 64, 266, 321  
 full board 101  
 full moon 280  
 fumble 220  
 funeral 26  
 funnel 166, 214  
 furniture store 115  
 furrow 183  
 fuse 60  
 fuse box 60, 203  
 fuselage 210
- G**  
 gable 300  
 Gabon 317  
 Galápagos Islands 315  
 galaxy 280  
 gale 286  
 galley 214  
 gallon 311  
 gallop 243  
 galvanized 79  
 Gambia 317  
 game 119, 230, 273  
 game show 178  
 games 272  
 gangway 214  
 garage 58, 199, 203  
 garbage can 61, 67  
 garbanzos 131  
 garden 84  
 garden center 115  
 garden features 84  
 garden pea 122  
 garden plants 86  
 garden styles 84  
 garden tools 88  
 gardener 188  
 gardening 90  
 gardening gloves 89  
 gardens 261  
 garland 111  
 garlic 125, 132  
 garlic press 68  
 garnet 288  
 garter 35  
 garter belt 35  
 gas burner 61  
 gas pump 199  
 gas station 199  
 gas tank 203  
 gasket 61  
 gasoline 199  
 gate 85, 182, 247  
 gate number 213  
 gauze 47, 167  
 gear lever 207  
 gearbox 202, 204  
 gears 206  
 gearshift 201  
 gel 38, 109  
 gems 288  
 generation 23  
 generator 60  
 genitals 12  
 geography 162  
 geometry 165  
 Georgia 318  
 gerbera 110  
 Germany 316  
 get a job *v* 26  
 get married *v* 26  
 get up *v* 71  
 geyser 285  
 Ghana 317  
 giant slalom 247  
 gift shop 114  
 gill 294  
 gin 145  
 gin and tonic 151  
 ginger 125, 133  
 giraffe 291  
 girder 186  
 girl 23  
 girlfriend 24  
 girth 242  
 glacier 284  
 gladiolus 110  
 gland 19  
 glass 69, 152  
 glass bottle 166  
 glass stirrer 167  
 glasses 51, 150  
 glassware 64  
 glaze *v* 139  
 glider 211, 248  
 gliding 248  
 gloss 83, 271  
 glove 224, 233, 236, 246  
 gloves 36  
 glue 275  
 glue gun 78  
 gneiss 288  
 go to bed *v* 71  
 go to sleep *v* 71  
 goal 221, 223, 224  
 goal area 223  
 goal line 220, 223, 224  
 goalkeeper 222, 224  
 goalpost 220, 222  
 goat 185  
 goat's cheese 142  
 goat's milk 136  
 goggles 238, 247  
 going out 75  
 gold 235, 289  
 goldfish 294  
 golf 232  
 golf bag 233  
 golf ball 233  
 golf cart 232, 233  
 golf clubs 233  
 golf course 232  
 golf shoe 233  
 golfer 232  
 gong 257  
 good 321  
 good afternoon 322  
 good evening 322  
 good morning 322  
 good night 322  
 goodbye 322  
 goose 119, 293  
 goose egg 137  
 gooseberry 127  
 gorge 284  
 gorilla 291  
 gothic 301  
 grade 163  
 graduate 169  
 graduate *v* 26  
 graduation ceremony 169  
 graft *v* 91  
 grains 130  
 gram 310  
 grandchildren 23  
 granddaughter 22  
 grandfather 22  
 grandmother 22  
 grandparents 23  
 grandson 22  
 granite 288  
 grape juice 144  
 grapefruit 126  
 grapes 51, 134  
 graphite 289  
 grass 86, 262  
 grass bag 88  
 grasshopper 295  
 grassland 285  
 grate *v* 67  
 grated cheese 136  
 grater 68  
 gratin dish 69  
 gravel 88  
 gravity 280  
 gray 39, 274  
 graze 46  
 greasy 39  
 Greece 316  
 green 129, 232, 274  
 green olive 143  
 green onion 125  
 green peas 131  
 green salad 158  
 green tea 149  
 greenhouse 85  
 Greenland 314  
 Grenada 314  
 grill pan 69  
 grilled 159  
 grip 78  
 groceries 106  
 grocery store 114  
 groin 12  
 groom 243  
 ground 60, 132  
 ground coffee 144  
 ground cover 87  
 ground floor 104  
 ground meat 119  
 ground sheet 267  
 groundnut oil 135  
 group therapy 55  
 grout 83  
 guard 236  
 guard rail 195, 246  
 Guatemala 314  
 guava 128  
 guest 64, 100  
 guidebook 260  
 guided tour 260  
 guilty 181  
 Guinea 317  
 Guinea-Bissau 317  
 guitarist 258  
 gull 292  
 gum 50  
 gumdrop 113  
 gun 94  
 gutter 58, 299  
 guy rope 266  
 Guyana 315  
 gym 101, 250  
 gym machine 250  
 gymnast 235  
 gymnastics 235  
 gynecologist 52  
 gynecology 49  
 gypsophila 110
- H**  
 hacksaw 81  
 haddock 120  
 hail 286  
 hair 14, 38  
 hair dye 40  
 hairband 38  
 hairdresser 38, 115, 188  
 hair-dryer 38  
 hairpin 38  
 hairspray 38

- Haiti 314  
 half an hour 304  
 half-board 101  
 half-time 223  
 half-liter 311  
 halibut fillets 120  
 Halloween 27  
 hallway 59  
 halter 243  
 halter neck 35  
 ham 119, 143, 156  
 hammer 80  
 hammer v 79  
 hammock 266  
 hamper 263  
 hamster 290  
 hamstring 16  
 hand 13, 15  
 hand drill 81  
 hand fork 89  
 hand rail 59  
 hand saw 89  
 hand towel 73  
 handbag 37  
 handcuffs 94  
 handicap 233  
 handkerchief 36  
 handle 36, 88, 106, 187,  
     200, 230  
 handlebar 207  
 handles 37  
 handrail 196  
 handsaw 80  
 handset 99  
 hang v 82  
 hang-glider 248  
 hang-gliding 248  
 hanging basket 84  
 hanging file 173  
 happy 25  
 harbor 217  
 harbor master 217  
 hard 129, 321  
 hard candy 113  
 hard cheese 136  
 hard drive 176  
 hard hat 186  
 hard shoulder 194  
 hardboard 79  
 hardware 176  
 hardware store 114  
 hardwood 79  
 haricot beans 131  
 harness race 243  
 harp 256  
 harvest v 91, 183  
 hat 36  
 hatchback 199  
 have a baby v 26  
 Hawaii 314  
 hay 184  
 hayfever 44  
 hazard 195  
 hazard lights 201  
 hazelnut 129  
 hazelnut oil 134  
 head 12, 19, 81, 230  
 head v 222  
 head injury 46  
 headache 44  
 headboard 70  
 headlight 198, 205  
 headphones 268  
 headquarters 175  
 headrest 200  
 headsail 240  
 health 44  
 health food store 115  
 heart 18, 119, 122, 273  
 heart attack 44  
 heater 60  
 heater controls 201  
 heather 297  
 heating element 61  
 heavy 321  
 heavy metal 259  
 hedge 85, 90, 182  
 hedgehog 290  
 heel 13, 15, 37  
 height 165  
 height bar 45  
 helicopter 211  
 hello 322  
 helmet 95, 204, 206,  
     220, 224, 228  
 helpdesk 168  
 hem 34  
 hematite 289  
 hemorrhage 46  
 hen's egg 137  
 herb 55, 86  
 herb garden 84  
 herbaceous border 85  
 herbal remedies 108  
 herbal tea 149  
 herbalism 55  
 herbicide 183  
 herbs 133, 134  
 herbs and spices 132  
 herd 183  
 hexagon 164  
 high 321  
 high chair 75  
 high dive 239  
 high-heeled shoe 37  
 high jump 235  
 high speed train 208  
 highlights 39  
 hiking 263  
 hill 284  
 Himalayas 313  
 hip 12  
 hippopotamus 291  
 historic building 261  
 history 162  
 hit v 224  
 hockey 224  
 hockey stick 224  
 hoe 88  
 hold 215, 237  
 hole 232  
 hole in one 233  
 hole punch 173  
 holly 296  
 home 58  
 home delivery 154  
 home entertainment 268  
 home furnishings 105  
 home plate 228  
 homeopathy 55  
 homework 163  
 homogenized 137  
 Honduras 314  
 honeycomb 135  
 honeymoon 26  
 honeysuckle 297  
 hood 31, 75, 198  
 hoof 242, 291  
 hook 187, 276  
 hoop 226, 277  
 horizontal bar 235  
 hormone 20  
 horn 201, 204, 291  
 horror movie 255  
 horse 185, 235, 242  
 horse race 243  
 horseback riding 242,  
     263  
 horseradish 125  
 horseshoe 242  
 hose 89, 95  
 hose reel 89  
 hospital 48  
 host 64  
 hostess 64  
 hot 124, 286, 321  
 hot chocolate 144, 156  
 hot dog 155  
 hot-dog vendor 154  
 hot drinks 144  
 hot faucet 72  
 hot-air balloon 211  
 hotel 100, 264  
 hot-water bottle 70  
 hour 304  
 hour hand 304  
 house 58  
 household products 107  
 hovercraft 215  
 hub 206  
 hubcap 202  
 hull 214, 240  
 human resources 175  
 humerus 17  
 humid 286  
 hummingbird 292  
 hump 291  
 hundred 308  
 hundred and ten 308  
 hundred thousand 308  
 hundredth 309  
 Hungary 316  
 hungry 64  
 hurdles 235  
 hurricane 287  
 husband 22  
 husk 130  
 hydrant 95  
 hydrofoil 215  
 hydrotherapy 55  
 hypnosis 55  
 hypoallergenic 41  
 hypotenuse 164
- I**
- ice 120, 287  
 ice and lemon 151  
 ice bucket 150  
 ice climbing 247  
 ice cream 149  
 ice cube 151  
 ice hockey 224  
 ice hockey player 224  
 ice hockey rink 224  
 ice maker 67  
 ice cream 137  
 iced coffee 148  
 iced tea 149  
 ice-skate 224  
 ice-skating 247  
 icicle 287  
 icing 141  
 icon 177  
 identity tag 53  
 igneous 288  
 ignition 200  
 iguana 293  
 illness 44  
 immigration 212  
 impotent 20  
 in 320  
 in brine 143  
 in front of 320  
 in oil 143  
 in sauce 159  
 in syrup 159  
 inbox 177  
 inch 310  
 incisor 50  
 incubator 53  
 index finger 15  
 India 318  
 Indian Ocean 312  
 indigo 274  
 Indonesia 319  
 induce labor v 53  
 industrial park 299  
 infection 44  
 infertile 20  
 infield 228  
 inflatable dinghy 215  
 information 261  
 information screen 213  
 in-goal area 221  
 inhaler 44, 109  
 injection 48  
 injury 46  
 ink 275  
 ink pad 173  
 inlet 61  
 inner core 282  
 inner tube 207  
 inning 228  
 innocent 181  
 inoculation 45  
 insect repellent 108, 267  
 inside 320  
 insomnia 71  
 inspector 94  
 install v 177  
 instant camera 270  
 instep 15  
 instructions 109  
 instruments 256, 258  
 insulating tape 81  
 insulation 61  
 insulin 109  
 insurance 203  
 intensive care unit 48  
 interchange 194  
 intercom 59  
 intercostal 16  
 intercourse 20  
 interest rate 96  
 interior 200  
 internal systems 60  
 international flight 212  
 internet 177  
 intersection 298  
 interval 254  
 interviewer 179  
 into 320  
 in-tray 172  
 invertebrates 295  
 investigation 94  
 investment 97  
 ionosphere 286  
 Iran 318  
 Iraq 318  
 Ireland 316  
 iris 51, 110  
 iron 76, 109, 233, 289  
 iron v 76  
 ironing board 76  
 island 282  
 Israel 318  
 Italy 316  
 itinerary 260  
 IUD 21  
 Ivory Coast 317
- J**
- jack 203, 273  
 jacket 32, 34  
 jackhammer 187  
 jade 288  
 jam 134, 156  
 Jamaica 314  
 January 306  
 Japan 318

jar 134, 311  
 javelin 234  
 jaw 14, 17  
 jazz 259  
 jeans 31  
 jelly bean 113  
 jellyfish 295  
 Jerusalem artichoke 125  
 jet 288  
 jet-skiing 241  
 jetty 217  
 jeweler 188  
 jewelry store 114  
 jewelry 36  
 jewelry box 36  
 jewelry-making 275  
 jigsaw 78  
 jigsaw puzzle 273  
 jodhpurs 242  
 jog in place 251  
 jogging 251, 263  
 jogging suit 31, 32  
 joint 17, 119  
 joker 273  
 Jordan 318  
 journal 168  
 journalist 190  
 judge 180  
 judo 236  
 jug 65  
 juices and milkshakes 149  
 juicy 127  
 July 306  
 jumbo shrimp 121  
 jump 237, 243  
 jump v 227  
 jump ball 226  
 jumping rope 251  
 June 306  
 Jupiter 280  
 jury 180  
 jury box 180

**K**

kale 123  
 kangaroo 191  
 karate 236  
 Karliningrad 316  
 kayak 241  
 Kazakhstan 318  
 kebab 155, 158  
 keel 214  
 keep net 244  
 kendo 236  
 Kenya 317  
 kernel 122, 129, 130  
 ketchup 135, 154  
 kettle 66  
 kettledrum 257  
 key 59, 80, 176, 207  
 keyboard 172, 176, 258  
 keypad 97, 99  
 kick 237, 239

kick v 221, 223  
 kickboxing 236  
 kickstand 207  
 kid 185  
 kidney 18, 119  
 kilogram 310  
 kilometer 310  
 king 272, 273  
 kippers 157  
 kitchen 66, 152  
 kitchen knife 68  
 kitchenware 68, 105  
 kitten 290  
 kiwifruit 128  
 knead v 138  
 knee 12  
 knee pad 205  
 knee support 227  
 kneecap 17  
 knee-length 34  
 knife 65, 80  
 knife sharpener 68, 118  
 knight 272  
 knitting 277  
 knitting needle 277  
 knock out 237  
 knuckle 15  
 koala 291  
 kohlrabi 123  
 koi carp 294  
 kumquat 126  
 kung fu 236  
 Kuwait 318  
 Kyrgyzstan 318

**L**

label 172  
 labels 89  
 labia 20  
 laboratory 166  
 lace 35, 37  
 lace bobbin 277  
 lace-making 277  
 lace-up 37  
 lacrosse 249  
 lactose 137  
 ladder 95, 186  
 ladle 68  
 lady fingers 141  
 ladybug 295  
 lake 285  
 lamb 118, 185  
 lamp 62, 207, 217  
 land 282  
 land v 211  
 landing 59  
 landing gear 210  
 landing net 244  
 landlord 58  
 landscape 271, 284  
 landscape v 91  
 lane 234, 238  
 languages 162  
 Laos 318

lapel 32  
 laptop 175  
 larch 296  
 large 321  
 large intestine 18  
 larynx 19  
 last week 307  
 lat 16  
 late 305  
 later 304  
 latex paint 83  
 latitude 283  
 Latvia 316  
 laugh v 25  
 launch 281  
 launch pad 281  
 laundromat 115  
 laundry 76  
 laundry basket 76  
 laundry service 101  
 lava 283  
 law 169, 180  
 lawn 85, 90  
 lawn rake 88  
 lawnmower 88, 90  
 lawyer 180, 190  
 lawyer's office 180  
 laxative 109  
 lead singer 258  
 leaded 199  
 leaf 122, 296  
 league 223  
 lean meat 118  
 learn v 163  
 leather shoe 37  
 leather shoes 32  
 leathers 205  
 Lebanon 318  
 lecture hall 169  
 leek 125  
 left 260  
 left field 228  
 left-hand drive 201  
 leg 12, 119  
 leg pad 225  
 leg press 251  
 legal advice 180  
 legal department 175  
 leggings 31  
 legumes 130  
 leisure 258, 254, 264  
 lemon 126  
 lemon curd 134  
 lemon grass 133  
 lemon sole 120  
 lemonade 144  
 length 165, 310  
 lens 270  
 lens (eye) 51  
 lens (glasses) 51  
 lens cap 270  
 lens case 51  
 Lesotho 317  
 lesson 163

let! 231  
 letter 98  
 letter slot 58, 99  
 letterhead 173  
 lettuce 123  
 level 80, 187  
 lever 61, 150  
 Liberia 317  
 librarian 168, 190  
 library 168, 299  
 library card 168  
 Libya 317  
 license plate 198  
 liquor store 115  
 licorice 113  
 lid 61, 66  
 Liechtenstein 316  
 life events 26  
 life jacket 240  
 life preserver 240  
 life raft 240  
 lifeboat 214  
 lifeguard 239, 265  
 lifeguard tower 265  
 ligament 17  
 light 178, 321  
 light a fire v 266  
 light aircraft 211  
 light bulb 60  
 lighter 112  
 lighthouse 217  
 lighting 105  
 lightmeter 270  
 lightning 287  
 lights 94  
 lights switch 201  
 lily 110  
 lime 126, 296  
 limestone 288  
 limousine 199  
 line 244  
 line judge 220  
 line of play 233  
 linen 105, 277  
 linen basket 76  
 linen 165  
 linesman 223, 230  
 lingerie 35, 105  
 lining 32  
 lining paper 83  
 link 36  
 lintel 186  
 lion 291  
 lip 14  
 lip brush 40  
 lip gloss 40  
 lip liner 40  
 lipstick 40  
 liqueur 145  
 liquid 77  
 liquid dispenser 311  
 liquid measure 311  
 liter 311  
 literature 162, 169

Lithuania 316  
 little finger 15  
 little toe 15  
 live 60, 178  
 live rail 209  
 liver 18, 118  
 livestock 183, 185  
 living room 62  
 lizard 293  
 load v 76  
 load line 214  
 loaf 139  
 loan 96, 168  
 load 230  
 lobby 100, 255  
 lobster 121, 295  
 lock 59, 207  
 lockers 239  
 log on v 177  
 loganberry 127  
 logo 31  
 loin 121  
 lollipop 113  
 long 32  
 long jump 235  
 long wave 179  
 long-grain 130  
 long-handled shears 88  
 longitude 283  
 loofah 73  
 loom 277  
 loose tea 144  
 lose v 273  
 loser 273  
 lotion 109  
 lottery tickets 112  
 love 230  
 low 321  
 luge 247  
 luggage 100, 198, 213  
 luggage department 104  
 luggage hold 196  
 luggage rack 209  
 lumbar vertebrae 17  
 lunar module 281  
 lunch 64  
 lunch menu 152  
 lung 18  
 lunge 251  
 lupines 297  
 lure 244  
 Luxembourg 316  
 lychee 128  
 lymphatic 19  
 lyrics 259

**M**

macadamia 129  
 mace 132  
 Macedonia 316  
 machine gun 189  
 machinery 187  
 mackerel 120  
 macramé 277



- Madagascar 317  
 magazine 112  
 magazines 107  
 magma 283  
 magnesium 109  
 magnet 167  
 maid service 101  
 mail carrier 98, 190  
 mailbag 98, 190  
 mailbox 99  
 mainsail 240  
 make a will v 26  
 make friends v 26  
 make the bed v 71  
 makeup 40  
 making bread 138  
 malachite 288  
 Malawi 317  
 Malaysia 318  
 Maldives 318  
 male 12, 21  
 Mali 317  
 mallet 78, 275  
 malt vinegar 135  
 Malta 316  
 malted drink 144  
 mammals 290  
 man 23  
 manager 24, 174  
 manchego 142  
 mane 242, 291  
 mango 128  
 mangosteen 128  
 manhole 299  
 manicure 41  
 mantelpiece 63  
 mantle 282  
 manual 200  
 map 195, 261  
 maple 296  
 maple syrup 134  
 maracas 257  
 marathon 234  
 marble 288  
 March 306  
 margarine 137  
 marina 217  
 marinated 143, 159  
 marine fishing 245  
 marjoram 133  
 mark v 227  
 market 115  
 marketing department 175  
 marmalade 134, 156  
 marrow 124  
 Mars 280  
 marshmallow 113  
 martial arts 237  
 martini 151  
 marzipan 141  
 mascara 40  
 mashed 159  
 masher 68  
 mask 189, 228, 236, 239, 249  
 masking tape 83  
 masonry bit 80  
 massage 54  
 mast 240  
 masters 169  
 mat 54, 83, 235, 271  
 match 230  
 matches 112  
 material 276  
 materials 79, 187  
 maternity 49  
 maternity ward 48  
 math 162, 164  
 mattress 70, 74  
 Mauritania 317  
 Mauritius 317  
 May 306  
 maybe 322  
 mayonnaise 135  
 MDF 79  
 meadow 285  
 meal 64  
 measles 44  
 measure 150, 151  
 measure v 310  
 measurements 165  
 measuring cup 69, 311  
 measuring spoon 109  
 meat 119  
 meat and poultry 106  
 meat tenderizer 68  
 meatballs 158  
 meathook 118  
 mechanic 188, 203  
 mechanics 202  
 medals 235  
 media 178  
 medical examination 45  
 medication 109  
 medicine 109, 169  
 medicine cabinet 72  
 meditation 54  
 Mediterranean Sea 313  
 medium wave 179  
 meeting 174  
 meeting room 174  
 melody 259  
 melon 127  
 memory 176  
 men's clothing 32  
 menswear 105  
 menstruation 20  
 menu 148, 153, 154  
 menu bar 177  
 mercury 289  
 Mercury 280  
 meringue 140  
 mesosphere 286  
 messages 100  
 metacarpal 17  
 metal 79  
 metal bit 80  
 metals 289  
 metamorphic 288  
 metatarsal 17  
 meteor 280  
 meter 310  
 Mexico 314  
 mica 289  
 microphone 179, 258  
 microscope 167  
 microwave oven 66  
 midday 305  
 middle finger 15  
 midnight  
 midwife 53  
 migraine 44  
 mile 310  
 milk 136, 156  
 milk v 183  
 milk carton 136  
 milk chocolate 113  
 milkshake 137  
 millennium 307  
 millet 130  
 milligram 310  
 milliliter 311  
 millimeter 310  
 mineral 144  
 mineral spirits 83  
 minerals 289  
 mini bar 101  
 mini disc recorder 268  
 minibus 197  
 minivan 199  
 mini-dress 34  
 mint 113, 133  
 mint tea 149  
 minus 165  
 minute 304  
 minute hand 304  
 minutes 174  
 mirror 40, 63, 71, 167  
 miscarriage 52  
 Miss 23  
 missile 211  
 mist 287  
 miter block 81  
 mitt 228  
 mittens 30  
 mix v 67, 138  
 mixing bowl 66, 69  
 mixing desk 179  
 moat 300  
 mobile 74  
 model 169, 190  
 model-making 275  
 modeling tool 275  
 modem 176  
 moisturizer 41  
 molar 50  
 Moldova 316  
 mole 14  
 Monaco 316  
 Monday 306  
 money 97  
 money order 98  
 Mongolia 318  
 monitor 172, 176  
 monitor 53  
 monkey 291  
 monkfish 120  
 monopoly 272  
 monorail 208  
 monsoon 287  
 month 306  
 monthly 307  
 monument 261  
 Moon 280  
 moonstone 288  
 moor v 217  
 mooring 217  
 mop 77  
 morning 305  
 Morocco 317  
 mortar 68, 167, 187  
 mortgage 96  
 mosque 300  
 mosquito 295  
 mosquito net 267  
 moth 295  
 mother 22  
 mother-in-law 23  
 motocross 249  
 motor 88  
 motor racing 249  
 motorcycle 204  
 motorcycle racing 249  
 molding 63  
 mountain 284  
 mountain bike 206  
 mountain range 282  
 mouse 176, 290  
 mousse 141  
 mouth 14  
 mouth guard 237  
 mouthwash 72  
 move 273  
 movie 260, 271  
 movie set 179  
 movie theater 255, 299  
 mow v 90  
 Mozambique 317  
 mozzarella 142  
 MP3 player 268  
 Mr. 23  
 Mrs. 23  
 mudguard 205  
 muffin 140  
 muffin pan 69  
 muffler 203, 204  
 mug 65  
 mulch v 91  
 multigrain bread 139  
 multiply v 165  
 multivitamin tablets 109  
 mumps 44  
 mung beans 131  
 muscles 16  
 museum 261  
 mushroom 125  
 music 162  
 music school 169  
 musical 255  
 musical score 255  
 musical styles 259  
 musician 191  
 mussel 121, 295  
 mustard 155  
 mustard seed 131  
 Myanmar 318

## N

- naan bread 139  
 nail 15, 80  
 nail clippers 41  
 nail file 41  
 nail polish 41  
 nail polish remover 41  
 nail scissors 41  
 Namibia 317  
 nape 13  
 napkin 65, 152  
 napkin ring 65  
 narrow 321  
 nation 315  
 national park 261  
 natural 256  
 natural fiber 31  
 naturopathy 55  
 nausea 44  
 navel 12  
 navigate v 240  
 near 320  
 nearsightedness 51  
 nebula 280  
 neck 12, 258  
 neck brace 46  
 necklace 36  
 neckline 34  
 nectarine 126  
 needle 109, 276  
 needle plate 276  
 needlenose pliers 80  
 needlepoint 277  
 negative 271  
 negative electrode 167  
 negligée 35  
 neighbor 24  
 neoclassical 301  
 Nepal 318  
 nephew 23  
 Neptune 280  
 nerve 19, 50  
 nervous 19, 25  
 net 217, 222, 226, 227, 231  
 net v 245  
 net curtain 63  
 Netherlands 316  
 nettle 297  
 network 176  
 neurology 49  
 neutral 60

- neutral zone 224  
 new 321  
 new moon 280  
 new potato 124  
 New Year 27  
 New Zealand 319  
 newborn baby 53  
 news 178  
 newscaster 179, 191  
 newspaper 112  
 newsstand 112  
 next week 306  
 nib 163  
 Nicaragua 314  
 nickel 289  
 niece 23  
 Niger 317  
 Nigeria 317  
 night 305  
 nightgown 35  
 nightie 31  
 nightwear 31  
 nightstand 70  
 nightstick 94  
 nine 308  
 nine hundred 308  
 nineteen 308  
 nineteen hundred 307  
 nineteen hundred and one 307  
 nineteen ten 307  
 nineteenth 309  
 ninetieth 309  
 ninety 308  
 ninth 309  
 nipple 12  
 no 322  
 no entry 195  
 no right turn 195  
 no stopping 195  
 nonsmoking section 152  
 nonstick 69  
 noodles 158  
 normal 39  
 north 312  
 North and Central America 314  
 North Korea 318  
 North Pole 283  
 North Sea 312  
 Northern Hemisphere 283  
 Norway 316  
 nose 14, 210  
 nose clip 238  
 noseband 242  
 nosebleed 44  
 nosewheel 210  
 nostril 14  
 notation 256  
 note 97, 256  
 notecard 173  
 notepad 173  
 notebook 163, 172
- notes 175, 191  
 notice board 173  
 notions 105  
 nougat 113  
 November 306  
 now 304  
 nozzle 89  
 number 226  
 numbers 308  
 numerator 165  
 nurse 45, 48, 52, 189  
 nursery 74  
 nursing 53  
 nursing bra 53  
 nut 80  
 nutmeg 132  
 nuts 151  
 nuts and dried fruit 129  
 nylon 277
- O**  
 oak 296  
 oar 241  
 oatmeal 156  
 oats 130  
 objective lens 167  
 oboe 257  
 obsidian 288  
 obstetrician 52  
 occupations 188, 190  
 occupied 321  
 ocean 282  
 ocean liner 215  
 octagon 164  
 October 306  
 octopus 121, 295  
 odometer 201  
 ofal 118  
 offers 106  
 office 24, 172, 174  
 office building 298  
 office equipment 172  
 office supplies 173  
 off-piste 247  
 off-side 223  
 oil 142, 199  
 oil paints 274  
 oil tank 204  
 oil tanker 215  
 oils 134  
 oily 41  
 ointment 47, 109  
 okra 122  
 old 321  
 olive oil 134  
 olives 151  
 Oman 318  
 omelet 158  
 on time 305  
 on top of 320  
 oncology 49  
 one 308  
 one billion 309  
 one million 309
- one thousand 309  
 one-way 194  
 one-way system 298  
 onion 124  
 on-line 177  
 onto 320  
 onyx 289  
 opal 288  
 open 260, 321  
 open sandwich 155  
 open-top 260  
 opera 255  
 operating room 48  
 operation 48  
 operator 99  
 ophthalmology 49  
 opponent 236  
 opposite 320  
 optic 150  
 optic nerve 51  
 optician 51, 189  
 orange 126, 274  
 orange juice 148  
 orangeade 144  
 orbit 280  
 orchestra 254, 256  
 orchestra pit 254  
 orchid 111  
 order v 153  
 organo 133  
 organic 91, 118, 122  
 organic waste 61  
 organizer 175  
 origami 275  
 ornamental 87  
 orthopedics 49  
 osteopathy 54  
 ostrich 292  
 otter 290  
 ounce 310  
 out 225, 228, 320  
 out of bounds 226  
 out of focus 271  
 outboard motor 215  
 outbuilding 182  
 outdoor activities 262  
 outer core 282  
 outfield 229  
 outlet 61  
 outpatient 48  
 outside 320  
 out-tray 172  
 oval 164  
 ovary 20  
 oven 66  
 oven mitt 69  
 ovenproof 69  
 over 320  
 over par 233  
 overalls 30, 82  
 overdraft 96  
 overexposed 271  
 overflow pipe 61  
 overhead bin 210
- overhead projector 163  
 overpass 194  
 overture 256  
 ovulation 20, 52  
 owl 292  
 oyster 121  
 ozone layer 286
- P**  
 Pacific Ocean 312  
 pack 311  
 pack of cigarettes 112  
 package 99, 311  
 pad 224  
 paddle 241  
 paddock 242  
 pads 53, 220  
 painkiller 109  
 painkillers 47  
 pail 77, 82, 265  
 paint 83  
 paint v 83  
 paint can 83  
 paint tray 83  
 painter 191  
 painting 62, 261, 274  
 paints 274  
 pajamas 33  
 pak-choi 123  
 Pakistan 318  
 palate 19  
 palette 274  
 pallet 186  
 palm 15, 86, 296  
 palm hearts 122  
 palmtop 175  
 pan 310  
 pan-fried 159  
 Panama 314  
 pancreas 18  
 panda 291  
 panties 35  
 pants 32, 34  
 panty liner 108  
 papaya 128  
 paper clip 173  
 paper guide 172  
 paper napkin 154  
 paper tray 172  
 papier-maché 275  
 paprika 132  
 Papua New Guinea 319  
 par 233  
 parachute 248  
 parachuting 248  
 paragliding 248  
 Paraguay 315  
 parallel 165  
 parallel bars 235  
 parallelogram 164  
 paramedic 94  
 parents 23  
 park 262  
 park v 195
- parka 31, 33  
 parking brake 203  
 parking meter 195  
 parking lot 298  
 parmesan 142  
 parole 181  
 parrot 293  
 parsley 133  
 parsnip 125  
 partner 23  
 pass 226  
 pass v 195, 220, 223  
 passenger 216  
 passenger port 216  
 passion fruit 128  
 Passover 27  
 passport 213  
 passport control 213  
 pasta 158  
 pastels 274  
 pasteurized 137  
 pasting brush 82  
 pasting table 82  
 pastry 140, 149  
 pastry brush 69  
 pasture 182  
 patch 207  
 patchwork 277  
 pâté 142, 156  
 path 58, 85  
 pathology 49  
 patient 45  
 patio garden 85  
 pattern 276  
 pause 269  
 paving 85  
 pawn 272  
 pay v 153  
 pay-per-view channel 269  
 payment 96  
 payroll 175  
 peach 126, 128  
 peacock 293  
 peanut 129  
 peanut butter 135  
 peanuts 151  
 pear 127  
 peas 131  
 pecan 129  
 pectoral 16  
 pectoral fin 294  
 pedal 61, 206  
 pedal v 207  
 pedestrian zone 299  
 pediatrics 49  
 pedicure 41  
 pediment 301  
 peel v 67  
 peeled shrimp 120  
 pelican 292  
 pelvis 17  
 pen 163, 185  
 pen holder 172

- pen pal 24  
penalty 222  
penalty area 223  
pencil 163, 275  
pencil case 163  
pencil sharpener 163  
pendant 36  
penguin 292  
peninsula 282  
penis 21  
pentagon 164  
peony 111  
people 12, 16  
pepper 64, 124, 152  
peppercorn 132  
pepperoni 142  
percentage 165  
percussion 257  
perennial 86  
perfume 41, 105  
pergola 84  
periodical 168  
perm 39  
perpendicular 165  
persimmon 128  
personal best 234  
personal CD player 269  
personal organizer 173, 175  
personal trainer 250  
Peru 315  
pesticide 89, 183  
pestle 68, 167  
pet food 107  
pet store 115  
petal 297  
petri dish 166  
pharmacist 108, 189  
pharmacy 108  
pharynx 19  
pheasant 119, 293  
Phillips screwdriver 81  
philosophy 169  
Philippines 319  
photo album 271  
photo finish 234  
photographer 191  
photograph 271  
photograph v 271  
photography 270  
phyllo pastry 140  
physical education 162  
physics 162, 169  
physiotherapy 49  
piano 256  
piccolo 257  
pick v 91  
pick-and-mix 113  
pickax 187  
pickled 159  
pickup 258  
picnic 263  
picnic bench 266  
picture frame 271  
pie 158  
pie pan 69  
piece 272  
pier 217  
pies 143  
pig 185  
pig farm 183  
pigeon 292  
pigeonhole 100  
piglet 185  
pigsty 185  
pigtails 39  
Pilates 251  
pill 21, 109  
pillar 300  
pillion 204  
pillow 70  
pillowcase 71  
pilot 190, 211  
pin 60, 237, 249, 276  
PIN 96  
pincushion 276  
pine 296  
pine nut 129  
pineapple 128  
pineapple juice 149  
pink 274  
pint 311  
pinto beans 131  
pipe 112, 202  
pipe cutter 81  
pipette 167  
piping bag 69  
pistachio 129  
pita bread 139  
pitch v 229  
pitch a tent v 266  
pitcher 151, 229  
pitcher's mound 228  
pitches available 266  
pith 126  
pizza 154  
pizzeria 154  
place mat 64  
place setting 65  
placenta 52  
plain 285  
plane 81  
plane v 79  
planet 280, 282  
plant v 183  
plant pot 89  
plants 86, 296  
plaque 50  
plaster v 82  
plastic bag 122  
plastic pants 30  
plastic surgery 49  
plate 283  
plateau 284  
platform 208  
platform number 208  
platform shoe 37  
platinum 289  
play 254, 269  
play v 229, 273  
player 221, 231, 273  
playground 263  
playhouse 75  
playing 75  
playpen 75  
plea 180  
please 322  
plow v 183  
plug 60, 72  
plum 126  
plumb line 82  
plumber 188  
plumbing 61  
plunger 81  
plus 165  
Pluto 280  
plywood 79  
poach v 67  
poached 159  
pocket 32  
pod 122  
podium 235, 256  
point 273  
poisoning 46  
poker 273  
Poland 316  
polar bear 291  
pole 245, 282  
pole vault 234  
police 94  
police car 94  
police officer 94, 189  
police station 94  
polish 77  
polish v 77  
politics 169  
polo 243  
polyester 277  
pomegranate 128  
pommel 242  
pommel horse 235  
pond 85  
ponytail 39  
pool 249  
pop 259  
popcorn 255  
poplar 296  
popper 30  
poppy 297  
poppy seeds 138  
porch 58  
porch light 58  
pore 15  
pork 118  
port 145, 176, 214, 216  
porter 100  
portfolio 97  
porthole 214  
portion 64  
portrait 271  
Portugal 316  
positive electrode 167  
post office 98  
postage 98  
postal worker 98  
postcard 112  
poster 255  
poster paint 274  
postgraduate 169  
postmark 98  
pot v 91  
potato 124  
potpourri 111  
potted plant 87, 110  
potter's wheel 275  
pottery 275  
potty 74  
pouch 291  
poultry 119  
poultry farm 183  
pound 310  
pour v 67  
powder 77, 109  
powder puff 40  
powdered milk 137  
power 60  
power cord 176  
power outage 60  
practice swing 233  
pram 75  
praying mantis 295  
pregnancy 52  
pregnancy test 52  
pregnant 52  
premature 52  
premolar 50  
prenatal 52  
prerecorded 178  
prescription 45  
present 27  
presentation 174  
presenter 178  
preservative 83  
preserved fruit 134  
press 178  
presser foot 276  
pressure valve 61  
price 152, 199  
price list 154  
prickly pear 128  
primer 83  
primrose 297  
principal 163  
principality 315  
print 271  
print v 172  
printer 172, 176  
printing 275  
prison 181  
prison guard 181  
private bathroom 100  
private jet 211  
private room 48  
probe 50  
problems 271  
processed grains 130  
procession 27  
processor 176  
produce stand 114, 188  
producer 254  
professor 169  
program 176  
program 254, 269  
programming 178  
projector 174  
propagate v 91  
propeller 211, 214  
proposal 174  
prosciutto 143  
pottery 180  
prostate 21  
protractor 165  
proud 25  
prove v 139  
province 315  
prow 215  
prune 129  
prune v 91  
pruners 89  
psychiatry 49  
psychotherapy 55  
public address system 209  
puck 224  
pudding rice 130  
Puerto Rico 314  
puff pastry 140  
pull up v 251  
pulp 127  
pulse 47  
pumice 288  
pumice stone 73  
pump 207  
pumpkin 125  
pumpkin seed 131  
punch 237  
punching bag 237  
pup 290  
pupil 51, 162  
puppy 290  
purple 274  
pushup 251  
purse 37  
putt v 233  
putter 233  
pyramid 164
- Q**  
Qatar 318  
quadriceps 16  
quail 119  
quail egg 137  
quart 311  
quarter of an hour 304  
quarterdeck 214  
quartz 289  
queen 272, 273  
question 163  
question v 163  
quiche pan 69

quilt 71  
 quilting 277  
 quince 128  
 quinoa 130  
 quiver 249

**R**

rabbit 118, 290  
 raccoon 290  
 race 234  
 race-car driver 249  
 racecourse 243  
 racehorse 243  
 racing bike 205, 206  
 racing dive 239  
 rack 166  
 racket 230  
 racket games 231  
 racquetball 231  
 radar 214, 281  
 radiator 60, 202  
 radicchio 123  
 radio 179, 268  
 radio antenna 214  
 radio station 179  
 radiology 49  
 radish 124  
 radius 17, 164  
 rafter 186  
 rafting 241  
 rail 208  
 rail network 209  
 rain 287  
 rain gear 245, 267  
 rainbow 287  
 rainbow trout 120  
 raincoat 31, 32  
 rainforest 285  
 raisin 129  
 rake 88  
 rake v 90  
 rally 230  
 rally driving 249  
 RAM 176  
 Ramadan 26  
 ramekin 69  
 range 67  
 rap 259  
 rapeseed 184  
 rapids 240, 284  
 rappelling 248  
 rash 44  
 raspberry 127  
 raspberry jam 134  
 rat 290  
 rattle 74  
 raw 124, 129  
 ray 294  
 razor blade 73  
 razorshell clam 121  
 read v 162  
 reading light 210  
 reading list 168  
 reading room 168

reamer 80  
 rear light 207  
 rear wheel 197  
 rearview mirror 198  
 receipt 152  
 receive v 177  
 receiver 99  
 reception 100  
 receptionist 100, 190  
 record 234, 269  
 record player 268  
 record store 115  
 recording studio 179  
 rectangle 164  
 rectum 21  
 recycling bin 61  
 red 145, 274  
 red card 223  
 red-eye 271  
 red kidney beans 131  
 red lentils 131  
 red meat 118  
 red mullet 120  
 Red Sea 313  
 reduce v 172  
 reduced-fat milk 136  
 reel 244  
 reel in v 245  
 referee 222, 226  
 referral 49  
 reflector 50, 204, 207  
 reflector strap 205  
 reflexology 54  
 refrigerator 67  
 reggae 259  
 region 315  
 register 100  
 registered mail 98  
 regulator 239  
 reheat v 154  
 reiki 55  
 reins 242  
 relationships 24  
 relatives 23  
 relaxation 55  
 relay race 235  
 release v 245  
 remote control 269  
 Renaissance 301  
 renew v 168  
 rent 58  
 rent v 58  
 repair kit 207  
 report 174  
 reporter 179  
 reproduction 20  
 reproductive 19  
 reproductive organs 20  
 reptiles 293  
 research 169  
 reserve v 168  
 residence hall 168  
 respiratory 19  
 rest 256

restaurant 101, 152  
 result 49  
 resurfacing 187  
 resuscitation 47  
 retina 51  
 retire v 26  
 return 231  
 return address 98  
 return date 168  
 rewind 269  
 rhinoceros 291  
 rhombus 164  
 rhubarb 127  
 rhythmic gymnastics 235  
 rib 17, 119  
 rib cage 17  
 ribbon 27  
 ribbon 39, 111, 141, 235  
 ribs 155  
 rice 130, 158, 184  
 rice pudding 140  
 rider 242  
 riding boot 242  
 riding crop 242  
 riding hat 242  
 rigging 215, 240  
 right 260  
 right field 229  
 right-hand drive 201  
 rim 206  
 rind 119, 127, 136, 142  
 ring 36  
 ring binder 173  
 ring finger 15  
 ring ties 89  
 rings 235  
 rinse v 38, 76  
 ripe 129  
 rise v 139  
 river 284  
 road bike 206  
 road markings 194  
 road signs 195  
 roads 194  
 road work 187, 195  
 roast 158  
 roast v 67  
 roasted 129  
 roasting pan 69  
 robe 38, 169  
 rock climbing 248  
 rock concert 258  
 rock garden 84  
 rocket 123  
 rocks 284, 288  
 Rocky Mountains 312  
 rococo 301  
 rodeo 243  
 roll 139, 311  
 roll v 67  
 roller 83, 187  
 roller coaster 262  
 roller shade 63  
 roller skating 249

rollerblading 263  
 rollerskate 249  
 rolling pin 69  
 romance 255  
 Romania 316  
 romper 30  
 roof 58, 203  
 roof garden 84  
 roof tile 187  
 roof rack 198  
 rook 272  
 room 58  
 room key 100  
 room number 100  
 room service 101  
 rooms 100  
 rooster 185  
 root 50, 124, 296  
 roots 39  
 rope 248  
 rose 89, 110, 145  
 rosé 145  
 rosemary 133  
 rotor blade 211  
 rotten 127  
 rough 232  
 round 237  
 round neck 33  
 roundabout 195  
 route number 196  
 router 78  
 row 210, 254  
 row v 241  
 rower 241  
 rowboat 214  
 rowing machine 250  
 rubber band 173  
 rubber boots 89  
 rubber ring 265  
 rubber stamp 173  
 ruby 288  
 ruck 221  
 rudder 210, 241  
 rug 63  
 rugby 221  
 ruler 163, 165  
 rum 145  
 rum and coke 151  
 rump steak 119  
 run 228  
 run v 228  
 runway 212  
 rush 86  
 rush hour 209  
 Russian Federation 318  
 rutabaga 125  
 Rwanda 317  
 rye bread 138

**S**

sad 25  
 saddle 206, 242  
 safari park 262  
 safe 228

safety 75, 240  
 safety goggles 81, 167  
 safety pin 47  
 saffron 132  
 sage 133  
 Sahara Desert 313  
 sail 241  
 sailboat 215  
 sailing 240  
 sailor 189  
 salad 149  
 salamander 294  
 salami 142  
 salary 175  
 sales clerk 104, 188  
 sales department 175  
 salmon 120  
 salt 64, 152  
 salted 121, 129, 137, 143  
 San Marino 316  
 sand 85, 264  
 sand v 82  
 sandal 37  
 sandals 31  
 sandbox 263  
 sandcastle 265  
 sander 78  
 sandpaper 81, 83  
 sandstone 288  
 sandwich 155  
 sandwich counter 143  
 sanitary napkin 108  
 São Tomé and Príncipe 317  
 sapphire 288  
 sardine 120  
 Sardinia 316  
 satellite 281  
 satellite dish 269  
 satellite navigation 201  
 satsuma 126  
 Saturday 306  
 Saturn 280  
 sauce 134, 143, 155  
 saucepan 69  
 Saudi Arabia 318  
 sauna 250  
 sausage 155, 157  
 sausages 118  
 sauté v 67  
 save v 177, 223  
 savings 96  
 savings account 97  
 savory 155  
 saw v 79  
 saxophone 257  
 scaffolding 186  
 scale 121, 256, 294  
 scales 45, 53, 69, 98, 118, 166, 212, 293, 310  
 scallop 121  
 scalp 39

- scalpel 167  
scan 48, 52  
scanner 106, 176  
scarecrow 184  
scared 25  
scarf 31, 36  
schedule 197, 209, 261  
schist 288  
scholarship 169  
school 162, 299  
school bus 196  
school uniform 162  
schoolbag 162  
schoolboy 162  
schoolgirl 162  
schools 169  
science 162, 166  
science fiction movie  
255  
scientist 190  
scissors 38, 47, 82, 188,  
276  
scoop 68, 149  
scooter 205  
score 220, 256, 273  
score a goal *v* 223  
scoreboard 225  
scorpion 295  
scotch and water 151  
scrabble 272  
scrambled eggs 157  
scrape *v* 77  
scraper 82  
screen 59, 63, 97, 176,  
255, 269  
screw 80  
screwdriver 80, 151  
screwdriver bits 80  
script 254  
scrollbar 177  
scrotum 21  
scrub *v* 77  
scrum 221  
scuba diving 239  
sculpting 275  
sculptor 191  
sea 264, 282  
sea bass 120  
sea bream 120  
sea horse 294  
sea lion 290  
sea plane 211  
seafood 121  
seal 290  
sealant 83  
sealed jar 135  
seam 34  
seamstress 191  
search *v* 177  
seasonal 129  
seasons 306  
seat 61, 204, 209, 210,  
242, 254  
seat back 210  
seat belt 198, 211  
seat post 206  
seating 254  
second 304, 309  
second floor 104  
second-hand 304  
second-hand store 115  
section 282  
security 212  
security bit 80  
security guard 189  
sedan 199  
sedative 109  
sedimentary 288  
seed 122, 127, 128, 130  
seed tray 89  
seeded bread 139  
seedless 127  
seedling 91  
seeds 88, 131  
seesaw 263  
segment 126  
self-defense 237  
self-rising flour 139  
self-tanning cream 41  
semi-hard cheese 136  
seminal vesicle 21  
semi-soft cheese 136  
semisweet chocolate  
113  
semolina 130  
send *v* 177  
send off 223  
Senegal 317  
sensitive 41  
sentence 181  
September 306  
series 179  
serve 231  
serve *v* 64, 231  
server 176  
service included 152  
service line 230  
service not included 152  
service provider 177  
service vehicle 212  
serving spoon 68  
sesame seed 131  
sesame oil 134  
set 178, 230, 254  
set *v* 38  
set honey 134  
set sail *v* 217  
set the alarm *v* 71  
set the table *v* 64  
seven 308  
seven hundred 308  
seventeen 308  
seventeenth 309  
seventh 309  
seventieth 309  
seventy 308  
sew *v* 277  
sewing basket 276  
sewing machine 276  
sexually transmitted  
disease 20  
shade 41  
shade plant 87  
shallot 125  
shallow end 239  
shampoo 38  
shapes 164  
share price 97  
shares 97  
shark 294  
sharp 256  
shaving 73  
shaving foam 73  
shears 89  
shed 84  
sheep 185  
sheep farm 183  
sheep's milk 137  
sheet 71, 74, 241  
shelf 67, 106  
shell 129, 137, 265, 293  
shelled 129  
shelves 66  
sherbet 141  
sherry 145  
shiatsu 54  
shield 88  
shin 12  
ship 214  
ships 215  
shipyard 217  
shirt 32  
shock 47  
shocked 25  
shoe department 104  
shoe store 114  
shoes 34, 37  
shoot *v* 223, 227  
shop 298  
shopping 104  
shopping bag 106  
shopping center 104  
shops 114  
short 32, 321  
short wave 179  
short-grain 130  
shorts 30, 33  
shot 151  
shotput 234  
shoulder 13  
shoulder bag 37  
shoulder blade 17  
shoulder pad 35  
shoulder strap 37  
shout *v* 25  
shovel 187  
shower 72, 286  
shower block 266  
shower curtain 72  
shower door 72  
shower gel 73  
shower head 72  
showjumping 243  
shuffle *v* 273  
shutoff valve 61  
shutter 58  
shutter release 270  
shutter-speed dial 270  
shuttle bus 197  
shuttlecock 231  
shy 25  
Siberia 313  
Sicily 316  
side 164  
side effects 109  
side mirror 198  
side order 153  
side plate 65  
side-saddle 242  
side street 299  
sidedeck 240  
sideline 220, 226, 230  
sidewalk 298  
sidewalk café 148  
Sierra Leone 317  
sieve 68, 89  
sieve *v* 91  
sift *v* 138  
sigh *v* 25  
sightseeing 260  
sign 104  
signal 209  
signature 96, 98  
silk 277  
silo 183  
silt 85  
silver 235, 289  
simmer *v* 67  
Singapore 319  
singer 191  
single 151  
single room 100  
singles 230  
sink 38, 60, 61, 66, 72  
sinus 19  
siren 94  
sirloin steak 119  
sister 22  
sister-in-law 23  
site manager's office 266  
situp 251  
six 308  
six hundred 308  
sixteen 308  
sixteenth 309  
sixth 309  
sixtieth 309  
sixty 308  
skate 120, 247, 294  
skate *v* 224  
skate wings 120  
skateboard 249  
skateboarding 249, 263  
skein 277  
skeleton 17  
sketch 275  
sketch pad 275  
skewer 68  
ski 241, 246  
ski boot 246  
ski jump 247  
ski pole 246  
ski run 246  
ski slope 246  
ski suit 246  
skier 246  
skiing 246  
skim milk 136  
skin 14, 119, 128  
skin care 108  
skinned 121  
skirt 30, 34  
skull 17  
skydiving 248  
skyscraper 299, 300  
slalom 247  
slate 288  
sledding 247  
sledgehammer 187  
sleeper 30  
sleeping 74  
sleeping bag 267  
sleeping compartment  
209  
sleeping mat 267  
sleeping pill 109  
sleet 286  
sleeve 34  
sleeveless 34  
slice 119, 139, 140, 230  
slice *v* 67  
sliced bread 138  
slicer 139  
slide 167, 263  
slide *v* 229  
sling 46  
slip 35  
slip-on 37  
slippers 31  
slope 284  
slotted spatula 68  
slotted spoon 68  
Slovakia 316  
Slovenia 316  
slow 321  
slug 295  
small 321  
small intestine 18  
small of back 13  
smash 231  
smile 25  
smoke 95  
smoke alarm 95  
smoked 118, 121, 143,  
159  
smoked fish 143  
smoking 112  
smoking section 152  
snack bar 113, 148  
snail 295

- snake 293  
 snare drum 257  
 sneeze 44  
 snore *v* 71  
 snorkel 239  
 snout 293  
 snow 287  
 snowboarding 247  
 snowmobile 247  
 snowsuit 30  
 soak *v* 130  
 soap 73, 178  
 soap dish 73  
 soccer 220, 222  
 soccer field 220  
 soccer player 220  
 soccer player 222  
 soccer uniform 31, 222  
 socket 60, 80  
 socket wrench 80  
 socks 33  
 soda bread 139  
 soda water 144  
 sofa 62  
 sofabed 63  
 soft 129, 321  
 soft cheese 136  
 soft drink 154  
 soft drinks 144  
 soft toy 75  
 software 176  
 softwood 79  
 soil 85  
 solar system 280  
 solder 79, 80  
 solder *v* 79  
 soldering iron 81  
 soldier 189  
 sole 15, 37  
 solids 164  
 Solomon Islands 319  
 soluble 109  
 solvent 83  
 Somalia 317  
 somersault 235  
 son 22  
 sonata 256  
 song 259  
 son-in-law 22  
 sorrel 123  
 sorting unit 61  
 soufflé 158  
 soufflé dish 69  
 sound boom 179  
 sound technician 179  
 soundtrack 255  
 soup 153, 158  
 soup bowl 65  
 soup spoon 65  
 sour 127  
 sour cream 137  
 sourdough bread 139  
 south 312  
 South Africa 317  
 South Korea 318  
 Southern Hemisphere 283  
 Southern Ocean 313  
 souvenirs 260  
 sow *v* 90, 183  
 soybeans 131  
 space 280  
 space exploration 281  
 space heater 60  
 space shuttle 281  
 space station 281  
 space suit 281  
 spade 88, 265, 273  
 Spain 316  
 spare tire 203  
 spark plug 203  
 sparkling 144  
 sparring 237  
 sparrow 292  
 spatula 68, 167  
 speaker 174, 176, 258, 268  
 speaker stand 268  
 spearfishing 245  
 specials 152  
 spectators 233  
 speed limit 195  
 speed skating 247  
 speedboat 241  
 speedometer 201, 204  
 spell *v* 162  
 sperm 20  
 sphere 164  
 spices 132  
 spicy sausage 142  
 spider 295  
 spike *v* 90  
 spikes 233  
 spin 230  
 spin *v* 76  
 spin-dryer 76  
 spinach 123  
 spine 17  
 spire 300  
 spleen 18  
 splint 47  
 splinter 46  
 split ends 39  
 split peas 131  
 spoke 207  
 sponge 73, 74, 83  
 sponge cake 140  
 spool 245  
 spoon 65  
 sport fishing 245  
 sports 105, 220, 236, 248  
 sports car 198  
 sports field 168  
 sportcoat 33  
 sportsman 191  
 spotlight 259  
 sprain 46  
 spray 109  
 spray *v* 91  
 spray can 311  
 spray bottle 89  
 spring 71, 307  
 spring balance 166  
 spring greens 123  
 springboard 235, 238  
 sprinkler 89  
 sprinter 234  
 sprocket 207  
 spy hole 59  
 square 164, 165, 272, 299  
 square foot 310  
 square meter 310  
 squash 231  
 squat 251  
 squid 121, 295  
 squirrel 290  
 Sri Lanka 318  
 St. Kitts and Nevis 314  
 St. Lucia 314  
 St. Vincent and the Grenadines 314  
 stable 185, 243  
 stadium 223  
 staff 175, 256  
 stage 167, 254  
 stages 23  
 stainless steel 79  
 stair gate 75  
 staircase 59  
 stake 90  
 stake *v* 91  
 stalk 122, 297  
 stalls 254  
 stamen 297  
 stamp 98  
 stamp collecting 273  
 stamps 112  
 stance 232  
 stand 88, 205, 268  
 stapler 173  
 staples 173  
 star 280  
 star anise 133  
 starfish 295  
 starfruit 128  
 start school *v* 26  
 starter 153  
 starting block 234, 238  
 starting line 234  
 state 315  
 statement 180  
 stationery 105  
 steak 121  
 steam *v* 67  
 steam train 208  
 steamed 159  
 steeplechase 243  
 steel wool 81  
 steering wheel 201  
 stem 111, 112, 297  
 stencil 83  
 stenographer 181  
 step machine 250  
 stepdaughter 23  
 stepfather 23  
 stepladder 82  
 stepmother 23  
 stepson 23  
 stereo 269  
 stereo system 268  
 sterile 47  
 stern 240  
 stethoscope 45  
 stew 158  
 stick 224, 249  
 sticks 133  
 still 144  
 sting 46, 295  
 stir *v* 67  
 stir-fry 158  
 stirrer 150  
 stirrup 242  
 stitch 277  
 stitch selector 276  
 stitches 52  
 stock broker 97  
 stock exchange 97  
 stockings 35  
 stocks 97, 110  
 stomach 18  
 stomachache 44  
 stone 36, 275  
 stone fruit 126  
 stop 269  
 stop button 197  
 stopper 166  
 stopwatch 234  
 store directory 104  
 stork 292  
 storm 287  
 stout 145  
 straight 39, 165  
 straight ahead 260  
 straighten *v* 39  
 strap 35  
 strapless 34  
 stratosphere 286  
 straw 144, 154  
 strawberry 127  
 strawberry milkshake 149  
 stream 285  
 street 298  
 street corner 298  
 street sign 298  
 streetlight 298  
 stress 55  
 stretch 251  
 stretcher 94  
 strike 228, 237  
 string 230, 258  
 string of pearls 36  
 string bean 122  
 strings 256  
 strip *v* 82  
 stroke 44, 233, 239  
 strokes 231  
 stroller 75  
 strong 321  
 stub 96  
 study 63, 162  
 stuffed 159  
 stuffed olive 143  
 stump 225  
 styles 39, 239, 301  
 submarine 215  
 subsoil 91  
 substitute 223  
 substitution 223  
 subtract *v* 165  
 suburb 299  
 subway map 209  
 subway train 209  
 succulent 87  
 suction hose 77  
 Sudan 317  
 sugarcane 184  
 suit 273  
 sulfur 289  
 summer 31, 307  
 summons 180  
 sumo wrestling 237  
 Sun 280  
 sun hat 30, 265  
 sunbathe *v* 264  
 sunbed 41  
 sunblock 108, 265  
 sunburn 46  
 Sunday 306  
 sunflower 184, 297  
 sunflower oil 134  
 sunflower seed 131  
 sunglasses 51, 265  
 sunny 286  
 sunrise 305  
 sunroof 202  
 sunscreen 108  
 sunset 305  
 sunshine 286  
 suntan lotion 265  
 supermarket 106  
 supersonic jet 211  
 supplement 55  
 supply pipe 61  
 support 187  
 suppository 109  
 surf 241  
 surfboard 241  
 surfcasting 245  
 surfer 241  
 surfing 241  
 surgeon 48  
 surgery 45, 48  
 Suriname 315  
 surprised 25  
 suspect 94, 181  
 suspension 203, 205  
 swallow 292

- swamp 285  
 swan 293  
 Swaziland 317  
 sweater 33  
 sweatpants 33  
 sweatshirt 33  
 Sweden 316  
 sweep *v* 77  
 sweet 124, 127, 155  
 sweet potato 125  
 sweet spreads 134  
 swim *v* 238  
 swimmer 238  
 swimming 238  
 swimming pool 101, 238, 250  
 swimsuit 238, 265  
 swing *v* 232  
 swings 263  
 swiss chard 123  
 switch 60  
 Switzerland 316  
 swivel chair 172  
 sword 236  
 swordfish 120, 294  
 symphony 256  
 synagogue 300  
 synchronized swimming 239  
 synthetic 31  
 Syria 318  
 syringe 109, 167  
 syrup 109  
 system 176
- T**
- tab 173  
 table 64, 148  
 table tennis 231  
 tablecloth 64  
 tachometer 201  
 tack *v* 241, 277  
 tackle 245  
 tackle *v* 220, 223  
 tackle box 244  
 tadpole 294  
 tae kwon do 236  
 tag *v* 229  
 tai chi 236  
 tail 121, 210, 242, 280, 290, 294  
 tailbone 17  
 tailgate 198  
 taillight 204  
 tailor 191  
 tailored 35  
 tailor's 115  
 tailor's chalk 276  
 tailor's dummy 276  
 tailplane 210  
 Taiwan 319  
 Tajikistan 318  
 take a bath *v* 72  
 take a shower *v* 72
- take notes *v* 163  
 take off *v* 211  
 talcum powder 73  
 tall 321  
 tambourine 257  
 tampon 108  
 tan 41  
 tandem 206  
 tangerine 126  
 tank 61  
 Tanzania 317  
 tap 61, 66  
 tap water 144  
 tape deck 268  
 tape dispenser 173  
 tape measure 80, 276  
 target 249  
 target shooting 249  
 taro root 124  
 tarragon 133  
 Tasmania 319  
 tattoo 41  
 tax 96  
 taxi stand 213  
 tea 144, 149, 184  
 tea bag 144  
 tea with lemon 149  
 tea with milk 149  
 teacher 54, 162, 191  
 teacup 65  
 team 220, 229  
 teapot 65  
 tear 51  
 teaspoon 65  
 teat 75  
 techniques 79, 159  
 teddy bear 75  
 tee 233  
 teeing ground 232  
 teenager 23  
 tee off *v* 233  
 telegram 98  
 telephone 99, 172  
 telephone booth 99  
 teleprompter 179  
 telescope 281  
 television 268  
 television series 178  
 television studio 178  
 temperature 286  
 temperature gauge 201  
 temple 14, 300  
 ten 308  
 ten thousand 309  
 tenant 58  
 tend *v* 91  
 tendon 17  
 tennis 230  
 tennis court 230  
 tennis shoes 231  
 tenon saw 81  
 tent 267  
 tent peg 266  
 tent pole 266
- tenth 309  
 tequila 145  
 terminal 212  
 termite 295  
 terrace café 148  
 territory 315  
 test 49, 163  
 test tube 166  
 testicle 21  
 tank 61  
 text message 99  
 textbook 163  
 Thailand 318  
 thank you 322  
 Thanksgiving 27  
 theater 254, 299  
 theme park 262  
 therapist 55  
 thermal underwear 35  
 thermals 267  
 thermometer 45, 167  
 thermosphere 286  
 thermostat 61  
 thesis 169  
 thick 321  
 thigh 12, 119  
 thimble 276  
 thin 321  
 third 309  
 third floor 104  
 thirteen 308  
 thirteenth 309  
 thirtieth 309  
 thirty 308  
 this way up 98  
 this week 307  
 thistle 297  
 thoracic vertebrae 17  
 thread 276  
 thread *v* 277  
 thread guide 276  
 thread reel 276  
 three 308  
 three hundred 308  
 hatchback 200  
 three-point line 226  
 thriller 255  
 throat 19  
 throttle 204  
 through 320  
 throw 237  
 throw *v* 221, 227, 229  
 throw-in 223, 226  
 thruster 281  
 thumb 15  
 thumbtack 173  
 thunder 286  
 Thursday 306  
 thyme 133  
 thyroid gland 18  
 tibia 17  
 ticket 209, 213  
 ticket gate 209  
 ticket inspector 209  
 ticket office 209, 216
- tie 32  
 tiebreaker 230  
 tie-pin 36  
 tiger 291  
 tights 35, 251  
 tile 58, 272  
 tile *v* 82  
 till 106, 150  
 tiller 240  
 timber 187  
 time 234, 304  
 time out 220  
 timer 166  
 times 165, 261  
 timing 203  
 tip 36, 122, 246  
 tissue 108  
 title 168  
 titles 23  
 to 320  
 to go 154  
 toad 294  
 toast 157  
 toasted sandwich 149  
 toaster 66  
 tobacco 112, 184  
 today 306  
 toddler 30  
 toe 15  
 toe clip 207  
 toe strap 207  
 toenail 15  
 toffee 113  
 toggle 31  
 Togo 317  
 toilet 61, 72  
 toilet brush 72  
 toilet paper 72  
 toilet seat 72  
 toiletries 41, 107  
 toilets 104, 266  
 toll booth 194  
 tomato 125, 157  
 tomato juice 144, 149  
 tomorrow 306  
 ton 310  
 toner 41  
 tongs 150, 167  
 tongue 19, 37, 118  
 tonic water 144  
 tool rack 78  
 toolbar 177  
 toolbelt 186  
 toolbox 80  
 tools 187  
 tooth 50  
 toothache 50  
 toothbrush 72  
 toothpaste 72  
 top coat 83  
 top-dress *v* 90  
 top tier 141  
 topaz 288  
 topiary 87
- topping 155  
 topsoil 85  
 tornado 287  
 tortoise 293  
 tossed salad 158  
 touch line 221  
 touchdown 221  
 tour bus 197, 260  
 tour guide 260  
 tourer 205  
 touring bike 206  
 tourist 260  
 tourist attraction 260  
 tourist information 261  
 tourmaline 288  
 tournament 233  
 tow away *v* 195  
 tow truck 203  
 toward 320  
 towel bar 72  
 towels 73  
 tower 300  
 town 298  
 town hall 299  
 townhouse 58  
 toy 75  
 toy basket 75  
 toys 105  
 track 208, 234  
 track and field 234  
 tractor 182  
 traffic 194  
 traffic jam 195  
 traffic light 194  
 traffic police 195  
 trailer 266  
 train 35, 208  
 train *v* 91, 251  
 train station 208  
 trainer 37  
 training wheels 207  
 tram 196, 208  
 transfer 223  
 transformer 60  
 transmission 202  
 transplant *v* 91  
 transportation 194  
 trapezium 164  
 trapezius 16  
 trash 177  
 travel agent 190, 114  
 travel brochure 212  
 travel sickness pills 109  
 traveler's check 97  
 tray 152, 154  
 tray-table 210  
 tread 207  
 tread water *v* 239  
 treadmill 250  
 treble clef 256  
 tree 86, 296  
 trekking 243  
 trellis 84  
 tremor 283

triangle 164, 257  
triceps 16  
trifle 141  
trim *v* 39, 90  
trimester 52  
trimmer 88  
Trinidad and Tobago 314  
tripod 166, 270, 281  
trolley bus 196  
trombone 257  
tropic of Cancer 283  
tropic of Capricorn 283  
tropical fruit 128  
tropics 283  
troposphere 286  
trot 243  
trough 183  
trout 120  
trowel 89, 187  
truck 194  
truck driver 190  
truffle 113, 125  
trumpet 257  
trunk 198, 291, 296  
trunks 238  
try 221  
T-shirt 30, 33  
tub 311  
tuba 257  
tube 311  
Tuesday 306  
tugboat 215  
tulip 111  
tumble 235  
tumble-dryer 76  
tumbler 65  
tuna 120  
tune *v* 179  
tune the radio *v* 269  
tuning peg 258  
Tunisia 317  
turbocharger 203  
turf *v* 90  
Turkey 316  
turkey 119, 185, 293  
Turkmenistan 318  
turmeric 132  
turn 238  
turn *v* 79  
turn off the television *v* 269  
turn on the television *v* 269  
turn signal 198, 204  
turnip 124  
turpentine 83  
turquoise 289  
turret 300  
turtle 293  
tusk 291  
tutu 191  
tweezers 40, 47, 167  
twelfth 309  
twelve 308

twentieth 309  
twenty 308  
twenty minutes 304  
twenty thousand 309  
twenty-first 309  
twenty-one 308  
twenty-second 309  
twenty-third 309  
twenty-two 308  
twig 296  
twin bed 71  
twin room 100  
twine 89  
twins 23  
twist ties 89  
two 308  
two hundred 308  
two o'clock 304  
two thousand 307  
two thousand and one 307  
two-door 200  
types 199, 205  
types of buses 196  
types of cameras 270  
types of farms 183  
types of plants 86  
types of fishing 245  
types of trains 208  
tire 198, 205, 206  
tire iron 207  
tire pressure 203

**U**  
Uganda 317  
ugli fruit 126  
Ukraine 316  
ulna 17  
ultralight 211  
ultrasound 52  
ultraviolet rays 286  
umbilical cord 52  
umbrella 36, 233  
umbrella stand 59  
umpire 225, 229, 230  
uncle 22  
unconscious 47  
uncooked meat 142  
under 320  
under par 233  
undercoat 83  
underexposed 271  
undergraduate 169  
underpass 194  
underwear 32, 35  
underwired 35  
uniform 94, 189  
United Arab Emirates 318  
United Kingdom 316  
United States of America 314  
universe 280  
university 299

unleaded 199  
unpasteurized 137  
unpick *v* 277  
unsalted 137  
until 320  
up 320  
upset 25  
Uranus 280  
ureter 21  
urethra 20  
urinary 19  
urology 49  
Uruguay 315  
usher 255  
uterus 20, 52  
utility knife 81  
utility room 76  
Uzbekistan 318

**V**  
vacation 212  
vacuum cleaner 77, 188  
vacuum cup 53  
vacuum flask 267  
vagina 20  
valance 71  
valley 284  
valve 207  
vanilla 132  
Vanuatu 319  
varnish 79, 83  
vas deferens 21  
vase 63, 111  
Vatican City 316  
vault 235, 300  
veal 118  
vegetable garden 85, 182  
vegetable oil 135  
vegetable peeler 68  
vegetables 107, 122, 124  
veggie burger 155  
veil 35  
vein 19  
venetian blind 63  
Venezuela 315  
venison 118  
vent 283  
Venus 280  
verdict 181  
vest 33, 35, 251  
veterinarian 189  
vibraphone 257  
video game 269  
video phone 99  
video recorder 269  
video tape 269  
Vietnam 318  
viewfinder 271  
village 299  
vine 183  
vinegar 135, 142  
vineyard 183

vintage 199  
viola 256  
violin 256  
virus 44  
visa 213  
vise 78  
vision 51  
visiting hours 48  
visor 205  
vitamins 108  
V-neck 33  
vocal cords 19  
vodka 145  
voice message 99  
volcano 283  
volley 231  
volleyball 227  
voltage 60  
volume 165, 179, 269, 311  
vomit *v* 44

**W**  
waders 244  
wading pool 263  
waffles 157  
waist 12  
waistband 35  
waistcoat 33  
waiter 148, 152  
waiting room 45  
waitress 191  
wake up *v* 71  
walk 243  
walking boot 37, 267  
walkway 212  
wall 58, 186, 222  
wall light 62  
wallet 37  
wallpaper 82, 177  
wallpaper *v* 82  
wallpaper brush 82  
wallpaper paste 82  
walnut 129  
walnut oil 134  
walrus 290  
ward 48  
wardrobe 70  
warehouse 216  
warm 286  
warm up *v* 251  
warrant 180  
wash *v* 38, 77  
washer 80  
washer fluid 199  
washer fluid reservoir 202  
washing machine 76  
wasp 295  
waste disposal 61, 266  
waste disposal unit 61  
waste pipe 61  
wastebasket 172  
watch 36  
watch television *v* 269  
water 144, 238  
water *v* 90, 183  
water bottle 206, 267  
water chamber 61  
water chestnut 124  
water garden 84  
water hazard 232  
water heater 61  
water jet 95  
water plant 86  
water polo 239  
watercolor paints 274  
watercross 123  
waterfall 285  
watering 89  
watering can 89  
watermelon 127  
waterskier 241  
waterskiing 241  
watersports 241  
wave 241, 264  
wavelength 179  
wax 41  
weak 321  
waffles 286  
weaving 277  
website 177  
wedding 26, 35  
wedding cake 141  
wedding dress 35  
wedding reception 26  
wedge 233  
Wednesday 306  
weed *v* 91  
weedkiller 91  
weeds 86  
week 306  
weekend 306  
weekly 307  
weigh *v* 310  
weight 166, 244  
weight bar 251  
weight belt 239  
weight training 251  
wellington boots 31  
west 312  
western 255  
Western Sahara 317  
wet 286, 321  
wet wipe 75, 108  
wetsuit 239  
whale 290  
wheat 130, 184  
wheel 198, 207  
wheel nuts 203  
wheelbarrow 88  
wheelchair 48  
wheelchair access 197  
whetstone 81  
whiplash 46  
whipped cream 137  
whisk 68  
whisk *v* 67



- whiskers 290  
 whiskey 145  
 white 39, 145, 272, 274  
 white bread 139  
 white chocolate 113  
 white coffee 148  
 white currant 127  
 white flour 138  
 white meat 118  
 white rice 130  
 whiting 120  
 whole 129, 132  
 whole milk 136  
 whole-grain 131  
 whole-grain mustard 135  
 whole-wheat bread 139  
 whole-wheat flour 138  
 wicket 225  
 wide 321  
 widescreen television 269  
 width 165  
 wife 22  
 wig 39  
 wild rice 130  
 willow 296  
 win *v* 273  
 wind 241, 286  
 windbreak 265  
 windbreaker 33  
 windlass 214  
 window 58, 96, 98, 177,  
     186, 197, 209, 210  
 windpipe 18  
 windshield 198, 205  
 windshield wiper 198  
 windsurfer 241  
 windsurfing 241  
 windy 286  
 wine 145, 151  
 wine glass 65  
 wine list 152  
 wine vinegar 135  
 wing 119, 210, 293  
 wings 254  
 winner 273  
 winter 31, 307  
 winter sports 247  
 wipe *v* 77  
 wire 79  
 wire cutter 80  
 wire strippers 81  
 wires 60  
 with 320  
 withdrawal slip 96  
 without 320  
 witness 180  
 wok 69  
 wolf 290  
 woman 23  
 womb 52  
 women's clothing 34,  
     105  
 wood 79, 233, 275, 285  
 wood glue 78  
 wood shavings 78  
 wood stain 79  
 wooden spoon 68  
 woodpecker 292  
 woodwind 257  
 woodworking 275  
 wool 277  
 work 172  
 work day 306  
 workbench 78  
 workshop 78  
 world map 312  
 worm 295  
 worried 25  
 wound 46  
 wrap 155  
 wrapping 111  
 wreath 111  
 wrench 80, 81, 203  
 wrestling 236  
 wrinkle 15  
 wrist 13, 15  
 wristband 230  
 writ 180  
 write *v* 162  
**X**  
 X-ray 48  
 X-ray film 50  
 X-ray machine 212  
 X-ray viewer 45  
**Y**  
 yacht 215, 240  
 yam 125  
 yard 310  
 yawn *v* 25  
 year 163, 306  
 yeast 138  
 yellow 274  
 yellow card 223  
 Yemen 318  
 yes 322  
 yesterday 306  
 yoga 54  
 yogurt 137  
 yolk 137, 157  
 you're welcome 322  
 Yugoslavia 316  
**Z**  
 Zambia 317  
 zebra 291  
 zero 308  
 zest 126  
 Zimbabwe 317  
 zinc 289  
 zip 277  
 ZIP code 98  
 zone 315  
 zones 283  
 zoo 262  
 zoology 169  
 zoom lens 270  
 zucchini 125

## ringraziamenti • acknowledgments

DORLING KINDERSLEY would like to thank Tracey Miles and Christine Lacey for design assistance, Georgina Garner for editorial and administrative help, Sonia Gavira, Polly Boyd, and Cathy Meeus for editorial help, and Claire Bowers for compiling the DK picture credits.

The publisher would like to thank the following for their kind permission to reproduce their photographs:

Abbreviations key:

t=top, b=bottom, r=right, l=left, c=centre

**Abode:** 62; **Action Plus:** 224bc; **alamy.com:** 154t; A.T. Willett 287bcl; Michael Foyle 184bl; Stock Connection 287bcr; **Allsport/Getty Images:** 238cl; **Alvey and Towers:** 209 acr, 215bcl, 215bcr, 241cr; **Peter Anderson:** 188bcr, 271br. **Anthony Blake Photo Library:** Charlie Stebbings 114cl; John Sims 114tcl; **Andyalte:** 98tl; **apple mac computers:** 268tcr; **Arcaid:** John Edward Linden 301bl; Martine Hamilton Knight, Architects: Chapman Taylor Partners, 213cl; Richard Bryant 301br; **Argos:** 41tcl, 66cbl, 66cl, 66br, 66bcl, 69cl, 70bcl, 71t, 77tl, 269tc, 270tl; **Axiom:** Eitan Simanor 105bcr; Ian Cumming 104; Vicki Couchman 148cr; **Beken Of Cowes Ltd:** 215cbc; **Bosch:** 76tcr, 76tc, 76tcl; **Camera Press:** 27c, 38tr, 256t, 257cr; Barry J. Holmes 148tr; Jane Hanger 159cr; Mary Germanou 259bc; **Corbis:** 78b; Anna Clopet 247tr; Bettmann 181tl, 181tr; Bo Zauders 156t; Bob Rowan 152bl; Bob Winsett 247cbl; Brian Bailey 247br; Carl and Ann Purcell 162l; Chris Rainer 247ctl; ChromoSohm Inc. 179tr; Craig Aurness 215bl; David H.Wells 249cbr; Dennis Marsico 274bl; Dimitri Lundt 236bc; Duomo 211tl; Gail Mooney 277ctcr; George Lepp 248c; Gunter Marx 248cr; Jack Fields 210b; Jack Hollingsworth 231bl; Jacqui Hurst 277cbr; James L. Amos 247bl, 191cr, 220bcr; Jan Butchofsky 277cbc; Johnathan Blair 243cr; Jon Feingersh 153tr; Jose F. Poblete 191br; Jose Luis Pelaez.Inc 153tc, 175tl; Karl Weatherly 220bl, 247tcr; Kelly Mooney Photography 259tl; Kevin Fleming 249bc; Kevin R. Morris 105tr, 243tl, 243tc; Kim Sayer 249tcr; Lynn Goldsmith 258t; Macduff Everton 231bcl; Mark Gibson 249bl; Mark L. Stephenson 249tcl; Michael Pole 115tr; Michael S. Yamashita 247ctcl; Mike King 247cbl; Neil Rabinowitz 214br; Owen Franken 112t; Pablo Corral 115bc; Paul A.

Sounders 169br; 249ctcl; Paul J. Sutton 224c, 224br; Peter Turnley 105tcr; Phil Schermeister 227b, 248tr; R. W Jones 309; R.W. Jones 175tr; Richard Hutchings 168b; Rick Doyle 241ctr; Robert Holmes 97br, 277ctc; Roger Ressmeyer 169tr; Russ Schleipman 229; Steve Raymer 168cr; The Purcell Team 211ctr; Tim Wright 178; Vince Streano 194t; Wally McNamee 220br, 220bcl, 224bl; Yann Arhous-Bertrand 249tl; **Demetrio Carrasco / Dorling Kindersley (c) Herge / Les Editions Casterman:** 112ccl; **Dixons:** 270cl, 270cr, 270bl, 270bcl, 270bcr, 270ccr; **Education Photos:** John Walmsley 26tl; **Empics Ltd:** Adam Day 236br; Andy Heading 243c; Steve White 249cbc; **Getty Images:** 48bcl, 100t, 114bcr, 154bl, 287tr; 94tr; **Dennis Gilbert:** 106tc; **Hulsta:** 70t; **Ideal Standard Ltd:** 72r; **The Image Bank/Getty Images:** 58; **Impact Photos:** Eliza Armstrong 115cr; John Arthur 190tl; Philip Achache 246t; **The Interior Archive:** Henry Wilson, Alfie's Market 114bl; Luke White, Architect: David Mikhail, 59tl; Simon Upton, Architect: Phillippe Starck, St Martins Lane Hotel 100bcr, 100br; **Jason Hawkes Aerial Photography:** 216t; **Dan Johnson:** 26cbl, 35r; **Kos Pictures Source:** 215cbl, 240tc, 240tr; David Williams 216b; **Lebrecht Collection:** Kate Mount 169bc; **MP Visual.com:** Mark Swallow 202t; **NASA:** 280cr, 280ccl, 281tl; **P&O Princess Cruises:** 214bl; **P A Photos:** 181br; **The Photographers' Library:** 186bl, 186bc, 186t; **Plain and Simple Kitchens:** 66t; **Powerstock Photolibrary:** 169tl, 256t, 287tc; **Rail Images:** 208c, 208 cbl, 209br; **Red Consultancy:** Odeon cinemas 257br; **Redferns:** 259br; Nigel Crane 259c; **Rex Features:** 106br, 259tc, 259tr, 259bl, 280b; Charles Ommaney 114tcr; J.F.F Whitehead 243cl; Patrick Barth 101tl; Patrick Frilet 189cbl; Scott Wiseman 287bl; **Royalty Free Images:** Getty Images/Eyewire 154bl; **Science & Society Picture Library:** Science Museum 202b; **Skyscan:** 168t, 182c, 298; Quick UK Ltd 212; **Sony:** 268bc; **Robert Streeter:** 154br; **Neil Sutherland:** 82tr, 83tl, 90t, 118, 188ctr, 196td, 196tr, 299cl, 299bl; **The Travel Library:** Stuart Black 264t; **Travelex:** 97cl; **Vauxhall:** Technik 198t, 199tl, 199tr, 199cl, 199cr, 199ctcl, 199ctcr, 199tcl, 199tcr, 200; **View Pictures:** Dennis Gilbert, Architects: ACDP Consulting, 106t; Dennis Gilbert,

Chris Wilkinson Architects, 209tr; Peter Cook, Architects: Nicholas Crimshaw and partners, 208t; **Betty Walton:** 185br; **Colin Walton:** 2, 4, 7, 9, 10, 28, 42, 56, 92, 95c, 99tl, 99tcl, 102, 116, 120t, 138t, 146, 150t, 160, 170, 191ctcl, 192, 218, 252, 260br, 260l, 261tr, 261c, 261cr, 271cbl, 271cbr, 271ctl, 278, 287br, 302, 401.

DK PICTURE LIBRARY:

Akhil Bahkshi; Patrick Baldwin; Geoff Brightling; British Museum; John Bulmer; Andrew Butler; Joe Cornish; Brian Cosgrove; Andy Crawford and Kit Houghton; Philip Dowell; Alistair Duncan; Gables; Bob Gathany; Norman Hollands; Kew Gardens; Peter James Kindersley; Vladimir Kozlik; Sam Lloyd; London Northern Bus Company Ltd; Tracy Morgan; David Murray and Jules Selmes; Musée Vivant du Cheval, France; Museum of Broadcast Communications; Museum of Natural History; NASA; National History Museum; Norfolk Rural Life Museum; Stephen Oliver; RNLI; Royal Ballet School; Guy Ryecart; Science Museum; Neil Setchfield; Ross Simms and the Winchcombe Folk Police Museum; Singapore Symphony Orchestra; Smart Museum of Art; Tony Souter; Erik Svensson and Jeppe Wikstrom; Sam Tree of Keygrove Marketing Ltd; Barrie Watts; Alan Williams; Jerry Young.

Additional Photography by Colin Walton.

Colin Walton would like to thank: A&A News, Uckfield; Abbey Music, Tunbridge Wells; Arena Mens Clothing, Tunbridge Wells; Burrells of Tunbridge Wells; Gary at Di Marco's; Jeremy's Home Store, Tunbridge Wells; Noakes of Tunbridge Wells; Ottakar's, Tunbridge Wells; Selby's of Uckfield; Sevenoaks Sound and Vision; Westfield, Royal Victoria Place, Tunbridge Wells.

All other images are Dorling Kindersley copyright. For further information see [www.dkimages.com](http://www.dkimages.com)



# italian english

## SHOWING YOU WHAT OTHERS ONLY TELL YOU

- The quick and intuitive way to learn and remember thousands of Italian words
- Features a complete range of illustrated objects and scenes from everyday life
- Fast and effective learning for any situation, from home and office to shopping and eating out
- Easy to use, with a detailed index for instant reference
- Ideal for foreign travel, whether business or pleasure

**il piatto**  
plate



**il poliziotto**  
policeman

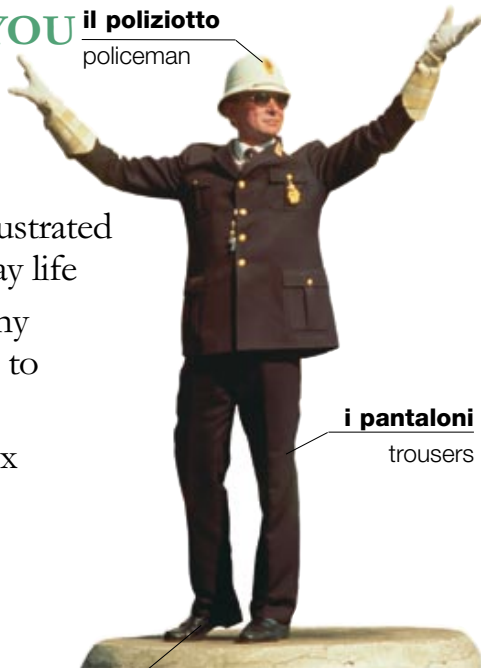

**i pantaloni**  
trousers

**le scarpe**  
shoes

**l'edificio**  
building

**l'arco**  
arch

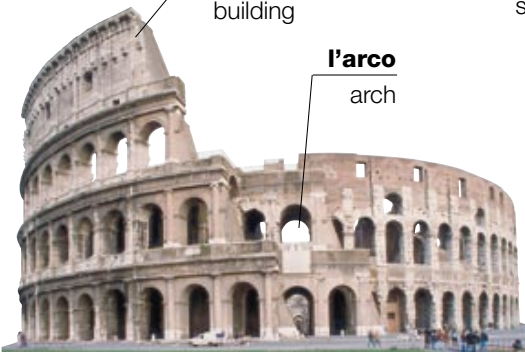

Discover more at  
[www.dk.com](http://www.dk.com)

Jacket images *Back*: Getty Images; Stephen Studd.

# BILINGUAL DICTIONARY

# ITALIAN